

Connection and installation manual

Swing gate control unit ST 61

V 3.0.001



Content

General warning and safety notes.....	3
1. General features, control board overview, technical data.....	4
2. Terminal assignment, connection notes	5
3. Adjustments - overview	6, 7
4. Connections and adjustments	8
Buttons/switches.....	8, 9
Safety	10–13
Left leaf	16
Right leaf	16
Operating mode.....	16, 17
Light / Lamps	18
Peripherals	19–21
Diagnosis	22
5. Connection of radio receiver.....	23
6. Initial operation	24–27
7. Error analysis	28
8. Dimensioned drawing housing IP54	29



General warning and safety notes

- These installation and operating instructions form an integral part of the product “**control unit**”. They have been specifically written for professional installers trained and skilled in the trade and should be carefully read in their full length before carrying out the installation. It concerns the control only, not of the overall device “automatic gate”. After the installation this manual has to be handed over to the user.
- **Installation, connection, adjustments, putting into operation, and servicing may only be carried out by trained professionals in full accordance with these installation and operating instructions.**
- **Before carrying out works on the gate system, the power supply has to be turned off.**
- Before taking off the housing cover, always turn off the mains switch!
- The EU Machine Directive, laws and rules concerning the prevention of accidents, and laws and standards which are in force in the EU and in the individual countries have to be strictly followed.
- The TOUSEK Ges.m.b.H. can not be held liable for any claims resulting from disregards of the laws and standards in force during the installation and operation.
- The packaging materials (cardboard, plastic, EPS foam parts and filling material etc.) have to be properly disposed of in accordance with the applying recycling and environmental protection laws. They may be hazardous to children and therefore have to be stored out of children’s reach.
- The product is not suitable for installation in explosion-hazardous areas.
- The product may only be used in accordance with its original purpose, for which it has been exclusively designed, and which is described in these installation and operating instructions. The TOUSEK Ges.m.b.H. rejects any liability if the product is used in any way not fully conforming to its original purpose as stated herein.
- **Children have to be instructed** that the gate facility as well as the belonging parts may not be used improperly, e.g. for playing. Furthermore handheld transmitters have to be kept in safe places and other impulse emitters as buttons and switches have to be installed out of children’s reach..
- Before beginning with the installation the installer has to make sure that all mechanical components of the gate facility, like carrier profile/rail, gate frame and panels, guiding elements etc. are sufficiently supportive and resistant for the purpose of gate automation.
- All electrical installations have to be made in full conformity with the applying rules and laws (e.g. using a fault current circuit breaker, proper grounding etc.).
- **An all-pole disconnecting main switch with a contact opening-gap of minimum 3 mm has to be foreseen.**
- **After installation the proper function of the gate facility and the safety devices has to be checked!**
- The TOUSEK Ges.m.b.H. rejects any liability for claims resulting from usage of the product in combination with components or devices which do not fully conform to the applying safety laws and rules.
- Only original spare and replacement parts may be used for repair of the product.
- The installer has to inform the user about all aspects of the automatic operation of the complete gate facility, as well as about emergency operation. The installer further has to supply to the user all instructions relating to the safe operation of the gate facility. The installation and operating instructions also have to be handed over to the user.



Maintenance

- **Maintenance works may only be carried out by qualified personnel.**
- **Maintenance and servicing of the complete gate facility has to be carried out according to the gate builder’s/ installer’s instructions.**
- **Check the proper sensitivity setting of the ARS safety reverse system once a month.**

EU - Manufacturer’s Declaration:

The company TOUSEK Ges.m.b.H., based in Zetschegasse 1, A-1230 Vienna/Austria, hereby declares that the control unit ST 61 complies with the following directives:

- Low Voltage Directive 2014/35/EU, incl. changes
- Electromagnetic Compatibility Directive 2014/30/EU, incl. changes

January 2019

Control board features

- suitable for swing gates with electromechanical operators SWING X and SPIN 250, 230V (1 or 2 gate leaves) with integrated sensor.
- leaf delay adjustable at opening and closing
- automatic closure with adjustable pause time
- travel time of both operators will be adjusted automatically
- separately adjustable softstop time of both operators (no loss of force even with reduced speed).
- Safety system ARS (autom. reversal system)
- operating mode: impulse, automatic or dead man mode
- ntegrated evaluation of safety sensing edges
- self-monitoring of photocells
- self-diagnosis display
- optional module: "electric lock /magnetic clamp" or "motor lock"
- slots for optional and status display module and radio receiver

Control board overview

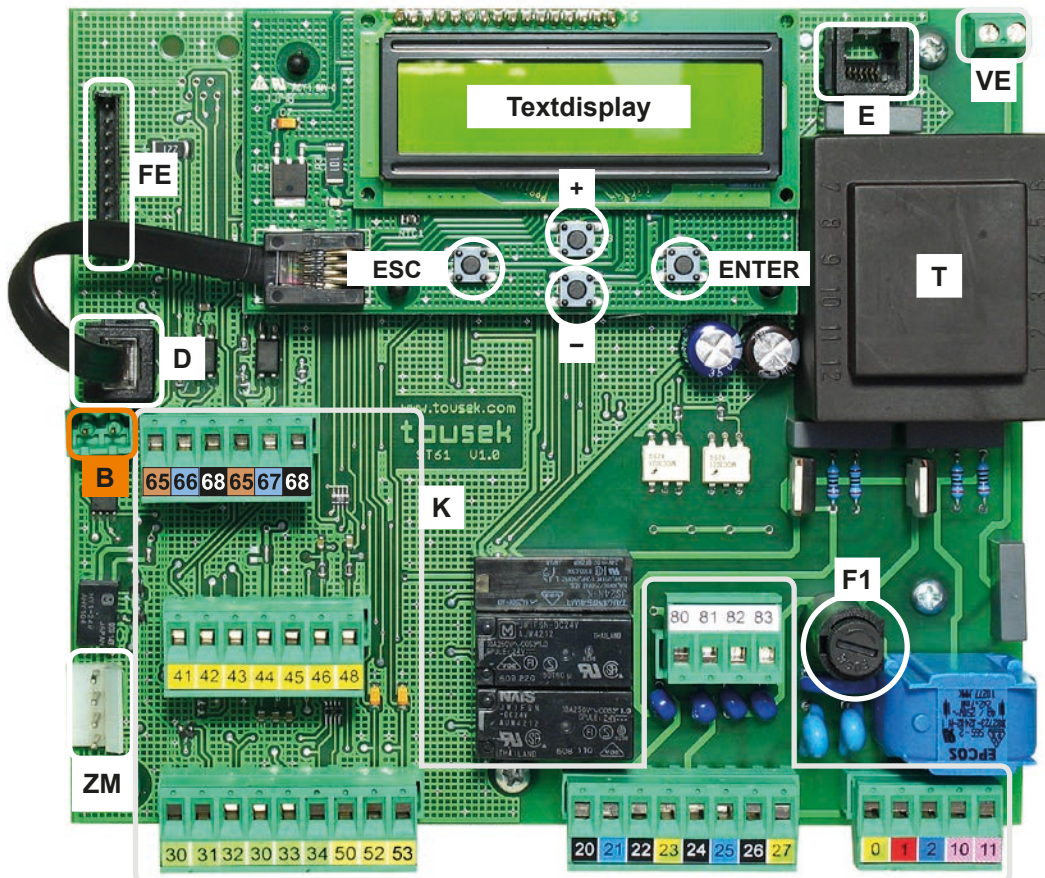

Attention

During connection, adjustment and maintenance works please take care, that the electronic circuit board won't be damaged by moisture (rain).

Important

The optional „tousek-connect“ or the „tousek-service interface“ must be connected with socket (D)! Not with (E)!

Components of the control board

- (K) terminal blocks
- (D) display connector (with programming buttons +, -, ESC, ENTER) or TC/TSI-connection (optional „tousek-connect“/ „tousek service Interface“)
- (E) System connector for optional module motor lock or electric lock / magnet (page 20)
- (VE) 230V a.c. for electric lock/magnet module
- (B) system connector
- (FE) slot for optional radio receiver (page 23)
- (ZM) slot for optional module „status display“ (page 19)
- (T) transformer
- (F1) fuse 6,3A F

Technical data

Swing gate control unit ST 61			
power supply	230V a.c., +/-10% 50Hz	magnetic clamp output	optional 24Vd.c.
motor output	2 x 500W, 230V a.c.	ambient temperature	- 20°C bis + 70°C
flashing light output	230V AC, 40W	protection class	IP54
electric lock output	optional 12Vd.c. oder 24V d.c.	speed sensor	■
photocell output	24V a.c.	art.number	12111670
optional components	pluggable radio receiver • additional module for courtyard/control lamp • Additional module for gate status evaluation • E-lock/magnet module • radio transmission system TX 310		



Warning

- Before taking off the control cover, the main switch must be turned off ! 
- The inside of the control unit is under tension when power supplied.
- In order to avoid electrical strokes, the safety regulations have to be respected.
- The device may only be connected by qualified personnel (specialised staff).
- The product is not suitable for installation in explosion-hazardous/explosive areas.
- An all-pole disconnecting main switch with a contact opening gap of min. 3 mm has to be foreseen. The gate facility has to be secured according to the valid safety regulations!
- **IMPORTANT:** The control lines (sensor, buttons, radio, photocells, etc.) have to be laid separately from the 230V lines (supply line, motors, signal lamp).

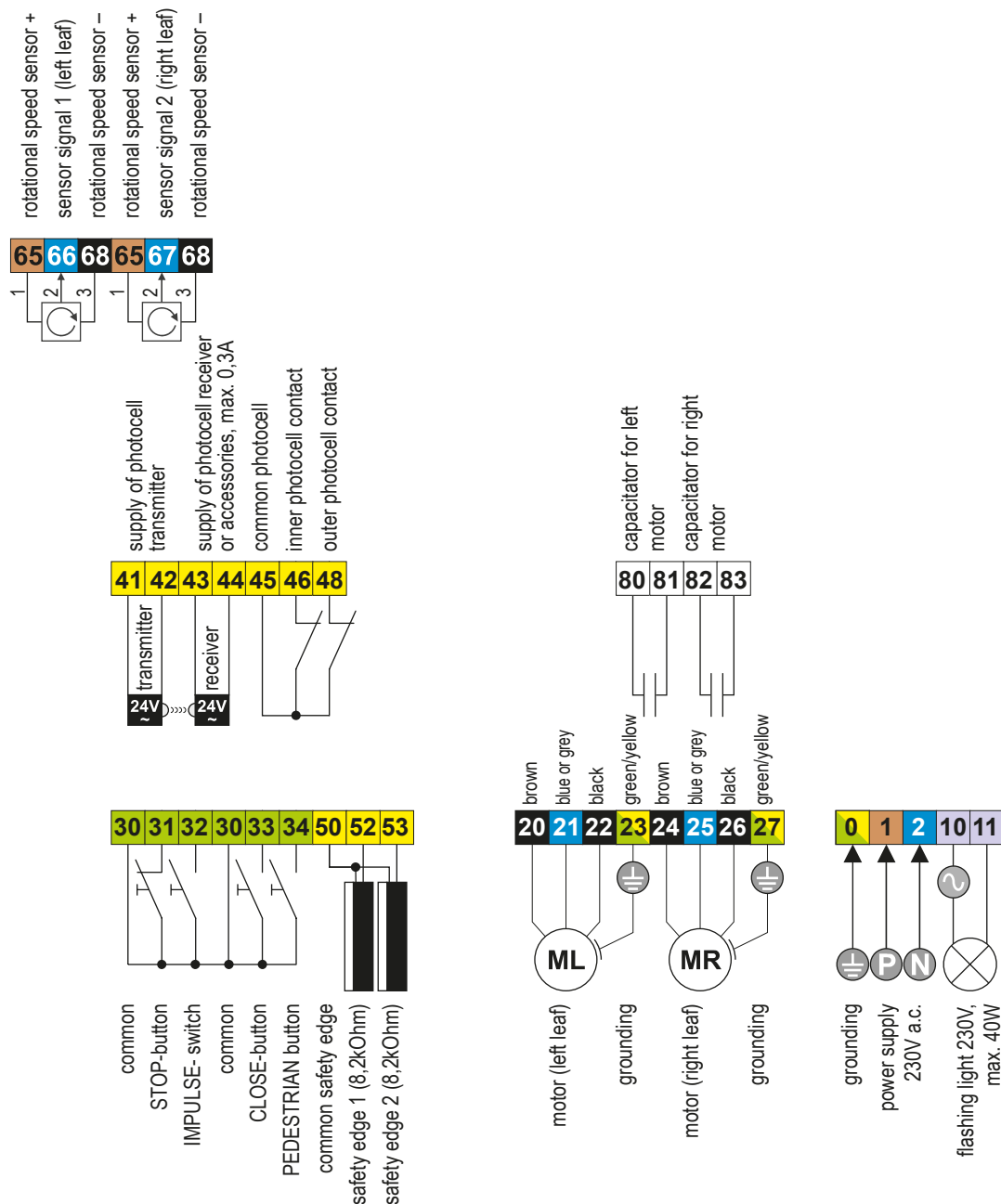

The stop input has no emergency stop function! - In order to ensure the emergency stop function, provide the supply line with an all-pole disconnecting emergency stop switch, that locks after actuation!

Programming buttons

Adjustments - Overview



- The adjustment (programming) of the operating parameters is carried out via four programming buttons and the text display.
- Before you can start programming, select the language of the display. You can do this by pressing the **+** or **-** and choose the language for the menus and press **ENTER**.
- Note: The language setting can be changed any time by pressing the **ESC button for 5s**.
- Before you can start programming, you have to select the operator (**SWING X or SPIN 250**).

- The text display informs you on the operating modes, selected menus and adjustment of several parameters.
- The programming of the control is done through four buttons (**+**, **-**, **ENTER** and **ESC**).
- Scrolling through the different menu points (up/down) and changing a parameter (increase/decrease) is done with **buttons + and -**.

AUTO-COUNT: When a button is pressed and held, an automatic scrolling of the menu (or change of the parameter) is carried out.

- By pressing the **ENTER-button** you enter the displayed menu point or memorise the shown value of a parameter.
- By pressing the **ESC-button** you return to the superior menu point. Changed adjustments of a parameter are rejected with this button (the original value is kept).
- **AUTO-EXIT:** If during programming no button is actuated for 1 minute or longer, the programming mode is left automatically. The control is set „ready“ **without storage** of possibly changed values.

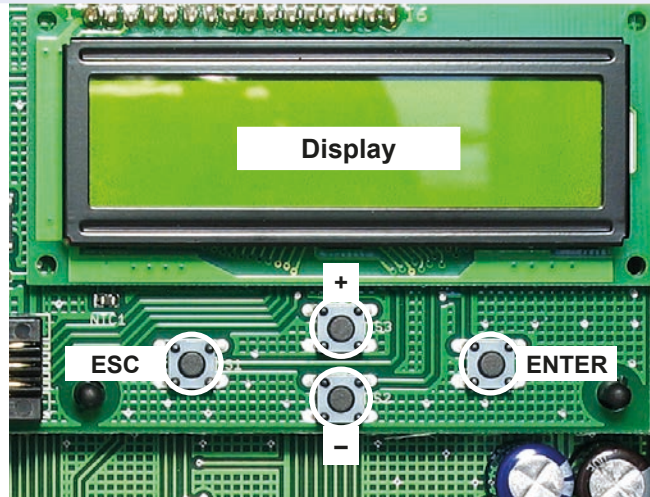

Programming menu

Adjustments - Overview



- The programming menu is divided into „BASIC SETTINGS“ and the „MENU CONTROL“.

BASIC SETTINGS

- When programming the control the **first time**, you enter the „**BASIC SETTINGS**“.
- Here the necessary adjustments for operation of the gate facility are made.
- Entering the menu control (for extended programming) is possible by selecting „**MENU CONTROL**“

MAIN MENU CONTROL

- The next time you will directly enter „**MENU CONTROL**“. (The BASIC SETTINGS are skipped.)
- The menu control contains all possible adjustments.



In the folloleaf the single menu points are marked as shown below:

- = possible adjustment (or value assignment)
 = factory setting
 = status display
 marks the menu points which are contained in the BASIC SETTINGS

Note: some adjustments regarding function or operating logic can only be executed if gate is closed and if the display shows „ready“.



Main layer	Sub layer	Adjustments
buttons/switches → page 8, 9	impulse button	<input type="radio"/> OPEN/STOP/CLOSE <input type="radio"/> OPEN/CLOSE/OPEN <input type="radio"/> OPEN <input type="radio"/> DEAD MAN
	pedestrian button	<input type="radio"/> OPEN/STOP/CLOSE <input type="radio"/> OPEN/CLOSE/OPEN <input type="radio"/> OPEN <input type="radio"/> Impulse OPEN <input type="radio"/> DEAD MAN *)
safety → page 10–13	inner photocell	<input type="radio"/> active <input type="radio"/> not active
	outer photocell	<input type="radio"/> active <input type="radio"/> not active
	main safety edge 1	<input type="radio"/> active <input type="radio"/> not active <input type="radio"/> radio edge TX310
	main safety edge 2	<input type="radio"/> active <input type="radio"/> not active <input type="radio"/> radio edge TX310
	photocell function inside	<input type="radio"/> during closing reverse <input type="radio"/> stop - after release open <input type="radio"/> during opening stop - then open
	photocell function outside	<input type="radio"/> during closing reverse <input type="radio"/> stop - after release open
	PHC-pause time	<input type="radio"/> no influence of photocell <input type="radio"/> abort pause time <input type="radio"/> re-start of pause time <input type="radio"/> immediate close after opening
	PHC-self test	<input type="radio"/> active <input type="radio"/> not active
left leaf → page 16	motor (left)	<input type="radio"/> motor ON <input type="radio"/> motor OFF
	delay left leaf	<input type="radio"/> opening delay <input type="radio"/> closing delay
	delay time left	<input type="radio"/> 0...25s ⊙ = 2s
	ARS response time	<input type="radio"/> 0,15...0,95s [increment: 0,05] ⊙ = 0,50s
	max. force	<input type="radio"/> 20...100% ⊙ = 70%
	soft stop time	<input type="radio"/> 0...25s ⊙ = 5s
right leaf → page 16	motor (right)	<input type="radio"/> not active <input type="radio"/> active only with SWING X ! <input type="radio"/> motor ON <input type="radio"/> motor OFF
	delay right leaf	<input type="radio"/> opening delay <input type="radio"/> closing delay
	delay time right	<input type="radio"/> 0...25s ⊙ = 2s
	ARS response time	<input type="radio"/> 0,15...0,95s [increment: 0,05] ⊙ = 0,50s
	max. force	<input type="radio"/> 20...100% ⊙ = 70%
	soft stop time	<input type="radio"/> 0...25s ⊙ = 5s
operating mode → page 16, 17	impulse logic	<input type="radio"/> not active <input type="radio"/> active only with SWING X ! <input type="radio"/> stop, start of pause time <input type="radio"/> impulse suppression when opening <input type="radio"/> pause time extension
	operating mode	<input type="radio"/> impulse mode <input type="radio"/> automatic 1...255s [increment: 1]
	partial opening	<input type="radio"/> 25...100% ⊙ = 100%
	automatic mode	<input type="radio"/> complete/partial opening <input type="radio"/> only complete opening <input type="radio"/> only partial opening
	pause time logic	<input type="radio"/> no influence <input type="radio"/> permanent open in automatic mode
	closing edges	<input type="radio"/> left/right <input type="radio"/> inside/outside
	limit tolerance	<input type="radio"/> 3...20 ⊙ = 20
lights/lamps → page 18	prewarning OPEN	<input type="radio"/> OFF, 1...30s ⊙ = OFF
	prewarning CLOSE	<input type="radio"/> OFF, 1...30s ⊙ = OFF
	courtyard lamp ¹	<input type="radio"/> OFF, 5...950 ⊙ = OFF
	control lamp ¹	<input type="radio"/> illuminates during open and close <input type="radio"/> blinks slowly / illuminates / blinks <input type="radio"/> illuminates in open position
peripherals → page 19–21	electric lock	<input type="radio"/> switched off visible only if activated under „locking“ <input type="radio"/> 1...10s
	reverse stroke	<input type="radio"/> switched off <input type="radio"/> 0,5...8s
	additional module	<input type="radio"/> courtyard/control lamp <input type="radio"/> status display 1 <input type="radio"/> status display 2
	locking	<input type="radio"/> e-lock/magnetic clamp <input type="radio"/> motor lock
	motor lock	<input type="radio"/> OPEN and CLOSE visible only if activated under „locking“ <input type="radio"/> only OPEN <input type="radio"/> only CLOSE
diagnosis → page 22	status display	<input checked="" type="radio"/> status display
	delete position	<input type="radio"/> NO <input type="radio"/> YES
	factory setting	<input type="radio"/> NO <input type="radio"/> YES
	software version	<input checked="" type="radio"/> show software version
	serial number	<input checked="" type="radio"/> show serial number

¹⁾ The menu points courtyard lamp and control lamp will only appear on display if in menu „Additional module“ ⊙ courtyard lamp/control lamp is selected.



tousek®

DIGITAL



Swing gate control unit ST61



Warning



- Before taking off the control cover, the mains switch must be turned off!
- If the control is power supplied, its inner part is under tension.
- In order to avoid electrical strokes, the safety regulations have to be kept.
- The device may only be connected by trained professionals.
- The product is not suitable for installation in explosion-hazardous areas.
- An all-pole disconnecting mains switch with a contact opening gap of min. 3 mm has to be foreseen. The gate facility has to be secured according to the valid safety regulations!
- **IMPORTANT:** The control lines (sensor, buttons, radio, photocells, etc.) have to be laid separately from the 230V lines (supply line, motors, signal lamp).



The single menu points are marked as shown below:

○ = possible adjustment (or value assignment) ⊙ = factory setting ⇄ = status display

☞ marks the menu points which are contained in the BASIC SETTINGS

- For some menu points e.g. stop-button, photocells and safety sensing edges, the status of the according input as well as the terminal numbers are shown on the text display.
- A general status display of all inputs is available in menu DIAGNOSIS/STATUS DISPLAY.

Buttons/switches

Connections and adjustments

☞ Impulse button (terminals 30/32)

Buttons/switches

- ⊙ **OPEN/STOP/CLOSE successive impulses (factory setting):** an impulse of the impulse switch makes the motor start opening/closing. If the impulse switch is actuated again during this opening-/closing movement, the motor stops. With the next command of the impulse switch the motor moves in the opposite direction of the last gate movement
- **OPEN/CLOSE/OPEN successive impulses:** an impulse of the impulse switch makes the motor start opening/closing. If the impulse switch is actuated again during this opening/closing movement, the travel direction is reversed.



- In this operation mode it is not possible to stop the motor with the impulse switch – it always moves until reaching an end position. (Opened or closed position).
- for the function OPEN/CLOSE/OPEN we strongly suggest the installation of a photocell!!

- **OPEN:** Only opening commands are accepted by the impulse switch – closing the gate with the impulse switch is not possible.
- **DEAD MAN:** The motor opens as long as the impulse switch is pressed (hold) – closing the gate with the impulse switch is not possible. As soon as the switch is released, the motor stops. **If hold to run operating mode is selected, the radio receiver slot (FE) is set out of order for reasons of safety.**



- If the impulse switch is set to DEAD MAN operation, then the pedestrian button works the same way. With the impulse switch or the pedestrian button the gate is opened, with the CLOSE-button it is closed.
- **IMPORTANT: Do not put into operation in dead man mode. Select only after putting into operation (☞ page 24), if desired.**



Push buttons, key switches or external radio receivers with potential-free contacts can be used as impulse switches.

○ **OPEN/STOP/CLOSE successive impulses:**

An impulse of the pedestrian button makes the according gate leaf open/close. If the pedestrian button is actuated again during this movement, the motor stops. With the next impulse the motor moves in opposite direction of the last gate movement.

○ **OPEN/CLOSE/OPEN successive impulses:**

A command of the pedestrian button makes the according gate wing open/close. If the button is actuated again during this movement, the travel direction is reversed.



- In this operation mode it is not possible to stop the motor with the pedestrian button – it always moves until reaching an end position. (Opened or closed position).
- for the function OPEN/CLOSE/OPEN we strongly suggest the installation of a photocell!

○ **OPEN:** Only opening commands are accepted by the impulse switch – closing the gate with the impulse switch is not possible.

○ **Impulse OPEN:** The contact at terminals 30/34 works as a second impulse button with the fixed adjustment „OPEN“.



A command with the pedestrian button effects a complete opening of both leaves when the adjustment “Impulse OPEN” is selected.

○ **DEADMAN:** The motor opens as long as the impulse switch is pressed (hold) – closing the gate with the impulse switch is not possible. As soon as the switch is released, the motor stops. **If hold to run operating mode is selected, the radio receiver slot (FE) is set out of order for reasons of safety.**



The DEADMAN function can not be chosen actively but is set automatically as soon as the impulse button is set to DEADMAN mode.



Push buttons, key switches or external radio receivers with potential-free contacts can be used as pedestrian button.

CLOSE-button (terminals 30/33)

• A command with the CLOSE-switch engages closing of gate. In deadman mode the gate closes as long as the CLOSE-switch is pressed/switched. As soon as switch is released the gate movement stops.



As CLOSE-buttons you may use pushbuttons or key switches as well as external radio receivers with potential free make contacts can be used.

STOP-switch (terminals 30/31)

• when pressing the stop switch the gate stops in any desired position.



As stop switch a break contact has to be used. If no stop switch is connected, terminals 30/31 have to be wire-bridged.



The stop input has no emergency stop function! - In order to ensure the emergency stop function, provide the supply line with an all-pole disconnecting emergency stop switch, that locks after actuation!



Important: notes for photocells

Photocell connection:

- The control unit has a power supply connection for a **24V a.c.** photocell (PHC)

Versorgung: PHC-transmitter: terminals 41/42
 PHC-receiver: terminals 43/44

Note: in „gate closed“ position the terminals 41/42 are being switched into energy saving mode (no current) (only if the radio transmission system TX 310 is not used) !

- At supplied and positioned photocells the contact has to be closed (make contact).

PHC contacts: inside = term. 45/46, outside = term. 45/48,
back area = With additional inner photocells the back area of the gate can be monitored. (All inner photocells are then set in series at control terminals 45/46 (terminals for inner photocells).

Mounting notes (SYNC function):

IMPORTANT: When using two pairs of photocells please do not install both photocell transmitters/receivers on the same side (to eliminate interference between both) !

Exception: photocells with SYNC function allow the installation of both photocell transmitters/receivers on the same side without causing interference to each other.

Self-monitoring of photocells:

The control unit has a monitoring function for the connected photocells. A test will be triggered by each impulse and will be checked if the receiver of the photocell responds to the signal from the photocell transmitter. If there is no communication between the photocell receiver and transmitter the control unit responds with an error.

⚠ The deactivation of the self-test function is only permitted if the safety installations correspond to the category 3 !

Photocell functions:

The exact function of the photocells depends on the programming of the control unit:
 see menu point SAFETY/inner (outer) photocell function, resp. photocell with pause time (→ page 13).

Detailed information you will find in the corresponding photocell manual.

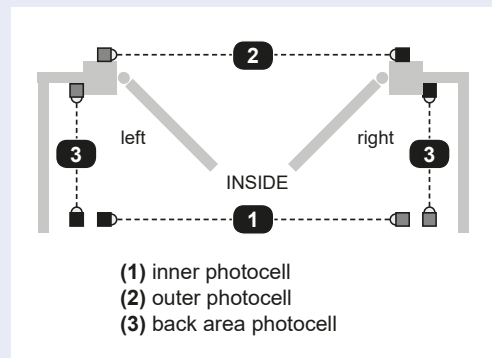

Standard	transmitter 1	receiver 1
	receiver 2	transmitter 2
mit SYNC	ransmitter 1	receiver 1
	ransmitter 2	receiver 2

G inner photocell (contact: terminals 45/46)

Safety

- active:** to be selected, if inner photocell should be triggered.
- not active:** to be selected, if inner photocell should not be triggered.

G outer photocell (contact: terminals 45/48)

Safety

- active:** to be selected, if outer photocell should be triggered.
- not active:** to be selected, if outer photocell should not be triggered.

Photocells - connection examples

Outer photocell Tousek LS 180 as safety device

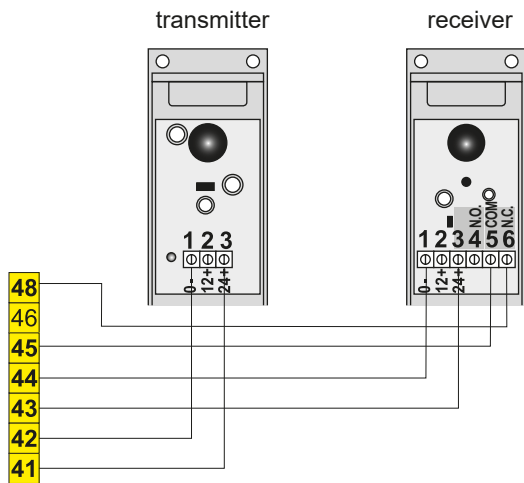

Important

- To activate the SYNC-function, the plug-in bridges (J) in both photocell transmitters **have to be removed**. (see manual LS 180).

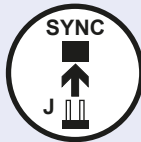

Outer and inner photocell Tousek LS 180 as safety device

with active SYNC-function

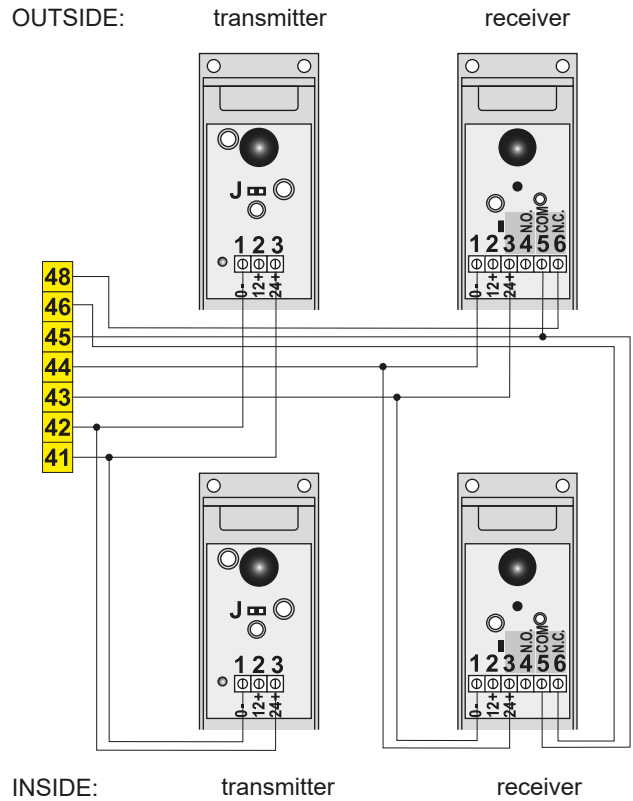

Outer photocell Tousek LS 26 as safety device

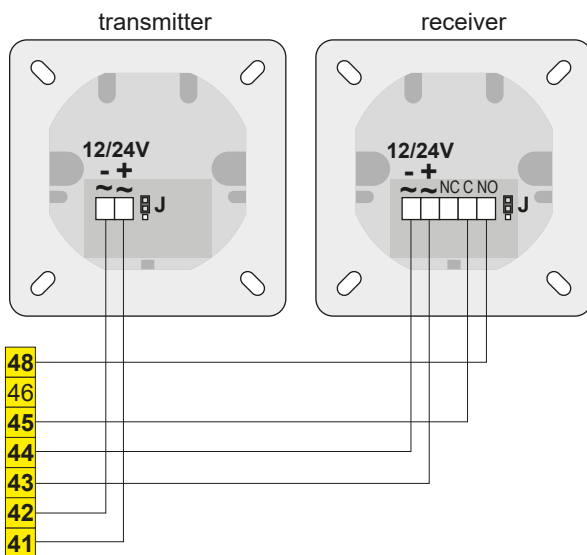

Important

- Jumper J of transmitter and receiver has to be adjusted in the same way.

Outer reflective photocell Tousek RLS 620 as safety device

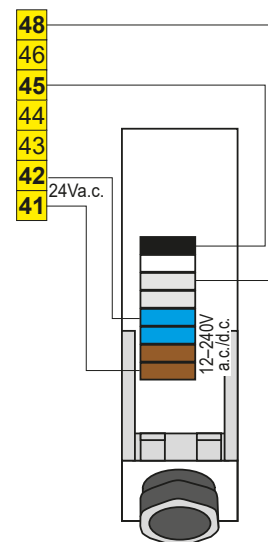



Safety sensing edges (main closing edge 1 + 2)

- **OBSTACLE DETECTION:** when a contact strip/safety edge is triggered/activated then a change of direction is effected for 1 second. Then the gate stops.
- The activation of the safety sensing edges is made in menu „**Safety / main closing edge 1**“ (term. 50/52) and „**Safety / main closing edge 2**“ (term. 50/53)
- If in the menu item „**operating logic / closing edge**“ (page 17) one of the modes „**left / right**“ or „**inside / outside**“ is selected - this results in the wiring of the safety contact edges to make with each other and the connection to the control terminals.

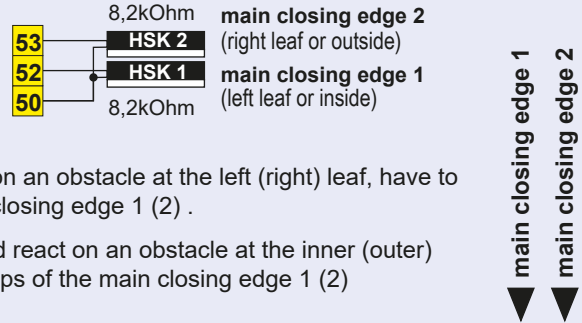

Safety sensing edges in mode „**left/right**“, that should react on an obstacle at the left (right) leaf, have to be connected (serially) to the connection clamps of the main closing edge 1 (2) .

Safety sensing edges in mode „**inside/outside**“, which should react on an obstacle at the inner (outer) side of the leaf, be connected (serially) to the connection clamps of the main closing edge 1 (2)

Example: W 8,2kΩ final resistance
 E final edge
 D passage edge
 S to the control board

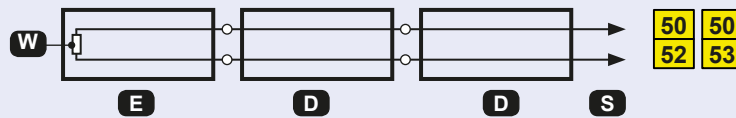

When connecting one safety edge a final edge (1) has to be used.



Important

- After giving the impulse to program the end positions, no other impulse must be given. Also the safety devices mustn't be triggered. This would lead to an interruption of the programming process.
- Therefore, the mechanical stops must be set so that the existing contact strips cannot be triggered.

G main safety edge 1 (terminals 50/52)

Safety

- ⊙ **active:** to be selected if the contact strip (8,2kOhm) of main safety sensing edge 1 should be evaluated.
- **not active:** to be selected if the contact strip of main safety sensing edge 1 should not be evaluated
- **radio edge TX310:** to be selected if safety sensing edge (8,2kΩ) of main entrance edge 1 should be evaluated **with the radio transmission system TX 310.**

G main safety edge 2 (terminals 50/53)

Safety

- ⊙ **active:** to be selected if the contact strip (8,2kOhm) of main safety sensing edge 2 should be evaluated.
- **not active:** to be selected if the contact strip of main safety sensing edge 2 should not be evaluated
- **radio edge TX310:** to be selected if safety sensing edge (8,2kΩ) of main entrance edge 2 should be evaluated **with the radio transmission system TX 310.**



- Connection and detailed information of radio transmission system TX 310 see according manual.

Photocell function inside

Safety

- ⊙ **during closing reverse:** an interruption of the photocell during closing makes the gate reverse (open). In automatic mode the gate closes as soon as the pause time has run out. In impulse operation another closing command has to be given.
- **stop - after release open:** an interruption of the photocell beam during opening or closing makes the motor stop as long as the photocell stays interrupted. After release of the photocell, the gate opens. In automatic mode the gate closes as soon as the pause time has run out, in impulse operation another closing command has to be given.
- **during opening stop - then open:** an interruption of the photocell during opening makes the motor stop as long as the photocell stays interrupted. After release of the photocell, the gate opens (back area monitoring). In automatic mode the gate closes as soon as the pause time has run out, in impulse operation another closing command has to be given.

Photocell function outside

Safety

- ⊙ **during closing reverse:** an interruption of the photocell during closing makes the gate reverse (open). In automatic mode the gate closes as soon as the pause time has run out. In impulse operation another closing command has to be given.
- **stop - after release open:** an interruption of the photocell beam during opening or closing makes the motor stop as long as the photocell stays interrupted. After release of the photocell, the gate opens. In automatic mode the gate closes as soon as the pause time has run out, in impulse operation another closing command has to be given.

PHC-pause time

Safety

- ⊙ **no influence of photocell:** the photocell doesn't have any influence on the pause time in automatic mode.
- **abort pause time:** in automatic mode an interruption of the outer photocell during pause time shortens the pause time. After release of the photocell the gate starts closing.
- **re-start of pause time:** in automatic mode an interruption of the outer photocell during pause time, restarts the pause time. As soon as the pause time has run out, the gate closes.
- **immediate close after opening:** If the outer or inner photocell is interrupted during the opening movement or if the outer photocell is interrupted in open position, then the gate begins to close after the release of the photocell.

PHC-self test

Safety

- ⊙ **active:** photocell self-test is executed with an opening impulse (switch, button) in gate position „closed“.
- **not active:** photocell self-test is not executed

**Attention**

- The photocell self-test can only be deactivated by selecting „not active“.
- The deactivation of the self-test function is only permitted if the safety installations correspond to the category 3 !



Danger



- Before connection work or taking off the housing cover, the power supply has to be turned off !
- All electrical installations (control panels, safety devices, impulse switches and buttons) and force adjustments (see menu: left left / right leaf) have to be made in full conformity with the applying rules and laws!
- ☑ also follow safety instructions on page 5 !



Important: notes for connection and adjustment of operators

- It is possible to connect 2 motors 230V (max. 500W/motor) with control ST61.
- **Attention: Before carrying out any connection works, the power supply of the gate facility has to be turned off.**
- Operators' power supply and sensor cables as well as the capacitors must be connected to the ST 61 control unit according to the installation manual. The sensor signal defines the performance/response when hitting an obstacle or when reaching a gate end position (adjustment of sensor sensibility please see menu "left (right) wing".
- Note that after turning on the power supply and giving an impulse the gate leaves open. If this is not the case then the terminals 20/22 of the left motor or the terminals 24/26 of the right motor have to be interchanged.
- **Important: for operation with one motor/operator please deactivate the other one by choosing "MOTOR OFF" ! The adjustments in the menu LEFT (RIGHT) LEAF/OPERATOR „Motor ON or OFF“ must match the actual motor connection on the control unit terminals.**



Motor and sensor wires



- The motor and sensor wires must be supplied to the control unit in 2 separate tubes or a cable channel with partition.
- The sensor wire must not exceed the max. length of 50m ! - For lengths of more than 20m shielded control lines must always be used. The shield must be clamped together with the cable number 3 (terminal 68)
- If sensor wires with more than 3 cables are used the remaining cables must be clamped together with the cable number 3 (terminal 68) - do not clamp to a ground wire (earth lead)!
- When connecting the sensors to the control unit please note the labeling/markings of the cables (number 1–3). Bad connection leads to destruction !

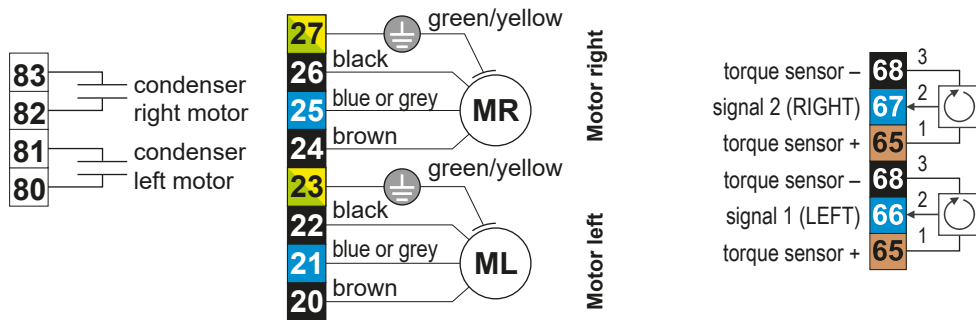

Motor condensers connection and attachment

- **ATTENTION: switch off the control unit before connecting the condensers !**
- 2 condensers have to be connected to the ST61 as follows: **left operator: clamps 80/81, right operator: clamps 82/83** (see connecting diagram above)
- To fix the 2 condensers inside the operator housing please use the sockets. After having mounted the condensers with the lace to the sockets they should be fixed on the inside of the operator's control housing.
- The placement of the condensers can be chosen freely, but we recommend the lower area of the operator control housing, as shown on picture. (see right picture)

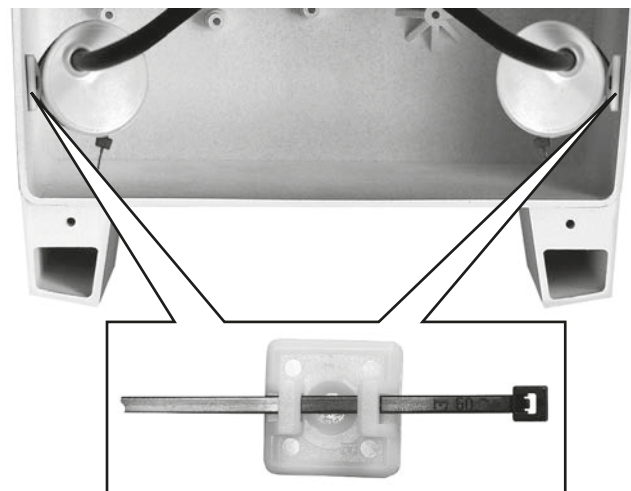

Connection SPIN 250

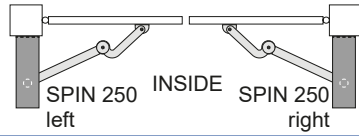

SPIN 250 terminals		Steuerungsklemmen	
number / colour		left operator to terminal	right operator to terminal
(M) power supply	4 brown	20	24
	5 blue or grey	21	25
	6 black	22	26
	⊕ green/yellow	23	27
(S) Sensor	1 red	65	65
	2 blue	66	67
	3 black	68	68

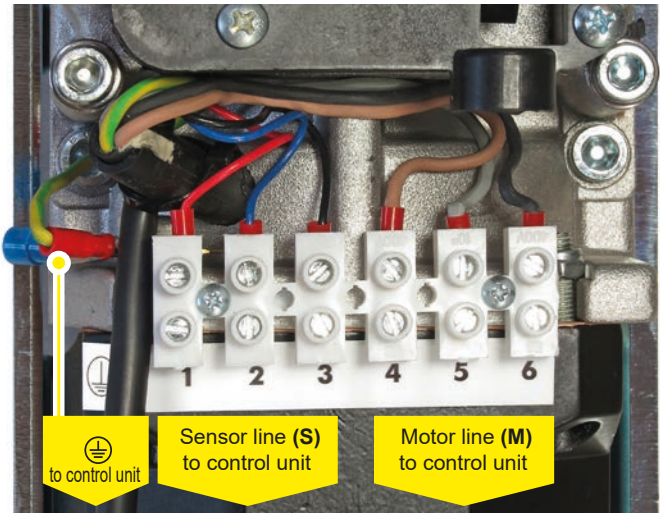

Connection SWING X

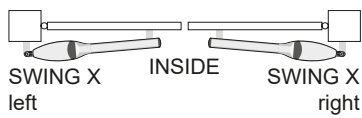

CONNECTION of operators to control unit			
Connection cable with colour or number		left operator to terminal	right operator to terminal
(M) power supply	brown	20	24
	blue or grey	21	25
	black	22	26
	green/yellow	23	27
(S) sensor	1	65	65
	2	66	67
	3	68	68



IMPORTANT!
separate tubes or a cable channel with partition!

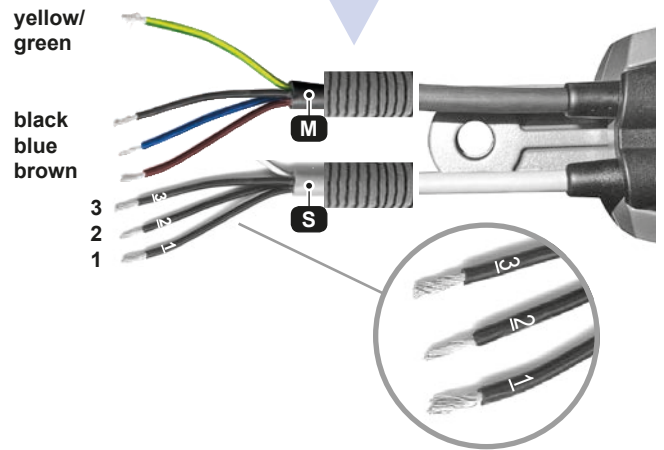

Left leaf

Connections and adjustments

G **Motor** (Supply: terminals 20/21/22, grounding: 23 - Sensor: terminals 65, 66, 68)

Left leaf

- MOTOR ON
- MOTOR OFF.

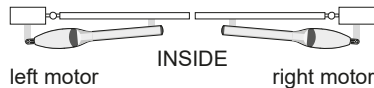

If a left operator is not available then set here to „MOTOR OFF“!

G **Delay left leaf**

Left leaf

- OPENING DELAY:** the left leaf opens after the adjusted delay time.
- CLOSING DELAY:** the left leaf closes after the adjusted delay time.

G **Delay time left** 2s (factory setting)

Left leaf

- 0–25s time delay adjustable:** indicates the delay time at opening or closing.

ARS response time 0,50 (factory setting)

Left leaf

- 0,15–0,95 adjustable:** indicates the response of the Automatic Rerversal System.

Max. force 70% (factory setting)

Left leaf

- 20–100% adjustable:** indicates the motor force in opening/closing movement.

Soft stop time 5s (factory setting)

Left leaf

- 0–25s adjustable:** indicates the duration of the soft stop time.

Soft start

Left leaf

- not active**
- active:** soft start with SWING X.



The option „soft start“ is only inserted for SWING X. With SPIN operator soft start is always active!

Right leaf

Connections and adjustments

G **Motor** (Supply: terminals 24/25/26, grounding: 27 - Sensor: terminals 65, 67, 68)

Right leaf

- MOTOR ON
- MOTOR OFF.

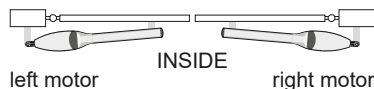

If a right operator is not available then set here to „MOTOR OFF“!

G **Delay right leaf**

Right leaf

- OPENING DELAY:** the right leaf opens after the adjusted delay time.
- CLOSING DELAY:** the right leaf closes after the adjusted delay time.

G **Delay time right** 2s (factory setting)

Right leaf

- 0–25s time delay adjustable:** indicates the delay time at opening or closing.

ARS response time 0,50 (factory setting)

Right leaf

- 0,15–0,95 adjustable:** indicates the response of the Automatic Rerversal System.

Max. force 70% (factory setting)

Right leaf

- 20–100% adjustable:** indicates the motor force in opening/closing movement.

Soft stop time 5s (factory setting)

Right leaf

- 0–25s adjustable:** indicates the duration of the soft stop time.

Soft start

Right leaf

- not active**
- active:** soft start with SWING X.



The option „soft start“ is only inserted for SWING X. With SPIN operator soft start is always active!

Operating mode

Connections and adjustments

Impulse logic

Operating logic

- stop, start of pause time:** a command of the impulse switch during the opening movement stops the gate and starts the pause time in automatic operation – as soon as the pause time has run out, the gate closes automatically.
- impulse suppression when opening:** commands which are emitted during the opening movement are suppressed. Commands during closing are accepted.
- pause time extension:** an impulse in automatic operation restarts the pause time. If this menu point is chosen, the impulse suppression during opening is active at the same time.





Operating mode

Operating logic

- ⊙ **impulse mode:** for initiating the closing movement, an impulse is necessary.
- **automatic closing, pause time adjustable from 1-255s:** gate closes as soon as the adjusted pause time has run out.

Partial opening ⊙ 100% (factory setting)

Operating logic

- **25–100% adjustable:** indicates the partial opening of the gate leaf with closing delay in relation to complete opening width.

This adjustment is ONLY adopted in CLOSED Position.

Automatic mode

Operating logic

- ⊙ **complete/partial opening:** either with complete as well as partial opening, the gate closes automatically after the adjusted pause time.
- **only complete opening:** only after complete opening, the gate closes automatically after the adjusted pause time.
- **only partial opening:** only after partial opening the gate closes automatically after the the adjusted pause time.

Pause time logic

Operating logic

- ⊙ **no influence**
- **permanent open in automatic mode:** if this function is activated, the control unit goes from automatic mode into impulse mode **with activated pause time through impulse in open gate position for this cycle**, hence if gate is open then an impulse will end the automatic mode - the gate remains open. Only the next impulse will close the gate and the control unit goes back to automatic mode. With this function e.g. the entrance to a company site can remain open during the day (1st impulse in gate open position) and closed in the evening (2nd impulse). The control board switches back to automatic mode (autom. opening and closing of gate).
If the gate is in partial open position and „permanent open in automatic mode“ is selected, so it is possible to adjust permanent partial open for this cycle by giving an impulse via **pedestrian button**. Permanent partial open can be finished analogous to the above described method.

Closing edges (HSK 1: terminals 50/52, HSK 2: terminals 50/53)

Operating logic

- ⊙ **left/right:** the safety sensing edges (contact strips) can actuate in every gate movement (OPEN/CLOSE). The safety sensing edge 1 (terminal 50/52) is mounted on the left gate wing and the safety sensing edge 2 (terminal 50/53) on the right wing.

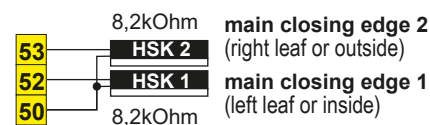

- **inside/outside:** sensing edges at the interior of the gate (terminal 50/52) can only actuate during opening movement and sensing edges on the outside of the gate (terminal 50/53) only during closing movement.

IMPORTANT !		ASSIGNMENT AND RESPONSE OF SAFETY EDGES		
Assignment		Movement	Open	Close
HSK 1	Mode left/right	left	active	active
HSK 2		right	active	active
HSK 1	Mode inside/outside	inside	active	
HSK 2		outside		active

Examples: (D) passage edge, (E) final edge

left (HSK 1 - Kl.50/52) right (HSK 2 - Kl.50/53)

Limit tolerance ⊙ 20 (factory setting)

Operating logic

- **3–20 adjustable:** indicates the tolerance in the end positions (low value = sensitive behaviour).

Prewarning OPEN (terminals 10/11)

Light / Lamps

- ⊙ OFF
- **1–30s adjustable:** before each opening movement the flashing light is activated for the adjusted time..

Prewarning CLOSE (terminals 10/11)

Light / Lamps

- ⊙ turned off
- **1–30s adjustable:** before each closing movement the flashing light is activated for the adjusted time..

**Important: Notes regarding connection of a flashing light**

- **Attention:** Before carrying out connection works, the power supply of the facility has to be turned off.
- A flashing light with 230V, max. 40W can be connected at the terminals 10/11.

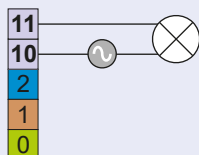
**Warning**

- Before taking off the housing cover the main switch has to be turned off !
- Follow safety instructions (📄 page 5) !



The following two menu points can only be selected if the menu point additional menu is adjusted to „Courtyard-/Control lamp“ (hence shown on display).

Courtyard lamp (Description add. modules 📄 page 19)

Light / Lamps

- ⊙ OFF
- **5–950 adjustable:** at the courtyard lamp output an external lamp can be connected (e.g. garden lamp), which can be turned on for each opening command for the duration of adjusted time.

Control lamp (Description add. modules 📄 page 19)

Light / Lamps

- ⊙ **illuminates during open and close:** The pilot lamp output is activated during opening- and closing movement.
- **blinks slowly/illuminates/blinks:** The pilot lamp output is activated as follows: During opening the pilot lamp flashes slowly. During pause time, in opened position or when the gate stops it is illuminated. During the closing movement it flashes rapidly. If the gate is closed, the pilot lamp expires
- **illuminates in open position:** Pilot lamp is illuminated as soon as the gate has reached end position open.

Electric lock (module terminals 72/73)

Peripherals

- ⊙ **switched off**
- **1–10s adjustable:** The electric lock is activated by push button impulse or impulse from pedestrian button for a period of time set here to ensure the release depending on the gate situation

Reverse stroke (only with activated locking!)

Peripherals

- ⊙ **switched off**
- **0,5–8s adjustable:** Only with activated lock (electric lock or motorized locking bar): After an impulse is given, a short closing movement for unlocking (for example, the E-lock) is initiated first, the unlocking is performed and the door is opening. With an electric lock, the reversal stroke is only carried out in the opening direction. With a motor bolt, depending on the setting, it is possible to set the reversal stroke also in the closing movement.

Additional module

Peripherals

- ⊙ **courtyard/control lamp:** the menu points courtyard lamp and control lamp are ready for adjustment (that means if not selected, these menu points will not be shown on the display)
- **status display 1:** with the two potential-free signal contacts K1 and K2, the gate end positions (limits) can be evaluated.
- **status display 2:** with the two potential-free signal contacts K1 and K2, the gate end positions (limits), the gate movement as well as a gate stop outside of the end positions can be evaluated.



Additional module (optional)

- **turn off power supply before installing the additional module!**
- Depending on which device, e.g. a **courtyard-/Control lamp** is chosen or **evaluation of gate status** should be effected, the corresponding module (**Z**) has to be plugged to the according slot/plug (**ZM**) of control board.
- Additionally the corresponding value has to be selected in menu point „Additional module“.

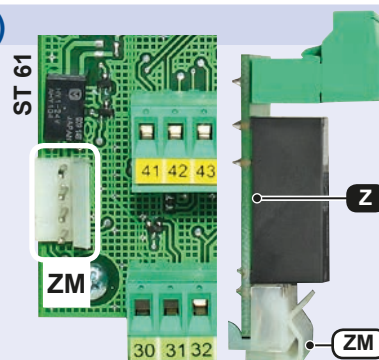

**Additional module
Courtyard lamp/
Control lamp**

- On the terminals 12/13 a courtyard lamp (H) can be connected: **230V, max. 100W**
- On the terminals 70/71 a control lamp (K) can be connected: **24Vd.c., max. 2W**

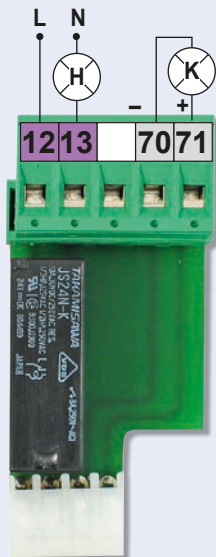

**Additional module
Gate status display**

- with potential free signal contacts K1 (Kl. 90/91) and K2 (Kl. 92/93) the gate status can be evaluated in two ways (see menu point „Additional module“).
- Contact load: **24Va.c./d.c., max. 10W**

		Function		K1	K2
Gate status display	1	Gate in CLOSE-Position	1	0	
		Gate in OPEN-Position	0	1	
2	2	Gate in CLOSE-Position	0	0	
		Gate opens or closes	0	1	
		Gate stopped or fault (Gate not in end position)	1	0	
		Gate in OPEN-position	1	1	

signal contacts: 0 = open, 1 = closed

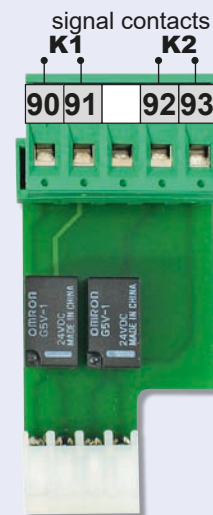

Locking

Peripherals

- ⊙ **e-lock/magnetic clamp:** with additional module electric lock/magnetic clamp.
- **motor lock:** with additional module motorized locking bar.

Motor lock

Peripherals

- ⊙ **OPEN and CLOSE:** locking via motorized locking bar in both end positions of the gate.
- **only OPEN:** locking via motorized locking bar only in open position.
- **only CLOSE:** locking via motorized locking bar only in closed position.

**WARNING:**

- Before taking off the housing cover the main switch has to be turned off !
- Follow safety instructions! (page 5)

**Optional module for electric lock/magnetic clamp**

- The control unit needs an optional module for connection of an electric lock/magnet (12V or 24Vd.c. version depending on electric lock).

Connection of module

- **ATTENTION: turn off power supply!**
- Fix the module as illustrated in the control with screws at position **(P1)**.
- Connect electric lock module via RJ-plug **(E)** with the control unit.
- Connect the electric lock (12/24Vd.c.) to the removable terminals **72/73** of the module.
- The magnet (24Vd.c.) must be connected via a resistor **(R)** for the connection to the module.
- To do this, push the connecting cable of the magnetic clamp as shown into the opening of the series resistor and fix by means of crimping pliers.
- Connect the connection cable and resistor **(R)**, as shown, to the removable terminals **74 (-) / 75 (+)** of the module. **Pay attention to polarity.**
- The supply is connected to the 2-pin connector cable **(V)** to the control terminals **(VE)**.
- After wiring, the E-lock-mode has still to be activated in the menu of the control under LIGHT PERIPHERAL / ELECTRIC LOCK
- Magnets are driven into the open and closed position of the gate, the electric lock only in closed position.

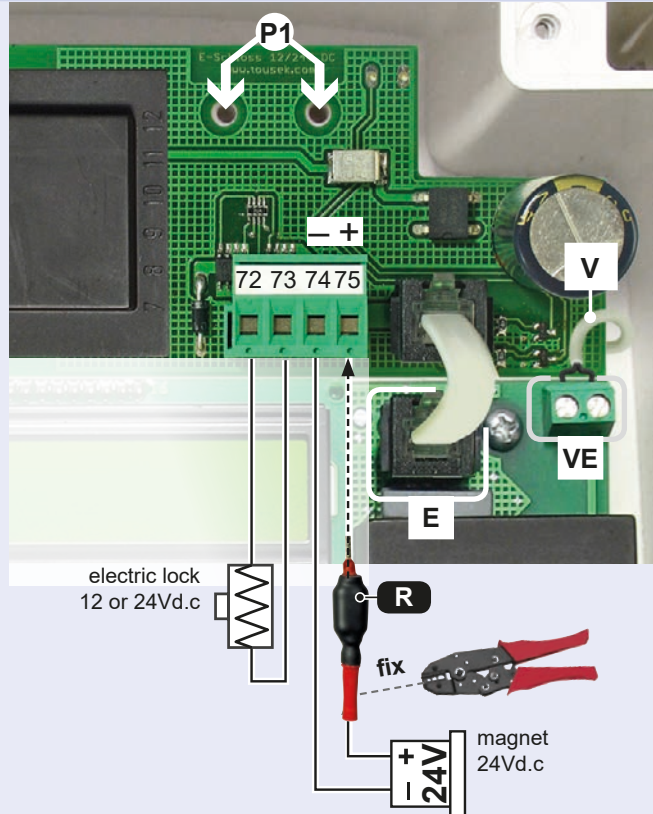

The series resistor (R) is for tousek magnets GD 50 and GD 70.

**optional dropbolt module**

- In order to connect the dropbolt SAFELOCK to the control unit it needs an optional modul and a dropbolt control unit. If needed then for double leaf swing gate also two dropbolts can be connected. Thereby the terminal block is labelled with „X“ for the first bolt and with „Y“ for the second bolt.

Modul connection

- **ATTENTION: Turn off the power supply!**
- Fix the module inside the control unit's housing as shown on the picture. Fix the module on the positions (P1) by spacers and screws (included).
- Connect the modul to the control unit with RJ-plug connection **(E)**.
- Carry out the connections on the modul clamps „X“, „Y“ and on the motor control unit clamps as shown on the picture.
- After succesful connection the dropbolt operation need to be activated in the control unit menu („peripherals/locking“ and „peripherals/dropbolt“)

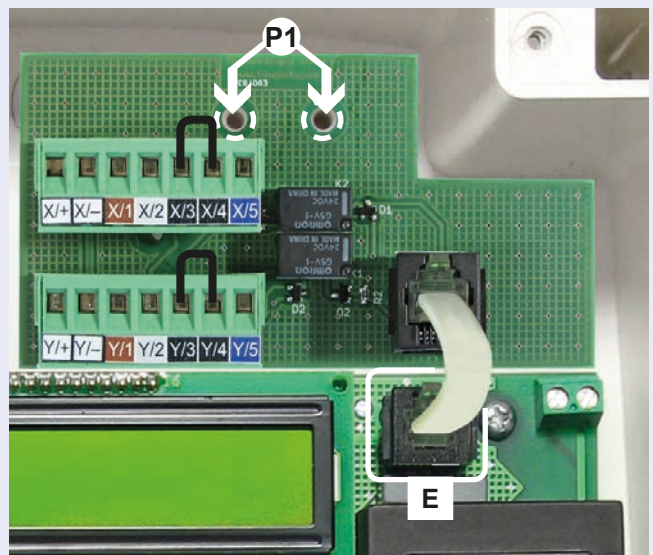

ST 61 with integrated dropbolt modul



IMPORTANT: When using only one drop bolt, the wire jumper must remain in the unused terminal block!

Dropbolt control unit

Wire the terminal block (K) of the dropbolt's printed circuit board as shown on the picture::

- on one hand wire it with the module, which is connected to the operator's control unit:
 - for 1 dropbolt: wire only with the terminal block „X“ - for 2 dropbolts wire with terminal blocks „X“+„Y“
- on the other hand wire it with the dropbolt via connection cable 4 x 0,75² (motor connection and limit switch) . Strictly note the numbering **1 – 4** of the connection cable's wires for a proper connection.
- Carry out the 230V a.c. power supply connection on terminal block (V) and the earthing connection on the earthing screw.



SAFELOCK-control unit with 1 motor print:

- suitable for 1 dropbolt
- connection motor print: with „X“-terminal block

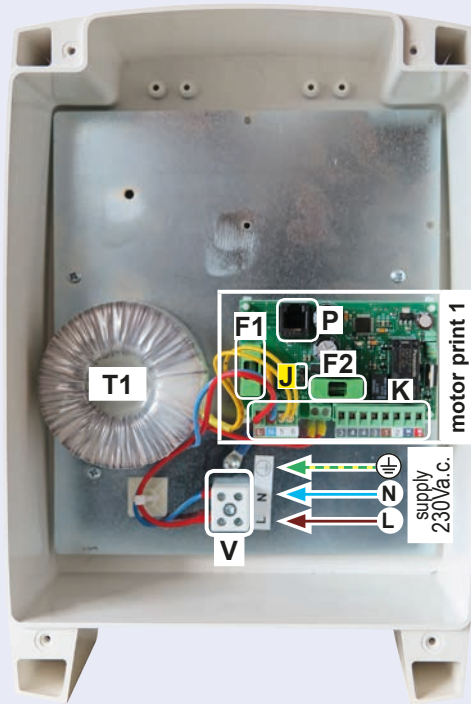

- (P) programming slot
- (F1) fuse 0,25A T
- (F2) fuse 4A T
- (J) Jumper
- (T1) transformer 1
- (T2) transformer 2
- (K) terminals
- (V) 230Va.c. supply terminals

Limit switch closed,
if the bolt is retracted

DROPBOLT 1

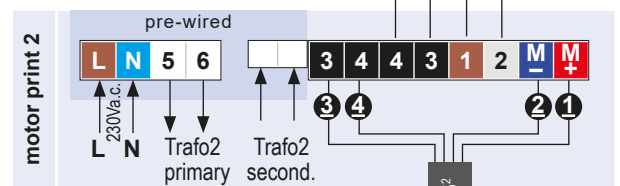
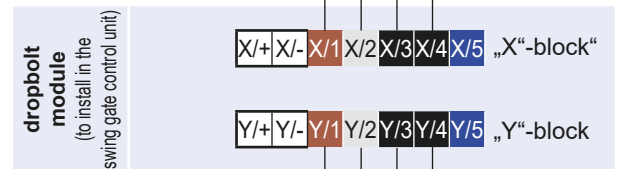
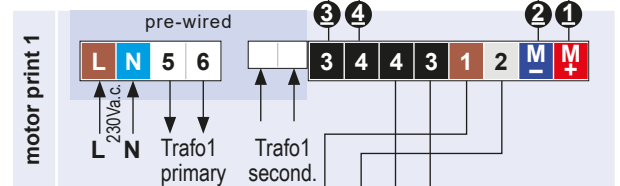
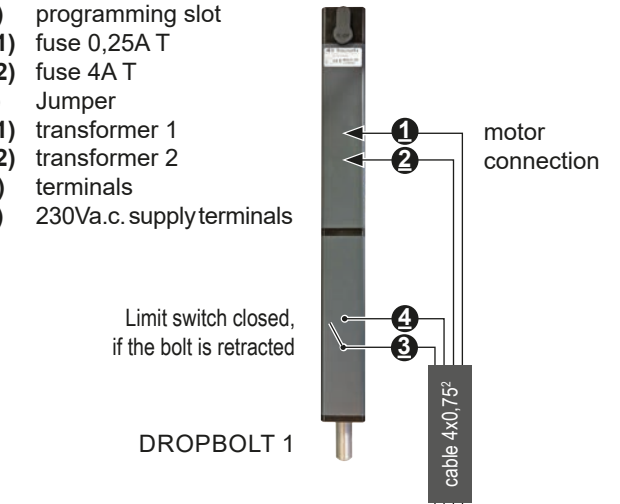

SAFELOCK-control unit with 2 motor prints:

- suitable for 2 dropbolts
- connection motor print 1: with „X“-terminal block
- connection motor print 2: with „Y“-terminal block

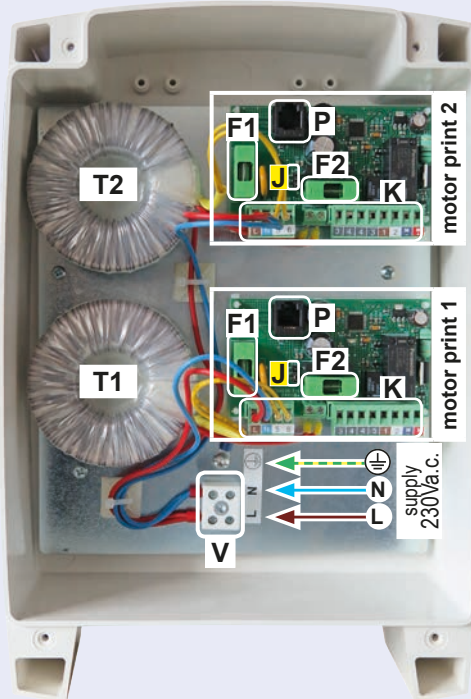

Jumper J	motor print
	„T“ with tousek control units ST 51, ST 61, ST REX
	„T“ with foreign control units

Limit switch closed,
if the bolt is retracted

DROPBOLT 2

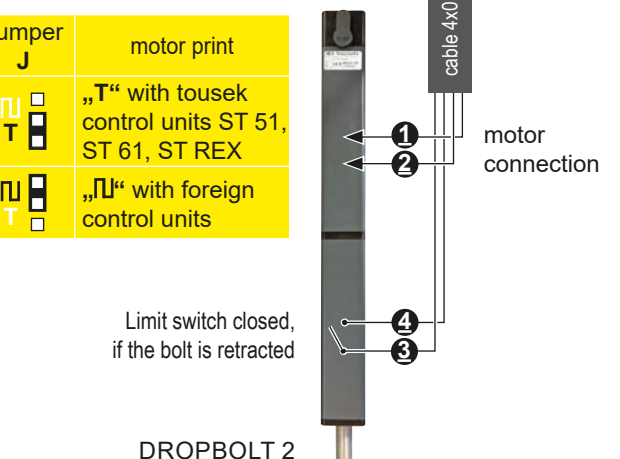





Status display

Diagnosis

↻ status display for inputs as photocell, safety sensing edges, stop button, impulse switch

- I impulse switch
- P partial opening switch
- C CLOSE-switch
- S STOP-switch
- Pi photocell inside
- Po photocell outside
- 1 safety edge main closing edge 1
- 2 safety edge main closing edge 2

-  Status: not triggered
-  Status: triggered
-  Status: contact strip not connected or defect
-  Status: contact strip or photocell deactivated in menu

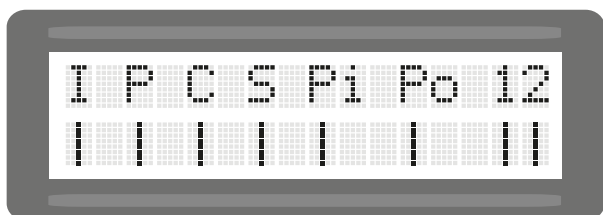

e.g.

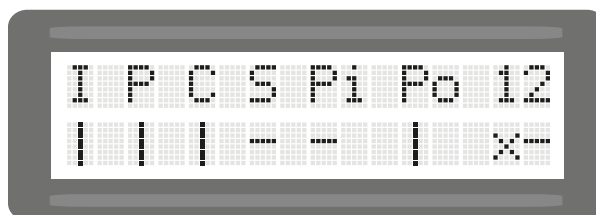

All inputs OK.

Impulse-, pedestrian - and close button not triggered.
 STOP-button and photocell inside are triggered.
 Photocell outside not triggered.
 Contact strip 1 not connected or defect.
 contact strip 2 triggered.

Delete position

Diagnosis

- ⊙ **NO:** no deleting of end positions “gate closed” and “gate open”
- **YES:** the determined end positions are being deleted.
 Note: the end positions are being newly determined after impulse.



The mechanical stops have to be placed so that possibly existing safety contact edges can not be triggered, as this would lead to an error message.

Factory setting

Diagnosis

- ⊙ **NO:** no reset to factory setting
- **YES:** reset to factory setting



Note: The factory settings of the single menu points are marked with ⊙ in this manual.

Software version

Diagnosis

↻ shows the software version and the operator type on the text display

Serial number

Diagnosis

↻ shows the serial number on the text display

- Disconnect the power supply. 
- Plug-in the receiver printed circuit board (E) RS433/868-STN1 (1 channel) or RS433/868-STN2 (2 channels) into the corresponding slot (FE) as shown in the picture.
- For range extension an external antenna FK433 or FK868 can be connected.



Important

- With the use of the 2-channel-receiver the second channel takes over the function of the pedestrian entry mode switch.
- For programming of receiver please *see manual for radio receiver.*

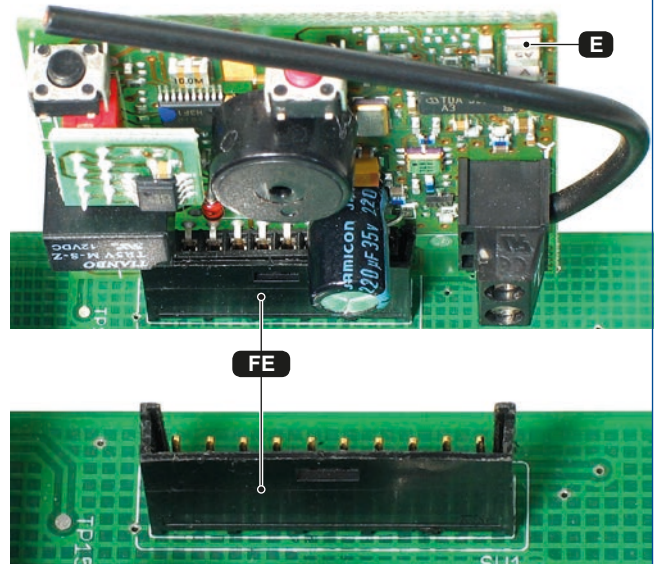
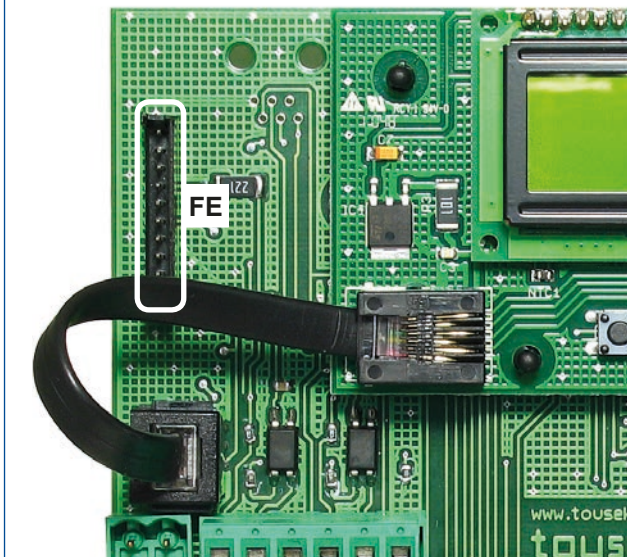



Important: preparation works

- Connect control panels, safety devices to the motor under the safety regulations in .
- **Attention: if no stop switch is connected then the terminals 30/31 have to be bridged.**
- **The mechanical limits have to be placed so that contact edges are not triggered, as this would lead to an error message**
- Unlock emergency release of operator and set gate to half-opened position. Then lock the operator again
- Then turn on the operator (correct connection necessary).
- **Important:** Putting into operation in Impulse mode (standard setting) and not in dead man mode.
- During initial operation the choice of language and operator (SWING X or SPIN 250) is made first, then in the “Basic settings” the adjustment of most important operator settings and after the system test, the automatic detection of limit positions of gate is made.

LANGUAGE SELECTION

- Can be selected during initial operation (hence after reset to factory settings).
- Can be also chosen by pressing the ESC button (↵) for 5s, from any position in menu.

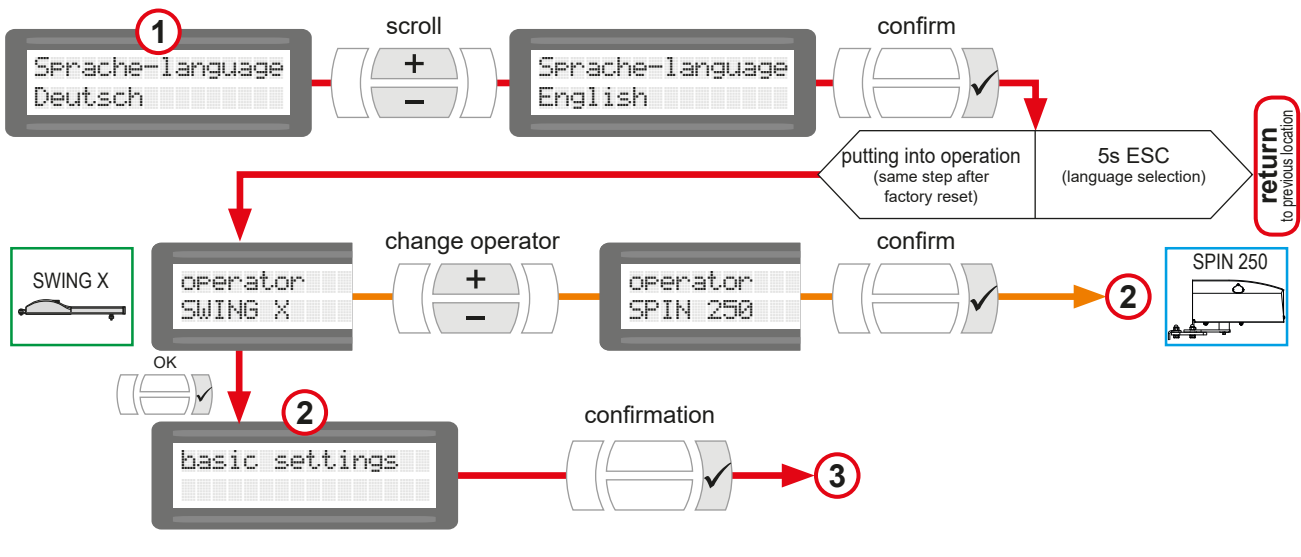

BASIC SETTING

- For setting the most important adjustments for initial operation of motor.
- Can be selected during initial operation (hence when restoring the factory setting).
- All safety devices are activated when leaving factory (menu → page 7).
- The next programming adjustments are made in the main settings menu (see → 6–7).

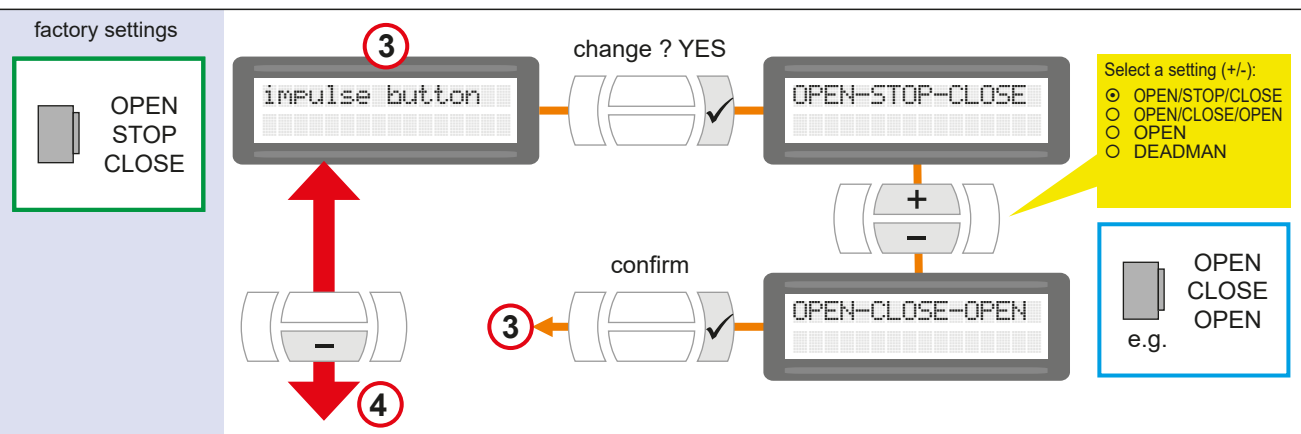

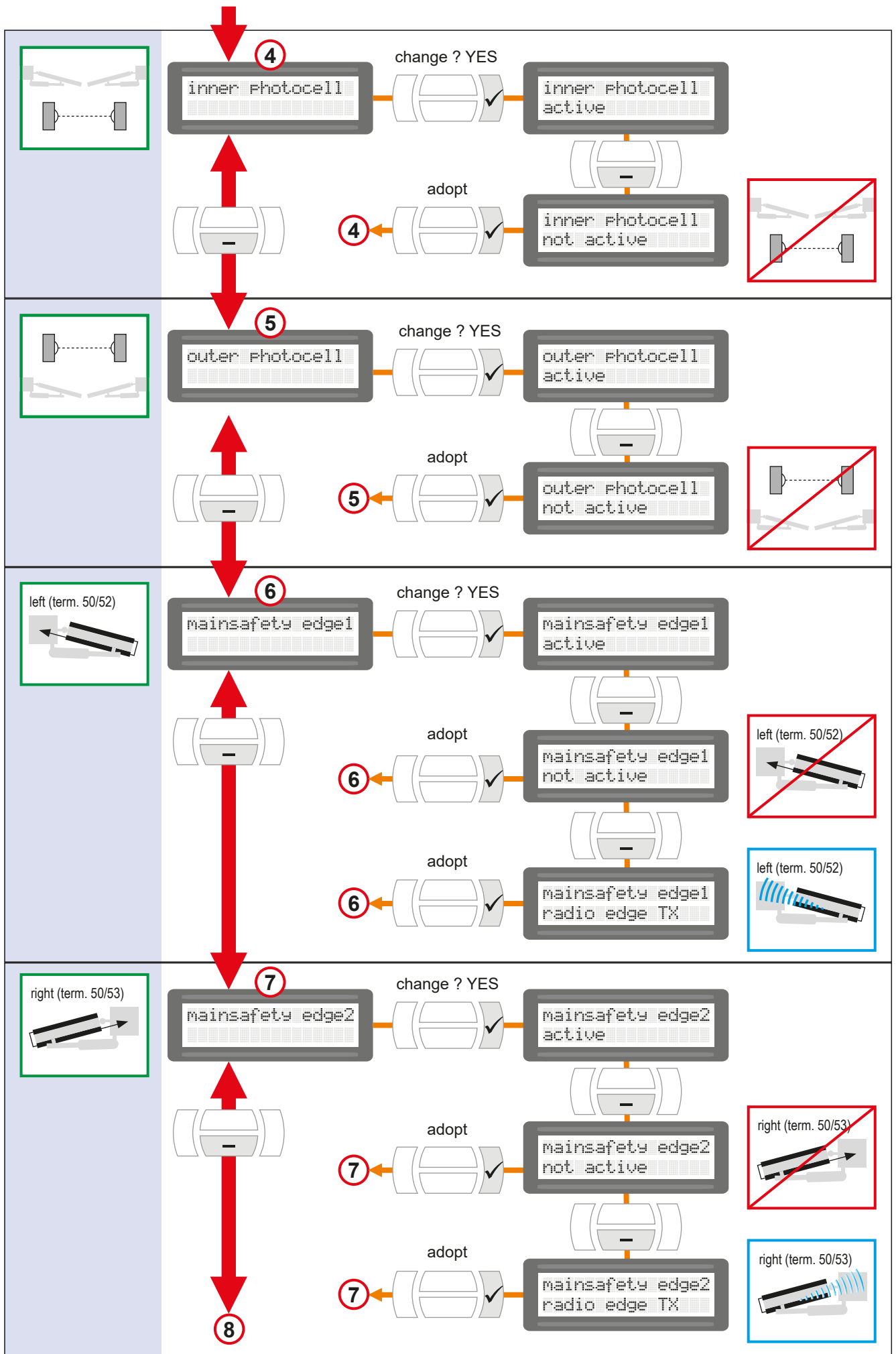

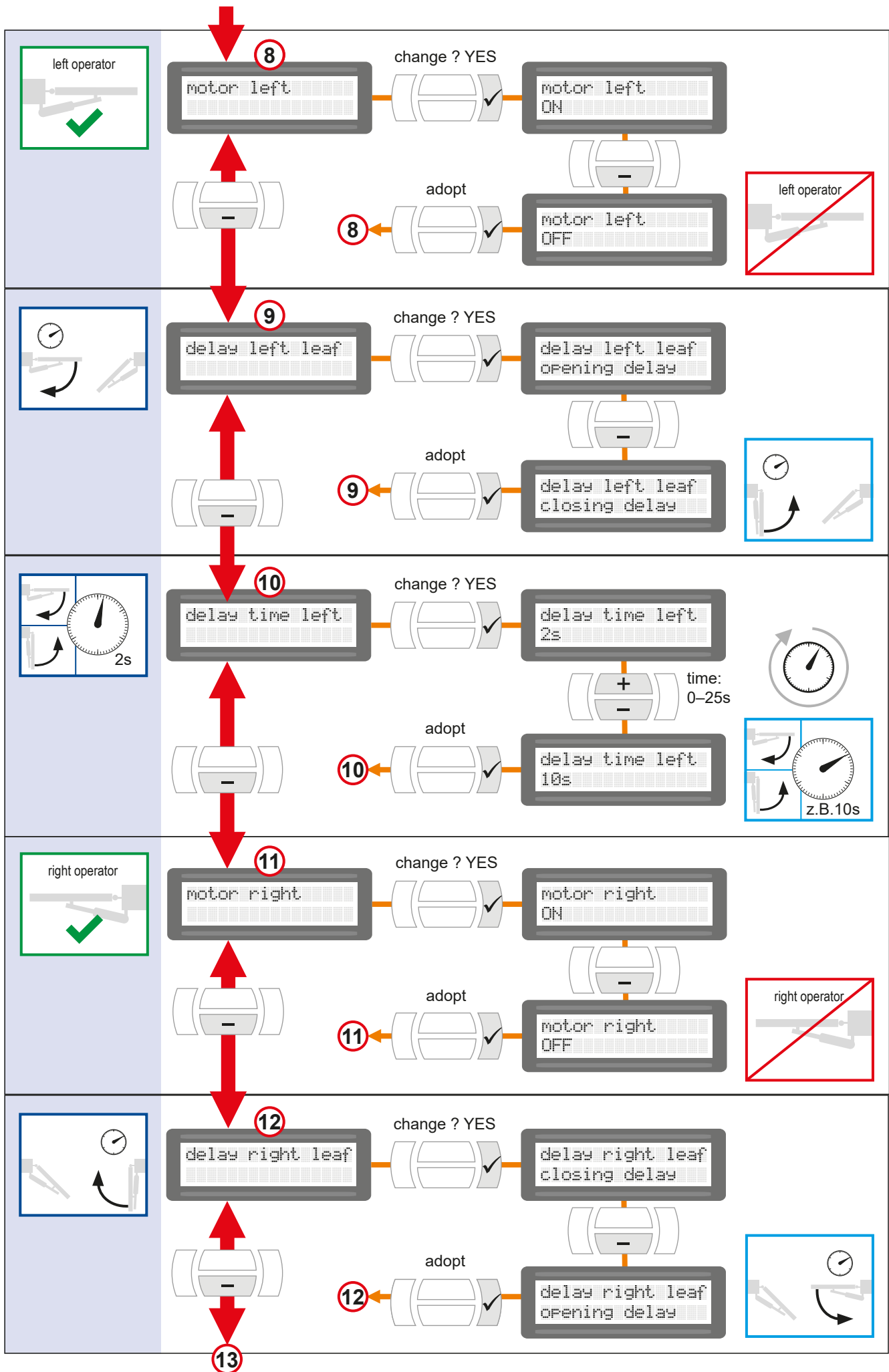

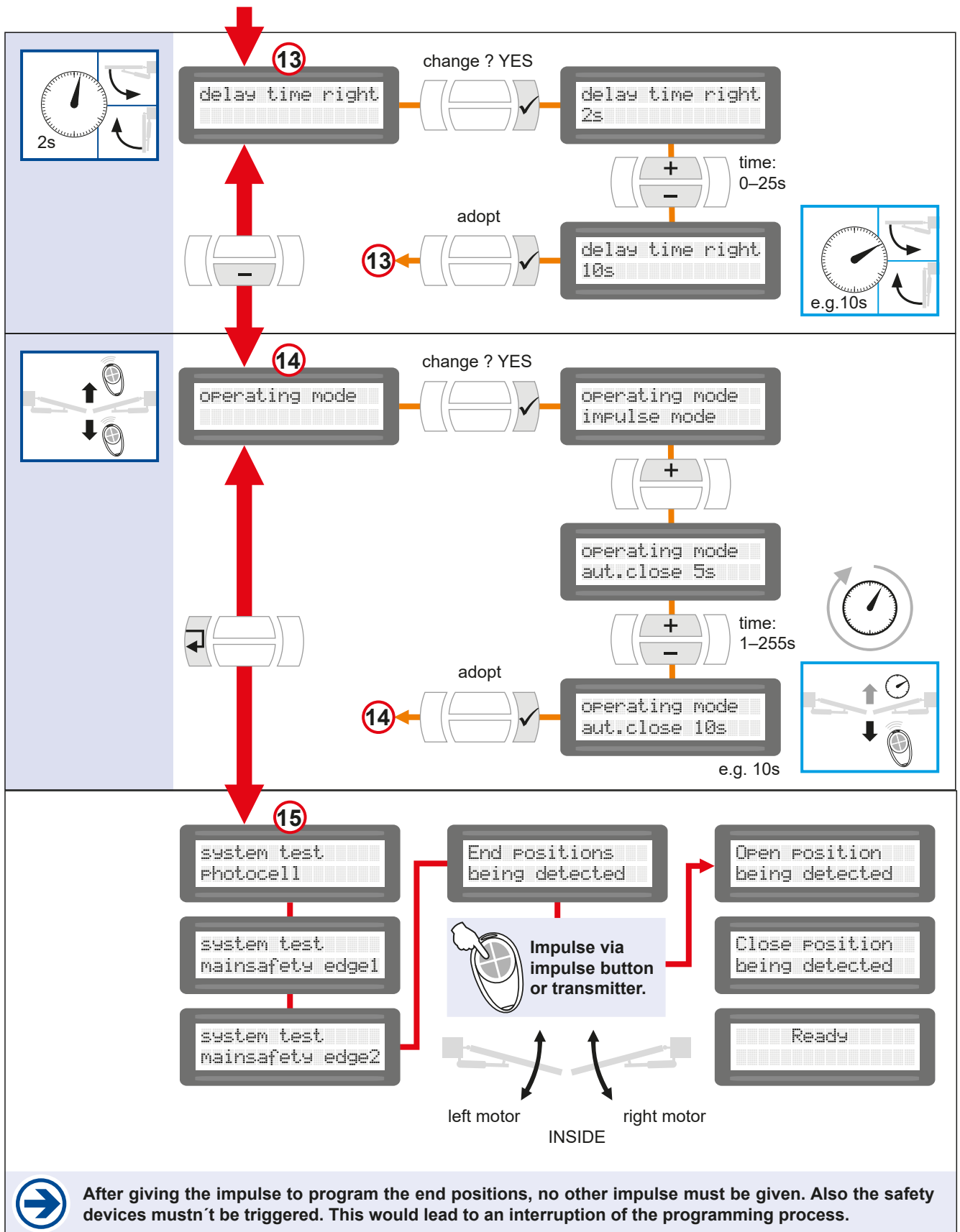

Important

- The gate installation (1 or with 2 leaves) has to reflect in the settings of the main menu !
- Factory setting: Operation of swing gate with 2 gate leaves, the left and right operator are turned on in main menu: „☉ Motor ON“.
- **IMPORTANT:** With 1 leaf gate installation, only the operator of the actually existing gate leaf must be activated in the main menu, the other one has to be disabled (deactivated) !
(In Main Menu: Left(Right) leaf / Motor / „Motor OFF“)

Error	possible reason	solution
no reaction after emitting a command	mains voltage missing or fuse F1 defective	control of mains voltage as well as of fuse F1
	Display: error stop button	check if stop button is properly connected or bridged
control relays switch but motor does not run	connection between motor and control defective	check supply lines
gate opens but does not close	photocell interrupted	check positioning and functions of photocells
	AR system actuated	check force and sensor adjustment
safety sensing edge 1 or 2 actuated	adjustment of safety sensing edges wrong	remove obstacle or function control via status display
no reaction of radio receiver	radio receiver plugged into wrong connector	check proper installation <i>see 5, connection of radio receiver</i>
	no / wrong connected antenna	check antenna connection
	radio transmitter not programmed	program handheld transmitter
error message „no learned way“	sensors/motors not correctly connected or condenser not connected	check correct connection

- dimensions in mm



- Mounting dimensions (back side)

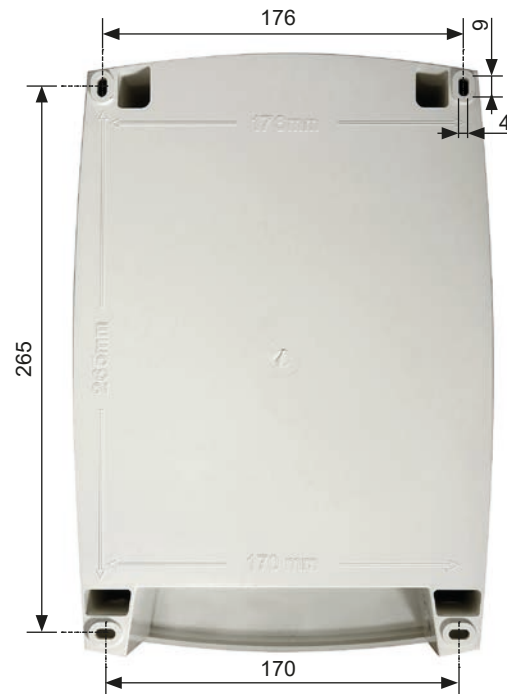

We reserve the right to change dimensions and technical specifications without prior notice !

Notes

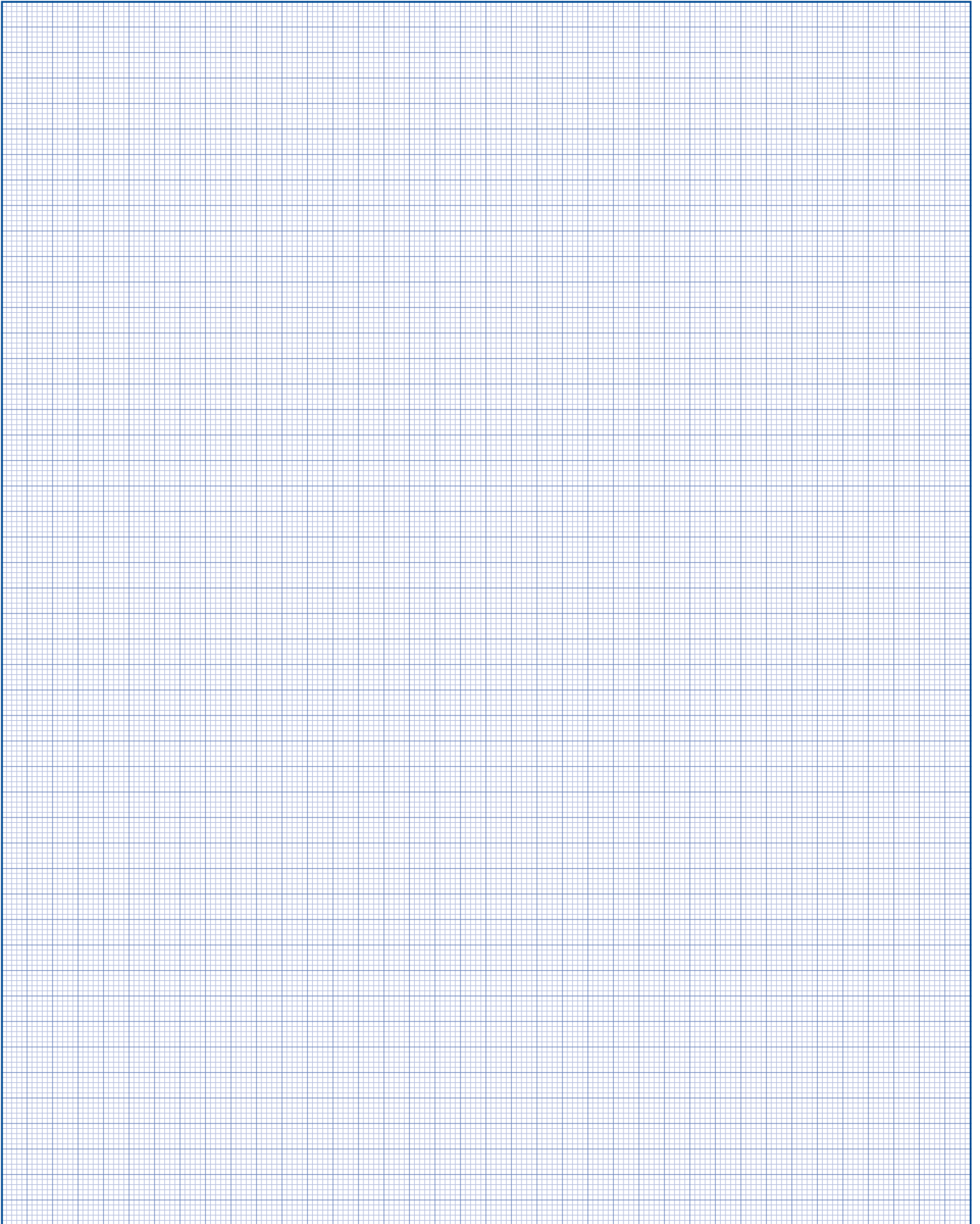

tousek PRODUCTS

- sliding gate operators
- cantilever systems
- swing gate operators
- garage door operators
- folding door operators
- traffic barriers
- electronic controls
- radio remote controls
- key operated switches
- access control
- safety devices
- accessories

Tousek Ges.m.b.H. Austria
A-1230 Vienna
Zetschegasse 1
Tel. +43/ 1/ 667 36 01
Fax +43/ 1/ 667 89 23
info@tousek.at

Tousek GmbH Germany
D-83395 Freilassing
Traunsteiner Straße 12
Tel. +49/ 8654/ 77 66-0
Fax +49/ 8654/ 57 196
info@tousek.de

Tousek Benelux NV
BE-3930 Hamont - Achel
Buitenheide 2A/ 1
Tel. +32/ 11/ 91 61 60
Fax +32/ 11/ 96 87 05
info@tousek.nl

Tousek Sp. z o.o. Poland
PL 43-190 Mikołów (k/Katowic)
Gliwicka 67
Tel. +48/ 32/ 738 53 65
Fax +48/ 32/ 738 53 66
info@tousek.pl

Tousek s.r.o. Czech Republic
CZ-252 61 Jeneč u Prahy
Průmyslová 499
Tel. +420 / 777 751 730
info@tousek.cz

tousek
E_ST61_07
06. 06. 2019



your service partner:

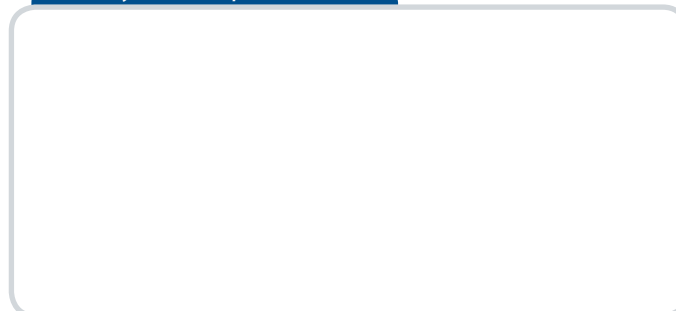

We reserve the right to change dimensions and/or technical specifications without prior notice. Claims resulting from misprints or errors cannot be accepted.

