

Installation and operating manual

Barrier PASS 838



tousek[®]
G A T E A U T O M A T I O N





Important warning and safety notes for installation and operation

- These installation- and operating instructions form an integral part of this product. They have been specifically written for professional installers trained and skilled in the trade and should be carefully read in their full length before carrying out the installation. It concerns the control only, not of the overall device "automatic gate". After the installation this manual has to be handed over to the user.
- Installation, connection, adjustments, putting into operation, and servicing may only be carried out by trained professionals in full accordance with these installation- and operating instructions.
- The EU Machine Directive, laws and rules concerning the prevention of accidents, and laws and standards which are in force in the EU and in the individual countries have to be strictly followed.
- The TOUSEK Ges.m.b.H. cannot be held liable for any claims resulting from disregards of the laws and standards in force during the installation and operation.
- The product may only be used in accordance with its original purpose, for which it has been exclusively designed, and which is described in these installation and operating instructions. The TOUSEK Ges.m.b.H. rejects any liability if the product is used in any way not fully conforming to its original purpose as stated herein.
- The product is not suitable for installation in explosion-hazardous areas. The existence of inflammable gas and steam is of great danger !
- The packaging materials (cardboard, plastic, EPS foam parts and filling material...) have to be properly disposed of in accordance with the applying recycling- and environmental protection laws. They may be hazardous to children and therefore have to be stored out of children's reach.
- Before beginning with the installation the installer has to make sure that all mechanical components of the gate facility, like carrier profile/rail, gate frame and panels, guiding elements etc. are sufficiently supportive and resistant for the purpose of gate automation. Check also whether the product has transport damages.
- All electrical installations have to be made in full conformity with the applying rules and laws (e.g. using a fault current circuit breaker, proper grounding...).
- An all-pole disconnecting main switch with a contact opening-gap of minimum 3 mm has to be foreseen.
- When installing the safety device (photocells, safety edges, emergency-stops etc.) please comply with the valid directives/standards, the criteria of practical rules of conduct, the installation environment, the operating logic of the system and the effected force of the motorised gate.
- The safety devices must secure possible bruise, shear and general danger areas of the motorised gate.
- After installation the proper function of the gate facility and the safety devices has to be checked.
- Place warning signs and notes of the valid regulations to indicate danger areas
- With each installation the identification data of the motorised gate has to be placed in a visible place.
- The electric motor heats up during operation. Therefore the device should only be touched after it has cooled off.
- Children have to be instructed, that the gate facility as well as the belonging parts may not be used improperly, e.g. for playing. Furthermore handheld transmitters have to be kept in safe places and other impulse emitters as buttons and switches have to be installed out of children's reach.
- Only original spare- and replacement parts may be used for repair of the product.
- The TOUSEK Ges.m.b.H. rejects any liability for claims resulting from usage of the product in combination with components or devices which do not fully conform to the applying safety laws and rules.
- The installer has to inform the user about all aspects of the automatic operation of the complete gate facility, as well as about emergency operation. The installer further has to supply to the user all instructions relating to the safe operation of the gate facility. The installation and operating instructions also have to be handed over to the user.
- The user has to be informed that he has to turn off the main power switch in case of malfunction of the product and that he can use the facility again after repair and adjustment works have been completed.
- **Please notice that the warranty will not be applicable if the label with the engine number has been removed or damaged.**



Maintenance

- **Maintenance works have to be carried out according to our maintenance plan (page12).**

Characteristics

- electromechanical barrier operator for barrier width 3m to 6m
- for 230 V a.c. power supply
- suitable for continuous operation (100% duty cycle)
- emergency release mechanism
- sinusoidal motion
- technology without limit switches
- speed sensor
- red finished (RAL3000) sheet steel housing optional in INOX
- integrated control board ST 80 with clear text menu through large, illuminated LCD screen
- adjustable soft stop
- ARS Automatic Reversal System
- integrated safety edge resistance evaluator 8,2 kΩ for lower boom edge
- output for boom magnetic clamp and boom lamp with free definable light/blinking function



General features

The barrier operators work electro-mechanically and are available with aluminium barrier booms (length of 3–6m depending on type). The barrier booms are painted white and have red reflective stickers. The drive unit basically consists of a mechanical gearing combined with a 230V electric motor, a balancing spring and a speed sensor.

All components are built into a robust red finished (on request also silver finished resp. in INOX), lockable steel housing. In case of a power failure the barrier boom can be opened and closed manually after loosening the emergency release hand wheel. Due to its particularly massive execution and the very short opening and closing times, the Tousek PASS 838 barrier operator has been designed to handle a large number of opening/closing cycles per day.

Optional accessories: base plate for barrier operator, (barrier boom) tip rest, base plate for (barrier boom) tip rest., pluggable radio receiver (tousek STN), pluggable induction loop detector (ISD 6) and barrier boom grid.

Technical Data

Barrier PASS-	838V-ST	838 L3-ST80	838 L4-ST80	838 L6-ST80
max. barrier width	3m		4,5m	6m
Opening-, closing time	1,5s	7s		
Motor power supply	230Va.c.			
Power consumption	400W			
Duty cycle (mode S1)	100%			
Max. cycles/day	2000	1000	500	
Ambient temperature	-20°C to +40°C			
Condenser	14µF			
Boom configuration	flat - (H x B) 116mm (with rubber profile) x 30mm			round - Ø 85mm
Integrated control ST 80	ST 80V	ST 80	ST 80	ST 80
Art.No.	11530360	11530330	11530340	11530350

possible equipment:

Boom	■	■	■	■
LED boom lamp	■	■	■	■
Pendulum arm or tip rest	only tip rest	■	■	■
Barrier boom grid		■	■	

Other

all barrier operators PASS 838 are equipped with an emergency operation hand wheel
Housing colour: red



Note: The mentioned values „max. cycles per day“ require regular maintenance work according to our specifications (depending on intensity of operation between 1 and 4 times per year)
The barrier PASS 838V-ST is only for vehicle traffic !

- (1) housing door
- (2) gearing lever
- (3) chain
- (4) gearing lever
- (5) balancing spring
- (6) euro standard lock cylinder
- (7) earthing bolt
- (8) activator bolt for door switch
- (9) door safety switch
- (10) drive shaft
- (11) Limit bolt „boom OPEN“
- (12) Limit bolt „boom CLOSED“
- (13) emergency release
- (14) reduction gearing
- (15) drive motor
- (16) electronic control with LC-Display menu programming (16a)

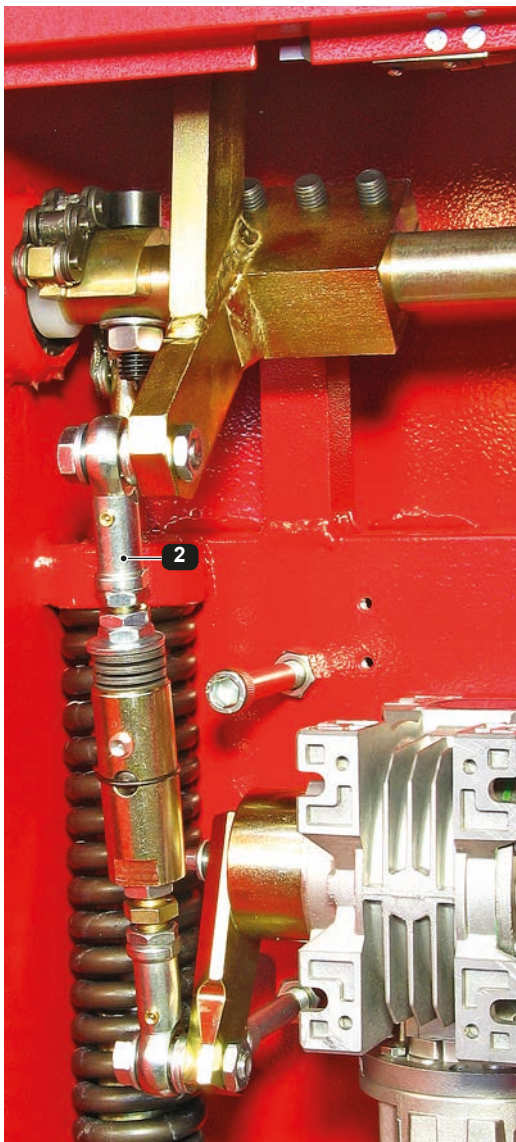

Barrier in position „CLOSED“

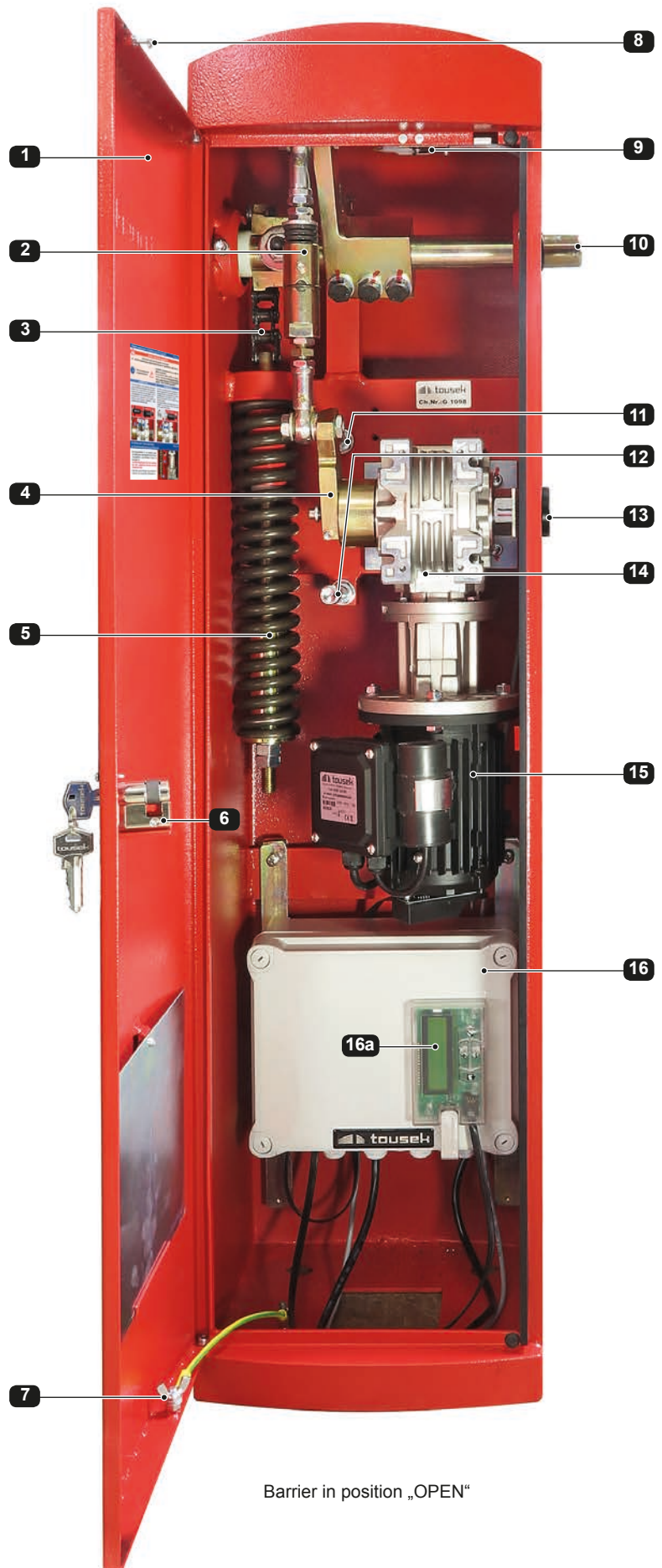

Barrier in position „OPEN“

3a. Mounting of base plate and barrier operator

- Lead the insulating sleeves (**S**) for power supply and accessories into the opening of the base plate.
- Embed the base plate firmly and horizontally in the foundation (**F**) (see „examples - Barrier installations“ page 13).
- Set the operator housing on the base plate with the door (**T**) aligned to the road (**FB**) and secure it with the bolts. Therefore it has to be ensured that the connecting cables won't be damaged.

Installation

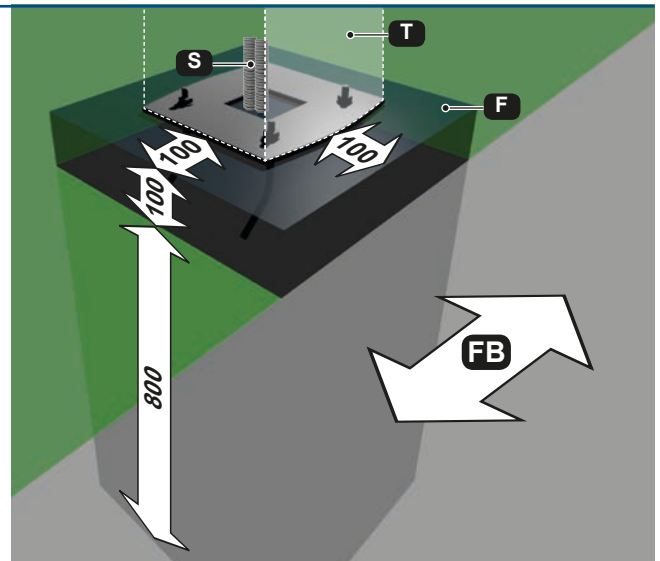

Foundation

- The foundations to be made must be at least **100mm** larger around then the foundation plates concerned.
- The foundation must be raised from the ground level to a minimum of **100mm**.
- The foundation depth from ground level to should have a **minimum of 800mm** (frost resistant).
- The foundation always has to be adjusted to the structure of the ground.

It should consist of concrete quality C20/25 at ground class 3. The foundation has to be horizontal and free of cracks.

- When using a support fork/tip rest pay attention to the offset **V**, which depends on the barrier used (barrier boom):

For barriers with flat boom: V = 190

For barrier type PASS 838 L6 (= barrier with round boom): V = 220

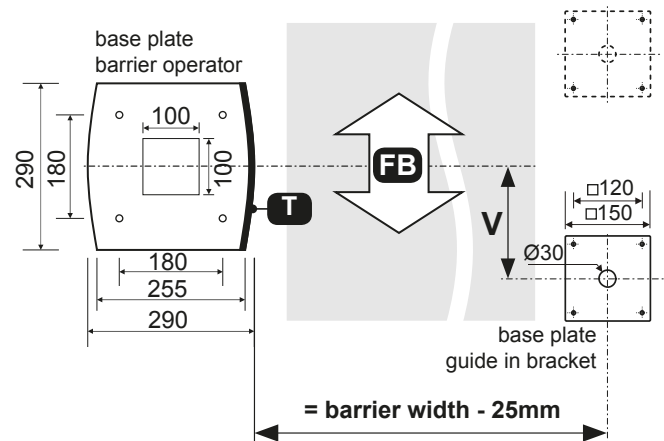

3b. Mounting the barrier boom

Installation



Important

- The barrier boom can be installed either on the left or on the right side of the operator housing.
- Please do not load additional weight (e.g. sign boards) on the barrier boom. This could result in the damage of the gearbox unit.



Important - grease the drive shaft

- put some grease onto the external drive shaft with provided grease!
(see picture))

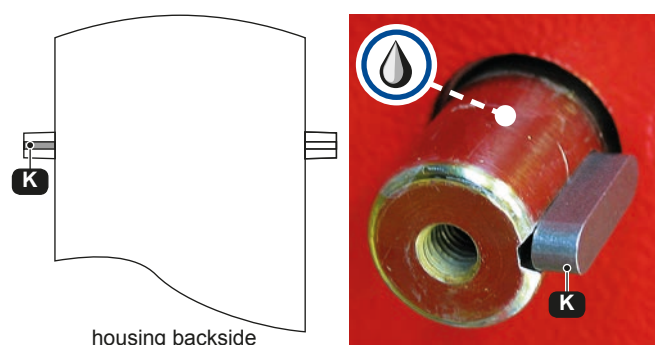

- In a first step knock in a metall key (**K**) into the nut of the gearing drive shaft on the side of the barrier where you wish to mount the boom.
- The following mounting steps differ in accordance of whether you wish to mount the round or the flat barrier boom.

Fixing the flat boom (example as left barrier)

- 1 Push the barrier boom carrier (M) onto the drive shaft (A), so that the knocked-in metal key drives into the nut (M.N).
- 2 Now slide the slide-in module (E) as shown into the boom so that the drillings fall in line with the boom.
- 3 Then bolt 4 x (with discs) the boom carrier (M) with the slide-in module inside boom (E).
- 4 Now connect the boom (B) with cylinder head bolt (M10 x 40) and disc with drive shaft (A) (close the opening of boom with plastic plug)
- 5 Attach the plastic covers onto the boom and drive shaft end.

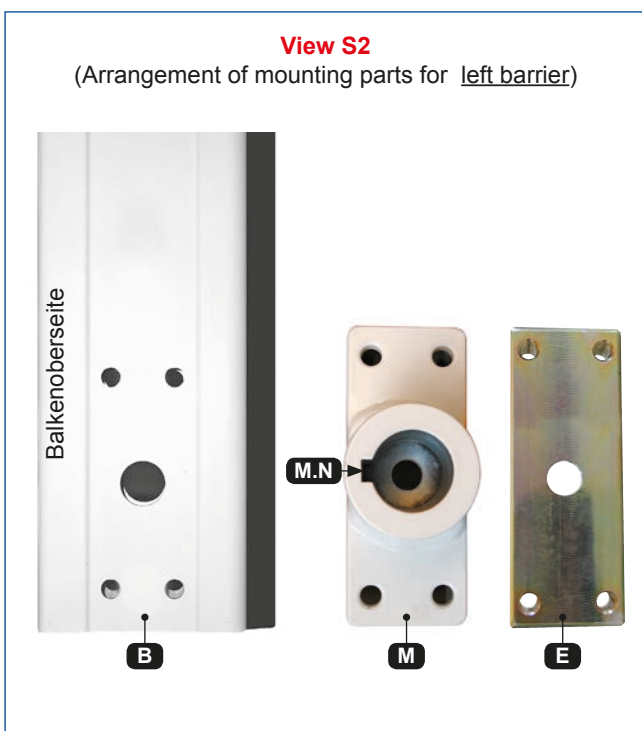
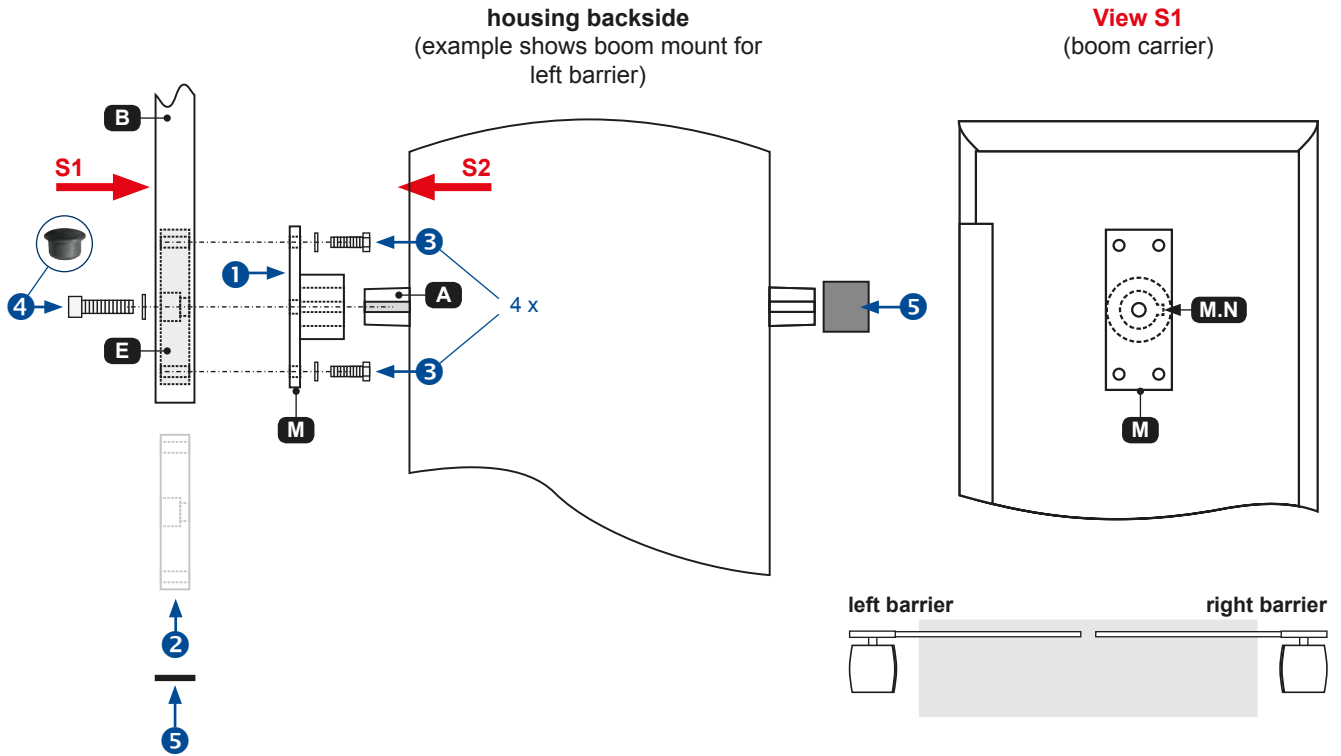

Important

- make sure to slide the slide in module (E) for both mounting types (left/right) into the boom so that the dropping (E.S) for the cylinder head bolt turns away from barrier housing.

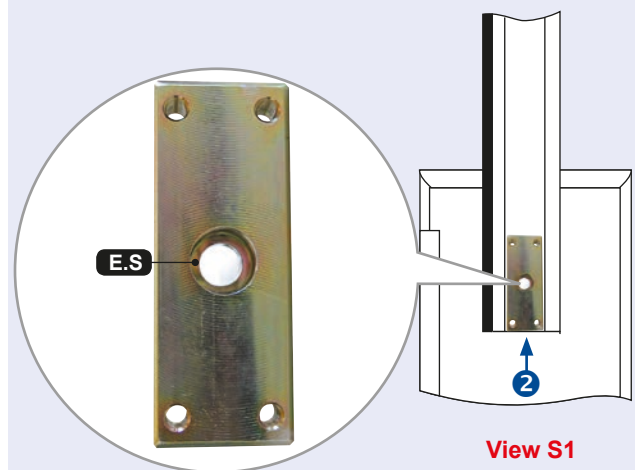

Attachment of round barrier boom (example as left barrier)

- 1 Push the barrier boom carrier (M) onto the drive shaft (A), so that the knocked-in metal key drives into the nut (M.N).
- 2 Now slide the slide-in module (E) as shown into the boom so that the drillings fall in line with the boom.
- 3 Then bolt 4 x (with discs) the boom carrier (M) with the slide-in module inside boom (E).
- 4 Now connect the boom (B) with cylinder head bolt (M10 x 40) and disc with drive shaft (A) (close the opening of boom with plastic plugs)
- 5 Attach the plastic covers onto the boom and drive shaft end.

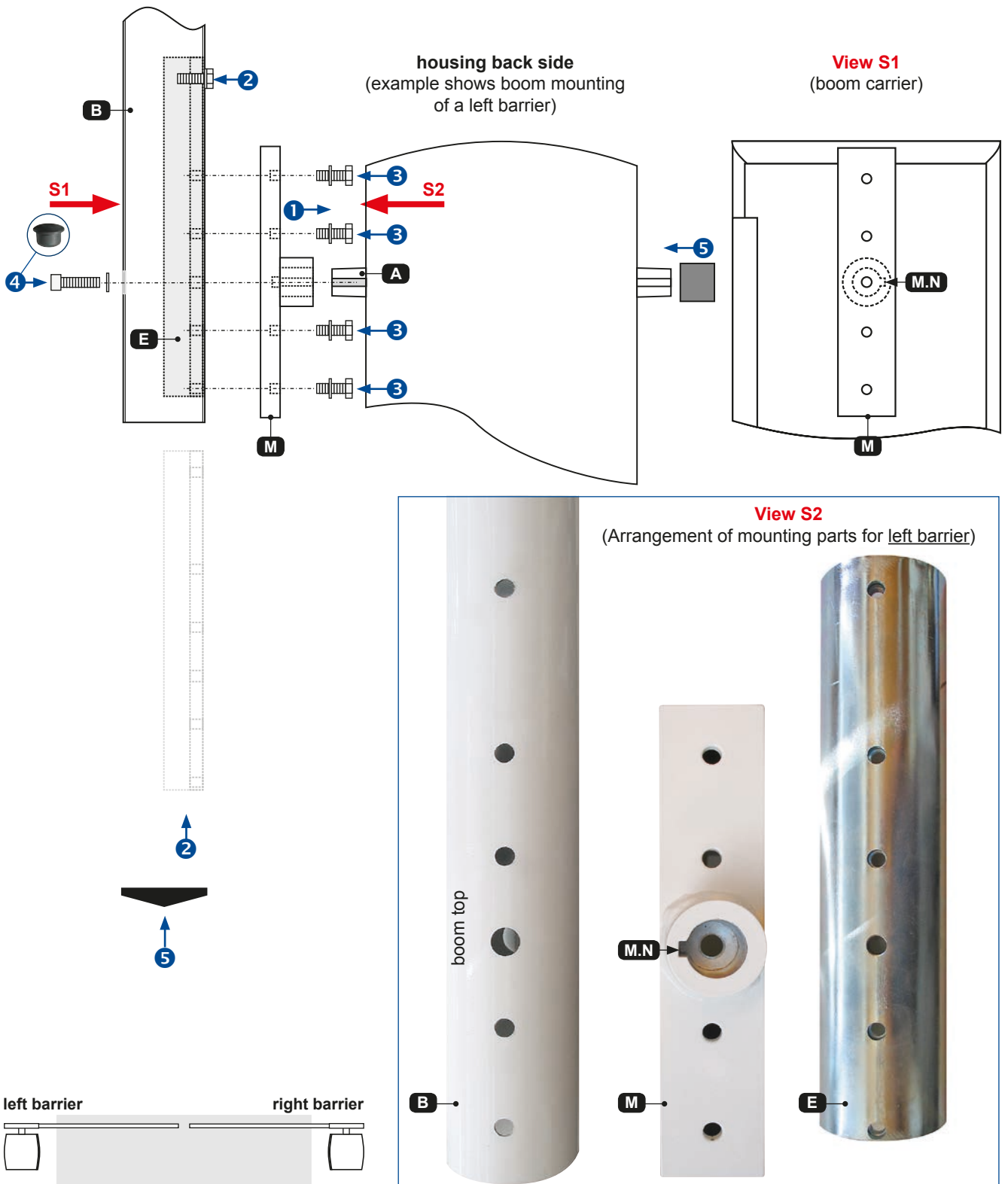



Warning

- Before carrying out the electrical connections, the power supply of the gate facility must be turned off !
- The safety regulations for electric shock prevention have to be complied.
- The device should only be connected by qualified personnel
- The device should not be used in an explosive environment !
- An all-pole disconnecting mains switch with a contact opening gap of min. 3 mm has to be foreseen. The gate facility has to be secured according to the valid safety regulations!
- **IMPORTANT:** The control lines (buttons, radio, photocells, etc.) have to be laid separately from the 230V lines (supply line, motors, signal lamp). and may have a max. length of 50m. For length > 50m decoupling steps are necessary !



- Before carrying out the electrical connections, the power supply of the gate facility must be turned off !
- Connect the operator to the control unit according corresponding control manual (mind the beside installation notes).
- For the connection of diverse safety devices, transmitters and other accessories please check the corresponding manuals (please note cable/wire plan).



Important installation notes

- Attention: The operator works with the condenser mounted on the motor. Therefore don't connect an additional condenser to the control unit.
- The operator housing is equipped with a safety switch (S) which stops the motor as soon as the housing lid is opened. This safety switch must be connected to the motor control unit (input for STOP switch).

3d. Adjustment of spring tension

- The adjustment of spring tension is made by turning the screw nut (M) on the spring rod.



Important

- The spring (F) has to be adjusted so that the boom can be moved easily by hand in emergency release state. (with pendulum arm and/or boom grid). The boom should have a position of approx. 20–40°.

3e. Force adjustment

- The force adjustment is made by the ST80 control board.
- Due to the spring balance, the operator force is measured in a way, that the barrier boom may be stopped with little effort.
- As an additional safety device we recommend the connection of a photocell.



Warning

- The safety standards and regulations regarding the force adjustment have to be in compliance with the effective rules !



3f. Adjusting the limits

- The barrier operator is equipped with two adjustable limit stop bolts, one for **OPEN (AO)** and one for **CLOSED (AG) position**.
- The gearing lever (**G**) is being defined in its turning movement by these two limit stop bolts in the end positions open and close. The integrated speed sensor registers when it reaches one of the limits, whereupon the control board turns off the motor.
- The switching time and also the boom limit positions can be defined by bolting in or out the limit stop bolts.



Note

- Please note that when the limit stop bolts are being adjusted (AO or AG) the limit positions are being learned in.
- Choose in control board menu of ST 80 under „DIAGNOSIS / delete position“ the value „YES“ .

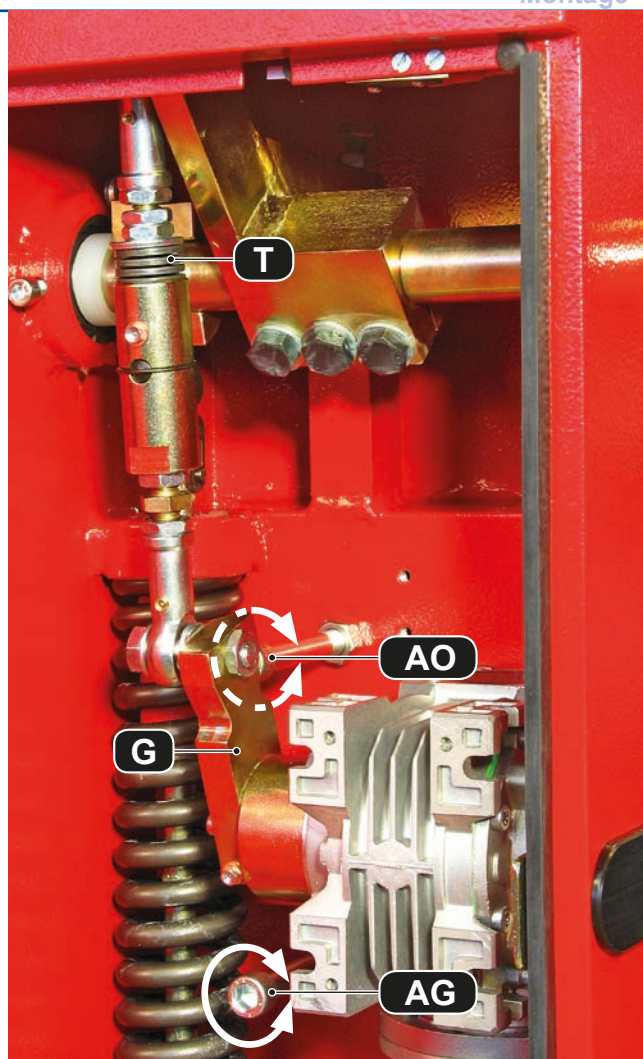

IMPORTANT

- The end position of the barrier must take place according to the above services mentioned above description.
- Never use a support fork or pendulum support as a limit. These serve only to discharge of the bar!
- The company Tousek Ges.m.b.H. accepts no liability for damages resulting from such a misuse!



Acute risk of injury

The operator may only be emergency released if:
 >>> **the power supply is turned off and >>> the barrier boom is mounted**



- Turn off power supply of gate facility!



- **ATTENTION: Make sure that the barrier boom is mounted!**
- If the barrier boom is removed, there is no counterweight to the spring tension. **In this case the operator may not be emergency released since this could lead to SERIOUS INJURIES !**

RELEASE

- Open the housing door and slide the cover of the emergency release in direction of front part of housing.
- Insert the 10mm Allan Key and turn it 2–3 times counter clockwise. This disengages the gear lever (G) from the gearing transmission.
- The operator is now unlocked and the boom may be moved manually (**slowly ! - not faster than with the operator**).

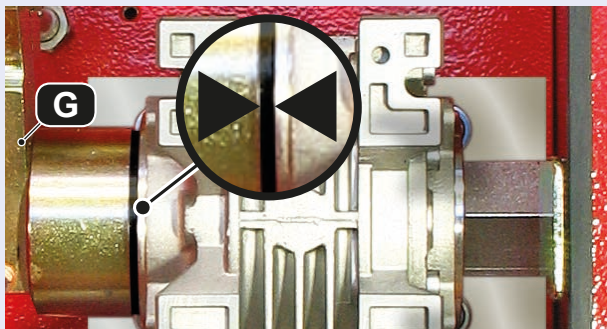
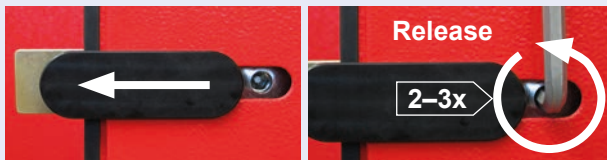

LOCKING

- To restore operation of the motor pull the emergency release clockwise again firmly. Move the boom a little so that the lever gear snaps into the gearing.
- The lever gear (G) must rest again directly on the gearing unit.
- After closing the housing door and turning on the power supply, the motorised mode can be engaged again.

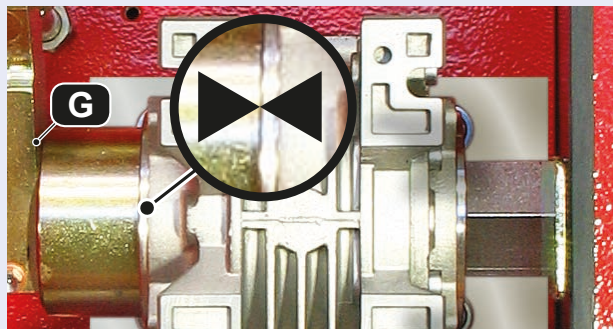

5. **Attachment of warning signs**

- Additionally to the safety installations of the barrier as suggested by safety instructions in effect, some warning signs have to be installed to warn pedestrians, bicycle drivers etc. showing special attention and informing of possible danger and for guidance to an alternative route.





7. Maintenance plan for barrier PASS 838

Maintenance works may only be carried out by trained professionals.

ATTENTION: Before carrying out maintenance works, turn off the power supply.

According to the frequency of actuation the following works have to be carried out 1–4 times a year:



- Check the correct fixing of the barrier housing.
- Check the balancing spring, adjust if necessary.
- Grease the guiding rod of the balancing spring.
- Grease the grease nipples (**N1–N4**) with the grease press.
- Check and adjust the end positions opened and closed.
- Check the proper function of the emergency release.
- Check the proper function of the housing lid safety switch.
- Check the gearing on tightness.
- Check if the assembly bolts of the gearing are properly secured.
- Check barrier boom support: - proper seat of support at the main shaft
- proper seat of the 4 internal assembly bolts
- Optical inspection of ball bearings of main shaft.
- Check force adjustment of control unit.
- Check all safety devices and accessories.
- **Equalising spring (W1), chain hoist device (W2) disc spring (w3) and fastening bolt M14 (W4) have to renewed every 200.000 cycles (latest every 3 years) !**

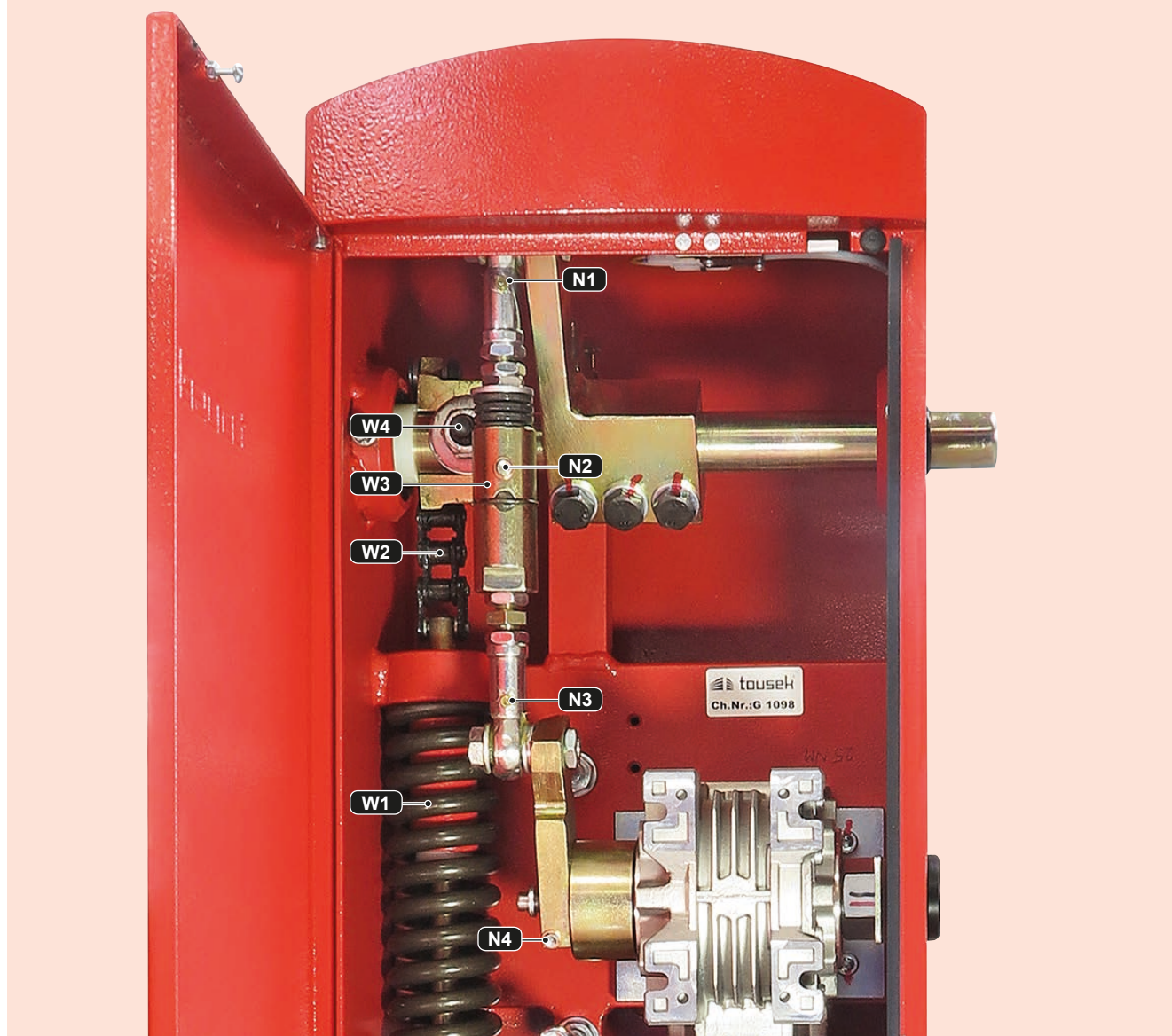

• Dimensions in mm

Single barrier with support fork and photocell pillars



Important

- The foundations to be made must be at least **100mm** larger around then the foundation plates concerned.
- The foundation must be raised from the ground level to a minimum of **100mm**.
- The foundation depth from ground level to should have a **minimum of 800mm** (frost resistant).
- The foundation always has to be adjusted to the structure of the ground.

It should consist of concrete quality C20/25 at ground class 3. The foundation has to be horizontal and free of cracks.

- When using a support fork/tip rest pay attention to the offset **V**, which depends on the barrier used (barrier boom):

For barriers with flat boom: V = 190

For barrier type PASS 838 L6 (= barrier with round boom): V = 220

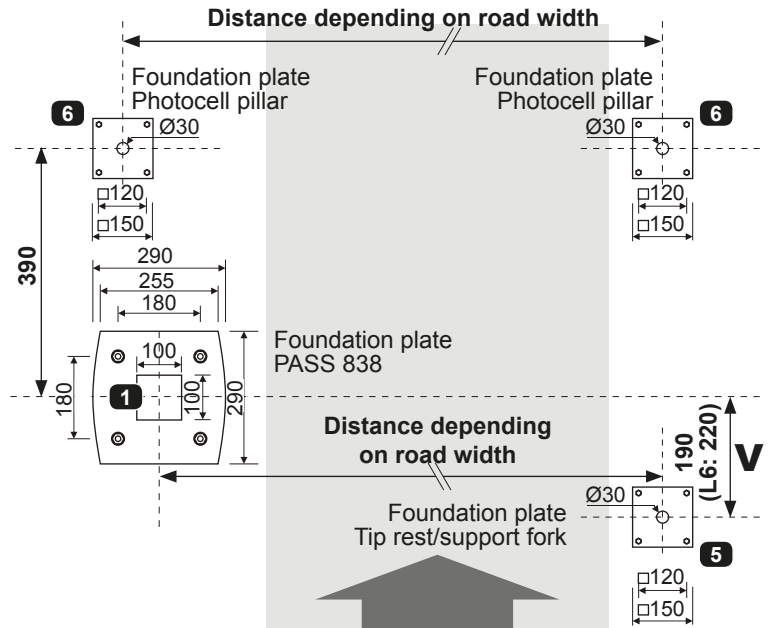

Barrier system for separate entrance / exit with impulse columns V03

- (1) Barriers PASS 838
- (2) Impulse columns
- (3) Photocells
- (4) Induction loops
- (5) Tip rests/support forks
- (6) Photocell pillars

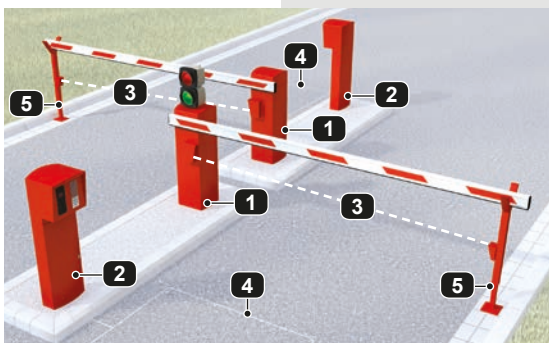
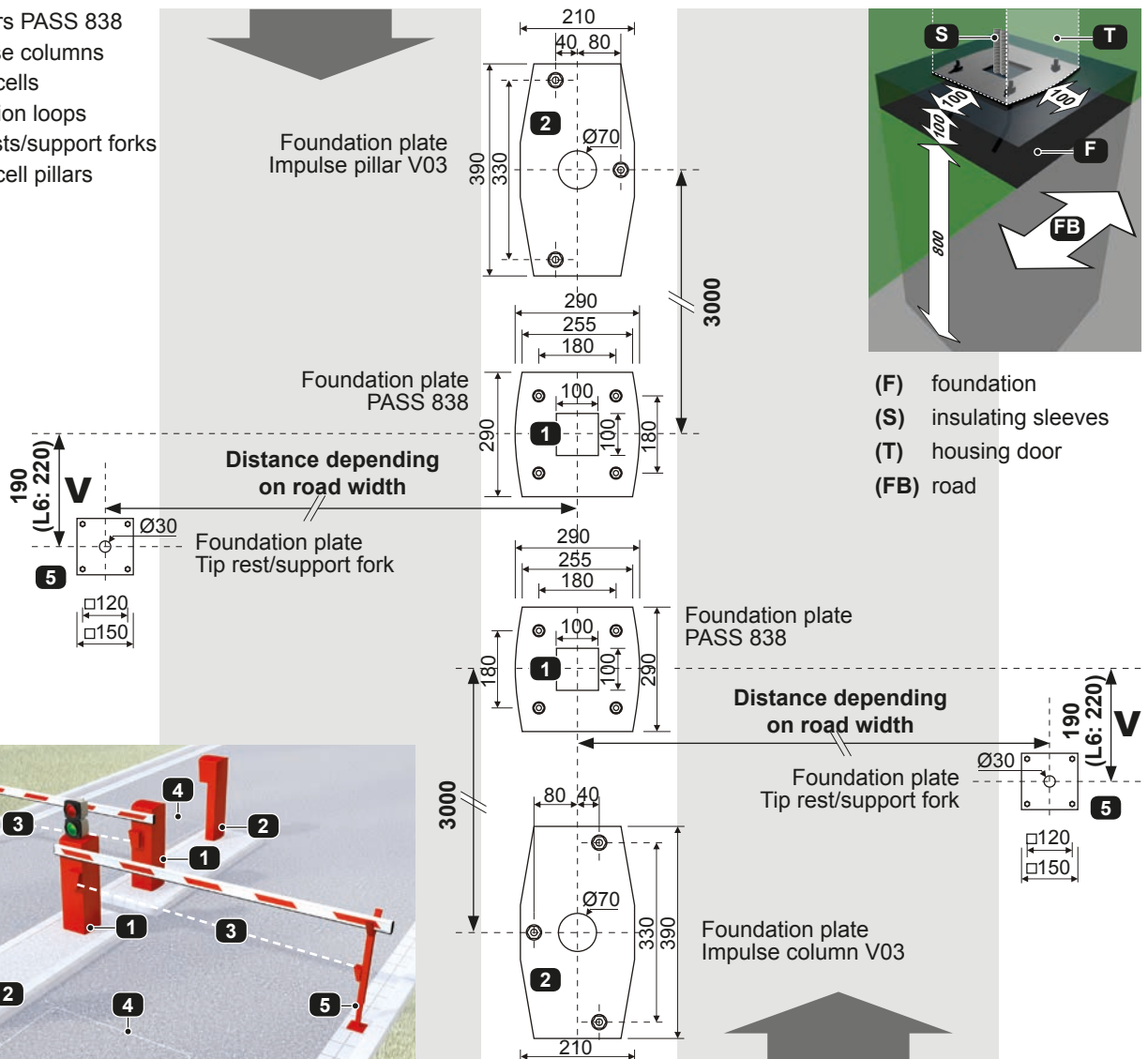

9. Dimensioned drawing

Barrier PASS 838

- dimensions in mm

NOTE	838V-ST	838 L3-ST80	838 L4-ST80	838 L6-ST80
max. barrier width	3m		4,5m	6m
boom length	barrier width + 220mm			barrier width + 280mm
Boom configuration	flat - (h x w) 116mm (with rubber profile) x 30mm			round - Ø 85mm

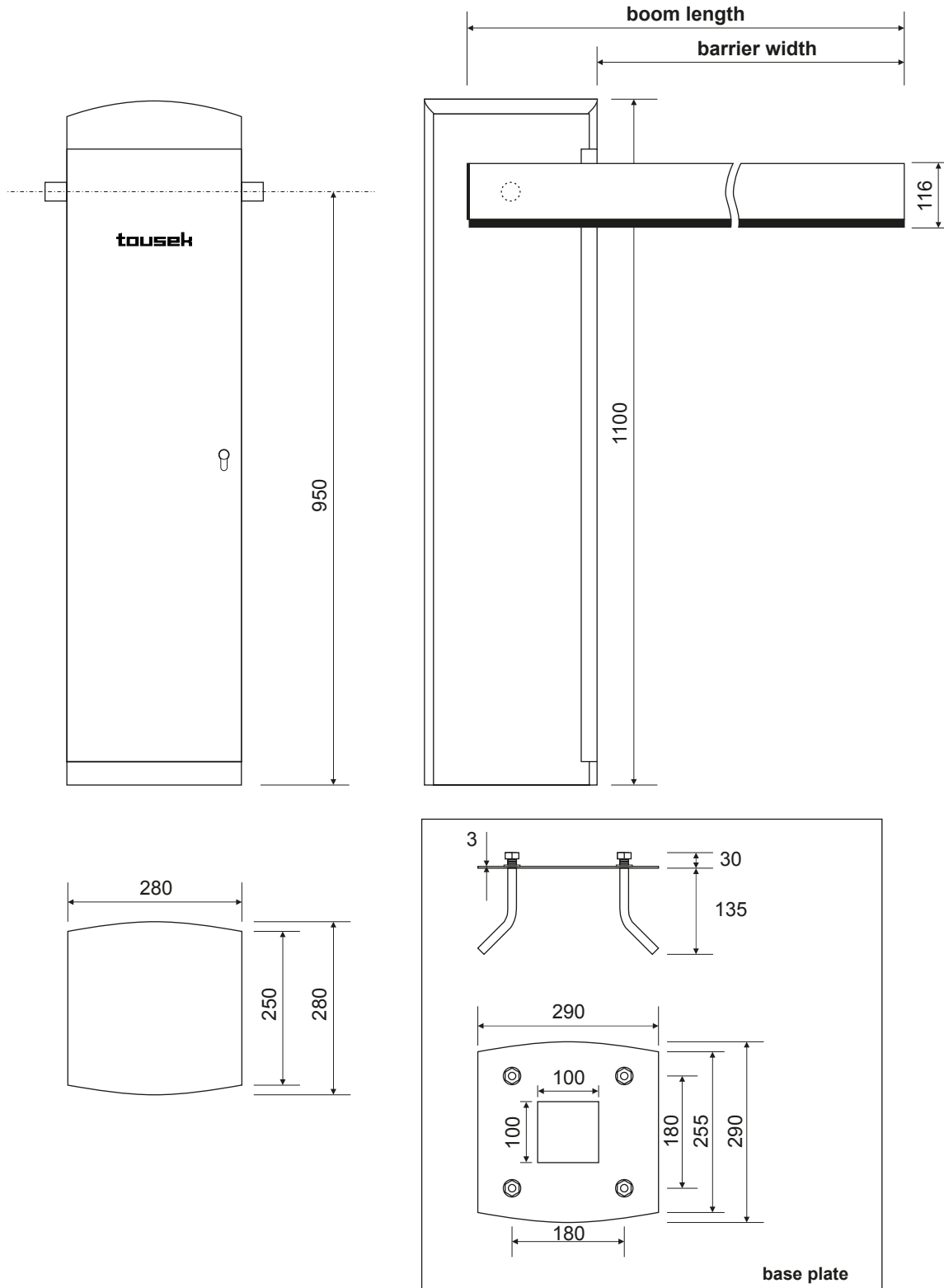

measures and technical modifications subject to change !



Declaration of incorporation

In compliance with EC Machine Directive 2006/42/EC, Annex II B for the installation of an incomplete machine.

We hereby declare that the following product, as well as its version, put by us into circulation, complies with the essential requirements of the Machinery Directive (2006/42/EC), due to its design and type of construction.

The validity of this declaration will cease in case of any unauthorized modifications to the products.

The product:

Barrier operator PASS-838V, -838L3, -838L4, -838L6

is developed, designed and manufactured in accordance with:

EG-Directive Machinery 2006/42/EG
EG-Directive Low Voltage 2014/35/EU
EG-Directive Electromagnetic compatibility 2014/30/EU

Applied and used standards and specifications:

EN ISO 13849-1, PL-,c“
EN 60335-1
EN 60335-2/95
EN 61000-6-3
EN 61000-6-2

Following requirements of Annex I of the EC Directive 2006/42/EC are met:

1.1.2, 1.1.3, 1.1.5, 1.2.1, 1.2.2, 1.2.3, 1.2.6, 1.3.2, 1.3.4, 1.3.7, 1.5.1, 1.5.4, 1.5.6, 1.5.8, 1.7

The relevant technical documentation is compiled in accordance with Annex VII, Part B of the EC Machinery Directive 2006/42/EC.

We undertake to submit it in electronic form and within a reasonable time to the market surveillance authorities in response to a duly substantiated request.

TOUSEK Ges.m.b.H., A1230 Wien, Zetschegasse 1, Österreich

is authorized to compile the technical documentation.

The incomplete machine cannot be put into service, until it is determined that the machine, into which the incomplete machine has to be inserted, complies with the the Machine Directive 2006/42/EC.

Eduard Tousek, CEO

Vienna, 01. 01. 2013

EC Declaration of Conformity

In compliance with EC Machine Directive 2006/42/EC, Annex II, Part 1 A.

When the described operators are connected to a barrier system they form a machine in the sense of the EC Machine Directive.

Relevant EU directives:

Construction Products Directive 89/106/EWG
Machinery Directive 2006/42/EG
Low Voltage directive 2014/35/EU
Electromagnetic compatibility 2014/30/EU

We hereby declare that the following product, in the version put by us into circulation, complies with the essential requirements of the Directives mentioned above. The validity of this declaration will cease in case of any unauthorized modifications to the products.

Product:

Motor description

Barrier width

The incomplete machine cannot be put into service, until it is determined that the machine, into which the incomplete machine has to be inserted, complies with the the Machine Directive 2006/42/EC.

Installation company

Address, ZIP code, Place

Date/ Signature

Motor number (Type plate): _____

Other components:

tousek PRODUCTS

- sliding gate operators
- cantilever systems
- swing gate operators
- garage door operators
- folding door operators
- traffic barriers
- electronic controls
- radio remote controls
- key operated switches
- access control
- safety devices
- accessories

Tousek Ges.m.b.H. Austria
A-1230 Vienna
Zetschegasse 1
Tel. +43/ 1/ 667 36 01
Fax +43/ 1/ 667 89 23
info@tousek.at

Tousek GmbH Germany
D-83395 Freilassing
Traunsteiner Straße 12
Tel. +49/ 8654/ 77 66-0
Fax +49/ 8654/ 57 196
info@tousek.de

Tousek Benelux NV
BE-3930 Hamont - Achel
Buitenheide 2A/ 1
Tel. +32/ 11/ 91 61 60
Fax +32/ 11/ 96 87 05
info@tousek.nl

Tousek Sp. z o.o. Poland
PL 43-190 Mikołów (k/Katowic)
Gliwicka 67
Tel. +48/ 32/ 738 53 65
Fax +48/ 32/ 738 53 66
info@tousek.pl

Tousek s.r.o. Czech Republic
CZ-130 00 Praha 3
Jagellonská 9
Tel. +420/ 2/ 2209 0980
Fax +420/ 2/ 2209 0989
info@tousek.cz

tousek
E_PASS-838_02
22. 10. 2018



your service partner:

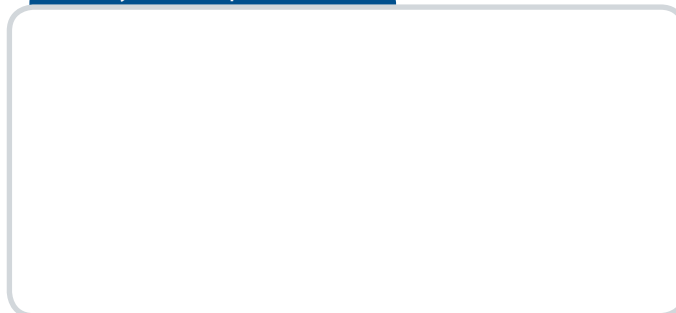

We reserve the right to change dimensions and/or technical specifications without prior notice. Claims resulting from misprints or errors cannot be accepted.

