

FUJITSU

AUSTRALIA'S FAVOURITE AIR™

# AIR CONDITIONING RANGE

WALL MOUNTED - DESIGNER RANGE

WALL MOUNTED - COOLING ONLY

WALL MOUNTED - REVERSE CYCLE

CASSETTE

CEILING & FLOOR CONSOLE

MULTI SYSTEMS



# Fujitsu leads the way

Fujitsu leads the way in design and technology with its most exciting range of innovative air conditioners.

With a choice of individual and advanced systems in a variety of configurations, Fujitsu can provide the perfect solution for any environment.

Whether it's heating or cooling, come home to Fujitsu comfort.

## Features



### Up/Down Swing Louvre

The up/down louvre automatically swings up and down.



### Right/Left Swing Louvre

The right/left louvre automatically swings in either direction.



### Double Swing Automatic

Complex swing action of the louvres enables them to swing automatically in both horizontal and vertical directions.



### Automatic Louvre

The position of the louvres is set automatically to match the operating mode. It is also possible to adjust the louvres using the remote control.



### Auto Shut Louvre

The auto shut louvres close or open automatically when the unit stops or starts.



### Automatic Air Flow Adjustment

The micro-processor automatically adjusts the air flow to follow changes in room temperature.



### Auto Restart

Should there be a temporary loss of power, the unit will automatically restart itself in the same operating mode, once the power is restored.



### Auto-Changeover

The unit automatically switches between operating modes based on the set point temperature and room temperature.



### Blue Fin Heat Exchanger

Corrosion-resistance of the heat exchanger in coastal areas has been improved by blue fin treatment of the outdoor unit heat exchanger.



### All DC

With All DC, electricity loss is decreased and power consumption reduced.



### V-PAM

V-Pam Inverter technology increases the maximum output of the compressor significantly and enables high power and high efficiency. For details, see page 5.



### I-PAM

I-Pam inverter technology enables high output and high efficiency performance. For details, see page 5.



### Sleep Timer

The micro-processor gradually changes the room temperature, allowing you to sleep comfortably at night.



### Program Timer

This timer allows selection of one of four options. ON, OFF, ON ---> OFF, or OFF --> ON.



### ON-OFF Timer

ON-OFF timer can be set to operate once every 24 hours.



### Weekly Timer

Different on-off times can be set for up to 7 days.



### Weekly + Setback Timer

Weekly + Setback timer can set temperature for two time spans and for each day of the week.



### Washable Panel



### Connectable Distributing Duct

Conditioned air can be distributed to adjacent areas by means of a distribution duct.



### Connectable Fresh Air Duct

Allows introduction of fresh air to occupied space.



### Fresh Air Intake

Fresh air can be taken in by a fan which can be connected using UTD-ECSSA\* (optional parts).



### Long-life Ion Deodorisation Filter

For details, see page 11.



### Apple-catechin Filter

For details, see page 11.



### Air Clean Filter

For details, see page 12.



### Powerful Mode

Powerful mode will operate the indoor unit fan and outdoor unit compressor at maximum operation to quickly make the room conditioned and comfortable.



### Human Sensor

Human sensor detects movement of people within the conditioned room.



### Product Design Award

For details, see page 6



### Good Design Award

For details, see page 6



### Coil Dry

After the power is turned off, the dry operation starts inside the air conditioner. This prevents the growth of mold and bacteria inside the air conditioner.



### Cooling



### Heating

“If you’re looking for an air conditioner that you can trust to keep you comfortable year round, my advice is to look no further than a Fujitsu.

They are efficient, effective, and beautifully designed, I should know, I bought one myself.

So for an air conditioner you can trust, go with the name you know, Fujitsu, it’s Australia’s favourite air.”



# CONTENTS

ABOUT AIR CONDITIONING	4
INVERTER TECHNOLOGY	5
WALL MOUNTED – DESIGNER RANGE	6
WALL MOUNTED – COOLING ONLY	10
WALL MOUNTED REVERSE CYCLE	12
CASSETTE	16
CEILING & FLOOR CONSOLE	18
MULTI SYSTEMS	20



# ABOUT AIR CONDITIONING

## What is an air conditioner?

An air conditioner is designed to provide comfort within your home regardless of the weather or season. Air conditioners use the principles of heat transfer where they absorb and transfer heat to keep you comfortable all year round. In summer when running on cooling mode, heat is removed from the indoor environment and transferred to the outdoor unit where it is expelled outside. This is why you will feel hot air coming from the outdoor unit in summer. This leaves your room cooler and more comfortable on those hot summer days.

### Cool vs reverse

Fujitsu air conditioners are great for keeping you cool in summer, but did you know they are also one of the most cost effective ways of warming your home in winter? Unlike other traditional heaters, they can warm your home faster and more efficiently. In winter when running on heating mode the process is “reversed”. Reverse cycle air conditioners absorb heat from the outside, and transfers that heat to the indoor environment keeping you warm in winter. Fujitsu air conditioners are designed to cool or heat your home even in the most extreme conditions. This makes a Fujitsu air conditioner the perfect comfort solution, all year around.



### Split System vs Multi System

Split System air conditioners are designed to conveniently and efficiently cool or heat a single room. For situations where more than a single room needs cooling or heating, Fujitsu has a range of Multi Systems designed to air condition 2, 3 or 4 areas in your home. They allow for individual control of each indoor unit, with the ease and simplicity of having only one outdoor unit running them all.



### What to consider when purchasing an air conditioner

Buying an air conditioner can be confusing and buying the biggest unit is not always the best idea. If the unit is too big for the room, it will use extra energy and will turn itself on and off too often. On the other hand, if the unit is too small, it will not be able to handle the amount of work it needs to do. The following are a few things to consider when thinking about your next Fujitsu air conditioner:

- Do I need cooling only or heating as well?
- What is the size of the area that I want to air condition?
- Are my ceilings and walls insulated?
- What direction do my windows face?

To find the most economical Fujitsu Air Conditioner for your room visit the Economatch page of the Fujitsu General website, or talk your local Fujitsu General stockist for more options.





# INVERTER TECHNOLOGY

## What is an inverter?

Through new, advanced technology, inverter air conditioners are more economical to operate and quieter to run than conventional units. They can handle greater extremes in temperature, are smoother and more stable in operation and reach the desired temperature more quickly than conventional air conditioners.

Room warming speed

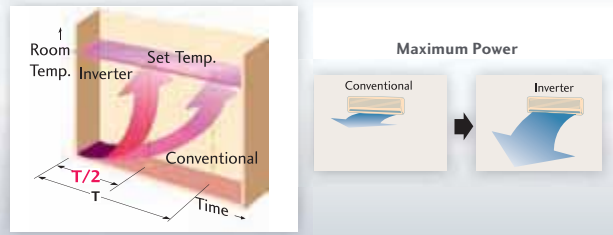

## Inverter control

The Inverter component allows the outdoor unit to vary its speed and output to match the required capacity of the indoor unit. Thus, the Inverter model can achieve 30% more operating efficiency than conventional models and therefore, is much cheaper to run.

Power and speed

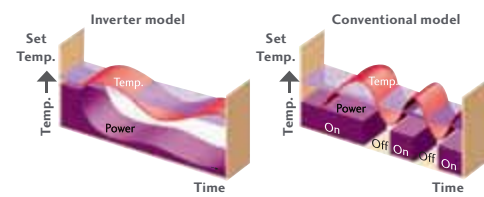

## Optimised inverter control

### I-PAM (IPM\*+PAM) Inverter Control

I-PAM inverter control is a technology which reduces loss by adjusting the current waveform to a better sine waveform. This promotes the effective use of the input power supply to attain high performance.

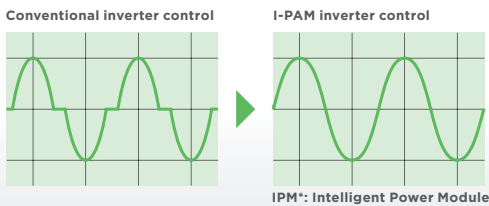

In addition, the voltage is raised at the start of operation and fast comfort is attainable by more powerful operation.

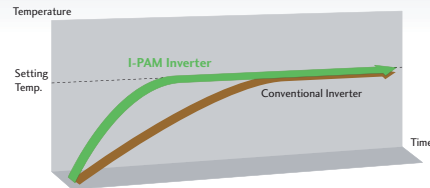

This technology enables miniaturisation and high performance of the compressor.

### V-PAM (Vector+I-PAM) Inverter Control

V-PAM inverter control reduces the effects of magnetic flux and increases the maximum speed and efficiency of the compressor by vector control technology. With this technology, further miniaturisation, higher efficiency, and better performance are attained.

More Compact than conventional models



It becomes more powerful with the newly developed high efficient compressor motor control.

## High energy efficiency

The high efficiency DC Inverter Multi System offers energy saving operation and 50% higher efficiency than a constant-speed multi system. Improved inverter cooling ratio prevents a drop in capacity when operating under load conditions.

Energy Saving over 1 year



## Comfort & stability

The air conditioner's output is stabilised at the optimum setting within the range from maximum to minimum to match the load, which is affected by factors such as the room temperature and the number of people present.

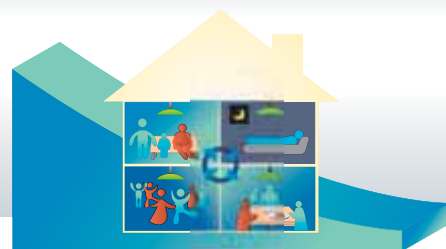

# INVERTER WALL MOUNTED – DESIGNER RANGE

## ASTG09LUCB

Hi-EER: 4.31 (W/W)  
 Hi-COP: 4.36 (W/W)  
 C 2.50kW/8,500 BTU/h  
 H 3.40kW/11,600 BTU/h

## ASTG14LUCB

Hi-EER: 3.36 (W/W)  
 Hi-COP: 3.67 (W/W)  
 C 4.20kW/14,300 BTU/h  
 H 5.40kW/18,400 BTU/h

## ASTG18LUCB

Hi-EER: 3.27 (W/W)  
 Hi-COP: 3.80 (W/W)  
 C 5.00kW/17,100 BTU/h  
 H 6.00kW/20,400 BTU/h



Wireless R.C



Optional

Wired R.C



For ASTG09



For ASTG14



For ASTG18



## GOOD DESIGN AWARD 2011

The Fujitsu Designer Range has received two international design awards. The 'iF Product Design Award 2012' recognises innovative product design and the 'Good Design Award 2011' identifies design that enriches everyday life.

## ENERGY SAVING

### Human sensor control

The human sensor in Fujitsu's Designer Range is designed to detect the movement of people to deliver the optimum efficiency and temperature control. When occupants leave the room and do not turn off the air conditioner, after 20 minutes of not detecting any movement in the room, the human sensor will switch the air conditioner into energy saving operation. During this operation, the set point will be increased by up to 2°C on cooling and decrease down to 4°C on heating to minimise the air conditioners energy usage. When someone re-enters the room, the human sensor will detect movement and return the air conditioner back to normal operation.

Energy Saving operation is initiated when movement is detected

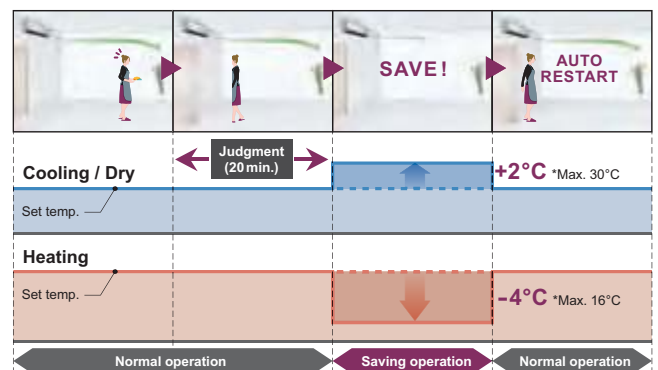

### Human sensor's coverage

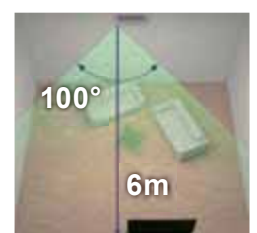

## POWERFUL OPERATION



Quick comfort by pressing just one button



### Powerful operation mode

When powerful operation mode is selected on the controller, the indoor unit fan and outdoor unit compressor will operate at maximum speed to quickly make the room conditioned and comfortable.

#### Caution

Powerful mode operates for 6 minutes or more, and stops automatically if reaching set temperature or 20 minutes pass.

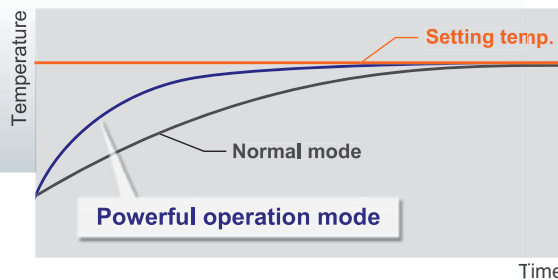

### 10°C HEAT operation

The room temperature can be set to go no lower than 10°C, thus ensuring that the room does not get too cold when not occupied.

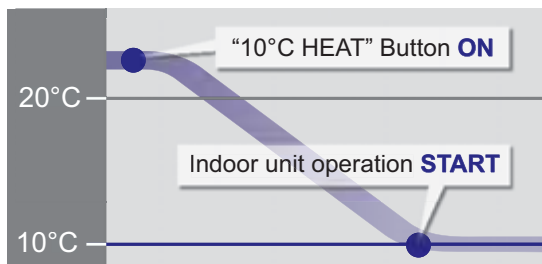

#### Caution

- When the room temperature is higher than 10°C, "10°C HEAT" operation does not start. Operation starts and maintains the room temperature at 10°C when the temperature drops below 10°C.
- When "10°C HEAT" operation stops, the room set temperature quickly returns to the preset temperature.

### Low noise mode for outdoor unit

Low noise mode of the outdoor unit can be selected by the wireless controller.

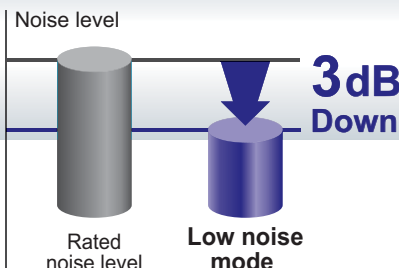

## OUR ADVANCED TECHNOLOGY

**Indoor unit:** How the air conditioner delivers comfort into the room has been improved by adopting an open panel design and a newly designed large diameter fan barrel. The introduction of these new features allows a much larger air intake to the indoor unit and better air circulation into the room space. In addition, this model has a new multi path high-density heat exchanger, which has increased the cooling and heating efficiency of the Designer Range models.

**Outdoor unit:** The operating noise of the outdoor unit has been reduced when compared with our other models by using an efficient air flow design. The Designer Range models use a large outdoor heat exchanger and DC twin rotary compressor to be able to deliver a higher capacity when required.

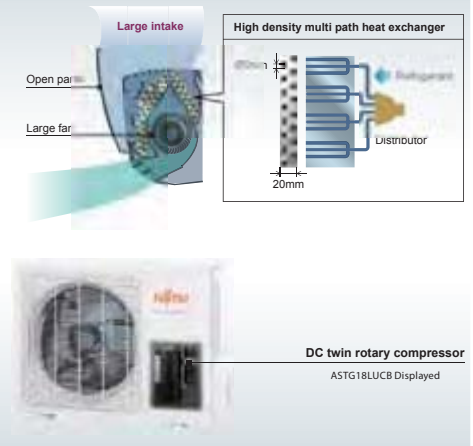

## REMOTE CONTROLLER

The Designer Range models have a new designed wireless controller, which allows for more convenient operation and high quality comfort operation by pushing a single button.

**Easier weekly timer setting:** Setting the weekly timer is much easier than before. The new 7 day timer mode allows for batch setting for all days of the week. Also it is possible to change the individual specified days separately.

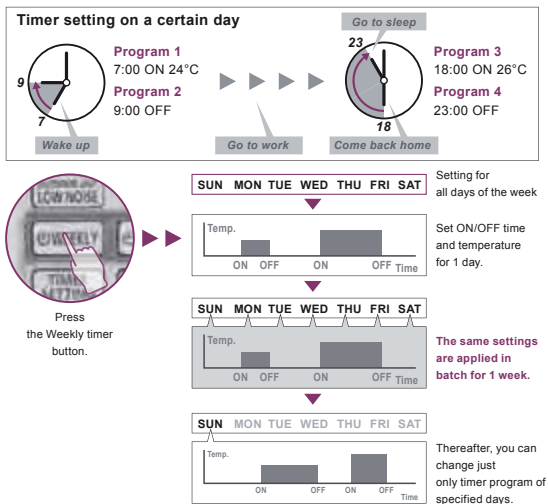

**Program timer:** This digital timer allows selection of one of four options: ON, OFF, ON OFF or OFF ON.

**Sleep timer:** The micro-processor gradually changes the room temperature automatically to allow a comfortable night's sleep.

\*Sleep timer setting : 0.5, 1, 2, 3, 5, 7, 9 Hours

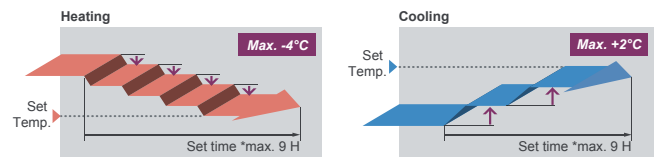

### Slim & Smart design remote controller

This thinnest ever remote controller has an easy-to-view large LCD and a one-touch selection button in simple and easy-to-use layout to achieve a great operation feel for often used functions. Ease of use and design are improved.

### 3 mode timer

Weekly timer can be easily set by wireless remote controller. ON, OFF can be set up to 4 times in 1 day and up to 28 times in 1 week. For other modes, Program timer and Sleep timer can be also selected by one push.

## OPTIONAL PARTS



- > Easy Operation
- > Weekly Timer
- > Sleep Timer
- > Program Timer

### Optional Remotes

(other accessories required)



Wired and wireless remote controllers are acceptable.

\*Optional communication kit is necessary for the installation

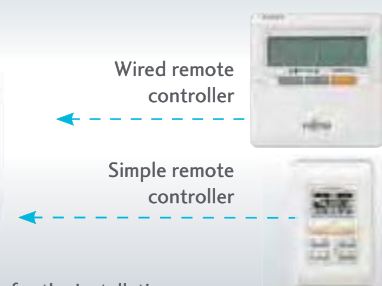





TYPE	MODEL	UNITS	INVERTER			
Model No.	Indoor Unit		ASTG09LUCB	ASTG14LUCB	ASTG18LUCB	
	Outdoor Unit		AOTG09LUCB	AOTG14LUCB	AOTG18LUCB	
Reverse Cycle System			YES	YES	YES	
Cooling Capacity		Watts	2,500	4,200	5,000	
		BTU/h	8,500	14,300	17,100	
Range		Watts	500-3,300	900-5,000	900-5,800	
		BTU/h	1,700-11,300	3,100-17,100	3,100-19,800	
Heating Capacity		Watts	3,400	5,400	6,000	
		BTU/h	11,600	18,400	20,400	
Range		Watts	500-4,200	900-6,000	1,050-7,300	
		BTU/h	1,700-14,300	3,100-20,500	3,600-24,900	
Power Supply		Volts	240	240	240	
Phase-Frequency		Ph- Hz	1-50	1-50	1-50	
Power Supply Attachment			Outdoor	Outdoor	Outdoor	
Plug Size (If Applicable)			NA	NA	NA	
Running Current	Cooling	Amps	2.8	5.7	6.5	
	Range		Max 6.0	Max 9.0	max 9.5	
	Heating		3.7	6.4	6.7	
Input	Cooling	Watts	580	1,250	1,530	
	Range		250-1,420	250-2,130	180-2,250	
	Heating		780	1,470	1,580	
	Range		250-1,780	250-2,490	170-3,200	
Moisture Removal		l/hr	1.3	2.1	2.6	
E.E.R.	Cooling		4.31	3.36	3.27	
C.O.P.	Heating		4.36	3.67	3.8	
Star Rating	Cooling		4	2	2	
	Heating		4	2.5	3	
Fan Speeds			4	4	4	
Air Circulation	High	l/s	222	250	264	
Compressor Type			DC Rotary	DC Rotary	DC Rotary	
Dimensions and Weights	I.U. mm	Height	282	282	282	
		Width	870	870	870	
		Depth	185	185	185	
	Net Weight		kg	9.5	9.5	9.5
		O.U. mm	Height	540	540	620
			Width	660	790	790
	Depth		290	290	290	
	Net Weight		kg	25	34	37
I.U. Sound Pressure Level			42	45	47	
O.U. Sound Pressure Level		dBA@1 metre	48	50	53	
O.U. Sound Power Level		dBA	65	67	70	
Refrigerant	Type		R410A	R410A	R410A	
Connection Pipe Sizes	Gas	mm	9.52	12.7	12.7	
	Liquid		6.35	6.35	6.35	
Pre Charged Length			15	15	15	
Minimum Pipe Length		Metre	3	3	3	
Maximum Pipe Length			20	20	20	
Maximum Pipe Height			15	15	15	
Pipe Connection Methods			Flare	Flare	Flare	
Outdoor operating Temp.	Cooling	Degrees C	10 to 46	10 to 46	10 to 46	
	Heating		-15 to 24	-15 to 24	-15 to 24	

# INVERTER WALL MOUNTED – COOLING ONLY

## Energy efficient Fujitsu comfort

The Fujitsu smart inverter range reaches the desired room temperature faster and then constantly adjusts to maintain perfect Fujitsu Comfort. With its energy efficiency, it is up to 30% cheaper to run than conventional air conditioners.

## INVERTER WALL MOUNTED – COOLING ONLY

<p><b>ASTG07JECB</b> Hi-EER: 4.47 (W/W) C 2.10kW/7,200 BTU/h</p>	<p><b>ASTG09JECB</b> Hi-EER: 4.13 (W/W) C 2.60kW/8,900 BTU/h</p>	
--	--	--



Wireless R.C

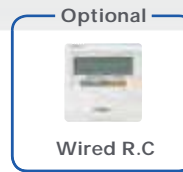

Optional

Wired R.C



For ASTG07/09

<p><b>ASTG12JECB</b> Hi-EER: 3.80 (W/W) C 3.50kW/11,900 BTU/h</p>	
---	--



Wireless R.C

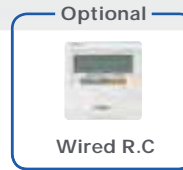

Optional

Wired R.C



For ASTG12

<p><b>ASTG18JVCA</b> Hi-EER: 3.27 (W/W) C 5.00kW/17,100 BTU/h</p>	
---	--



Wireless R.C

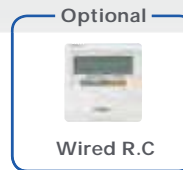

Optional

Wired R.C



For ASTG18

<p><b>ASTG24JFCC</b> Hi-EER: 3.27 (W/W) C 7.10kW/24,200 BTU/h</p>	<p><b>ASTG30JFCC</b> Hi-EER: 3.31 (W/W) C 8.00kW/27,300 BTU/h</p>	<p><b>ASTG34JFCC</b> Hi-EER: 3.29 (W/W) C 9.20kW/31,400 BTU/h</p>	
---	---	---	--



Wireless R.C

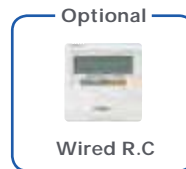

Optional

Wired R.C



For ASTG24



For ASTG30



For ASTG34

## FEATURES & BENEFITS

### Air conditioner filter features



#### Long-life\* Ion Deodorisation Filter

The filter deodorises by powerfully decomposing absorbed odours using the oxidising and reducing effects of ions generated by the ultra-fine-particle ceramic.



\*The filter can be used for approx. 3 years if it is washed under water to restore its surface action when it is dirty.



#### Apple-catechin Filter

Fine dust, invisible mold spores, and harmful micro organisms are absorbed onto the filter by static electricity, and further growth is inhibited and deactivated by the polyphenol extracted from apples.

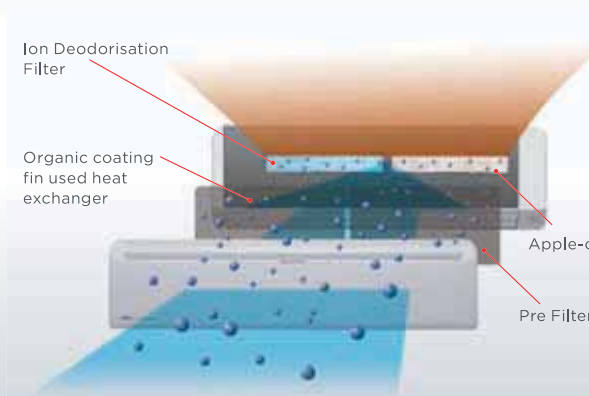

T TYPE	MODEL	UNITS	INVERTER							
Model No.	Indoor Unit		ASTG07JECB	ASTG09JECB	ASTG12JECB	ASTG18JVCA	ASTG24JFCC	ASTG30JFCC	ASTG34JFCC	
	Outdoor Unit		AOTG07JECB	AOTG09JECB	AOTG12JECB	AOTG18JVCA	AOTG24JFCC	AOTG30JFTC	AOTG34JFTC	
Reverse Cycle System			No	No	No	No	No	No	No	
Cooling Capacity		Watts	2,100	2,600	3,500	5,000	7,100	8,000	9,200	
		BTU/h	7,200	8,900	11,900	17,100	24,200	27,300	31,400	
Range		Watts	900-3,000	900-3,200	900-4,000	900-5,800	900-8,300	2,900-9,000	2,900-10,000	
		BTU/h	3,100-10,200	3,100-10,900	3,100-13,600	3,100-19,800	3,100-28,300	9,900-30,700	9,900-34,100	
Heating Capacity		Watts	-	-	-	-	-	-	-	
		BTU/h	-	-	-	-	-	-	-	
Range		Watts	-	-	-	-	-	-	-	
		BTU/h	-	-	-	-	-	-	-	
Power Supply		Volts	240	240	240	240	240	240	240	
Phase-Frequency		Ph- Hz	1-50	1-50	1-50	1-50	1-50	1-50	1-50	
Power Supply Attachment			Outdoor/NA	Outdoor/NA	Outdoor/NA	Outdoor/NA	Outdoor/NA	Outdoor/NA	Outdoor/NA	
Running Current	Cooling	Amps	2.5	3.1	4.2	6.5	9.1	10.2	11.8	
	Range		Max 6.0	Max 6.0	Max 6.5	Max 9.5	Max 13.5	Max 17	Max 18.5	
	Heating		-	-	-	-	-	-	-	-
	Range		-	-	-	-	-	-	-	-
Input	Cooling	Watts	470	630	920	1,530	2,170	2,420	2,800	
	Range		250-1,270	250-1,270	250-1,540	180-2,030	300-2,860	580-3,150	590-3,540	
	Heating		-	-	-	-	-	-	-	-
	Range		-	-	-	-	-	-	-	-
Moisture Removal		l/hr	1.0	1.3	1.8	2.6	2.7	3.2	3.5	
E.E.R.	Cooling		4.47	4.13	3.80	3.27	3.27	3.31	3.29	
C.O.P.	Heating		-	-	-	-	-	-	-	
	Cooling		4.5	3.5	3	2	2	2	2	
Star Rating	Heating		-	-	-	-	-	-	-	
	Cooling		4	4	4	4	4	4	4	
Fan Speeds			4	4	4	4	4	4	4	
Air Circulation	High	l/s	192	192	208	267	311	311	347	
Compressor Type			DC Rotary	DC Rotary	DC Rotary	DC Rotary	DC Rotary	DC Rotary	DC Rotary	
Dimensions and Weights	I.U. mm	Height	260	260	280	293	320	320	320	
		Width	790	790	790	790	998	998	998	
		Depth	198	198	203	225	238	238	238	
	Net Weight		kg	7.5	7.5	8.0	9.5	14	14	14
		O.U. mm	Height	540	540	540	620	620	830	1,290
	Width		660	660	790	790	790	900	900	
	Depth		290	290	290	290	290	330	330	
	Net Weight		kg	29	29	34	37	41	61	86
			43	43	43	46	49	49	52	
O.U. Sound Pressure Level		dB	47	49	49	52	55	53	53	
O.U. Sound Power Level		dB	62	65	66	69	71	69	67	
Refrigerant	Type		R410A	R410A	R410A	R410A	R410A	R410A	R410A	
Connection Pipe Sizes	Gas	mm	9.52	9.52	9.52	12.7	15.88	15.88	15.88	
	Liquid		6.35	6.35	6.35	6.35	6.35	9.52	9.52	
Pre Charged Length			7.5	7.5	7.5	15	15	20	20	
Minimum Pipe Length			3	3	3	3	3	5	5	
Maximum Pipe Length			15	15	20	20	30	50	50	
Maximum Pipe Height			10	10	15	15	20	30	30	
Pipe Connection Methods			Flare	Flare	Flare	Flare	Flare	Flare	Flare	
Outdoor operating Temp.	Cooling	Degrees C	18 to 46	18 to 46	18 to 46	18 to 46	18 to 46	18 to 46	18 to 46	
	Heating		-	-	-	-	-	-	-	

# INVERTER WALL MOUNTED – REVERSE CYCLE

## INVERTER WALL MOUNTED

ASTG09LV	ASTG12LV	ASTG18LV	ASTG22LV
Hi-EER: 4.31 (W/W)	Hi-EER: 3.80 (W/W)	Hi-EER: 3.27 (W/W)	Hi-EER: 3.23 (W/W)
Hi-COP: 4.66 (W/W)	Hi-COP: 4.32 (W/W)	Hi-COP: 4.03 (W/W)	Hi-COP: 3.55 (W/W)
<b>C</b> 2.50kW/8,500 BTU/h	<b>C</b> 3.50kW/11,900 BTU/h	<b>C</b> 5.00kW/17,100 BTU/h	<b>C</b> 6.30kW/21,500 BTU/h
<b>H</b> 3.40kW/11,600 BTU/h	<b>H</b> 4.80kW/16,400 BTU/h	<b>H</b> 6.00kW/20,400 BTU/h	<b>H</b> 7.20kW/23,900 BTU/h

Wireless R.C

Optional  
Wired R.C

For ASTG09LV

For ASTG12LV

For ASTG18/22LV

### Air conditioner filter features

The ASTG standard air clean filter uses static electricity to clean fine particles and dust in the air such as tobacco smoke and plant pollen that are too small to see.

The filter contains catechin which is highly effective against various bacteria by suppressing the growth of bacteria absorbed by the filter.

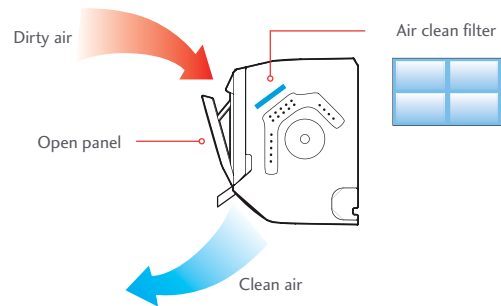

- > Clean automatic open panel
- > Air clean (anti-bacteria) filter provides clean airflow for complete comfort

## HIGH EFFICIENCY TECHNOLOGY

Significantly higher efficiency is realised by using DC twin rotary compressor, DC Inverter control and DC fan motor technologies.

High density multiple path heat exchanger

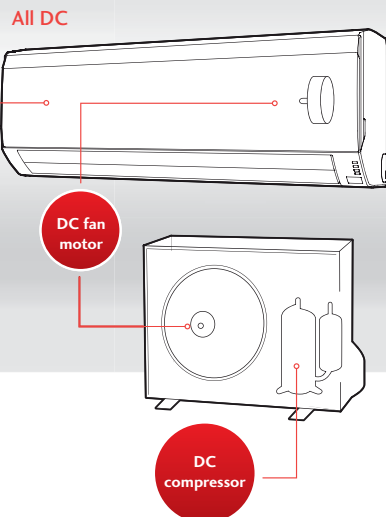
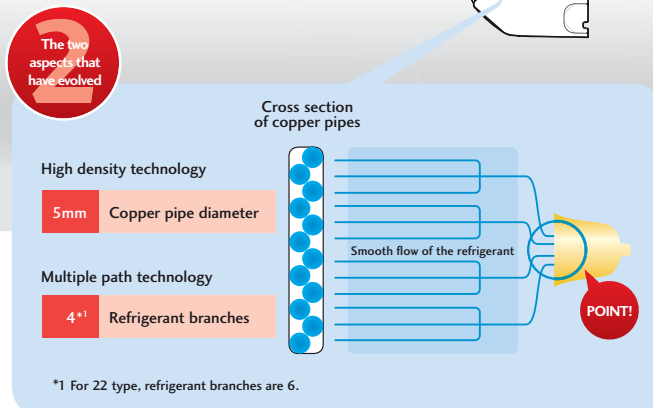



# CONTROL OPTIONS



- > Four Standard Timers (On/Off/Program/Sleep Timers)
- > Easy Operation
- > Easy to change transmission code

**Optional Remotes**  
(other accessories required)



Wired and wireless remote controllers are acceptable.  
\*Optional communication kit is necessary for the installation



Wired remote controller



Simple remote controller

TYPE	MODEL		UNITS	INVERTER			
	Indoor Unit	Outdoor Unit		ASTG09LVCC	ASTG12LVCC	ASTG18LVCC	ASTG22LVCC
Model No.	Indoor Unit	Outdoor Unit		AOTG09LVCC	AOTG12LVCC	AOTG18LVCC	AOTG22LVCC
Reverse Cycle System			Yes	Yes	Yes	Yes	Yes
Cooling Capacity		Watts	2,500	3,500	5,000	6,300	
		BTU/h	8,500	11,900	17,100	21,500	
Range		Watts	500-3,300	900-4,000	900-5,800	900-7,300	
		BTU/h	1,700-11,300	3,100-13,600	3,100-19,800	3,100-24,900	
Heating Capacity		Watts	3,400	4,800	6,000	7,200	
		BTU/h	11,600	16,400	20,400	23,900	
Range		Watts	500-4,000	900-5,600	1,050-8,100	1,050-8,700	
		BTU/h	1,700-13,600	3,100-19,100	3,600-27,600	3,600-29,700	
Power Supply		Volts	240	240	240	240	
Phase-Frequency		Ph- Hz	1-50	1-50	1-50	1-50	
Power Supply Attachment			Outdoor	Outdoor	Outdoor	Outdoor	
Running Current	Cooling	Amps	2.8	4.2	6.5	8.2	
	Range		Max 6.0	Max 6.5	Max 9.5	Max 11.5	
	Heating		3.5	5	6.3	8.5	
	Range		Max 7.5	Max 9.0	Max 13.5	Max 17.5	
Input	Cooling	Watts	580	920	1,530	1,950	
	Range		250-1,240	250-1,420	180-2,030	180-2,750	
	Heating		730	1,110	1,490	2,030	
	Range		250-1,560	250-2,000	170-3,190	170-4,180	
Moisture Removal		l/hr	1.3	1.8	2.6	2.7	
E.E.R.	Cooling		4.31	3.8	3.27	3.23	
C.O.P.	Heating		4.66	4.32	4.03	3.55	
Star Rating	Cooling		4	3	2	2	
	Heating		4.5	4	3.5	2.5	
Fan Speeds			4	4	4	4	
Air Circulation	High	l/s	219	225	267	267	
Compressor Type			DC Rotary	DC Rotary	DC Rotary	DC Rotary	
Dimensions and Weights	I.U. mm	Height	293	293	293	293	
		Width	790	790	790	790	
		Depth	225	225	225	225	
	O.U. mm	Net Weight	kg	9.5	9.5	9.5	10
		Height	540	540	620	620	
			Width	660	790	790	790
			Depth	290	290	290	290
	Net Weight	kg	25	34	37	40	
I.U. Sound Pressure Level		dB(A)@1metre	41	42	46	48	
O.U. Sound Pressure Level		dB(A)	47	48	52	55	
O.U. Sound Power Level		dB(A)	64	66	69	72	
Refrigerant	Type		R410A	R410A	R410A	R410A	
Connection Pipe Sizes	Gas	mm	9.52	9.52	12.7	15.88	
	Liquid	mm	6.35	6.35	6.35	6.35	
Pre Charged Length			15	15	15	15	
Minimum Pipe Length		Metre	3	3	3	3	
Maximum Pipe Length			20	20	20	20	
Maximum Pipe Height			15	15	15	15	
Pipe Connection Methods			Flare	Flare	Flare	Flare	
Outdoor operating Temp.	Cooling	Degrees C	10 to 46	10 to 46	10 to 46	10 to 46	
	Heating	Degrees C	-15 to 24	-15 to 24	-15 to 24	-15 to 24	

# INVERTER WALL MOUNTED – REVERSE CYCLE

## INVERTER WALL MOUNTED

### ASTG24LF

Hi-EER: 3.27 (W/W)  
 Hi-COP: 3.54 (W/W)  
 C 7.1kW/24,200 BTU/h  
 H 8.00kW/27,300 BTU/h

### ASTG30LF

Hi-EER: 3.31 (W/W)  
 Hi-COP: 3.41 (W/W)  
 C 8.00kW/27,300 BTU/h  
 H 9.00kW/30,700 BTU/h

### ASTG34LF

Hi-EER: 3.29 (W/W)  
 Hi-COP: 3.30 (W/W)  
 C 9.2kW/31,400 BTU/h  
 H 10.00kW/34,100 BTU/h



Wireless R.C

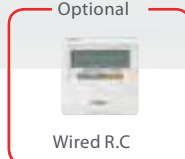

Optional  
Wired R.C



For ASTG24LF



For ASTG30LF



For ASTG34LF

## ALL DC

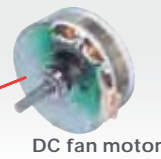

DC fan motor

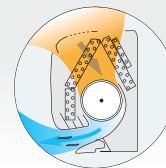

**High efficiency layout**  
 Large air flow and quiet operation by new air flow path.

**A** DC fan motor

**B** DC Compressor  
 More compact compared with conventional model

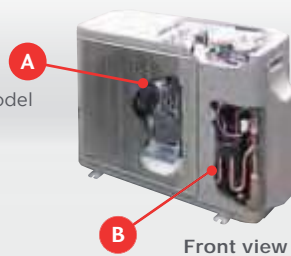

Front view

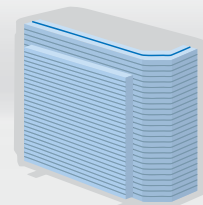

Back view

**New 3-row heat exchange system**  
 (For ASTG24LF)

### Economy operation

Economy operation is an energy saving setting that allows the set temperature of the indoor unit to change by 1°C intervals which limits the maximum energy usage of the air conditioner.

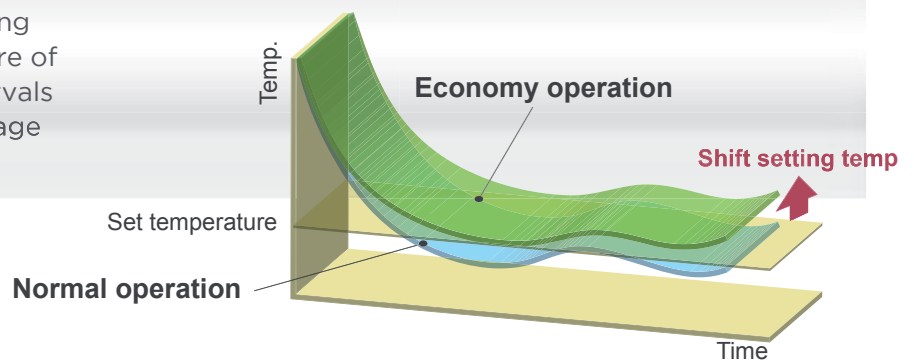

## BLUE FIN HEAT EXCHANGER

Fujitsu has made an air conditioner to suit almost all installation environments. As over 80% of Australia's population live in coastal areas, Fujitsu has improved the corrosion resistance of all its outdoor unit heat exchangers with the introduction of a blue fin coil treatment.

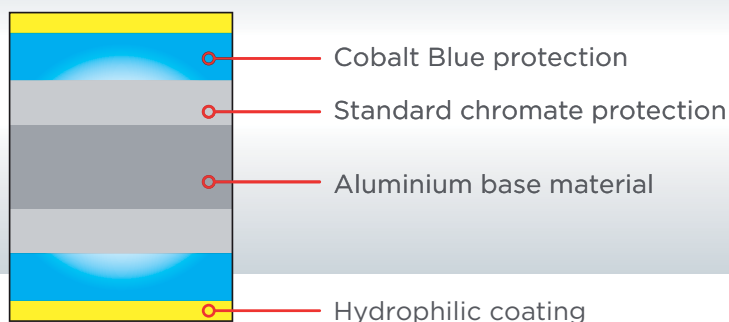

TYPE	MODEL	UNITS	INVERTER		
Model No.	Indoor Unit		ASTG24LFCC	ASTG30LFCC	ASTG34LFCC
	Outdoor Unit		AOTG24LFCC	AOTG30LFCC	AOTG34LFCC
Reverse Cycle System			Yes	Yes	Yes
Cooling Capacity		Watts	7,100	8,000	9,200
		BTU/h	24,200	27,300	31,400
Range		Watts	900-8,300	2,900-9,000	2,900-10,000
		BTU/h	3,100-28,300	9,900-30,700	9,900-34,100
Heating Capacity		Watts	8,000	9,000	10,000
		BTU/h	27,300	30,700	34,100
Range		Watts	900-10,600	2,200-11,000	2,700-11,200
		BTU/h	3,100-36,200	7,500-37,600	9,200-38,200
Power Supply		Volts	240	240	240
Phase-Frequency		Ph- Hz	1-50	1-50	1-50
Power Supply Attachment			Outdoor	Outdoor	Outdoor
Running Current	Cooling	Amps	9.1	10.2	11.8
	Range		Max 13.5	Max 17.0	Max 18.5
	Heating		9.5	11.1	12.8
	Range		Max 18.5	Max 19.0	Max 19.0
Input	Cooling	Watts	2,170	2,420	2,800
	Range		300-2,860	580-3,150	590-3,540
	Heating		2,260	2,640	3,030
	Range		280-4,060	500-3,530	600-3,570
Moisture Removal		l/hr	2.7	3.2	3.5
E.E.R.	Cooling		3.27	3.31	3.29
C.O.P.	Heating		3.54	3.41	3.30
Star Rating	Cooling		2	2	2
	Heating		2.5	2	2
Fan Speeds			4	4	4
Air Circulation	High	l/s	311	311	347
Compressor Type			DC Rotary	DC Rotary	DC Rotary
Dimensions and Weights	I.U. mm	Height	320	320	320
		Width	998	998	998
		Depth	238	238	238
	Net Weight	kg	14	14	14
		O.U. mm	Height	620	830
	Width		790	900	900
	Depth		290	330	330
	Net Weight	kg	41	61	86
I.U. Sound Pressure Level		dB@1metre	49	49	52
O.U. Sound Pressure Level			55	53	53
O.U. Sound Power Level		dB	71	69	67
Refrigerant	Type		R410A	R410A	R410A
Connection Pipe Sizes	Gas	mm	15.88	15.88	15.88
	Liquid		6.35	9.52	9.52
Pre Charged Length			15	20	20
Minimum Pipe Length		Metre	3	3	5
Maximum Pipe Length			30	50	50
Maximum Pipe Height			20	30	30
Pipe Connection Methods			Flare	Flare	Flare
Outdoor operating Temp.	Cooling	Degrees C	-10 to 46	-10 to 46	-5 to 46
	Heating		-15 to 24	-15 to 24	-15 to 24

## POWER DIFFUSER

### Introduction of a Power Diffuser

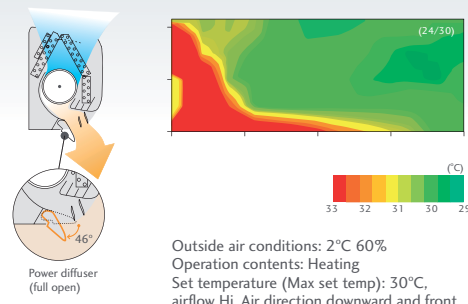

"Strong vertical air flow" provides powerful floor level heating

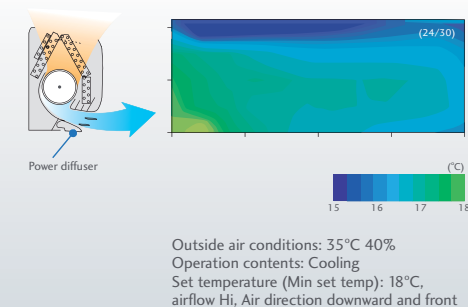

"Healthy horizontal air flow" does not blow cool air directly at the occupants in the room

# INVERTER CASSETTE

## INVERTER CASSETTE SPLIT SYSTEMS - COMPACT

### AUTG18L

- C 5.20 kW / 17,700 BTU/h
- H 6.00 kW / 20,500 BTU/h

### AUTG24L

- C 7.10 kW / 24,200 BTU/h
- H 8.00 kW / 27,300 BTU/h



Provide wide air flow & quiet operation.

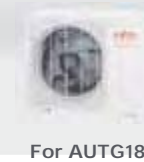
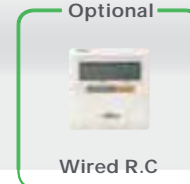

## INVERTER CASSETTE SPLIT SYSTEM

### AUTA30L

- C 8.50 kW / 29,000 BTU/h
- H 10.0 kW / 34,100 BTU/h



Provide wide air flow & quiet operation.

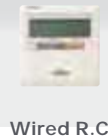



## FEATURES & BENEFITS

### High efficiency turbo fan with 3-dimensional blade

**Previous turbo fan:** Air passing through the heat exchanger was uneven and the air would only flow close to the ceiling.

**New turbo fan:** High efficiency airflow distribution has been achieved by the introduction of a 3-dimensional blade which increases the air passing over the heat exchanger.

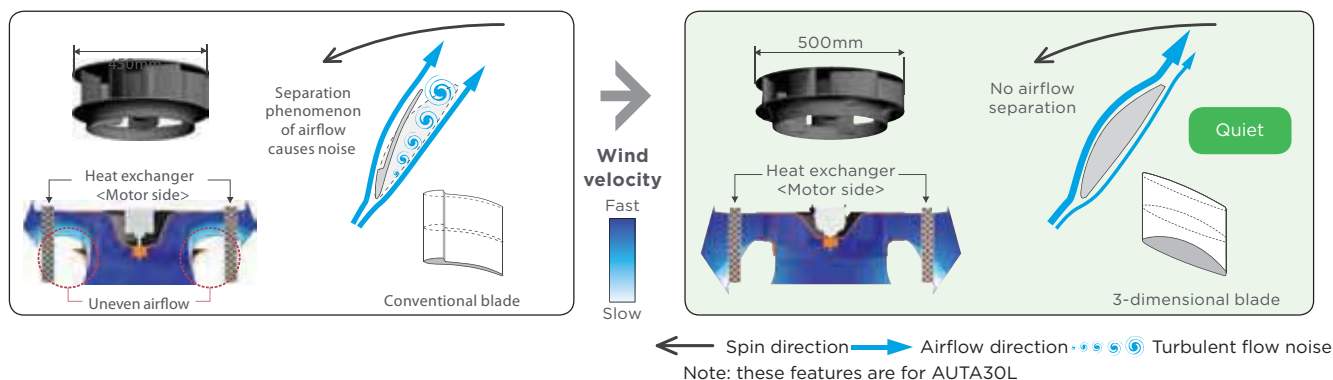

TYPE	MODEL	UNITS	INVERTER		
Model No.	Indoor Unit		AUTG18LVLA	AUTG24LVLC	AUTA30LBLU
	Outdoor Unit		AOTG18LACC	AOTG24LATC	AOTA30LGTL
Reverse Cycle System			Yes	Yes	Yes
Cooling Capacity		Watts	5,200	7,100	8,500
		BTU/h	17,700	24,200	29,000
Range		Watts	900-5,900	2,900-8,000	2,800-10,000
		BTU/h	3,100-20,100	9,900-27,300	9,500-34,100
Heating Capacity		Watts	6,000	8,000	10,000
		BTU/h	20,500	27,300	34,100
Range		Watts	900-7,500	2,200-9,100	2,700-11,200
		BTU/h	3,100-25,600	7,500-31,000	9,200-38,200
Power Supply		Volts	240	240	240
Phase-Frequency		Ph- Hz	1-50	1-50	1-50
Power Supply Attachment			Outdoor	Outdoor	Outdoor
Plug Size (If Applicable)		Amps	NA	NA	NA
Running Current	Cooling	Amps	6.8	9.1	10.8
	Range		Max 9.6	Max 15.7	Max 17.0
	Heating		7.0	9.3	11.6
	Range		Max 13.1	Max 15.7	Max 17.0
Input	Cooling	Watts	1,560	2,160	2,570
	Range		Max 1,990	Max 2,970	Max 4,040
	Heating		1,660	2,210	2,770
	Range		Max 2,520	Max 2,800	Max 4,040
Moisture Removal		l/hr	2.2	2.7	2.5
E.E.R.	Cooling		3.33	3.29	3.31
C.O.P.	Heating		3.61	3.61	3.61
Star Rating	Cooling		2	2	2
	Heating		2.5	2.5	2.5
Fan Speeds			4	4	4
Air Circulation	High	l/s	189	258	444
Compressor Type			DC Rotary	DC Rotary	DC Rotary
Dimensions and Weights	I.U. (Grille) mm	Height	245(49)	245(49)	288(50)
		Width	570(700)	570(700)	840(950)
		Depth	570(700)	570(700)	840(950)
	Net Weight	kg	15(2.6)	17(2.6)	26(5.5)
			620	830	830
	O.U. mm	Width	790	790	900
		Depth	290	330	330
		Net Weight	kg	41	60
I.U. Sound Pressure Level		dBA@1 metre	38	49	40
O.U. Sound Pressure Level			55	53	53
O.U. Sound Power Level		dBA	71	68	69
Refrigerant	Type		R410A	R410A	R410A
Connection Pipe Sizes	Gas	mm	12.7	15.88	15.88
	Liquid		6.35	6.35	9.52
Pre Charged Length			15	20	20
Minimum Pipe Length		Metre	3	3	5
Maximum Pipe Length			30	30	50
Maximum Pipe Height			20	30	30
Pipe Connection Methods			Flare	Flare	Flare
Outdoor operating Temp.	Cooling	Degrees C	-10 to 46	-10 to 46	-15 to 46
	Heating		-15 to 24	-15 to 24	-15 to 24

### Improvement of the airflow distribution

#### New louvre

The new louvre design allows for a better air circulation to all areas of the room when compared with the previous model.

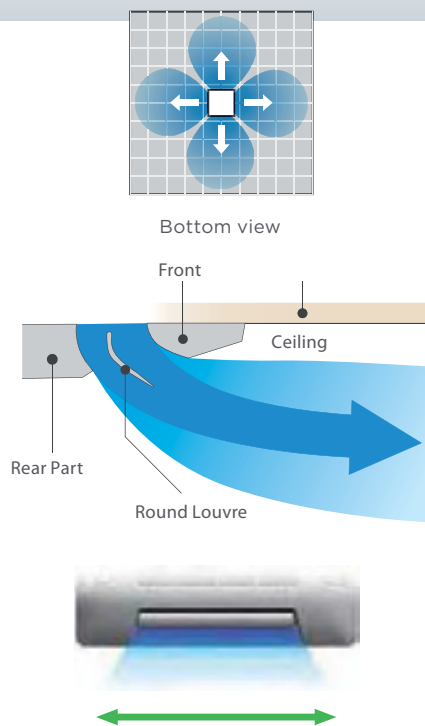

Temperature irregularity has been reduced by evenly circulating the airflow across the louvre.

# INVERTER CEILING & FLOOR CONSOLE

## INVERTER FLOOR CONSOLE SPLIT SYSTEMS

### AGTV09L

- C 2.6 kW / 8,900 BTU/h
- H 3.5 kW / 11,900 BTU/h

### AGTV14L

- C 4.2 kW / 14,300 BTU/h
- H 5.2 kW / 17,700 BTU/h

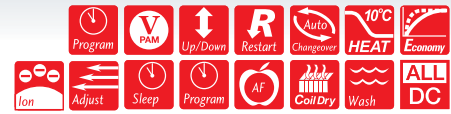

Wireless R.C

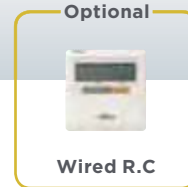

Wired R.C



For AGTV09L/14L

## INVERTER CEILING & FLOOR CONSOLE SPLIT SYSTEMS

### ABTG18L

- C 5.20 kW / 17,700 BTU/h
- H 6.00 kW / 20,500 BTU/h

### ABTG24L

- C 7.10 kW / 24,200 BTU/h
- H 8.00 kW / 27,300 BTU/h



Wireless R.C

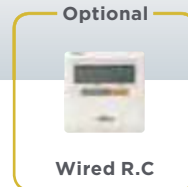

Wired R.C



For ABTG18L



For ABTG24L

## INVERTER UNDER CEILING SPLIT SYSTEM

### ABTA30L

- C 8.50 kW / 29,000 BTU/h
- H 10.0 kW / 34,100 BTU/h



Provides wide air flow & quiet operation.



Wireless R.C

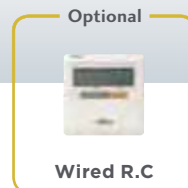

Wired R.C



For ABTA30L

### Floor Console Airflow

#### Cooling

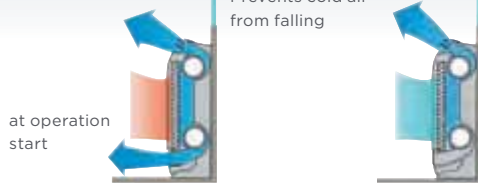

#### Heating

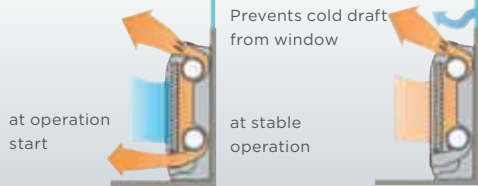

For AGTV floor model - 2-fan & wide air flow

### Control Setting

Setting by wired remote controller.



TYPE	MODEL	UNITS	INVERTER				
Model No.	Indoor Unit		AGTV09LAC	AGTV14LAC	ABTG18LVTA	ABTG24LVTC	ABTA30LBT
	Outdoor Unit		AOTV09LAC	AOTV14LAC	AOTG18LACC	AOTG24LATC	AOTA30LGTL
Reverse Cycle System			Yes	Yes	Yes	Yes	Yes
Cooling Capacity		Watts	2,600	4,200	5,200	7,100	8,500
		BTU/h	8,900	14,300	17,700	24,200	29,000
Range		Watts	900-3,500	900-5,000	900-5,900	2900-8,000	2,800-10,000
		BTU/h	3,100-11,900	3,100-17,100	3,100-20,100	9,900-27,300	9,500-34,100
Heating Capacity		Watts	3,500	5,200	6,000	8,000	10,000
		BTU/h	11,900	17,700	20,500	27,300	34,100
Range		Watts	900-5,500	900-8,000	900-7,500	2,200-9,100	2,700-11,200
		BTU/h	3,100-18,800	3,100-27,300	3,100-25,600	7,500-31,000	9,200-38,200
Power Supply		Volts	240	240	240	240	240
Phase-Frequency		Ph- Hz	1-50	1-50	1-50	1-50	1-50
Power Supply Attachment			Outdoor	Outdoor	Outdoor	Outdoor	Outdoor
Running Current	Cooling Range	Amps	2.8	5.3	6.4	9.0	10.8
	Heating Range		7	9	Max 9.6	Max 15.7	Max 17.0
Input	Cooling Range	Watts	3.8	6.1	7.0	9.3	11.6
	Heating Range		10	13.5	Max 13.1	Max 15.7	Max 17.0
	Cooling Range		600	1220	1,510	2,140	2,570
	Heating Range		250-1,400	250-1,950	Max 1,810	Max 2,400	Max 4,040
Moisture Removal		I/hr	810	1440	1,660	2,210	2,770
E.E.R.			250-2,200	250-3,050	Max 2,350	Max 2,650	Max 4,040
C.O.P.	Cooling		1.3	2.1	2	2.7	2.5
Star Rating	Heating		4.33	3.44	3.44	3.32	3.31
	Cooling		4.32	3.61	3.61	3.61	3.61
Fan Speeds	Heating		3.5	2.0	2	2	2
Air Circulation	Heating		3.5	2.5	2.5	2.5	2.5
Compressor Type	High	l/s	4	4	4	4	4
Dimensions and Weights	I.U. mm	Height	158	180	217	272	461
		Width	DC Rotary	DC Rotary	DC Rotary	DC Rotary	DC Rotary
		Depth	600	600	199	199	240
	O.U. mm	Height	740	740	990	990	1,660
		Width	200	200	655	655	700
		Depth	290	300	290	330	330
	Net Weight	kg	14	14	27	27	46
		kg	540	540	620	830	830
I.U. Sound Pressure Level		dBA@1metre	790	790	790	900	900
O.U. Sound Pressure Level			290	300	290	330	330
O.U. Sound Power Level			36	40	41	60	61
Refrigerant	Type		40	44	44	49	45
Connection Pipe Sizes	Gas	mm	47	50	55	53	53
	Liquid		64	66	71	68	69
Pre Charged Length			R410A	R410A	R410A	R410A	R410A
Minimum Pipe Length			9.52	12.7	12.7	15.88	15.88
Maximum Pipe Length			6.35	6.35	6.35	6.35	9.52
Maximum Pipe Height			15	15	15	20	20
Pipe Connection Methods			3	3	3	3	5
Outdoor operating Temp.	Cooling	Degrees C	20	20	30	30	50
	Heating		15	15	20	30	30
			Flare	Flare	Flare	Flare	Flare
			-10 to 43	-10 to 43	-10 to 46	-10 to 46	-15 to 46
			-15 to 24	-15 to 24	-15 to 24	-15 to 24	-15 to 24

# INVERTER MULTI SYSTEMS

A new Fujitsu Inverter Multi System is ideal where an individual indoor unit is required in more than one room, eg. a living room and 3 bedrooms. A Multi System allows for one outdoor unit to be connected to a wide variety of 2, 3 or 4 indoor units including Wall Mounted, Floor/Ceiling Console and Cassette models.

## Wide range of indoor units with various models & sizes

The range includes 6 different indoor unit types and 12 different models ranging in capacity from 2.3kW to 6.8kW. With such a wide range of options to choose from, there's a combination to suit almost any need from a small residence to a large shop.

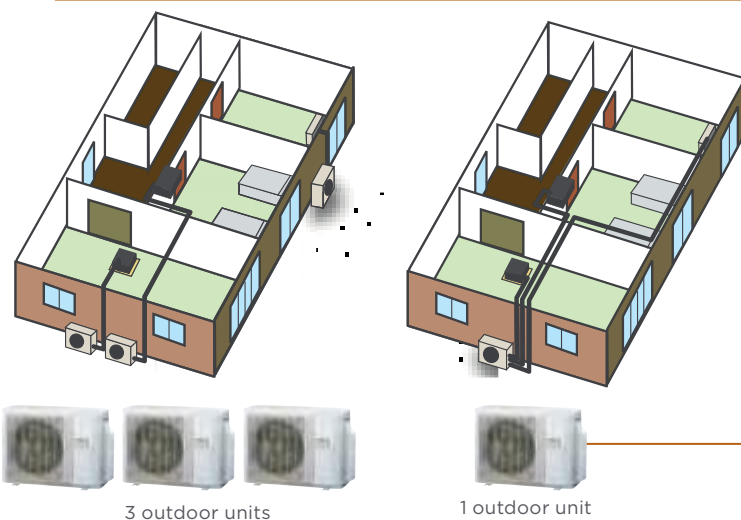

## Space-saving installation

Multiple indoor units can be connected to 1 outdoor unit rather than multiple outdoor units. This means greater installation flexibility and space saving options. Long pipe runs offer even greater choices for installation.



## FLEXIBLE INSTALLATION

Fujitsu Multi type systems can be installed in large buildings and over multiple floors due to the maximum allowable piping length.

**Max. Piping Length (Each Unit):**  
25m (AOTG24LAT3/30LAT4)

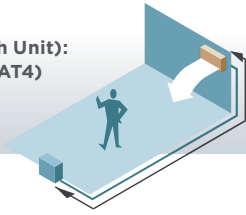

**Max. Height:**  
15m (AOTG24LAT3/30LAT4)

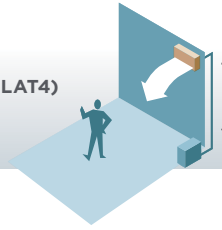

**Total Piping Length:**  
50m (AOTG24LAT3)  
70m (AOTG30LAT4)

## INNOVATIVE TECHNOLOGY

### High efficiency large fan

New designed fan has been used to increase airflow efficiency.

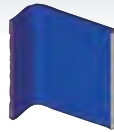

### Heat exchanger

A new 3 row heat exchanger has been used which allows for a more compact outdoor unit with higher energy efficiency.

### DC fan motor

High performance and High efficiency has been achieved by using a new small DC Fan motor.



### High efficiency DC twin rotary compressor

A high performance, low noise, large capacity DC twin rotary compressor is used.

## 10°C HEAT OPERATION

The room temperature can be set to go no lower than 10°C, thus ensuring that the room does not get too cold when not occupied.

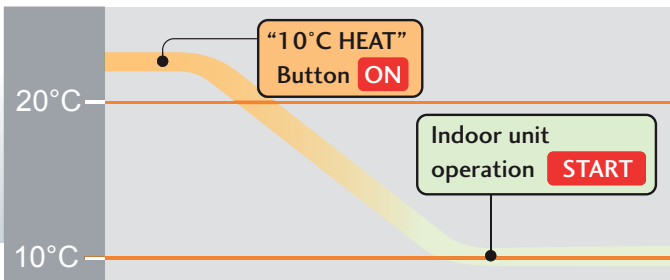

### Caution

When the room temperature is higher than 10°C, "10°C HEAT" operation does not start. Operation starts and maintains the room temperature at 10°C when the temperature drops below 10°C.

## ECONOMY OPERATION

Economy operation is an energy saving setting that allows the set temperature of the indoor unit to change by 1°C intervals which limits the maximum energy usage of the air conditioner.

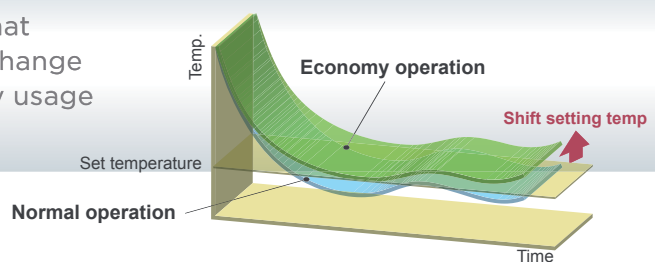

# OUTDOOR UNITS

## 3 room set-up



AOTG24LAT3

**C** 6.80kW/23,200 BTU/h

**H** 8.00kW/27,300 BTU/h

## 4 room set-up



AOTG30LAT4

**C** 8.00kW/27,300 BTU/h

**H** 9.60kW/32,800 BTU/h

### ASTG07/09/12LV



### ASTG18/24LF



### ASTG09/14LU



### AUTG09/12/18LV



### ABTG18LV



	Up/Down	Double	Adjust	Restart	HEAT	Fresh	Fresh	Economy	Sleep	Program	W+S	Weekly	Filter	Ion	AF	Wash	Auto Flaps	Auto Shut flaps	Human Sensor	ALL DC	
ASTG09/14LUCA	•	•	•	•	•	•	•	•	•	•	•	•	•	•	•	•	•	•	•	•	•
ASTG07/09/12LV	•	•	•	•	•	•	•	•	•	•	•	•	•	•	•	•	•	•	•	•	•
ASTG18/24LF	•	•	•	•	•	•	•	•	•	•	•	•	•	•	•	•	•	•	•	•	•
AUTG09/12/18LV	•	•	•	•	•	•	•	•	•	•	•	•	•	•	•	•	•	•	•	•	•
ABTG18LV	•	•	•	•	•	•	•	•	•	•	•	•	•	•	•	•	•	•	•	•	•

• Included function ○ Optional function

# INDOOR UNITS THAT CAN BE CONNECTED TO EACH OUTDOOR UNIT

• CONNECTED - NOT CONNECTED

OUTDOOR	BTU Class kW Class	COMPACT CASSETTE			COMPACT WALL MOUNTED				WALL MOUNTED		FLOOR/CEILING	
		AUTG09-18LVLA			LV		LU		ASTG18LFCA ASTG24LFCC		ABTG18LVTA	
		09	12	18	ASTG07LVCA ASTG09-12LVCC	12	ASTG09-14LUCB	09	14	18	24	18
3 ROOMS	AOTG24LAT3	•	•	•	•	•	•	•	•	•	•	•
4 ROOMS	AOTG30LAT4	•	•	•	•	•	•	•	•	•	•	•

## CONTROLLER OPTIONS



TYPE	MODEL	INDOOR UNITS				
		Compact Cassette	Compact Wall Mounted		Wall Mounted	Floor/Ceiling
			LV	LU		
Wired Remote Controller	UTY-RNNYN	○	○*1	○*2	○	○
Wireless Remote Controller	AR-RAH2E	-	-	-	•	•
	AR-RAH1E	•	•	-	•	•
	AR-REA1E	-	-	•	-	-
Simple Remote Controller	UTY-RSNNYN	○	○*1	○*2	○	○

• Included controller ○ Optional controller \*1 Optional Communication Kit (UTY-XCBXZ1) is necessary for the installation  
\*2 Optional Communication kit (UTY-TWBXF) is necessary for the installation

## INDOOR UNIT CONNECTION PATTERN

3 ROOMS - AOTG24LAT3 CONNECTABILITY					
NO.	ROOM 1	ROOM 2	ROOM 3	ROOM 4	TOTAL
1	7	7	-	-	14
2	7	9	-	-	16
3	7	12	-	-	19
4	7	14	-	-	21
5	7	18	-	-	25
6	9	9	-	-	18
7	9	12	-	-	21
8	9	14	-	-	23
9	9	18	-	-	27
10	12	12	-	-	24
11	12	14	-	-	26
12	12	18	-	-	30
13	7	7	7	-	21
14	7	7	9	-	23
15	7	7	12	-	26
16	7	7	14	-	28
17	7	9	9	-	25
18	7	9	12	-	28
19	7	9	14	-	30
20	7	12	12	-	31
21	7	12	14	-	33
22	9	9	9	-	27
23	9	9	12	-	30
24	9	9	14	-	32
25	9	12	12	-	33
26	9	12	14	-	35
27	12	12	12	-	36

# INDOOR UNIT CONNECTION PATTERN (CONT'D)

4 ROOMS - AOTG30LAT4 CONNECTABILITY					
1	7	7	14	-	28
2	7	7	18	-	32
3	7	7	24	-	38
4	7	9	12	-	28
5	7	9	14	-	30
6	7	9	18	-	34
7	7	9	24	-	40
8	7	12	12	-	31
9	7	12	14	-	33
10	7	12	18	-	37
11	7	12	24	-	43
12	7	14	14	-	35
13	7	14	18	-	39
14	7	14	24	-	45
15	7	18	18	-	43
16	7	18	24	-	49
17	9	9	9	-	27
18	9	9	12	-	30
19	9	9	14	-	32
20	9	9	18	-	36
21	9	9	24	-	42
22	9	12	12	-	33
23	9	12	14	-	35
24	9	12	18	-	39
25	9	12	24	-	45
26	9	14	14	-	37
27	9	14	18	-	41
28	9	14	24	-	47
29	9	18	18	-	45
30	12	12	12	-	35
31	12	12	14	-	38
32	12	12	18	-	42
33	12	12	24	-	48
34	12	14	14	-	40
35	12	14	18	-	44
36	12	18	18	-	48
37	7	7	7	7	28
38	7	7	7	9	30
39	7	7	7	12	33
40	7	7	7	14	35
41	7	7	7	18	39
42	7	7	9	9	32
43	7	7	9	12	35
44	7	7	9	14	37
45	7	7	9	18	41
46	7	7	12	12	38
47	7	7	12	14	40
48	7	7	12	18	44
49	7	7	14	14	42
50	7	9	9	9	34
51	7	9	9	12	37
52	7	9	9	14	39
53	7	9	9	18	43
54	7	9	12	12	40
55	7	9	12	14	42
56	7	9	12	18	46
57	7	9	14	14	44
58	7	12	12	12	43
59	7	12	12	14	45
60	7	12	12	18	49
61	7	12	14	14	47
62	9	9	9	9	36
63	9	9	9	12	39
64	9	9	9	14	41
65	9	9	9	18	45
66	9	9	12	12	42
67	9	9	12	14	44
68	9	9	12	18	48
69	9	9	14	14	46
70	9	12	12	12	45
71	9	12	12	14	47
72	9	12	14	14	49
73	12	12	12	12	48

**3 room notes:**

7: 7000Btu/h, 9: 9000Btu/h, 14: 14000Btu/h, 18: 18000Btu/h models

**4 room notes:**

7: 7000Btu/h, 9: 9000Btu/h, 14: 14000Btu/h, 18: 18000Btu/h, 24: 24000Btu/h models

# INVERTER MULTI SYSTEMS

TYPE	MODEL	UNITS	WALL MOUNTED – DESIGNER RANGE				
			ASTG09LUCB		ASTG14LUCB		
Model No.	Indoor Unit Outdoor Unit		AOTG24LAT3	AOTG30LAT4	AOTG24LAT3	AOTG30LAT4	
Reverse Cycle System			Yes		Yes		
Capacity Class			2.5		4.0		
Cooling Capacity		kW	2,700	2,700	4,200	4000	
		BTU/h	9,220	9,220	14,343	13,660	
Range (Maximum for Inverter Multi)		Watts	3,300	3,400	4,800	4,500	
		BTU/h	11,270	11,611	16,392	15,368	
Heating Capacity		Watts	3,300	3,300	4,800	4,800	
		BTU/h	11,270	11,270	16,392	16,392	
Range (Maximum for Inverter Multi)		Watts	4,200	3,700	5,800	5,800	
		BTU/h	14,343	12,636	19,808	19,808	
Power Supply		Volts	240		240		
Phase-Frequency		Ph- Hz	1-50		1-50		
Power Supply Attachment			Outdoor		Outdoor		
Plug Size (If Applicable)			NA		NA		
Running Current	Cooling Range Heating Range	Amps	0.14		0.2		
Input	Cooling Range Heating Range	Watts	16		23		
Moisture Removal		l/hr					
E.E.R.	Cooling		-	-	-	-	
C.O.P.	Heating		-	-	-	-	
Star Rating	Cooling Heating		-	-	-	-	
Fan Speeds			4		4		
Air Circulation	High	l/s	167		197		
Compressor Type			DC Twin Rotary	DC Twin Rotary	DC Twin Rotary	DC Twin Rotary	
Dimensions and Weights	I.U. mm	Height	282		292		
		Width	870		870		
		Depth	185		185		
	O.U. mm	Net Weight	kg	9.5		9.5	
		Height	700	830	700	830	
		Width	900	900	900	900	
Net Weight	Depth	330	330	330	330		
	kg	55	68	55	68		
I.U. Sound Pressure Level		dBa@1metre	36		41		
O.U. Sound Pressure Level			48	50	48	50	
O.U. Sound Power Level		dBa	64	64	64	64	
Refrigerant	Type		R410A		R410A		
Connection Pipe Sizes	Gas	mm	9.52		12.7		
	Liquid		6.35		6.35		
Pre Charged Length			-		-		
Minimum Pipe Length			5		5		
Maximum Pipe Length per unit Inverter Multi only		Metre	-		-		
Maximum Pipe Length			25		25		
Maximum Pipe Height			10		10		
Pipe Connection Methods			Flare	Flare	Flare	Flare	
Outdoor operating Temp	Cooling	Degrees C	-10 to 46	0 to 46	-10 to 46	0 to 46	
	Heating		-15 to 24	-10 to 24	-15 to 24	-10 to 24	





# INVERTER MULTI SYSTEMS (CONT'D)

TYPE	MODEL	UNITS	COMPACT WALL MOUNTED						WALL	
			ASTG07LVCA		ASTG09LVCC		ASTG12LVCC		ASTG18LVCA	
Model No.	Indoor Unit		AOTG24LAT3	AOTG30LAT4	AOTG24LAT3	AOTG30LAT4	AOTG24LAT3	AOTG30LAT4	AOTG24LAT3	AOTG30LAT4
Reverse Cycle System			Yes		Yes		Yes		Yes	
Capacity Class		kW	2		2.5		3.5		5	
Cooling Capacity		Watts	2,300	2,300	2,700	2,700	3,500	3,500	5,000	5,200
		BTU/h	7,854	7,854	9,220	9,220	11,953	11,953	17,075	17,758
Range (Maximum for Inverter Multi)		Watts	2,700	2,700	3,300	3,400	3,700	3,800	5,600	6,000
		BTU/h	9,220	9,220	11,270	11,611	12,636	12,977	19,125	20,491
Heating Capacity		Watts	2,700	2,700	3,300	3,300	3,800	3,800	6,000	6,000
		BTU/h	9,220	9,220	11,270	11,270	12,977	12,977	20,491	20,491
Range (Maximum for Inverter Multi)		Watts	3,300	3,300	4,200	3,700	4,800	4,500	7,100	7,100
		BTU/h	11,270	11,270	14,343	12,636	16,392	15,368	24,247	24,247
Power Supply		Volts	240		240		240		240	
Phase-Frequency		Ph- Hz	1-50		1-50		1-50		1-50	
Power Supply Attachment			Outdoor		Outdoor		Outdoor		Outdoor	
Plug Size (If Applicable)			NA		NA		NA		NA	
Running Current	Cooling	Amps	0.14		0.14		0.16		0.33	
	Range Heating									
	Range Heating									
Input	Cooling	Watts	16		16		19		37	
	Range Heating									
	Range Heating									
Moisture Removal		l/hr								
E.E.R.	Cooling		-	-	-	-	-	-	-	-
C.O.P.	Heating		-	-	-	-	-	-	-	-
Star Rating	Cooling		-	-	-	-	-	-	-	-
	Heating		-	-	-	-	-	-	-	-
Fan Speeds			4		4		4		4	
Air Circulation	High	l/s	178		178		194		250	
Compressor Type			DC Twin Rotary	DC Twin Rotary	DC Twin Rotary	DC Twin Rotary	DC Twin Rotary	DC Twin Rotary	DC Twin Rotary	DC Twin Rotary
Dimensions and Weights	I.U. mm	Height	293		293		293		320	
		Width	790		790		790		998	
		Depth	225		225		225		238	
	Net Weight	kg	9.5		9.5		9.5		14	
	O.U. mm	Height	700	830	700	830	700	830	700	830
		Width	900	900	900	900	900	900	900	900
		Depth	330	330	330	330	330	330	330	330
	Net Weight	kg	55	68	55	68	55	68	55	68
I.U. Sound Pressure Level			36		36		38		43	
O.U. Sound Pressure Level		dB@1metre	48	50	48	50	48	50	48	50
O.U. Sound Power Level		dB	64	64	64	64	64	64	64	64
Refrigerant	Type		R410A		R410A		R410A		R410A	
Connection Pipe Sizes	Gas	mm	9.52		9.52		9.52		12.7	
	Liquid		6.35		6.35		6.35		6.35	
Pre Charged Length			-		-		-		-	
Minimum Pipe Length			5		5		5		5	
Maximum Pipe Length per unit Inverter Multi only		Metre	-		-		-		-	
Maximum Pipe Length			25		25		25		25	
Maximum Pipe Height			10		10		10		10	
Pipe Connection Methods			Flare	Flare	Flare	Flare	Flare	Flare	Flare	Flare
Outdoor operating Temp	Cooling	Degrees C	-10 to 46	0 to 46	-10 to 46	0 to 46	-10 to 46	0 to 46	-10 to 46	0 to 46
	Heating		-15 to 24	-10 to 24	-15 to 24	-10 to 24	-15 to 24	-10 to 24	-15 to 24	-10 to 24

\* Specifications for each indoor unit listed is subject to the outdoor unit which it is connected to. Please consult a Fujitsu stockist for further information.



MOUNTED		COMPACT CASSETTE						FLOOR CEILING		OUTDOOR UNIT	
ASTG24LFCC		AUTG09LVLA		AUTG12LVLA		AUTG18LVLA		ABTG18LVTA		-	
AOTG24LAT3	AOTG30LAT4	AOTG24LAT3	AOTG30LAT4	AOTG24LAT3	AOTG30LAT4	AOTG24LAT3	AOTG30LAT4	AOTG24LAT3	AOTG30LAT4	AOTG24LAT3	AOTG30LAT4
Yes	7	Yes	2.5	Yes	3.5	Yes	5	Yes	5	-	Yes
-	6,800	2,700	2,700	3,500	3,500	5,000	5,200	5,000	5,200	6,800	8,000
-	23,223	9,220	9,220	11,953	11,953	17,075	17,758	17,075	17,758	23,200	27,300
-	7,400	3,300	3,400	3,700	3,800	5,600	6,000	5,600	6,000	1,800-8,500	3,500-10,100
-	25,272	11,270	11,611	12,636	12,977	19,125	20,491	19,125	20,491	6,100-29,000	11,940-34,500
-	8,200	3,300	3,300	3,800	3,800	6,000	6,000	6,000	6,000	8,000	9,600
-	28,004	11,270	11,270	12,977	12,977	20,491	20,491	20,491	20,491	27,300	32,800
-	9,000	4,200	3,700	4,800	4,500	7,100	7,100	7,100	7,100	2,000-9,200	3,700-12,000
-	30,736	14,343	12,636	16,392	15,368	24,247	24,247	24,247	24,247	6,800-31,400	12,620-41,000
240		240		240		240		240		240	
1-50		1-50		1-50		1-50		1-50		1-50	
Outdoor		Outdoor		Outdoor		Outdoor		Outdoor		Outdoor	
NA		NA		NA		NA		NA		NA	
0.53		0.15		0.19		0.3		0.36		8.1	9.3
										Max 10.9	Max 15.0
										8.4	10.1
										Max 12.1	Max 15.0
										1,940	2,220
69		18		23		39		47		Max 2,600	Max 3,560
										2,000	2,400
										Max 2,870	Max 3,580
-	-	-	-	-	-	-	-	-	-	3.5	3.6
-	-	-	-	-	-	-	-	-	-	4	4
-	-	-	-	-	-	-	-	-	-	-	-
-	-	-	-	-	-	-	-	-	-	-	-
4		4		4		4		4		2	2
311		150		169		208		217		917	972
DC Twin Rotary	DC Twin Rotary	DC Twin Rotary	DC Twin Rotary	DC Twin Rotary	DC Twin Rotary	DC Twin Rotary	DC Twin Rotary	DC Twin Rotary	DC Twin Rotary	DC Twin Rotary	DC Twin Rotary
320		245 (49)		245 (49)		245 (49)		199		-	-
998		570 (700)		570 (700)		570 (700)		990		-	-
238		570 (700)		570 (700)		570 (700)		655		-	-
14		15 (2.6)		15 (2.6)		15 (2.6)		27		-	-
700	830	700	830	700	830	700	830	700	830	700	830
900	900	900	900	900	900	900	900	900	900	900	900
330	330	330	330	330	330	330	330	330	330	330	330
55	68	55	68	55	68	55	68	55	68	55	68
49		33		37		42		41 (UC)/44 (FC)		-	-
48	50	48	50	48	50	48	50	48	50	48	50
64	64	64	64	64	64	64	64	64	64	64	64
R410A		R410A		R410A		R410A		R410A		R410A	R410A
15.88		9.52		9.52		12.7		12.7		2x 9.52, 1x 12.7	2x 9.52, 2x 12.7
6.35		6.35		6.35		6.35		6.35		3x 6.35	4x 6.35
-		-		-		-		-		30	50
5		5		5		5		5		15	20
-		-		-		-		-		25	25
25		25		25		25		25		Max Total 50	Max Total 70
10		10		10		10		10		15 (IU to OU)	15 (IU to OU)
Flare	Flare	Flare	Flare	Flare	Flare	Flare	Flare	Flare	Flare	Flare	Flare
-10 to 46	0 to 46	-10 to 46	0 to 46	-10 to 46	0 to 46	-10 to 46	0 to 46	-10 to 46	0 to 46	-10 to 46	0 to 46
-15 to 24	-10 to 24	-15 to 24	-10 to 24	-15 to 24	-10 to 24	-15 to 24	-10 to 24	-15 to 24	-10 to 24	-15 to 24	-10 to 24



Products in this brochure contain R410A refrigerant. Please refer to specifications before installation & servicing this product.

Only persons and/or companies qualified and experienced in the installation, service and repair of refrigerant products should be permitted to do so. The purchaser must ensure that the person and/or company who is to install, service or repair this air conditioner has qualifications and experience in refrigerant products.

Suitable access for warranty & service is required.

For future improvement, specifications, designs of product and availability are subject to change without notice. Please check with your dealer.

All Capacity and Energy Efficiency ratings are based on AS/NZS3823.2.

Cooling Indoor Temp: 27°C DB/19°C WB  
Outdoor Temp: 35°C DB

Heating Indoor Temp: 20°C DB  
Outdoor Temp: 7°C DB /6°C WB

Running current is at rated conditions (AS3823) and does not include compressor start-up or variations in power supply and load conditions.

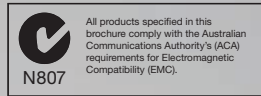

# FUJITSU COMFORT

AUSTRALIA'S FAVOURITE AIR™

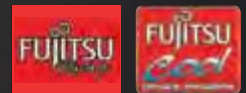

## FUJITSU GENERAL (AUST.) PTY LIMITED

ABN 55 001 229 554  
A Subsidiary of FUJITSU GENERAL LIMITED  
www.fujitsugeneral.com.au

### HEAD OFFICE

**NSW** Eastern Creek Drive, Eastern Creek NSW 2766 TEL (02) 8822 2500 FAX (02) 8822 2501

**VIC/TAS** Suite 1, Building 2, Omnicore Business Centre, 270 Ferntree Gully Road, Notting Hill VIC 3168 TEL (03) 9543 5899 FAX (03) 9543 8299

**QLD** 1 Breakfast Creek Road, Newstead QLD 4006 TEL (07) 3257 2800 FAX (07) 3257 2184

**SA/NT** 128A Rose Terrace, Wayville SA 5034 TEL (08) 8172 1180 FAX (08) 8172 1190

**WA** Suite 3, 5 Mumford Place, Balcatta WA 6021 TEL (08) 9240 5877 FAX (08) 9240 5866

E-mail: [contact@fujitsugeneral.com.au](mailto:contact@fujitsugeneral.com.au) - or call 1300 882 201

Distributed by:

