

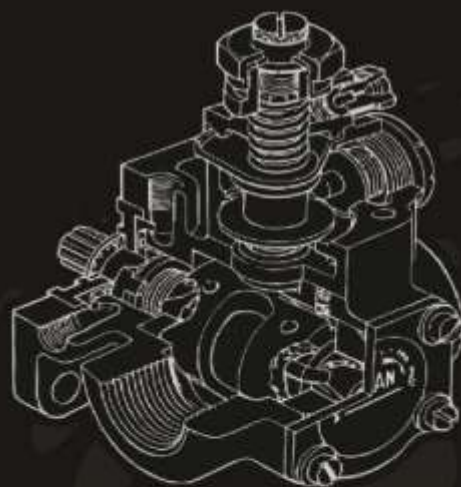

# Acca Accesorios

Accesorios Automotrices y Ferreteros

**2021**



Catalogo de Productos

# CUBRE VOLANTES ACCA

**COLOR NEGRO Y BEIGE.**

**CÓDIGO: A-04-WB**

Toma el control de tu conducción, con este increíble cubre volante ACCA, el complemento que hace de tu camino un trayecto fantástico para disfrutar.

Para volantes de 14.5" a 15.5" este cubre volante es de muy buena calidad, cocido.



**BEIGE MADERA CLARA.**

**CÓDIGO: A-02-BG**

Proporciona un mejor agarre en el volante mientras conduce proporciona comodidad y protección para las manos en temperaturas extremas.

Compare CALIDAD/PRECIO, fotos reales.



**NEGRO MADERA OSCURA**

De fácil colocación. **CÓDIGO: A-01-WB**

Totalmente garantizado.





# CUBRE VOLANTES ACCA



ACCA  
ACCESORIOS

POR QUE PENSAMOS QUE TU COMODIDAD  
ES  
IMPORTANTE TE PRESENTAMOS LOS NUE-  
VOS  
**CUBRE VOLANTES ACCA** QUE TE BRINDAN  
UN BUEN AGARRE Y COMODIDAD PARA  
LARGOS  
VIAJES.

**\*FÁCIL DE LIMPIAR E INSTALAR, SIN  
DEFORMACION, ALTA RESISTENCIA AL  
DESGASTE.**

**CÓDIGO**

**ACCA-62250BK**

COLOR:  
NEGRO



ACCA  
ACCESORIOS

COLOR:  
GRIS

**CÓDIGO**

**ACCA-62250GR**



ACCA  
ACCESORIOS

COLOR:  
ROJO

**CÓDIGO**

**ACCA-62250RD**



ACCA  
ACCESORIOS

COLOR:  
BEIGE

**CÓDIGO**

**ACCA-62250BG**



ACCA  
ACCESORIOS

COLOR:  
CAMELLO

**CÓDIGO**

**ACCA-62250CM**





# CUBRE VOLANTES



ACCA  
ACCESORIOS

**POR QUE PENSAMOS QUE TU COMODIDAD ES IMPORTANTE TE PRESENTAMOS LOS NUEVOS CUBRE VOLANTES ACCA QUE TE BRINDAN UN BUEN AGARRE Y COMODIDAD PARA LARGOS VIAJES.**

**\*FÁCIL DE LIMPIAR E INSTALAR, SIN DEFORMACION, ALTA RESISTENCIA AL DESGASTE.**

**CÓDIGO**

ACCA-62251BK

**COLOR:  
NEGRO**



ACCA  
ACCESORIOS

**COLOR:  
GRIS**

**CÓDIGO**

ACCA-62251GR



ACCA  
ACCESORIOS

**COLOR:  
ROJO**

**CÓDIGO**

ACCA-62251RD



ACCA  
ACCESORIOS

**COLOR:  
BEIGE**

**CÓDIGO**

ACCA-62251BG



ACCA  
ACCESORIOS

**COLOR:  
CAMELLO**

**CÓDIGO**

ACCA-62251CM



## CUBRE VOLANTE CON COSTURA

**NEGRO/ROJO**



**ACCA-62254BK**

**GRIS**



**ACCA-62254GR**

**BEIGE**



**ACCA-62254BG**



## CUBRE VOLANTES

**BLANCO**



**ACCA-62265WT**

**ROJO**



**ACCA-62265RD**

**AZUL**



**ACCA-62265BL**



## CUBRE VOLANTE

**BEIGE**



**ACCA-62267BG**

**GRIS**



**ACCA-62267GR**

**NEGRO**



**ACCA-62267BK**



## FOCOS AMBAR



CÓDIGO	COLOR
ACCA-3157A	AMBAR

2 POLO. CAJA CON 10.

## FOCOS AMBAR



CÓDIGO	COLOR
ACCA-194A	AMBAR

2 POLO. CAJA CON 10.

## FOCOS CLAROS



CAJA CON 10.  
1 POLO.



CÓDIGO	COLOR
ACCA-7440	CLARO

## FOCOS AMBAR



CAJA CON 10.



CÓDIGO	COLOR
ACCA-1157A	AMBAR

## FOCOS CLAROS



CÓDIGO	COLOR
ACCA-3157	CLARO

CAJA CON 10.



CÓDIGO	COLOR
ACCA-7443	CLARO

CAJA CON 10.

## FOOSMIN



ACCA  
ACCESORIOS



CÓDIGO	COLOR
ACCA-1141	CLARO

1 POLO. CAJA CON 10.



ACCA  
ACCESORIOS



CÓDIGO	COLOR
ACCA-1157	CLARO

2 POLO. CAJA CON 10.

## FOOSMIN.



ACCA  
ACCESORIOS



CÓDIGO	COLOR
ACCA-194	CLARO

1 POLO. CAJA CON 10.



ACCA  
ACCESORIOS



CÓDIGO	COLOR
ACCA-921	CLARO

1 POLO. CAJA CON 10.

## FOOSCLAROS



ACCA  
ACCESORIOS



CÓDIGO	COLOR
ACCA-H4	CLARO



ACCA  
ACCESORIOS



CÓDIGO	TIPO
ACCA-9005	ALTAS
ACCA-9006	BAJAS



## FOCOS HALOGENO H11 AZUL



## FOCOS HALOGENO H4 AZUL



## FOCOS CLAROS



## FOCOS CLAROS





**GUANTES MULTIUSOS  
JARDINERIA  
CONSTRUCCIÓN  
MECANICA  
ENTRE OTROS.**

CÓDIGO	TAMAÑO
ACCA-90106A-S	S
ACCA-90106A-M	M
ACCA-90106A-L	L
ACCA-90106A-XL	XL

## FUSBLES TIPO MUELA



MINI TIPO MUELA	
AMPE-RAJE	CODIGO
20	AZUL-HM
30	ROSA-HM
40	VERDE-HM
60	AMARILLO-HM



## FUSBLES TIPO MUELA



HEMBRA	
AMPE-RAJE	CODIGO
20	BLANCO-H
30	ROSA-H
40	VERDE-H
60	AMARILLO-H



## FUSBLES TIPO MUELA



MACHO	
AMPE-RAJE	CODIGO
30	ROSA-M
50	ROJOM
60	AMARILLO-M
80	NEGRO-M
100	AZUL-M
12	CAFÉ-M





## TAPETES DE HULE



ACCA  
ACCESORIOS

TAPETES DE HULE TODA TEMPORADA, RECORTABLES PARA AUTOS Y CAMIONETAS.



ACCA  
ACCESORIOS

TAPETES DE HULE TODA TEMPORADA, RECORTABLES PARA AUTOS Y CAMIONETAS.



## CABLE PARA PASAR CORRIENTE ACCA



ACCA  
ACCESORIOS

CON PROTECCION MORDAZAS PLASTICAS.

CALIBRE: 2

CODIGO	MEDIDA	AMP
ACCA-5240-200A	2.5M	200
ACCA-5240-400A	3.5M	400
ACCA-5240	3	600

## PROBADORES DE CORRIENTE



PRUEBA FUSIBLES LOCALIZA CORTOS CIRCUITOS

PARA USO EN CARROS, CAMIONES, BARCOS, TRAILERS, VANS, Y OTROS

6-12V



CÓDIGO

CT046



PARA USO PESADO

PRUEBA FUSIBLES LOCALIZA CORTOS CIRCUITOS

PARA USO EN CARROS, CAMIONES, BARCOS, TRAILERS, VANS, Y OTROS

6-12V HD



ACCA  
ACCESORIOS

CÓDIGO

BT018

## CRUCETAS



**MEDIDAS:**  
11/16" 3/4" 3/16" 7/8"  
20"

ACCA  
ACCESORIOS

CÓDIGO

TIPO

ACCA-D007C-1

STD



**MEDIDAS:**  
17MM 19MM 23MM 24MM  
14"

ACCA  
ACCESORIOS

CÓDIGO

TIPO

ACCA-D007C-2

MM



ACCA  
ACCESORIOS

## CRUCETAS



ACCA  
ACCESORIOS



ACCA  
ACCESORIOS

## RESPALDO DE BOLTA



COLOR: BEIGE

CODIGO

RA008



COLOR: AZUL

CODIGO

RA007



COLOR: GRIS

CODIGO

RA006



COLOR: NEGRO

CODIGO

RA005



## GUANTES DE NITRILO HD



NAVY DUTY  
USA



ACCA  
ACCESORIOS



L

66518

## GUANTES DE NITRILO



ACCA  
ACCESORIOS

BATERIA DE ALTA  
DURACION.

CÓDIGO

AA2



## BOCINA CARACOL JUEGOSIN TAPA Y SIN REJILLA



### BOCINA CARACOL C/RELAY ROJA 12V



CÓDIGO

ZH-121

## TAPE DOBLE CARA



### IDEAL PARA MONTAR CUADROS, Y DECORACIONES.

CÓDIGO

109015

## SILICONA RTV GRIS



ACCA ACCESORIOS

PARA USO UNIVERSAL RESISTE GRASA Y ACEITE PARA TEMPERATURAS DE -60°C A +320°C IDEAL PARA CARTER Y PIEZAS DE ALUMINIO

CÓDIGO

700-EE

## DESENGRASANTE



ACCA ACCESORIOS

NO FLAMABLE NO ABRASIVO LIBRE DE FOSFATO Y BIODEGRADABLE CONCENTRADO FUERZA INDUSTRIAL. PARA USO: AUTOMOTRIZ MARINO HOGAR

Contenido: 32oz

CÓDIGO

9915P

## FILTRO DE GASOLINA UNIVERSAL



ACCA ACCESORIOS

PARA TODO TIPO DE VEHICULO INCLUYE TROZO DE MANGUERA Y ABRAZADERA.

CÓDIGO

06817

## PROBADOR DE CORRIENTE 6-12V



ACCA ACCESORIOS

PARA USO EN CARROS, CAMIONES, BARCOS, TRAILERS, VANS, Y OTROS USALO PARA CHECAR CIRCUITOS ELECTRICOS Y ACCESORIOS EN TODO 6-12V CABLE EXTENSIBLE HASTA 12FT.

CÓDIGO

CHIT0047

## ABRAZADERAS METALICAS



CÓDIGO	MEDIDA	CÓDIGO	MEDIDA
SC4	7/32" A 5/16"	CC20	15/16" A 1 3/4"
SC6	1/2" A 15/16"	CC24	1 1/16" A 2"
CC8	1/2" A 29/32"	CC28	1 5/16" A 2 9/32"
CC10	9/16" A 1 1/16"		
CC12	11/16" A 1 1/4"		
CC16	13/16" A 1 1/2"		

## BOLA DE JALON

MEDIDA 2"X3/4" X2-1/2"



CAPACIDAD: 3500LB



CÓDIGO

TAIH0040

## MAN TELESCOPO 5LB



EXTENDIBLE DE 5" A 24"  
CABEZA DE 1/2" DE DIAMETRO  
IDEAL PARA AGARRAR COSAS DE  
AREAS NO ACCESIBLES.



CÓDIGO

CHIP4400

## MANQUERA P GASOLINA

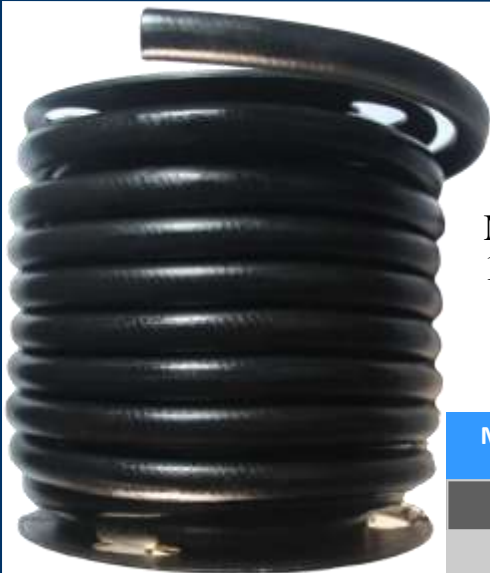

Medida:  
14 Metros



MEDIDA CODIGO

5/16" FLH5/16

3/8" FLH3/8

## ANTICONGELANTE SIBERIA



Capacidad:  
1 GALON



CODIGO COLOR

ANT-V VERDE

ANT-R ROSA

FORRO DE VOLANTE



ACCA  
ACCESORIOS

CÓDIGO

FV198A

FORRO DE VOLANTE



ACCA  
ACCESORIOS

CÓDIGO

FV148A

FORRO DE VOLANTE



ACCA  
ACCESORIOS

CÓDIGO

FV039A

FORRO DE VOLANTE



ACCA  
ACCESORIOS

CÓDIGO

FV147A

FORRO DE VOLANTE



ACCA  
ACCESORIOS

CÓDIGO

FV521A

FORRO DE VOLANTE



ACCA  
ACCESORIOS

CÓDIGO

FV196A



## FORRO DE VOLANTE



ACCA  
ACCESORIOS

CÓDIGO

FV040A

## FORRO DE VOLANTE



ACCA  
ACCESORIOS

CÓDIGO

FV315A

## FOCO CLARO

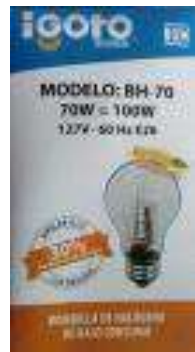

ACCA  
ACCESORIOS

CÓDIGO

BH-70

## GANTES DE NITRILO



ACCA  
ACCESORIOS

## ROLLO DE LEDS 16 pies



ACCA  
ACCESORIOS

CÓDIGO

COLOR

T-LED-B

BLANCO

T-LED-A

AZUL

T-LED-RJ

ROJO

## CUBRE VOLANTE VINIL BRONX "LISO"



CÓDIGO	COLOR
FV149A	NEGRO
FV150A	GRIS
FV151A	BEIGE

## CUBRE VOLANTE NEGRO LINEAS



CÓDIGO

FV110A

## CUBRE VOLANTE LIZO NEGRO



CÓDIGO

FV146A

## CUBRE VOLANTES LISOS



CÓDIGO	COLOR
CHIWS0031	BEIGE
CHIWS0032	NEGRO
CHIWS0033	GRIS

## CUBRE VOLANTE BEGE LINEAS



CÓDIGO

FV-BG

## CUBRE VOLANTE VINIL NEGRO



CÓDIGO

FV-BK

## CUBRE VOLANTE VINIL BEIGE NEGRO



CÓDIGO

FV-BG/BK

## CUBRE VOLANTE NEGRO BRONX



CÓDIGO

FV297A



## CUBRE VOLANTE CON LOGO ORIGINAL (OFICIAL)



ORIGINAL CHEVROLET  
ELITE  
CÓDIGO: PTC-6727



ORIGINAL CHEVROLET  
CÓDIGO: PTC-6446



DE FORD NEGRO LETRAS ROJAS  
CÓDIGO: PTC-6714



DE CHEVROLET  
CÓDIGO: PTC-6334



DE DODGE  
CÓDIGO: PTC-6447



DE FORD  
CÓDIGO: PTC-6333



DE JEEP NEGRO LETRAS  
BLANCAS  
CÓDIGO: PTC-6729



DE DODGE ELITE  
CÓDIGO: PTC-6451



5 EN 1 ACCESORIOS CON CUBRE VOLANTE, TOPONES PARA VÁLVULAS, CUBRE PEDAL P/ AUTOMÁTICO, PUÑO PA-

CÓDIGO	COLOR
20-350-RED	ROJO
20-350-BLUE	AZUL
20-350-BLACK	NEGRO
20-350-SILVER	PLATEADO

## FIGURA DE CALavera PARA

## CUBRE VOLANTE ED HARDY



CÓDIGO	FIGURA
5072763	TIGRE

CÓDIGO	COLOR
PU-3424	PIRATA DRAGON ROJO

# CUBRE VOLANTES DEPORTIVO



NEGRO CON GRIS  
Y 3 CUADRICULAS  
CÓDIGO: A-03-GR



NEGRO  
Y 3 CUADRICULAS  
CÓDIGO: A-03-BK



NEGRO CON BEIGE  
Y 3 CUADRICULAS  
CÓDIGO: A-03-BG



NEGRO CON MADERA  
OBSCURA  
CÓDIGO: A-01-WB



BEIGE CON MADERA  
OBSCURA  
CÓDIGO: A-01-BD



GRIS CON MADERA  
OBSCURA  
CÓDIGO: A-01-GR



NEGRO CON  
MADERA CLARA  
CÓDIGO: A-02-BK



BEIGE CON MADERA  
CLARA  
CÓDIGO: A-02-BG



GRIS CON MADERA  
CLARA  
CÓDIGO: A-02-GR



IMITACION PIEL FRANJA  
ROJA  
CÓDIGO: SW-762-RD



IMITACION PIEL FRANJA  
AZUL  
CÓDIGO: SW-762-BL



IMITACION PIEL FRANJA  
PLATEADA  
CÓDIGO: SW-762-SL





# CUBRE VOLANTES DEPORTIVOS



CÓDIGO	COLOR
SW-240-BK	NEGRO
SW-240-BG	BEIGE
SW-240-GR	GRIS



CUBRE VOLANTE BEIGE  
PELUCHE CÓDIGO:  
SW241-BG



CUBRE VOLANTE GRIS ESPONJOSO  
CÓDIGO: SW-237-GR



CUBRE VOLANTE NEGRO ESPONJOSO  
CÓDIGO: SW-237-BK



CUBRE VOLANTE BEIGE ESPONJOSO  
CÓDIGO: SW-237-BG



CUBRE VOLANTE GRIS DEPORTIVO  
CON FLECHA  
CÓDIGO: SW-306-GR



CUBRE VOLANTE NEGRO  
DEPORTIVO CON  
FLECHA  
CÓDIGO: SW-306-BK



CUBRE VOLANTE BEIGE  
DEPORTIVO CON  
FLECHA  
CÓDIGO: SW-306-BG



CUBRE VOLANTE GRIS TIPO PIEL DE VIBORA  
CÓDIGO: SW-309-GR



CUBRE VOLANTE NEGRO TIPO PIEL VIBORA  
CÓDIGO: SW-309-BK



CUBRE VOLANTE BEIGE TIPO PIEL VIBORA  
CÓDIGO: SW-309-BG



## CUBRE VOLANTES LIZOS



MADERA OSCURA  
CÓDIGO: A-01-BK



BEIGE  
CÓDIGO: SW-230-BG



NEGRO  
CÓDIGO: SW-230-BK



GRIS  
CÓDIGO: SW-230-GR

## CUBRE VOLANTES DE BOLTAS



NEGRO  
CÓDIGO: SW-202-BK



NEGRO/GRIS  
CÓDIGO: SW-202-GR



CÓDIGO: SW-235-BK

## PIEL GENUINA. MODELO COSTILLA. 13.5"



COLOR NEGRO  
CÓDIGO: SW-899S-BK



COLOR NEGRO  
CÓDIGO: SW-899S-GR



COLOR NEGRO  
CÓDIGO: SW-899S-BG

**SPORT SMALL 13.5"**



**CÓDIGO: SW-708-GR**



**COLOR NEGRO  
CÓDIGO: SW-709-BB-S**



**COLOR NEGRO  
CÓDIGO: SW-761-BK-S**

**CUBRE VOLANTES LIBRE OLORES**



**COLOR BEIGE  
CÓDIGO: SW-806-BG**



**COLOR BEIGE  
CÓDIGO: SW-806-BG-S**

**CUBRE VOLANTE MENSAJE**



**MASAJE MADERA  
CÓDIGO: 87038**



**CÓDIGO: 87030**



**MASAJE GRIS  
CÓDIGO: 87032**



**MASAJE AZUL  
CÓDIGO: 87034**



## CUBRE VOLANTES PARA TRAILER 18"



CÓDIGO: SW-351-BK

CÓDIGO: SW-351-BG

CÓDIGO: SW-351-GR

CÓDIGO: SW-352-DW

## PROTECTOR SOLAR PARA TABLERO

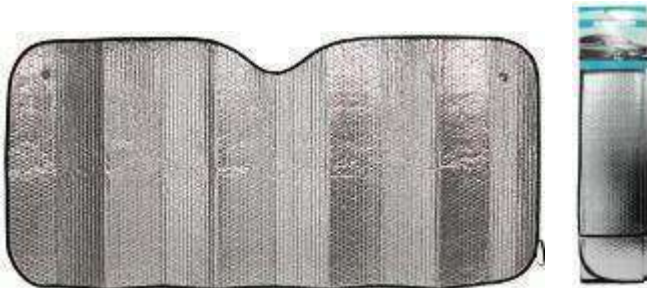

CORTINA LATERAL PARA AUTO  
CON MALLA ESTÁTICA QUE SE ADIERE  
AL VIDRIO SIN NECESIDAD DE VENTOSA.

**PAQUETE CON 2PZS**  
**DE 15" X 17"**

CÓDIGO: SS-002

- CALIDAD PREMIUM
- MANTIENE EL AUTOMOVIL FRESCO
- FACIL DE MANEJAR Y GUARDAR

CÓDIGO	MEDIDA
AS-216	JUMBO (1.70m x 67cm)
AS-215	GRANDE (1.40m x 60cm)



CORTINA LATERAL PARA AUTO  
CON VENTOSA.

**PAQUETE CON 2PZS**  
**DE 15" X 17"**



PROTECTOR SOLAR PARA TABLERO SMILE CAR.  
TAMAÑO ESTANDAR 50.5 X 24 PULGADAS.

CÓDIGO: AS-130



## MOSQUITERA MAGNETICA



CODGIGO CHIM0055



## TAPETE VINIL CON 4pzs



TRANSPARENTE

CÓDIGO: 1230



COLOR VINO

CÓDIGO: 1234



COLOR NEGRO  
SMOCK

CÓDIGO: 1235



DE LAS CHIVAS  
CÓDIGO:  
FMMT-1182



DEL AMERICA  
CÓDIGO:  
FMMT-1282

## TAPETE VINIL CON 4pzs PARA MINI



COLOR ROJO  
TRANSPARENTE  
CÓDIGO: 67-363

## TAPETE DE PVC CON 4 pzs



COLOR GRIS.  
CÓDIGO: MT-654-GY

COLOR CLEAR.  
CÓDIGO: MT-654-CL



COLOR BEIGE  
CÓDIGO: MT-654-BG

COLOR NEGRO.  
CÓDIGO: MT-654-BK



## TAPETE DE PVC CON 3pzs (2 FRONTALES Y 1CORRIDO)



COLOR GRIS  
CÓDIGO:  
MT-783-GR



COLOR BEIGE  
CÓDIGO:  
MT-783-BG



COLOR NEGRO  
CÓDIGO:  
MT-783-BK



COLOR  
TRANSPARENTE  
CÓDIGO:  
MT-783-CL



## TAPETE DE PVC CON 3pzs (2 FRONTALES Y 1 CORRDO)

PARA CAMIONETAS, VANS Y PICK-UPS



COLOR GRIS  
CÓDIGO:  
MT-713-GR



COLOR BEIGE  
CÓDIGO:  
MT-713-BG



COLOR NEGRO  
CÓDIGO:  
MT-713-BK

## TAPETE VINL CORRDO 1pz



TRANSPARENTE  
CÓDIGO:  
MT-781-CL

## TAPETE DE PVC 1pz CORRDO

ESTE JUEGO DE TAPETES SE PUEDE COMBINAR CON LOS JUEGOS DE TAPETE DE PVC C/ 3PZS. (2 FRONTALES Y 1 CORRDO) CON LOS CODIGOS: MT-783-COLOR



BEIGE  
CÓDIGO: MT-781-BG



NEGRO  
CÓDIGO: MT-781-BK



GRIS  
CÓDIGO: MT-781-GR

## TAPETE DE PVC 1pz LARGO CORRDO

ESTE JUEGO DE TAPETES SE PUEDE COMBINAR CON LOS JUEGOS DE TAPETE DE PVC C/ 3PZS. (2 FRONTALES Y 1 CORRDO) PARA CAMIONETAS, VANS Y PICK-UPS CON LOS CODIGOS: MT-713-COLOR



BEIGE  
CÓDIGO: MT-711-BG



NEGRO  
CÓDIGO: MT-711-BK



GRIS  
CÓDIGO: MT-711-GR

## JUEGO DE TAPETE DE HULE DE 3 PIEZAS



COLOR GRIS  
CÓDIGO:TAP-263G



COLOR BEIGE CÓDI-  
GO: TAP-263B





# TAPETES DE PVC GRANDES DE 4 Y 3 pzs



TAPETE PVC 4PZAS  
CÓDIGO: MT-634-BK



TAPETE PVC 4PZAS  
CÓDIGO: MT-681-GR



TAPETE PVC 4PZAS  
CÓDIGO: MT-690-GY



TAPETE PVC 4PZAS  
CÓDIGO: MT-774-BG



TAPETE PVC 4PZAS  
CÓDIGO: MT-921-BK



TAPETE PVC 3PZAS  
CÓDIGO: MT-923-GR



TAPETE PVC 3PZAS  
CÓDIGO: MT-883-CL



TAPETE PVC 1PZA  
CÓDIGO: MT-881-CL

# TAPETE DE ALFOMBRA CON 4 PIEZAS



COLOR NEGRO  
CÓDIGO: M001



COLOR CAFE  
CÓDIGO: M002



COLOR ORO  
CÓDIGO: M003



COLOR GRIS CLARO  
CÓDIGO: M004



COLOR ROSA  
CÓDIGO: M005



COLOR AZUL  
CÓDIGO: M006

# TAPETE DE ALFOMBRA CON 4 PIEZAS



COLOR CAFÉ CLARO  
CÓDIGO: M007



COLOR CHARCOAL OSCURO  
CÓDIGO: M010



COLOR GUINDA  
CÓDIGO: M013



COLOR GRIS LIZO  
CÓDIGO: M016



COLOR GRIS BEIGE  
CÓDIGO: M017



COLOR GRIS RATA  
CÓDIGO: M018



# **FOCOS Y SOQUETS**

# FOCO DE HALOGENO CLARO



DE 12Vcc.  
CÓDIGO:  
9004



DE 12Vcc.  
CÓDIGO:  
9005



DE 12Vcc.  
CÓDIGO:  
9005XS



DE 12Vcc.  
CÓDIGO:  
9006



DE 12Vcc.  
CÓDIGO:  
9006XS



DE 12Vcc.  
CÓDIGO:  
9007



DE 12Vcc.  
CÓDIGO:  
H1



DE 12Vcc.  
CÓDIGO:  
H3

DE 12Vcc.  
CÓDIGO:  
H4



DE 12Vcc.  
CÓDIGO:  
H7



DE 12Vcc.  
CÓDIGO:  
H8



DE 12Vcc.  
CÓDIGO:  
H9



DE 12Vcc.  
CÓDIGO:  
H10



DE 12Vcc.  
CÓDIGO:  
H11



H12  
DE 12Vcc.  
CÓDIGO:  
H12



DE 12Vcc.  
CÓDIGO:  
H13



DE 12Vcc.  
CÓDIGO:  
H16



T19 DE 2 POLOS  
PARA MOTO  
CÓDIGO:  
T19



H7 12V  
DE 100W

CÓDIGO:  
H7P-BDK



H1 12V  
DE 100W

CÓDIGO:  
H3-BDK

H1 12V  
DE 100W

CÓDIGO:  
H1-BDK



9005 12V  
DE 100W

CÓDIGO:  
9005-BDK



## FOCO DE HALOGENO PARA FARO DE NIEBLA



880  
DE 12Vcc.  
CÓDIGO:  
880



889  
12Vcc.  
CÓDIGO:  
889



890  
12Vcc.  
CÓDIGO:  
890

## FOCO DE HALOGENO CLARO BDK



H4  
60 / 55W  
CÓDIGO:  
H4P-BDK



9006  
55 W  
CÓDIGO:  
9006P-BDK



9007  
65 / 55W  
CÓDIGO:  
9007P-BDK



SOQUET PARA FOCO 9004 Y 9007  
CÓDIGO: 3794700



SOQUET ORIGINAL DE CHEVROLET  
1 POLO FOCO 1141  
CÓDIGO: 3790500



SOQUET ORIGINAL DE FORD 2 POLOS FOCO  
1157 Y 1034  
CÓDIGO: 3794000



SOQUET ORIGINAL DE FORD  
1 POLO FOCO 1141  
CÓDIGO: 3794200



SOQUET ORIGINAL DE CHEVROLET  
2 POLOS FOCO 1157  
CÓDIGO: 3791000



SOQUET LATERAL PARA DODGE  
FOCO 158 Y 194  
CÓDIGO: 3790000



SOQUET TIPO T"  
1 POLO GRANDE  
USO UNIVERSAL FOCO  
1003 Y 1141  
CÓDIGO: 3802000



SOQUET TIPO L"  
1 POLO GRANDE  
USO UNIVERSAL FOCO  
1003 Y 1141  
CÓDIGO: 3798000



SOQUET TIPO T"  
2 POLOS GRANDE  
USO UNIVERSAL FOCO  
1157 Y 1004  
CÓDIGO: 3804000



SOQUET TIPO L"  
2 POLOS GRANDE  
USO UNIVERSAL FOCO  
1004 Y 1157  
CÓDIGO: 3800000



SOQUET DE PRESION 2 POLOS. PATAS DISPAREJAS 1003 Y 1176  
CÓDIGO: 37780000



SOQUET DE PRESION 1 POLOS PATAS PAREJAS 1003 Y 1141  
CÓDIGO: 37760000



SOQUET DE PRESION 2 POLOS PATAS PAREJAS 1004 Y 1157  
CÓDIGO: 37800000



SOQUET P/FOCO 3157 DIRECCIONAL

CÓDIGO	PARA
37956	BASE ALTA
37957	BASE BAJA



CONECTOR P/REGULADOR CHRYS-  
LER DE 2 PUNTOS.  
CÓDIGO: 14499



ENCHUFE CAMBIO DE PIE MINI  
CHEVROLET  
CÓDIGO: EPCH



SOQUET P/ FOCO 9006.  
CÓDIGO: 37954



CONECTOR PARA REG-  
ULADOR FORD DE 4 PUNTOS.  
CÓDIGO: 14511



SOQUET UNIVERSAL PARA FOCOS 1034 Y 1141  
CÓDIGO: 77816



SOQUET PARA FOCO 9005.  
CÓDIGO: 37951



ENCHUFE CAMBIO DE PIE MINI  
FORD  
CÓDIGO: EPFD



SOQUET P/ FOCO 3157 DE FRENOS CHEVROLET.  
CÓDIGO: 37958



ENCHUFE P/ RELEVADOR DE 5 PUNTAS  
CÓDIGO: RSW-1208



ENCHUFE PARA UNIDAD REFORZADO CALIBRE 16  
CÓDIGO: 1630000



SOQUET PARA FOCO HALOGENO 880  
CÓDIGO: 06628



SOQUET PARA FOCO HALOGENO 889  
CÓDIGO: 06629



# FOCOS DE HALOGENO XENON HD (HIGH INTENSITY DISCHARGE)

LUCES DE CUARTA GENERACION PARA CARROS , AUMENTAN HASTA UN 300% LA LUZ.

INCLUYE:

- 2 FOCOS DE HALOGENO XENON
- 2 BALASTRAS
- TODO LO NECESARIO PARA SU INSTALACION.



**HALOGENO XENON HID**

## **REPUESTO DE HALOGENO XENON HID (HIGH INTENSITY DISCHARGE)**

CÓDIGO	NUMERO	INTENSIDAD
HID9006/8R	9006	8000K
HID9007/8R	9007	8000K
HIDH13/8R	H13	8000K

CÓDIGO	NUMERO	INTENSIDAD
HID9005/8	9005	8000K
HID9006/6	9006	6000K
HID9006/8	9006	8000K
HID9007/6	9007 / 9004	6000K
HID9007/8	9007 / 9004	8000K
HIDH3/8	H3	8000K
HIDH4/6	H4	6000K
HIDH4/8	H4	8000K
HIDH10/8	H10/H9/H8	8000K
HIDH13/8	H13	8000K
HID880/8	880/881	8000K

## **XENON HID BAJAS, ALTAS CON FOCO EXTRA H3**

CÓDIGO	NUMERO	INTENSIDAD
HID9007-2/8	9007 / 9004 (ALTA Y BAJA)	8000K
HID9007-2/6	9007 / 9004 (ALTA Y BAJA)	6000K
HIDH4-2/8	H4 (ALTA Y BAJA)	8000K
HIDH13-2/8	H13 (ALTA Y BAJA)	8000K



## **HALOGENO BIXENON HID DE BALASTRA DELGADA**

CÓDIGO	NUMERO	INTENSIDAD
HIDH13-4/8	H13	8000K



## **HALOGENO BIXENON HID**

CÓDIGO	NUMERO	INTENSIDAD
HIDH4-3/6	H4	6000K
HID9007-3/8	9007	8000K
HIDH4-3/8	H4	8000K
HIDH13-3/8	H13	8000K

# FOOSDELED UTRA HGH 36W/ 3800 LM



CÓDIGO	NUMERO	INTENSIDAD
LED2C-9005	9005	3800 LM



CÓDIGO	NUMERO	INTENSIDAD
LED2C-9006	9006	3800 LM



CÓDIGO	NUMERO	INTENSIDAD
LED2C-H1	H1	3800 LM



CÓDIGO	NUMERO	INTENSIDAD
LED2C-H4H/LE	H4	3800 LM

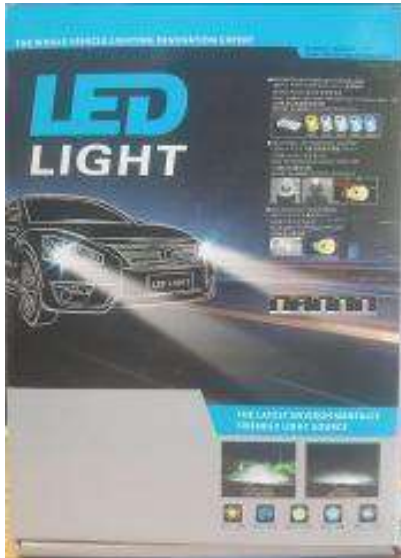

### LUCES LED BAJA

TIEMPO DE VIDA APROXIMADO  
30,000 HORAS  
COLOR/TEMPERATURA LUZ:  
6000/8000K.  
3000lm 30w. MINI BALASTRAS.  
CON CAMBIO MANUAL A 3  
COLORES,  
CLARO, TORNASOL Y AZUL.

CÓDIGO	FOCO
LED9006/3	9006

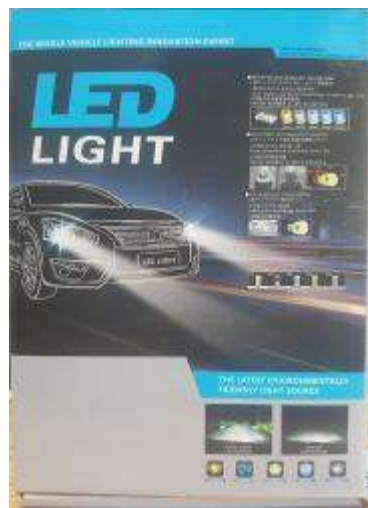

LUCES LED ALTA Y BAJA  
TIEMPO DE VIDA APROXIMADO 30,000 HORAS  
COLOR/TEMPERATURA LUZ: 6000/8000K.  
3000lm 30w. MINI BALASTRAS.  
CON CAMBIO MANUAL A 3 COLORES,  
CLARO, TORNASOL Y AZUL.

CÓDIGO	FOCO
LEDH4/3	H4
LED9007/3	9007
LEDH13/3	H13



# FOCOS DE HALOGENO MARCA FEZO



FOCO HALOGENO H4 S.  
BLANCO 100/130w  
6000K  
CÓDIGO: H4B-FZ



FOCO HALOGENO 880 S.  
BLANCO 100/130w 6000K  
CÓDIGO: 880B-FZ



FOCO HALOGENO H3 S.  
BLANCO 100/130w  
6000K  
CÓDIGO: H3B-FZ



FOCO HALOGENO H3 S.  
AMARILLO 100/130w  
6000K  
CÓDIGO: H3Y-FZ



FOCO HALOGENO 9005 S.  
BLANCO 100/130w 6000K  
CÓDIGO: 9005B-FZ



FOCO HALOGENO 9007 S.  
BLANCO 100/130w 6000K  
CÓDIGO: 9007B-FZ



FOCO HALOGENO 9004  
S. BLANCO 100/130w 6000K  
CÓDIGO: 9004B-FZ



FOCO HALOGENO H13 S.  
BLANCO 100/130w 6000K  
CÓDIGO: H13B-FZ



FOCO HALOGENO H13 S.  
AMARILLO 100/130w  
6000K  
CÓDIGO: H13Y-FZ



FOCO HALOGENO H4  
S. AMARILLO 100/130w  
6000K  
CÓDIGO: H4Y-FZ



FOCO HALOGENO 9004  
S. AMARILLO 100/130w  
6000K  
CÓDIGO: 9004Y-FZ



CÓDIGO: 9005Y-FZ

FOCO HALOGENO 9005  
S. AMARILLO 100/130w  
6000K



CÓDIGO: 9007Y-FZ

FOCO HALOGENO 9007  
S. AMARILLO 100/130w  
6000K

# FOCOS LEDS DE ALTA INTENSIDAD TIPO DOMO SERIAL Y PARALELO CON 2pzs



CÓDIGO	COLOR	MEDIDA	LD40AM	AMARILLO	40mm
LD31AZ	AZUL	31mm	LD40B	BLANCO	40mm



## FOCOS 3157 DE 68 Y 18 DIODOS



3157LED-68



3157LED-18

## FOCOS 1157 DE 68 DIODOS



CÓDIGO  
1157LED-68

## FOCOS 1141 DE 18 Y 27 DIODOS



1141LED-18



1141LED-27

## FOCOS LEDS DE ALTA INTENSIDAD TIPO PELLISCO 2pzs



CÓDIGO	COLOR
LPAZ	AZUL
LPB	BLANCO

## FOCOS DOMO DE 31mm BLANCO



CÓDIGO: T11X31W



CÓDIGO: T11X31W-16

## ROLLOS DE LEDS DE 16fts



CÓDIGO	COLOR
T-LED-AM	AMARILLO
T-LED-V	VERDE
T-LED-RJ	ROJO
T-LED-B	BLANCO
T-LED-RS	ROSA
T-LED-A	AZUL

## LED DE PLACA CON CONECTORES



LED DE DOMO DE 48 DIODOS CON ADAPTADORES PARA USO GENERAL.

CÓDIGO: CN-48LED

## CONECTOR ROLLO DE LEDS



CÓDIGO
CN-LEDS



TODOS LOS FOCOS DE XENON  
BLANCO DE 100w NETAMI  
A SOLO 3.50dls



FOCO XENON 9004 S.  
BLANCO 100w NET-  
AMI

**CÓDIGO: 46-9904OP1**

## CHISPADORES CON LUZ



CÓDIGO	DESCRIPCION	COLORES
09-088	CON 3 COLORES	?!
09-085	CON 2 COLORES	VERDE/ROJO



# UNDADES SELLADAS DE HALOGENO



RECTANGULAR

**CÓDIGO: H-4651**



RECTANGULAR

**CÓDIGO: H-4656**



RECTANGULAR

**CÓDIGO: H-6054**



REDONDA

**CÓDIGO: H6024**

**EIKO**  <sup>®</sup>

CERTIFIED GREEN

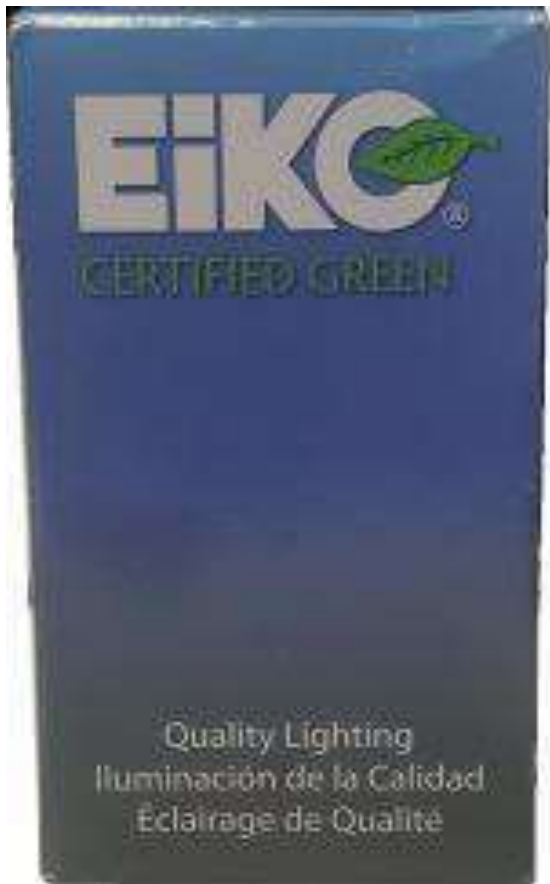

**CAJA CON 10.**

CÓDIGO	COLOR
7443E	CLARO

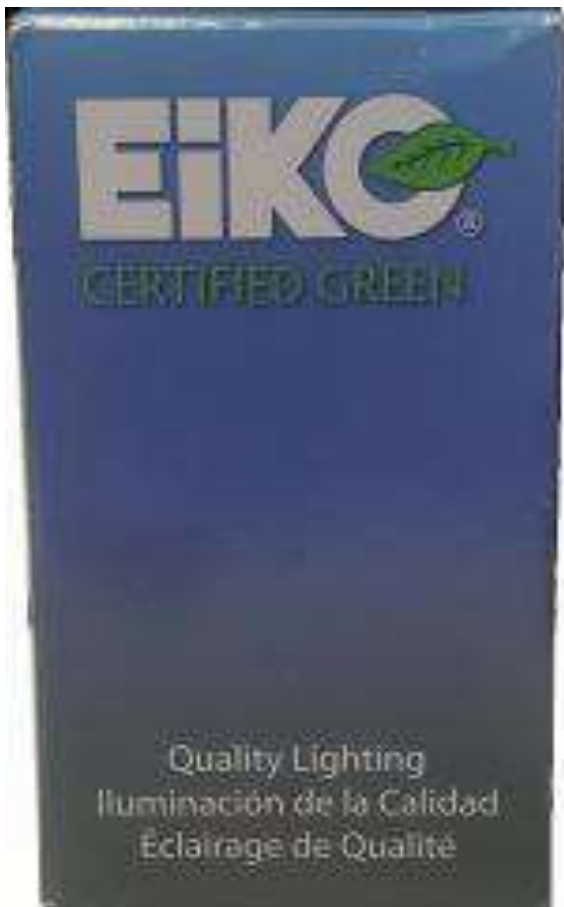

CÓDIGO	COLOR	TIPO
9005	CLARO	ALTAS
9006	CLARO	BAJAS



## LUZ HALOGENO CON PROIECTOR



**AZUL**  
CÓDIGO: 11-386



**CLARO**  
CÓDIGO: 11-381



**AMARILLO**  
CÓDIGO: 11-836

## LUZ PARA NEBLA DE ALTA RESISTENCIA

CONSUME 55W Y LOS AUMENTA A 85W



CÓDIGO	COLOR
270BL	AZUL
270CL	CLARO
270YL	AMARILLO

## LAMPARA CIRCULAR DE 7"

PARA FOCO H4 CON VELA



**CLARO**  
CÓDIGO: 11-702

## LAMPARA RECTANGULAR DE 7X6"

PARA FOCO H4



**CLARO**  
CÓDIGO: 11-703

## LAMPARA RECTANGULAR DE 7X6"

PARA FOCO H4



**CLARO CON LEDS LATERALES**  
CÓDIGO: 11-703LED

## PLAFON DOBLE OPTICO PAQUETE CON 2pzs



CÓDIGO	COLOR
CHIL006	AMBAR
CHIL005	ROJO

## LUZ ROJA REDONDA CON 15 LEDS PARA FRENS



CÓDIGO: CHIL010

## LUZ ROJA OVALADA CON 16 LEDS PARA FRENS



CÓDIGO: CHIL017

## PLAFON PARA EMBUTIR SELLADO



CÓDIGO	COLOR
2973100	CLARO
29728	ROJO
2972900	AMBAR

## LUZ ROJA REDONDA CON 15 LEDS PARA FRENS



CÓDIGO: CHIL010

## LUZ ROJA REDONDA CON 12 LEDS PARA FRENS



CÓDIGO: CHIL018

## LUZ REDONDA DOBLE CARA



- CON BASE MAGNETICA.
- 20FTS DE CABLE Y CONECTOR DE 4 PIN'S.
- SET CON 2 PIEZAS



**CÓDIGO: 90305**

## PLAFON UNIVERSAL COMPLETO



CON INDICADOR DE REVERSA.

**CÓDIGO: PCU**

## LUZ ROJA REDONDA CON LEDS PARA REVOLQUE



- CON BASE MAGNETICA.
- 20FTS DE CABLE Y CONECTOR DE 4 PIN'S.
- SET CON 2 PIEZAS

**CÓDIGO: CHIL003**

## PLAFON SELLADO PARA EMBUJIR REDONDO



DE 4" COLOR ROJO

**CÓDIGO: CHILT4000**

## LUZ PARA REVOLQUE



- 2 LUCES ROJAS TRASERAS
- 2 LUCES AMBAR LATERALES
- SOPORTE PARA LA PLACA

**CÓDIGO: 90309**



## PLAFON SELLADO DOBLE CARA REDONDO



**CÓDIGO: 16049**

## CABLES PARA CONEXION



- 4 CABLES FLAT TRAILER LUZ DE EXTENSIÓN.
- 48" CABLEADO CON CONECTORES MACHO Y HEMBRA DE 4 POLOS.
- HARDWARE DE MONTAJE INCLUIDO.

**CÓDIGO: CZTLW4**



## PLAFON SELLADO PARA EMBUJIR



CÓDIGO	DESCRIPCION
CHIL022	CONVENCIONAL
CHIL020	LUZ DE LED

## FOCOMIN DE DOS POLOS, CAJA CON 10 pzs



**CON CASQUILLO**

CÓDIGO	COLOR	CÓDIGO	COLOR
1157	CLARO	1176	CLARO
1157A	AMBAR	1176A	AMBAR
1157B	AZUL	1176B	AZUL
1157G	VERDE	1176G	VERDE
1157R	ROJO	1176R	ROJO
1157P	PURPURA		



**CLAVIJA**

CÓDIGO	COLOR	CÓDIGO	COLOR
3157	CLARO		
3157A	AMBAR		
3157B	AZUL		
3157P	PURPURA		
3157R	ROJO		



**PELLIZCO GRANDE  
LINEA HONDA, PATHFINDER**

CÓDIGO	COLOR
7443A	AMBAR
7440A	AMBAR
7443	CLARO
7440	CLARO

## FOCOMIN DE UN POLO CAJA CON 10 pzs



**CON CASQUILLO**

CÓDIGO	COLOR	CÓDIGO	COLOR
67	CLARO	57	CLARO
67A	AMBAR.	57-A	AMBAR.
67B	AZUL	57-B	AZUL
67R	ROJO	57-G	VERDE
67P	PURPURA	57-P	PURPURA
67G	VERDE	57-R	ROJO



**CON CASQUILLO**

CÓDIGO	COLOR
1141	CLARO
1141A	AMBAR
1141B	AZUL.
1141R	ROJO
1141P	PURPURA
1141G	VERDE



**CLAVIJA**

CÓDIGO	COLOR
3156	CLARO
3156A	AMBAR
3156B	AZUL
3156P	PURPURA
3156R	ROJO

## FOOCLARO FLASHEADOR



CLARO  
FLASHEADOR

**CÓDIGO: 257**

## FOOCLARO FLASHEADOR



CÓDIGO	COLOR
53	CLARO
1003	CLARO.
1004	CLARO



# WIPER ACCA



ACCA  
ACCESORIOS

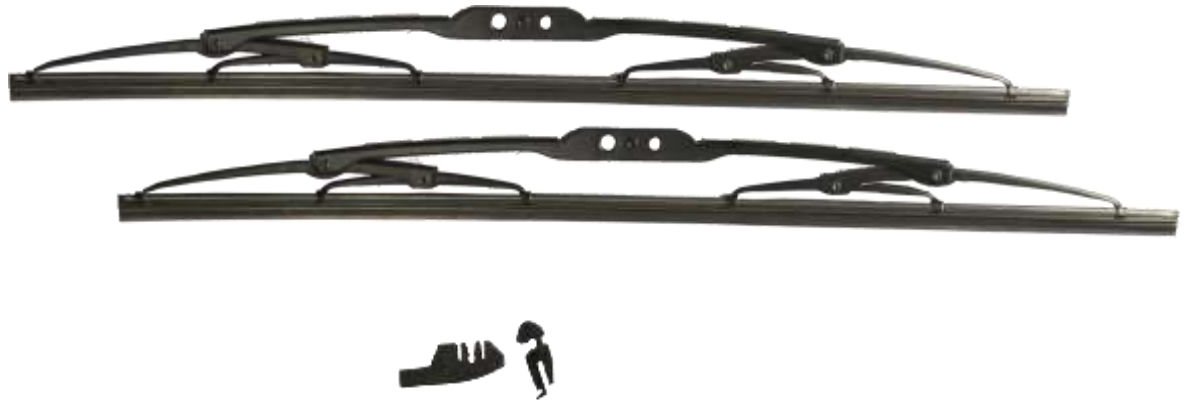

**INCLUYEN ADAPTADORES.**

CÓDIGO	MEDIDA
ACCA-W16	16"
ACCA-W18	18"
ACCA-W19	19"
ACCA-W20	20"
ACCA-W21	21"
ACCA-W22	22"
ACCA-W24	24"

## CABLE PARA PASAR CORRIENTE ACCA

MEDIDA 10FT.  
CALIBRE 2 600 AMP  
CON PROTECCION  
MORDAZAS PLASTICAS.



ACCA  
ACCESORIOS



CÓDIGO CALIBRE

ACCA-5240 2

## CANDADO TIPO T



ACCA  
ACCESORIOS



CÓDIGO

ACCA-L054

## CANDADO PARA VOLANTE



ACCA  
ACCESORIOS



CÓDIGO

ACCA-L070

## CANDADO PARA VOLANTE Y PEDAL



ACCA  
ACCESORIOS



CÓDIGO

ACCA-L008

## CEPILLO PARA LAAR CARRO



ACCA  
ACCESORIOS



CEPILLO DE 10' CERDAS DE PVC CON PROTECTOR PARACHOQUE, LA LONGITUD DEL MANGO ES DE 101 A 165 CM, CON CONECTOR PARA EL AGUA EN TIERRA POR

CÓDIGO

ACCA-98217A

## ESPEJOS CONCAVOS



DOBLE  
DEL #2

CÓDIGO  
CAPBSM2



DE 3"

CÓDIGO:  
CAPBSM3



DE 3 3/4"  
EN BLISTER

CÓDIGO:  
W-29C



DE 4 X 5/2"  
EN BLISTER

CÓDIGO:  
W-36C

## CANDADO PARA VOLANTE TIPO T



PARA VOLANTE, DE AJUSTE AL  
TABLERO, IMPIDE EL MOVIMIEN-  
TO DEL  
VOLANTE.

CÓDIGO

PROVEEDOR

004

AMERICAN TOOL EX-  
CHANGE

## CANDADO PARA VOLANTE TIPO BARRA



DE AJUSTE AL CRISTAL,  
IMPIDIENDO EL MOVIMIENTO DEL  
VOLANTE.

CÓDIGO

PROVEEDOR

003

AMERICAN TOOL EX-  
CHANGE

## CANDADO DE BARRA DUAL PARA VOLANTE Y/O PEDAL



- FUNCION CO-  
MO BASTON DE  
BARRA

UNE Y TRABA  
EL VOLANTE Y A  
ALGUNO DE  
LOS PEDALES

CÓDIGO: 6050

## CANDADO PARA VOLANTE



DISEÑO DE AGARRADERAS PARA  
MAYOR SEGURIDAD.  
ALTA VISIBILIDAD.

CÓDIGO: CQ-6009

## CANDADO PARA VOLANTE Y PEDAL



UNE Y TRABA EL VOLANTE Y A  
ALGUNO DE LOS PEDALES

CÓDIGO: 6012



## CUBRE PEDALES ESTANDAR.

## SEPARADOR DE BALL JOIN



CÓDIGO

1058028



CÓDIGO

ATTR-5

PROVEEDOR

VALLEY

## JUEGO DE HERRAMIENTA PARA DIAGNOSTICAR PRESION DEL RADIADOR

## LLAVE ABRAZADERA DISTRIBUIDORA



CÓDIGO

90810



CÓDIGO

ACWDW

## JUEGO DE DADOS DE 38 PIEZAS DE IMPACTO



7PC 3/8" DR tomas de impacto poco profundas  
8mm (5/16), 9mm,  
12mm, (15/32), 13mm, 14mm, 16mm (5/8"), 17mm  
Contralor de muro de contenido  
6PC 3/8" DR tomas de impacto poco profundas  
3/8" 7/16 (11mm), 1/2", 9/16", 11/16", 3/4" (19mm)

1 PC 1/2 (F)X3/8(M) adaptador  
1 PC 3/8 DR X3 barra de extensión  
1PC 1/2 DR X3 barra de extensión  
1PC caso de golpe

1 1PC 1/2" DR. Tomas de impacto poco profundas  
10mm, 11mm (7/16") 12mm (15/32) 13mm, 14mm, 15mm, 16mm  
(5/8),  
17mm, 18mm, 21mm, 24mm (15/16)  
10PC 1/2 DR tomas de impacto profundo  
1/2, 9/16 11/16, 3/4 (19mm) 13/16, 7/8 (22mm), 1, 1-1/16, (27mm), 1-  
1/8,  
1-1/4 (32mm)

CÓDIGO

50178

## SOPORTES PARA CUADROS PQTE DE 600PCS



- 153 Pc - 18GA Wire Nails
- 153 Pc - 17GA Wire Nails
- 152 Pc - 17GA Wire Brads
- 50 Pc - Thumb Tacks
- 16 Pc - Plastic Anchors
- 16 Pc - 32mm Sheet Metal Screws
- 15 Pc - Plastic Anchors
- 15 Pc - 25mm Sheet Metal Screws
- 12 Pc - Picture Hanger
- 10 Pc - Push Pins
- 4 Pc - 38mm Cup Hooks
- 4 Pc - 32mm Cup Hooks

CÓDIGO

TAIAS302

## CUÑAS DE METAL 60 PCS



- 4 Pc - 1/8" x 1/8" x 3/4"
- 4 Pc - 1/8" x 1/8" x 1"
- 5 Pc - 3/16" x 3/16" x 3/4"
- 5 Pc - 3/16" x 3/16" x 1"
- 5 Pc - 3/16" x 3/16" x 1-1/4"
- 5 Pc - 1/4" x 1/4" x 3/4"
- 5 Pc - 1/4" x 1/4" x 1-1/4"
- 5 Pc - 1/4" x 1/4" x 1-1/2"
- 5 Pc - 5/16" x 5/16" x 1-1/4"
- 5 Pc - 5/16" x 5/16" x 1-1/2"
- 5 Pc - 3/8" x 3/8" x 1-1/4"
- 5 Pc - 3/8" x 3/8" x 1/2"
- 2 Pc - 1/2" x 1/2" x 1-1/2"

CÓDIGO

TAIAK060

## TORNILLO TIPO ALLEN 106PCS



- (25) 8-32 x 1/2 in.,
- (25) 10-24 x 1/2 in.,
- (20) 10-24 x 1 in.,
- (3) 3/8 in.-16 x 1-1/2 in.
- (3) 3/8 in. – 16 x 1 in.
- (10) 1/4 in.-20 x 1 in.
- (10) 1/4 in.-20 x 1/2 in.
- (5) 5/16 in. – 18 x 1-1/2 in.
- (5) 5/16 in.-18 x 1 in.

CÓDIGO

TAIF0010

**SURTIDO DE RETENEDORES TIPO PULSADOR DE TAMAÑO DE AGUJERO**



**CÓDIGO**  
#8121

**SURTIDO DE TERMINALES DE ALAMBRE**



**CÓDIGO**  
TAIAT185

**SURTIDO DE RETENEDORES DE ESCUDOS**



**CÓDIGO**  
#8117

**TORNILLOS TUERCAS Y RONDANAS ACERO INOXIDABLE**



**CÓDIGO**  
TAIAB044

**TORNILLOS:**  
12 PCS.6-32x1,16pcs.8-32x1/2  
14 pcs.8-32x3/4,10pcs.8-32x1-12,6pcs.8-32x2,10pcs.10-24x1,8pcs.1/4x1,6pcs.1/4x1-1/2

**Planos:**  
26 pcs.#6,18pcs.#8,12pcs.#10,16pcs 1/4

24 pcs.#6-32,18pcs.#8-32,12pcs.#10-24,16pcs.1/4.

**SURTIDO DE TAPAS, T Y CONECTORES RECTOS**



**CÓDIGO**  
OPK2000

**CAPS**  
VT090 3/16" 60 Pieces  
VT238 1/8" 50 Pieces  
VT346 1/4" 50 Pieces  
VT930 5/16" 15 Pieces  
VT931 3/8" 10 Pieces  
VT932 9/32" 15 Pieces

**TEES**  
VT095 3/16" 40 Pieces  
VT322 1/8" 25 Pieces  
VT353 1/4" 25 Pieces

**STRAIGHT**  
VT067 1/4" 25 Piecse  
VT070 3/16" 40 Pieces  
VT579 1/8" 25 Pieces



# ABRAZADERAS CON INSULACIÓN DE HULE



INCLUYE

- 8PCS 1/4"
- 4PCS 5/16"
- 2PCS 3/8"
- 2PCS 1/2"
- 2PCS 5/8"

CÓDIGO

TAIB0022

# TAQUETES PLASTICOS CAJA CON 60PCS



INCLUYE  
30 TAQUETES PLASTICOS  
DE 1 1/2" X 5/8"

CÓDIGO

TAIC0780

# SURTIDO DE TAPAS, T Y CONECTORES RECTOS



CÓDIGO

OPK2000

## CAPS

- VT090 3/16" 60 Pieces
- VT238 1/8" 50 Pieces
- VT346 1/4" 50 Pieces
- VT930 5/16" 15 Pieces
- VT931 3/8" 10 Pieces
- VT932 9/32" 15 Pieces

## TEES

- VT095 3/16" 40 Pieces
- VT322 1/8" 25 Pieces
- VT353 1/4" 25 Pieces

## STRAIGHT

- VT067 1/4" 25 Pieces
- VT070 3/16" 40 Pieces
- VT579 1/8" 25 Pieces

## PASTA PARA PULIR ALUMINIO MAG 141gr JARRITO



LO SUFICIENTEMENTE FUERTE PARA LIMPIAR LOS METALES MÁS DESCUIDADOS Y LO SUFICIENTEMENTE DELICADO PARA USO DIARIO.

CÓDIGO

05100

## KIT LIMPIADOR DE MOLDURAS TRABAJO PESADO



El kit de limpiador de molduras para trabajo pesado Mothers® Back-to-Black® brinda una capacidad de limpieza inigualable, restaurando sus molduras exteriores y plásticos texturizados a su color original, como nuevo. Heavy Duty Trim Cleaner no es un encubrimiento; Limpia en profundidad, permitiéndole borrar años de negligencia y abuso ambiental, incluyendo oxidación, suciedad, mugre e incluso cera incrustada. Cuenta con un gel único, sin goteo, que te deja con una superficie duradera y naturalmente limpia.

CÓDIGO

06141

## KIT PCARGAR GAS REFRIGERANTE PUNTA PLASTICAS



ELIMINA LA PRESIÓN DE RECARGAR EL AIRE ACONDICIONADO DE SU AUTOMÓVIL CON LA TECNOLOGÍA SMART CLIP! LOS CLIPS DE VENTILACIÓN FÁCILES DE USAR CAMBIAN DE COLOR PARA MOSTRAR EL LLENADO CORRECTO DE REFRIGERANTE Y EVITAR LA SOBRE CARGA.

CÓDIGO

AVL-402CS

## ADAPTADOR PARA MANGUERA GAS FREON



CONECTA LAS MANGUERAS DE RECARGA DE ESTILO PERFORADOR A LAS LATAS CON UNA VÁLVULA AUTOSELLANTE SIN DAÑOS.

CÓDIGO

AVL-420

## EXTENSION AMORTIGUADOR



NO HAY NECESIDAD DE CHOQUES MÁS GRANDES AL REALIZAR LA INSTALACIÓN DE UN KIT DE ELEVACIÓN.

SE ADAPTA A TODOS LOS AMORTIGUADORES MONTADOS EN MONTANTES.

CÓDIGO

13-6501

## SET RATCH 14 CONDADOS 21PZAS.



INCLUYE

1 RATCH 1/4" PARA USO RUDO

10 PZAS- 1/4" (MM): 5, 6, 7, 8, 9, 10, 11, 12, 13, 14mm

10 PZAS- 3/8" (SAE): 3/16" 7/32" 1/4" 9/32" 5/16" 11/32" 3/8" 7/16" 1/2" 9/16"

CÓDIGO

TAIS0460



## SET RATCH 3/8" 8 CONDADOS 21PZAS.



INCLUYE

1 RATCH 3/8" PARA USO RUDO

10 PZAS- 3/8" (MM): 10, 11, 12, 13, 14, 15, 16, 17, 19 22mm

10 PZAS- 3/8" (SAE): 5/16" 3/8" 7/16" 1/2" 9/16" 5/8" 11/16" 3/4" 13/16" 7/8"

CÓDIGO

TAIS0461

## SET RATCH 1/2" 2 CONDADOS 21PZAS.



INCLUYE

1 RATCH 1/2" PARA USO RUDO

10 PZAS- 1/2" (MM): 10, 11, 12, 13, 14, 15, 17, 19 22, 24mm

10 PZAS- 1/2" (SAE): 3/8" 7/16" 1/2" 9/16" 5/8" 11/16" 3/4" 13/16" 7/8" 15/16"

CÓDIGO

TAIS0462

## SOLDADURA PARA PLOMERO



Con pasta fundente rápido y agresivo, para una limpieza efectiva que da adherencia a la soldadura.

Perfecto para muchos tipos diferentes de pasatiempos o proyectos electrónicos.

Pasta 10g.  
Rollo 0.13lb 3.00mm

CÓDIGO

11-TW260

## EXTRACTOR DE TORNILLOS CON BROCAS 10 PZS

5 piezas de aleación mecanizada y de múltiples pliegues

- Tamaños de los extractores de tornillos de acero: # 1- # 5
- 5 puntas de puntas de cobalto de mano izquierda: 5/64", 7/64", 5/32", 1/4", y 19/64".
- Incluye caja de almacenamiento de metal duradero.

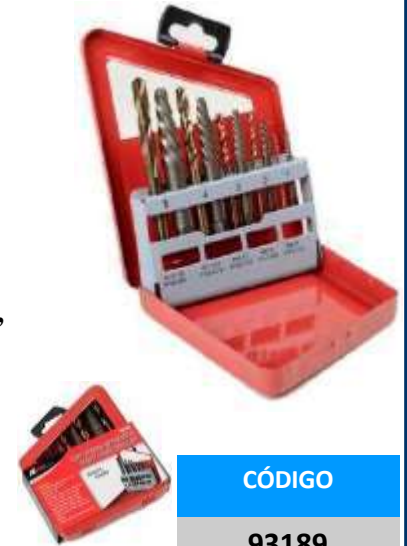

CÓDIGO

93189

## ALAMBRE DE SOLDADURA 2 PCS PARA CAUTIN



SOLDADURA DE PLOMO

tamaño: d- 0.5" / 0.12cm, peso 20g / pc

80% plomo 20% estaño

CÓDIGO

JC21099

## EXTRACTOR PARA TORNILLOS 7 PZS

Contenido:

Tornillo de 5 piezas,  
Manija de 1 pieza, Extractor de tornillo de 1 pieza

Material: acero al carbono

Forma rápida y fácil de quitar tornillos rotos, tubos, pernos y pernos.

CÓDIGO

TAIE0738





## ADAPTADORES PARA RATCH



CÓDIGO	MEDIDA
10830	1/4" F X 3/8" M
10831	3/8" F X 1/4" M
10834	3/8" F X 1/2" M
10835	1/2" F X 3/8" M

## JUEGO PUNAS TORX MN 8PCO GUA



CÓDIGO	MEDIDAS
88187	T-5,T-6,T-7,T-8,T-9,T-10,T-15

## CINTA DE MOLTAJE



- CINTA DOBLE VISTA
- 2 PIEZAS
- RESISTENTE

CÓDIGO
26572

## PUNAS DE CRUZ MAGNETICAS #1



CÓDIGO
BF12011

## PUNAS DE CRUZ MAGNETICAS PARA TABLAROCA #2



CÓDIGO
BF12021

## JUEGO DE BROCAS



CÓDIGO
CHIB0210

## CEPILLO ROLLAR DE ALAMBRE PARA BAFER

SE UTILIZA PARA PULIR  
OBJETOS DE ACERO,  
LATON Y COBRE.

ÚSELO PARA PREPARAR  
SUPERFICIES METALIDAS  
PARA SOLDAR, DESBASTAR  
Y PINTAR.



CÓDIGO

MEDIDA

CHIW215

3"X5/8"

CHIW216

4"X5/8"

## CEPILLO PARA TALADRO JEGO DE 3 PZS



CÓDIGO

CHIW2150

## CEPILLO PARA TALADRO TIPO CARDA



CÓDIGO

CHIW21



CERTIFICADO BA-  
JO LA  
NOM-046-SCFI-1999  
CINTA IMPRESA  
EN AMBOS LADOS  
MATERIAL RESIS-  
TENTE A LOS IM-  
PACTOS



CÓDIGO	MEDIDA
FLE0519	5mts
FLE0319	3mts

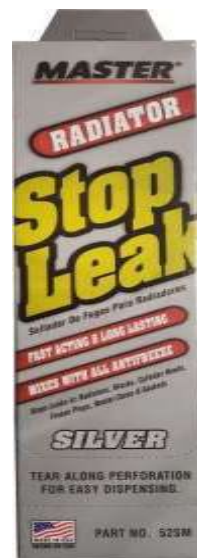

CÓDIGO
52SM

## POLVO BRONZE P/RAD. MASTER 20G



CODIGO
52BM

## CINTA REFLEJANTE



R81301

2" X 150'

CODIGO	R81301
--------	--------

## LUZ PREVENTIVA GIRATORIA



CODIGO
TAIL0019A

## ESPONJA MULTIUSOS



ESPONJA MULTIUSOS  
DE 4.5X8.5 PARA USO  
AUTOMOTRIZ Y DO-  
MESTICO IDEAL PARA  
LAVAR AUTOS, APLI-  
CAR BOQUILLA DE  
AZULEJO ETC.





### BOMBA DE GASOLINA



**BOMBA GAS ELECT.  
NISSAN TSURU III B13**

CÓDIGO  
**17042-OM300**

CÓDIGO  
**10074**

### BOMBA DE GASOLINA



**BOMBA GAS ELECT.  
TACOMA, CAMRY, RAV4, SIE.**

CÓDIGO  
**KON-05/ST-12**

### BOMBA DE GASOLINA



**BOMBA GAS ELECT.  
NISSAN TSURU III (DELGADA)=V**

CÓDIGO  
**KON-05NK**

### BOMBA DE GASOLINA



**BOMBA GAS ELECT.  
PICK-UP, TBI, SISTEMA  
GM=VF-8K**

CÓDIGO  
**KON-08K**

CÓDIGO  
**06723**

### BOMBA DE GASOLINA



**BOMBA GAS ELECT.  
UNIVERSAL=EP-8012=VF-12K=000-  
093**

CÓDIGO  
**KON-12K**

CÓDIGO  
**05062**

### BOMBA DE GASOLINA

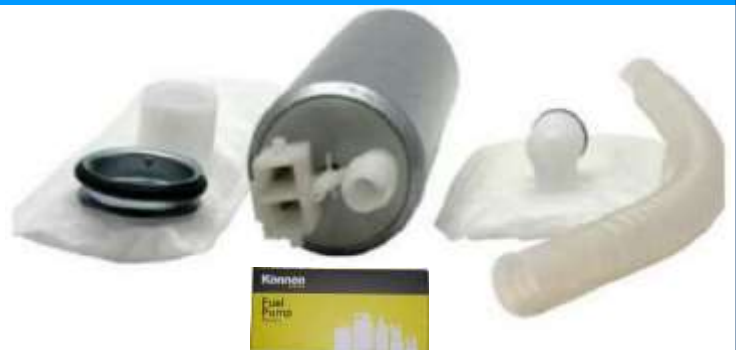

**BOMBA GAS ELECT.  
REGAL, GRAN PRIX, CADILAC**

CÓDIGO  
**KON-277K**

CÓDIGO  
**10362**

## SILICON NEGRO ALTA TEMPERATURA NASCA



RESISTENTE HASTA 343°C.  
REVISTE O FORMA  
EMPAQUES.  
FLEXIBILIDAD  
PERMANENTE.  
RESISTENTE A PRESION.

CODIGO

999-BK

## SILICON GRIS ALTA TEMPERATURA NASCA



RESISTENTE HASTA 343°C.  
REVISTE O FORMA  
EMPAQUES.  
FLEXIBILIDAD  
PERMANENTE.  
RESISTENTE A PRESION.

CODIGO

999-G

## SILICON ROJO ALTA TEMPERATURA NASCA



RESISTENTE HASTA 343°C.  
REVISTE O FORMA  
EMPAQUES.  
FLEXIBILIDAD  
PERMANENTE.  
RESISTENTE A PRESION.  
3oz.

CODIGO

999-R

## SILICON TRANSPARENTE ALTA TEMPERATURA NASCA



RESISTENTE HASTA 343°C.  
REVISTE O FORMA  
EMPAQUES.  
FLEXIBILIDAD  
PERMANENTE.  
RESISTENTE A PRESION.

CODIGO

999-CL

## AFLOJATODO 156gr.



DESTRABA PARTES ME-  
TALICAS  
QUITA EL RECHINIDO  
REMUEVE EL OXICO  
ENTRE OTROS.

CODIGO

901179

## LIMPIADOR DE CARBURADOR 311gr



LIMPIA EN CUESTION DE  
MINUTOS LAS SUPERFICIES DEL  
CARBURADOR, ASI COMO PARTES  
METALICAS, ELIMINANDO  
ACEITE PEGADO, SUCIEDAD,  
GOMOSIDADES M BARNIZ Y  
CARBON.  
BUEN FACTOR DE EVAPORACION

CODIGO

A-CC

## WIPER COMPLETO 2 PZS



La cuchilla está diseñada para proporcionar una presión constante en toda su longitud para ayudar a asegurar una limpieza uniforme.



CODIGO	MEDIDA	CODIGO	MEDIDA
LB301-A	11"	LB306-A	20"
LB102-A	14"	LB307-A	22"
LB203-A	16"	LB208-A	24"
LB204-A	18"		
LB312-A	19"		

### WIPER BANANA 1 PZA



CÓDIGO	MEDIDA
LB320A	16"
LB322A	18"
LB323A	19"
LB324A	20"
LB326A	22"
LB327A	24"

### WIPER BANANA 19/24"

MODELO	AÑO
EOS	2010
JETTA TDI	211-2017
JETTA A4	2011-2017
PASSAT CC	2009-2014
PASSAT	2007-2014
GTI A6	2010-2013



#### CODIGO

LB351A



# MULTIMETRO DIGITAL

DE GANCHO PROFESIONAL  
CON ESTUCHE, CON  
ZUMBIDO INDICADOR DE  
CONTINUIDAD



CÓDIGO

33067

CON PROTECTOR  
CUENTA CON RANURAS,  
PARA MEDIR TRANSISTORES,  
DIODOS  
Y CON ZUMBIDO INDICADOR DE  
CONTINUIDAD



CÓDIGO

2451

CÓDIGO

CHIC012

## PROBADOR DIGITAL DE CIRCUITOS



UTILICE PARA  
VERIFICAR LOS  
CIRCUITOS Y  
ACCESORIOS  
ELÉCTRICOS EN  
LOS SISTEMAS  
DE 3 A 12  
VOLTIOS

CÓDIGO

CHIT0050

## PROBADOR DIGITAL DE CIRCUITOS



3-48 V.

PANTALLA LCD  
RETRO  
ILUMINADA  
PARA  
LECTURAS  
PRECISAS DE  
VOLTAJE,  
DISEÑO  
PEQUEÑO PARA  
USO FACIL.

CÓDIGO

CHIT0054

## ACEITE MISTERIOSO MARVEL



Lubrifica todo el sistema de combustible: bombas de combustible, inyectores de combustible o carburadores y la parte superior de los cilindros. Éstas son las áreas, que por diseño, aceite de motor no alcanza. Usando Marvel Mystery Oil en su combustible se extiende la vida de estos componentes vitales, proporcionándoles lubricación que el combustible por sí solo no proporciona.

CÓDIGO

00012

MEDIDA

16oz

00013

32oz

## CEPILLO ALAMBRE CUADRADO



CÓDIGO

CAR

# ESPECIAL

**COPAS CROMADAS DOS EN UNO, CON DOS OPCIONES, GIRATORIA Y NORMAL, ES DESMONTABLE.**



**COPA SPINNER DE 14"**

**CÓDIGO**

105103



**COPA SPINNER DE 14"**

**CÓDIGO**

105115



## ADHESIVO LIQUIDO DEPOX



ADHESIVO LIQUIDO EPOXIVO MARCA DEPOX IDEAL PARA REPARAR Y PEGAR TODO TIPO DE METALES. DE SECADO NORMAL CON UN TIEMPO DE 45 MINS DE SECADO INICIAL Y UN TIEMPO DE 16HRS DE SECADO TOTAL. TOLERA HASTA 124 GRADOS CENTIGRADOS Y RESISTE 195 KG

**CÓDIGO: EA-242**

## ADHESIVO TRANSPARENTE DEPOX



ADHESIVO EPOXICO LIQUIDO TRANSPARENTE PARA REPARAR VIDRIO, CERAMICA, MADERA, MARMOL, ALGUNOS PLASTICOS ETC. SECADO SUPER RAPIDO DE 5MIN INICIAL Y 1HR DE SECADO TOTAL, TOLERA HASTA 94 GRADOS CENTIGRADOS Y RESISTE HASTA 100 kg

**CÓDIGO: EA-529**

## ADHESIVO LIQUIDO CON CARGA DE ACERO DEPOX



ADHESIVO LIQUIDO EPOXICO CON CARGA DE CERO REFORZADO PARA PEGAR TODO TIPO DE METALES, ACERO, BRONCE, LATON, ALUMINIO COBRE ETC. SECADO SUPER RAPIDO DE 5 MINS Y 1 HR DE SECADO TOTAL, TOLERA HASTA 124 GRADOS CENTIGRADOS Y RESISTE HASTA 145 kg

**CÓDIGO: EA-545**

## ADHESIVO TRANSPARENTE DEPOX



ADHESIVO LIQUIDO EPOXICO TRANSPARENTE PARA PEGAR Y REPARAR VIDRIO, CERAMICA, MADERA, MARMOL, ALGUNOS PLASTICOS SECADO SUPER RAPIDO DE 5 MINS Y 1 HR DE SECADO TOTAL TOLERA HASTA 95 GRADOS CENTIGRADOS RESISTE HASTA 97 kg

**CÓDIGO: EA-528**



## LIMPIADOR DE CARBURADOR



IDEAL PARA RAPIDA  
AFINACION  
ELIMINA TODO TIPO  
DE SUCIEDAD,  
GRASAS SIN DAÑAR  
SELLOS  
NO REQUIERE DE-  
MONTAR PIEZAS

**CÓDIGO: DP-53**



ACCA  
ACCESORIOS

## LIMPIADOR DEL SISTEMA DE ADMISION Y CATALIZADOR



IDEAL PARA RAPIDA  
AFINACION  
REDUCE EMISIONES  
CONTAMINANTES  
ELIMINA LA SUC-  
IEDAD DEL SISTEMA  
DE ADMISION

**CÓDIGO DP-80**



ACCA  
ACCESORIOS



ACCA  
ACCESORIOS



ACCA  
ACCESORIOS



ACCA  
ACCESORIOS



ACCA  
ACCESORIOS

## SOLDADURA ALMACENABLE EN TORNILLO DE AMARRE



**CÓDIGO: 33092**

## DISCO DE CORTE METAL DE 4-1/2



**CÓDIGO**

**MEDIDA**

40150 4-1/2" x 1/8" x 7/8"

40152 4-1/2" x 1/32" x 7/8"

40157 4-1/2" x 1/16" x 7/8"

## PRUEBA DE INYECCION DE COMBUSTIBLE 9PZS



PRUEBE LOS SISTEMAS ELECTRONICOS DE INYECCION DE COMBUSTIBLE EN VEHÍCULOS GMTBI, BOSH PFI, FORD TBI, GM PFI, GEO TB1 Y GM SCPI, GM MULTEC 2, GM -1987 Y GM-1982.

**CÓDIGO: 31098**

## DISCO CORTE METAL DE 7" X 1 8" X 7 8"



Max RPM 8600

**CÓDIGO: 40153**

## KIT PARA PULIR ESPONJA Y AMORTIGUADOR 7PCS



PARA PULIDO DE AUTOMOVILES

ADAPTADOR DE TALADRO DE ALTA CALIDAD

- MATERIAL: ESPONJA DE ESPUMA Y LANA
- 1 X ALMOHADILLA DE LANA BUFFER
- 2 X PALETA DE WAFFLE NARANJA
- 2 X ALMOHADILLA PLANA NARANJA
- 1 X 5/8 " ROSCA Y UN ADAPTADOR DE MANGO DE TALADRO DE 1/4" PARA PLACA DE RESPALDO
- 1 X 5/8 " ROSCA PARA AMOLADORA ANGULAR

**CÓDIGO: 14705**

## BORLA PARA LIJADO ESPONJA FIRME

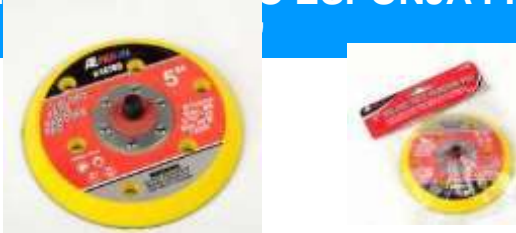

ALMOHADILLA DE LIJADO ORBITAL ALEATORIO DE DOBLE ACCIÓN PROFESIONAL

- ESPUMA FIRME ESTÁNDAR
  - TAMAÑO: 125 MM M8 5/16", 24 HILOS
  - RPM MÁX.: 12,000
- CÓDIGO: 14709**

## PORTA NAVAJA 1 FILO



**MANGO BLANDO PARA MAYOR COMODIDAD Y SEGURIDAD  
INCLUYE 1 NAVAJA.**

**CÓDIGO: 93536**

## RASPADOR 5 EN 1



**CÓDIGO: 92086**

## JECODELLAVES COMBINADAS STD 11 PZAS



MEDIDAS: 1/4", 5/16", 3/8", 7/16", 1/2", 9/16", 5/8", 11/16", 3/4", 13/16", 7/8".

**CROMO TIPO ESPEJO  
CÓDIGO: 97906**

## JECODELLAVES COMBINADAS STD 11 PZAS



MEDIDAS: 6, 7, 8, 9, 10, 12, 13, 14, 15, 17, 19mm

**CROMO TIPO ESPEJO**

**CÓDIGO: 97907**

## JECOLLAVES COMBINADAS MM Y STD 22 PCS

MEDIDAS mm: 6, 7, 8, 9, 10, 12, 13, 14, 15, 17, 19mm

MEDIDAS STD: 1/4", 5/16", 3/8", 7/16", 1/2", 9/16", 5/8", 11/16", 3/4", 13/16", 7/8".

**CROMO TIPO ESPEJO  
CÓDIGO: 97909**



## CEPILLO TELESCOPICO P/LAVAR CAMION HASTA 8FT.



**CERDAS EXTRA SUAVES, NO RASGUÑAN.**

**AGARRADERA EXTENDIBLE CON  
AGREGADOS DE ESPONJA ERGONOMICOS**

**CONECTOR PARA MANGUERA CON SEGURO  
DE ABIERTO Y CERRADO.**

**EXTENDIBLE HASTA 8 PIES.**



**CÓDIGO**

**1965C**

## PINZA PRESION DE 10" RECTA



**TIPO VISE-GRIP**

**UTILIZA UN CLASICO DISPARADOR  
DISEÑADO PARA PROPORCIONAR  
LA MAXIMA FUERZA DE BLOQUEO.**

**CÓDIGO**

**CHIP106**

## SEGURO PARA GANCHO DE JALON 5/8"



**CONSTRUIDO DE  
ACERO CHAPADO DE  
ZINC**

**UTILIZAR PARA  
ASEGURAR LOS  
SOPORTES DE BOLA.**



**CÓDIGO**

**TAIAH032**

## PROBADOR DE BATERIA



**PROBADOR DE  
BATERÍA Y  
ALTERNADOR  
PARA  
ENCENDEDOR**

**CÓDIGO**

**81089**

## ESPEJO RETROVISOR DIA NOCHE 8"



**CÓDIGO**

**ES002A**

## LIMPIA POSTES BATERIA 4 EN 1

**ESPECIFICACIONES:  
DIÁMETROS: 1/2" (12.7MM) Y  
3/4" (19MM)  
EMPAQUE: BLISTER  
LONGITUD DE CEPILLOS: 3 CM**

**CARACTERÍSTICAS:  
CEPILLO 4 EN 1  
CERDAS DE ACERO  
CUERPO DE POLIPROPILENO RE-  
SISTENTE Y LIGERO**

**USOS:  
IDEAL PARA LIMPIEZA DE POSTES Y  
TERMINALES DE BATERÍAS, TUBOS  
Y CONECTORES  
MECÁNICA AUTOMOTRIZ**



**CÓDIGO**

**BPC-2**

## PRENSAS



- SIN ROSCA, CHAPADO EN ZINC
- MANGO EN T DESLIZANTE
- SWIVEL PAD GIRARLO DEL ACERO BILLET
- REFORZADO ESQUINAS SIN DISTORSIÓN

CÓDIGO	MEDIDA
40037	3"
40039	4"

## ANTORCHA DE PROPANO

**Ideal para derretir hielo, quemar malezas, descongelar tuberías, etc.**  
**24 "longitud total Manguera de 60 "**  
**2 boquillas adicionales Tamaño de las boquillas: 1-1 / 8 " , 1-3 / 8" , 2 "**  
**Disparador Turbo Blast Mango de goma dura Protector de boquilla extra grande**



CÓDIGO

86180

## JUEGO DE FUNZONES Y CNELES 6PC



CÓDIGO

40065

## JUEGO DE FUNZONES Y CNELES 8PC



CÓDIGO

40106



## FILTRO AIRE INTAKE



CÓDIGO	COLOR
PM-614W	Transparente
PM-614R	Rojo
PM-614	Smoke

## SELLADOR Y RELLENADOR BASE ASFALTO NEGRO 300ML



SELLADOR Y RELLENADOR  
BASE ASFALTO 300ML.

- REPARA FUGAS MENORES.
- RESISTENTE AL AGUA
- FLEXIBILIDAD PERMANENTE

**CÓDIGO: D18268**

## SILICON MARCA HECORT

CARTUCHO CON 280ml. PRODUCTO ALEMÁN  
J AMARILLO PARA BAÑOS Y COCINAS



PARA APLICAR EN:

- TARJAS
- AZULEJOS
- TINAS
- LAVA MANOS
- CANCELERIA DE BAÑOS
- W.C.

**CÓDIGO:  
16-0207**

## ADAPTADOR PARA LLANA AVION

RESISTENTE AL DESGASTE.



## LLANA AVION 36X5



RESISTENTE AL  
DESGASTE, LA HOJA  
ESTA REDONDEADA  
EN LAS ESQUINAS Y  
ES FLEXIBLE PARA  
UNA MEJOR  
OPERACIÓN.

**MRFR36R**

## PROTECTOR SOLAR LATERAL PARA AUTOS DE CLUBES MEXICANOS



CORTINA LATERAL PARA AUTO  
PRODUCTO OFICIAL DE LAS CHI-  
VASCON 2 PZS  
**CÓDIGO: SC-1342**



CORTINA LATERAL PARA AUTO  
PRODUCTO OFICIAL DE LOS PU-  
MAS  
CON 2 PZS  
**CÓDIGO: SC-3342**



CORTINA LATERAL PARA AUTO  
PRODUCTO OFICIAL DEL AME-  
RICA  
CON 2 PZS  
**CÓDIGO: SC-2342**



CORTINA LATERAL PARA  
AUTO  
PRODUCTO OFICIAL DEL  
CRUZ AZUL  
CON 2 PZS  
**CÓDIGO: SC-4342**



PROTECTOR SOLAR O  
PARA TABLERO  
CON ESCUDO DEL AMERICA.  
**PRODUCTO OFICIAL**  
HECHO DE NYLON  
MEDIDA: 30" X 60"  
**CÓDIGO: MS-2312CA**



PROTECTOR SOLAR  
PARA TABLERO  
CON ESCUDO DE LAS CHIVAS.  
**PRODUCTO OFICIAL**  
HECHO DE NYLON  
MEDIDA: 30" X 60"  
**CÓDIGO: MS-1312CHI**

**CORTINA CORREDIZA JUMBO DEL  
AMERICA,**

**MEDIDAS: 27"X67"**  
MANTIENE FRESCO EL VEHICULO,  
PLEGABLE PARA FACIL ALMACENA-  
MIENTO.  
MANTIENE EL CALOR Y LOS RAYOS UV  
FUERA.



**CÓDIGO: AS-2331CA**

**PROTECTOR PARABRISAS 26X26.5"**

SE ADAPTA A SU VEHÍCULO PARA  
PROTEGER EL INTERIOR DE LOS NOCIVOS  
RAYOS UV. SU INGENUOSO DISEÑO AYUDA  
A MANTENER FRESCO EL HABITÁCULO EN  
VERANO Y EVITA QUE SE ACUMULE ES-  
CARCHA EN EL INVIERNO SI SE USA DEL  
LADO OPUESTO.

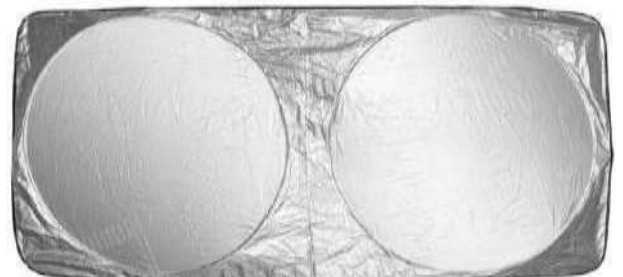

**CÓDIGO: IPT-AUTO-SS1**

# RONDANAS DE COBRE CAJA CON 10 PCS



**MEDIDAS:  
RESISTENTES A CORROSION,  
PARA CONECCIONES ELECTRI-  
CAS.**

**5/8" 10 PCS  
1/2" 10PCS  
7/16" 15PCS  
3/8" 20PCS  
5/16" 25 PCS**

**CÓDIGO**

**41092**



## ESCANER OBD II



**DETERMINA FACILMENTE  
LA CAUSA DEL "CHECK  
ENGINE LIGHT (MIL)"**

**BORRA CODIGOS Y  
RESTABLECE LOS MONI-  
TORES.**

**FACIL DE USAR Y  
ALTAMENTE CONFIABLE.**

**CÓDIGO**

**62000**

## EXTRACTOR DE MANIJAS Y BUJES



**PARA SACAR  
MANIJAS Y BUJES  
DE COMPRESIÓN  
DE GRIFOS**

**CÓDIGO**

**T168**

## JUEGO DE LLAVES CURVAS CON RATCHET MM STD 5PC



**CÓDIGO DESCRIPCION**

**50605** 6/8"X3/4" 1/2"X9/16" STD  
1/4"X5/16"  
7/32"X9/32"



**CÓDIGO DESCRIPCION**

**50607** 5.5X7 mm 6x8mm MM  
10x12mm 11x13mm  
14x17mm

## JUEGO DE LLAVES CON RATCHET MM STD 5PC



**CÓDIGO DESCRIPCION**

**50603** 5.5X7mm 6x8mm MM  
9x10mm 12x14mm  
15x17mm



**CÓDIGO DESCRIPCION**

**50601** 5/8"X3/4" 1/2"X9/16" STD  
3/8x7/16" 1/4"X5/16"  
7/32"X9/32"



***Dynatex***

## PEGAMENTO NEGRO 5oz. DYNATEX



Un adhesivo de ajuste versátil ampliamente utilizado en automoción y mobiliario, para la unión de tela recubierta de vinilo y telas de acabado a metal y madera. Un cemento de contacto de secado al aire que permite una rápida unión pero mantiene una versatilidad suficiente en tacto para permitir que grandes áreas se extiendan y se unan al mismo tiempo.

CODIGO

49429

## ADHESIVO DE ESPEJO RETROVISOR



Un adhesivo de fuerza profesional y un activador que asegura el espejo retrovisor se monta en

los parabrisas. Se adhiere al parabrisas en 40 segundos y permite el montaje en espejo en aproximadamente 15 minutos. Con 0.02oz.

CODIGO

49401

## SILICONES RTV ALTAS TEMPERATURAS



Formulado para aplicaciones de fabricación de juntas. Sensor seguro y fabricado para cumplir con las especificaciones OEM. Hace juntas instantáneas, a prueba de fugas, equipos de transmisión y componentes relacionados. Resistente a la temperatura hasta 343 ° C (650 ° F). Resiste aceite, agua, anticongelante y líquido de transmisión. Curas resistentes y flexibles. Funciona en todos los vehículos.

COLOR	CODIGO
ROJO	49292
NEGRO	49290

## SELLADOR DE ROSCA AZUL 6ml



Ideal para conjuntos de tuercas y tornillos de 1/4-3/4 de diámetro. Rellena espacios de hasta 0.006 pulgadas

CODIGO

49441

## SILICONES ALTA TEMPERATURA 3oz.



Resistente a la temperatura hasta 343 ° C (650 ° F). Resiste aceite, agua, anticongelante y líquido de transmisión. resistentes y flexibles.

COLOR	CÓDIGO
ROJO	49202
NEGRO	49200

## SILICON TRANSPARENTE 3oz.



Sellos de metal, plásticos, vidrio, tela, vinilo, madera y caucho. Uso en windshield, sunroofs, luces traseras, paneles interiores, paredes de fuego y tableros de instrumentos. Cura a temperatura ambiente.

CÓDIGO

49204

## PEGAMENTO EPOXICO 30 MINUTOS



ADHESIVO LIQUIDO EPOXICO PARA PEGAR TODO TIPO DE PLASTICOS, METALES, CERAMICA, PAPEL, MADERA, Y ALGUNOS TIPOS DE HULE. DE **30 MINS** DE SECADO TOTAL, TOLERA HASTA 200 GRADOS FARENHEIT.

CONTENIDO : .84 FL OZ

**CÓDIGO: 44107**

## PEGAMENTO EPOXICO MULTI METAL



ADHESIVO LIQUIDO EPOXICO CON CARGA DE ACERO REFORZADO PARA PEGAR TODO TIPO DE METALES, ACERO, BRONCE, LATON, ALUMINIO SE PUEDE TALADRAR LIJAR O PINTAR **120 MINS DE SECADO TOTAL**, TOLERA HASTA 300 GRADOS FARENHEIT

CONTENIDO : .84 FL OZ

**CÓDIGO: 44109**

## PEGAMENTO EPOXICO 5 MINUTOS



ADHESIVO LIQUIDO EPOXICO PARA PEGAR TODO TIPO DE PLASTICOS, METALES, CERAMICA, PAPEL, MADERA, Y ALGUNOS TIPOS DE HULE. DE **5 MINS** DE SECADO TOTAL, TOLERA HASTA 200 GRADOS FARENHEIT.

CONTENIDO : .84 FL OZ

**CÓDIGO: 44101**

## PEGAMENTO EPOXICO 4 MINUTOS



ADHESIVO LIQUIDO EPOXICO PARA PEGAR PLASTICOS, METALES, CERAMICA, Y VIDRIO SECADO SUPER RAPIDO DE **4 MINS** Y LISTO PARA USAR

CONTENIDO : 1 OZ

**CÓDIGO: 49409A**



## DYNAGREY



Alta temperatura, poco olor y no corrosivo. Resiste el agua, el aceite y el anticongelante. No se escapará. Resistente a temperaturas de hasta 500 ° F (260 ° C). Utilízelo en tapas de válvulas, cárteres de aceite, bombas de agua, bandejas de transmisión, cajas de termostatos, tapas de distribución y sellos de extremo de colector de admisión.

TUBO CON .85oz

CÓDIGO

47181

## ADHESIVO EPOXICO SECADO RAPIDO



FUERZA INDUSTRIAL  
COMPUESTO DE SOLDADURA QUIMICA, SELLA Y UNE LA MAYORIA DE METALES COMO:  
ALUMINIO, LATON,  
COBRE, HIERRO,  
HORMIGÓN Y PLASTICO.

CONT. 2oz.

CÓDIGO

00044

## GRASA BLANCA DE LITO



Lubricante de propósito general. Protege contra el óxido y la corrosión. Minimiza la fricción. Reduce el desgaste del equipo. Aumenta la vida útil. Se puede usar en pestillos de puerta, capó y tronco.

Bisagras y resortes de compartimentos, reguladores de asientos y rieles, mecanismos de limpiaparabrisas, piezas de freno y levas de distribución.

Fabricado para cumplir con las especificaciones del USDA.

TUBO CON 1.5oz

CÓDIGO

49594

## SUPERPEGAMENTO EN GEL 0.7oz



Reparaciones rápidas y fuertes. Funciona en superficies verticales  
Fórmula de fuerza extra de caucho, vinilo, la mayoría de los plásticos, vidrio, cuero, corcho y más.

TUBO CON .07 oz

CÓDIGO

49433

## FIJADOR DE ROSCA ROJO



Bloquea y sella los ensamblajes roscados metálicos donde se requiere alta resistencia. Conjuntos de tuerca y perno ideales donde el desmontaje

futuro es improbable. Proporciona un sello positivo que resiste la mayoría de los líquidos. Evita que las tuercas, pernos y otros sujetadores se aflojen debido a la vibración.

Funciona en temperaturas de -65 ° F a 350 ° F (-54 ° C a 177 ° C).

Luminaria apretada en minutos. Protege contra la corrosión del hilo. Rellena espacios de hasta .008 pulgadas.

Aplicar antes del montaje.

Protege contra la corrosión del hilo.

CANTIDAD CÓDIGO

1 ml 9440

6 ml 49451

24 ml 49452

## GRASA PARA 5TA RUEDA



GRASA PARA 5TA RUEDA DE  
TECNOLOGIA AVANSADA  
SOPORTA PRESIONES EX-  
TREMAS PROTEJE DE COR-  
ROSION Y  
OXIDO  
APRUEVA DE AGUA  
ALARGA EL PERIO  
ENTRE ENGRASADOS

CONT. 2 OZ

CÓDIGO

56400

## TAPE ELECTRICO LIQUIDO



TAPE LIQUIDO PARA  
USO ELECTRICO CON  
BROCHA

ELIMINA CORROSION Y  
SELLA DE HUMRDAD Y  
POLVO

CONT 4 FL. OZ.

CÓDIGO

49412

## ELIMINADOR DE EMPAQUES



JUNTA  
ANAEROBICA

PARA:  
BOMBAS DE  
COMBUSTIBLE  
BOMBAS DE  
AGUA  
Y OTROS MAS.

CÓDIGO

49477



ACCA  
ACCESORIOS



ACCA  
ACCESORIOS

## SUPERPROTECTOR



LIMPIA, BRILLA Y DURA MAS QUE CUALQUIER OTRA MARCA.  
NO PRODUCE OLORES DESAGRADABLES.  
ECOLOGICAMENTE AMIGABLE.  
NO ES TOXICO  
NO ES INFLAMABLE  
NO ES CORROSIVO.  
BOTELLA CON 8oz

COLOR	CÓDIGO
NEW CAR	02013
FRESH ORANGE	02012

## SILICONUSO GENERAL 280ml



PARA USO EN INERIORES, EXTERIORES, EN PUERTAS, VENTANAS, ES ANTIHONGOS, PARA METALES, ENTRE OTRAS APLICACIONES.

COLOR	CÓDIGO
BLANCO	BOSS302
TRANSPARENTE	BOSS302T

## SILICONACRILICO SILICONIZADO



PARA USO EN INERIORES, EXTERIORES, EN PUERTAS, VENTANAS, ES ANTIHONGOS, PARA METALES, ENTRE OTRAS APLICACIONES.

COLOR	CÓDIGO
BLANCO	BOSS361

## SOLDADURA PLASTICA 25ml



PARA USO EN INERIORES, EXTERIORES, EN PUERTAS, VENTANAS, ES ANTIHONGOS, PARA METALES, ENTRE OTRAS APLICACIONES.

CÓDIGO
44115

## ESPUMA POLIURETANO EXPANSIVA



A diferencia de los selladores ordinarios, se expande tres veces su volumen original

Se adhiere a todos los materiales de construcción excepto PTFE, silicona y polietileno

Sella expandiéndose en huecos, grietas y hendiduras.

Los usos incluyen aislar, sellar y rellenar huecos alrededor de tuberías, accesorios de plomería, conductos y cimientos.

UL clasificado  
Incluye aplicador.

CÓDIGO
333





Cemento amarillo de media viscosidad para usar en toda clase de conexiones de CPVC de hasta 2" de diámetro. Para uso en sistemas residenciales de agua caliente y fría de hasta 70 °C. Recomendado para aplicación en temperaturas de 5 °C a 43 °C. Cumple con la norma ASTM F493.

4 oz 118 ml  
CÓDIGO: 1453

Cemento azul de alta viscosidad para conexiones de PVC hasta 8"/200 mm de diámetro. Pega rápidamente. Recomendado para tuberías de agua potable, a presión, drenaje sanitario, de desperdicio y ventilación. Se puede aplicar a temperaturas de 5 °C a 43 °C. Cumple con la norma ASTM D2564.

4 oz 118 ml  
CÓDIGO: 1448



Limpiador para remover rápidamente suciedad y grasa de las superficies. Suaviza el tubo de CPVC o PVC preparándolo para el cemento disolvente. Se puede aplicar en diámetros de cualquier medida. Se recomienda aplicar en temperaturas de -25 °C a 43 °C.

8 oz 237 ml  
CÓDIGO: 7195





Cemento ROJO de ALTA viscosidad para usar en toda clase de conexiones de CPVC de hasta 2" de diámetro. Para uso en sistemas residenciales de agua caliente y fría de hasta 70 °C. Recomendado para aplicación en temperaturas de 5 °C a 43 °C. Cumple con la norma ASTM F493.

4 oz 118 ml  
**CÓDIGO: 7272**

Pegamento para uso general. Pega rápidamente. Se puede aplicar a temperaturas de 5 °C a 43 °C. Cumple con la norma ASTM D2564.

250 ml  
**CÓDIGO: 3298**



Cemento amarillo de media viscosidad para usar en toda clase de conexiones de CPVC de hasta 2" de diámetro. Para uso en sistemas residenciales de agua caliente y fría de hasta 70 °C. Recomendado para aplicación en temperaturas de 5 °C a 43 °C. Cumple con la norma ASTM F493.

2 oz - 60 ml **CÓDIGO: 1537**



Cemento AZUL de ALTA viscosidad para usar en toda clase de conexiones de CPVC de hasta 2" de diámetro. Para uso en sistemas residenciales de agua caliente y fría de hasta 70 °C. Recomendado para aplicación en temperaturas de 5 °C a 43 °C. Cumple con la norma ASTM F493.

2 oz - 60 ml **CÓDIGO: R7294**





Cemento AZUL de ALTA viscosidad para usar en toda clase de conexiones de CPVC de hasta 2" de diámetro. Para uso en sistemas residenciales de agua caliente y fría de hasta 70 °C. Recomendado para aplicación en temperaturas de 5 °C a 43 °C. Cumple con la norma ASTM F493.

2 oz - 60 ml      **CÓDIGO: 1452**



## ARMORALL DIFERENTES PRESENTACIONES ( USA )



**PREVENIR EL AGRIETAMIENTO Y  
DECOLORAMIENTO MEJORA EL  
ASPECTO DEL COCHE  
RENUOVA Y REVITALIZA EL VINYL,  
CAUCHO Y PLASTICO.**

CÓDIGO	CONT
10040	4oz.
10010	10oz.

## ARMORALL DIFERENTES PRESENTACIONES ( NACIONAL )

CONT. 946 ml.



CÓDIGO

19167

CONT. 473 ml.



CÓDIGO

19166

CONT. 295 ml.



CÓDIGO

19169

CONT. 118 ml.



CÓDIGO

19170



## PINTURA EN AEROSOL BROTIMEX



COLOR	CÓDIGO
ROJO PRIMARIO	AEA-174
GRIS PRIMARIO	AEA-175
AZUL METALICO	AEA-177

## RESPUESTOS RODILLO, BAJA Y MEDIA DENSIDAD



PERMITEN UN EXCELENTE RENDIMIENTO Y CARGAS DE PINTURA BUENAS PARA REALIZAR TRABAJOS DE APLICACION DE FORMA LIMPIA Y CONTROLADA SIN ESCURRIMIENTOS.

BAJA D ENSIDAD		MEDIA DENSIDAD	
CÓDIGO	MEDIDA	CÓDIGO	MEDIDA
RRB-80	3/4"	RRM-70	3/4"
RRB-81	1/2	RRM-71	9/16"
RRB-85	1"	RRM-72	3/8"
RRB-89	1 1/4"		

## LIJA DE ESPONJA BROTIMEX



LIJA DE ESPONJA BROTIMEX DE GRANO 220 IDEAL PARA LIMPIAR O LIJAR METALES, PLASTICO , FIBRA DE VIDRIO O MADERA

**CÓDIGO: LIES-220**



## LIIJA ESPONJA ANGULADA BROTIMEX



CÓDIGO: LIAN-60

**LIIJA ESPONJA ANGULADA. IDEAL PARA DEBASTADOS Y ACABDOS INTERMEDIOS O FINALES.  
GANO 60**

## BROCHAS DE ESPUMA BROTIMEX



CÓDIGO: BRE-3P

**JUEGO DE TRES BROCHAS DE ESPUMA, IDEAL PARA MANUALIDADES Y TRABAJOS ESCOLARES, RETOQUES EN AREAS DE DIFICIL ACCESO O APLIQUE PINTURA O BARNIZ.**

## FLEXOMETRO BROTIMEX



CÓDIGO	MEDIDA
FLEX-8	8M
FLEX-5	5M
FLEX-3	3M

**FLEXOMETRO GRADUACION EN SISTEMA METRICO E INGLES  
8.0mm X 25mm**

# PRODUCTOS

**byvo**

## “LA BUENA” MANGO DE PLASTICO



CÓDIGO	MEDIDA
BYP-1/2	DE 1/2"
BYP-1	DE 1"
BYP-1 1/2	DE 1 1/2"
BYP-2 1/2	DE 2 1/2"
BYP-5	DE 5"
BYP-6	DE 6"

## “LA REGIA” MANGO DE POLIPROPILENO



CÓDIGO	MEDIDA
BYPR-1/2	DE 1/2"
BYPR-5	DE 5"
BYPR-6	DE 6"

## TRADICIONAL FIBRA DE IXTLE



CÓDIGO	MEDIDA
BYPT-6	DE 6"

## REPUESTO DE RODILLO ACRILICO 9" C/2



FACIL USO, PARA TODO TIPO DE PINTURAS.

**CÓDIGO: 0282**

## RODILLO CORTO



Para proyectos en interior y exterior, ideales para retoques y pintar líneas de estacionamiento. Aplica pintura de manera

**CÓDIGO: REC14**

## PINCELES BYP A9000



PARA USO EN DECORACION DEL HOGAR, ARTESANIA Y MUCHO MAS PAQUETE C/144pzas.

**CÓDIGO: PPE**



## PISTOLA DE GRAEDAD



CON VASO DE PLASTICO

- Boquilla de 1.4mm de diámetro, acero inoxidable
- Aspersor ajustable
- Con capacidad de hasta 600ml de pintura, ligera y muy cómoda

**CÓDIGO: PGP**

## PISTOLAS DE SUCCIÓN



**MODELO 100**

- ASPERSOR AJUSTABLE
- PISTOLA DE BAJA PRESION
- CON CAPACIDAD PARA HASTA 750ml DE PINTURA MANIOBRABLE.

**CÓDIGO: PSM**

## CAMELUS PLANO C/ 12PZS



CÓDIGO	NUMERO
PCP0	No.0
PCP1	No.1
PCP2	No.2
PCP3	No.3
PCP4	No.4
PCP5	No.5
PCP6	No.6
PCP7	No.7
PCP8	No.8
PCP9	No.9
PCP10	No.10

## CAMELUS PLANO C/ 12PZS



DE ARTISTA  
PARA USO EN OLEO,  
ACRILICA Y ACUARELAS  
**100% CERDA DE PONY**  
PAQUETE C/5pzas.

## KIT DE CHAROLA DE PLASTICO PARA PINTAR



C/ MANERAL Y RODILLO  
ECONOMICO DE 9" X 1"  
**CÓDIGO: KPR00**

## FLEXOMETROBYP



**CERTIFICADO BAJO LA NOM-046-SCFI-1999 CINTA IMPRESA EN AMBOS LADOS MATERIAL RESISTENTE A LOS IMPACTOS**



CÓDIGO	MEDIDA
FLE0519	5mts
FLE0319	3mts

## PINTURA EN AEROSOL MARCA WEEKEND



CÓDIGO	COLOR
349	VERDE

## PINTURA EN AEROSOL MARCA BYP



CODIGO	COLOR
ANB	NEGRO BRILLANTE
ANM NEGRO MATE	NEGRO MATE
ARE	AZUL REGIO
ANS	NEGRO SATINADO
ARB	ROJO BERMELLON
ATR	TRANSPARENTE
AGR	GRIS MAQUINA
ABB	BLANCO BRILLANTE
AAL	ALUMINIO
AAO	AMARILLO
AAR	AZUL REY
ACR	CREMA
ARO	ROSA MEXICANO
APR	PRIMER ROJO OXIDO
AMA	MARRON
APG	PRIMER GRIS

## PINTURA EN AEROSOL FLUORESCENTE MARCA BYP



CODIGO	COLOR
ARF	ROSA FLUORESCENTE
ANF	NARANJA FLUORESCENTE
AAF	AMARILLO FLUORESCENTE

## PINTURA EN AEROSOL ALTA TEMPERATURA MARCA BYP



CODIGO	COLOR
ANT	NEGRO ALTA TEMP.
AAAH	ALUMINIO ALTA TEMP.

## PINTURA EN AEROSOL METALICA MARCA BYP



CODIGO	COLOR
AAM	AZUL METALICO

## PINTURA EN AEROSOL CROMADA MARCA BYP



CODIGO	COLOR
AOR	ORO
ACM	CROMO

## MANERAL PARA PINTAR



**REFORZADO**  
PRO. DE 9"  
C/ JAULA Y ROSCA P/  
EXTENSION

**CÓDIGO: MPR9**

**REFORZADO**  
"ELIT" DE 9"  
C/ JAULA Y ROSCA  
P/ EXTENSION

**CÓDIGO: MEL9**

**SENCILLO**  
SEMI-PRO. DE 9"  
C/ JAULA Y ROSCA  
P/ EXTENSION

**CÓDIGO: MSP9**

## MANERAL CON RODILLO PROFESIONAL PARA PINTAR

## MANERAL CON RODILLO ECONOMICO PARA PINTAR



CÓDIGO	MANERAL	MEDIDA
RPR19	PROFESIONAL	9" x 3/8"
RPR29	PROFESIONAL	9" x 3/4"
RPR59	PROFESIONAL	9" x 1/2"



CÓDIGO	MANERAL	MEDIDA
REC19	SENCILLO	9" x 3/8"
REC49	SENCILLO	9" x 1 1/4"
95000	SENCILLO	4" x 3/8"

## CHAROLAS PARA PINTAR



DE 9" PLASTICO  
REFORZADO  
**PROFESIONAL.**  
**CÓDIGO: CPR9**



DE 9" PLASTICO  
**SEMI-PROFESIONAL**  
**CÓDIGO: CEC9**



METALICA DE 9"  
INCLUYE GANCHOS  
P/ASEGURAR  
A LA ESCALERA.  
**CÓDIGO: CME9**

## ESCALERAS DE EXTENSIÓN

- ESCALERA DE ALUMINIO, RECOMENDADA PARA TRABAJOS EN MAYOR ALTURA Y CON MAYOR SEGURIDAD.
- PELDAÑOS TIPO "D"
- CAPACIDAD DE TRABAJO DE 102 KILOS.



CÓDIGO	DESCRIPCION	LARGO TOTAL
EEA16	DE 16 ESCALONES	16 PIES (4.87m)
EEA24	DE 24 ESCALONES	24 PIES (7.31m)
EEA32	DE 32 ESCALONES	32 PIES (9.75m)



# PRODUCTOS



## GRASA MARINA EN CARTUCHO 00140Z



GRASA MARINA  
 PEGAJOSA, COMPLEJO DE ALUMINIO  
 CON UN ACEITE ALTAMENTE REFINA-  
 DO.  
 FORMULADO CON POLIMEROS PARA  
 PROPORCIONAR ADHESIVO,  
 RESISTE AL AGUA BAJO LAS CONDI-  
 CONES MAS SEVERAS

**CÓDIGO: SL3120**

## SILICON EN SPRAY



HEAVY DUTTY  
 USOS MULTIPLES  
 CON 7.5oz

**CÓDIGO: 05074**

## REDUCTOR DE FRICCIÓN PARA ACEITE



ANTI-DESGASTE  
 ANTI-CORROCIÓN  
 REDUCE DEPOSITOS PA-  
 RA MOTOR GDI  
 6 oz

**CÓDIGO: 05818**

## ACONDICIONADOR PARA BANDA EN SPRAY



ELIMINA RUIDOS Y  
 PROLONGA LA VIDA  
 DE SU BANDA.  
 CON 7.5oz.

**CÓDIGO: 05350**

## SILENCIADOR DE BALATAS.

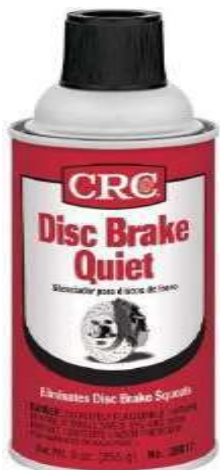

ESPECIALMENTE FORMU-  
 LADA  
 PARA AMORTIGUAR  
 LAS VIBRACIONES QUE  
 CAUSAN  
 RUIDO EN LOS FRENOS.  
 CON 12 oz.

**RESISTENTE AL AGUA**

**CÓDIGO:  
05017**

## ENGINKOOL



ENFRIADOR  
 DE MOTOR  
 CON 30oz.

**CÓDIGO: 05348**

## LUBRICANTE PENETRANTE



CÓDIGO	CONTENIDO
05005	8oz
05006	11oz



SL3110



SL3151



SL3111

**GRASA DE ULTIMA GENERACION**

**CONTENIDO 14oz**

GRASA DE ULTIMA GENERACION DE LITIO ESPECIALMENTE DISEÑADA PARA DISCOS Y TAMBORES, RODAMIENTOS, SUSPENSIÓN Y CHASIS. CON AMPLIO RANGO A LA TEMPERATURA Y A LA PRESION.

CÓDIGO	PRESENTACION
SL3110	CARTUCHO 14oz.
SL3111	BOTE 14oz.
SL3151	BOTE 14oz.



**GRASA EN CARTUCHO C/ 14oz**

GRASA DE LITIO PRESION EXTREMA CALIDAD PREMIUM IDEALES PARA TRABAJOS DE ALTA TEMPERATURA Y ALTO RENDIMIENTO. ANTI DESGASTANTE, ANTI-OSIDANTE CON ADITIVOS

**CÓDIGO: SL3190**

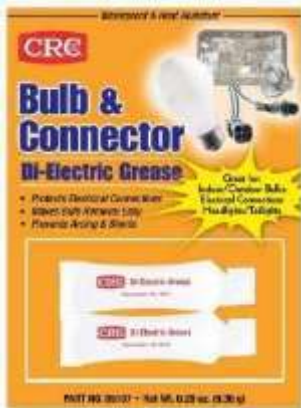

05107

**GRASA DIELECTRICA**

PROTEJE LOS CONTACTOS ELECTRICOS, LUBRICA Y PREVIENE LA CORROSION EN LAS TERMINALES DE LAS BATERIAS Y MAS.

CÓDIGO	CONTENIDO
05107	0.28oz



**GRASA DIELECTRICA**

GRASA DIELECTRICA DE 3.3 OZ

PROPIEDADES:

- SELLA, LUBRICA, PROTEJE Y AISLA
- A PRUEBA DE AGUA.
- APLICADOR DE PRESION PARA MAXIMO CONTROL.

**CÓDIGO: 05113**



## GRASA EN CARTUCHO DE 14oz



De lito uso general de alta resistencia al agua

**CÓDIGO: SL3310**



Alta temperatura incrementa la productividad y vida de los productos

**CÓDIGO: SL3630**



Blanca usos múltiples

**CÓDIGO: SL3150**

## GRASA EN TUBO



Para c.v. joint ideal para juntas de velocidad constante con 4oz

**CÓDIGO: SL3174**



Lubricante presión extrema con Moly-Graphite de 10oz

**CÓDIGO: SL3331**



Grasa súper blanca usos múltiples de 10oz

**CÓDIGO: SL3360**

## LIMPIADOR EN SPRAY



PARA CARBURADORES CON 12oz

**CÓDIGO: 85081**



PARA EQUIPO ELECTRONICOS C/ 8oz  
(AIRE COMPRIMIDO)

**CÓDIGO: 05185**



DESENGRASANTE PARA MOTOR CON 20oz

**CÓDIGO: 85025**

## LIMPIADOR EN SPRAY



PARA LA TOMA DEL AIRE CON 12oz

**CÓDIGO: 85078**



PARA PARTES DE FRENOS.



LIMPIA Y PROTEGE EQUIPOS ELECTRONICOS.  
NO DEJA RESIDUOS.

CON 11 oz

**CÓDIGO: 05103**

## GRASA EN LATA DE 14oz



DE TRABAJO PESADO  
PARA COJINES DEL TAMBOR  
DEL DISCO DEL FRENO.  
ECONOMICA, RESISTENTE,  
**CÓDIGO: SL3131**

## GRASA EN LATA DE 14oz



EXTREMA PRESION  
PARA CARGA PESADA,  
RESISTENTE AL AGUA.  
**CÓDIGO: SL3141**

## GRASA BLANCA DE LITO



ALTA RESISTENCIA AL CALOR  
**CÓDIGO: 05037**

## LIMPIADOR DE SENSORES DE FLUJO DE AIRE



Aumenta la potencia y  
mejora la relación  
Aire/Combustible

**CÓDIGO: 05110**

## LIMPIADOR LIQUIDO CON 12oz



PARA VALVULAS, DISUELVE  
LODO, BARNIZ Y GOMA.

**CÓDIGO: 05331**

## LIMPIADOR LIQUIDO CON 12oz



PARA RADIADORES LUBRICA SISTEMAS  
DE ENFRIAMIENTO  
**CÓDIGO: 05337**

## CREMA LIMPIADORA PARA MANOS



CON PÓMEZ  
PROTEJE LAS MANOS CON LANOLINA  
CON 14oz  
**CÓDIGO: SL1621**



CON LOCIÓN CÍTRICA  
NO CONTIENE SOLVENTES  
CON 16 oz.  
**CÓDIGO: SL1712**



CON POMEZ  
PUEDA USARSE CON O SIN AGUA  
CON 1gal.  
**CÓDIGO: 23218**

## SUPRESOR DE HUMO



REDUCE LA COMBUSTIÓN EXCESIVA  
DE ACEITE  
CON 12oz.

**CÓDIGO: 05334**

## SELLADOR DE EMPAQUETADURAS



AYUDA A DETENER  
ESCAPES DE ACEITE  
CON 12 oz.

**CÓDIGO: 05339**

## FLUIDO PARA GATO HIDRÁULICO



EXTIENDE LA VIDA  
DE TRABAJO

**CÓDIGO: SL2621**



### LIMPIADOR DE SISTEMAS DE ENFRIAMIENTO

Funciona en siete minutos. Revitaliza la eficiencia del enfriamiento, elimina la escoria dañina de óxido, el aceite y las incrustaciones de agua dura. Sistema de enfriamiento sin ácido.

**CÓDIGO: 401320**



### COPPER COAT

PEGAMENTO PARA EMPAQUES, RESISTE EL AGUA, VAPOR, GASOLINA, ACEITE, GRASA ACIDO LIGEROS ETC.

CÓDIGO	PRESENTACION	CONTENIDO
401504	LIQUIDA	4oz.
401612	EN SPRAY	9oz.

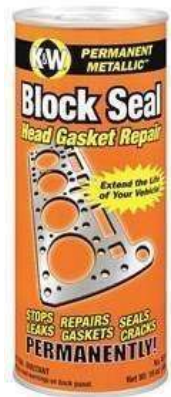

### BLOCK SEAL

SELLADOR DE RADIADOR Y BLOCK.

CON 16 oz.

**CÓDIGO: 401016**



TRATAMIENTO PARA TRANSMISION AUTOMATICA. DETIENE FUGAS PARA VEHICULOS CON 75,000 MILLAS O MAS.

CONT 473ml.

**CÓDIGO: 402916**



DETIENE LAS FUGAS Y PONE A PUNTO TRABAJA CON TODOS LOS TIPOS DE TRANSMISION

CONT 946ml.

**CÓDIGO: 402033**

USOS:

### TRANS-X



- DETIENE LAS FUGAS.
- IDEAL PARA LA AFINACIÓN DE LA TRANSMISIÓN Y DIRECCIÓN HIDRÁULICA.
- COMO MANTENIMIENTO PREVENTIVO CUANDO SE CAMBIA EL FLUIDO.

CON 15 oz.

**CÓDIGO: 402015**



- ADITIVO DEL ACEITE DEL ENGRANAJE.
- APLICACIONES EN EL DIFERENCIAL

SILENCIA EL RUIDO DE LOS ENGRANAJES

CON 7 oz.

**CÓDIGO: 402508**



### STOR-X

TRATAMIENTO ESTABILIZADOR SUPER CONCENTRADO PARA UN MEJOR ENCENDIDO, COMPATIBLE CON MOTORES A GASOLINA Y DIESEL.

CON 8oz.

**CÓDIGO: 402815**



### TRANSMEDIC

ADITIVO PARA TRANSMISIÓN CON 12oz.

**CÓDIGO: M36-16**



REPARADOR INSTANTANEO DE BLOCK /CABEZA CON NANOTECNOLOGIA CON 444ml

**CÓDIGO: 401214**



REPARADOR PERMANENTE DE BLOCK /CABEZA CON NANOTECNOLOGIA CON 946ml

**CÓDIGO: 401232**



### LIMPIADOR DE MOTOR 5 MINS

- REMUEVE LA PERDIDA DE POTENCIA, OXIDO, LODO Y BARNIZ
- LIBERA VALVULAS Y ANILLOS ATASCADOS
- USAR ANTES DE CADA CAMBIO DE ACEITE

CONT. 887ml

**CÓDIGO: 402718**



### REPARADOR DE PERDIDO PARA DIRECCION HIDRAULICA

-USOS PARA SISTEMAS DE POWER STEERING

CONT. 444ml

**CÓDIGO: 403015**



## LIMPIADOR DE BATERIAS CON 1lbz.



Detecta instantáneamente las fugas y neutraliza el ácido.

Elimina los subproductos de corrosión. Simplemente rocíe y enjuague.

**CÓDIGO:  
85023**

## PROTECTOR DE TERMINALES DE BATERIA CON 7.5oz



Diseñado para proteger los terminales de la batería de la corrosión, una de las principales causas de arranque y falla de la batería. Proporciona un recubrimiento protector suave sin plomo.

**CÓDIGO:  
05046**

## ADITIVO Y LIMPIADOR DE INYECTORES PARA AUTOS DIESEL

**FORMULA PARA REDUCIR EMISIONES  
CALIFICADA COMO SUPERIOR**



- LIMPIA INYECTORES
- INCREMENTA LA POTENCIA
- REDUCE EMISIONES
- REDUCE HUMO BLANCO
- Y MAS BENEFICIOS

**CÓDIGO:  
05232**

**CONTENIDO Neto: 30oz (888ml)  
TRATAMIENTO PARA 125 galones ( 473 litros)**

## ACEITE PARA HERRAMIENTAS NEUMATICAS 15oz

### DESCRIPCIÓN

Un lubricante especial diseñado para equipos y herramientas neumáticas.

### APLICACIONES:

Llaves de impacto, trinquetes neumáticos, lijadoras, rectificadoras, motores neumáticos, martillos, taladros, etc.



**CÓDIGO:  
SL2531**

# LAMPARA CON LEDS RECARGABLE DE MANO



**CON 4 LEDS** NO REQUIERE BATERIAS  
**CODIGO: 40333**



**CON 7 LEDS**  
SWITCH DE 2 POSICIONES  
1.- PRENDE 3 LEDS  
2.- PRENDE 7 LEDS  
**CÓDIGO: 40337**



**CON 11 LEDS**  
SWITCH DE 2 POSICIONES  
1.- PRENDE 6 LEDS  
2.- PRENDE 11 LEDS  
**CÓDIGO: 40336**



DE LARGO ALCANCE (200 METROS)  
**CON 15 LEDS**  
SWITCH DE 2 POSICIONES  
1.- PRENDE 5 LEDS  
2.- PRENDE 15 LEDS  
**CÓDIGO: 40335**

## LAMPARA DE CABEZA CON 14 LED'S



ESTA LAMPARA REQUIERE 3 PILAS TRILA 3A (BATERIAS NO INCLUIDAS)

- EXTENSIVA DURACION EN LA VIDA DE TIEMPO DE LOS LED HASTA 100,000 HORAS.
- LA DURACION DE LA BATERIA VARIA DEPENDIENDO DE LOS LED'S EN USO
- RESISTENTE AL AGUA

**CÓDIGO:40330**

## LAMPARA DE CABEZA CON 21 LED'S



**CÓDIGO:40334**



## LAMPARA MAGNETICA CON 3 LEDS ULTRA BRILLANTES

CUERPO DE ALUMINIO  
EXTENDIBLE DE 6.5" A 21.5" (16.5cms A 54.5cms)  
UN EXTREMO FLEXIBLO.  
AMBOS EXTREMOS MAGNETICOS PARA LEVANTAR HASTA 5lbs  
INCLUYE 4 BATERIAS LR44 + BONUS DE 4 PILAS DE REPUESTO

**CÓDIGO: 97945**



**MARINE-TEX PEGAMENTO PARA USO INDUSTRIAL REPARA BOMBAS DE AGUA, RADIADORES, TRAE SU PEGAMENTO CON SU CATALIZADOR**

**CÓDIGO JR2**

# PRODUCTOS







## FUEL INJECTOR & CARBURETOR CLEANER

MEJORA EL RENDIMIENTO DISOLVIENDO LOS RESIDUOS QUE SE ACUMULAN EN EL CARBURADOR, VALVULAS DE ADMISION Y TUBO MULTIPLE.

LIMPIA LOS SISTEMAS INYECTORES

CONTENIDO: 355ml

**CÓDIGO: 4695**



## ENGINE STOP LEAK

ADITIVO DE ACEITE REDUCE O ELIMINA FUGAS DE ACEITE DE LOS SELLOS Y EMPAQUETADURAS

CONTENIDO 355ml

**CÓDIGO: 4625**



## AUTOMATIC TRANSMISSION SEALER Y CONDITIONER

ELIMINA LAS FUGAS CAUSADAS POR SELLOS DE LA TRANSMISION SECOS O RAJADOS COMPATIBLE CON TODAS LAS TRANSMISIONES AUTOMATICAS.

CONTENIDO: 355ml

**CÓDIGO: 4617**



## OIL TREATMENT

MEJORA LA VISCOSIDAD DEL ACEITE EN LOS MOTORES DE DIESEL Y GASOLINA

CONTENIDO 355ml

**CÓDIGO: 4624**



## LIMPIADOR DE FRENOS Y PARTES SIN CLORO

SPRAY DE ALTA POTENCIA QUITA LIQUIDO DE FRENOS GRASA Y ACEITE AL INSTANTE DE TAMAÑO PROFESIONAL. FOMULA "50 STATE".

**CÓDIGO: 2417C**



## AUTOMATIC TRANSMISSION FLUID

COMPATIBLE CON TODOS LOS LIQUIDOS DE TRANSMISION

- ⇒ PROTEJE CONTRA LA CORROSION
- ⇒ AUMENTA LA VISCOCIDAD
- ⇒ EXCELENTE RETENCION DE FRICCION PARA OBTENER CAMBIOS SUAVES

CONTENIDO: 355ml

**CÓDIGO: 2512**

## ETER (STARTING FLUID)

4611 1 GAL.



AUXILIAR DE ENCENDIDO (LIQUIDO DE ARRANQUE) EN SPRAY CON 11oz.

## DESPOACHADOR CON MANGUERA



INFLA Y DESPONCHA TODO TIPO DE NEUMATICOS CONTIENE 15oz

CÓDIGO: 976

LIQUIDO PARA FRENOS

## LIQUIDO PARA FRENOS



RESISTENTE PARA SISTEMAS DE DISCO, TAMBOR Y ABS

CÓDIGO MEDIDAS

2212 12oz

2232 32oz

## LIQUIDO PARA POWER



CON ACONDICIONADORES QUE DETIENEN EL GOTEÓ.

CÓDIGO MEDIDAS

4611 1 GAL.

## ACEITE PARA DIRECCION ASISTIDA PARA HONDA Y ACURA



CÓDIGO CANTIDAD

2612F/Q 12OZ (355ML)

## ACEITE PARA MOTOR DOS TIEMPOS



CÓDIGO CANTIDAD

5593 8OZ (237ML)

# PRODUCTOS







J-B WELD SOLDADURA FRIA USOS TALLERES Y USOS DOMESTICOS, PEGA ASIENTOS Y GUIAS DE VÁLVULAS, SELLA CAMISAS DE CILINDROS Y BLOCKS TAPA TANQUES DE GASOLINA Y TRABAJO DE CARROCEÍA. SECADO LENTO.

CÓDIGO **8265-S**



J-B KWIK SOLDADURA EN FRIO USOS TALLERES Y USOS DOMESTICOS, PEGA ASIENTOS Y GUIAS DE VÁLVULAS, SELLA CAMISAS DE CILINDROS Y BLOCKS TAPA TANQUES DE GASOLINA Y TRABAJO DE CARROCEÍAS, SECADO RAPIDO.

CÓDIGO **8276**

**FIJADOR DE ROSCA JB WELD RESISTENCIA MEDIO AZUL**



CÓDIGO: 24236  
36ML

CÓDIGO: 24213 13ML

CÓDIGO: 24206  
6ML

DATOS	
<ul style="list-style-type: none"> <li>Resistente a la temperatura a 300 ° F</li> <li>Ideal para ¼ "a 1" elementos de fijación                             <ul style="list-style-type: none"> <li>OEM Aprobado</li> </ul> </li> <li>No Spill, goteo, o estorbo Cap</li> </ul>	
APLICACIONES	
<ul style="list-style-type: none"> <li>Balancín</li> <li>Pernos de la Armadura</li> <li>Sujetadores y bujes                             <ul style="list-style-type: none"> <li>Tornillos sueltos</li> </ul> </li> <li>Sensibles a las vibraciones Artículos</li> </ul>	

**FIJADOR DE ROSCA JB WELD RESISTENCIA ALTA ROJO**



CÓDIGO: 27136  
36ML

CÓDIGO: 27113

CÓDIGO: 27106  
6ML

DATOS	
<ul style="list-style-type: none"> <li>Resistente a la temperatura a 300 ° F</li> <li>Ideal para ¼ "a 1" elementos de fijación                             <ul style="list-style-type: none"> <li>OEM Aprobado</li> </ul> </li> <li>No Spill, goteo, o estorbo Cap</li> </ul>	
APLICACIONES	
<ul style="list-style-type: none"> <li>Balancín</li> <li>Espárragos</li> <li>Pernos de la Armadura</li> <li>Sujetadores y bujes                             <ul style="list-style-type: none"> <li>Tornillos sueltos</li> </ul> </li> <li>Sensibles a las vibraciones Artículos</li> </ul>	



CÓDIGO	CONTENIDO	EXCELENTE PARA	DATOS	T\SECADO
31310	3.0 OZ (85gr) 	PARABRISAS VENTANAS LENTES DE USO MARCOS DE PUERTA TUBO Y REGADERA ACUARIOS	IMPREMIABLE RESISTENTE AL MOHO Y AL HONGO NO RETRACTIL	1 HORA SILICON CLARO
31312	3.0 OZ (85gr) 	TUBERIAS Y REGADREA SINKS Y BAÑOS VENTANAS INTERIORES MOLDURAS INTERIORES MARCO DE PUERTAS LENTES DE USO	RESISTENTE AL MOHO Y AL HONGO IMPERMIABLE	1 HORA SILICON BLANCO
31314	3.0 OZ (85gr) 	CARTER DE ACEITE TAPAS DE LAS VALVULAS MULTIPLES ESCAPES BOMBA DE AGUA TAPA DE LA DISTRIBUCION CUBIERTA DEL DIFERENCIAL ,ETC	RESISTENTE A TEMPREATURAS MAS DE 650F°	1 HORA SILICON ROJO
31316	3.0 OZ (85gr) 	CUBIERTA DE ENGRANAJE DE SIN- CONIZACION CACEROLAS DE LA TRANSMISION CARTER DE ACEITE BOMBA DE AGUA TERMOSTATO, ETC	SENSOR DE SEGURIDAD	1 HORA SILICON AZUL
31319	3.0 OZ (85gr) 	UNION Y SELLADO BURLETES INTERIORES VENTANAS PARABRISAS MARCO DE PUERTAS, ETC.	RESISTENTE AL MOHO Y AL HONGO	1 HORA SILICON NE- GRO



CÓDIGO	CONTENIDO	EXCELENTE PARA	DATOS	T/SECADO
50112	25ml 	AZULEJOS. PLASTICOS. CERAMICA. VIDRIO. MADERA.	RAPIDA FIJACIÓN. 4400 PSI. SECADO EN 5 MINUTOS. CURA EN UNA HORA.	5 MINUTOS. ADHESIVO CLARO
50132	25ml 	AZULEJOS. PLASTICOS. CERAMICA. VIDRIO. MADERA.	RAPIDA FIJACIÓN. 4400 PSI. SECADO EN 5 MINUTOS. CURA EN UNA HORA.	1 HORA ADHESIVO AMARILLO TRANSLUCIDO
32327	3.0 OZ (85gr) 	VEHICULOS IMPORTADOS, MANGUERAS DE ADMISIÓN, PARTES DE TRANSMISIÓN.	RESISTENTE AL ACEITE, POCO OLOR, TIEMPO DE FIJACIÓN 1 HORA, COLOR GRIS.	1 HORA, SILICON GRIS.

### KIT REPARADOR DE TANQUE Y RADIADOR



TRABAJA EN SUPERFICIES DE PLASTICO Y METAL. EVITA FUGAS.

NO REQUIERE SER REMOVIDO.

EL KIT CONTIENE: MASILLA EPOXICA, CAPA DE FIBRA DE VIDRIO, LIJA Y CEPILLO APLICADOR.

**CÓDIGO: 2120JB**

### POVO PARA RADIADOR JB



Formulado para obtener un tamaño de partícula muy fino para mezclar y fluir rápidamente en todas las áreas del sistema de enfriamiento para encontrar y sellar fugas.

**CÓDIGO**  
**DS-114**



# PRODUCTOS



# CINTA REPARADORA DE FAROS AUXILIARES



DE 2in X 5ft  
COLOR  
TRANSPARENTE

**CÓDIGO: 00925c**



DE 3" X 4"  
COLORES:  
AMBAR, ROJO Y  
TRANSPARENTE

**CÓDIGO: 90237**

## KIT REPARADOR PROFESIONAL



PARA CRISTALES,  
DIANAS, GRIETAS  
ETC.

EN MINUTOS

**CÓDIGO:  
90110**

## SUPER PEGAMENTO



SUPER RAPIDO Y  
SUPER FUERTE.

**CÓDIGO:  
29045**

## LAMINA PERFORADA



PARA AUTOS,  
CASAS, ETC  
**CÓDIGO:  
36001**





# PINTURAS



# ABCO





"The Inventor of Aerosol Spray Paint"

PINTURA EN SPRAY MARCA SEYMOUR

CÓDIGO	COLOR
10-1	ALUMINIO
10-2	BLANCO BRILLANTE
10-3	NEGRO BRILLANTE
10-4	ROJO CEREZA
10-8	VERDE BOSQUE
10-24	NEGRO SEMI-BRILLANTE
10-31	ACRILICO TRANSPARENTE
10-49	MAGNECIO IMPORTADO
10-56	AZUL ROYAL
10-10	NEGRO MATE



**HASTA 325 °F**

CÓDIGO	COLOR
00807	CAST IRON BRILLANTE



TRABAJA PERFECTAMENTE EN LA MAYORIA DE METALES, PLASTICOS MADERAS Y MIMBRE

CONTENIDO NETO: 10oz (283grs)

CÓDIGO	COLOR
00235	PINTURA CROMO STD



PINTURA EN SPRAY  
CONTENIDO NETO: 10oz (283grs)

USO GENERAL PUEDE UTILIZARSE EN LA MAYORIA DE LAS SUPERFICIES

CÓDIGO	COLOR
BT-61	VERDE BOSQUE
BT-47	AZUL BRILLANTE

PINTURA EN SPRAY ALTA TEMPERATURA



RESISTEN HASTA 1200°F

CÓDIGO	COLOR
A96	BEIGE CUMMIN
A114	NEGRO

PINTURA EN SPRAY RUST-OLEUM



CODIGO	COLOR
1915830	PLATA METALICO
1910830	ORO METALICO

AROMATIZANTES



PINOS AROMATIZANTES



**BLACK ICE**  
U1P-10155-12



**NEW CAR**  
U1P-10189-12



**WILD CHERRY**  
U1P-10311-12



**COCO**  
U1P-10317-12



**DURAZNO**  
U1P-10319-12



**FRESA**  
U1P-10312-12



**PERA DULCE**  
U1P-10341-12



**OCEAN MIST**  
U1P-10221-12



**MULBERRY**  
U1P-10348-12



**NIGHT SKY**  
U1P-10279-12



**CALABAZA-CANELA**  
U1P-10504-12



**APPLEWOODS**  
U1P-10595-12



**SUMER SURF**  
U1P-10942-12



**TALCO**  
U1P-10225-12



**CHOCOLATE**  
U1P-10207-12



**ROSA SALVAJE**  
U1P-1017127-12



**PONCHE FRUTAS**  
U1P-10314-12



**MANGO**  
U1P-10339-12



**PAPAYA**  
U1P-10151-12



**PEACE**  
U1P-17502-12



**ORANGE ZEST**  
U1P-14315-12



**LILAC**  
U1P-14431-12



**PINO REAL**  
U1P-10101-12



**RELAX**  
U1P-17505-12



**VAINILLA**  
U1P-10105-12



**LEMON GROOVE**  
U1P-10594-12



**MANZANA CANELA**  
U1P-10338-12



**PIEL**  
U1P-10290-12



**SANDIA**  
U1P-10320-12



**STEEL**  
U1P-17152-12



## AROMA EN GEL CON 3 OZ



**VAINILLA**  
**07756-32**

## MINI TINS AROMATIZANTE



CONVENIENTE Y FACIL DE USAR. PERFECTO PARA CARROS, LA OFICINA Y HASTA ARMARIOS.  
"DURA HASTA 30 DIAS"

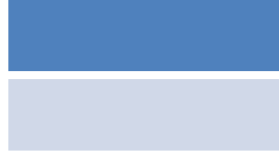

## AROMA EN GEL CON 1 OZ (28GR)



**VAINILLA**  
**12756**

## AROMA EN SPRAY CON 2 OZ



CODIGO	AROMA
UPS-05087	SPORT



CODIGO	AROMA
UPS-05001	PINO



CODIGO	AROMA
UPS-05017	COCO

**ES UNA ESPONJA ORGANICA DU-  
RA HASTA 45 DIAS,. SUGERENCIA  
DE USO: USAR DEBAJO DEL  
ASIENTO DEL VEHICULO**



## **AROMA CHICA FRESA EN TABLA**



**LA ORIGINAL CHICA FRESCITA  
NO ACEPTES IMITACIONES.**

AROMA DE FRESAS

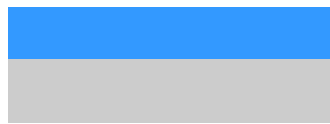

## **AROMA VAINILLO COTORRO**



**EL ORIGINAL VAINILLINO  
COTORRO**  
AROMA A VAINILLA

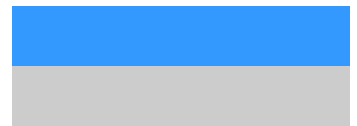

## **AROMA EL CATRIN LAVANDIN**



**EL ORIGINAL CATRIN LAVANDIN**

AROMA LAVANDA



## **AROMA CONO NUTS**

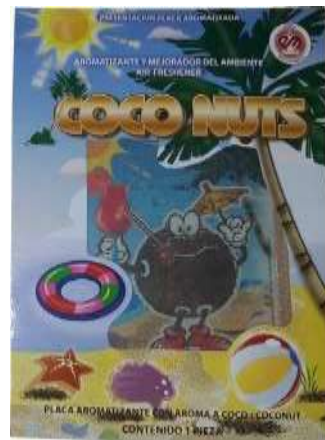

**EL ORIGINAL COCO NUTS**  
AROMA A COCO

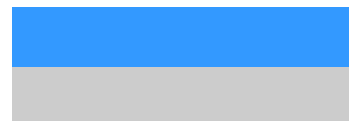

## AROMATIZANTE AMBIENTADOR CON 1.5oz (42gr)

FUERTE Y EFECTIVA FRAGANCIA QUE DURA HASTA DE 60 DIAS. PERFECTOS PARA AUTOS, TRAILERS, BOTES Y MAS.



ARANDANO



BRISA  
MARINA



ARTICICE



CÓDIGO	AROMA
01988	BRISA MARINA
01990	ARANDANO
01991	ICE

## GEL ELIMINADOR DE OLORES DE 2.5oz (70gr)

CITRICO



CEREZA



BRISA DE LAGUNA



CÓDIGO	AROMA
01571	CITRICOS
01484	CEREZA
01478	BRISA DE LAGUNA

## GEL ELIMINADOR DE OLORES DE 5.2oz (150gr)



CITRICO



CEREZA



JAZMIN

CÓDIGO	AROMA
01157	CITRICOS
01394	CEREZA
01395	JAZMIN



## AROMATIZANTE TIN SCENT ORGANICO

- Diseño unico de vanguardia
- Da nueva frescura al aire
  - Fresco y duradero



CÓDIGO	AROMA
30501	CHERRY
30502	STRAWBERRY
30585	COOL ICE

## AROMATIZANTES MENTOS



- Duracion hasta 45 dias
- Producto hecho en U.S.A

CÓDIGO	AROMA
45002	CHERRY
45004	COOL MINT
45001	BUBBLE GUM

## AROMATIZANTE PARA CLIP DE VENTILACION (K29)



- Duracion hasta 45 dias
- Producto hecho en U.S.A

CÓDIGO	AROMA
24012	NEW CAR
24003	CHERRY

# AROMA ORGANICO CALIFORNIA CAJA CON 12 Y 18 PIEZAS



CODIGO	AROMA
CAN-12C	CEREZA
CAN-12T	MIXTO



CODIGO CAN-18CT



CODIGO CAN-18C

## PALMERAS AROMATICAS EXOTICA FRESHERS



CHICLE  
CÓDIGO: PT24CH



COCO  
CÓDIGO: PT24CO



PINO REAL  
CÓDIGO: PT24PR



MANZANA  
CÓDIGO: PT24MV



TALCO  
CÓDIGO: PT24T



DURAZNO  
CÓDIGO: PT24D



VAINILLA  
CÓDIGO: PT24V



AROMATIZANTE DE AUTO  
EN ACEITE PARA AIRE  
ACONDICIONADO.  
FACIL INSTALACION CON  
CLIP AJUSTABLE  
OLOR VAINILLA

CÓDIGO  
U1P-16705

## PALMAS AROMATICAS EXOTICA FRESHERS



CARTERA CON 60 PALMERAS SURTIDAS  
CÓDIGO: PT60S

## SEGETA Y BROCAS PARA INSTALAR CHAPAS DE FUERTA

## LLAVE PARA TALADRO DE 1 2"



### JUEGO CON 3 PZS

- CIRCULAR DE 2 1/8"
  - PALETA DE 1"
  - MANDRIL
- CÓDIGO: CHIL303**



EN SU ESTUCHE.  
**JUEGO CON 11 PZS.**

**CÓDIGO: 32020**



**CÓDIGO:  
ETACK-12**

## PIEDRAS MONTABLES

## JUEGO DE BROCAS DE 29 PIEZAS



JUEGO DE 5 PZS

**CÓDIGO: CHIS084**



JUEGO CON 10  
**CÓDIGO: 40284**



**CÓDIGO: CHIB0226**

DE MEDIDAS 1/16 A 1/2" CON  
ENTRADA DE 3/8" PARA USO  
PROFESIONAL IDEAL PARA MADERA,  
PLASTICO  
Y METAL, CON ESTUCHE.



**CÓDIGO: 32072**

## JUEGO DE BROCAS 8PCS PARA CONCRETO

## BROCA DE PALETA PARA MADERA



### PAQUETE JUEGO CON 8 PZS.

Para taladrar ladrillo, concreto,  
mármol, teja y piedra.

**3 mm, 4 mm, 5 mm, 6 mm, 7 mm,  
8 mm, 9 mm, 10 mm, 1/8", 5/32",  
3/16", 1/4", 9/32", 5/16"  
11/32", 3/8"**

**CÓDIGO: DBMDB-8**



CÓDIGO	MEDIDA
DI151-09	DE 5/8"
DI151-16	DE 1"
DI151-07	DE 7/16"
DI151-20	DE 1 1/4"





## Broca para Concreto



CÓDIGO	MEDIDA
51018-3/16x4	DE 3/16
51018-1/4X6	DE 1/4 X 6
51018-5/16X4	DE 5/16 X 4
51018-5/16X6	DE 5/16 X 6
51018-3/8X5	DE 3/8 X 5
51018-1/2X6	DE 1/2 X 6

## Broca para Metal



CÓDIGO	MEDIDA
51019-3/32	DE 3/32
51019-1/8	DE 1/8
51019-3/16	DE 3/16
51019-7/32	DE 7/32
51019-1/4	DE 1/4
51019-9/32	DE 9/32
51019-5/16	DE 5/16
51019-3/8	DE 3/8
51019-1/2	DE 1/2

## LLAVES COMBINADAS INDIVIDUAL MILIMÉTRICAS Y ESTÁNDAR MARCA DISSTON

### MILIMÉTRICA

CÓDIGO	MEDIDA
DI339-14	DE 6mm
DI339-15	DE 7mm
DI339-17	DE 9mm

### ESTÁNDAR

CÓDIGO	MEDIDA
DI339-01	DE 1/4"



## LLAVES COMBINADAS DE DIFERENTES MEDIDAS MILIMETRICAS Y ESTANDAR MARCA

### ESTANDAR

CODIGO	MEDIDA
7312	3/8"
7313	7/16"
7314	1/2"
7316	5/8"
7311	5/16"
7317	11/16"
7315	9/16"
7318	3/4"
7319	13/16"

### MILIMETRICAS

CÓDIGO	MEDIDA
7294	10mm
7296	12mm
7297	13mm
7295	11mm
7299	15mm



# BATERIAS PANASONIC

CÓDIGO	TIPO	CÓDIGO	TIPO	CÓDIGO	TIPO
PANA-AA	DOBLE A	PANA-C	C	PANA-9V	9 VOLTS
PANA-AAA	TRIPLE A	PANA-D	D		



## DISCO PARA CORTAR METAL

DE 12" X 1/8  
MÁXIMA REV.  
POR MINUTO 4300  
**MASTERCRAFT**

CÓDIGO: A30PBF



## DISCO PAON DIAMANTE PARA CORTAR CONCRETO



DE 7"  
CON DIAMANTE.  
CÓDIGO: 33050



DE 4-1/2"  
CON DIAMANTE  
CÓDIGO: 40262

## DISCO CON DIAMANTE PARA MADERA IRWIN



DE 7 1/4"  
C/ SISTEMA DE  
ENFRIAMIENTO  
DE 24 DIENTES.  
**HD**  
CÓDIGO: 24030

## DISCO PARA CORTAR



DISCO DIAMANTE PARA CORTAR  
SOBRE MOJADO DE 7", 8600 RPM  
MAXIMO, PARA CORTES LIMPIOS,  
LISOS Y SIN ASTILLAR

CÓDIGO: 40265



## DISCO PARA AZULEJO

DE 4"  
CON DIAMANTE  
CÓDIGO: 33025



## DISCO PARA CORTAR MADERA

DISCO 4-3/8  
DIENTES DE  
CARBURO

CÓDIGO: 18004



## DISCO CON DIAMANTE PARA MADERA POTE 2PCS

CÓDIGO	MEDIDA	DIENTES
33014	DE 7 1/4"	24
33015	DE 7 1/4"	40





## DISCO PARA CONCRETO



Disco sinterizado caliente de turbo diamante para cortar concreto de 4-1/2"

- Ideal para cortar granito marmol, procelana, piedra y diferentes tipos de losetas y materiales de albañilería.
- constante contacto con el material proporciona un acabado más suave , más limpia que las cuchillas segmentadas

- Matriz óptima de bonos ofrece un rápido , más largo, y suave corte.

**CÓDIGO: 90320**

## DISCO PARA CONCRETO

Disco de turbo diamante para cortar concreto de 7"

- Ideal para cortar granito marmol, procelana, piedra y diferentes tipos de losetas y materiales de albañilería.

- constante contacto con el material proporciona un acabado más suave , más limpia que las cuchillas segmentadas

- Matriz óptima de bonos ofrece un rápido , más largo, y suave corte.



**CÓDIGO: 90325**

## DISCO PARA CONCRETO 7"



constante contacto con el material proporciona un acabado más suave , más limpia que las cuchillas segmentadas

- Matriz óptima de bonos ofrece un rápido , más largo, y suave corte.

**CÓDIGO: 90326**

## DISCO PARA CONCRETO 4 1/2" DAVIDSON



- Max r.p.m.: 13200
- 4 – 1/2" d x 2.2T x 7H x 5/8"
- Para uso en seco
- Continuo borde **Turbo** diseñado para un uso óptimo en ladrillo, bloque, y azulejos
- Con segmentos de diamante grande, ideal para uso en aplicaciones de varios producto

**CÓDIGO: ABDW-0412T**

## DISCO PARA CONCRETO



Disco de turbo diamante para cortar concreto de 4-1/2"

- Ideal para cortar granite marmol, procelana, piedra y diferentes tipos de losetas y materials de albañilería.
- constante contacto con el material proporciona un acabado más suave , más limpia que las cuchillas segmentadas

- Matriz óptima de bonos ofrece un rápido , más largo, y suave corte.

**CÓDIGO: 90319**

## DISCO PARA CONCRETO

Disco de diamante para cortar concreto de 4" para uso mojado (con agua).

- Ideal para cortar granite marmol, procelana, piedra y diferentes tipos de losetas y materials de albañilería.
- constante contacto con el material proporciona un acabado más suave , más limpia que las cuchillas segmentadas

- Matriz óptima de bonos ofrece un rápido , más largo, y suave corte.



**CÓDIGO: 90330**

## Surtido de Tornillos Tuercas y Rondanas 224 piezas

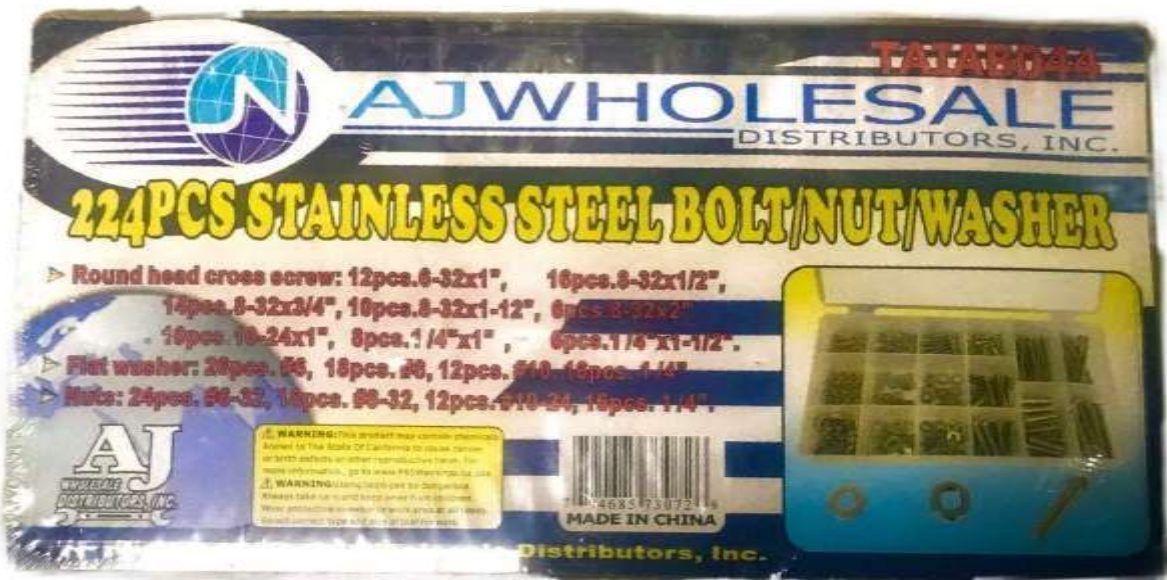

**CÓDIGO:**  
**TAIAB-044**

**Surtido de Tornillos tuercas y rondanas 224 piezas**

Contiene

30 Pcs 2.0x40 mm	25 Pcs 2.5x40 mm
20 Pcs 2.0x40 mm	20 Pcs 5.0x40 mm
16 Pcs 7.0x80 mm	8 Pcs 10.0x80 mm
8 Pcs 13.0x85 mm	

## Surtido de envoltura de aislante tipo tubo termoaplicable (calor) 127 piezas



**CÓDIGO: 41100**



Contiene

**Tornillo de Cruz Cabeza Redonda**

12 Pcs 6-32x1"	16 Pcs 8-32x1/2"
14 Pcs 3-32x3/4"	10 Pcs 8-32x1-1/2"
10 Pcs 10-24x1"	8 Pcs 1/4\"x1"
10 Pcs 8-32x2"	6 Pcs 1/4\"x1-1/2"

**Rondana Plana**

26 Pcs #6	18 Pcs #8
12 Pcs #10	16 Pcs 1/4"

**Tuercas**

24 Pcs #6-32	18 Pcs #8-32
12 Pcs #10-24	16 Pcs 1/4"

# PRODUCTOS





## DISCO PARA CORTAR METAL



CÓDIGO	MEDIDA	TIPO	USO	MAX. RPM
600020	7" X 1/8"	CON DIAMANTE	METAL	8,700
603020	14" X 7/64" X 1"	CON DIAMANTE	METAL	4,400



CÓDIGO	MEDIDA	TIPO	USO	MAX. RPM
601020	7" X 1/8"	CON DIAMANTE	CONCRETO	8,700



CÓDIGO	MEDIDA	TIPO	USO	MAX. RPM
601070	14" X 1/8" X 1"	SIN DIAMANTE	DESBASTE	4,400

### CARACTERISTICAS

- GRANO DE OXIDO DE ALUMINIO
- INTERNAMENTE CON FIBRA DE VIDRIO DE CAPAS DE ALTA RESISTENCIA A LA TRACCION.

### APLICACIONES

- TODOS LOS METALES
- ACERO
- BARRAS DE HIERRO, ETC.

### BENEFICIOS

- MAXIMA SEGURIDAD
- ACERO
- BARRAS DE HIERRO, ETC.

## DISCO PARA BAFER



CÓDIGO	MEDIDA	TIPO
620020	4" X 1/8" X 5/8"	SIN ROSCA
620050	4 1/2" X 1/8" X 5/8 - 11"	CON ROSCA
620060	4 1/2" X 1/4" X 7/8"	SIN ROSCA
620070	4 1/2" X 1/4" X 5/8 - 11"	CON ROSCA
620150	7" X 1/4" X 5/8 - 11"	CON ROSCA
615040	4 1/2 x 1/16 x 7/8	CON ROSCA
614160	4 x 1/16 x 1	SIN ROSCA
620140	7 x 1/4 x 7/8"	SIN ROSCA

## DISCO PARA CORTAR



DISCO DE ACERO PARA CORTADORA DE 24 DIENTES, 7 1/4", CERTIFICADO ISO 9001

**CÓDIGO: 717141B**

## DISCO PARA CORTAR



DISCO DE ACERO PARA CORTADORA DE 40 DIENTES, 7 1/4", CERTIFICADO ISO 9001

**CÓDIGO: 717143B**

## CEPILLO DE ALAMBRE TRENZADO EN DISCO



CÓDIGO	MEDIDA	TIPO	MAX. RPM
186030	6" X 3/16" X 5/8" - 110.020	ACERO AL CARBON	9,000
186040	6" X 3/16" X 5/8" - 11	0.020 ACERO INOXIDABLE	9,000

## CEPILLO DE RUEDA CON ALAMBRE



**DE 5/8"**

DISEÑADO PARA EL RETIRO DE MOHO, EL RETIRO DE LA PINTURA

**CÓDIGO: 183010**

## CEPILLO DE ALAMBRE TPARA BAFER



CÓDIGO	MEDIDA	TIPO
<b>188014B</b>	2-3/4" X M14X 2.0	CIRCULAR
<b>189070B</b>	2-3/4 X 5/8 - .020 C	TRENZADO

## CEPILLO DE ALAMBRE TRENZADO TIPO ESPIGA



CÓDIGO	MEDIDA
<b>181020B</b>	DE 1" X 1/4" - 0.020 ACERO AL CARBON

LIJAS DE AGUA MERCER PAQUETE DE 50 PZAS



CÓDIGO	DESCRIPCION
80C	LIJA DE AGUA GRADO 80C
100C	LIJA DE AGUA GRADO 100C
120C	LIJA DE AGUA GRADO 120C
150C	LIJA DE AGUA GRADO 150C
180C	LIJA DE AGUA GRADO 180C
220C	LIJA DE AGUA GRADO 220C
240C	LIJA DE AGUA GRADO 240C
280C	LIJA DE AGUA GRADO 280C
320C	LIJA DE AGUA GRADO 320C
360A	LIJA DE AGUA GRADO 360A
400C	LIJA DE AGUA GRADO 400C
500C	LIJA DE AGUA GRADO 500C
600A	LIJA DE AGUA GRADO 600A
1000C	LIJA DE AGUA GRADO 1000C
1200C	LIJA DE AGUA GRADO 1200C
L1500C	LIJA DE AGUA GRADO 1500C
2000C	LIJA DE AGUA GRADO 2000C

ROLLOS DE LIJA



LIJA DE ROLLO 1-1/2X50YD

CÓDIGO	DESCRIPCION
220R	LIJA DE ROLLO GRADO 220
180R	LIJA DE ROLLO GRADO 180

EXHIBIDOR DE LIJAS



CÓDIGO  
000DIS

LIJA DE TELA MULTUSOS

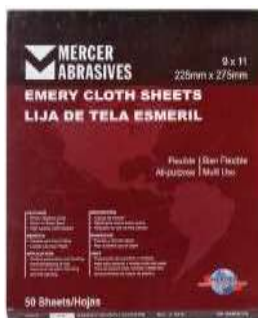

Uso de Materiales : Metales ferrosos, Metal, De metales no ferrosos, Pintar, Plástica, PVC, Caucho, Acero, Madera

Industria : Construcción, Sujetadores, Industrial, Trabajo En Metales, MRO, Pintar, Plomería, Alquiler, Trabajo de la madera

CÓDIGO  
216036



# DISCOS PARA LADRILLO, BLOCKS, PAVIMENTO Y STUCCO



**CORTE CONTINUO DE DIAMANTE,  
CONTE EN SECO Y/O HUMEDO**

CÓDIGO	MEDIDA
159107	DE 7"

# DISCOS PARA CORTAR METAL, DESBASTE Y CORTAR CONCRETO MARCA MARAGA POWER

**DISCOS PARA  
CORTAR METAL**



DE 7" x 1/8" x 5/8"  
**SIN ROSCA**  
CENTRO DE DIAMANTE  
CÓDIGO:  
**DA071858DCA**

**DISCO PARA  
CORTAR CONCRETO**



DE 7" x 1/8" x 5/8"  
**SIN ROSCA**  
CENTRO DE DIAMANTE  
CÓDIGO:  
**DA071858FLA**

**DISCOS PARA  
DESBASTE**

## CEPILLO DE RUEDA CON ALAMBRE TRENZADO DE 6" MARCA AJ



**DE 6"**  
DISEÑADO PARA EL RETIRO DE MOHO,  
EL RETIRO DE LA PINTURA Y LA  
MEZCLA DEL BORDE **6" RUEDA  
ANUDADA DE ALAMBRE**

**CÓDIGO: CHIW2154**

## BROCHAS PARA PINTAR MARCA AMERICAN



BROCHAS DE USO PROFESIONAL  
DE MANGO DE PLASTICO.  
EXELENTE PARA APLICACION DE  
PINTURA, QUITAR MANCHAS,  
APLICAR PEGAMENTO, ETC.

**CERDAS 100% NATURALES**

CÓDIGO	MEDIDAS
60032	2" (50.8 mm)
60034	3" (76.2 mm)
60036	4" (101.6 mm)

## RODILLOS PARA PINTAR



**C-9853**

5 ALAMBRE DE JAULA DE MARCO PROFESIONAL  
CON ROSTA INFERIOR PARA EXTENSION.



**B-6615**

MINI RODILLO 6" LARGO ALCANCE MARCO STICK PRINCIPAL 6.0mm BARRA CON CROMADO



**00413**

RODILLO MINI P/MARCO 3" 4 ALAMBRE DE JAULA DE MARCO SENCILLO.



**A-9643**

CON ROSTA INFERIOR PARA EXTENSION.  
4 ALAMBRE DE JAULA DE MARCO SENCILLO.  
PRINCIPAL CON BARRA 6.0mm CROMADO  
JAULA DE ALAMBRE 3.0mm CON CINCADE  
RODILLO FRAME 9.



**SENCILLO**  
SEMI-PRO. DE 4" C/ JAULA Y ROSCA P/ EXTENSION  
CÓDIGO: **MSP4**



**SENCILLO**  
SEMI-PRO. DE 4" SIN JAULA Y C/ ROSCA P/ EXTENSION  
CÓDIGO: **MMI4**



CÓDIGO: **91050**



CÓDIGO: **38150**

CÓDIGO	MEDIDA	COLOR
<b>91050</b>	9" RODILLO 1/2 GRUESOR	AMARILLO
<b>38150</b>	3" RODILLO 3/4 GRUESOR	AMARILLO

## REPUESTO PARA RODILLO DE PINTAR



CÓDIGO	MEDIDA	COLOR
<b>90012</b>	9" RODILLO 1/2 GRUESOR	ROSA
<b>90034</b>	9" RODILLO 3/4 GRUESOR	ROSA
<b>TT650-P</b>	6.5" RODILLO 1/2 GRUESOR	ROSA

## BROCHAS PARA PINTAR



**BROCHA 100% VIRUTA 2 1/2 CONOMICA**

PARA TODOS LOS RESULTADOS DE PINTURA

- EXCELENTE CON BASE DE AGUA EXCELENTE CON PINTURA LATEX

**CÓDIGO: 00005**



# PRODUCTOS

**FANDELI**<sup>®</sup>

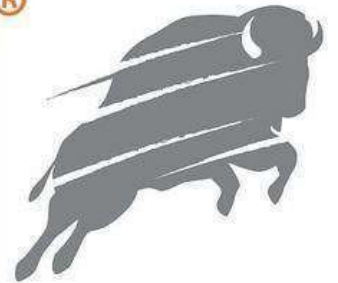

# TRAS PARA BONDO PROFESIONALES Y ALMOHADILLAS ABRASIVAS

## TIRA BONDO PARA DESBASTE PROFESIONAL LINEA AZUL



CÓDIGO	DESCRIPCION
17114	GRADO 36 DE 0.070m X 0.419m TELA PSA

## TIRA BONDO PARA DESBASTE PROFESIONAL LINEA AMARILLA



CÓDIGO	DESCRIPCION
20295	GRADO 60 DE 0.070m X 0.419m PAPEL PSA
03465	GRADO 80 DE 0.070m X 0.419m TELA PSA

## ALMOHADILLAS ABRASIVAS 6" x 9"



CÓDIGO	DESCRIPCION
1473	BLANCA S/G N/A
1502	MARRON FINA
1551	BEIGE MEDIANA
5633	VERDE MEDIANA
17034	NEGRA MEDIANA

# LIJAS FANDELI

## TELA DE ESMERIL UNIVERSAL LINEA NEGRA



CÓDIGO	GRADO	PAQUETE
00067	FINO 120	CON 50
00069	MEDIANA 80	CON 50
00066	X-GRUESO 36	CON 25
00068	GRUESA 50	CON 25

## TELA OXIALUM PROFESIONAL LINEA ROJA



CÓDIGO	GRADO	PAQUETE
00073	80	CON 50
00089	36	CON 25

## LONA DE BONDO PROFESIONAL LINEA ROJA



CÓDIGO	GRADO	PAQUETE
00075	120	CON 50
00091	50	CON 25

## PARA MADERA PROFESIONAL LINEA CAFE

EXHIBIDOR CONVENCIONAL PARA HOJAS, DE ALAMBRE CON 9 NIVELES INCLUYE DATOS DE LINEAS DE PRODUCTOS Y APLICACIONES

CÓDIGO: 00001L



CÓDIGO	GRADO	PAQUETE
00056	36	CON 25

## MIN BANDAS ALTO RENDIMIENTO LINEA MARRON



CÓDIGO	GRADO	MEDIDA
00915	60	3 X 18 in
00933	80	3 X 18 in
00955	100	3 X 18 in
00237	100	3 X 21 in
00238	60	3 X 21 in
01548	36	3 X 21 in
07564	80	3 X 21 in
07327	60	3 X 24 in
07568	80	3 X 24 in
07786	100	3 X 24 in
07937	120	3 X 24 in
00956	100	4 X 21 in
01213	80	4 X 21 in
02987	60	4 X 21 in
01546	100	4 X 24 in
01561	36	4 X 24 in
01564	60	4 X 24 in
07589	80	4 X 24 in
00878	120	3 x 18 in
00236	120	3 x 21 in
00875	60	4 x 36 in

## DISCO DE CONTACTO PSA GRANOS MEDIOS Y MUY FINOS

### ALTO RENDIMIENTO LINEA AMARILLA



CÓDIGO	GRADO	MEDIDA
04118	100	5"
04129	120	5"
04076	80	5"
04534	120	6"
04533	100	6"
18117	400	6"

## DISCO DE CONTACTO CON VELOCRO GRANOS MEDIOS Y MUY FINOS

### ALTO RENDIMIENTO LINEA AMARILLA



CÓDIGO	GRADO	MEDIDA
07703	80	5"
08291	100	5"
07140	120	5"
07098	180	5"
19229	320	5"

## DISCO DE FIBRA UNIVERSAL LINEA MARRON



CÓDIGO	GRADO	MEDIDA
00889	24	9"
00396	60	7"
00390	100	5"
00887	120	7"
00391	120	5"



## LJA DE AGUA PROFESIONAL LINEA NEGRA



CÓDIGO	GRADO	PAQUETE
00051	80	CON 50
00052	100	CON 50
00053	120	CON 50
00054	150	CON 50
00055	180	CON 50
00037	220	CON 50
00038	240	CON 50
00039	280	CON 50
00040	320	CON 50
00041	360	CON 50
00042	400	CON 50
00043	500	CON 50
05525	1000	CON 25
00048	1200	CON 25
00049	1500	CON 25
10965	2000	CON 25

## LJAS PARA MADERA PROFESIONALES LINEA



CÓDIGO	GRADO	PAQUETE
00057	40	CON 25
00058	50	CON 25
00059	60	CON 25
00060	80	CON 50
00046	100	CON 50
00047	120	CON 50
00780	150	CON 50
00204	180	CON 50
00205	220	CON 50
00206	240	CON 50
00207	280	CON 100
00208	320	CON 50
00209	360	CON 50

## LINEA PS-FORTE SUPER DELGADO

Para uso universal en la construcción, permiten corte precisos en concreto y piedra.

**Ventajas:** Cortes rapidos y precisos.



CÓDIGO	GRADO	MEDIDA mm (in)
669297	60	115 x 22 (4.5" x 7/8")

## DISCOS DE CORTE

### LINEA PS-FORTE CORTE ACERO

Para uso universal en el taller. Ideal para el corte de todo tipo de metales en tareas universales de corte.



CÓDIGO	GRADO	MEDIDA mm (in)
163436	24	178 x 22 (7" x 7/8")

## LINEA PS-FORTE CHOPSAW

Linea de usos generales, excelente opcion en el corte de materiales solidos, perfiles tubulares  
**Ventajas:** Corte rapido y limpio, evita retrabajos.



CÓDIGO	GRADO	MEDIDA mm (in)
736098	30	350 x 22 (13.5" x 7/8")

**LINEA SG-ELASTIC  
ALTO RENDIMIENTO**

Para uso profesional tanto en la industria  
Como en el taller.  
Potente disco de corte PFERD para un  
trabajo  
rápido y con mínima producción de reba-  
bas.



CÓDIGO	GRADO	MEDIDA mm (in)
499702	60	115 x 22 (4.5" x 7/8")
499733	60	125 x 22 (5" x 7/8")

**DISCOS DE CORTE**

**LINEA SG-ELASTIC  
ALTO RENDIMIENTO  
MINI DISCOS**

Ideales en el corte de acero fino, acero  
inoxidable, metales no ferricos y metales  
resistentes a altas temperaturas.  
Para uso profesional en talleres de  
repintado  
y la industria automotriz



CÓDIGO	GRADO	MEDIDA mm (in)
165669	60	50 x 6.0 (1.9" x 1/4")
165812	60	76 x 6.0 (3" x 1/4")

**LINEA PS-FORTE  
CORTE ESTANDAR**

Para el corte universal de piedra  
natural, artificial y refractaria.  
Brinda un buen balance entre  
costo-beneficio en tareas universals de  
corte.



CÓDIGO	GRADO	MEDIDA mm (in)
163665	30	115 x 22 (4.5" x 7/8")

**LINEA PS-FORTE UNIVERSAL  
CORTE INOX**

Para uso general en el taller.  
Multiples posibilidades de uso, ideal para  
materiales de sección fina.  
Fabricados sin aditivos férricos, sulfurosos  
y  
de cloro.

CORTE INOX



PS-FORTE

CÓDIGO	GRADO	MEDIDA mm (in)
538135	46	115 x 22 (4.5" x 7/8")

**LINEA PS-FORTE UNIVERSAL  
CORTE ACERO FINO-INOX**

Para cortar lamina, perfiles y material  
Macizo de acero fino-INOX

CORTE ACERO FINO-INOX



CÓDIGO	GRADO	MEDIDA mm (in)
523032	46	115 x 22 (4.5" x 7/8")

**LINEA PS-FORTE  
CORTE ACERO**

Para uso universal en el taller.  
Multiples posibilidades de uso,  
ideal para materiales de sección fina.

CORTE ACERO



PS-FORTE

CÓDIGO	GRADO	MEDIDA mm (in)
560242	60	115 x 22 (4.5" x 7/8")

**LINEA OXIDO DE ALUMINIO  
TIPO PSF-A**

**Herramienta de múltiples aplicaciones**  
Para trabajos de desbaste medio y lijado  
Universales en todos los materiales.

**Adecuada para:**

Esmeriladoras angulares de toda  
clase de potencia.

**Materiales de trabajo:**

Metales, plásticos y madera

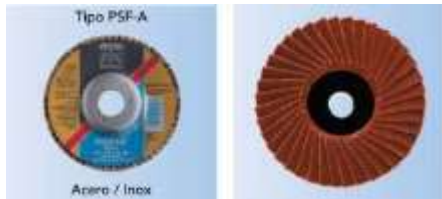

**DISCOS LAMINADOS POLIFAN  
LINEA ZIRCONIO  
TIPO PSF-Z**

**Herramienta potente para trabajos  
de desbaste medio y lijado universales.**  
Solución PFERD con arranque agresivo  
De material y larga vida, especialmente  
en tareas de canteado y eliminación  
de soldaduras.

**Materiales de trabajo:**

Acero y acero inoxidable  
Abrasivo



**LINEA OXIDO DE ALUMINIO  
TIPO SG-A**

**Herramienta de múltiples aplicaciones**  
Para trabajos de desbaste medio y lijado  
Universales en todos los materiales.

**Adecuada para:**

Esmeriladoras angulares de toda  
clase de potencia.

**Materiales de trabajo:**

Metales, plásticos y madera  
Abrasivo

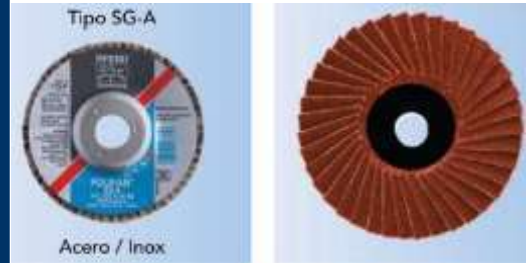

CÓDIGO	GRADO	MEDIDA mm (in)
444559	40	115 x 15 x 22 (4.5" x 7/8")
444566	60	115 x 15 x 22 (4.5" x 7/8")
444573	80	115 x 15 x 22 (4.5" x 7/8")
444696	60	180x 14 x 22 (7" x 7/8")

CÓDIGO	GRADO	MEDIDA mm (in)
444597	60	115 x 14 x 22 (4.5" x 7/8")
377369	80	115 x 14 x 22 (4.5" x 7/8")
444085	60	180 x 14 x 22 (7" x 7/8")

CÓDIGO	GRADO	MEDIDA mm (in)
167793	24	180 x 19 x 22 (7" x 7/8")
614969	24	115 x 17 x 22 (4.5" x 7/8")

**LINEA OXIDO DE ALUMINIO Y REFRIGERANTE  
TIPO SG-A-COOL**

**Herramienta profesional para trabajos de desbaste  
medio y lijado** que brinda resultados con alta  
calidad de superficie y mínima carga térmica.  
Solución PFERD con desbaste especialmente frío  
en materiales malos conductores del calor como  
el inoxidable.

**Materiales de trabajo:**

Acero inoxidable, aluminio y metales no ferrosos  
Abrasivo

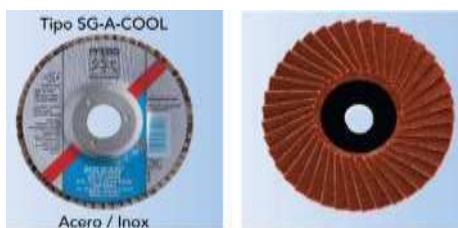

CÓDIGO	GRADO	MEDIDA mm (in)
232903	80	115 x 16 x 22 (4.5" x 7/8")
233016	80	180 x 16 x 22 (7" x 7/8")

**DISCOS DE CAMBIO RAPIDO**

CON RESPALDO DE TELA POLIESTER-ALGODON RESISTENTE.  
APLICACIONES:

- ◆ LIJADO DE SUPERFICIES CONCAVAS Y CONVEXAS.
- ◆ LIJADO PROFESIONAL DE CONTORNOS EN METALES.
- ◆ LIJADO DE SOLDADURA DE UNIONES EN LA INDUSTRIA AUTOMOTRIZ.
- ◆ AFINADO DE SUPERFICIES Y ELIMINACION DE IMPERFECCIONES.



CÓDIGO	GRADO	DIAMETRO
14497	60	3"





**FRAM**<sup>®</sup>



**Mobil**

# ACEITES



# ACEITE PARA MOTOR PLATINUM DE ALTA CALIDAD MARACA RACE TEAM 946ml



**MONOGRADO**



**5W30**



**10W30**



**10W40**



**20W50**

CÓDIGO	GRADO	API SERVICE
10304	5W30	SM, SL ILSAC GF-4, GF-3
10305	10W30	SM, SL ILSAC GF-4, GF-3

<b>MULTIGRADO</b>		
CÓDIGO	GRADO	API SERVICE
10306	10W40	SN
10307	20W50	SN

CÓDIGO	GRADO	API SERVICE
10302	40	SC

## ACEITE PARA TRANSMISION AUTOMATICA RACE TEAM 946ml



**NIVEL DE FUNCIONAMIENTO  
DEXROM-III, DEXROM-IIIE, DEXROM Y  
MERCOSIL D/M-3**

**CÓDIGO: 10308**

## ACEITE 2 TIEMPOS RACE TEAM 473ml



**CERTIFICADO G-4  
API SM-SL**

**CÓDIGO: 10409**

## ACEITE PARA TRANSMISION CASTROL 946ml



**CÓDIGO: ACATF**



**CÓDIGO: 06814**

## ACEITE PARA MOTOR CASTROL 946ml



### **MULTIGRADO**

CÓDIGO	GRADO
AC530	5W30
AC1030	10W30
AC1040	10W40
AC2050	20W50
AC520	5W20
ACHD40	SAE40

**CONTRA LA DESCOMPOSICION  
TERMICA**



## ACEITE CHEVRON DEL 40

### MONOGRADO

SAE 40  
API SERVICE SN

CÓDIGO:  
CHEV40



## ACEITE PARA TRANSMISION CHEVRON

PRECIO DE CAJA SOLO DE  
CONTADO.

TRANSMISION

MD-3 (ATF)

CÓDIGO:  
CHEVMD-3



## ACEITE PARA MOTOR CHEVRON

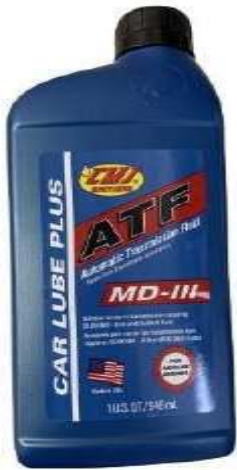

CÓDIGO: 20047

## ACEITE PARA MOTOR CHEVRON

PRECIO DE CAJA SOLO DE  
CONTADO.

### MULTIGRADO



CÓDIGO	GRADO
CHEV530	5W30
CHEV1030	10W30
CHEV1040	10W40
CHEV2050	20W50

## ACEITE PARA TRANSMISION MULTIVEHICULO CHEVRON

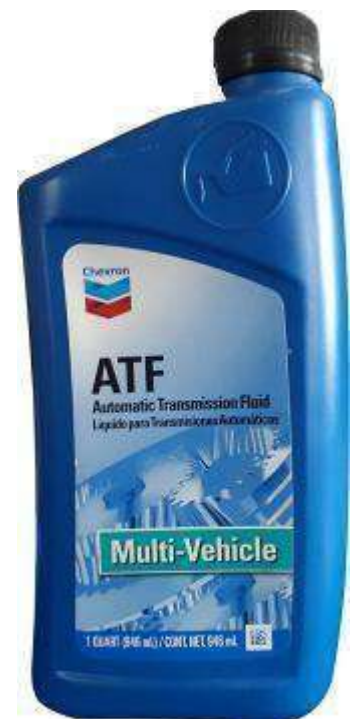

CÓDIGO: CHEVMV



# ACETE PARA MOTOR A GASOLINA

## CHEVRON SUPREME



SAE 20W-50

CÓDIGO: 38084



- Excelente protección anti-desgaste
- Protección contra fallas térmicas
- Ahorro de Energía

## CHEVRON SUPREME

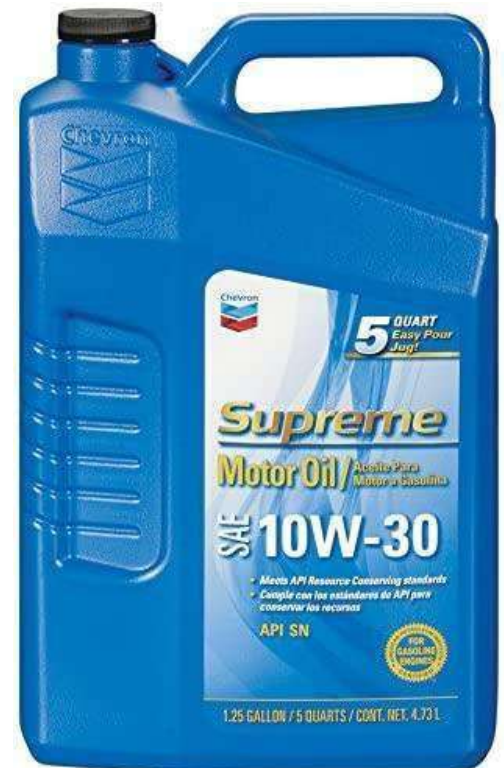

SAE 10W-30

CÓDIGO: 06404

CÓDIGO	GRADO
CHEV1030	10W30



CÓDIGO	GRADO
CHEV1040	10W40



CÓDIGO	GRADO
CHEV2050	20W50



CÓDIGO	GRADO
CHEVMD-3	MD-3

# ACEITE TOTALMENTE SINTÉTICO

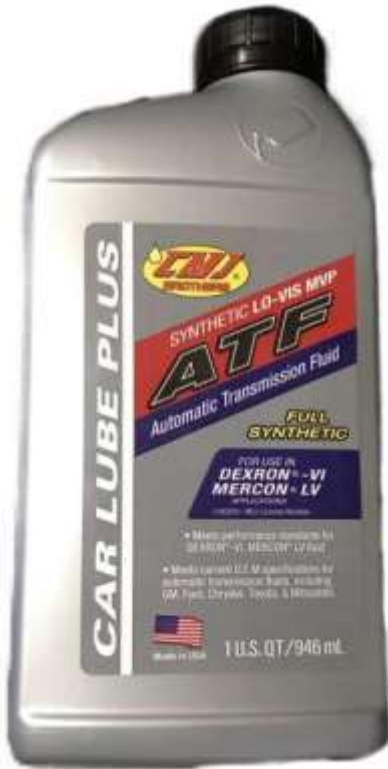

CÓDIGO

20051

## PROTECCIÓN EXTENDIDA PARA CONDICIONES DE MANEJO SEVERAS



CÓDIGO

04788

CÓDIGO

04776





## ACEITES PARA MOTOR 100% SINTETICOS



CÓDIGO	GRADO
AC5W30S	5W30
AC5W40S	5W40
AC5W50S	5W50
AC10W30S	10W30
AC10W40S	10W40



CÓDIGO	GRADO
APK0W20S	0W20
APK5W20S	5W20
APK5W30S	5W30
APK10W30S	10W30

## ANTICONGELANTE CONCENTRADO

ANTICONGELANTE MAXIMA PROTECCIÓN.

**LISTO PARA USARSE.**

PROTÉGÉ LA BOMBA DE AGUA Y EL TERMOSTATO CONTRA LA QUE CAVITACIÓN.

FORMULA DE TECNOLOGIA DE ACIDOS ORGANICOS ANTICORRO-SIVOS DE ULTIMA GENERACION.

A LA HORA DE REALIZAR EL CAMIO, PODRAS VER COMO SU COLOR SIGUE SIENDO ROSACEO.

**CÓDIGO: APO-60**

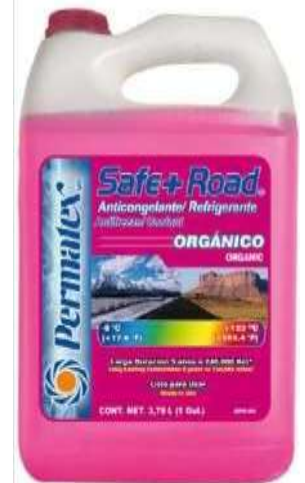

## ANTIFREEZES DIFERENTES MARCAS



El sistemas de enfria-  
miento queda protegido  
contra la ebullición hasta  
+135° C y contra la con-  
gelación hasta -50° C.  
Sus inhibidores de oxida-  
ción y corrosión prote-  
gen todos los metales  
del motor y sistema de  
enfriamiento incluyendo  
el aluminio

**CÓDIGO: ICE-50**



ANTICONGELANTE EXTREMA  
PROTECCION  
RESISTE EL OXIDO Y LA  
CORROSION  
**LISTO PARA USARSE**  
FORMULA AL<sup>3</sup> (PROTEGE  
ALUMINIO)

COLOR VERDE  
CONTENIDO NETO: 3.79 L

**CÓDIGO: APV-60**

# ANTIFREEZE DIFERENTES MARCAS



**CÓDIGO: 00500** 3.78L/ 1 GAL.

- 100% ANTICONGELANTE Y REFRIGERANTE.
- PROTEGUE ALUMINIO, TODO TIPO DE METALES



**CÓDIGO: 00225** 3.78L/ 1 GAL.

- 50/50 PRELUIDO ANTICONGELANTE Y REFRIGERANTE.
- CONFORMULA CONVENCIONAL(VERDE).



**CÓDIGO: 03328** 3.78L/ 1 GAL.

ANTICONGELANTE Y REFRIGERANTE, 100% PROTECCION A TODO TIPO DE METAL CONCENTRADO



TRABAJA EN TEMPERATURAS DE -36°C A 129°C

**CÓDIGO: 03329** 3.78L/ 1 GAL.

- ANTICONGELANTE Y REFRIGERANTE, 100% 50/50
- PARA CARROS DE BAJA DENSIDAD QUE REQUIEREN UN ANTICONGELANTE DE LARGA DURACION



**AMARILLO  
DE CONTACTO BASE SOLVENTE SUPER MIL 5"**

CÓDIGO	MEDIDA
DSM-125	125 ml
DSM-250	250 ml
DSM-500	500 ml



AMARILLO  
DE CONTACTO 50gr  
REPARADOR DE  
EMERGENCIA  
PEGA: HACER,  
ALUMINIO,  
BRONCE, COBRE, LATON,  
MADERA, CONCRETO,  
CERAMICA, VIDRIO, ETC

**CÓDIGO DSM-5**



BLANCO  
PEGA MADERA, CAR-  
TON,  
PAPEL, CERAMICA.  
IDEAL PARA  
INDUSTRIA, HOGAR  
Y MANUALIDADES  
**CONTENIDO 1KG**

**CÓDIGO PB-1K**



ALBAÑILERIA

## LLANA DENTADA PARA ALBIÑILERIA



CÓDIGO: **LL5PLDP**

## FLOTA DE HULE 4"X 12" X 3/4"



CÓDIGO: **FL-12H**

## TIRALINEAS PARA CONSTRUCCION MARCA CELTA

TIRALINEAS PARA CON-  
STRUCCION

CÓDIGO: **TIC-15**



## PISTOLA PARA APLICAR SILICON DE CARTUCHO



ECONOMICA

CÓDIGO

55-020

CHIC6932



TIPO ESQUELETO

CÓDIGO: **PSF3**

## LLANA DENTADA PARA ALBIÑILERIA MARCA CELTA



LLANA DENTADA PARA  
ALBAÑILERIA CON  
MANGO DE PLASTICO  
ROSA / NEGRO.

CÓDIGO: **110-88**

## RAYADOR PARA BANQUETA



RAYADOR PARA  
BANQUETA

CÓDIGO: **RDB**

# PRODUCTOS





**LIMPIAR DE INYECTORES BOYA**

**CÓDIGO: 54-D**  
DE 500ML

**LIMPIADOR DE INYECTORES**

DE 420g  
**CÓDIGO: 54-B**

**DESKARBOMEX BOTE**

DE 1 L  
**CÓDIGO: 51-B**

**LIMPIADOR PARA CUERPO DE ACELERACION**

**CÓDIGO: 58-A**

**SOLDADURA EN FRIO T 70 G**

**CÓDIGO: 61-A**

**LIMPIADOR PARA RADIADOR**

LIMPIA TODO TIPO  
DE RADIADORES  
CONTIENE 355ml  
**CÓDIGO: 21-B**

**SELLADOR DE FUGAS PARA RADIADOR**

SELLA FUGAS DE  
RADIADORES  
METALICOS  
**CÓDIGO: 22-C**

**LIQUIDO PARA FRENS BOTE 275ml****LIQUIDO PARA FRENS BOTE 946ml**

**CÓDIGO:**  
**83-A**



**CÓDIGO:**  
**83-B**

**ANTIERRAPANTE PARA BANDAS**

OPTIMUS 24-A  
LUBRICANTE  
SÓLIDO PARA  
TODO TIPO DE  
BANDAS IN-  
DUSTRIALES  
CAJA C/10 pzs.  
**CÓDIGO:**  
**24-A**

**SELLAC**

SELLADOR PARA  
EMPAQUES.  
RESISTENTE A  
TEMPERATURAS  
DE -55°C A  
+180°C  
CON 56g.



**CÓDIGO**  
**5-A**

**LIMPIADOR PARA RADIADORES****SELLADOR DE FUGAS PARA RADIADOR**

LIMPIADOR PARA RADIADOR EN MO-  
TORES A GASOLINA O DIESEL "SELLA-  
MAX" CARTERA C/15 pzs.

**CÓDIGO: 21-A**



SELLADOR PARA FUGAS DE RADIADOR  
EN MOTORES A GASOLINA O DIESEL  
"SELLA-MAX" CARTERA C/15 pzs.

**CÓDIGO: 22-A**

**GRASA ESMERIL VELOCIL**

GRASA ESMERIL CON PODEROSA FUERZA DE ABRASION QUE FACILITA  
EL RAPIDO ASENTADO DE VALVULAS EN MOTORES DE COMBUSTION  
INTERNA AFILADO DE HERRAMIENTAS PULIDO DE PIEZAS  
METALICAS

**BASE AGUA**  
**CON 115 grs.**

**CÓDIGO: 34-A**



**BASE GRASA**  
**CON 54 grs.**

**CÓDIGO: 31-A**

## AFOJATODO "SUPER PENETRANTE" PERMATEX

PENETRA, DISUELVE Y AFLOJA

CONTIENE 100g/3.5oz  
**CÓDIGO: 68-C**



## PASTA PARA PULIR MARCA MARVIL

BLANCA

ROJO



Su sistema de finos agentes abrasivos le permite eliminar los rayones y restos de pintura quemada sin dejar marcas y devolviendo el brillo perdido por la exposición a los agentes naturales y contaminantes del ambiente.

GRADO FINO

GRADO MEDIO

**CÓDIGO: 110213**

**CÓDIGO: 110218**

## SILICON RTV ROJO ALTAS TEMPERATURAS



- IDEAL PARA FORMAR
- PUNTAS EN MINUTOS
- EFECTIVO DE -40 C A 315 C.

**CÓDIGO**

**26-C**

## SOLUCIONA NEGRA DEVCON 2.54cm X 3m BLISTER

Para el sellado de fugas de líquidos y aire en tuberías o mangueras, así como un aislante en conexiones eléctricas

**CÓDIGO: SCN-1P**



## PULISH LIQUIDO RESTAURADOR MARVIL 473ml

Cera protectora, abrillantadora y limpiadora para pintura de autos nuevos y usados de cualquier superficies metálica pintada con esmalte o laca.

**CÓDIGO: 110693**





## PINTURA NEGRA PARA LLANTAS



**MAS BELLEZA Y DURACION. BOTE CON 500ml.**

**CUBRE PERFECTAMENTE RASPONES RENOVANDO LA APARIENCIA DE SUS LLANTAS.**

**CÓDIGO**

**110233**

## RELLENADO AUTOMOTRIZ LIGERO



**CREMA ENDURECEDORA + CATALIZADOR PARA RELLENAR GOLPES. SU CONSISTENCIA Y VISCOSIDAD HACEN QUE ESTA SEA EL COMPLEMENTO IDEAL PARA LA REPARACIÓN DE SUPERFICIES COLISIONADAS.**

**CÓDIGO MEDIDA**

**111015 240ML**

**110895 480ML**

## CERA LIQUIDA PARA AUTOS MARVL



**CERAS NATURALES+ SILICÓN. BRINDA LA MEJOR PROTECCIÓN A CUALQUIER TIPO DE PINTURA, RECUPERANDO SU BRILLO ORIGINAL Y PREVIENIENDO EL ENVEJECIMIENTO, DECOLORACIÓN Y DETERIORO DE TU AUTO, OCASIONADA POR EL SOL, AGUA, TIERRA Y LA CONTAMINACIÓN.**

**BOTELLA CON 521ml.**

**MAYOR PROTECCION**

**CÓDIGO**

**110065**



**CERAS NATURALES+ SILICÓN+ PTFE.**

**PRODUCE UN ALTO Y DURADERO BRILLO CUANDO SE PULE. DISEÑADA CON ACCIÓN LIMPIADORA COMBINADA CON CERAS NATURALES QUE PRODUCEN UNA SUPERFICIE TERSA CON BRILLO PROFUNDO Y DURADERO.**

**BOTELLA CON 521ml.**

**MAYOR PROTECCION**

**CÓDIGO**

**110811**

## CERA LIQUIDA PARA AUTOS MARVL



**LE BRINDA LA MEJOR PROTECCIÓN A CUALQUIER TIPO DE PINTURA, RECUPERANDO SU BRILLO ORIGINAL Y PREVIENIENDO EL ENVEJECIMIENTO, DECOLORACIÓN Y DETERIORO DE TU AUTO, OCASIONADA POR EL SOL, EL AGUA, LA TIERRA Y LA CONTAMINACIÓN.**

**BOTELLA CON 521ml.**

**DOBLE PROTECCION, SILICÓN + PTFE + RESINA ACRILICA.**

**CÓDIGO**

**111124**

## SHAMPOO LIQUIDO MARVL



**LIMPIA A FONDO DEJANDO UN ACABADO IMPECABLE. FÁCIL DE ENJUAGAR, SIN DEJAR MANCHAS. RINDE MÁS DEL DOBLE QUE LOS DEMÁS. DADA SU ALTA CONCENTRACIÓN (DILUIBLE HASTA 1/80) PROPORCIONA MÁS LAVADAS POR CADA BOTELLA QUE LOS DETERGENTES COMUNES.**

**BOTELLA CON 521ml.**

**CONSERVA EL BRILLO POR MAS TIEMPO.**

**CÓDIGO**

**110746**



**PASTA PARA PULIR RINES BLUE MAGIC  
200gr LARBITO**



**CÓDIGO:  
40012**

**PASTA BLUE MAGIC PARA PULIR RINES  
100gr EN TUBO**



**CÓDIGO: BLMG100**

**LIQUIDO RESTAURADOR DE FAROS BLUE MAGIC**



- PARA FAROS NUEVOS Y RESTAURADOS.
- MANTIENE LOS FAROS LIMPIOS Y BRILLANTES
- PROTÉGÉ LOS FAROS DE LOS RAYOS UV
- IMPIDEN LA ENTRA DE SUCIEDAD Y MUGRE
- PREVIENE EL AMARILLAMIENTO

**CÓDIGO:  
BLMG730**

**LIQUIDO RESTAURADOR DE FAROS BLUE MAGIC**



**CÓDIGO: BLMG725**

**SILICON ROJO C/70grs**

SE MANTIENE ESTABLE A TEMPERATURAS DE  
-40°C A 250°C

RESISTENTE A LA PRESIÓN.

PARA USO AUTOMOTRIZ.

TUBO CON 70g.



**CÓDIGO: 16208**

**TOALLA DE MICROFIBRA**



ELIMINA RAPIDAMENTE LOS  
PULIMIENTOS, CERAS Y  
SOBRANTES DE SPRAY.  
EXCELENTE RESULTADOS  
EN PINTURA DE AUTO,  
VENTANAS, PLASTICOS  
CROMOS.

# PRODUCTOS



## BLOCKSEAL HEAD GASKET REPAIR 567g

REPARA PERMANENTEMENTE JUSTAS DE CABEZAL ROTO, CABEZAL Y BLOQUES AGRIETADOS, FUGAS EN LAS JUSTAS DE ADMISION Y MAS. FUNCIONA EN HIERRO FUNDIDO Y ALUMINIO

**CÓDIGO: 21100**



## SELLADOR METALICO DE BLOQUE

- SELLA LAS FUGAS MAS GRANDES QUE LOS ELIMINADORES DE FUGAS REGULARES NO LOGRAN SELLAR
- PARA USO EN TODO TIPO DE AUTOMOVIL.
- NO DAÑA EL SISTEMA ANTICONGELANTE SI SE USA CORRECTAMENTE.

**CÓDIGO: 21108**



## SELLADOR DE BLOQUE PERMANENTE

SELLADOR PARA JUNTAS DE CABEZA PARA VEHICULOS DE 4 Y 6 CILINDROS

- DETIENE LAS FUGAS DE BLOQUE
- SELLADOR DE GRIETAS DE CULATA.
- DETIENE LA FUGA DE ANTICONGELANTE

**CÓDIGO: 21110**



## REPARADOR PARA EL SISTEMA DE ENFRIAMIENTO

- DETIENE LA PERDIDA DE LIQUIDO REFRIGERANTE.
- COMPATIBLE CON TODOS LOS ANTICONGELANTES
- REFORZADO CON FIBRA DE CARBONO.
- LUBRICA LA BOMBA DE AGUA
- PREVIENE LA CORROSION.

**CÓDIGO: 21150**



## SELLADOR DE FUGAS DEL RADADOR ALUMINO LIQUIDO

SELLA FUGAS EN RADIADORES DE PLASTICO, ALUMINIO Y METAL, PANELES DE CALEFACCION JUSTAS Y SELLOS.

- FORNULA DE DOBLE ACCION
- COMPATIBLE CON TODOS LOS ANTICONGELANTES

**CÓDIGO: 21184**



## SUPLEMENTO PARA ACEITE "HY-PER LUBE"

### PROTECCIÓN DIARIA DE ALTO RENDIMIENTO

- INCREMENTA LA RESISTENCIA DE LA CAPA PROTECTORA
- DISMINUYE LA TEMPERATURA
- PREVIENE LA DESCOMPOSICIÓN TÉRMICA
- REDUCE LA FRICCIÓN
- SILENCIA RUIDOS

**CÓDIGO: 24201**





## SELLADOR DE FUGAS PARA RADIADOR

- ACONDICIONA EL SISTEMA DE ENFRIAMIENTO.
- EVITA LA CORROSION Y OXIDACION.
- LUBRICA LA BOMBA DE AGUA.
- COMPATIBLE CON TODOS LOS ANTICONGELANTES

**CÓDIGO: 21192**



## ACEITE PARA GATOS HIDRAULICOS CON SELLADOR DE JUNTAS

- REPARA FUGAS EN LOS GATOS.
- NO GENERA CORROSION NI ESPUMA.
- CON ACONDICIONADOR.
- SE MEZCLA CON CUALQUIER ACAITE P/ GATOS.

**CÓDIGO: 22012**



## ENJUAGUE PARA EL RADIADOR EN 10mins

- RAPIDO, FACIL Y SEGURO DE USAR.
- NO CONTIENE ACIDOS, NO HAY NECESIDAD DE NEUTRALIZAR
- COMPATIBLE CON TODOS LOS ANTICONGELANTES

**CÓDIGO: 21211**



## LIMPIADOR Y SUPER ENJUAGUE

- LIMPIA EL SISTEMA DE ENFRIAMIENTO COMPLETO.
- REMUEVE DEPOSITOS Y LA FORMACION DE GEL EN EL REFRIGERANTE.
- LIMPIEZA COMPLETA EN 30 MINUTOS O MENOS

**CÓDIGO: 21240**



## LUBRICANTE PARA LA BOMBA DEL AGUA Y ANTIOXIDANTE

- PROTÉGÉ LAS PARTES DE ALUMINIO, COBRE, HIERRO Y TODAS LAS DEMAS PARTES DEL SISTEMA DE ENFRIAMIENTO
- CON LUBRICANTES PARA EL TERMOSTATO.
- COMPATIBLE CON TODOS LOS ANTICONGELANTES

**CÓDIGO: 21311**



## TRATAMIENTO PARA MOTOR

- ADITIVO ANTIFRICCIÓN
- SILENCIA LAS VALVULAS
- REDUCE FRICCIÓN Y DESGASTE
- MAXIMIZA LA POTENCIA DEL MOTOR

Cont. Net. 946ml

**CÓDIGO: 24100**



## REPARADOR DE MOTOR CON PROTECCION ADICIONAL

- RESTAURA EL RENDIMIENTO DEL MOTOR.
- AUMENTA LA COMPRESION Y LA POTENCIA.
- ELIMINA LAS FUGAS, LOS RUIDOS Y EL HUMO.
- FORMULA DE 2 PARTES.

**CÓDIGO: 24110**



## SELLADOR DE FUGAS

### CONCENTRADO PARA

RESTAURA JUNTAS Y SELLOS PARA DETENER Y PREVENIR FUGAS DE ACEITE DEL MOTOR.

COMPATIBLE CON TODOS LOS ACEITES PARA MOTOR.

DETIENE Y SELLA FUGAS DEL MOTOR.

**CÓDIGO: 24209**



## REPARADOR PARA EL RETEN DEL CIGÜEÑAL

- RESTAURA LOS SELLOS DEL CIGÜEÑAL.
- REPARADOR DEL RETEN DE TAPA DE TIEMPO
- SELLA PERDIDAS DE ACEITE PARA MOTOR.
- CON POLIMEROS QUIMICOS.

**CÓDIGO: 24240**



## ELIMINADOR DE HUMO CONCENTRADO

ELIMINA EL CONSUMO DE ACEITE, SELLA LAS FUGAS DE ACEITE Y REDUCE EL HUMO DE ESCAPE.

- ES UN TRATAMIENTO PARA EL MOTOR.
- FORMULA DE TRIPLE ACCION
- REVISTE LAS PARTES INTERNAS DEL MOTOR.

**CÓDIGO: 24326**



## SELLADOR DE ANILLOS ADITIVO PARA ACEITE

EVITA EMISIONES DE HUMO AZUL CONTAMINANTE,

- REDUCE EL CONSUMO DE ACEITE
- SELLA ANILLOS Y PISTONES DESGASTADO.
- AMORTIGUA Y RECUBRE LAS PARTES DEL MOTOR.

**CÓDIGO: 24416**



## REPARADOR DE COMPRESION CON SELLADOR DE ANILLOS

ALGUNOS DE SUS BENEFICIOS SON:

- Renueva motores desgastados
- Reconstruye compression
- Restaura la energía Perdida

**CÓDIGO: 24447**





## TRATAMIENTO DE ALTO RENDIMIENTO PARA ACEITE

- SILENCIA MOTORES Y LEVAS RUIDOSAS.
- AUMENTA LA PRESION DEL ACEYTE.
- EVITA EL DESGASTE DEL MOTOR.
- COMPATIBLE CON TODOS LOS ACEITES.



**CÓDIGO: 24471**

## ESTABILIZADOR DE ACEITE PARA TRANSMISION CON SELLADOR DE FUGAS

- ELIMINA LAS PATINADAS.
- EVITA LOS CAMBIOS BRUSCOS
- DETIENE LA PERDIDA DE LIQUIDOS.
- PARA TODO TIPO DE TRANSMISIONES
- **REDUCE RUIDO Y VIBRACIONES.**

**CÓDIGO: 24502**



## SELLADOR DE FUGAS CONCENTRADO

ESPECIALMENTE DISEÑADO PARA DETENER FUGAS EN SELLOS Y JUNTAS CAUSADAS POR EL USO CONTINUO Y DESGASTE NORMAL DEL SISTEMA DE TRANSMISION.

COMPATIBLE CON TODOS LOS ACEITES.

**CÓDIGO: 24519**



## REPARADOR DE TRANSMISION AUTOMATICA

- RESTAURA EL RENDIMIENTO.
- REDUCE LA FRICCION Y ESTABILIZA EL ACEITE
- DETIENE LA PERDIDA DE LIQUIDOS.
- CON SELLADOR DE FUGAS.
- **COMPATIBLE CON TODOS LOS ACEITES**

**CÓDIGO: 24540**





## SELLADOR DE FUGAS CONCENTRADO PARA DIRECCION HIDRAULICA



- ESPECIALMENTE DISEÑADO PARA DETENER FUGAS EN SELLOS Y JUNTAS CAUSADAS POR EL USO CONTINUO Y DESGASTE NORMAL DE LA DIRECCION HIDRAULICA.
- COMPATIBLE CON TODOS LOS ACEITES.

CÓDIGO: **24629**

## REPARADOR DE DIRECCION HIDRAULICA



- MEJORA LA VISCO-SIDAD DEL ACEITE.
- CONTIENE DETERGENTES.
- RESTAURA EL RENDIMIENTO DE POWER
- CON ACONDICIONADOR DE SELLOS

CÓDIGO: **24650**

## TRATAMIENTO CONCENTRADO PARA SISTEMAS A GASOLINA

INCREMENTA LA POTENCIA, EL RENDIMIENTO Y AHORRA GASOLINA LIMPIANDO Y LUBRICANDO EL SISTEMA COMPLETO DEL COMBUSTIBLE

- LIMPIA LA BOMBA DE GASOLINA E INYECTORES.
- OPTIMIZADOR DE OCTANAJE.

CÓDIGO: **24700**



## LIMPIADOR DE INYECTORES Y TRATAMIENTO DE COMBUSTIBLE

- CON ACONDICIONADOR.
- MAXIMIZA LA POTENCIA Y EL KILOMETRAJE
- LUBRICA LOS SISTEMAS DE COMBUSTIBLE
- PARA GASOLINA Y DIESEL

CÓDIGO: **24701**



## AUMENTADOR DE OCTANAJE

INCREMENTA EL OCTANAJE DEL COMBUSTIBLE, RESTAURA LA POTENCIA Y EL RENDIMIENTO PERDIDO.

- EVITA LAS DETONACIONES DEL MOTOR

CÓDIGO: **24747**



## TRATAMIENTO PARA GASOLINA SUPER CONCENTRADO

- DE ALTO RENDIMIENTO
- PREVIENE LA GOMOSIDAD Y EL BARNIZ
- LUBRICA LOS SISTEMAS DE COMBUSTIBLE
- MEJORA LA CALIDAD DE LA GASOLINA

CÓDIGO: **24777**



## SUPERSELLADOR DE FUGAS

FORMULA PARA MULTIPLES SISTEMAS  
SELLA Y DETIENE FUGAS RAPIDAMENTE EN:  
MOTORES  
TRANSMISIONES  
SERVODIRECCIONES  
SISTEMAS HIDRAULICOS  
ENGRANAJES Y EJES

CÓDIGO: **24305**



## ESPAULAS DE PLASTICO



UTILICE C/ BONDO, RESINA DE FIBRA DE VIDRIO, MASILLAS, ETC. BRINDA ACABADO LISO, QUE SIGNIFICA MENOS

PAQUETE C/ 3PZS  
TAMAÑOS:

- 7cm x 10cm (2 3/4" x 4")
- 7.6cm x 13.3mm ( 3" x 5 1/4")
- 8.9cm x 15.9cm (3 1/2" x 6 1/4")

## MASKING TAPE



CÓDIGO	MEDIDA
126102	1/2"
126119	3/4"
126140	2"

## TAPE NEGRO ECONOMICO 3M



CINTA ELECTRICA DE VINILO ECONOMICO Y TEMPERATURA HASTA DE 80° C (176° F)

**CÓDIGO:**  
**58297**

## TAPE NEGRO 3M TEMFLEX



AGUANTA HASTA 600v. Y TEMPERATURA DE 0° C (-32° F) a 80° C (176° F)

**CÓDIGO:**  
**105725**

## ONIA AISLANTE



ROLLO DE 3/4" x 60FTS  
**CÓDIGO: TAIT0788**



ROLLO DE 3/4" x 50FTS.  
**CÓDIGO: 70020**





## NAVAJA PARA CARTON ARENADO



- NAVAJA P/CARTON ARENADO**
- CUBIERTA DE AXERO DE KA GALGA PESADA
  - AJUSTABLE PROFUNDIDAD DE LA LAMINA
  - SOSTENEDIOR DE LA LAMINA

**CÓDIGO: 114-40**

## REPUESTO NAVAJA PAQUETE CON 5pz



- HOJA DELGADA PERO UN MEJOR CORTE
- ACERO INOXIDABLE

**CÓDIGO: 114-37**

## NAVAJA RETRACTIL DE 6" PARA YEZERO



INCLUYE 5 NAVAJAS  
USO PROFESIONAL.  
U.S.A.

**CÓDIGO: 03-996**



## NAVAJA PLEGABLE



INCLUYE 5 NAVAJAS  
FACIL CAMBIO DE NAVAJA.  
SEGURO BLOQUEADOR DE  
SEGURIDAD.

**CÓDIGO**

**CHIK0014-05**

## NAVAJA PARA MULTIPLES TAREAS



NAVAJA DE UTILIDAD  
W/5. DE 6"  
INCLUYE NAVAJA  
U.S.A.

**CÓDIGO: W-145**

## NAVAJA TIPO CUTER



NAVAJA TIPO CUTER  
PARA MULTIPLES  
TAREAS.

**CÓDIGO: 52662**

## PASO DE BROCA DE TITANO



90035

90037

90039

90041

90042

90043

90047

90048

DESCRIPCION	MEDIDAS	CÓDIGO
PASO BROCA DE TITANIO 1/8 A 1/2"	-1/8", -5/32", -3/16", -7/32", -1/4", -9/32", -5/16", -11/32", -13/32", -7/16", -15/32", -1/2"	<b>90035</b>
PASO BROCA DE TITANIO 7/16 A 1-1/8"	-7/6", -1/2", -9/16", -5/8", -11/16", -3/4", -13/16", -7/8", -15/16", -1-1/16", -1-1/8"	<b>90037</b>
PASO BROCA DE TITANIO 1/8 A 7/8"	-1/8", -3/16", -1/4", -5/16", -3/8", -7/16", -1/2", -9/16", -5/8", -11/16", -3/4", -13/16", -7/8"	<b>90039</b>
PASO BROCA DE TITANIO 3/16 A 1/2"	-3/16", -1/4", -5/16", -3/8", -7/16", -1/2"	<b>90041</b>
PASO BROCA DE TITANIO 1/4 A 3/4"	-1/4", -5/16", -3/8", -7/16", -1/2", -9/16", -5/8", -11/16", -3/4"	<b>90042</b>
PASO BROCA DE TITANIO 3/16 A 7/8"	-3/16", -1/4", -5/16", -3/8", -7/16", -1/2", -9/16", -5/8", -11/16", -3/4", -13/16", -7/8"	<b>90043</b>
PASO BROCA DE TITANIO 9/16 A 1"	-9/16", -5/8", -11/16", -3/4", -13/16", -7/8", -15/16", -1"	<b>90047</b>
PASO BROCA DE TITANIO 13/16 A 1-3/8"	-9/16", -5/8", -11/16", -3/4", -13/16", -7/8", -15/16", -1"	<b>90048</b>

## PASO BROCA TITANIO PQTE 3 PCS



CÓDIGO

93264

MEDIDA

-3/16", -1/4", -5/16", -3/8", -7/16", -1/2"

-1/4", -5/16", -3/8", -7/16", -1/2", -9/16", -5/8", -11/16", -3/4"

-1/8", -5/32", -3/16", -7/32", -1/4", -9/32", -5/16", -11/32", -13/32", -7/16", -15/32", -1/2"

## PASO BROCA TITANIO PQTE 2 PCS



CÓDIGO

40434

MEDIDA

1/4"; 25/64"; 35/64"; 11/16"; 13/16"; 7/8"; 1"; 1 - 1/8"; 1 - 7/32"; 1 - 1/4"; 1 - 3/8."

-3/16", -1/4", -5/16", -3/8", -7/16", -1/2", -9/16", -5/8", -11/16", -3/4", -13/16", -7/8"



# PASO BROCA ACERO Y TITANIO PQTE 9 PCS



CÓDIGO

90062



## MEDIDA

-3/16", -1/4", -5/16", -3/8", -7/16" -1/2"

-1/4", -5/16", -3/8", -7/16", -1/2", -9/16", -5/8", -11/16", -3/4"

-1/8", -5/32", -3/16", -7/32", -1/4", -9/32", -5/16", -11/32", -13/32", -7/16", -15/32", -1/2"

# PASO BROCA ACERO Y TITANIO PQTE 5 PCS

CÓDIGO  
90045



## MEDIDA

1/4"; 25/64"; 35/64"; 11/16"; 13/16"; 7/8"; 1"; 1 - 1/8"; 1 - 7/32"; 1 - 1/4"; 1 - 3/8."

-3/16", -1/4", -5/16", -3/8", -7/16", -1/2", -9/16", -5/8", -11/16", -3/4", -13/16", -7/8"

# PRODUCTOS QUIMICOS MARCA "PRODEL"



ACEITE DE LINAZA  
ECONOMICO 1lt  
CÓDIGO: ALE



ACEITE DE LINAZA  
DOBLE COCIDO 1lt  
CÓDIGO: ALDC



PETROLEO 1lt  
CÓDIGO: PET



CREOLINA 1lt  
CÓDIGO: CREO



AGUARRAS 1lt  
CÓDIGO: AGV



RETARDADOR PARA  
PINTURA 1lt  
CÓDIGO: RP



GASOLINA BLANCA 1lt  
CÓDIGO: GBV



CARBUTHINNER 1lt  
CÓDIGO: CTV



REMOVEDOR DE  
PINTURA 1lt  
CÓDIGO: RDP



REMOVEDOR DE  
PINTURA 1lt  
SUPER REMOVEDOR  
CÓDIGO: SRP

## MANDIL DE MEZOLILLA



UNITALLA

CÓDIGO:  
ME-1000

## THINNER



CÓDIGO	CONTENIDO
TH-1B	1 LITRO

## ACEITE LUSTRADOR PARA PISOS



CÓDIGO	CONTENIDO
ALPP	1 LITRO
ALPPG	1 GALON

## VENENO PARA HORMIGAS



VENENO PARA  
HORMIGAS  
EN POLVO

CONTIENE 225grs

## ACIDO MURIATICO



CÓDIGO	CONTENIDO
AMUL	1 lt.
AMUG	1 galon

## SOSA CAUSTICA



CÓDIGO	CONTENIDO
SC-1	1 kg.
SC-1/2	1/2 kg.



## LIQUIDO PARA FRENOS



RESISTENTE PARA SISTEMAS DE DISCO, TAMBOR Y ABS

CÓDIGO	MEDIDAS
2212	12oz
2232	32oz

## LIQUIDO PARA POWER



CON ACONDICIONADORES QUE DETIENEN EL GOTEO.

CÓDIGO	MEDIDAS
4611	1 GAL.

## WD-40 AFLOJA TODO



CÓDIGO	CONTENIDO	CÓDIGO	CONTENIDO
110108	DE 3oz.	10013	DE 13.2oz
10005	DE 5.5oz	10016	DE 16oz
11005	DE 8oz	10110	DE 1gal.
10011	DE 11oz		

## ATOMIZADOR PARA WD 40



BOQUILLA REGULABLE,

PLASTICO DURADERO

PERFECTO PARA USUARIOS PESADOS DE WD-40

CÓDIGO	CAPACIDAD
10000	16 oz.

## ACEITE LUBRICANTE UNIVERSAL

2 GOTAS BASTAN AFLOJA TODO

APLICACIONES:

- PENETRACION INSTANTANEA.
- ELIMINA FRICCION Y DESGASTE.
- PARA CUALQUIER CLIMA.
- PREVIENE OXIDACION.
- PREVIENE CORROSION.
- FORMULA EXCLUSIVA



CÓDIGO	CONTENIDO
300541	90 ml



## ETER (STARTING FLUID)

AUXILIAR DE ENCENDIDO (LIQUIDO DE ARRANQUE) EN SPRAY CON 11oz.

**CÓDIGO: 85341**

## DESPONCHADOR CON MANGUERA



INFLA Y DESPONCHA TODO TIPO DE NEUMATICOS CONTIENE 500 ml.

**CÓDIGO: 692457**

## PEGAMENTO MARCA MASTER

MASTER PARA PARCHES LATA DE 8 OZ.

**CÓDIGO: 540-C**



## SET REPARACION LLANTAS 15PCS



**CODIGO 93159**

## KIT REPARADOR DE LLANTAS CON 6pzs



**CÓDIGO: CHIT0005**

## PARCHES PARA BICICLETAS



**CODIGO 00402-8**

**6 piezas**

## PEGAMENTO AMARILLO PRO SEAL



**CODIGO 88881**

## KIT REPARADOR DE LLANTAS CON 55pzs



**CODIGO 90420**

## FOCO MINI CAJA CON 10pzs



### PELLIZCO CHICO PARA TABLERO

CÓDIGO	COLOR	CÓDIGO	COLOR
73	CLARO	158	CLARO
73-A	AMBAR.	158-A	AMBAR
73-B	AZUL		
73-P	PURPURA		

### PELLIZCO GRANDE PARA TABLERO

CÓDIGO	COLOR
921	CLARO
921-A	AMBAR
921-B	AZUL
921-R	ROJO
921-P	PURPURA
921-G	VERDE

## FOCO TIPO FUSIBLE CON 10pzs



CÓDIGO	TAMAÑO
2026000	CHICO
2030000	MEDIANO
2036000	CHICO
211	GRANDE



FOCO PARA LUZ INTERIOR **SIN CASQUILLO**  
GENERAL ELECTRIC U.S.A.

CÓDIGO
1947000
1980000



FOCO PARA LUZ INTERIOR **CON CASQUILLO**  
GENERAL ELECTRIC U.S.A.

**CÓDIGO: 1946000**

# PRODUCTOS





## LUCAS ADITIVO PARA GASOLINA



**EL PRECIO DE CAJA ES UNICAMENTE EN PAGO DE CONTADO.**

**LIMPIADOR DE INYECTORES. REDUCE: PISTONEO, EFECTO "DIESEKING", EMISIONES CONTAMINANTES Y FALLAS.**

CÓDIGO	CONTENIDO
30020	155ml.
30003	946ml
30013	1gal.

## LUCAS ESTABILIZADOR PARA ACEITE DE MOTOR



**EL PRECIO DE CAJA ES UNICAMENTE EN PAGO DE CONTADO.**

PROPORCIONA AMPLIA PROTECCION A LOS MOTORES NUEVOS, Y AYUDA A EVITAR EL HUMO, EL PISTONEO Y EL ALTO CONSUMO DE ACEITE EN MOTORES MAS VIEJOS.

CÓDIGO	CONTENIDO
30001	946ml.
30002	1gal.

## LUCAS REPARADOR DE TRANSMISIONES



**EL PRECIO DE CAJA ES UNICAMENTE EN PAGO DE CONTADO.**

ELIMINA EL DESLIZAMIENTO, LIMPIA Y LUBRICA VALVULAS PEGADIZAS. PARA UN CAMBIO ADECUADO, DETIENE FUGAS DE ACEITE, CONTROLA EL RECALENTAMIENTO Y RENUEVA EL FLUIDO GASTADO.

CÓDIGO	CONTENIDO
30009	700ml.

## LUCAS SELLADOR DE FUGAS EN LA DIRECCION HIDRAULICA



**EL PRECIO DE CAJA ES UNICAMENTE EN PAGO DE CONTADO.**

REMUEVE PIÑONES Y CREMALLERAS. CONTROLA EL JUEGO, CHIRRIDOS, PUNTOS DUROS Y DIRECCIONES PESADAS.

**CONTIENE 355ml = 12 Oz**

CÓDIGO	CONTENIDO
30008	355ml.

## LUCAS LIQUIDO PARA POWER STEERING



**EL PRECIO DE CAJA ES UNICAMENTE EN PAGO DE CONTADO.**

**ESTA DISEÑADO CON ADITIVOS ESPECIALES**

CÓDIGO	CONTENIDO
10824	946ml.

## LUCAS CERA LIQUIDA SLICK MIST SPEED WAX



**EL PRECIO DE CAJA ES UNICAMENTE EN PAGO DE CONTADO.**

ES UN POLIMERO INTENSIFICADOR DE BRILLO DE LA PINTURA. IDEAL PARA TODO TIPO DE PINTURAS. PROPORCIONA UNA PROTECCION DE LARGA DURACION.

CONTIENE PROTECCION CONTRA LOS RAYOS UV.

CÓDIGO	CONTENIDO
10160-2	710ml.

## LUCAS LUBRICANTE PARA CADENAS



LUBRICANTE  
PARA CADENAS  
PENETRA,  
LUBRICA Y  
EXTIENDE  
LA VIDA DE LAS  
CADENAS.

CÓDIGO	CONTENIDO
10393	311 ml. 11 oz

## LUCAS FLUIDO DE POWER STEERING

FLUIDO PARA  
POWER  
STEERING



CÓDIGO	CONTENIDO
10823	355 ml. 12 oz



EXTRA ALTA  
DURACION  
ACEITE PARA MOTOR  
10W-40  
ALTO MILLAJE

CÓDIGO
10275



EXTRA ALTA  
DURACION  
ACEITE PARA MOTOR  
20W-50  
ALTO MILLAJE

CÓDIGO
10252



EXTRA ALTA  
DURACION  
ACEITE PARA MOTOR  
10W-30  
AHORRADOR  
DE GASOLINA

CÓDIGO
10276



SEMI-SINTETICO  
ACEITE PARA  
TRANSMISIÓN  
AUTOMATICA  
MULTI-VEHÍCULO  
DE ALTA DURACIÓN

CÓDIGO
10418

# SWITCHES DE UNO Y DOS PASOS



DE 2 PASOS  
CÓDIGO: 2101



DE 1 PASO ECO.  
CÓDIGO: 127-AH

SWITCH 1 PASO DE 2 PUNTAS  
REFORZADO.

CÓDIGO: 03323



DE 2 PASOS ECO.  
CÓDIGO: SW-2



DE 1 PASO ECO.  
CÓDIGO: SW-1

## FLASHERS



LARGO, TRANSPARENTE  
Y REFORZADO HD



ECONOMICO 552



REFORZADO  
DE ALUMINIO  
552-A/ 550-A

CÓDIGO	DESCRIPCION
--------	-------------

552	CON 2 PATAS
-----	-------------

552-A	CON 3 PATAS
-------	-------------

550-A	CON .3 PATA
-------	-------------

CÓDIGO	DESCRIPCION
--------	-------------

552-HD	CON 2 PATAS
--------	-------------

550-HD	CON 3 PATAS
--------	-------------

## ENCENDEDOR UNIVERSAL DE CIGARROS PARA AUTO



SIN LUZ  
CÓDIGO: C-134

MINI DE LUJO  
CÓDIGO: C-136



CON LUZ  
CÓDIGO: C-135



## BOTON DE START DE 1 POLO GENERICA



SIN LUZ

CÓDIGO: 03327

RELEVADOR DE  
5 PUNTAS  
UNIVERSAL  
30 AMP/ 14VDC - 12V  
CÓDIGO: RL-5X



## BOTON PARA STAR Y CLAXON



DE 2 PASO

CÓDIGO: TS-113



CÓDIGO: HB-01

## SWITCH DE ENCENDIDO UNIVERSAL



ECONOMICO  
CÓDIGO: 07-1214



GENERAL ELECTRIC  
CÓDIGO: 25535



## SOLENOIDE DE MARCHA PARA CHEVROLET



SOLENOIDE DE MARCHA DELCO 5mt, 10mt  
BOTELLA CORTO.

VOLATEJE: 12v.

OEM: D984

SISTEMA OEM: DELCO

WAI: 66-100

UNIPOINT: SNLS145

SERIE: 5MT, 10MT, 27MT, SD200, SD250,

SD300, 15

**CÓDIGO: 11829**

## SOLENOIDE DE MARCHA PARA CHEVROLET



SOLENOIDE DE MARCHA DELCO 5mt, 10mt  
( zm551 )

- SOLENOIDE BOTELLA NORMAL

-VOLATEJE: 12v.

-OEM: 1114256

-SISTEMA OEM: DELCO

-WAI: 66-101-1

-UNIPOINT: SNLS143

-SERIE: 5MT, 8MT, 10MT, 20MT, 25MT, 27MT,

SD200

**CÓDIGO: 11831**

## SOLENOIDE PARA FORD

TIPO VIEJO  
CÓDIGO: SW3-A



TIPO NUEVO  
ACCURATE  
CÓDIGO: 1533-ACU





COLILLA DE UN POLO  
CON RESORTE  
PARA FOCO DEL 53.  
**CÓDIGO: 3312**



COLILLA DE UN POLO  
CON RESORTE  
PARA FOCO  
**CÓDIGO: 3313**



COLILLA DE 2 POLO CON RESORTE PARA  
FOCO.  
**CÓDIGO: 3314**

## FUSIBLES



**EXTRA GRANDE**

CÓDIGO	AMPERAJE
ATX20	20AMP
ATX25	25MP
ATX30	30AMP
ATX40	40AMP
ATX50	50AMP
ATX60	60AMP
ATX70	70AMP
ATX80	80AMP
ATX90	90AMP
ATX100	100AMP



**CLAVIJA**

CÓDIGO	AMPERAJE
ATC5	5AMP.
ATC7.5	7.5AMP.
ATC10	10AMP.
ATC15	15AMP.
ATC20	20AMP.
ATC25	25AMP.
ATC30	30AMP.
ATC40	40AMP.



**MINI**

CÓDIGO	AMPERAJE
ATM10	10AMP.
ATM15	15AMP.
ATM20	20AMP.
ATM25	25AMP.
ATM30	30AMP.



**DE CRISTAL**

CÓDIGO	AMPERAJE
SFE3	3AMP
SFE4	4AMP
SFE7 ½	7.5AMP
SFE9	9AMP
SFE10	10AMP
SFE14	14AMP
SFE15	15AMP
SFE20	20AMP
SFE25	25AMP
SFE30	30AMP

### TIPO MUELA



**MACHO**

CÓDIGO	AMPERAJE
BLANCO-M	20AMP
ROSA-M	30AMP
VERDE-M	40 AMP
ROJO-M	50 AMP
AMARILLO-M	60 AMP
CAFÉ-M	70 AMP
NEGRO-M	80 AMP
AZUL-M	100 AMP
CAFE120-M	120 AMP
VIOLETA-M	130 AMP



**HEMBRA**

CÓDIGO	AMPERAJE
BLANCO-H	20AMP
ROSA-H	30AMP
VERDE-H	40AMP
ROJO-H	50AMP
AMARILLO-H	60AMP
CAFÉ-H	70AMP
NEGRO-H	80AMP
AZUL-H	100AMP
NEGRO120-H	120 AMP

### FUSIBLE MINI TIPO MUELA HEMBRA PARA NISSAN SENTRA



CÓDIGO	PARA FUSIBLE
AZUL-HM	20AMP
BLANCO-HM	25AMP
ROSA-HM	30AMP
VERDE-HM	40AMP
AMARILLO-HM	60AMP

### FUSIBLE TIPO MUELA CHICO



**CÓDIGO**  
**43608C**

### FUSIBLE TIPO MUELA CHICO



**CÓDIGO**  
**43624C**

## FUSIBLES CLAVIJA ESTUQUE CON 120 PIEZAS



CÓDIGO	CÓDIGO	TIPO
TAIAF120	ATC-120	CLAVIJA

CÓDIGO	TIPO
TAIAF122	MINI TIPO NUEVO

CÓDIGO	TIPO
ATM-120	CLAVIJA MINI

## PORTA FUSIBLE REFORZADO CALIBRE 12



CÓDIGO	PARA FUSIBLE
31987	CLAVIJA
31982	DE VIDRIO

## ENGRASADORA 2 EN 1 NEUMÁTICA Y MANUAL



Presión de funcionamiento: 1200 - 1600 PSI  
 Consumo de aire: 4 CFM @ 100 PSI  
 Presión de trabajo: 30 - 100 PSI  
 Entrada de aire: NPT de 1/4 "

CÓDIGO
AIRGG-10

## ENGRASADORA HEAVY DUTY KIT CGRASA



FACIL USO CON UNA MANO.  
 EXTENSIÓN DE 6".  
 12" DE MANGUERA FLEXIBLE.  
 CARGA POR SUCCION DE BOMBA O CARTUCHO.  
 TUBO DE 14 Oz. DE MULTIPLE FINALIDAD.  
 GRASA DE LITIO.

CÓDIGO
94103



## GATO HIDRAULICO DE PATIN



CÓDIGO	CAPACIDAD. EN TONELADAS
--------	-------------------------

GP-2T	2
GP-23/4	2-3/4
GP-3T	3

## GATO HIDRAULICO DE TIJERA MANUAL



CÓDIGO	TON.
--------	------

CHIJ00012	2
-----------	---

## GATO HIDRAULICO TPO BOTELLA ECONOMICO



CÓDIGO	CAPACIDAD	CÓDIGO	CAPACIDAD
--------	-----------	--------	-----------

GB-2	2 TON.	GB-12	12 TON.
GB-4	4 TON.	GB-20	20 TON.
GB-6	6 TON.	GB-32	32 TON.
GB-8	8 TON.	GB-50	50 TON.
GB-10	10TON.		

## TORRES PARA LEVANTAR AUTOS



CAJA CON 2 PIEZAS

CÓDIGO	CAPACIDAD
--------	-----------

8206-4	3 TONELADAS
CHIS600	6 TONELADAS

## GATO HIDRAULICO PARA TRAILER CAPACIDAD DE 1000lbs CON 2 RUEDAS

ALTURA DE 22-1/2" A 3  
CÓDIGO: TAIJ053



## GATO HIDRAULICO PARA TRAILER CAPACIDAD DE 2000lbs



ALTURA DE 10" A 16.5"  
CÓDIGO: TAIJ052



CON 1 RUEDAS  
ALTURA DE 15" A 26"  
CÓDIGO: ATTJ-004C

## GATO HIDRAULICO PARA TRAILER CAPACIDAD DE 8000lbs



- FACIL DE USAR
- ALTURA MINIMA 14" (0.61m)
- ALTURA MAXIMA 53" (1.35m)
- BASE DE 8-1/4" x 6-1/4" (21cm x 16cm)

CÓDIGO:  
85360



## CRUCETAS PARA CARROS



CÓDIGO	DESCRIPCION
--------	-------------

W-1	P/ CARRO AMERICANO 20
W-2	P/ CARRO EUROPEO 14
W-11	P/ CAMION 25



## VENTILADOR DE 12 VOLTS 8'

DE PLASTICO

CÓDIGO: 23-7307

## CLAXON PARA AUTOS Y CAMIONES

CON BOCINA MUSICAL

CÓDIGO	MUSICA
15-214	"DIXIE"
15-210	"LA MACARENA"
15-205	"LA CUCARACHA"

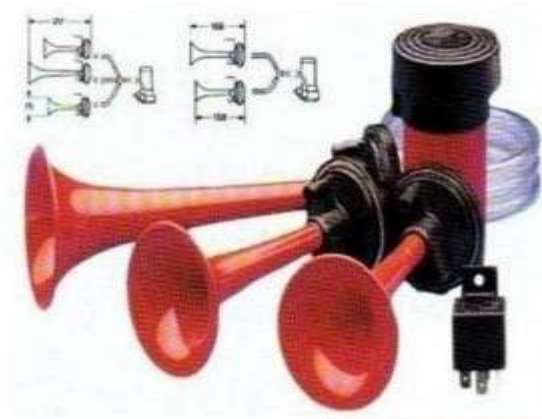

**ADAPTADOR PARA GANCHO DE JALON DE 2" A 1-1/4"**



**CÓDIGO:82012**

**ADAPTADOR PARA GANCHO DE JALON**



CÓDIGO	MEDIDAS
TAIH0032	1-1/4" A 2"

**COPE DE GANCHO DE JALON**



CÓDIGO	MEDIDAS
81102	6" 2"x2"
81103	12" - 2" x 2"
TAIH0034-11	2" x 2 X12 X 5/8"

**COPE DE 2" A 1-1/4" PARA GANCHO DE JALON**



**CÓDIGO:TAIH0033**

**GANCHO PARA JALON AJUSTABLE DE 10' CAPACIDAD 5000lbs**



PARA BOLA DE ENGANCHE DE 1" CON 4 NIVELES DE 4-1/2" A 10-1/2" INCLUYE SEGUROS PARA SU USO.

CÓDIGO	MEDIDAS
82005	4-1/2" A 10-1/2"
TAIH0034-07	4-1/2" A 10-1/2"

**EXTENSIÓN PARA JALON**



CÓDIGO	MEDIDAS
TAIH0043	12" A 1-1/4"

**TOWBAR**



**AJUSTABLE FACIL DE INSTALAR CAPACIDAD PARA 5000 LIBRAS.**

**CÓDIGO: 70201**

**CONECTOR 4 HILOS PARA TRAILA 25FT**



25'

**CÓDIGO  
CHIL1219**

**JALON REMOLQUE DE OJO 2"X2"X1/4**



**2"x 2"x 1/4"**

PESO MAXIMO SOPORTADO 5 TON. PESO SOPORTABLE POSICIÓN VERTICAL 500LB

**CÓDIGO  
TAIH0034-15**



**SUJETADORES CON RATCH**  
15fts X 1" CON 4pzs



CADA SUJETADOR INCLUYE 1 BANDA DE NYLON Y EN LOS EXTREMOS UN RATCH Y UN GANCHO

**CÓDIGO: 33079**

**SEGURO PARA GANCHO DE JALÓN**



**CÓDIGO: BMHP58**

**SUJETADORES CON RATCH**  
15fts X 1" CON 4pzs HD



CADA SUJETADOR INCLUYE 1 BANDA DE NYLON Y EN LOS EXTREMOS UN RATCH Y UN GANCHO

**CÓDIGO: 30064**



**MALLA P/CARGA TIPO PULPO 4FTX6FT C/10 GANCHOS**

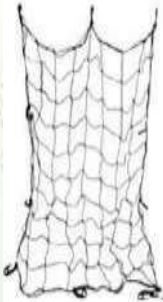

EL MATERIAL SE ARRASTRA PARA CUBRIR Y ASEGURAR CARGA.

SE PUEDE ENGANCHAR CASI EN CUALQUIER COSA.

IDEAL PARA CARGA EN CAMIONETAS.  
ALTA CALIDAD Y SERVICIO PESADO.



**CÓDIGO**

**TAIE4510**

**BANDA PARA REMOLQUE 2" X 12 FT Y 12" X 20 FTS CON GANCHOS**



**2" x 20 ft.**

**CÓDIGO**

**TAIT5393**

**MEDIDA**

**2" x 12 fts - 6000 LIBRAS**

**CÓDIGO**

**TAIT5394**

**MEDIDA**

**2" x 20 fts - 10,000 LIBRAS**

**SUJETADOR ELASTICO SET CON 10pzs**



**CÓDIGO**

**MEDIDA**

**BGC0810-10**

**10"**

**BGC0810-12**

**12"**

**BGC0810-15**

**15"**

**BGC0810-18**

**18"**

**BGC0810-24**

**24"**

**BGC0810-30**

**30"**

**92008**

**36"**

**BANDA PARA REMOLQUE 2" X 27FTS HD C/ RATCH**



CAPACIDAD PARA 10,000 LIBRAS.

**CÓDIGO: TAIR0537**

## BOLA DE ENGANCHE CON CAPACIDAD DE 2000lbs

DE ACERO SOLIDO CROMADO PARA REMOLCAR



CÓDIGO	MEDIDA
81069	2" x 3/4" x 2"
81068	1 7/8" x 3/4" x 2"
81067	1 7/8" x 3/4" x 1"
81073	1 7/8" x 1" x 1"
TAIH0036	1 7/8" x 3/4" x 2"



CÓDIGO	MEDIDA
93432	2" x 1" x 3"
TAIH0037	2" x 1" x 2"
81078	2 5/16" x 1" x 2"
TAIH0035	2" x 3/4" x 2"
TAIH0038	1 7/8" x 1" x 2"
TAIH0041	2" x 1" x 3"

## COUPLE DE ENGANCHE PARA REMOLCAR AUTOS



CÓDIGO	MEDIDA Y PESO
81083	2"X3" -3500 LIBRAS
TAIH0045	1 7/8" -2000 LIBRAS
81081	2" X 2-1/2"
TAIH0046	1 7/8 X 2-1/2 2000 LIBRAS
TAIH0048	2 X 3" 3500 LIBRAS

## Bola Doble de Enganche de Remolque Ajustable



CÓDIGO

82017

## GANCHO PARA JALON CAPACIDAD DE 5000lbs



CÓDIGO	No.	MEDIDA
82001	2	2 x 7"
82003	4	4 x 10"

## COUPLE PARA BOLA DE JALON



CÓDIGO	MEDIDA
TAIH0049	2" - 5000 LIBRAS
TAIH0050	2 5/16 " - 5000 LIBRAS
AATC-004	2 5/16 " - 5000 LIBRAS

### GANCHO CROMADO PARA JALON 4" X 10" 5000LBS



CÓDIGO

MEDIDA

81100

4" x 10".

### GANCHO PARA JALON 2" X 7" 5000LBS



CÓDIGO

MEDIDA

TAIH0034-02

2" x 7".

### GANCHO PARA JALON 4" X 10" 5000LBS



CÓDIGO

MEDIDA

TAIH0034-04

4" x 10".

### GANCHO PARA JALON 6" X 11-1/4" 5000LBS

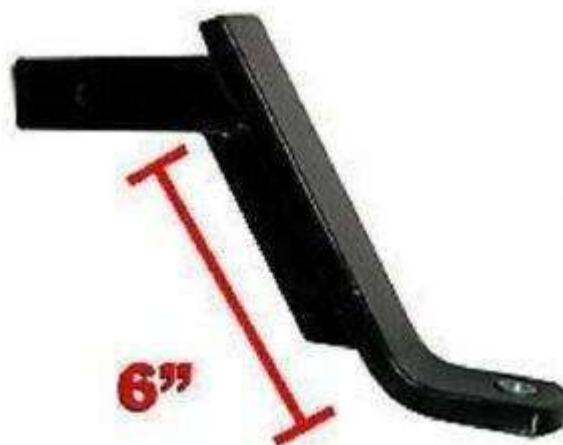

CÓDIGO

MEDIDA

TAIH0034-06

6" x 11-1/4".

### GANCHO PARA JALON 8" X 13-1/4" 5000LBS



CÓDIGO

MEDIDA

TAIH0034-08

8" x 13-1/4".



## BARRA CON 2 BOLAS DE ENGANCHE



MEDIDAS:

- 1-7/8 "(3500lbs)
- 2" (5000lbs)

CÓDIGO: TAIH0034-24

## BARRA CON 2 BOLAS DE ENGANCHE Y GANCHO



MEDIDAS:

- 1-7/8"(3500lbs)
- 2" (5000lb)

CÓDIGO: TAIH0034-18

## BARRA CON 3 BOLAS DE ENGANCHE Y GANCHO



MEDIDAS:

- 2 5/16 (7500lb)
- 2" (5000lb)
- 1 7/8" (3500lb)

CÓDIGO: TAIH0034-14

## BARRA CON 3 BOLAS DE ENGANCHE



MEDIDAS:

- 2 5/16 (7500lb)
- 2" (5000lb)
- 1 7/8" (3500lb)



CÓDIGO	PROVEDOR
TATHM	AJ WHOLESALE
82007	AMERICAN EX-CHANGE

## BARRA CON 3 BOLAS DE ENGANCHE AJUSTABLE



MEDIDAS:

TAMAÑO DE LA BOLA DEL MOBILIARIO: 1-7 / 8 "

- DE LENGÜETA TAMAÑO: 2-1 / 2
- CAPACIDAD: 2000LBS

CÓDIGO: TAIH0033-55

## SEGURO PARA GANCHO DE JALON

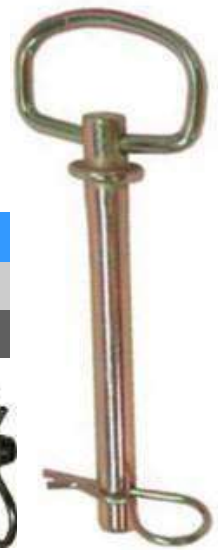

CÓDIGO	MEDIDA
TAIAH041	1/2" X 4-3/4 "
TAIAH042	5/8" X 4-3/4"



## KIT DE GANCHO DE REMOLQUE



**CÓDIGO:TAIH0034-13**

## SEGURO UNIVERSAL PARA BOLA DE ENGAÑE



### MEDIDAS:

- MECANISMO DE BLOQUEO RESISTE RECOGIENDO Y HACIENDO PALANCA.
- FÁCIL DE INSTALAR Y QUITAR.
- EL ÓXIDO Y RESISTENTE A LA CORROSIÓN.

**CÓDIGO:TAIH0042**

## COPLÉ TIPO MUELA DE 1-7/8"



CÓDIGO	MEDIDA
TAIH0033-51	1-7/8"
TAIH0033-52	2"

## BASE PARA JALON 13 1/2" X 4 1/2"



**CÓDIGO: TAIH0034-10**

## AJUSTADOR DE CARBURADOR



IDEAL PARA LLEGAR A LUGARES CON POCA ACCESIBILIDAD.

**CÓDIGO: TAICO006**

## PINZA PARA SEGUROS 4 EN 1



**CÓDIGO: CHIP4193**

**LONAS**



## LONA AZUL DE PLASTICO



CÓDIGO	MEDIDA EN PIES	MEDIDA EN METROS
LN5X7	5 X 7	1.52 X 2.13
LN6X8	6 X 8	1.83 X 2.44
LN7X16	7 X 16	2.13 X 4.88
LN8X10	8 X 10	1.83 X 3.05
LN9X12	9 X 12	2.74 X 3.66
LN10X10	10 X 10	3.05 X 3.05
LN10X12	10 X 12	3.05 X 3.66
LN10X16	10 X 16	3.05 X 4.88
LN10X20	10 X 20	3.05 X 6.10
LN12X12	12 X 12	3.66 X 3.66
LN12X14	12 X 14	3.66 X 4.27
LN12X18	12 X 18	3.54 X 5.41
LN12X16	12 X 16	3.66 X 4.88

CÓDIGO	MEDIDA EN PIES	MEDIDA EN METROS
LN12X20	12 X 20	3.66 X 6.10
LN12X24	12 X 24	3.66 X 7.32
LN14X16	14 X 16	4.27 X 4.88
LN14X20	14 X 20	4.27 X 6.10
LN14X24	14 X 24	4.27 X 7.32
LN15X15	15 X 15	4.57 X 4.57
LN15X30	15 X 30	4.57 X 9.14
LN16X20	16 X 20	4.88 X 6.10
LN16X24	16 X 24	4.88 X 7.32
LN18X24	18 X 24	5.49 X 7.32
LN20X20	20 X 20	6.10 X 6.10
LN20X24	20 X 24	6.10 X 7.32

CÓDIGO	MEDIDA EN PIES	MEDIDA EN METROS
LN20X30	20 X 30	6.10 X 9.14
LN20X40	20 X 40	6.10 X 12.19
LN24X24	24 X 24	7.32 X 7.32
LN24X36	24 X 36	7.32 X 10.97
LN25X25	25 X 25	7.62 X 7.62
LN25X45	25 X 45	7.62 X 13.72
LN26X40	26 X 40	7.92 X 12.19
LN30X30	30 X 30	9.14 X 9.14
LN30X40	30 X 40	9.14 X 12.19
LN30X50	30 X 50	9.14 X 15.24
LN30X60	30 X 60	9.14 X 18.29
LN40X40	40 X 40	12.19 X 12.19
LN40X60	40 X 60	12.19 X 18.29

## LONA GRIS DE PLASTICO CON REFUERZO



CÓDIGO	MEDIDA EN PIES	MEDIDA EN METROS
LNGHD6X8	6 X 8	1.83 X 2.44
LNGHD8X10	8 X 10	1.83 X 3.05
LNGHD8X12	8 X 12	1.83 X 3.66
LNGHD9X12	9 X 12	2.74 X 3.66
LNGHD10X10	10 X 10	3.05 X 3.05
LNGHD10X12	10 X 12	3.05 X 3.66
LNGHD10X16	10 X 16	3.05 X 4.88
LNGHD10X20	10 X 20	3.05 X 6.10
LNGHD12X12	12 X 12	3.66 X 3.66
LNGHD12X16	12 X 16	3.66 X 4.88
LNGHD12X20	12 X 20	3.66 X 6.10
LNGHD14X18	14 X 18	4.27 X 5.49
LNGHD14X20	14 X 20	4.27 X 6.10
LNGHD15X15	15 X 15	4.57 X 4.57

CÓDIGO	MEDIDA EN PIES	MEDIDA EN METROS
LNGHD15X30	15 X 30	4.57 X 9.14
LNGHD16X20	16 X 20	4.88 X 6.10
LNGHD16X24	16 X 24	4.88 X 7.32
LNGHD16X30	16 X 30	4.88 X 9.14
LNGHD18X24	18 X 24	5.49 X 7.32
LNGHD20X20	20 X 20	6.10 X 6.10
LNGHD20X30	20 X 30	6.10 X 9.14
LNGHD20X40	20 X 40	6.10 X 12.19
LNGHD24X24	24 X 24	7.32 X 7.32
LNGHD30X30	30 X 30	9.14 X 9.14
LNGHD30X40	30 X 40	9.14 X 12.19
LNGHD30X60	30 X 60	9.14 X 18.29
LNGHD40X40	40 X 40	12.19 X 12.19
LNGHD40X60	40 X 60	12.19 X 18.29

## COPLES Y VALVULAS MARCA TRU-FLATE



UNION DE 1/4 EN CARTERA

CÓDIGO: 21-505



COOPLE HEMBRA DE 1/4 EN CARTERA

CÓDIGO: 13-135



COPLE MACHO DE 1/4 EN CARTERA

CÓDIGO: 13-125



COOPLE MACHO DE 1/4 TRU-FLATE EN CARTERA UNIVERSAL

CÓDIGO: 13-513



PISTOLA PARA SOPLEAR CAMEL U.S.A



CÓDIGO: 18-203



MANÓMETRO DE DOBLE PIE, PARA CAMIONES Y AUTO BUSES CALIBRADO DESDE 10 HASTA 150 PSI EN INCREMENTOS DE 2 LB.

CÓDIGO: 17-545



ADAPTER MACHO DE 1/4 EN CARTERA

CÓDIGO: 12-125B



VALVULA DUAL INFLADORA DE LLANTAS PARA AUTOS DE 10 HASTA 150 PSI

CÓDIGO: 17-383



MANOMETRO DE UNA CARA CALIBRA DESDE 10 A 50 PSI EN INCREMENTOS DE 1LB.

CÓDIGO: 17-509



ADAPTER HEMBRA DE 1/4 EN CARTERA

CÓDIGO: 12-135



PISTOLA P/ SOPLEAR C/ MANGUERA  
CÓDIGO: 18-225



VALVULA PARA AIRE DOBLE CARA 12 PULGADAS

CÓDIGO: 17-398

MANGUERA EN ESPIRAL DE 3.5 MTS CON PISTOLA PARA SOPLEAR



CONTIENE:

- MANGUERA DE PLASTICO
- "T" DE COBRE DE 1/4 NTA.
- PISTOLA DE NARIZ DE ZINC FACIL DE INSTALAR

CÓDIGO: 10-11K



VÁLVULA PARA AIRE TIPO ESFERA 1/4 HEMBRA FNPT EN CARTERA

CÓDIGO: 17-351

**MILTON** *INDUSTRIES, INC.*



## COPLE MACHO 1/4 NPT 2PCS



ACCA  
ACCESORIOS

TAPON ACOPLADOR  
MACHO 1/4

CÓDIGO: S727

## VALVULA PARA AIRE HEMBRA



ACCA  
ACCESORIOS



VÁLVULA PARA AIRE  
1/4 HEMBRA NPT  
EN CARTERA  
MILTON

CÓDIGO: S699

## ADAPTADOR MACHO ESTILO T



ACCA  
ACCESORIOS

ADAPTADOR MACHO  
DE 1/4" NPT  
ESTILO "T"  
CARTERA C/ 2PZS  
MILTON  
CÓDIGO: S783



## COPLE RAPIDO HEMBRA ESTILO M



ACCA  
ACCESORIOS



COPLE RAPIDO  
HEMBRA ESTILO  
"M"

DE 1/4 NPT  
MILTON  
CÓDIGO:  
S715

## COPLE MACHO 1/4



ACCA  
ACCESORIOS

COPLE MACHO ESTI-  
LO "M"  
DE 1/4 NPT  
MILTON  
CÓDIGO: S716

## COPLE HEMBRA 1/4 NPT 2PCS



ACCA  
ACCESORIOS

TAPONES  
HEMBRA 1/4"  
CÓDIGO: S784

## VALVULA DUAL INFLADORA DE LLANTAS



PARA AUTOS  
DE 10 HASTA 150 PSI  
MILTON

CÓDIGO: **S690**

## MANOMETRO DOBLE PIE GRANDE



DOBLE  
CABEZA 10-  
160PSI

80-1100KPA

CÓDIGO: **S976**

## MANOMETRO DOBLE PIE PARA CAMIONES CHICOS



CALIBRADOR DE PRE-  
SION NEUMATICO  
20-120PSI

CÓDIGO: **S927**

## PISTOLA PARA SOPLETEAR



PISTOLA DE SOPLADO  
COMPACTO A PALANCA

1/4 NPT  
CÓDIGO:  
**S148**



# PRODUCTOS





## SINCHO QUITA FILTRO MARCA PLEWS



**CODIGO**

**PEQUEÑO  
DE 2 13/16-  
3 5/32**

**Solida construcción de  
acero**

## SINCHO QUITA FILTROS DE CAMIONES Y TRACTOCAMIONES



**CÓDIGO**

**DIAMETRO**

70-605 GRANDE DE 3 1/2" -3 7/8"

70-607 GRANDE DE 4 1/8" -4 1/2"

70-609 GRANDE DE 4 3/4"-5 1/5"

## ENGRASADORA MANUAL DE USO GENERAL



INCLUYE TUBO Y COPL  
ACABADO DE ESMALTE HORNEADO  
FACIL DE LIMPIAR

**CÓDIGO: 30-445**



## MANGUERA PARA ENGRASADORA MARCA PLEWS



PARA PISTOLAS OPERADAS A  
MANO SOLAMENTE  
**CÓDIGO: 10-212**



## BOMBA PARA TAMBORES CON MANIJA



### BOMBA PARA TAMBORES CON MANIJA "T"

ADAPTABLE A TAMBORES DE 30 A 55 GALONES

BOMBEA LA MAYORIA DE LOS FLUIDOS NO  
CORROSIVOS BASADOS EN ACEITE

INCLUYE UN PICO DE METAL

EXTREMO CON ROSCA DE MANGERA DE JARDIN

ESTANDAR

EQUIPADA CON UNA UNIDAD DE SELLADO ESTANDAR  
DE 2"

**CÓDIGO: 55-017**

## AGUA PARA INYECTAR GRASA MARCA PLEWS



**CÓDIGO: 05-037**

## COUPLE PARA ENGRASADORA MANUAL



DE 1/8 NPT

**CÓDIGO: 05-031**

## SINCHOPARA FILTRO



TIPO RATCH UNIVERSAL  
P/ CARRO AMERICANO  
Y EUROPEO.

INCLUYE ADAPTADOR  
PARA RATCH



CÓDIGO	MEDIDA
90210	3/8" SIN ADAPTADOR
°TAIW0737 °90211	½ A 3/8" CON ADAPTADOR

## FLOREADOR Y CORTADOR DE TUBO



KIT CON 6PZS  
PROFESIONAL



CÓDIGO

34053

## CORIA TUBO MIN



DE 1/8 A 5/8

CÓDIGO

0325

## FLOREADOR DE TUBO



KIT CON 9 PZS  
PROFESIONAL.

CÓDIGO

21837

## BOMBAS DE AIRE

MANUAL.



CÓDIGO

1046



DE  
PEDAL.

CÓDIGO

630

## BOMBA MIN DE AIRE MANUAL



CÓDIGO

CHIP810

## MIN CEPILLOS JUEGOS DE 3pzs



CON CERDAS DE:

- ACERO
- LATÓN
- NYLON



CÓDIGO

CHIB3943

## CEPILLO DE ALAMBRE



Los cepillos de alambre de acero con alto carbon son una herramienta ideal para quitar la pintura descascarada, oxido, los arañazos, suciedad y las pequeñas imperfecciones de superficies de concreto, metal, piedra y madera

CÓDIGO

**CAL51**

## CEPILLOS DE ALAMBRE



MANGO DE PLASTICO DE  
3 HILERAS

CÓDIGO

1-1129

## CEPILLOS DE ALAMBRE



MANGO DE MADERA DE 3  
HILERAS

CÓDIGO

1129

## LIMPIA PARRASIS MANGO FLEXIBLE



CÓDIGO

13404

## LIMPIA PARRASIS MANGO DE MADERA



MANGO DE MADERA

CÓDIGO

88133



## DEPOSITOS DE PLASTICO PARA GASOLINA



CÓDIGO	CAPACIDAD
11833	5gal.
11832	2gal.
50805	1gal.

## BROCHA PARA MECANICO



**MANGO DE MADERA**  
CÓDIGO: W-197

## DIABLITO DE CARGA CAPACIDAD PARA 6000lbs



- PROFESIONAL
- CON LLANTAS DE 10" X 3 1/2"
- ESTRUCTURA PARA USO RUDO
- COMODA PARA TRABAJOS PESADOS
- **CÓDIGO: 40122**

## EMBUDOS LARGOS DE PLASTICO Y METAL



CÓDIGO

W-226



CÓDIGO

TAIF0006

TIPO

ECONOMICO



**FLEXIBLE PLASTICO**  
CÓDIGO: HOPP06064



**FLEXIBLE METAL**  
CÓDIGO: TAIF0005

## EMBUDOS CORTOS DE PLASTICO



DE 7 in

CÓDIGO:05064



DE 3in  
1/2 PINTA  
CÓDIGO:W-223



HECHO DE MATERIAL RESISTENTE.

IDEAL PARA AGREGAR ADITIVO AL TANQUE DE COMBUSTIBLE, LLENAR EL DEPÓSITO DEL LIQUIDO DE FRENOS, EL DEPÓSITO DE LA DIRECCIÓN ASISTIDA Y RELLENAR LAS TRANSMISIONES.

CÓDIGO

TAIF0013

## CHAROLA DE PLASTICO RESISTENTE



PARA CAMBIO DE ACEITE.

CÓDIGO: CH-275

## CHAROLA PARA ACEITE



PARA CAMBIO DE ACEITE.

CÓDIGO: TAIF0012

## CUÑA



CON MANGO DE MADERA DE 100 x 80mm.

CÓDIGO: CUN-003

## VALVULA DE ESFERA PARA AIRE



- 1/4" N.P.T
  - ZINC
- CÓDIGO: **83055**

## COUPLE PARA MANGUERA DE AIRE



**DE ZINC**  
 JUEGO CON 5 PZS  
 CÓDIGO: **TAZ-2941**



**DE BRONCE**  
 JUEGO CON 5 PZS  
 CÓDIGO: **TAB-2941**

## COUPLE RAPIDO UNIVERSAL



COUPLE RAPIDO  
 UNIVERSAL  
 HEMBRA DE 1/4 NPT  
 SE ADAPTA A LOS ESTILOS  
 A, M, L Y T.



CÓDIGO: **11374**

## VALVULA DUAL PARA AIRE DE 6"



- 1/4" N.P.T
  - ZINC
- CÓDIGO: **TAIT0258**

## BROCHA 1/2 PARA MECANICO CON 12pzS



MANGO DE ALUMINIO.  
 CÓDIGO: **TAIB0046**

## MAN TELESCOPO



CÓDIGO	MEDIDA
<b>CHIP4391</b>	8 LBS.
93515	16 LBS

## TEE DE BRONCE EN BLISTER



ENTRADA 1/4 NPT  
 SALIDA 1/4 NPT  
 CÓDIGO: **ATAHCT-001**



## REGULADOR DE AIRE DE BRONCE



ENTRADA 1/4 NPT  
 SALIDA 1/4 NPT  
 EN BLISTER  
 CÓDIGO: **ATAHRB-C**

## COUPLE DE BRONCE MACHO



1/4 NPT  
 EN BLISTER  
 CÓDIGO: **ATQCB-001**

## CEPILLO 10" BI-LEVEL



CÓDIGO: **1810-B**

## BROCHA PARA MECANICO



CÓDIGO: **3801**

## CUBRE PLACAS METALICAS "VARIOS"

CÓDIGO	DESCRIPCION
--------	-------------

22250	TIPO CINTURON ADIAMANTADO
-------	---------------------------

CÓDIGO	DESCRIPCION
--------	-------------

22030	TIPO CADENA BOLA CROMADA
-------	--------------------------



CÓDIGO	DESCRIPCION
--------	-------------

23300	TIPO JIPI
-------	-----------

CÓDIGO	DESCRIPCION
--------	-------------

WL201-CF	TIPO VISTA FIBRA DE VIDRIO
----------	----------------------------

CÓDIGO	DESCRIPCION
--------	-------------

22150	TIPO COLLAR DE PICOS
-------	----------------------



## CERAS MARCA TURTLE WAX

CERA SUPER PROTECTORA DEVUELVE EL BRILLO ORIGINAL FACIL DE APLICAR



EN PASTA 14 OZ

**CODIGO**

**T-222R**

POLLISH COUMPOND PASTA BLANCA Y CREMOSA



COMPUESTO PARA ACABADOS MUY DESGASTADOS



10 OZ

**CODIGO**

**T-241A**

## TURTLE WAX LIQUIDA



SHAMPO 16 OZ

**CODIGO**

**T-75AS**



16 OZ

**CODIGO**

**T-123R**

## CUBRE ASIENTOS 2pzs DE EQUIPOS DEL FUTBOL MEXICANO



**CUBRE ASIENTOS FRONTALES  
DE LAS CHIVAS C/2PZS  
CON LOGOTIPO BORDADO**

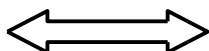

**CUBRE ASIENTOS FRONTALES  
DEL AMERICA C/2PZS  
CON LOGOTIPO BORDADO**

CÓDIGO	COLOR
SC-1101F-NAZ	NEGRO/AZUL
SC-1101F-NG	NEGRO/GRIS

CÓDIGO	COLOR	CÓDIGO	COLOR
SC-2101F-NBE	NEGRO/BEIGE	SC-2101F-N	NEGRO
SC-2101F-NG	NEGRO/GRIS		
SC-2101F-NR	NEGRO/ROJO		

## CUBRE ASIENTOS 4pzs DE EQUIPOS DEL FUTBOL MEXICANO



**CUBRE ASIENTOS TRASEROS  
DE LAS CHIVAS C/4PZS  
CON LOGOTIPO BORDADO**

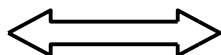

**CUBRE ASIENTOS TRASEROS  
DEL AMERICA C/4PZS  
CON LOGOTIPO BORDADO**

CÓDIGO	COLOR
SC-1101T-NAZ	NEGRO/AZUL
SC-1101T-NG	NEGRO/GRIS
SC-1101T-NR	NEGRO/ROJO

CÓDIGO	COLOR
SC-2101T-NAZ	NEGRO/AZUL
SC-2101T-NG	NEGRO/GRIS
SC-2101T-NA	NEGRO/AMARILLO

## CUBRE ASIENTOS 11 PZS CON ESCUDO ESTAMPADO

CONTIENE: 2 ASIENTOS DELANTEROS, 1 RESPALDO TRASERO, 1 ASIENTO TRASERO, 2 PROTECTORES P/CINTURON,



SC-4110-BB BEIGE/BLANCO

SC-4110-AA AMARILLO/AZUL

## CUBRE ASIENTOS 11 PZS CON ESCUDOS

CONTIENE: 2 ASIENTOS DELANTEROS, 1 RESPALDO TRASERO, 1 ASIENTO TRASERO, 2 PROTECTORES P/CINTURON,

# ESTAMPADOS



**DE LAS CHIVAS C/11PZS  
CON LOGOTIPO ESTAMPADO**

CÓDIGO	COLOR
SC-1108B	BEIGE



**DE LAS CRUZ AZUL C/11PZS**

CÓDIGO	COLOR
SC-3110-AB	BLANCO/AZUL



**DEL AMERICA C/11PZS  
CON LOGOTIPO ESTAMPADO**

CÓDIGO	COLOR
SC-2108B	BEIGE
SC-2108G	GRIS
SC-2108NA	NEGRO/AZUL
SC-2108GN	NEGRO/GRIS
SC-2110-AA	AMARILLO/AZUL



## CUBREASIENTO DE COCHE ENCORE COMBO ESPALDA BAJA 9CS



**Incluye: cubos de 4 piezas, banco de 2 piezas, almohadillas para cinturón de 2 piezas y 1 tapa del volante.**



CÓDIGO	MEDIDA
SC-112-BK	NEGRO
SC-112-CC	CHARCOAL
SC-112-GR	GRIS
SC-112-BG	BEIGE

## CUBREASENTO DE COCHE REGAL COMBO ESPALDA BAJA 9PC



**Incluye: cubos de 4 piezas, banco de 2 piezas, almohadillas para cinturón de 2 piezas y 1 tapa del volante.**



CÓDIGO	MEDIDA
SC-110-CC	CHARCOAL
SC-110-GR	GRIS
SC-110-BG	BEIGE

## CUBREASIENTO UNIVERSAL



**CONJUNTO COMPLETO DE CUBIERTAS DE SEGURIDAD PARA COCHES BAJOS DE LUJO, AJUSTE UNIVERSAL PARA COCHES, CAMIONES, SUV O VAN**



OCODIGO	MEDIDA
SC-309-BK	NEGRO
SC-309-CC	CHARCOAL
SC-309-GR	GRIS
SC-309-BG	BEIGE

## TAPETE DE ALFOMBRA CON 3 PIEZAS PARA SUBURBAN, VAN Y PICKUP TRUCK



COLOR NEGRO  
CÓDIGO: 98002BK



COLOR AZUL  
CÓDIGO: 98002BL



COLOR BEIGE  
CÓDIGO: 98002BE



COLOR GRIS CLARO  
CÓDIGO: 98002LG



COLOR GRIS OSCURO  
CÓDIGO: 98002DG

## TAPETE DE ALFOMBRA Y VINIL DE 1 PIEZA



COLOR ROJO.  
CÓDIGO: 102-215R



COLOR BEIGE.  
CÓDIGO: 102-215B



COLOR GRIS OSCURO  
CÓDIGO: 102-215GO



COLOR NEGRO.  
CÓDIGO: 102-215N



COLOR AZUL.  
CÓDIGO: 102-215AZ



COLOR GRIS CLARO  
CÓDIGO: 102-215GC

## TAPETES DE ALFOMBRA Y VINIL CON 4 PIEZAS



AMARILLO-NEGRO.  
CÓDIGO: HC-111-NA



NEGRO-NEGRO.  
CÓDIGO: HC-111-NN



AZUL-NEGRO.  
CÓDIGO: HC-111-NAZ



GRIS-NEGRO.  
CÓDIGO: HC-111-NG



ROJO-NEGRO.  
CÓDIGO: HC-111-NR



ROSA-NEGRO.  
CÓDIGO: HC-111-PK



BEIGE-NEGRO.  
CÓDIGO: HC-111-NBE

# CUBRE ASIENTOS ACOJINADOS CON 9 PIEZAS LISO PARA PICKUP EN COLORES



CÓDIGO	COLOR
SC-1120-BG	BEIGE CON TEXTURA
SC-1120-GR	GRIS
SC-1120-CC	CHARCOAL
SC-1122-BK	NEGRO LISO
SC-1122-BG	BEIGE LISO
SC-1124-BK	NEGRO CON TEXTURA

## CUBRE ASIENTO "TYPE R" CON 11 PZS.

CONTIENE: 2 ASIENTOS DELANTEROS, 1 RESPALDO TRASERO, 1 ASIENTO TRASERO, 2 PROTECTORES P/CINTURON, 2 CABECERAS Y 1 CUBRE VOLANTE



## ACOJINADOS

CÓDIGO	COLOR	CÓDIGO	COLOR
21-919BL/B	AZUL/ NEGRO	21-919G/B	GRIS/NEGRO
21-919R/B	ROJO/NEGRO	21-919B/B	NEGRO/NEGRO

CÓDIGO	COLOR	CÓDIGO	COLOR
SC-502-BL	NEGRO/AZUL	SC-502-BK	NEGRO
SC-502-GR	NEGRO/GRIS	SC-502-BG	NEGRO/BEIGE

## CUBRE ASIENTOS 1 PZA BORDADOS



**ACOJINADO**  
CON BOB ESPONJA BORDADO  
**1 PZA.**

**CÓDIGO: 52737**

## CUBRE ASIENTOS 11 PZS BORDADOS



CON FIGURA DE TAZ  
JUGANDO FUTBOL

**CÓDIGO: CATZ-11**



CON FIGURA DE PIOLIN  
JUGANDO FUT-BOL

**CÓDIGO: CAP-11**



## TAPETE DE ALFOMBRA CON ESTAMPADO DE DRAGON



**CON 4PZS LADY SKULL**  
CÓDIGO: MT-421



**NEGRO CON DRAGON ROJO**  
CÓDIGO: MT-401-RD



**NEGRO CON DRAGON GRIS**  
GODIGO: MT-401-GR

## TAPETE DE HULE CON FIGURA ESTAMPADA DE 2pzs



**NEGRO CON DRAGON ROJO**  
CÓDIGO: 67-327

## TAPETE DE HULE CON FIGURA ESTAMPADA CON 4pzs



**NEGRO CON TAZ C/CAMISA DE LA SELECCIÓN MEXICANA**  
CÓDIGO: 103018

## CUBRE ASIENTO BORDADO



**DE EXPRESION**  
CÓDIGO: 5046480

## CUBRE ASIENTO BORDADO



**DE TIGRE GRIS**  
CÓDIGO: 5049784

## CUBRE ASIENTO BORDADO



**CÓDIGO**

**TIPO**

00001

VACA

00003

TIGRE

CUBRE ASIENTOS CON DISEÑO DE LUJO, SUAVE Y CONFORTABLE  
IDEAL PARA



**CHEVY:** \* TAHOE  
\* AVALANCHE  
\* SUBURBAN  
\* SILVERADO

**G.M.C.:** \* YUKON  
\* ENVOY  
\* SIERRA

**LINCOLN:** \* NAVIGATOR

**FORD:** \* F-150



**TIPO A**

CÓDIGO	COLOR
TS-301-BK	NEGRO

CÓDIGO	COLOR
TS-302-BK	NEGRO

**TIPO B**

TAPETE DE HULE CORRIDO 1 PIEZA DE MATERIAL 100% NUEVO  
(NO RECICLADO) PARA TRUCKS, VANS & SUVs  
**CALIDAD PREMIUM HD**



**COLOR NEGRO**

**CÓDIGO:**  
MT-721-BK

TAPETE DE HULE CON 4 PIEZAS DE MATERIAL 100% NUEVO  
(NO RECICLADO) UNIVERSALES  
**CALIDAD PREMIUM HD**



**COLOR NEGRO**

**CÓDIGO:**  
MT-644-BK



**COLOR BEIGE**

**CÓDIGO:**  
MT-721-BG



**COLOR BEIGE**

**CÓDIGO:**  
MT-644-BG



**COLOR GRIS**

**CÓDIGO:**  
MT-721-GR



**COLOR GRIS**

**CÓDIGO:**  
MT-644-GR



CÓDIGO	MEDIDA
GY-CC1A	CHICA (S)
GY-CC4A	EXTRA GRANDE (XL)
GY-CC5A	EXTRA E. GRANDE (XXL)

FUNDA PARA AUTOS DE ALTA CALIDAD  
TELA 100% IMPERMEABLE

- EL SOL
- NIEVE
- AGUA
- POLVO

## CUBREASIENTO FRONTALES UNIVERSAL TIPO HAWAIIANO



CÓDIGO	COLOR
HSC-AZ	AZUL CLARO
HSC-VE	VERDE

## CUBRE ASIENTOS UNIVERSAL TIPO JEAN C/ 11PZS



CÓDIGO	COLOR
CW-CC352R	ROSA/NEGRO
CW-CC352N	GRIS/NEGRO
CW-CC352AZ	AZUL/NEGRO

## CUBRE ASIENTOS UNIVERSAL REGAL ACOLCHONADOS CON 9 PZS. COLORES CON CUADRICULADOS



CÓDIGO	COLOR
SC-120-BG	BEIGE
SC-120-GY	GRIS
SC-120-CC	CHARCOAL



## CUBRE ASIENTOS UNIVERSAL REGAL ACOLCHONADOS CON 9 PZS. COLORES LIZOS



CÓDIGO	COLOR
SC-122-GY	GRIS
SC-122-CC	CHARCOAL





## PEDALES ESTANDAR DEPORTIVOS



COLOR CROMO ESTANDAR

CÓDIGO: 20-428

## CUBRE PEDAL ESTANDAR



CÓDIGO	COLOR
20-317B	AZUL
20-317C	NEGRO
20-317G	CAFE
20-317R	ROJO
20-317Y	AMARILLO

## CUBRE PEDAL AUTOMATICO



CÓDIGO	COLOR
20-318B	AZUL
20-318C	NEGRO
20-318G	CAFE
20-318R	ROJO

## TRIANGULO DE EMERGENCIA

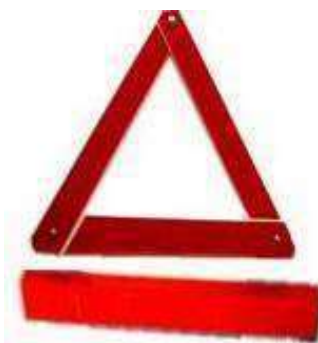

CÓDIGO	DATOS
1690	C/1 ECONOMICO
1692HD	C/1
16114	KIT C/3

## LENTES PROTECTORES DE SEGURIDAD



"DERMA CARE"  
AJUSTABLE.  
CÓDIGO: TAIG0139

## CINTURON TIPO CHALECO (FAJA ELASTICA AJUSTABLE)



CÓDIGO	TALLA
W-172	GRANDE
W-173	MEDIANO
W-174	CHICO
W-175	X-GRANDE



## CHALECO FLUORESCENTE ECONOMICO

REFLECTOR  
UNITALLA.

CÓDIGO: 508E

# ABRAZADERA DE EXPANSION PARA MANGUERA, CAJA CON 10 pzs.



CÓDIGO	MEDIDA	CÓDIGO	MEDIDA
SC-6	5/16" A 7/8"	CC-20	¾" A 1 3/4"
CC-6	5/16" A 7/8"	CC-24	1 1/16" A 2"
CC-8	7/16" A 1"	CC-28	1 5/16" A 2 1/4"
CC-10	9/16" A 1 1/16"	CC-32	1 9/16" A 2 1/2"
CC-12	1/2" A 1 1/4"	CC-36	1 13/16" A 2 3/4"
CC-16	1 1/16" A 1 1/2"		

CÓDIGO	MEDIDA	CÓDIGO	MEDIDA
B-40-H	2" A 3"	B-56-H	3 1/16" A 4"
B-44-H	2 1/4" A 3 ¾"	B-64-H	3 9/16" A 4 ½"
B-48-H	2 9/16" A 3 ½"	B-72-H	4 1/16" A 5"
B-52-H	2 13/16" A 3 ¾"	B-104-H	5" A 7"



## ABRAZADERA DE EXPANSION PARA MANGUERA, CAJA CON 10pzs.



CÓDIGO	MEDIDA
CB036	1 13/16" A 2 3/4"
CB056	3 1/16" A 4"
CB064	3 9/16" A 4 1/2"
CB104	5" A 7"



## ABRAZADERAS PARA FUEL INJECTION, CAJA C/10PZS.



CÓDIGO	MEDIDA
52F13	7/16" A 1/2" (11-13mm)
52F15	1/2" A 9/16" (13 -15mm)
52F 16	9/16" A 5/8" (14 -16mm)

## ABRAZADERA PAQUETE C/2 PZS.



CÓDIGO	MEDIDA

## ABRAZADERA DE EXPANSION PARA MANGUERA, CAJA CON 10pzs. "ECONOMICA"



## ABRAZADERA DE UÑA



CÓDIGO	MEDIDA
ABR-007	DE 3/4"
ABR-006	DE 1/2"

CÓDIGO	MEDIDA
HC-04	1/4" A 5/8"
HC-06	5/16" A 7/8"



## ABRAZADERA DE PLASTICO

COLOR NEGRO

CÓDIGO	LARGO	ANCHO	RESISTE	CON
APD-8	8in	2.5mm	40lbs	100PZS
APD-8A	8in	3.6mm	40lbs	200PZS
APD-12	12in	3.6mm	40lbs	100PZS



## ABRAZADERA DE PLASTICO

COLOR BLANCO Y NEGRO



6" x 3.6 mm.

CÓDIGO	LARGO	ANCHO	RESISTE	CON
TAIC0769-500	12in	4.8mm	50lbs	500PZS
APD-6	6n	3.6mm	40lb	200PZ

## ABRAZADERA DE PLASTICO



CÓDIGO	MEDIDA
CT1150B	11"
CT1550B	15"

## ABRAZADERA DE PLASTICO

COLOR BLANCO

CÓDIGO	LARGO	ANCHO	RESISTE	CON
AP-8	8in	4.8mm	50lbs	100PZS
AP-11	11in	4.8mm	50lbs	50PZS
AP-12	12in	4.8mm	50lbs	100PZS
51132B	14in	4.0mm	50lbs	100PZS
AP-14 1/2	14-1/2in	7.6mm	120lbs	24PZS
AP-16	16in	4.8mm	50lbs	100PZS
AP-18	18in	4.8mm	50LBS	50PZS
AP-20	20in	4.8mm	50LBS	12PZS
AP-20 3/8	20-3/8in	9mm	165lbs	12PZS
AP-28	28in	9mm	165lbs	12PZS



## ABRAZADERA DE PLASTICO



CÓDIGO	MEDIDA
CT1150W	11"

## O-RINGS SET CON DIFERENTES MEDIDAS CON CAJA PROTECTORA DE PLASTICO

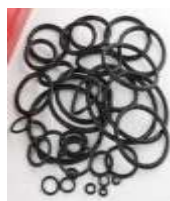

CON 407 PZS  
DE 32 DIFERENTES MEDIDAS  
**MILIMETRICOS**

CÓDIGO: 41104

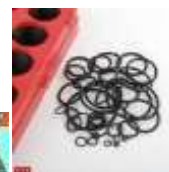

CON 407 PZS  
DE 32 DIFERENTES MEDIDAS  
**ESTANDAR**

CÓDIGO: 41105

## O-RINGS SET CON 225 PZS DE 18 DIFERENTES MEDIDAS



MEDIDAS QUE CONTIENE:

20 DE	1/4 x 1/16	1/4 x 5/64	9/32 x 1/16
	5/16 x 1/16	11/32 x 1/16	3/8 x 5
	7/16 x 5/64	15/32 x 3/32	7/16 z 1/
5 DE	1/21 x 1/16	5/8 x 3/32	11/16 x 5/64
	3/4 x 3/32	13/16 x 5/64	7/8 x 3/32
	15/16 x 5/64	1 x 1/8	1-1/16 x 9/64



CÓDIGO: TAIAR039

## TEFLÓN ROLLO DE 1/2"



CÓDIGO	LONGITUD
1-1122	260'
1-1123	520

## LANA DE ACERO BOLSA CON 16PZS



CÓDIGO	NUMERO	CÓDIGO	NUMERO
2/0	No. 00	4	No. 4
1	No. 1	0	No. 0
2	No. 2	3/0	No. 000
3	No. 3	4/0	No. 0000



# BANDAS SERPENTINA

CÓDIGO	CÓDIGO	CÓDIGO	CÓDIGO	CÓDIGO	CÓDIGO	CÓDIGO	CÓDIGO	CÓDIGO	CÓDIGO	CÓDIGO	CÓDIGO
K3243	K4290	K4425	K5340	K5505	K5888	K6325	K6495	K6670	K6620	K6947	K7900
k3250	K4295	K4430	K5345	K5510	K61000	K6330	K6500	K6675	K6825	K6950	K7973
K3260	k4300	K4440	K5350	K5520	K61005	K6340	K6505	K6680	K6830	K6955	K7976
K3268	K4305	K4450	K5355	K5530	K61010	K6345	K6510	K6685	K6835	K6960	K81000
K3280	K4310	K4460	K5360	K5545	K61020	K6350	K6520	K6690	K6845	K6968	K81189
K3290	K4315	k4465	K5365	K5550	K61025	K6355	K6525	K6695	K6850	K6970	K81362
K3295	K4320	K4470	K5375	K5565	K61030	K6360	K6529	K6705	K6860	K6975	K8393
K3300	K4325	K4490	K5380	K5570	K61038	K6370	K6538	K6710	K6865	K6980	K8720
K3310	K4330	K4500	K5385	K5582	K61045	K6380	K6539	K6715	K6870	K6985	K8806
K3323	K4335	K4515	K5390	K5630	K61055	K6385	K6548	K6721	K6874	K6988	K8810
K3325	K4340	K4520	K5395	K5635	K61065	K6390	K6555	K6696	K6875	K71005	K8820
K3335	K4345	K4525	K5400	K5640	K61075	K6400	K6557	K6730	K6880	K71037	K8830
K3340	K4350	K4535	K5405	K5645	K61080	K6405	K6560	K6733	K6885	K7362	K8981
K3365	K4355	K4545	K5420	K5650	K61105	K6410	K6590	K6735	K6895	K7425	K8990
K3385	K4360	K4560	K5425	K5660	K61110	K6415	K6595	K6740	K6990	K7610	
K3390	K4365	K4575	K5430	K5690	K61115	K6420	K6600	K6745	K6995	K7650	
K3395	K4370	K4595	K5435	K5705	K61120	K6425	K6605	K6750	K6900	K7670	
K3400	K4378	K4685	K5440	K5715	k61130	K6436	K6610	K6755	K6905	K7690	
K3415	K4382	K4880	K5446	K5720	K61150	K6441	K6615	K6760	K6910	K7695	
K3425	K4385	K4940	K5450	K5750	K61015	K6445	K6620	K6770	K6915	K7700	
K3455	K4390	K5200	K5455	K5755	K61125	K6450	K6625	K6775	K6919	K7735	
K4238	K4395	K5273	K5460	K5780	K61177	K6455	K6637	K6780	K6926	K7835	
K4248	K4400	K5280	K5470	K5815	K61187	K6465	K6640	K6785	K6930	K7855	
K4250	K4405	K5315	K5475	K5825	K61360	K6470	K6642	K6790	K6935	K7875	
K4270	K4410	K5325	K5480	K5835	K6288	K6475	K6650	K6805	K6940	K7885	
K4275	K4413	K5330	K5490	K5845	K6295	K6480	k6660	K6810	K6942	K7890	
k4285	K4420	K5336	K5500	K5855	K6305	K6490	K6663	K6815	K6945	K7895	





## BANDAS TIPO V

CÓDIGO	CÓDIGO	CÓDIGO	CÓDIGO	CÓDIGO	CÓDIGO	CÓDIGO	CÓDIGO	CÓDIGO
15215	15290	15340	15385	15425	15475	15525	15575	15630
15225	15295	15345	15388	15430	15480	15530	15580	15640
15240	15300	15348	15390	15435	15483	15535	15585	15645
15250	15305	15350	15395	15440	15485	15540	15590	15650
15255	15310	15355	15400	15445	15490	15545	15595	15660
15260	15315	15360	15405	15450	15495	15550	15600	15670
15265	15320	15361	15410	15455	15500	15555	15605	15680
15270	15325	15365	15415	15460	15505	15560	15610	15700
15275	15328	15370	15418	15465	15510	15565	15615	
15280	15330	15375	15420	15470	15515	15570	15620	
15285	15335	15380	15423	15472	15520	15571	15625	
17245	17315	17365	17410	17455	17505	17565	17625	17700
17250	17320	17370	17415	17460	17510	17570	17630	17710
17260	17325	17375	17420	17463	17515	17580	17635	17725
17265	17330	17380	17425	17465	17525	17585	17640	17730
17270	17335	17385	17430	17470	17530	17590	17650	17740
17280	17340	17390	17435	17475	17540	17595	17660	17745
17290	17343	17395	17440	17480	17548	17600	17665	17755
17295	17350	17400	17443	17485	17550	17605	17670	
17300	17355	17403	17448	17490	17555	17610	17680	
17305	17360	17405	17450	17495	17560	17620	17690	



# FILTROS DE AIRE

CÓDIGO	FRAM	CÓDIGO	FRAM	CÓDIGO	FRAM	CÓDIGO	FRAM	CÓDIGO	FRAM
DA45	CA184	DA4343	CA5056	DA4633	CA6626	DA4690	CA7351	DA4886	CA7626
DA67	CA192	DA3593	CA5057	DA4643	CA6664	DA4712	CA7365	DA4831	CA7628
DA4	CA3529	DA3592	CA5058	DA4645	CA6690	DA4721	CA7417	DA5378	CA7640
DA4372	CA3901	DA4601	CA5125	DA4669	CA6850	DA4873	CA7420	DA4877	CA7730
DA4852	CA3914	DA4722	CA5466	DA4675	CA6900	DA4731	CA7421	DA4858	CA7738
DA3590	CA3916	DA5049	CA5595	DA4650	CA7094	DA4995	CA7431	DA5150	CA7764
DA4278	CA4309	DA4378	CA6366	DA4715	CA7142	DA5048	CA7432	DA4879	CA7774
DA4299	CA4830	DA4468	CA6395	DA4717	CA7167	DA4727	CA7440	DA5076	CA7775
DA4361	CA4939	DA4490	CA6541	DA4799	CA7174	DA4880	CA7597	DA5065	CA8033
DA4467	CA4940	DA4409	CA6545	DA4720	CA7344	DA5050	CA7605	DA5091	CA8037
CÓDIGO	FRAM	CÓDIGO	FRAM	CÓDIGO	FRAM	CÓDIGO	FRAM	CÓDIGO	FRAM
DA5090	CA8038	DA5227	CA8221	DA5373	CA8766	DA5359	CA9286	DA5431	CA9492
DA4878	CA8039	DA5192	CA8243	DA5306	CA8805	DA5418	CA9332	DA5507	CA9600
DA5148	CA8040	DA5249	CA8475	DA5414	CA8817	DA5433	CA9345	DA5589	CA9798
DA5219	CA8069	DA5257	CA8547	DA5397	CA8911	DA5398	CA9359	DA5588	CA9902
DA5266	CA8121	DA5267	CA8602	DA5370	CA8922	DA5410	CA9367	DA6122	NO HAY
DA6067	CA8141	DA5265	CA8606	DA5324	CA8969	DA5435	CA9402	DA5596	CA10085
DA5155	CA8142	DA5372	CA8747	DA5323	CA8997	DA5457	CA9409	DA5582	CA10094
DA5207	CA8162	DA5330	CA8754	DA5405	CA9053	DA5387	CA9441	DA5625	CA10163
DA5089	CA8205	DA5314	CA8755/56	DA5396	CA9054	DA5488	CA9471	DA5633	CA10173
DA5244	CA8208	DA5352	CA8760	DA5363	CA9115	DA5463	CA9482	DA5634	CA10192



# FILTROS DE AIRE

CÓDIGO	FRAM	CÓDIGO	FRAM
DA5700	CA10254	DA6308	CA10468
DA5780	CA10344	DA5775	CA10488
DA6306	CA10359	DA5841	CA10616
DA5822	CA10466	DA5907	CA10781
DA6309	CA10467	DA6149	CA11114



# FILTROS DE ACEITE

CÓDIGO	FRAM
D4651	PH2
D1A	PH8A
D4670	PH16
D252	PH2870A
D111	PH3387A
D4459	PH3593A
D195	PH3600
D241	PH3614
D4006	PH3675
D4457	PH3682
D193	PH3950
D4011	PH3980
D4619	PH3985
D4477	PH4386
D4476	PH4967
D4612	PH6607
D4610	PH7317
D5230	PH8316
D2222	PH10060



## FILTROS DE ACEITE

## FILTROS DE ACEITE CON CARTUCHO

CÓDIGO	FRAM
D85	CH3970
D5309	CH8806
D5436	CH9018
D5505	CH9641
D8113	CH9461
D5581	CH9911



# SUSPENSIÓN





# SUSPENSIÓN

## ROTULA

CÓDIGO	CÓDIGO	CÓDIGO	CÓDIGO	CÓDIGO	CÓDIGO	CÓDIGO	CÓDIGO	CÓDIGO	CÓDIGO
CF1008001	K5208	K6145	K6701	K7451	K80591	K8259	K90255	K90357	K9519
DA40160	K5273-OE	K6291	K6713	K7452	K80604	K8608T	K90258	K90434	K9554
ES3609	K5289	K6292	K7241	K7218	K80629	K8609T	K90264	K90459	K9643
K100071	K5301	K6527	K7242	K80008	K80647	K8611T	K90309	K90469	K9645
K3134T	K5320	K6539-OE	K7346	K80010	K80660	K8683	K90332	K90663	K9802
K500015	K5331	K6540	K7393	K80012	K80964	K8685	K90336	K9343	K8738
K500034	K5335	K6541	K7399	K80014	K80992	K8687	K90346	K9459	K8647
K500090	K6117T	K6663-OE	K7429	K80027	K80997	K8695T	K90347	K9482	K8478
K500223	K6141	K6693	K7449	K80067	K8195T	K8773	K90355	K9499	



## ROTULA BARRA DE ACOPLAMIENTO

CÓDIGO	CÓDIGO	CÓDIGO	CÓDIGO	CÓDIGO	CÓDIGO	CÓDIGO	CÓDIGO	CÓDIGO	CÓDIGO
ES2019RL	ES2946L	ES3311S	ES3380T	ES3474	ES3630	ES80287	EV317	EV428	K8755
ES2020RL	ES3084R	ES3349RL	ES3386RL	ES3475	ES3646	ES80288	EV362	EV433	K6535
ES2361	ES3085L	ES3353RL	ES3387RL	ES3488	ES3660	ES80309	EV367	EV440	K8763
ES2814RL	ES3095R	ES3364T	ES3401RL	ES3490	ES3661	ES80311	EV380	EV457	K9422
ES2836RL	ES3096L	ES3365T	ES3407	ES3491	ES3667	ES80381	EV400	EV458	K8700
ES2837RL	ES3173RL	ES3366T	ES3438	ES3524	ES3709A	ES80431	EV401	EV469	K6365T
ES2838RL	ES3181RL	ES3367T	ES3455	ES3525	ES3710A	ES80432	EV408	EV470	K7240
ES2900S	ES3184RL	ES3368S	ES3461	ES3581	ES800030	ES80590	EV415	EV80310	
ES2926RL	ES3238RL	ES3377	ES3472	ES362S	ES800574	EV127	EV423	EV80789	
ES2943R	ES3254RL	ES3379T	ES3473	ES3629	ES80277	EV181	EV427	EV80988	

# SUSPENSIÓN



## BUJE

CÓDIGO	CÓDIGO	CÓDIGO	CÓDIGO	CÓDIGO
K200041	K200151	K200255	K80024	K9733
K200066	K200183	K200717	K80057	
K200067	K200254	K6698	K8436	

## KIT PARA BUJE

CÓDIGO	CÓDIGO	CÓDIGO	CÓDIGO	CÓDIGO	CÓDIGO	CÓDIGO	CÓDIGO	CÓDIGO	CÓDIGO
K200161	K3168	K6329	K6439	K6679	K7276	K7353	K7472	K80099	K8690
K200162	K3170	K6333	K6578	K6724	K7286	K7354	K7474	K80151	K8704
K200217	K3172	K6395	K6649	K7164	K7291	K7362-OE	K80009	K80830	K8705
K200327	K6167	K6408	K6650-OE	K7194	K7350	K7391	K80018	K8219	K90016
K200601	K6198	K6411	K6651	K7212	K7351	K7406	K80019	K8415	K90054
K3160	K6282	K6437	K6658	K7244	K7352	K7435	K80020	K8689	K8733
K8788	K8721	K90025							



## BUJE BRAZO CONTROL

CÓDIGO	CÓDIGO
K7471	K80235
K80100	



# SUSPENSIÓN

## KIT BARRA ESTABILIZADORA

CÓDIGO	CÓDIGO	CÓDIGO	CÓDIGO	CÓDIGO	CÓDIGO	CÓDIGO	CÓDIGO	CÓDIGO	CÓDIGO	CÓDIGO
K3201	K6666	K80074	K80080	K80265	K80461	K80842	K8648	K90341	K90369	K9231
K5252	K6667	K80075	K80081	K80266	K80468	K80843	K8848	K90342	K90390	
K5342	K6668	K80076	K80082	K80296	K80470	K80861	K8852	K90343	K90433	
					K80471	K80899	K90128	K90344	K90452	
K6662	K7348	K80078	K80235	K80458	K80478	K8402	K90130	K90352	K90453	
K6665	K80073	K80079	K80252	K80460	K80685	K8625	K90340	K90353	K9228	



## BARRA ESTABILIZADORA

			CÓDIGO	CÓDIGO	CÓDIGO	CÓDIGO
K7258	K7430	K750098	K80066	K80824	K90664	K90705
K7275	K7431	K80015	K80596	K90531	K90684	K90715
			K80611	K90548	K90702	K90718
K7306	K7433	K80058	K80636	K90617	K90703	K80502
K80583						

## OTROS

CÓDIGO	CÓDIGO
K6349	K9545
K8452	K9824
K90517	
K9511	
K9515	

# PRODUCTOS



## AROMAS



CONTENIDO 1 galón

CÓDIGO	AROMA
1088-1	TALCO .
1097-1	JASMIN 1
1096-1	PIÑA COLADA
1098-1	FRESA
1095-1	ESPECIES
1093-1	CEREZA
1090-1	CARRO NUEVO
1089-1	VAINILLA

## PULIMENTO



CONTENIDO 1 galón

CÓDIGO	DESCRIPCION
1064-1	TOQUE FINAL
	CORTE PERFECTO
	USO PESADO
1012-1	GRUESO XXX

## CERA LIMPIADORA DE VIDRIOS.



CERA CON PROTECCION UV  
CONTENIDO: 1 galón  
CÓDIGO: 1130-1

CÓDIGO

1130-1

## CERA EXPRES



CÓDIGO

1025-1

## CERA CON AROMA A CEREZA



CONTENIDO: 1 galón

CÓDIGO

1052-1



TRATAMIENTO PARA PIEL  
DEVUELVE BRILLO Y PROTEJE  
CONTENIDO: 1 galón

CÓDIGO

1131-1



## AROMAS

CERA CARNAUBA C/ NANOTECNOLOGIA



CÓDIGO	PRESENTACION
1111-1	1 GALON
1111-16	SPRAY 16oz

## PULIMENTO



CÓDIGO	PRESENTACION
1023-1	1 GALON
1223-16	SPRAY 16oz

## LIMPIADOR PARA VINIL



SUSTITUTO DE ARMOR ALL

CÓDIGO	DESCRIPCION	CONETNIDO
1031-5	NORMAL	5 GALONES

## ARILLA PARA DETALLADO

COLOR AZUL  
CONTENIDO: 200grs  
CÓDIGO: 2026B

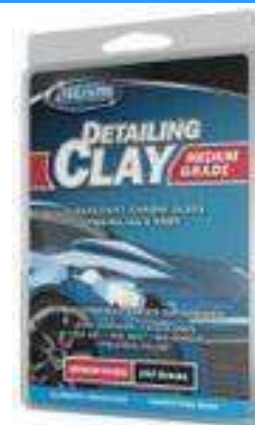
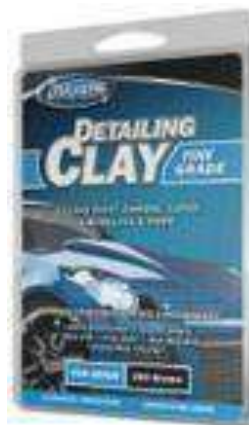

COLOR ROJO  
CONTENIDO: 200grs  
CÓDIGO: 2026R

## DESENGRASANTES



CÓDIGO	DESCRIPCION	CONTENIDO
1001-5	USOS MULTIPLES	5 Galones
1030-5	USO RUDO	5 Galones
1030-1	USO RUDO	1 Galón

## SHAMPOOS



CÓDIGO	DESCRIPCION
1048-5	P/ CARROCERIAS.
1024-5	P/ INTERIORES
1045-5	CONCENTRADO

## BORLAS



**BORLA AMARILLA  
PARA PULIR  
CÓDIGO: 3022**



**BORLA FINA AMARILLA  
100% LANA DE 7.5"  
CÓDIGO: 3033**

## BORLAS



**BORLA NEGRA  
PARA PULIR  
CÓDIGO: 3023**



**BORLA GRUESA BLANCA  
100% LANA DE 7.5"  
CÓDIGO: 3031**

## SPRAY ABRILLANTADOR



### SPRAY ABRILLANTADOR CON CAPA PROTECTORA

CÓDIGO	DESCRIPCION
<b>2041-12</b>	P. EXTERIOR 1-DEFENSAS 2-PLASTICO, ETC.
<b>2045-12</b>	P. INTERIOR 1 SALPICADEROS 2 RESPIRADERO 3 ASIENTOS, ETC.



### ESPUMA PARA TAPICERIA HI-LUSTRE

- DEJA SUPERFICIE LIMPIA Y SECA.

**CÓDIGO: 2046**

## ESPONJA PARA APLICAR ARMORALL



ESPONJA ESPECIAL PARA  
APLICAR ARMOR ALL  
PAQUETE CON 12PZS.

CÓDIGO: EAA-12

## SELLADOR PREMIUM



TAPETE DE PAPEL  
ENCERADO  
PAQUETE CON 500PZS

CÓDIGO: 3680

## TRATAMIENTO Y ACONDICIONADOR PARA PIEL



TRATAMIENTO PARA  
PIEL  
DEVUELVE BRILLO Y  
PROTEJE  
CONTENIDO: 1 galón  
CÓDIGO: 1132-1

CÓDIGO

1132-1

## RESPALDO DE HULE P/ BORLA CON VELCRO



CÓDIGO

3030

## SELLADOR PREMIUM



ALTO BRILLO  
PROTECCION PURA, FACIL DE  
APLICAR Y REMOVER.  
CONTENIDO: 1 galón  
CÓDIGO: 1142-1

CÓDIGO

1142-1

## COMPUESTO DE CORTE Y PULIDO



TRATAMIENTO PARA PIEL  
DEVUELVE BRILLO Y PROTEJE  
CONTENIDO: 1 galón  
CÓDIGO: 1069-1

CÓDIGO

1069-1



**PURPLE CLEAN ULTRA**



LIMPIADOR

DESENGRASANTESUPER  
CONCENTRADO PARA USO DOMESTI-  
CO, EN AUTOS, INDUSTRIA Y MÀS.

**CÓDIGO PC-32    CONTENIDO 1 litro**

**ATOMIZADOR REFORZADO  
PARA USO INDUSTRIAL**



**CÓDIGO: ACR-02**

**ATOMIZADOR REFORZADO**

**PARA USO  
INDUSTRIAL**



**CÓDIGO: 3725**

**DESENGRASANTE AWESOME PARA USO  
GENERAL**



**CÓDIGO  
FS12453  
FS12454**

**CONTENIDO  
24oz  
32oz**

**GUANTES PARA  
LAVAR CARRO**



**CÓDIGO: 11009**

# CABLES PASA CORRIENTE



CÓDIGO	CALIBRE	LONGITUD	CÓDIGO	CALIBRE	LONGITUD
50461	4	20 FTS	87017	8	12 FTS
50462	2	20FTS			
50463	2	25FTS			
87014	10	10 FTS			

## PLUMA PARA LEVANTAR MOTORES



CÓDIGO	DESCRIPCION
11-897	CONSTAN, PARA 6 TONELADAS
11-896	SIN STAN, PARA 6 TONELADAS

## TECLE CADENA



CÓDIGO	CAPACIDA
02350	1 1/2 Ton.
CHICH022	2 Ton.
02500	3 Ton.

## TECLE DE CABLE



CÓDIGO	CAPACIDAD
1190	2 Ton.
1191	4 Ton.
1192	6 Ton.

## TECLE DE CABLE



**PROFESIONAL**  
CON CAPACIDAD DE 8000  
Lbs (3.63 ton)

**CÓDIGO: CHIC52**

## TECLE DE CABLE

**HEAVY DUTTY**  
CON CAPACIDAD DE  
2-1/2 TON

**CÓDIGO: 89024**



## TECLE DE CABLE

**HEAVY DUTTY**  
CON CAPACIDAD DE  
2-1/2 TON

**CÓDIGO: 89029**





## MORDAZAS

### P/ CARGADORES DE BATERIA, CABLES

PASA CORRIENTE Y/O EQUIPO ELECTRICO



CÓDIGO	MEDIDA
00335	Grande
00336	Chica

### PAQUETE C/10pzs.

#### GRANDE

PAQUETE C/ 2PZS.

**CÓDIGO: 00182**



TORNILLO PARA  
TERMINAL DE BATERIA  
BOLSA CON 50PZS

**CÓDIGO: 05304**

### CAIMAN MINI



DE 60 AMPERES. USA

**CÓDIGO: 06145**

### PAQUETE DE CAIMANES



- PAQUETE DE CAIMANES CON 12pzas
- TAMAÑO 2"
- ACERO NIQUELADO
- CON COLORES PARA FACIL IDENTIFICACIÓN
- USOS ILIMITADOS EN ELECTRICIDAD, ARTE, HOBBY, HOGAR ETC..

**CÓDIGO: 8019AC12**

### CABLE P/ARRANCADOR DOBLE OJO,



	CÓDIGO ROJO	MEDIDA
04282	04276	DE 16"
04284	04278	DE 24"
	04279	DE 32"
04286	04280	DE 40"
04287	04281	DE 49"



### CABLE PARA BATERIA



CÓDIGO NEGRO	CÓDIGO ROJO	MEDIDA	CÓDIGO NEGRO	CÓDIGO ROJO	MEDIDA
04153	04138	DE 10"	04161	04146	DE 38"
04154	04139	DE 12"	04162	04147	DE 43"
04155	04140	DE 15"	04163	04148	DE 48"
04156	04141	DE 20"	04164	04149	DE 53"
04157	04142	DE 25"	04165	04150	DE 56"
04158	04143	DE 27"	04166	04151	DE 65"
04159	04144	DE 32"	04167	04152	DE 72"
04160	04145	DE 34"			

# CABLE PRIMARIO ROLLO CON 100 FTS

### ROJO

CÓDIGO	CALIBRE
110-R	10
112-R	12
114-R	14
116-R	16
118-R	18



### NEGRO

CÓDIGO	CALIBRE
110-N	10
112-N	12
114-N	14
116-N	16
118-N	18



### BLANCO

CÓDIGO	CALIBRE
110-B	10
112-B	12
114-B	14
116-B	16
118-B	18







**TERMINAL PARA BATERIA  
UNIVERSAL**

**INCLUYE OREJA  
OJAL PARA PLEJAR**



**CÓDIGO: 01056**

**TERMINAL DE PLOMO PARA BATERIA PAQUETE CON 2 PZS**



**CÓDIGO: 00353**

**TERMINAL MARINA  
DE PLOMO**



CÓDIGO	MEDIDA
05308	3/8
05309	5/16

**POSTES PARA BATERIA PAQUETE CON 2PZS.**



**HEMBRA  
CÓDIGO: 00575**



**MACHO  
CÓDIGO: 00352**



**TERMINAL DE OJO**



CÓDIGO	PARA CABLE
05335T	2/0 X 1/2"
05327	4 X 3/8"

**TORNILLOS PARA BATERIA**



**CÓDIGO: 00243**

**BASE DE PLASTICO**



CÓDIGO	MEDIDA
00252	13 3/4in (GDE)
00253	11 3/8in (CH)

**"H" PARA BATERIA**



**BATERIA  
CÓDIGO: 00250**

**CON TORNILLO.  
CÓDIGO: 00678**



DE HULE  
REFORZADO  
CÓDIGO: 2248



DE HULE  
SENCILLA  
CÓDIGO: 2246



BLINDADA  
CÓDIGO:  
CLA-020



CLAVIJA DE ROSCA PATA  
DE FIERRO  
CÓDIGO: CLA-004



REFORZADA  
TIPO INDUSTRIAL  
CÓDIGO: 2249

### CONTACTO TRIFASICO



USO RUDO  
CÓDIGO: CTO-015

### CLAVJA ADAPTADORA



DE TRIFASICO A  
MONO FASICO  
CÓDIGO: CLA-011

### SWITCH TIPO AB



PARA CABLE/ANTENA  
2 ENTRADAS Y 1 SALIDA  
CÓDIGO: SWI-002

### DIVISOR DE SEÑALES



1 ENTRADA Y 3 SALIDAS  
PARA VIDEO DE 5 A 1000MHZ  
CÓDIGO: DIV-003

## APAGADORES Y TOMA CORRIENTES



APAGADOR DOBLE  
CÓDIGO: U-09



APAGADOR Y TOMA  
CORRIENTE  
CÓDIGO: U-10



TOMA CORRIENTE  
DOBLE  
CÓDIGO: EF03



APAGADOR  
SENCILLO  
CÓDIGO: U-07



TOMA CORRIENTE DOBLE  
CON PROTECTOR  
CÓDIGO: EF07

### TAPA DE ABS MARFIL



P/TOMA CORRIENTE  
DOBLE  
CÓDIGO: UF2



P/APAGADOR  
SENCILLO  
CÓDIGO: UF1



CIEGA  
CÓDIGO: PLA-016



P/PILOTO  
CÓDIGO: PLA-017

### TAPA CEGA DE ALUMINO



COLOR ORO  
CÓDIGO: PLA-004

### ROSETA



DE PORCELANA  
DE 4"  
CÓDIGO: EF507-2S

### SENCILLO



DE PORCELANA  
CÓDIGO: EF517

### SOQUET REFORZADO



DE HULE  
PARA INTERPERIE  
250V - 660W  
CÓDIGO: PBW-27

### ADAPTADOR



DE CLAVIJA A SOQUET  
MARFIL  
CÓDIGO: SOC-013

### LADRON/ CADENA



MARFIL  
(CALAVERA  
CON CADENA)  
CÓDIGO: LAD-004



## LAMPARA DE PROCELANA 4"



15Amp

**CÓDIGO:**  
**M507CW3S-UL**

## RESITENCIA P/REGADERA ELECTRICA



**CÓDIGO: RE-002**

## VARILLA DE BRONCE



DE ½" X 1 m  
PARA TIERRA FISICA EN  
INSTALACIONES  
ELECTRICAS

**CÓDIGO: BAR-012**

## ABRAZADERA



PARA VARILLA DE BRONCE  
**CÓDIGO: CON-002**

## SEPARADORES PARA PISO

Esta variedad de separadores está destinada a abarcar distintas medidas de cerámicas para pisos y revestimientos dependiendo del estilo buscado y el gusto personal.

La escasa altura de todos los modelos le permite realizar el empastinado sin necesidad de removerlos con lo cual ahorrará tiempo en esa etapa del trabajo.



MEDIDA 1/8"  
CON 110pzs.  
**CÓDIGO: 2671**

## CONTROL REMOTO



IDEAL PARA CONTROLAR  
TV, DVD o CABLE  
PERMITE NAVEGACION COMPLETA  
DEL DVD

**CÓDIGO: RCU403**

## CINTA METRICA "AMERICA"



25'/7.5M

**CÓDIGO: 20041**

## CODO DE POLIPRODUCTO USO: GUIA PARA INSTALACIONES



CÓDIGO	MEDIDA
COD-002	3/4"



## GANCHOS PERFOCEL

CÓDIGO	MEDIDA
GP-4	DE 4"
GP-6	DE 6"
GP-8	DE 8"



**DELGADOS**



**GRUESOS**

CÓDIGO	MEDIDA
GPG-4	DE 4"
GPG-6	DE 6"
GPG-8	DE 8"

## GANCHOS TRIPLAY RANURADO



CÓDIGO	MEDIDA
34105	DE 4"
34106	DE 6"
34107	DE 8"

## ARMELLA SURTIDO CON 151 pz



### MEDIDA

60 pz: 1-1/8"  
 12 pz: 1-13/16"  
 12 pz: 1-15-16"  
 5 pz: 3-3/8"  
 50 pz: 1-5/8"  
 12 pz: 2-1/2"

### CÓDIGO

**TAIAE151**

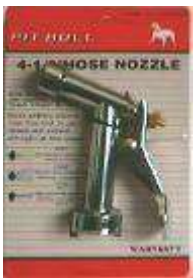

DE 4 ½"



DE 5 ½"  
REFORZADA



DE 5 ½" REFORZADA  
CON PROTECTOR DE ABS  
CÓDIGO: 21654Y



DE PLASTICO  
CON SEGUROS APRUEBA DE FUGAS  
CÓDIGO: 21649

**COPELE HEMBRA 5/8" X 3/4"**



- DE PLASTICO
- FACIL DE USAR
- REUTILIZABLE

CÓDIGO: 14701

**COPELE MACHO 5/8" X 3/4"**



- DE PLASTICO
- FACIL DE USAR
- REUTILIZABLE

CÓDIGO: 14702

**CONECTOR 5/8" X 3/4"**



- DE PLASTICO
- FACIL DE USAR
- REUTILIZABLE

**MANGUERA REFORZADA**



CÓDIGO	MEDIDAS
C-1515	DE 5/8 X 50 PIES
C-1510	DE 5/8 X 25 PIES
C-1615	DE 5/8 X 100 PIES
FR5875	DE 5/8 X 75 PIES

**CAJA DE POSTAS CON 10 X 200**



CÓDIGO	MEDIDAS
POS	4.5mm

**ESTOPA**



CÓDIGO	DESCRIPCION
PB-1/2	BOLSA CON ½ Kg
PB-1	BOLSA CON 1Kg

**CEPILLO DE TELA PARA LAVAR CARRO**



CÓDIGO: 28311

**CEPILLO PARA LAVAR LLANTAS  
CON MANGO DE PLASTICO**



AMARILLO

CÓDIGO: 3103Y



AZUL

CÓDIGO: 3103B



BLANCO

CÓDIGO: 3103W



BLANCO U.S.A

CÓDIGO: 5012

**CEPILLO PARA  
USOS MULTIPLES  
DE 20"**



BLANCO  
CON CERDAS SUPER SUAVES

**CÓDIGO: 3105-L**

**CEPILLO DE 10"**



CON BLOCK DE PLASTICO  
CÓDIGO: 1810-P



**CEPILLO HECHO PARA ESCOBA  
CON 2 PERFORACIONES ROSCADAS PARA FIJAR EL BASTÓN  
HECHO EN BLOCK DE MADERA DE PINO**



FIBRA DE POLIESTER

CÓDIGO	MEDIDA
1518	DE 18in
1524	DE 24in



FIBRA DE POLIPROPILENO

CÓDIGO	MEDIDA
1118	DE 18in
1124	DE 24in



FIBRA DE PALMYRA NATURAL

CÓDIGO	MEDIDA
1218	DE 18in
1224	DE 24in



## BASTON DE MADERA PARA CEPILLO

DE 7/8 X 1.20MTS  
CON PUNTA ROSCADA MADERA

CÓDIGO: 1901



JALADOR CON ESPONJA  
MANGO DE PLASTICO



CÓDIGO

LV-P

## JALADOR DE AGUA PARA PISOS



SIN MANGO

CÓDIGO: 7104-I



MANGO METALICO

CÓDIGO: 7104-BM

## BASTON DE MADERA PARA CEPILLO



DE 7/8 X 1.20MTS  
CON PUNTA ROSCADA  
METALICA

CÓDIGO: 1904

## CEPILLO COMPLETO DE 24"

INCLUYE MANGO  
CON PUNTA DE METAL DE  
60"  
Y TIRANTES PARA  
SOPORTE

CÓDIGO: 1124-P



## TIRANTES DE REFUERZO PARA CEPILLO



BRINDAN EXCELENTE SOPORTE  
AL BASTON Y HACEN POSIBLE  
UTILIZARLOS CEPILLOS EN USOS  
MUY RUDOS.

CÓDIGO: 1910

**FRANELA SIN TRATAR.  
ROLLO DE 50cm X 50m**



ROJA

**CÓDIGO: F-176RR**



GRIS

**CÓDIGO: F-172RG**



BLANCA

**CÓDIGO: F-175RB**

**JERGA EN ROLLO**



**CÓDIGO: JR-172**



**FRANELA EN  
PAQUETE  
DE 50cms x 90cms.**



CÓDIGO	DESCRIPCION	CÓDIGO	DESCRIPCION
F-172GT	GRIS TRATADA	F-176RT	ROJA TRATADA
F-172G	GRIS SIN TRATAR	F-176R	ROJA SIN TRATAR

# Master Lock

## CANDADOS MASTER CON CUERPO DE HIERRO SÓLIDO DE 1 9/16" CON GANCHO DE 38mm.



PAQUETE C/ 4PZS  
CÓDIGO: 740QLF



PAQUETE C/ 2 PZS  
CÓDIGO: 740TLF



INDIVIDUAL  
CÓDIGO: 740DLF

## CANDADOS MASTER CON CUERPO DE HIERRO SÓLIDO



CUERPO DE 1 9/16"  
GANCHO DE 22mm  
CÓDIGO: 740D



CUERPO DE 2"  
GANCHO DE 8mm  
CÓDIGO: 750D

## CANDADO LAMINADO CON ARGOLLA DE ACERO



CÓDIGO	MEDIDA
1D	DE 1 3/4"
3D	DE 1 1/2"
5D	DE 2"
7D	DE 7"



CÓDIGO	CANDADO	ARGOLLA
1DLJ	DE 1 3/4"	DE 2 1/2"
3DLH	DE 1 9/16"	DE 2"
3DLF	DE 1 9/16"	DE 1 1/2"

## CANDADO MASTER MAXIMA SEGURIDAD

DE CONTRATADOR GRANDE RESISTENTE A CORTES, PUNZONES, PERFORACIONES Y CORROSION. CON ARGOLLA DE ALEACION DE BORO, CILINDRO 5 PATILLAS



CANDADO MASTER ECONOMICO, EN BLISTER

CÓDIGO	CANDADO	ARGOLLA
1902D	DE 1 9/16"	DE 22mm
1901D	DE 1 3/16"	DE 14mm



CÓDIGO	MEDIDA
930DPF	1.25" (31mm)
230DLHPF	2" (51mm)
930DLHPF	2 1/2" (51mm)

## CANDADO MASTER DE COMBINACION

GANCHO DE ACERO ENDURECIDO DE 7mm (9/32")  
CÓDIGO: 1500D



## CANDADO MASTER CON MECANISMO DE SEGURO DOBLE ARGOLLA DE ACERO ENDURECIDO DE 7mm (9/32")



PAQUETE C/ 3 PZS + 1 GRATIS  
GARANTIA DE POR VIDA.  
CÓDIGO: 3008D



PAQUETE C/ 2 PZS DE 2" X 25mm  
CÓDIGO: 5T



PAQUETE C/ 2 PZS  
CÓDIGO: 3T

## CANDADO MASTER PARA TRAILA



ACOPLE DE 2"  
CÓDIGO: 605DAT





### PORTACANDADO MASTER EN BLISTER

DE ACERO ENDURECIDO, DISEÑO DE ALTA SEGURIDAD



CÓDIGO	MEDIDA
706D	6"
703D	3 1/2"
702D	2 1/2"



### PORTACANDADO MASTER EN BLISTER

DE ACERO ENDURECIDO, DISEÑO DE ALTA SEGURIDAD



DE 4 1/2"

CÓDIGO: 704DPF

### PORTA CANDADO REFORZADO INCLUYE CHILILLOS PARA SU INSTALACIÓN



CÓDIGO	TAMAÑO
HS90	DE 4 1/2"
90065	DE 3 1/2"

### BISAGRA PLANA

PAQUETE CON 2 PZS. INCLUYE CHILLOS PARA SU INSTALACIÓN



CÓDIGO	MEDIDA
90064	DE 3" X 3"
90066	DE 3 1/2" X 3 1/2"
90068	DE 4" X 4"

### BISAGRA PLANA EN BLISTER

PAQUETE CON 2 PZS. INCLUYE CHILLOS PARA SU INSTALACIÓN



CÓDIGO	MEDIDA
UH10	DE 1" X 1"
UH15	DE 1 1/2" X 1 1/2"
UH20	DE 2" X 2"
UH25	DE 2 1/2" X 2 1/2"

### JALADERA PARA PUERTA EN BLISTER INCLUYE CHILILLOS PARA SU INSTALACIÓN.



DE 6" CON 1PZA. CÓDIGO: 58361

CÓDIGO	DESCRIPCION
01230	DE 4" C/ 2 PZS
01240	DE 6" C/ 2 PZS

### BROCHE TIPO MAUSER EN BLISTER



CÓDIGO	MEDIDA
60006	DE 1 1/2"
60007	DE 2"
60008	DE 2 1/2"
60005	DE 3"
60009	DE 4"
60011	DE 5"

### CADENA DE SEGURIDAD EN BLISTER



CÓDIGO: 60013

### CANDADO LAMINADO EN BLISTER



CÓDIGO	MEDIDA
40222	DE 30 MM
40224	DE 40 MM
40226	DE 50 MM

### CANDADO LAMINADO 12PZS



CONTIENE 4PZS. DE C/U DE LAS SIG. MEDIDAS. 30,40 Y 50mm

CÓDIGO: 40227



### CANDADO BRONCE 20 MM C/2

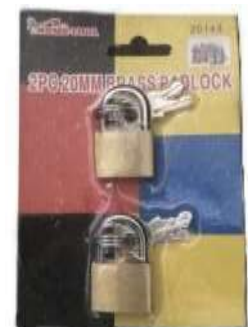

CÓDIGO: 20143

**TERMINAL DE OJO AISLADA  
PAQUETE CON 100PZS.**



AZUL	
CÓDIGO	MEDIDA
R6B1/4	1/4
R5B3/16	3/16
AZCTRB10	5/16
TEA009A	3/8

AMARILLO	
CÓDIGO	MEDIDA
R6Y1/4	1/4
R5Y3/16	3/16
04244	5/16

**CONECTOR ABIERTO**



AZUL

CÓDIGO	Paquetes
04268	100pzs

**TERMINAL CONECTOR MACHO**



AZUL

CÓDIGO	Paquetes
039-039	100pzs

**TERMINAL CONECTOR A TOPE**



AMARILLA



ROJO



AZUL

039-003	100pzs
---------	--------

AZCTBR	100pzs
--------	--------

--	--

**TERMINAL MACHO & HEMBRA**



AZUL



AMARILLO

04262	100pzs
-------	--------

04263	100pzs
-------	--------

**TERMINA HEMBRA DE ENCHUFE PAQUETE C/ 100PZS.**



CHICA CON PROTECTOR

CÓDIGO	Paquetes
04225	100pzs



AZUL

CÓDIGO	Paquetes
F-250BC	100pzs



ROJA

CÓDIGO	Paquetes
AZCTPFR	100pzs



AMARILLA

CÓDIGO	Paquetes
F-250YC	100pzs

**TERMINAL CONECTOR MACHO**



GRANDE CON PROTECTOR

04258	100pzs
-------	--------



AZUL

M-250BC	100pzs
---------	--------



ROJO

CÓDIGO	Paquetes
AZCTPMR	100pzs



AMARILLA

CÓDIGO	Paquetes
M-250YC	100pzs

## PROBADOR DE CORRIENTE PARA 12 VOLTS



ECONOMICO.  
CÓDIGO: W-2945



EXTRA HEAVY DUTTY  
CÓDIGO: CHIT0040

REFORZADO PARA USO RUDO.  
CÓDIGO: 70105



## PROBADOR DE CHISPA PARA BUJIA



TAIT0007

## PROBADOR DE BATERIA CON RANGO



81099

CHIT0045

IDEAL PARA CA-  
RRO, VAN,  
CAMIONETAS Y  
MOTOCICLETA

CÓDIGO	PROVEEDOR
81099	AMERICAN TOOL EXCHANGE
CHIT0045	AJ WHOSALE

## MORDAZA CHICA PARA CARGADOR



CON 2 PIEZAS  
DE 50 AMPERES.  
CÓDIGO: ZPC-3

## PROBADOR DE CORRIENTE



PARA  
110 Y 220 VCA.  
CÓDIGO: VCA110

## TERMINALES DE BRONCE PARA BATERIA

### SENCILLA

CÓDIGO

BL-06



### REFORZADA

CÓDIGO

BL-07



### DE 4 TORNILLOS

### REFORZADA

CÓDIGO

BL-08





## TERMINALES PARA BATERIA

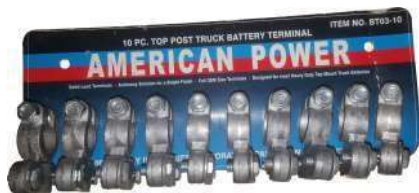

DE PLOMO

**REFORZADO HD**

CARTERA  
CON 10 PZS.

CÓDIGO: 777-L

DE PLOMO

CARTERA  
CON 10 PZS.

CÓDIGO: 888-L



DE PLOMO

LATERAL  
CARTERA  
CON 7 PZS.

CÓDIGO: 999-L

TERMINAL  
LATERAL  
CARTERA  
CON 10 PZS.

CÓDIGO: 87000



## SWITCH PARA DESCONECTAR LA BATERIA (CORTA CORRIENTE)



- CAPACIDAD: 300AMP.
- TERMINAL DE BRONCE 5/16"
- 2 LLAVES INCLUIDAS

CÓDIGO

87002



# ANTISULFANTES



CAJA C/ 60PZS.

CÓDIGO: 02450

## CARGADOR DE BATERIA

DE 10/2/55 AMPERS.  
FACIL DE USAR



CÓDIGO:  
CHIB0004

## MEDIDOR DE PRESION DE AIRE



0-100 PSI

CÓDIGO: PG-100



0-100 PSI

CÓDIGO: PG-200

## CARGADOR DE BATERIA CON BREAKER AUTOMATICO

DE 2 A 10 AMPERS.  
FACIL DE USAR



CÓDIGO: 86161

## JUMP STAR AUXILIAR DE ENCENDIDO



**2 en 1**  
CON ACCESORIOS DE AUTOMOCIÓN  
12V CON SALIDA DE CORRIENTE PARA  
RECARGAR BATERIA DE AUTOMOVIL,  
CUENTA CON COMPRESOR DE AIRE Y  
UNA LAMPARA DE EMERGENCIA.

CÓDIGO: JAM-400

## MINI COMPRESOR AIRE 6-12 VOLT



CÓDIGO	DESCRIPCION	PROVEDOR
88129	TANQUE DE 10gal. CON 3.5HP	AMERICAN TOOL EXCHANGE
CHIA477	TANQUE DE 10gal. CON 3.5HP	AJ WHOSALE



**REFORZADO**  
SALIDA DE 12 V PARA RECARGAR  
BATERIA DE AUTOMOVIL, CUENTA  
CON COMPRESOR DE AIRE Y UNA  
LAMPARA DE EMERGENCIA CON 7  
LEDS, 2 ENTRADAS PARA CONEC-  
TAR, 1 ENTRADA USB, BOTON DE  
ENCENDIDO O APAGADO, INDICA-  
DOR DE BATERIA,

CÓDIGO: 87015

## COMPRESOR LUBRICADO

CON  
TRANSMISIÓN DIRECTA  
DE FACIL  
TRANSPORTACIÓN,  
CON MANOMETRO  
INTEGRADO

CÓDIGO	DESCRIPCION
88139	TANQUE DE 10gal. CON 3.5HP



## VALVULA DE ESFERA DE CIERRE A 90°



SOLDABLE DE BRONCE  
ITALIANA FLUJO TOTAL  
ACABADO SATINADO

CÓDIGO	MEDIDA
62510	DE 3/4 in



DE P.V.C.  
CEMENTAR

CÓDIGO	MEDIDA
100PS-13	13mm (1/2")
100PS-19	19mm (3/4")
100PS-25	25 mm (1")
100PS-32	32 mm (1 1/4")
100PS-38	38 mm (1 1/2")
100PS-51	51 mm (2")

## MANGUERA FLEXIBLE



PARA BOYLER

CÓDIGO	MEDIDA
25B601/2	3/4" x 1/2" x 60cm



PARA SANITARIO

CÓDIGO	MEDIDA
67-ME	1/2" x 7/8" x 50cm

PARA LAVABO

CÓDIGO	MEDIDA
25ME1/240	1/2" x 1/2" x 40cm

PARA FREGADERO

CÓDIGO	MEDIDA
25ME1/255	1/2" x 1/2" x 55cm

MANERAL NILO JUEGO C/ 2PZS  
ENTRADA DE ESTRIA



COLOR AMBAR

CÓDIGO: RI-65

MANERAL NILO JUEGO C/ 2PZS  
ENTRADA DE ESTRIA



COLOR: TRANSPARENTE  
CÓDIGO: JMANLA



### VARILLA PARA BOLA DE FLOTADOR



**CÓDIGO: 6911-01**

### TORNILLO PARA TAZA Y BAÑO



**CÓDIGO: 6410-01**



### MEZCLADORA



**P/ LAVABO DE 4"**

- ◆ CUBIERTA DE A.B.S.
- ◆ MANERAL A.B.S.
- ◆ CIERRE DE 1/4 CERAMICO
- ◆ ACABADO CROMO

**CÓDIGO: M4A**

### MANGUERA CON TRENZADO DE ALUMINIO Y TUERCA DE METAL



CÓDIGO	DESCRIPCION
MANA35-WC	PARA BAÑO DE 1/2 x 7/8 x 35cm
MAN55-FRE	PARA FREGADOR 1/2x1/2x55cm
MANA40-LAV	MANGUERA P/ LAVABO 40CM 1/2 x 1/2"

### MANGUERA FLEXIBLE C/ TRAMA DE ACERO INOX. TUERCA DE LATON, PARA W.C.



CÓDIGO	LONGITUD
645	40cms.
645-A	50cms.
645-B	60cms.

### CHAPETON CROMADO DE ACERO INOXIDABLE



**PARA REGADERA**

**CÓDIGO: 571**



**VALVULA PARA WC**

**GIRA JACK**

**CÓDIGO: 2716**



**HERRAJE COMPLETO PARA  
SANITARIO**

CON VALVULA DE ADMISION.  
CONTIENE TODO LO NECESARIO  
PARA SU INSTALACION.

**EXTENSION FLEXIBLE  
PARA LAVABO O FREGADERO**



**CÓDIGO: 2702**

CÓDIGO	LONGITUD
2215	DE 11 A 25cms

**CESPOL (COLADERA)**



**JUMBO TIPO "P" FLEXIBLE  
SIN CUBIERTA  
PARA FREGADERO**

**CÓDIGO: 2933**

**MANGUERA PARA GAS CON TUERCA DE LA-  
TON DE 3/8"**

- FERULA DE LATON NIQUELADO



CÓDIGO	LONGITUD
AGAL5	5mts.

### TUBO DE PVC CON CEJA



DE 10cms DE LARGO  
CÓDIGO: TUBC10P

### LLAVE DE ESFERA SOLDABLE



300W DE 1/2"  
CÓDIGO: LLAES12MA

### GUACHA PARA TORNILLO



PUNTA DE BROCA  
CÓDIGO: GUATPB



### CINTAS DE MONTAJE

- CINTA DE ESPUMA CON PEGAMENTO EN AMBOS LADOS.
- FABRICADO PARA ALTA RESISTENCIA.
- 2 PIEZAS

CÓDIGO: 26572

### VASTAGO PARA MEZCLADORA(S)



IDEAL PARA LAS  
SIG. MEZCLADORAS

P/ FREGADEROS

MEZF8068

CÓDIGO: V3046

### LLAVE DE ESFERA DE PASO DE PVC



PARA CEMENTAR

CÓDIGO	MEDIDA
LLAPPS12	DE 1/2"
LLAPPS34	DE 3/4"



## PIGTAIL PARA GAS



CODIGO	TAMAÑO
PGAL	50cm
PGAL2	2 m

## GANCHOS PARA FREGADERO



CÓDIGO	DESCRIPCION
5660	GANCHO ESTANDAR P/FREGADERO 19mm X 40cm
5661	GANCHO COBRA P/FREGADERO 19mm
5665	GANCHO CISNE P/FREGADERO 19mm X 28cm
5679	GANCHO ESTANDAR P/FREGADERO 19mm X 34cm

## LLAVE ANGULAR



CÓDIGO	DESCRIPCION
53-040	LLAVE ANGULAR DE ZINC VUELTA COMPLETA 1/2" X 1/2"
53-041	LLAVE ANGULAR DE LATON VUELTA COMPLETA 1/2" X 1/2"

## ROSCA PARA PIG TAIL



CÓDIGO	DESCRIPCION
LN14	ROSCA PARA PIG TAIL

## ROSCA PARA PIG TAIL



CÓDIGO	DESCRIPCION
TI14	TUERCA INVERTIDA 1/4 * 1/4 MNPT

VALVULA DE AGUJA 1/4"



NVFF-0404

VALVULA DE AGUJA 3/8"



NVMF-0604

LLAVE DE MANGUERA DE 1/2"



79-110

LLAVE DE MANGUERA DE LATON 1/2"



79-111(L)

## GRIFOS PARA COSINA ECHO DE MATERIAL PLASTICO ABS



GRIFO PARA COCINA CENTRAL  
ESTILO ELITE 8" CON VIAS DE PLASTICO,  
MANIJAS ESTILO CERAMICAS  
**CÓDIGO: PRO-1018P**



GRIFO PARA COCINA CENTRAL ESTILO  
CISNE 8" CON VIAS DE PLASTICO  
**CÓDIGO: PRO-1018PF**



GRIFO PARA COCINA CENTRAL ESTILO COBRA  
8" CON VIAS DE PLASTICO, MANIJAS ESTILO  
BASICO  
**CÓDIGO: PRO-1022P**



GRIFO PARA COCINA CENTRAL  
ESTILO CLASICO 8" CON VIAS DE PLASTICO,  
MANIJAS ESTILO ALISE DE CERAMICA  
**CÓDIGO: PRO-3015P**



GRIFO PARA COCINA CENTRAL ESTILO  
ESTANDAR 8" CON VIAS DE PLASTICO,  
MANIJAS ESTILO EN CRUZ  
**CÓDIGO: PRO-1205P**



GRIFO PARA COCINA CENTRAL ESTILO  
MEZCLADORA DOBLE DE LATON,  
APLICACIÓN SOLO AGUJERO,  
VIENE CON 2 MANGUERAS  
**CÓDIGO: PRO-12000P**



GRIFO PARA COCINA CENTRAL  
ESTILO CISNE 8" CON VIAS DE  
COBRE, MANIJAS ESTILO BASICO  
**CÓDIGO: PRO-1035M**



GRIFO PARA COCINA CENTRAL  
ESTILO ALISE 8" CON VIAS DE  
COBRE, MANIJAS ESTILO CERAMICA  
**CÓDIGO: PRO-3015MF**



GRIFO PARA COCINA CENTRAL  
ESTILO COBRA 8" CON VIAS DE  
COBRE, MANIJAS ESTILO BSICO  
**CÓDIGO: PRO-1022M**

## GRIFOS PARA BAÑO ECHO DE MATERIAL PLASTICO ABS



GRIFO PARA BAÑO ESTILO PALANCA SENCILLA, CON VIA DE LATON

**CÓDIGO: PRO-N110P**



GRIFO PARA COCINA CENTRAL ESTILO ESTANDAR 8" CON VIAS DE COBRE, BASE DE METAL, CAÑON ACERO INOXIDABLE Y ASAS DE LATON

**CÓDIGO: PRO-K1310**



GRIFO PARA BAÑO ESTILO PERILLA DOBLE ELITE 4", CON VIA DE PLASTICO, CON SUPERFICIE Y MANIJAS CROMADAS, MANIJAS DE CERAMICA DE 1/4

**CÓDIGO: PRO-1044P**



GRIFO PARA BAÑO ESTILO CISNE C\DOBLE PERILLA 4", CON VIA DE PLASTICO, BASE DE PLASTICO, MANIJAS DE CERAMICA 1/4

ACABADO CROMADPO  
**CÓDIGO: PRO-1206P**



GRIFO PARA BAÑO ESTILO CISNE C\DOBLE PERILLA 4" CON VIA DE COBRE, BASE DE PLASTICO MANIJAS DE CERAMICA 1/4

ACABADO CROMADO  
**CÓDIGO: PRO-1206M**



GRIFO PARA BAÑO ESTILO PERILLA SENCILLA, CON VIA DE LATON

**CÓDIGO: PRO-N113P**



GRIFO PARA BAÑOS ESTILO SOCIEDAD 4" CON VIAS DE COBRE, MANIJAS DE

**CÓDIGO: PRO-1207M**



GRIFO PARA BAÑO ESTILO SOCIEDAD 4" CON VIA DE PLASTICO, CON MANGOS DE PLASTICO ABS Y ACABADO EN CROMO LA PUSERFIE

**CÓDIGO: PRO-1115P**





**NIPLE TERMINAL CON  
ESPIGA HEMBRA**

CÓDIGO	MEDIDA	NOTA
KFRS42W06-06	3/8" X 3/8"	T.INVERTIDA



**NIPLE TERMINAL CON  
ESPIGA**

CÓDIGO	MEDIDA
KFPS08-08	1/2" X 1/2"



**CONECTOR CON  
COMPRESION**

CÓDIGO	MEDIDA
68F05-06	5/16" X 3/8"
68F06-06	3/8" X 3/8"
68F08-08	1/2" X 1/2"



**VASTAGO PARA  
MONOMANDO**

CÓDIGO	MEDIDA
1352	1/4" X 40 mm
1356	1/4" X 35 mm



**VASTAGO PARA  
LAVABO DE LATON**

CÓDIGO	MEDIDA
31-023R	1/4" X 52 mm
31-023B	1/4" X 52mm



**VASTAGO PARA LAVABO DE  
PLASTICO**

CÓDIGO	MEDIDA
1353	1/4" X 46 mm S/ROSCA
1354	1/4" X 46mm C\ROSCA



**VASTAGO PARA  
REGADERA**



**CÓDIGO: 2432**



# PVC

**ADAPTADOR MACHO DE CPVC  
ROSCA EXTERIOR**



CÓDIGO	MEDIDA
AM34C	3/4"

**ADAPTADOR MACHO DE PVC**



CÓDIGO	MEDIDA
AM34	3/4"

**ADAPTADOR HEMBRA DE PVC  
ROSCA INTERIOR**



CÓDIGO	MEDIDA
AH12	1/2"
AH34	3/4"

**CODO DE CPVC  
ANGULO DE 45 GRADOS**



CÓDIGO	MEDIDA
C4512C	1/2"
C4534C	3/4"

**CODO DE PVC  
ANGULO DE 45 GRADOS**



CÓDIGO	MEDIDA
C4512	1/2"
C4534	3/4"

**CODO DE CPVC CON REDUCCION  
ANGULO DE 90 GRADOS**



CÓDIGO	REDUCCION
C90R3412C	3/4" A 1/2"

**CODO DE CPVC  
ANGULO DE 90 GRADOS**



CÓDIGO	MEDIDA
C9034C	3/4"

**CODO DE PVC  
ANGULO DE 90 GRADOS**



CÓDIGO	MEDIDA
C9034	3/4"

**TEE DE PVC**



CÓDIGO	MEDIDA
TPVC34	3/4"
TPVC12	1/2"

**TEE REDUCIDA  
DE PVC**



CÓDIGO	MEDIDA
TR3412	3/4" - 3/4" - 1/2"

**TEE DE CPVC**



CÓDIGO	MEDIDA
T34C	3/4"
T12C	1/2"

**COPELE DE PVC**



CÓDIGO	MEDIDA
C34	3/4"

**COPELE DE CPVC**



CÓDIGO	MEDIDA
C12C	1/2"

**REDUCTOR BUSHING**



CÓDIGO	REDUCCION
RB3412	3/4" A 1/2"

**REDUCTOR BUSHING**



CÓDIGO	REDUCCION
RB3412C	3/4" A 1/2"

**TAPON CAPA**



CÓDIGO	MEDIDA
TP34	3/4"

**TAPON CAPA  
DE CPVC**



CÓDIGO	MEDIDA
TC12C	1/2"
TC34C	3/4"

**TUERCA UNION  
DE CPCV CEMENTAR**



CÓDIGO	MEDIDA
TU12C	1/2"
TU34C	3/4"

**TUERCA UNION  
DE PVC ROSCADA**



CÓDIGO	MEDIDA
UR12	1/2"
UR34	3/4"

**PRESOSTATO PARA  
HIDRONEUMATICA**



REGULADO AUTOMATICO DE  
1.4/2.8 BAR.

CÓDIGO: PPH

**VALVULA ESFERA  
CPVC PARA CEMENTAR**



CÓDIGO	MEDIDA
VEC12C	1/2"
VEC34C	3/4"

**VALVULA ESFERA  
PVC PARA CEMENTAR**



CÓDIGO	MEDIDA
VEC12	1/2"
VEC34	3/4"

**PICHANCHA DE LATON  
CON REJILLA**



CÓDIGO	MEDIDA
P-10-13	1/2"
P-10-19	3/4"

**SOPORTE DE ALUMINIO  
PARA LAVABO**



CÓDIGO: SPLA





# COBRE

**CODO DE COBRE  
ANGULO DE 45 GRADOS**



CÓDIGO	MEDIDA
CC4512	1/2"
CC4534	3/4"

**CODO DE CU-FO  
(COBRE Y FIBRA OPTICA)  
ROSCA EXTERIOR  
ANGULO DE 90 GRADOS**



CÓDIGO	MEDIDA
CCFE9012	1/2"
CCFE9034	3/4"

**CODO DE CU-FO  
(COBRE Y FIBRA OPTICA)  
ROSCA INTERIOR  
ANGULO DE 90 GRADOS**



CÓDIGO	MEDIDA
CCFI34	3/4"

**CODO DE COBRE  
ANGULO DE 90 GRADOS**



CÓDIGO	MEDIDA
CC9012	1/2"
CC9034	3/4"

**CODO TERMINAL DE COBRE  
ANGULO DE 90 GRADOS**



CÓDIGO	EXTREMOS
CT3838	3/8" - 3/8"

**CODO UNION DE COBRE  
ANGULO DE 90 GRADOS**



CÓDIGO	EXTREMOS
CU3890	3/8" - 3/8"

**CODO DE COBRE PARA ESTUFA  
ANGULO DE 90 GRADOS**



CÓDIGO	EXTREMOS
CE381290	3/8" - 1/2"
CE3890	3/8" - 3/8"

**CONECTOR SOLDABLE**



CÓDIGO	MEDIDA
CS38F12	3/8" - FLARE 1/2"

**CONECTOR DE COBRE  
ROSCA EXTERIOR**



CÓDIGO	MEDIDA
CCRE13	13mm
CCRE19	19mm

**CONECTOR DE COBRE  
ROSCA INTERIOR**



CÓDIGO	MEDIDA
CCRI13	13mm
CCRI19	19mm

**COPE DE COBRE**



CÓDIGO	MEDIDA
CC12	1/2"
CC34	3/4"

**TEE DE COBRE**



CÓDIGO	MEDIDA
TC19	3/4"
TC13	1/2"

**TEE TERMINAL DE BRONCE**



CÓDIGO	MEDIDA
TT38	3/8"

**TEE UNION DE BRONCE**



CÓDIGO	MEDIDA
TU38	3/8"

**CONECTOR SOLDABLE**



CÓDIGO	MEDIDA
CS1238	3/8" - 1/2"

**NIPLE CAMPANA**



CÓDIGO	MEDIDA
NC3812	3/8" - 1/2"

**NIPLE TERMINAL**



CÓDIGO	MEDIDA
NT3838	3/8" - 3/8"

**NIPLE UNION**



CÓDIGO	MEDIDA
NU3838	3/8" - 38"

**NIPLE TERMINAL CON ESPIGA**



CÓDIGO	MEDIDA
NTE3838	3/8" - 38"

**TUERCA CONICA**



CÓDIGO	MEDIDA
TC12	1/2"
TC38C	3/8"

**TUERCA IZQUIERDA PIG TAIL**



CÓDIGO	MEDIDA
TIPT	1"

**TUERCA UNION SOLDABLE DE COBRE**



CÓDIGO	MEDIDA
TUC13	13mm

**PUNTA POOL**



CÓDIGO	MEDIDA
PPCE	3/8"

**BRAZO METALICO PARA REGADERA CON CHAPETON**



CÓDIGO	ANGULO	LARGO
BR90A	90 GRADOS	34cm

**COLADERA DE Fo. Fo.**



CÓDIGO	MEDIDA
CFF1515	15 X 15



# GRIFOS

MEZCLADORA DE 4" PARA LAVABO



MANERALES DE ACRILICO  
CÓDIGO: M4MA

MEZCLADORA MONOMANDO



INCLUYE: MANGUERAS PARA SU  
INSTALACION  
CÓDIGO: MMCL

MEZC.P\FREGADERO CROMO-BLANCO "8"



INCLUYE: MANGUERAS PARA SU  
INSTALACION

MANGUERA PARA GAS CON TUERCA DE LATON DE 3/8"

- FERULA DE LATON NIQUELADO



CÓDIGO	LONGITUD
XGF-06-060	60cm
XGF-06-100	1m.
XGF-06-150	1.5mts.
XGF-06-200	2mts
XGF-06-300	3mts.



# EMPAQUES



## EMPAQUE ESCAPE Y ADMICION

CÓDIGO	FEL-PRO	CÓDIGO	FEL-PRO	CÓDIGO	FEL-PRO	CÓDIGO	FEL-PRO	CÓDIGO	FEL-PRO
AMS1031	MS94118-1	AMS2480	MS92100	AMS1390	MS94125-1	AMS1273	MS95535	AMS4911	MS95968
AMS11030	MS95695	AMS4750	MS92121-3	AMS3462	MS94286	AMS3502	MS95536	AMS4932	MS95981
AMS3810	MA95787	AMS2360	MS92165	AMS7040	MS94370	AMS5390	MS95583	AMS2300	MS96042
AMS4851	MS90000	AMS3710	MS92211	AMS4640	MS94432	AMS1270	MS95612	AMS2460	MS96075
AMS3310	MS90131	AMS5370	MS92270-4	AMS1181	MS94602	AMS1391	MS95612-1	AMS4833	MS96124
AMS3191	MS90540	AMS3711	MS92467	AMS4270	MS94682	AMS11080	MS95660	AMS5410	MS96126
AMS3190	MS90543	AMS1360	MS92506	AMS4271	MS94764	AMS11052	MS95660-1	AMS2290	MS96148
AMS3170	MS90610	AMS4711	MS92568	AMS2701	MS94790	AMS11031	MS95674	AMS2280	MS96331
AMS4452	MS90728	AMS8500	MS92692	AMS4741	MS94801	AMS11051	MS95692	AMS1431	MS96447
AMS4455	MS90732	AMS3223	MS9275B	AMS5131	MS94803	AMS2222	MS95708	AMS5540	MS96454
AMS3251	MS90746	AMS2471	MS92846	AMS5031	MS94914	AMS2220	MS95709	AMS5480	MS96514
AMS4601	MS90779	AMS2702	MS93094	AMS4858	MS94951	AMS4511	MS957226	AMS5510	MS96536
AMS3151	MS90864	AMS2470	MS93219	AMS8131	MS94976	AMS4511	MS95726	AMS5511	MS96539
AMS4600	MS90890	AMS4070	MS93248	AMS4255	MS95372-1	AMS4743	MS95728-2	AMS2281	MS96632
AMS4590	MS90891	AMS3230	MS93317	AMS2611	MS95392	AMS3140	MS95751	AMS5460	MS96854
AMS3150	MS91022	AMS3250	MS93346	AMS2613	MS95392-1	AMS3593	MS95809-1	AMS3160	MS96859
AMS5342	MS91241	AMS3254	MS93346-1	AMS3180	MS95393	AMS3200	MS95817	AMS1430	N/A
AMS5500	MS91241-1	AMS2093	MS93795	AMS2372	MS95444	AMS3480	MS95839		
AMS2350	MS91473	AMS3181	MS93812	AMS2361	MS95446	AMS3201	MS95842		
AMS1300	MS91485	AMS4880	MS93837	AMS5190	MS95459	AMS4420	MS95918		
AMS1302	MS91553	AMS8550	MS93856	AMS2031	MS95470	AMS4253	MS95939		
AMS4403	MS92057	AMS8551	MS93909	AMS1271	MS95533	AMS4453	MS95960		

## JUEGO DE TAPAS DE PUNTERIA

CÓDIGO	FEL-PRO	CÓDIGO	FEL-PRO	CÓDIGO	FEL-PRO	CÓDIGO	FEL-PRO
ATC4710	TCS45869-2	AVC209S	VS50173R	AVC405	VS50364R	AVC833S	VS50440R
AVC905S	50528R-1	AVC517S	VS50251R-1	AVC114S	VS50365R	AVC454S	VS50441R
AVC302	AV50053R	AVC813S	VS50304R-1	AVC474S	VS50377R	AVC350S	VS50442R
AVC270	VS50022C-1	AVC318	VS50313R	AVC503S	VS50383R	AVC346S	VS50447R
AVC485	VS50029C	AVC700S	VS50323C	AVC427	VS50386C	AVC1105S	VS50455R
AVC353S	VS50080R	AVC808S	VS50324R-1	AVC261	VS50419R	AVC1104S	VS50457R
AVC323S	VS50088R	AVC230	VS50339R	AVC519S	VS50431R	AVC271S	VS50458R

CÓDIGO	FEL-PRO	CÓDIGO	FEL-PRO	CÓDIGO	FEL-PRO	CÓDIGO	FEL-PRO
AVC1108S	VS50459R	AVC139S	VS50493R	AVC546S	VS50550R-1	AVC143S	VS50606R
AVC222S	VS50461R	AVC134S	VS50498R/-1	AVC484S	VS50551R	AVC553	VS50617R
AVC314S	VS50469R	AVC251S	VS50513R	AVC461S	VS50553R	AVC551	VS50623R
AVC706S	VS50473R	AVC857S	VS50514R	AVC541S	VS50570R	AVC242S	VS50640R
AVC442	VS50476R	AVC247S	VS50518R	AVC439S	VS50574R	AVC243S	VS50651R
AVC319	VS50485R	AVC239S	VS50520R	AVC229	VS50575R	AVC316	VS50692R
AVC459S	VS50489R	AVC465S	VS50529R	AVC240S	VS50593R		

# EMPAQUE DE DONA



CÓDIGO	FEL-PRO	CÓDIGO	FEL-PRO
AEG1003	23626	AEG1013	60620
AEG1007	23591	AEG1010	60632
AEG1007	23591	AEG1011	60679
AEG1008	23624	AEG1030	60811
AEG1019	60458	AEG1027	60835
AEG1009	60531	AEG1024	60924

# EMPAQUE DEL CARTER INFERIOR

CÓDIGO	FEL-PRO	CÓDIGO	FEL-PRO	CÓDIGO	FEL-PRO
AOP1103	OS30673R	AOP114	OS30632R	AOP453B	OS30702R
AOP1108	OS30676R	AOP809	OS30639	AOP905	OS30708R
AOP813	OS30468C	AOP821	OS30642C	AOP441	OS30915R
AOP808	OS30510A	AOP519	OS30651C	AOP318	OS34300C
AOP802	OS30553C	AOP350	OS30668R	AOP271	OS34308R
AOP209	OS30570C	AOP451	OS30675R	AOP445	OS34309R
AOP517	OS30591	AOP320	OS30680R	AOP261	OS34408R
AOP512	OS30617C	AOP460	OS30687R	AOP502	OS34410R
AOP502	OS30619C	AOP534	OS30688	AOP323	OS34500R
AOP425	OS30620R	AOP235	OS30689R	AOP325	OS34502R
AOP230	OS30622R	AOP130A	OS30690R	AOP485D	OS34508R
AOP453	OS30625R	AOP130	OS30691R		
AOP118	OS30630R	AOP371	OS30693R		
AOP405	OS30631R	AOP534A	OS30696		



## EMPAQUE DE TIEMPO



CÓDIGO	FEL-PRO	CÓDIGO	FEL-PRO	CÓDIGO	FEL-PRO
ATC3480	TCS45972	ATC3150	TCS45828	ATC3460	TCS45958
ATC5340	TCS45997	ATC3530	TCS45840	ATC3460	TCS45958
ATC3221	TCS45121	ATC5020	TCS45864	ATC11030	TCS45961
ATC9000	TCS45357	ATC4270	TCS45867	ATC11031	TCS45962
ATC2000	TCS45483	ATC2300	TCS45893-1	ATC4330	TCS45963
ATC8010	TCS45592	ATC1140	TCS45898	ATC3590	TCS45971
ATC8130	TCS45641	ATC1141	TCS45899	ATC4541	TCS45984
ATC2090	TCS45750	ATC5070	TCS45903	ATC4600	TCS45986
ATC4250	TCS45771	ATC4540	TCS45951	ATC2561	TCS45996
ATC3180	TCS45793	ATC2560	TCS45952	ATC5480	TCS46063

## EMPAQUE DE CABEZA

CÓDIGO	FEL-PRO	CÓDIGO	FEL-PRO	CÓDIGO	FEL-PRO	CÓDIGO	FEL-PRO	CÓDIGO	FEL-PRO
AHG139	26155PT	AHG306	8215PT	AHG440	9309PT-2	AHG230R	9673PT-1	AHG519	9942PT
AHG855	26158PT/-1	AHG485	8548PT-2	AHG320	9354PT-1	AHG230L	9676PT-1	AHG519	9942PT
AHG532	26171PT	AHG433	9005PT/-1	AHG850	9465PT	AHG703	9683PT-1	AHG834	9955PT
AHG907	26182PT	AHG349	9059PT	AHG852	9468PT	AHG470R	9790PT-2	AHG350	9957PT
AHG229	26195PT	AHG366	9071PT	AHG337	9469PT	AHG470L	9792PT-2	AHG127	9958PT-1
AHG140	26196PT	AHG270	9076PT-1	AHG857	9494PT	AHG503	9819PT	AHG347	9968PT
AHG272	26206PT	AHG209	9112PT	AHG257	9537PT	AHG447	9885PT	AHG346	9971PT
AHG537	26219PT	AHG348	9115PT	AHG464	9539PT	AHG260	9898PT	AHG251L	9978PT
AHG143	26236PT	AHG318	9170PT-1	AHG482L	9540PT	AHG425L	9902PT	AHG251R	9981PT
AHG548	26255PT	AHG313	9174PT	AHG482R	9541PT	AHG425R	9903PT	AMS3254	MS93346-1
AHG551	26261PT	AHG134	9274PT	AHG517	9571PT	AHG256	9910PT		
AHG316	26317PT	AHG371	9292PT	AHG833	9604PT	AHG130	9915PT		
AHG322	7733PT-2	AHG460L	9293PT	AHG700	9623PT	AHG359L	9917PT		
AHG808	8188PT	AHG460R	9294PT	AHG704	9651PT	AHG359R	9918PT		



## EMPAQUE DE RETEN CIGUEÑAL

CÓDIGO	FEL-PRO	CÓDIGO	FEL-PRO	CÓDIGO	FEL-PRO
ABS100	BS40430	ABS320	BS40656	ABS500	BS40384
ABS1103	BS40182	ABS323	BS40520	ABS502	BS40628
ABS209	BS40660	ABS371	BS40640	ABS503	BS40609
ABS256	BS40181	ABS403	BS40634	ABS801	BS40409
ABS270	BS40612	ABS427	BS40419	AMS2220	MS95709
ABS315	BS40615	ABS445	BS40619		

# FEDERAL



CÓDIGO	CÓDIGO	CÓDIGO	CÓDIGO	CÓDIGO	CÓDIGO	CÓDIGO	CÓDIGO	CÓDIGO	CÓDIGO
13-2307	13-2873	13-2992	13-3203	13-3318	13-3350	13-4572	13-4688	13-4748	13-6399
13-2416	13-2874	13-3111	13-3204	13-3323	13-3352	13-4576	13-4689	13-4768	13-6451
13-2417	13-2917	13-3115	13-3205	13-3324	13-3353	13-4577	13-4692	13-4776	13-6503
13-2418	13-2929	13-3117	13-3207	13-3326	13-3354	13-4588	13-4693	13-4883	13-8081
13-2423	13-2946	13-3133	13-3210	13-3327	13-3355	13-4654	13-4696	13-4884	13-8084
13-2602	13-2951	13-3137	13-3213	13-3329	13-4395	13-4656	13-4697	13-6069	13-8085
13-2608	13-2959	13-3145	13-3216	13-3333	13-4475	13-4658	13-4714	13-6072	13-8086
13-2616	13-2962	13-3146	13-3304	13-3335	13-4512	13-4674	13-4716	13-6075	13-2419
13-2619	13-2965	13-3154	13-3309	13-3336	13-4530	13-4675	13-4717	13-6076	13-2613
13-2620	13-2968	13-3156	13-3310	13-3337	13-4564	13-4676	13-4718	13-6078	13-2615
13-2623	13-2969	13-3161	13-3312	13-3340	13-4565	13-4677	13-4743	13-6317	13-2621
13-2624	13-2970	13-3162	13-3313	13-3343	13-4567	13-4680	13-4744	13-6319	13-2912
13-2625	13-2983	13-3163	13-3317	13-3349	13-4569	13-4687	13-4745	13-6325	13-2923

13-2930	13-3124	13-3160	13-4340	13-4679
13-2939	13-3131	13-3311	13-4360	13-4722
13-2950	13-3138	13-3319	13-4520	13-3357
13-3102	13-3143	13-3325	13-4539	13-3307
13-3109	13-3147	13-3339	13-4551	
13-3118	13-3151	13-3346	13-4605	
13-3119	13-3155	13-4330	13-4609	



**CAUTIN  
TIPO PISTOLA**

**CÓDIGO: 41189**



**CAUTIN TIPO LAPIZ  
DE 60 WATTS**

<b>CÓDIGO</b>
41186
CHIS250L

**SOLDADURA  
PARA CAUTÍN**



**ROLLO CON 25grs.**

**CÓDIGO: SLW-19**



**ALAMBRE GALVANIZADO**

ROLLOS DE ALAMBRE GALVANIZADO PARA USOS GENERALES, DOS ROLLOS  
ROLLO DE 100 PIES 20GA  
ROLLO DE 50 PIES 18GA

**CÓDIGO: CZGW**

**SOLDADURA PARA CAUTIN**



**CÓDIGO: 41180**

**CHISPA PARA PLOMERO**



**CÓDIGO: 57950**

**BOQUILLA PLOMERO**



**CÓDIGO: TAIT-8912**

**QUEMADOR ANTORCHA**



2400F°  
1300C°

SOLO CILINDRO (8 oz)

**CÓDIGO: TAIT-8026**

**COMPRESOR DE MUELLES  
HELICOIDALES**



**CODIGO**

TAIC0177



## REMACHADORA DE MANO.



CON 60 REMACHES  
DE CLAVO EN 4  
MEDIDAS  
DIFERENTES

**CÓDIGO: 41159**

## REMACHES JUEGO CON 100 PZS.



.MEDIDAS DE REMACHES:  
20 DE 1/8" x 7/32", 30 DE  
1/8" x 5/16",  
30 DE 5/32" x 7/32" Y 20  
DE 3/16" x 5/16"

**CÓDIGO: 0375**

## REMACHES KIT CON 1000 PZS.



.MEDIDAS DE REMACHES:  
1/8" X1/4", 1/8"X5/16"  
1/8"X3/8", 1/8"X5/8"

**CÓDIGO: 70011**

## REMACHADORA DOBLE MANO



REMACHES:  
3/32", 1/8"  
5/32", 3/16"

**CÓDIGO: TAIR0373**

## SEGUETA CALADORA



JUEGO CON 8 PZS.



JUEGO CON 5 PZS

## ACEITERA CON MANGUERA FLEXIBLE



CÓDIGO	MEDIDA
4230	300ml
4232	500ml

## GRASERAS P/ CRUETA CARDAN,



SET C/ 110PZS.  
CÓDIGO: 41101

## SEGUETA CALADORA

## ENGRAPADORA PARA TRABAJO PESADO WHITE DOG



CÓDIGO	MEDIDA
97835	DE 5-8
97836	DE 6
97837	DE 8-12
97838	DE 18



CÓDIGO: CHIST384

## GRAPAS ARROW USA PAQUETE C/ 1250 PZS.

## CHAVETAS



CÓDIGO	MEDIDA
T501/2	DE 1/2"
T505/16	DE 5/16"
T503/8	DE 3/8"
T50 1/4	DE 1/4"
T509/16	DE 9/16"



JUEGO CON 555PZ.S

- 150pc 1/16" x 1" • 150pc 3/32" x 1" • 150pc 3/32" x 1-1/2"
- 75pc 1/8" x 1-1/4" • 50pc 1/8" x 2" • 30pc 5/32" x 2-1/2"

CÓDIGO: 41095





TRAMPA PARA RATON

**TRAMPA CHICA CON CEBO 2 PZS**



**CÓDIGO:  
VIC150**

**TRAMPA PARA RATON DE GOMA**

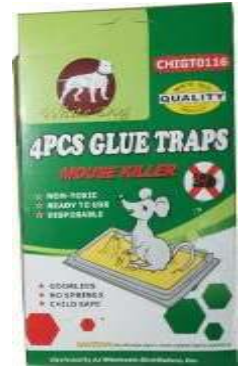

**CONTIENE 4 PZS.**

**FACIL DE USAR, NO TOXICO,  
LIBRE DE OLORES Y MAS.**

**CÓDIGO: A1011**

**TRAMPA CHICA SIN CEBO 2 PZS**



**CÓDIGO:  
VIC040**



**TRAMPA PARA RATON GRANDE SIN BLISTER**



**CÓDIGO:  
VIC200**



## PLASTI LOKA

### PLASTILINA EPOXICA FUERTE COMO EL ACERO

MUY FACIL DE APLICAR; DESPUES DE ENDURACIDO LO PUEDE LIMAR, LIJA, TALADRAR, TORNEAR Y/O INDISPENSABLE EN EL HOGAR, LA OFICINA, EL TALLER, LA INDUSTRIA Y EN CUALQUIER LUGAR DONDE TENGA ALGO QUE REPARAR.

### PLASTI LOKA REPARA PRACTICAMENTE CUALQUIER MATERIAL



PLASTI LOKA SUPER RAPIDA  
ENDUCERE EN 7min. **CON 20g.**  
**ENDURECE AUN BAJO EL AGUA**

#### APLICACIONES:

- \* REPARA
- \* RESANA
- \* TAPA
- \* RELLENA
- \* UNE
- \* AISLA
- \* MOLDEA
- \* RESTAURA
- \* FIJA
- \* SELLA
- \* PARCHA
- \* Y MUCHO MAS.

**CÓDIGO: 1206**

#### APLICACIONES:

- \* REPARA
- \* RESANA
- \* TAPA
- \* RELLENA
- \* MOLDEA
- \* RESTAURA
- \* FIJA
- \* SELLA



**CON 20g.**  
**CÓDIGO: 1207**



**CON 40g.**  
**CÓDIGO: 1208**

## KOLA LOKA

### PEGA INSTANTANEO.

PARA USARSE. PEGA AL INSTANTE OBJETOS SÓLIDOS EXCEPTO ACERO INOXIDABLE, POLIETILENO, TEFLÓN O MATERIALES QUE CONTENGAN FLUORURO DE CARBONO.

**KOLA LOKA**  
PEGA EN SEGUNDOS.  
**CONT. NET. 2g**

- PEGA:
- \* PLASTICOS
  - \* METALES
  - \* HULES
  - \* CERAMICA
  - \* PONCELANA
  - \* UÑAS
  - \* CRISTALES
  - \* Y MUCHO MAS.



**CÓDIGO: 10003**

**KOLA LOKA BROCHA**  
PEGA EN 30 SEGUNDOS.  
**CONT. NET. 3.5g**

- PEGA:
- \* PLASTICOS
  - \* METALES
  - \* HULES
  - \* CERAMICA
  - \* PONCELANA
  - \* UÑAS
  - \* CRISTALES
  - \* Y MUCHO MAS.



**CÓDIGO: 14322**

**KOLA LOKA GOTERITO**  
PEGA EN 30 SEGUNDOS.  
**CONT. NET. 5g**

- PEGA:
- \* PLASTICOS
  - \* METALES
  - \* HULES
  - \* CERAMICA
  - \* PONCELANA
  - \* UÑAS
  - \* CRISTALES
  - \* Y MUCHO MAS.



**CÓDIGO: 614056**

# MARCADORES



**TEMPERATURA  
CODIGO: 27322**

## MARCADOR TRIPLE MINI



**INCLUYE CONEXIONES  
CODIGO: MTM**

## MARCADOR TRIPLE UNIVERSAL



**INCLUYE CONEXIONES  
CODIGO: MTG**

# TACOMETRO

## MARCADOR INDIGLOW TACOMETRO



**TAMAÑO: 5" LUZ ELECTRICA SHIFT  
CODIGO: MTG**

### TUERCA PARA RING



CÓDIGO	MEDIDA
P-8202	7/16 - 20
P-8204	½ - 20
P-8206	12mm X 1.25
P-8207	12mm X 1.50

### TUERCA PARA RING CROMADO



CÓDIGO	MEDIDA
P-1202	7/16 - 20
P-1203	12mm X 1.75
P-1204	½ - 20
P-1206	12mm X 1.25
P-1207	12mm X 1.50
P-1405	14 mm X 1.50

### TUERCA CONVENCIONAL



CÓDIGO	MEDIDA
5440	½ - 20
5442	7/16 - 20
5441	14X1.50
5443	9/16 - 18
5445	12mm X 1.50
5447	12mm X 1.25

### CANDADO CROMADO PARA RING CON 6 ESTRIAS



CÓDIGO	MEDIDA
6805	12 MM X 1.25
6806	12 MM X 1.50
6803	½ - 20

### ARANDELAS



PARA TUERCA DE RING.  
PAQUETE CON 50 PIEZAS  
CÓDIGO: 772

### CONEXIONES MANGUERA DE BRONCE



PARA  
MARCADOR DE  
ACEITE

CÓDIGO: KMA

### LLAVE DE 6 ESTRIAS



CÓDIGO: 6864

## CONEXIÓN PARA BULBO DE TEMPERATURA



PARA CHEVROLET

CÓDIGO: 06579



PARA CHRYSLER

CÓDIGO: 06580



PARA FORD

CÓDIGO: 06581



PARA AUTO EUROPEO

CÓDIGO: 06582



The logo features a thick red horizontal bar with a central downward-pointing triangular notch. Below this bar, the word "DORMAN" is written in a bold, black, sans-serif font. The letters are closely spaced, and the 'D' and 'N' have horizontal wings extending outwards. A registered trademark symbol (®) is located at the end of the word.

**DORMAN**®



## BIRLO PARA RUEDA CON 10pz



CÓDIGO	CÓDIGO	CÓDIGO	CÓDIGO	CÓDIGO	CÓDIGO	CÓDIGO	CÓDIGO
610-103	610-234	610-275	610-312	610-338	610-379	610-414	610-452
610-138	610-236	610-276	610-317	610-340	610-380	610-416	610-455
610-148	610-240	610-277	610-318	610-342	610-381	610-424	610-462
610-159	610-244	610-281	610-320	610-344	610-382	610-426	610-471
610-174	610-246	610-285	610-325	610-345	610-383	610-427	610-474
610-181	610-250	610-286	610-326	610-346	610-384	610-428	610-475
610-182	610-253	610-287	610-327	610-360	610-389	610-434	610-480
610-186	610-254	610-290	610-328	610-362	610-390	610-435	610-482
610-189	610-256	610-295	610-329	610-364	610-391	610-436	610-485
610-194	610-260	610-300	610-330	610-365	610-393	610-440	610-486
610-199	610-261	610-302	610-331	610-366	610-395	610-442	610-376
610-210	610-262	610-303	610-334	610-368	610-403	610-486	
610-217	610-266	610-305	610-336	610-369	610-404	610-477	
610-218	610-269	610-308	610-337	610-378	610-410	610-449	

## UNION DE COMPRESION CAJA CON 10pz



MEDIDA	
490-023	1/4 "
490-022	3/16 "
	3/8 "



## TUERCA PARA RIN CON 10pz

CÓDIGO	T/ROSCA	T/HEXAGONAL	L/TOTAL
611-178	1/2"-20	13/16"	1-1/8"
611-199	1/2"-20	3/4"	1-1/4"
611-117	M12-1.5	21mm	37mm
611-210	M12-1.25	21mm	29mm
611-113	M12-1.5	19mm	32,5mm

## SURTIDO DE TAPAS DE DERIVACION



## T DE VACIO



CÓDIGO	02252	02253	02254	02255	02256
MEDIDAS	5/8"	Multi	3/4"	1/2"	3/8"

CÓDIGO	MEDIDAS	NOTA
47001	1/8"-3/8"	UNIVERSAL



## "T" PARA CONDUCTO CALEFACTOR

CÓDIGO	MEDIDAS	NOTA
47114	1/4"	
47116	1/2"	
47117	5/8"	UNIVERSAL
47118	3/4"	UNIVERSAL



## "T" PARA CONDUCTO CALEFACTOR

CÓDIGO	MEDIDAS
47151	1/2"
47152	5/8"



## CODOS PARA MANGUERA DE CALEFACCIÓN

CÓDIGO	MEDIDAS	NOTA
47058	1/4"	
47060	3/8"	
47061	1/2"	
47062	5/8"	UNIVERSAL
47063	3/4"	UNIVERSAL



## ACOPLES PARA MANGERA DE CALEFACCIÓN

CÓDIGO	TIPO	AÑO
47065	GM	95-2007/3.8

CÓDIGO	TIPO	NOTA
47056	JEEP	Codo para válvula PVC







**CONECTOR  
PARA**



CÓDIGO	MEDIDAS	NOTA
47080	5/8 X 3/4"	
47081	1/2" X 5/8"	
47082	1/2" X 3/8"	
47090	1/4"	
47091	3/8"	
47093	1/2" X 1/2"	UNIVERSAL
47094	5/8"	



**ADAPTADOR DE  
MANGUERA DE CALEFACCIÓN**

CÓDIGO	TIPO	NOTA
56356	ADAPTADOR	PARA CALEFACCIÓN



**DIAGFRAGMA  
PARA POMPA  
DEL  
ACELERADOR**



**CONECTOR PARA  
SISTEMA DE  
ENFRIAMIENTO**

CÓDIGO	90082	90084	90087
MODELO	AMC, FORD, JEEP	FORD	CHRYSLER, FORD, GMC, JEEP

CÓDIGO	MEDIDAS
800-404	CONECTOR P SIST, DE ENFRIAMIENTO
800-403	CONECTOR P SIST, DE ENFRIAMIENTO

**VARILLA MEDIDORA DE ACEITE  
UNIVERSAL**

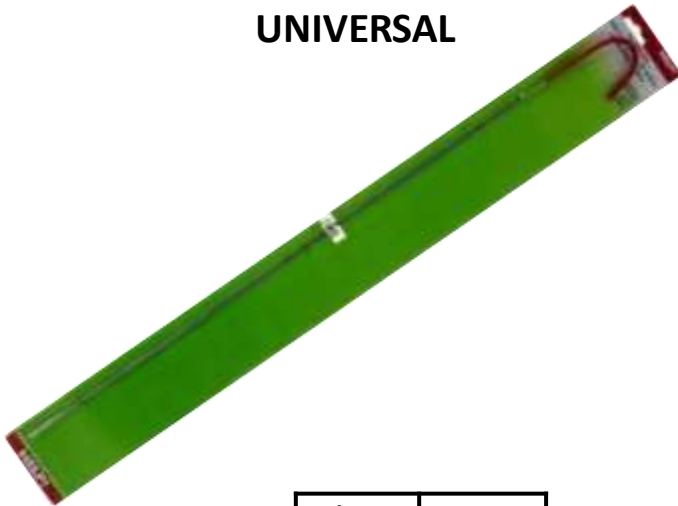

CÓDIGO	MEDIDAS
65116	23-7/8"

**JUEGO DE TORNILLOS PARA  
AMORTIGUADOR  
UNIVERSAL**



CÓDIGO	MEDIDAS	AÑO \ MODELO	TIPO
31001	1/2-21	Ford 2010-90, Mazda 1997-91	UNIVERSAL



## GUIA PARA EMBRAGUE

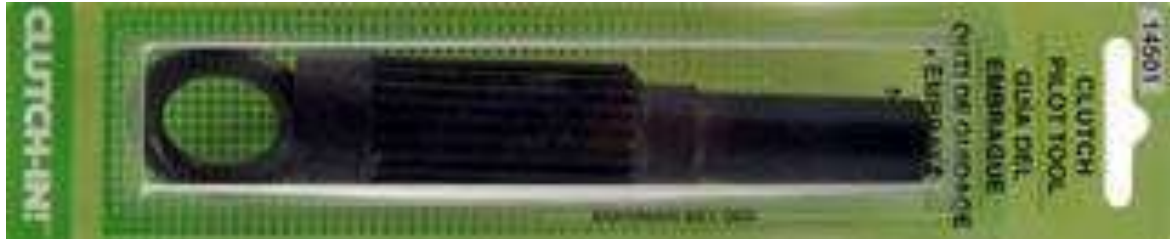

CÓDIGO	14501	14503	14504	14505	14507	14519	14522	14523
MODELO	NISSAN	CHRYSLER FORD MITSUBISHI	AMC GN HONDA IZUZU OPEL	FORD MAZDA	TOYOTA	FORD	GN JEEP MERCEDES VOLVO	GM



### BROCHES DE NAILON PARA TAPIZADO UNIVERSAL

CÓDIGO
45319



### BOTONES TAPONADORES DE PLASTICO

CÓDIGO
02411



### TERMINALES PARA CABLE

CÓDIGO
03336



## PURGADOR DE FRENOS

CÓDIGO	MEDIDAS
12702	M10-1.5 x 33 mm
12707	7/16 in - 20 x 1-1/4 in
12709	M10-1.0 x 35 mm



## SURTIDO DE TORNILLOS PARA PURGADORES DE FRENOS

CÓDIGO	MEDIDAS	COMENTARIO
13949	1/4"-28 x 15/16", 5/16"-24 x 1", 3/8"-24 x 1-1/4", M10-1.0 x 35mm, M10-1.5 x 30mm	INCLUYE 2 DE CADA UNO



## JUEGO DE REPARACION DE DESBORDAMIENTO DE TUBO DEL RADIADOR

CÓDIGO	MEDIDAS
10691	UNIVERSAL





## JUEGO DE REPARACION DE DESBORDAMIENTO DE TUBO DEL RADIADOR



CÓDIGO	MEDIDAS	NOTA
<b>02365</b>	1/8", 3/8", 1/2", 5/8" I.D. and 2 Each 3/16", 1/4", 5/16"	<b>UNIVERSAL</b>

## TAPA DEL REFRIGERANTE

CÓDIGO	NOTA
<b>82599</b>	<b>Infiniti 2001-90, Nissan 2012-86</b>



## SIJETADORES PARA CABLES DE BUJIAS

CÓDIGO	MEDIDA
<b>40282</b>	<b>UNIVERSAL</b>



## JUEGO DE ENGRANAJE DEL REGULADOR DE VENTANA

CÓDIGO	AÑO\MODELO
<b>74409</b>	<b>Ford 2011-89, Lincoln 2011-90, Mazda 1994-91, Mercury 2006-92, Mercury 1989</b>



### SUJETADOR PARA FOCO DE FARO

CÓDIGO	MODELO	AÑO
42415	CHRYSLER & FORD	84-2007

### SURTIDOS DE RETENES PARA FOCO DE FARO DELANTERO

CÓDIGO	MODELO	AÑO
42420	GM	86-2005



### TAPA ANTIPOLVO



### TAPA ANTIPOLVO



CÓDIGO	MODELO	AÑO
13974	FORD	68-2003

CÓDIGO	MODELO	AÑO
13977	GM	69-2002



**LINEADOR P\ MOTOR DE ARRANQUE**



CÓDIGO	MODELO	MEDIDAS
02350H	GM	1/64, 3/64, 1

**JUEGO DE DISCOS DE ACOPLAMIENTO DE DIRECCION**



CÓDIGO	MODELO
31000	Ford 1989-80, Lincoln 1989-80, Mercury 1989-80 –GM

**MANIJA PARA PUERTA EXTERIOR**



CÓDIGO	MODELO	MEDIDAS	TIPO
77192	CHEVROLET/GMC	92-2005	DERECHA
77193	GM	92-2005	IZQUIERDA

**JUEGO DE CUBIERTA DE PIÑON Y CORONA DE DIRECCION**



CÓDIGO
614-020

**WIPER DOBLE COMPLETO  
ESTILO METALICO  
PAQUETE CON 1 PZS**



CÓDIGO	MEDIDA
W -18GM	18"
WBP-22GM	22"

**WIPER COMPLETO DE  
METAL  
PAQUETE CON 1 PZS**



CÓDIGO	MEDIDA
WB-018C	18"
WB-020C	20"
WB-022C	22"

**WIPER DOBLE COMPLETO  
PAQUETE CON 2PZS**



CÓDIGO	MEDIDA
WD-16B	16" BLANCO
WD-16ORO	16" CROMO ORO





CROMOORO.  
LIZO  
CÓDIGO: 50116



CROMO ESTÁNDAR  
LIZO  
CÓDIGO: LP-101

PORTA PLACAS CROMADO C/DIANMANETES  
DELGADAS 1PZS



CONTIENE 4 TORNILLOS PARA COLOCARLO  
CÓDIGO: 0190

BASE PARA PLACAS  
AJUSTE UNIVERSAL  
CON 2 TORNILLOS



CÓDIGO: 79050

BASE PARA PLACAS  
AJUSTE UNIVERSAL  
CON 4 TORNILLOS



CÓDIGO: 79150

MICA PORTA PLACA SMOCK



CÓDIGO: 90490

TORNILLO DE NYLON  
CON TUERCA PARA PLACAS



PAQUETE CON 8 PZS.  
MEDIDA: 6 x 20mm

- 4 TUERCAS
- 4 TORNILLOS

CÓDIGO: 80150



TORNILLO DE ACERO  
CON TUERCA PARA PLACAS

PAQUETE CON 8 PZS.  
MEDIDA: 6 x 20mm

- 4 TUERCAS
- 4 TORNILLOS

CÓDIGO: 80330

TORNILLO DE ACERO  
CON TUERCA PARA PLACAS



PAQUETE CON 9 PZS.  
MEDIDA: 6 x 20mm

- 4 TUERCAS
- 4 TORNILLOS
- 1 LLAVE ESTRELLA

CÓDIGO: 81300

TORNILLO DE ACERO CON TUERCA PARA  
PLACAS

PAQUETE CON 13PZS.  
MEDIDA: 6.35 x 19.05mm

- 4 TUERCAS
- 4 TORNILLOS
- 2 EMPAQUES
- 2 RONDANAS
- 1 LLAVE ESTRELLA

CÓDIGO: 81420



# EXTENSIONES PARA RATCH



		MEDIDAS
94685	1/4	3", 6", 9" Y 12"
50275	3/8	3", 5", 8" Y 10"
		3", 5", 6" Y 10"
		8", 10" Y 12"



CÓDIGO	ENTRADA	PIEZAS
BSPEBW33P	3/8	3 PCS
TAIB0460	3/8	3 PCS

## REDUCTOR PARA RATCH C/2PZS



1/4" DR. X 6" Y 3/8" DR. X 8"  
 TERMINACIONES DE CROMO DE VANADIO EN ACERO. FLEXIBLE Y RESISTENTE MANGUERA CON RUBULANTE.

**CODIGO**  
 50270



PAQUETE CON 2 PZS. DE 1/2 A 3/8 Y DE 3/8 A 1/4

**CODIGO**  
 50220

## ADAPTADORES PARA RATCH



**JUEGO CON 3 PZS.**  
 EN MEDIDAS DE:

- 3/8" MACHO A 1/4" HEMBRA
- 1/2" MACHO A 3/8" HEMBRA
- 3/4" MACHO A 1/2" HEMBRA



**CODIGO**  
 50222

## ADAPTADOR UNIVERSAL PARA RATCH



DE 3/8"

**CODIGO**  
 10773



**CON 3 PZS.**  
 EN MEDIDAS DE: 1/4", 3/8" Y 1/2"

**CODIGO**  
 50228

## EXTENSIONES PARA RATCH



CON BOTON PARA  
EXPULSAR DADOS.

CÓDIGO	DESCRIPCION
50286	DE 1/2" C/ 72 DIENTES
50288	DE 3/8" C/ 72 DIENTES

## RATCH CROMADO 'ECONOMICO'



CÓDIGO	MEDIDA
1249	DE 1/2"
1250	DE 3/8"
1251	DE 1/4"

## RATCH DOBLE CROMADO



DE 1/2"  
CON 72  
DIENTES

CÓDIGO	DESCRIPCION
RH3812L	LARGO DE 10in (26cm)

## RATCH DOBLE CROMADO



DE 3/8"  
CON 72  
DIENTES

CÓDIGO	DESCRIPCION
10898	CORTO DE 5in (13cm)

## TUNE UP KIT



INCLUYE:  
EXTENSION RATCH Y  
2 DATOS PARA BUJIA.

CÓDIGO

W-1131

## FALANCAS CROMADAS



DE 1/2"

CÓDIGO	LARGO
10790	DE 15"
1066	DE 18"
TAIB0463	DE 25"

## LLAVE TIPO RACHET COMBO FLEX



CÓDIGO	DESCRIPCION
10969	LLAVE DE 8 mm
10955	LLAVE DE 10 mm
10958	LLAVE DE 13 mm
31096	LLAVE DE 1/2
31097	LLAVE DE 9/10

## JUEGO DE DADOS



### JUEGO CON 40PIEZAS

CONTIENE:

1PZA- 3/8" Dr 8" Ratchet Handle, 1PZA- 1PZA- 3/8" Dr 3" Extensión Bar, 1PZA- 3/8" Dr 5/8" Spark Plug Socket, 1PZA- 3/8" Dr Spin Disc, 1PZA- 1/4" Dr. 6" Spinner Handle, 1PZA- 1/4" (M) x 3/8" (F) Adapter, 3PZAS- 8 PT 1/4" Dr Sk (SAE) : 1/4", 5/16", 3/8", 3PZAS- 3/8" Dr (MM): 12, 14, 15mm 12PZAS- 1/4" Dr Sk (SAE): 5/32", 3/16", 7/32, 1/2", 9/32", 5/16", 11/32", 3/8", 13/32", 7/16", 15/32", 1/2", 12PZAS- 1/4" Dr Sk (MM): 4, 4.5, 5, 5.5, 6.7, 8, 9, 10, 11, 12, 13mm 1PZA. Blow Case.

**CÓDIGO: 50062**



### JUEGO CON 52 PIEZAS

CONTIENE:

1PZA- 3/8" Dr 8" Ratchet Handle, 1PZA- 1PZA- 3/8" Dr 3" Extensión Bar, 1PZA- 3/8" Dr 5/8" Spark Plug Socket, 1PZA- 3/8" Dr Spin Disc, 1PZA- 1/4" Dr. 6" Spinner Handle, 1PZA- 1/4" (M) x 3/8" (F) Adapter, 3PZAS- 8 PT 1/4" Dr Sk (SAE) : 1/4", 5/16", 3/8", 3PZAS- 3/8" Dr (MM): 12, 14, 15mm 12PZAS- 1/4" Dr Sk (SAE): 5/32", 3/16", 7/32, 1/2", 9/32", 5/16", 11/32", 3/8", 13/32", 7/16", 15/32", 1/2", 12PZAS- 1/4" Dr Sk (MM): 4, 4.5, 5, 5.5, 6.7, 8, 9, 10, 11, 12, 13mm 1PZA. Blow Case.

**CÓDIGO: 10852**





**TORQUIMETRO**



**FLECHA DE 1/2"**  
**CÓDIGO: 4274**



**RATCH DE 1/2"**  
**CÓDIGO: 4254**

**DADOS METRICOS JUEGO CON 22PZS**



- DADOS CORTOS DE:**
- 9, 10, 11, 12, 13, 14, 15, 17 Y 19mm.
- DADOS LARGOS DE:**
- 9, 10, 11, 12, 13, 14, 15, 17 Y 19mm.
- EXTENSION PARA RATCH DE:**
- 1-3/4" & 3" RATCH Y ESTUCHE
- CÓDIGO: 07-847**

**DADOS CON ESTUCHE JUEGO DE 12 PZS**



<b>50154</b>	1/2 A STD	3/8", 7/16", 1/2", 9/16", 5/8", 11/16", 3/4", 13/16", 7/8", 15/16" Y 1"
<b>50156</b>	1/2 A MM	10, 11, 12, 13, 14, 16, 17, 19, 21, 22 Y 24mm



**DADO PARA BUJIAS.**



**CÓDIGO**  
**SKSP3858**

**DADO DE IMPACTO ENTRADA DE 1/2 PARA SERVICIO PESADO EN BLISTER**



CÓDIGO	MEDIDA
<b>71738</b>	<b>30"</b>
<b>71176</b>	<b>32"</b>
<b>71740</b>	<b>34"</b>
<b>71736</b>	<b>36"</b>
<b>71737</b>	<b>38"</b>

**DADO DE IMPACTO**



CÓDIGO	DESCRIPCION
<b>10951</b>	<b>DE 1/2 x 10mm</b>
<b>10955</b>	<b>DE 1/2 x 15mm</b>
<b>10958</b>	<b>DE 1/2 x 18mm</b>
<b>31096</b>	<b>DE 1/2 x 9/16mm</b>
<b>31097</b>	<b>DE 1/2 x 1/2</b>

**DADOS TIPO ALLEN C/ 12 PZS**

**A ESTANDAR**



**A MILIMÉTRICOS**



DE	DADOS
3/8 A STD	3/8, 1/8, 5/32, 3/16, 7/32, 1/4, 5/16.
1/2 A STD	1/2", 9/16" Y 3/8

DE	DADOS
3/8 A MM	3, 4, 5, 5.5, 6, 8 Y 10mm
1/2 A MM	12, 14 Y 17mm

**CÓDIGO: 10917**

**CÓDIGO: 10915**

**PUNTAS COMBINADAS ALLEN Y TORXS C\8pz**



DE	DADOS
TAIB0729	1/4, 5/16, 3/8, (8MM) SD-40, SD-45, SD-50, SD-60

**DADO TORX JUEGO**



HEMERA:	E6	E7	E8	E10
	E12	E14	E16	
MACHO:	T10	T15	T20	T25
	T30	T40	T45	T50

**CÓDIGO : 21841**



**DADO DE 6 PUNTAS CON ENTRADA**



CÓDIGO	MEDIDA
BF23208	DE 3/8" A 5/16"
BF23209	DE 3/8" A 3/8"
BF23210	DE 3/8" A 7/16"
BF23213	DE 3/8" A 1/2"
BF23214	DE 3/8" A 9/16"
BF23216	DE 3/8" A 5/8"
BF23217	DE 3/8" A 11/16"
BF23219	DE 3/8" A 3/4"
BF23220	DE 3/8" A 13/16"

CÓDIGO	MEDIDA
BF23607	DE 3/8" A 7mm
BF23608	DE 3/8" A 8mm
BF23609	DE 3/8" A 9mm
BF23610	DE 3/8" A 10mm
BF23611	DE 3/8" A 11mm
BF23612	DE 3/8" A 12mm
BF23613	DE 3/8" A 13mm
BF23614	DE 3/8" A 14mm
BF23615	DE 3/8" A 15mm
BF23616	DE 3/8" A 16mm
BF23617	DE 3/8" A 17mm
BF23618	DE 3/8" A 18mm
BF23619	DE 3/8" A 19mm

CÓDIGO	MEDIDA
BF25209	DE 1/2" A 3/8"
BF25210	DE 1/2" A 7/16"
BF25213	DE 1/2" A 1/2"
BF25214	DE 1/2" A 9/16"
BF25216	DE 1/2" A 5/8"
BF25217	DE 1/2" A 11/16"
BF25219	DE 1/2" A 3/4"
BF25221	DE 1/2" A 13/16"
BF25222	DE 1/2" A 7/8"
BF25224	DE 1/2" A 15/16"
BF25225	DE 1/2" A 1"
BF25229	DE 1/2" A 1 1/8"

CÓDIGO	MEDIDA
BF25610	DE 1/2" A 10mm
BF25611	DE 1/2" A 11mm
BF25612	DE 1/2" A 12mm
BF25613	DE 1/2" A 13mm
BF25614	DE 1/2" A 14mm
BF25615	DE 1/2" A 15mm
BF25616	DE 1/2" A 16mm
BF25617	DE 1/2" A 17mm
BF25618	DE 1/2" A 18mm
BF25619	DE 1/2" A 19mm
BF25620	DE 1/2" A 20mm
BF25621	DE 1/2" A 21mm
BF25622	DE 1/2" A 22mm
BF25624	DE 1/2" A 24mm

**PUNTAS ESTRELA JUEGO CON 11 pzs. MEDIDAS T-8 A T-55**

**CÓDIGO TAIB0731**

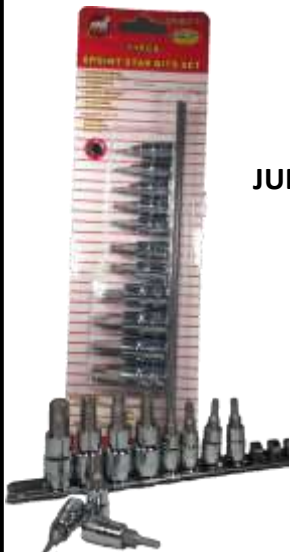

**LLAVES HEXAGONALES**

CON MANGO DE VINIL, DE 6" DE LARGO EN MEDIDAS: 3/32", 7/64", 1/8", 9/64", 5/32", 3/16", 7/32" Y 1/4"

**CÓDIGO: TAIH0581**



## AJUSTADOR DE FRENS



CÓDIGO	MEDIDA
W-179	8 1/2"

## LLAVE COMBINADAS JUEGO CON 9 PZS



CÓDIGO	DESCRIPCION	
CHIWS109S	1/4, 5/16, 3/8, 7/16, 1/2, 9/16, 5/8, 11/16, 3/4	STD

## LLAVES ALLEN JUEGO CON 10 PZS



CÓDIGO	DESCRIPCION	
41064	1.5, 2, 2.5, 3, 3.5, 4, 5, 6, 8, 9 Y 10	MM
41061	1/16, 5/64, 3/32, 1/8, 9/64, 5/32, 3/16, 1/4, 5/16 Y 3/8	STD

## LLAVES COMBINADAS JUEGO CON 5 PZS



CÓDIGO	DESCRIPCION	
W15-MP	8, 10, 12, 14 Y 17	MM
W15-P	3/8", 7/16", 1/2", 9/16" Y 5/8"	STD



## RATCHET MULTIFUNCIONAL 3 EN 1 ACERO INOXIDABLE



CÓDIGO	DESCRIPCION
21442	3/8" DR

## PUNAS JUEGO DE 33 PZS



CONTIENE:

- 9 DE 25mm ESTRELLA: 8, 10,15, 20, 25,27, 30, 35, 40.
- 6 DE 25mm HEXAGONO: 5/64, 3/32, 7/64, 1/8, 9/64, 5/32.
- 4 DE 25 mm DE 3 PUNTAS: 1, 2, 3, 4.
- 4 DE 25mm DE SPANNER: 4, 6, 8, 10.
- 3 DE 25mm TORQ-SET: 6, 8, 10.
- 6 DE 25mm HEX-KEY: 2, 2.5, 3, 4, 5.6
- 1 DE 60mm MAGNETIC BIT HOLDER.



CÓDIGO

31833

## PUNAS TORX JUEGO 15 PZS.

CON ENTRADA DE 1/4, Y 3/8 6PC. 1/4 DR. SD-10,15,20,25,27,30. 6PC. SD-40,45,47,50,55,60 IPC. ADAPTADOR 2PC



CÓDIGO	CÓDIGO	DESCRIPCION
TBSK-15	TAIB0728	SIN GUIA
TBSK-15S	TAIB0730	CON GUIA

## PUNAS TORX JUEGO 5 PZS. SINGUA



CON ENTRADA DE 3/8 SD-40,45,47,50,60 Y PORTA PUNTAS TORX



CÓDIGO

TBSK-5

## DADOS TORX JUEGO 11PZS CON ENTRADA DE 3/8 Y 1/4

3/8 DR. E10,E12,E14,E16,E18  
1/4 DR E4,E5,E6,E7,E8.  
CON PORTA DADOS TORX

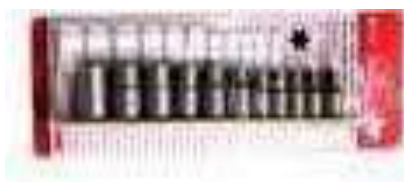

CÓDIGO

TBSK-11

## PUNAS EN ESTUCHOS CON 8 PZS.



TORX

MEDIDAS: T-9,T-10, T-15,  
T-20, T-25, T-27. T-30, T-40

CÓDIGO

WRTK-8P



ALLEN STD

MEDIDAS: 5/64", 3/32",  
7/64", 1/8", 9/64", 5/32",  
3/16", 7/32" Y 1/4"

CÓDIGO

91445



ALLEN MM

MEDIDAS: 1.5, 2, 2.5, 3, 3.5,  
4, 5, 6 Y 8mm

CÓDIGO

91446



## DESARMADOR CON PUNTA MAGNETICA



ACCA  
ACCESORIOS

DE CROMO -  
VANADIO

CÓDIGO	PUNTA
1-1140	PLANO
1-1139	CRUZ

## DESARMADORES PARA RELOJERO



JUEGO CON  
6 PIEZAS

CÓDIGO: SDP-06

## DESARMADOR CON RATCH



ACCA  
ACCESORIOS



CONTIENE:

- 1 PUNTA DE CRUZ # 1
- 1 PUNTA DE CRUZ #2
- 1 PUNTA PLANA DE 1/4
- 1 PUNTA PLANA DE 3/16

CÓDIGO: 10899

## DESARMADOR JUEGO C/8PZS



ACCA  
ACCESORIOS



MEDIDAS PLANOS: 3/16 X 3", 1/4 X 4"

MEDIDAS CRUZ: 2 X 1 1/2", 1 X 3" X 4" Y 1/4" X 1-1/2"

MEDIDA TORX: T-20 T-15

CÓDIGO: 30253

## 2PZS

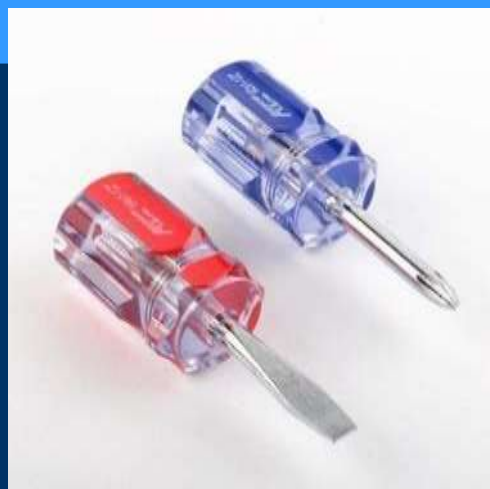

CÓDIGO:  
30976

## PUNTAS (DOBLE LADO) PARA TALADRO JEGOC/ 10PZS



CON:

- 1 DEL 0,
- 1 DEL 1,
- 2 DEL 2,
- 1 DEL 3,
- 1 DE 5/32
- 1 DE 3/16
- 1 DE 1/4
- 1 DE T15
- 1 DE T20.

CÓDIGO: 31070

## DESARMADORES PUNTA TORX



ACCA  
ACCESORIOS

JUEGO CON 2 PZS  
T-20 Y T-15

CÓDIGO: T-1520

## DESARMADORES 4 EN 1 MANGO ROJO MADE IN USA



ACCA  
ACCESORIOS

CONTIENE:

- 1 PUNTA DE CRUZ # 1, #2
- 1 PUNTA PALETA DE 9/32", 3/16"

CÓDIGO: 64612

## DESARMADOR 6 EN 1 MANGO ERGONÓMICO



ACCA  
ACCESORIOS

CÓDIGO: SD-6IN1S

## GUANTES DE NITRIL



ACCA  
ACCESORIOS



CÓDIGO	MEDIDAS
30252 CON 14pzs	MEDIDAS PLANOS: 2 X 1 1/2", 1/8 X 2 1/2", 3/16 X 3", 1/4 X 4" Y 5/16 X 6" MEDIDAS CRUZ: 2 X 1 1/2", 1 X 3" 0 X 2 1/2", 2 X 4" Y 3 X 6".
83353 CON 10pzs	MEDIDAS PLANOS: 2 X 1 1/2", 1/8 X 2 1/2", 3/16 X 3", 1/4 X 4" Y 5/16 X 6" MEDIDAS CRUZ: 2 X 1 1/2", 1 X 3" 0 X 2 1/2", 2 X 4" Y 3 X 6".

## PUNAS DE CRUZ DEL N.º2



ACCA  
ACCESORIOS

JUEGO CON 200  
CÓDIGO: 33083



ACCA  
ACCESORIOS

**FINZA DE ELECTRICISTA DE 8" ECONOMICAS**



**CÓDIGO**  
30248

**FINZA DE CORTE DAGONAL DE 8" ECONOMICAS**



**CÓDIGO**  
30251

**FINZA DE PUNTA DE 8" ECONOMICAS**



**CÓDIGO**  
30249

**FINZAS PARA CORTAR LAMINA DE 10'**



**CÓDIGO**  
93224

**FINZAS PARA CORTAR PVC**



CORTA HASTA 1 5/8" FACIL Y SEGURA DE USAR

**CÓDIGO**  
34046

**FINZA DE 8" PARA TERMINALES**



**CÓDIGO**  
RC-105

**LLAVE STILLSON ECONOMICA**



CÓDIGO	MEDIDA
E-8	8"
E-10	10"
E-12	12"
E-14	14"
E-18	18"

**FINZA DE PRESION DE 10' CON QUADA RECTA CURVA**



**IRWIN**  
**VISE-GRIP**

DE FACIL MANEJO,  
MATERIAL RESISTENTE Y  
LISTA PARA USARSE.

**CÓDIGO**  
10-R

**FINZA MECANICA JUEGO CON 3 PZS**



CÓDIGO	MEDIDA
PLSJ-31	6", 8" Y 10"
CHIP06S3	6", 8" Y 10"



## PINZA DE PRESION ECONOMICA



CÓDIGO	TAMAÑO
CR-V	10" / 250mm

## PINZA DE PRESION QUIJADA CURVA



- \*ACERO AL CARBON 55
- \*ACERO TEMPLADO
- \*TERMINADO NIQUELADO DE 10"
- \*GARANTIA DE 3 AÑOS

**CÓDIGO**

7030

## PINZA DE PRESION CON CADENA

CÓDIGO	TAMAÑO
31042	10" / 250mm



## PINZA DE USORILDO



IDEALES PARA CORTAR CABLE Y PRESIONAR TERMINALES

CÓDIGO	MEDIDA
33076	DE 10"
CHIP015-08	DE 8"

## PINZA DE PRESION MORDAZA CUADRADA



PINZAS DE PRESION MORDAZA CUADRADA C/ 2PZS

**CÓDIGO**

TAIC0322

## PINZA DE PRESION QUIJADA RECTA 10" C/U



**CÓDIGO**

CHIP102

## LLAVE CRECIENTE ECONOMICA



CÓDIGO	MEDIDA
C-8	DE 8"
C-10	DE 10"
C-12	DE 12"
C-15	DE 15"



## INFLADOR DE LLANTAS



**CÓDIGO DESCRIPCIÓN**

12069 CON MEDIDOR



CON  
GAUGE.  
CÓDIGO  
12068



**CÓDIGO**

0933

## PISTOLA PARA SOPLETAR



W/6' PARA LIMPIEZA DE MOTOR

**CÓDIGO PROVEEDOR**

13049 AMERICAN

## MANGUERA EN ESPIRAL 1/4"



**CÓDIGO TAMAÑO**

025 DE 25 FT.

050 DE 50 FT.



## REGULADOR DE PRE



CON MANOMETRO  
0-160 1/4 NPT



**CÓDIGO**

12119

## PISTOLA PARA SOPLETAR



JUEGO CON 5 PZS.

**CÓDIGO**

ATABG-004



ECONOMICO

**CÓDIGO**

M586

## PISTOLA PARA ROTULISTA PINTA SUAVE, DE AJUSTE DE 3/4 A 2"



CON PIPA ADAPTADORA DE  
1/4in HERRAMIENTA DE  
CALIDAD  
PROFESIONAL  
TRABAJA DE 15 A 50 PSI

**CÓDIGO**

12057

## FILTRO MINI DE ACEITE

PARA INYECCION  
NEUMATICA  
DE BRONCE 1/4 NPT.



**CÓDIGO**

10882

## FILTRO MINI DE AIRE



**CÓDIGO**

10877

## KIT DE 4 PC SPATULA PLANA DE PLASTICO CON MEDIDAS 1-1/2, 2, 3, 4



**CÓDIGO**

CHIS1127



## PISTOLA DE GRAVEDAD PARA PINTAR



**INCLUYE:**  
VASO DE PLASTICO CON CAPACIDAD DE 150cc. IDEAL PARA EL REPINTADO AUTOMOTRIZ, LA EBANISTERIA Y USO INDUSTRIAL. CONSUMO DE AIRE DE 2.8CFM PRESION OPTIMA DE TRABAJO DE 43PSI – 50 PSI



**CÓDIGO**

**12182**

## PISTOLA PARA PINTAR DE ALTA PRESION 50 - 90 PSI

**CON 2 PIEZAS.**



**CÓDIGO**

**12070**

**CON UNA PIEZA.**



**CÓDIGO**

**12071**

## TERMAN LATERAL CARTERA CON 10



**CON 2 PIEZAS**

- CAPACIDAD: 100CC & 680CC
- PRESION DE AIRE REQUERIDA: 50PSI & 70PSI
- CONSUMO DE AIRE: 2.8CFM & 4CFM
- O DE LAS BOQUILAS DE 1.3mm Y 1.4mm



**CÓDIGO**

**93355**

## SET REPARACION LLANTAS 15PCS



**CON UNA PIEZA.**

- CAPACIDAD: 600CC
- REQUIERE COMPRESOR DE 2 - 3HP
- CONSUMO DE AIRE: 4CFM



**CÓDIGO**

**12181**

## LLAVE PARA DIS



**CON 2 PIEZAS.**

PARA MAYORIA DE CARROS AMERICANOS

**CÓDIGO**

**ACWCW**



**HERRAMIENTAS PARA INSTALAR Y REMOVER BALATAS  
SET CON 11 PZS**



IDEAL PARA:  
MERCEDES, BMW, VW, GM, AUDI, FORD, HONDA,  
SUBARU, MAZDA, NISSAN, MITSUBISHI, TOYOTA,  
ROVER Y 4WD

**CODIGO**  
31099

**HERRAMIENTAS PARA INSTALAR Y REMOVER ALTERNADORES Y POWER  
STEERING SET CON 12 PZS**



PARA MODELOS DE LA GM, FORD Y  
CHRYSLER

**CODIGO**  
90367

**PROBADOR DE COMPRESION EN CILINDROS**

**SET PROFESIONAL CON 8 PZS**



- PUEBA LA COMPRESION RAPIDA Y PRECISA EN MOTORES A GASOLINA.
- TAMAÑO DE ROSCAS: M8 X 1.5, M10 X 1.0, M12 X 1.25, M14 X 1.25

**CÓDIGO**  
90376

**SET PROFESIONAL CON 12 PZS**



- PUEBA LA COMPRESION RAPIDA Y PRECISA EN MOTORES A DIESEL
- TAMAÑO DE ROSCAS: M10 X 1.0, M10 X 1.25, M12 X 1.25, M14 X 1.25

**CÓDIGO**  
90375

**KIT PARA INSTALAR Y REMOVER BALL JOIN SET CON 14 PZS**



**CÓDIGO**  
90362

**KIT PARA INSTALAR Y REMOVER BALL JOIN SET 3 EN 1**



**CÓDIGO**  
11370

## KIT DE MONTAJE SEPARADOR



DISEÑADO PARA QUE TIRA DEL COJINETE DEL EJE Y SEPARACIÓN DE CAJA DEL RODAMIENTO

CÓDIGO

90383

## ADAPTADOR DE CAMBIO RAPIDO



SET QUE CONTIENE 2pz DE 150mm DE 1/4

CÓDIGO

93258

## FRENSAS MN



SET QUE CONTIENE 3pz CON MEDIDAS EN 1,2 & 3in

CÓDIGO

23020

## ADAPTADOR DE CAMBIO RAPIDO



SET QUE CONTIENE 2 pz DE 60mm DE 1/4

CÓDIGO

93257

## PUNTAS MAGNETICAS



SET QUE CONTIENE 3pz DE 1/4 A 6, 8 & 10mm

CÓDIGO

10798

## EXTRACTOR DE POLEAS

MORDAZA DE ACERO FORJADA Y TRATADA TERMICAMENTE.

ELIMINA ENGRANAJES, POLEAS,

VOLANTES, ETC. DEL EJE.

MORDAZAS CON GANCHOS REVERSIBLES INTERIORES/EXTERIORES



CÓDIGO

CGP06B



## EXTENSIÓN PARA TALADRO



DE 2 1/2" CON IMAN  
PAQUETE CON 6PZS

CÓDIGO

CHIBH700

## EXTRACTOR PARA VOLANTE



JUEGO CON  
9 PIEZAS

CÓDIGO

87028

## EXTRACTOR DE POLEAS



JUEGO C/ 4PZS  
DE 3", 4", 6" Y 8"

CÓDIGO

91142

## PATA DE GALLO



CON 13 PZS

CÓDIGO

89004

## OPRESOR DE SAPOS



CÓDIGO

02120

## EXTRACTORES PARA TORNILLOS



JUEGO CON 8PZS

MEDIDAS: 5/32", 5/16", 1/4",  
9/32", 7/16", 5/8", 3/4" Y  
15/16"

CON ESTUCHE

CÓDIGO

93191

JUEGO CON 6 PZS.  
CON ESTUCHE



CÓDIGO

TAIE0739



JUEGO CON 5PZS.

CÓDIGO

1-1529

CÓDIGO

TAIE0737

## EXTRACTOR BRAZO PITMAN



CÓDIGO

89002

## OPRESOR DE ANILLO



DE 4" CAPACIDAD DE  
60mm HASTA  
175mm

CÓDIGO

OP-4

## PULDRES DE CILINDROS

CÓDIGO

88232

CILINDRO DE

FRENOS

MEDIDAS

DE 3/4 A 2 1/2  
in



## OPRESOR DE RESORTE



CÓDIGO	LONGITUD
83023	DE 12"
TAIC0177	DE 12"
TAIC0175	DE 9"

## AUMENTO DE TORNILLOS



PARA RESORTE  
CARTERA CON 2 PIEZAS

CÓDIGO  
18-1201

## ESPACEADORES



PARA RESORTES  
DELANTEROS  
CARTERA CON 4 PIEZAS

CÓDIGO  
18-8001



PARA RESORTES  
TRASEROS  
CARTERA CON 4 PIEZAS

CÓDIGO  
18-9001

## BLOQUE



CÓDIGO  
CHIS0681

## AUMENTO DONA PARA RESORTE



CÓDIGO  
18-1901

## RESORTE



CARTERA CON 20 PZS.

CÓDIGO  
11111

## RESORTES SURTIDOS KIT C/200 PZS



CÓDIGO  
TAIAS200

## PALANCA



CÓDIGO  
03482

## PEDRA VERDE DE BARRA PARA PULIR CROMO



CÓDIGO  
PDV

## LIMPIADOR DE BATERIA



CÓDIGO  
W-147-C

## ESCUADRA DE COMBINACION DE 12"



CON ESTRUCTURA  
DE ALUMINIO  
CÓDIGO: CS-12

## MENSLA



CÓDIGO	MEDIDAS	CÓDIGO	MEDIDA
MEN-2	DE 4" X 5"	MEN-5	DE 8" X 10"
MEN-3	DE 5" X 6"	MEN-6	DE 10" X 12"
MEN-4	DE 6" X 8"	MEN-7	DE 12" X 14"

## ESPATULA TAPZADORA PAQUETE CON 12 PIEZAS



CÓDIGO	MEDIDAS
ET-8	DE 8" (203mm)
ET-10	DE 10" (254mm)
ET-12	DE 12" (305mm)

## ESPATULA FLEXIBLE PAQUETE CON 12 PIEZAS



CÓDIGO	MEDIDAS	CÓDIGO	MEDIDA
1-1070	1" (25mm)	1-1073	4" (101mm)
1-1015	1 1/2" (37mm)	1-1074	5" (127mm)
1-1072	2" (51mm)	1-1075	6" (127mm)
1-1071	3" (76mm)		

## ESPATULA MANGO DE PLASTICO CON NAVAJA PAQUETE CON 12 PIEZAS



CÓDIGO  
11075

## PIEDRA PARA AFLAR



CÓDIGO	MEDIDAS
48959	6" X 2" X 1"
53093	8" X 2" X 1"

## JUEGO DE MENSLAS 2PZS



CÓDIGO	MEDIDAS
00191	6" X 8"
00192	8" X 10"
00193	10" X 12"

## NAVAJA DE UN FLO



CAJA CON 100 PZS.  
CÓDIGO  
00-402

## NAVAJA DE ALMACEN



INCLUYE PORTA NAVAJA.  
PAQUETE CON 100 PZS.

CÓDIGO  
00-403

## NAVAJA DE UN SOLO FLO



CAJA CON 5PZS.  
CÓDIGO  
112-10



**ARCODE 14"(355mm) PARA HJALATERO**



CUERPO DE ALEACION METALICA  
MANGO CON AJUSTE DE TUERCA  
P/LIMA FLEXIBLE DE 350mm  
**CÓDIGO: ARLI-14**

**ARCO CONSEJETA**



CROMO ESTANDAR  
**ECONOMICO**  
**CÓDIGO: 1-1068**

**MIN ARCO CONSEJETA**



PARA CORTAR MADERA, YESO,  
ACERO, LATON, ETC.  
**CÓDIGO: T113**

**CINTA PROFESIONAL DE PRECAUCION**



ROLLO DE 3" X 1000fts  
COLOR AMARILLO  
**CÓDIGO: 97849**

**CINTA  
PARA FLEJAR**



DE 2" x 50yds.

CÓDIGO	COLOR
82864	CLARA
82865	CANELA

**DUCTO TAPE  
U.S.A.**



DE 2"

CÓDIGO	MEDIDA
6802	10yds
6900	50yds.

**MASKING TAPE  
USO GENERAL  
ROLLO 50M**



CÓDIGO	MEDIDA
5540	DE ¾"
5541	DE 1"
5542	DE 1 ½"
5543	DE 2"

**CINTA PARA FLEJAR PAQUETE CON 6 PZAS**



DE 2" POR 100 YFS

CÓDIGO	COLOR
2CT-100	CLARA
2TT-100	CANELA



**SEGUETAS MORSE**



CÓDIGO	DESCRIPCION
18DPP	CON 18 DIENTES POR PULGADA.



## CHAROLA PARA EMPLASTE DE 14"



METALICA

CÓDIGO: TRWMP-14SS



DE PLASTICO

CÓDIGO: TRWMP-14P

## CINTA PERFACEL ROLLO CON 92m



AMARILLA

CÓDIGO	DESCRIPCION
PCA92	2" X 150
PCA92-300	2" X 300



BLANCA

CÓDIGO: PCB92

PERFACINTA BLANCA 2" x150' (48mm x 92 m)

## MARRO CON MANGO DE MADERA



CÓDIGO	DESCRIPCION
MAF-2	DE 2Lbs.
MAF-3	DE 3Lbs.
MAF-4	DE 4Lbs.

## MARTILLO TUBULAR 16oz



CÓDIGO:  
26329

## MARTILLO DE FIERA DE VIDRO



CÓDIGO	DESCRIPCION
21014	DE 16oz. LISO
21026	DE 24oz.

## MARTILLO CON MANGO DE MADERA



DE 21oz.

DE QUIJADA RECTA  
GENUINE HICKRY

CÓDIGO: 20065

## MARTILLO UNA SOLA PIEZA DE ACERO



DE 24oz.

- DE QUIJADA RECTA
- PARTE SUPER MAGNETICA

CÓDIGO: 20116

## NIVEL DE ALUMINIO DE 24"



BASE CON IMAN  
CÓDIGO: CHIL7400

## NIVEL DE PLASTICO DE 24"



GRADUADA  
CÓDIGO: CHIL8720

## LIMA PLANA MUSA



CÓDIGO	MEDIDA
LMP-8	DE 8"
LMP-10	DE 10"
LPB-8	DE 8"
LPB-10	DE 10"

## JUEGO DE ANILLOS



CÓDIGO

16478

## LIMA TIPO QUESERA CON MANGO DE PLASTICO Y CUERPO METALICO



**DE 10"**  
PARA REBAJAR BONDO

CÓDIGO: CHIF100

## LIMA PARA HOJALATERO



**DE 14"**  
CÓDIGO: LHO-14

## CALBRADOR PARA BUJAS TIPO MONEDA Y DE HOJA



**TIPO MONEDA**  
ESCALA DE 0.020 A 0.100  
Y SU EQUIVALENTE METRICO

CÓDIGO: 712A



CÓDIGO	DESCRIPCION
ATFG-003	DE 15 HOJAS. DE 0.002 A 0.025

## FLEXOMETRO PROFESIONAL



- PARA USO RUDO
- DISEÑO ERGONOMICO

CÓDIGO	MEDIDA
20037	DE 16' X 5M X 3/4"
20035	DE 10' X 3M X 1/2"

## FLEXOMETRO PROFESIONAL MARCA STANLEY



- REVESTIDA CON NYLON.  
ESTRUCTURA IMPREGNADA DE CAUCHO PARA AGARRE COMODO.

CÓDIGO	MEDIDA
30-626	DE 8mts / 26'
30-615	DE 5mts / 16'
30-608	DE 3mts / 10'



## DESARMADORES STANLEY JUEGO CON 6 pzs.

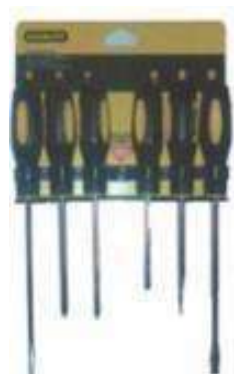

INCLUYE  
SU PORTA DESARMADORES

CÓDIGO: 60-0600



# NewTek

BALATAS SEMI-METALICAS TITANIO DE PRIMERA CALIDAD.  
 DISEÑADAS CON MATERIAL DE MUY ALTA CALIDAD IDEALES PA-  
 RA  
 APLICACIONES DE USOS MUY SEVEROS.

ESTAS BALATAS SON UTILIZADAS POR FLOTILLAS DE TAXIS EN  
 LA CIUDAD DE NEW YORK.

CÓDIGO	CÓDIGO	CÓDIGO
MD227	MD745	MD1022
MD300	MD749	MD1069
MD324	MD750	
MD363	MD812	
MD383	MD817	
MD452	MD830	
MD524	MD839	
MD534	MD886	
MD544	MD887	
MD555	MD900	
MD577	MD929	
MD580	MD931	
MD584	MD965	
MD593	MD967	
MD621	MD970	
MD664	MD975	
MD669	MD1011	
MD696	MD1017	



# BALATAS SEMIMETÁLICAS PARA DISCOS MARCA GIC

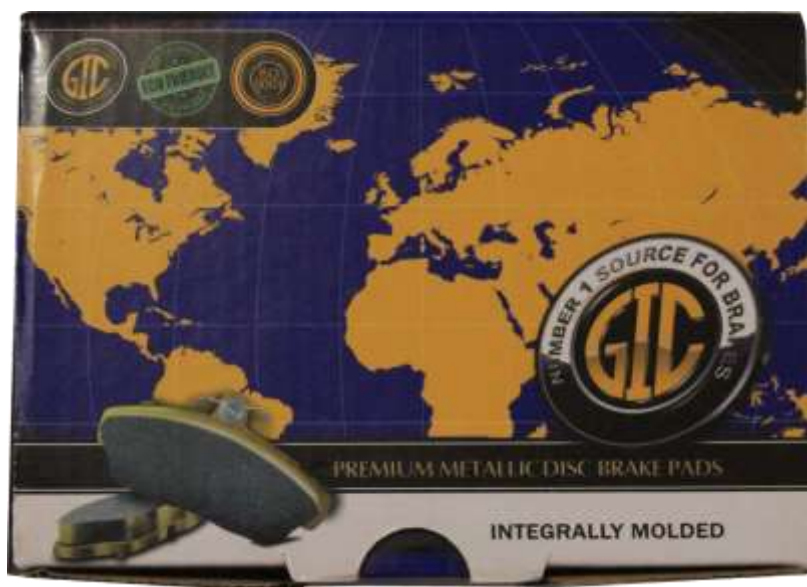

CÓDIGO	CÓDIGO	CÓDIGO	CÓDIGO	CÓDIGO
MD215G	MD464G	MD678G	MD862G	MD1216G
MD219G	MD499G	MD687G	MD867G	MD1278G
MD227G	MD505G	MD694G	MD886G	MD1279G
MD224G	MD511G	MD696G	MD898G	
MD234G	MD521G	MD704G	MD900G	
MD241G	MD522G	MD714G	MD924G	
MD266G	MD524G	MD724G	MD931G	
MD275G	MD544G	MD733G	MD932G	
MD289G	MD563G	MD745G	MD935G	
MD306G	MD564G	MD751G	MD942G	
MD324G	MD567G	MD752G	MD958G	
MD325G	MD569G	MD757G	MD959G	
MD328G	MD577G	MD766G	MD964G	
MD380G	MD584G	MD774G	MD981G	
MD383G	MD593G	MD777G	MD1040G	
MD388G	MD601G	MD782G	MD1046G	
MD392G	MD610G	MD792G	MD1047G	
MD398G	MD661G	MD799G	MD1058G	
MD450G	MD663G	MD812G	MD1086G	
MD452G	MD664G	MD828G	MD1092G	
MD458G	MD674G	MD840G	MD1100G	

# BALATAS SEMMETALICAS PARA DISCOS MARCA NEWTEK



CÓDIGO	CÓDIGO	CÓDIGO
SMD52	SMD802	SMD1210
SMD340	SMD804	SMD1258
SMD365	SMD815	SMD1273
SMD369	SMD816	SMD1274
SMD387	SMD830	SMD1329
SMD430	SMD841	SMD1345
SMD462	SMD856	SMD1444
SMD465	SMD866	SMD1445
SMD562	SMD905	SMD1454
SMD579	SMD914	SMD1468
SMD652	SMD923	SMD1521
SMD655	SMD976	SMD1592
SMD702	SMD1028	SMD1731
SMD707	SMD1033	SMD1935
SMD711	SMD1035	
SMD730	SMD1094	
SMD768	SMD1100	
SMD784A	SMD1107	
SMD785	SMD1108	
SMD787	SMD1173	
SMD793	SMD1191	



**CÓDIGO**

SCD465A

SCD855A

SCD857

SCD1210

SCD1345

SCD1349

SCD1522

SCD1568

SCD1569

SCD1590

SCD1592

SCD1593





## KIT PARA RECARGAR GAS REFRIGERANTE



PARA GAS R-12 EZ  
CÓDIGO:



PARA GAS 134-A  
CON CONEXIONES  
DE PLASTICO

CÓDIGO: 401P

## KIT PARA RECARGAR GAS REFRIGERANTE



PARA GAS R-134A

CON  
CONEXIONES  
DE  
BRONCE

CÓDIGO:  
MB-134A

## SET PARA DESCONECTAR LINEAS DE COMBUSTIBLE Y DE A/C



FACILITA LA DES-  
CONEXION DE  
LINEAS DE COM-  
BUSTIBLE Y DE A/  
C  
MEDIDAS DE  
1/4", 5/16", 3/8",  
1/2", 5/8", 3/4" Y  
7/8"

CÓDIGO: CAPFLD

## KIT PARA DIAGNOSTICO DE A/C



CÓDIGO:  
90371

## PAPEL PARA POLARIZAR 20X100"

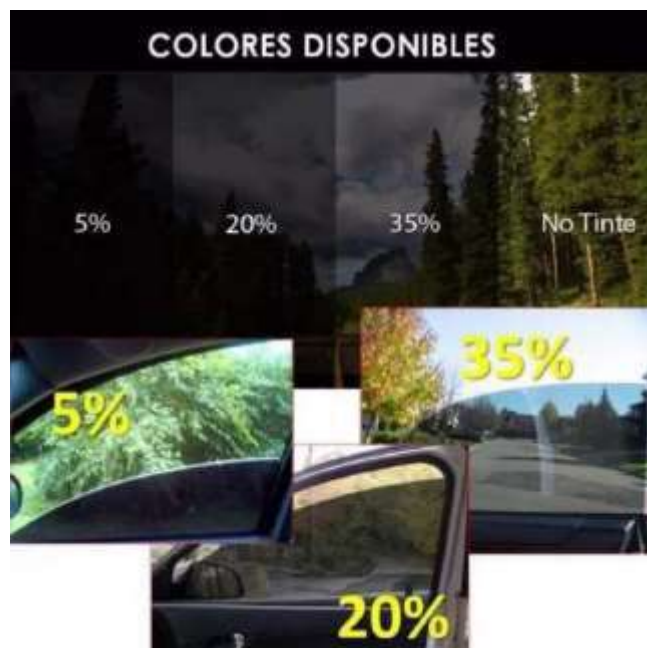

CONSIGUE CONTROLAR LA TEMPERATURA AMBIENTE, EVITA EL INGRESO DE RAYOS SOLARES INFRARROJOS LETALES PARA LA PIEL E INCLUSO ELIMINA EL EFECTO "HORNO" PROVOCADO POR LAS HORAS DE APARCAMIENTO AL AIRE LIBRE EN LA TEMPORADA DE VERANO.

CÓDIGO	No.
EA05BK	5%
GPCG-20A	20%
EA35BK	35%

## PAPEL TORNASOL PARA POLARIZAR



CÓDIGO	COLOR	MEDIDAS
PO301A	AMARILLO	30 CM x 10 MTS
PO303A	VERDE	30 CM x 10 MTS
PO307A	AZUL	30 CM x 10 MTS

## PROTECTOR PARA FUERIA ROLLO 46 MTS



CÓDIGO	COLOR
SILVA-C	CROMO STD
SILVA-N	NEGRO



## COROHO PARA HACER EMPAQUES



CÓDIGO	MEDIDA
C-1	1/16" x 12" x 36"
C-2	1/8" x 12" x 36"

## BELOVID PARA HACER EMPAQUES



CÓDIGO	MEDIDA
1101	1/64" x 9" x 36"
1102	1/32" x 9" x 36"

## ASBESTO PARA HACER EMPAQUES



CÓDIGO	MEDIDA
1966-C	1/32" x 12" x 120"
1967-C	1/16" x 12" x 20"

## MANGUERA PARA AIRE CON CONEXION



CÓDIGO	DESCRIPCION	PROVEEDOR
0802	DE 3/8 X 25FT	AMERICAN
0804	DE 3/8 X 50FT	AMERICAN
0805	DE 3/8 X 100FT	AMERICAN

## MANGUERA PARA GASOLINA ROLLO DE 25FTS.

CÓDIGO	MEDIDA
24060	1/4"
24078	5/16"
24088	3/8"

## MANGUERA PARA CALENTON ROLLO DE 50FTS.

CÓDIGO	MEDIDA
1725	1/2"
1726	5/8"
1727	3/4"
1728	1"

## MANGUERA PARA TRANSMISION ROLLO DE 25FTS.

CÓDIGO	MEDIDA
31616	3/8"
32998	5/16"



## MANGUERA PARA AVANCE ROLLO DE 50FTS.

CÓDIGO	MEDIDA
334050	5/32"
334150	7/32"

## GUANTES DE PIEL PARA CHOFER



CÓDIGO: 608-P

## GUANTES DE LONA Y CARNAZA UNTALLA

CÓDIGO	DESCRIPCION
608-H	SENCILLOS
609-H	REFORZADOS



## GUANTES DESEL PARA MECANICO



- MUY COMODOS
- PALMA ANTIDERRAPANTE
- AUTO AJUSTABLES
- SEMI-PROFESIONALES

CÓDIGO	TALLA
LN2000-M	MEDIANO
LN2000-L	GRANDE
LN2000-XL	EXTRA GRANDE



- MUY COMODOS
- PALMA ANTIDER-RAPANTE
- AUTO AJUSTABLES

CÓDIGO	TALLA
023-M	MEDIANO
023-L	GRANDE
023-XL	EXTRA GRANDE

## GUANTES NEGROS DE NITRIL



CÓDIGO

43-40MN-BK-M

43-40MN-BK-L



PARA ENSAMBLAJE, JARDINERIA, ALMACENAMIENTO, TRABAJOS CON CABLEADO. DISTINTAS MEDIDAS. ULTRA LIGEROS. TOTAL RESPIRACIÓN. PALMAS PUNTEADAS PARA MEJOR AGARRE.

CÓDIGO	MEDIDA
32184	MEDIANO
32185	GRANDE
32186	EXTRA GRANDE



## CABLE DE EXTENCION



**CODIGO**  
**CHIE0966**

## EXTENCION ELECTRICA A



**CODIGO**  
**ECTL-15**

**15 PULGADAS**

## MARTILLO MANGO FIBRA DE VIDRIO



**16 ONZAS LISO**

**CODIGO**  
**HMFR-16A**

## MARRO MANGO FIBRA DE VIDRIO

**MARRO MANGO FIBRA DE VIDRIO**



**5 LIBRAS**

**CODIGO**  
**HMPSL-03**

## RESPALDO DE HULE CON ESPONJA



**7' C/5PIEZAS**

**CODIGO**  
**ABSD7-5**

## GANCHOS PARA PICK UP

**GANCHOS PARA PICK UP**



**SET CPN 2 PZ**

**CÓDIGO; RTDHK-003**

**GANCHOS ECONOMICO PARA PICK UP**



**SET CPN 2 PZ**

**CÓDIGO; RTDHK-004**

**GANCHOS PARA PICK UP**



**SET CPN 2 PZ**

**CÓDIGO; RTDHK-001**



## TAPON RADIADOR



CÓDIGO	STANT
RR-25	10225

## TAPON RADIADOR 13 LBS



CÓDIGO	STANT
RR-27	10227

## TAPON RADIADOR O VALVULA 16 LBS



CÓDIGO
RSP-30

## TAPON RADIADOR



CÓDIGO	STANT
RR-32	10232

## TAPON RADIADOR



CÓDIGO	STANT
RR-36	10236

## TAPON RADIADOR



CÓDIGO	STANT	CAPACIDAD
RR-38	10238	16 PSI
RR-39	10239	15 PSI.

# EXTENSIONES DE USO DOMÉSTICO



- CONEXIÓN POLARIZADA.
- TAMAÑO DE SEIS PIES (1.83m).
- DE TRES CONEXIONES.
- MUY LIGERA.
- 13AMPERES 125VOLTS 1625WATSS, CALIBRE 2.
- AVALADA POR LA **NORMA DE CALIDAD UL**.



CÓDIGO	TAMAÑO
70035	6 FTS (1.83mts)
70036	9 FTS (2.74mts)
70038	15FTS (4.50mts)

CÓDIGO	LONGITUD
2112	12"
2120	20"
ECI-1625	25"

## DOMÉSTICOS

- CALIBRE 16 AWG
- 3 CONTACTOS ATERRIZADOS
- GARANTIA 2 AÑOS DE CALIDAD

CÓDIGO	TAMAÑO
ED13-5B	5 mts
ED13-8B	8 mts
ED13-10B	10 mts



Tensión: 125 v~  
Corriente: 13 A

## RUDOS

- CALIBRE 16 AWG
- RECUBRIMIENTO DOBLE
- CONTACTOS ATERRIZADOS DE COBRE
- GARANTIA 2 AÑOS DE CALIDAD

CÓDIGO	TAMAÑO
ER13-3NA	3mts
ER13-5NA	5 mts
ER13-8NA	8 mts
ER13-10NA	10 mts
ER13-15NA	15 mts
ER13-20NA	20 mts
ER13-30NA	30 mts



Tensión: 125 v~  
Corriente: 15 A

**EXTENSION CON FOCO PARA 110v  
CON PROTECCION METALICA**



CÓDIGO	LONGITUD
2350	50FTS
70062	50 FTS
23100	100FTS

**CALENTADOR  
ELECTRICO  
DE AGUA**



**DE 18" CALIENTA  
EN MINUTOS  
CÓDIGO: 2204**

**EXTENSION  
CON FOCO  
PARA 12v**



**CÓDIGO: 0772**

**EXTENSION MULTIPLE  
CON BRAKE**



**CALIBRE 14  
DE PLASTICO**

**CÓDIGO: PSUL-6P**

**EXTENSIÓN HEAVY DUTTY**

**DE CALIDAD NORMAL**



**DE CALIDAD CERTIFICADA  
POR LA NORMA UL**



CÓDIGO	LONGITUD	CALIBRE
2125-16	25 FTS	16
2125-12	25 FTS	12
2150-16	40 FTS	16
2150-12	40 FTS	12
21100-16	100 FTS	16
21100-12	100 FTS	12

CÓDIGO	LONGITUD	CALIBRE
2125-16UL	25 FTS	16
2125-12UL	25 FTS	12
2150-16UL	50 FTS	16
2150-12UL	40 FTS	12
21100-16UL	100 FTS	16
21100-12UL	100 FTS	12

**EXTENSION ELECTRICA HD 100 FTS.  
CAL. 16 UL**

**CON INDICADOR  
DE LUZ.**



**CÓDIGO  
70043**



**CABLE  
PARA  
BOCINA**

CÓDIGO	LONGITUD	CALIBRE
CAB-B18	100 MTS	18

**CABLE PARA BOCINA**



CÓDIGO	LONGITUD	CALIBRE
C-1000-18	1000 FTS	18
C-1000-24	1000 FTS	24
C-1000-16	1000 FTS	16
C-300-12	300 FTS	12
C-100-12	100 FTS	12
C-100-18	80 FTS	18
C-100-24	100 FTS	24
C-100-16	100 FTS	16

**TIRALINEAS AZUL Y POVO**



**CÓDIGO  
564110**



## TAPON RADIADOR



CÓDIGO	STANT	CAPACIDAD
RR-40	10240	18 PSI

## TAPON RADIADOR



CÓDIGO	STANT
RR-43	10243

## TAPON GASOLINA CON ROSCA



CÓDIGO
13-CK016

## TAPON PARA GASOLINA



CÓDIGO	STANT
MGC-802	10502
MGC-907	10509

## TERMOSTATOS



CÓDIGO	STANT
207-180	13828
267-195	13899
2028-180	13968
234-160	13376
281-180	14078
321-170	13967

## TERMOSTATOS UNIVERSALES



CÓDIGO
P300-160
300-195
300-180



## TIRALINEAS Y POLVO MARCA RWN

TIRALINEAS IRWIN  
DE 30m 3  
X MAS RAPIDO



CÓDIGO: 64310

TIRALINEAS IRWIN  
DE 30m 3  
DE METAL



CÓDIGO: 64110

## TIRALINEAS 30 mts. CON POLVO



CON POLVO ROJO  
CÓDIGO: 47144

## TIRALINEAS METALICO



CON POLVO.  
CÓDIGO: 564110

## SET AZUL DE CHALK LINE



- Chalk Line con 3pzs.
- Incluye línea de tiza, tiza y un nivel de bolsillo
- Línea de tiza de 100ft.
- Soporta hasta 4 oz
- Nivel de línea horizontal para marcar
- El carrete puede ser usado para hacer marcaciones verticales.

CÓDIGO: 90332

## MECATE DE 1/4 X 50"



CÓDIGO: 13197

## HLODENLON PARA ALBAÑIL ROLO CON 10mts CAL 18



CÓDIGO	COLOR
0029	AMARILLO
0018	BLANCO

# CONVERTIDORES DE CORRIENTE DC A AC



CÓDIGO	CAPACIDAD
HI-100	100W
HI-200	200W
HI-40121A	400W
HI-500	500W
HI-600	600W
HI-800	800W
HI-1000	1000W
HI-2000	2000W
HI-2500	2500W



## ESTUFA COMPACTA



IDEAL PARA DIAS DE CAMPO  
FACIL DE TRANSPORTAR  
DEBIDO A SU MALETA.  
**CÓDIGO: EZS-1000**

## REPUESTO DE GAS PARA ESTUFA COMPACTA



LATA DE GAS BUTANO  
CON 8 OZ.  
**CÓDIGO: 6802-TGE**

## MASCARILLA SENCILLA CON 50pzs.



**CÓDIGO: 41200**



### ENCENDEDOR PARA ESTUFA

#### PARA USOS EN:

- B.B.Q
- PARA ESTUFAS SIN PILOTO
- CAMPAMENTOS
- ETC.

**CÓDIGO: 70002**

#### NOTA:

RECARGABLE DE GAS BUTANO



**ENCENDEDOR DESECHABLE**  
PAQUETE DE ENCENDEDORES  
DESECHABLES CON 25 PIEZAS.

**CÓDIGO: 45824**

## ESTUFA DE GAS CON 2 QUEMADORES



### ACABADOS DETALLADOS

- CON ENCENDIDO ELECTRONICO.
- CON QUEMADORES DIFERENTES DISEÑOS
- QUEMADORES EN BRONCE.
- FACIL DE LIMPIAR.
- MUY LIGERA.
- CON TODAS LAS CONECIONES NECESARIAS PARA SU USO.

**CÓDIGO: S-0808**



**CHAPA COMBO TIESHEN**

CÓDIGO	DESCRIPCION
B601+C301PB	CON CILINDRO SENCILLO
B601+C312PB	CON CILINDRO DOBLE



CÓDIGO	DESCRIPCION
C301PB	CON CILINDRO SENCILLO
C312PB	CON CILINDRO DOBLE

**CHAPA TITAN DE DOBLE CILINDRO**



**CÓDIGO: 64861-DB**

## CHAPA 2 CLINDROS



CÓDIGO

DDDAB-24

COLOR

BRONCE ENVEJECIDO

## CHAPA 1 CLINDRO



CÓDIGO

DDSAB-24

COLOR

BRONCE ENVEJECIDO



CÓDIGO

DDDPB-24

COLOR

ORO



CÓDIGO

DDSPB-24

COLOR

ORO



CÓDIGO

DDDSN-24

COLOR

PLATA



CÓDIGO

DDSSN-24

COLOR

PLATA



## CHAPA DE ENTRADA COMBO CILINDRO SENCILLO



CÓDIGO

DCSPB-12

COLOR

ORO

## CHAPA DE ENTRADA SIN LLAVE



CÓDIGO

DPEPB-24

COLOR

ORO

## CHAPA DE ENTRADA CON LLAVE



CÓDIGO

DELAB-24

COLOR

BRONCE ENVEJECIDO

## CHAPA DE ENTRADA CON LLAVE



CÓDIGO

DELPB-24

COLOR

ORO

## CHAPA DE ENTRADA CON LLAVE



CÓDIGO

DELSN-24

COLOR

PLATA

## CHAPA DE ENTRADA COMBO CILINDRO DOBLE



CÓDIGO

DCDPB-12

COLOR

PLATA

## COPA BICOLOR ABS SPORT DE 13"



CÓDIGO: 490496



TIPO TEABS02-R13  
CÓDIGO: 491486



CÓDIGO: 490533



CÓDIGO: 490632N

## COPAS COLOR NEGRO Y BICOLOR ABS SPORT DE 14"



TIPO TSPORT02-R14  
CÓDIGO: 491783B



CÓDIGO: 492490N



TIPO TEABS01-R14  
CÓDIGO: 491622B

## COPAS NEGRO Y BICOLOR ABS SPORT 15" A



SPORT 15" VERSA  
CÓDIGO: 492964B



CÓDIGO: 492070B

SPORT 15" TOYOTA



CÓDIGO: 492971N



CÓDIGO: 492971B

## COPAS COLOR NEGRO ABS SPORT 16"



CÓDIGO:  
491738N



## COPA BICOLOR Y NEGRA 14"



CÓDIGO: ABSLESR140010



TIPO

## COPA GRIS Y NEGRA 15"



CÓDIGO: ABSLGRR150058



CÓDIGO: ABSLGRR150060



CÓDIGO: ABSLESR150014

## COPA BICOLOR Y NEGRA 15"



CÓDIGO: ABSLESR150016



CÓDIGO: ABSLESR150015



CÓDIGO: ABSLESR150017

## COPA NEGRA Y GRIS 16"



CÓDIGO: ABSLGRR160007



CÓDIGO: ABSLESR160002



## COPA CROMADA ABS SPORT DE 13"



CÓDIGO: 490854



CÓDIGO: 491899



CÓDIGO: 491905

## COPA CROMADA ABS DE 13"



CÓDIGO:  
492285

## COPA GRIS ABS DE 13"



CÓDIGO:  
467130

## COPA GRIS ABS DE 13"



CÓDIGO: 492117



CÓDIGO: 492124



CÓDIGO: 492131



CÓDIGO: 492209

## COPA GRIS ABS SPORT DE 13"



CÓDIGO: 490571



CÓDIGO: 490236



CÓDIGO: 490441



CÓDIGO: 490632

## COPA GRIS ABS DE 13"



CÓDIGO:  
490243



CÓDIGO:  
491615

## COPA CROMADA ABS SPORT DE 14"



CÓDIGO: 491530



CÓDIGO: 492308



CÓDIGO: 491806



CÓDIGO: 491820



CÓDIGO:  
492261A

CÓDIGO:  
490885



## COPA CROMADA ABS DE 14"



CÓDIGO: 492216



CÓDIGO: 492223



CÓDIGO: 492278R



CÓDIGO: 492452



# COPA GRIS ABS SPORT DE 14"



**CÓDIGO: 490274**



**CÓDIGO: 491455**



**CÓDIGO: 490380**



**CÓDIGO: 491493**



**CÓDIGO: 490250**



**CÓDIGO: 491622**



**CÓDIGO: 491783**



**CÓDIGO: 492490**



**CÓDIGO: 490823**



**CÓDIGO: 490663**



## COPA GRIS ABS DE 14"



CÓDIGO: 492605



CÓDIGO: 461141



CÓDIGO: 492155

## COPA GRIS ABS DE 15"



CÓDIGO:  
492186



CÓDIGO:  
492551



CÓDIGO:  
490816



CÓDIGO:  
492629



CÓDIGO:  
492643

# COPA GRIS ABS SPORT DE 15"



CÓDIGO: 490830



CÓDIGO: 490397



CÓDIGO: 490427



CÓDIGO: 490465



CÓDIGO: 492483



CÓDIGO: 492070



CÓDIGO: 492063



CÓDIGO: 491653



CÓDIGO: 491592

COPA PARA CARRO  
MODELO TOYOTA



CÓDIGO: 492971

COPA PARA CARRO  
MODELO SENTRA



CÓDIGO: 490823R15

COPA PARA CARRO  
MODELO VERSA



CÓDIGO: 492964

## COPA CROMADA ABS DE 15"



**CÓDIGO:**  
492254

## COPA CROMADA ABS CON TAPA



105114 (14")

105115 (15")

## COPA CROMADA ABS SPORT DE 15"



**CÓDIGO:**  
492506



**CÓDIGO:**  
491738



**CÓDIGO:**  
491738



**CÓDIGO:**  
491844



**CÓDIGO:**  
491851



**CÓDIGO:**  
491868



**COPA GRIS ABS SPORT 14''**



**ABS-LGR-R14-0013**

**COPA BICOLOR ABS 14''**



**ABS-LES-R14-0020**

**COPA GRIS ABS 14''**



**ABS-LGR-R14-0081**



**ABS-LGR-R14-0082**



**ABS-LGR-R14-0083**

**COPA GRIS ABS SPORT CROMADO 14''**



**ABS-LGR-R14-0075**



**ABS-LGR-R14-0078**



**ABS-LGR-R14-0079**

## COPA GRIS ABS SPORT 15''



**ABS-LGR-R15-0005**



**ABS-LGR-R15-0046**



**ABS-LGR-R15-0062**

## COPA GRIS ABS SPORT CROMADO 15''



**ABS-LGR-R15-0023**



**ABS-LGR-R15-0028**



**ABS-LGR-R15-0041**



**ABS-LGR-R15-0065**

## COPA BICOLOR ABS 15''



**ABS-LES-R15-0007**



**ABS-LES-R15-0019**



**ABS-LES-R15-0026**

## COPA GRIS ABS 15''



**ABS-LES-R15-0067**



**COPA CROMADA  
ABS SPORT 16"**



**CODIGO: 492414**

**COPA DIFUMINADA 16"**



**LESDIF-BIC-R16-1**



**LESDIF-BIC-R16-2**

**COPA NEGRO ABS SPORT 16"**



**ABS-LES-R16-0001**

**COPA GRIS ABS SPORT DE 16"**



**CÓDIGO: 491721**



**CÓDIGO: 491608**



**CÓDIGO: 491738R16**



**ABS-LGR-R16-005**

**PORTA PLACAS PLASTICO PAQUETE CON 2 PZS.**



CÓDIGO	COLOR	CÓDIGO	COLIR
PPNL	NEGRO LISO	PPCL	CROMO LISO
PPNT	NEGRO ESTAMPADO TIJUANA	PPCT	CROMO ESTAMPADO TIJUANA



# CENTROS PARA RINES

PARA  
CAMIONETAS LOBO



CÓDIGO:  
CCR001

PARA  
CAMIONETAS RAM



CÓDIGO:  
CCR002

PARA  
CAMIONETAS RANGER



CÓDIGO:  
CCR003

PARA  
CARROS NISSAN



CÓDIGO:  
CCR004

# CUBRE BRLOS

CONICOS



CÓDIGO	MEDIDA
CBC01	33mm
CBC02	38mm

HEXAGONALES



CÓDIGO	MEDIDA
CBE002	33mm
CBE003	38mm

## IMPERMEABLE HEAVY DUTY DE 3 PIEZAS



(PANTALON, CHAMARRA Y CAPUCHA)  
HECHO DE PVC/POLYESTER.

CÓDIGO	TALLA
BI-R050M	MEDIANO (M)
BI-R050L	GRANDE (L)

## ADULT RAIN PONCHO



<b>CÓDIGO</b>
<b>12318A</b>
<b>COLOR</b>
<b>AMARILLO</b>

## CUBRE CARRO ECONOMICOS



CÓDIGO	TALLA	CÓDIGO	TALLA
CC-141-S	CHICA (S)	CC-144-XL1	EXTRA GRANDE 1
CC-142-M	MEDIANA (M)	CC-145-XL2	EXTRA GRANDE 2
CC-143-L	GRANDE (L)		

## BOLSA PARA BASURA

PAQUETE CON 7 BOLSAS  
CADA UNA CON CAPACIDAD DE  
33 GALONES (124 Lts)



MEDIDAS:  
82.5cm X 96.5cm X 11.4µm  
CÓDIGO: 5104

PAQUETE CON 15 BOLSAS  
CADA UNA CON CAPACIDAD DE  
13 GALONES (49.2 Lts)



MEDIDAS:  
59.7cm X 72.4cm X 11.4µm  
CÓDIGO: 5102

BOLSA PARA BASURA 39 GAL. 18pz  
CON CAPACIDAD DE 39 GALONES  
(147.6 L)



MEDIDAS:  
83.8cm x 104.1cm  
CÓDIGO: 56639

## SWITCH BOTON DUAL



**CÓDIGO: 03361**

BOTON DUAL MECANICO PARA CAMIONES PESADOS ANTIGUOS TIPO FORD, CHEVROLET

## RESISTENCIA DOBLE



**CÓDIGO: EL-401**

## REGULADOR DE VOLTAJE



**CÓDIGO  
E-140-XR**

REGULADOR DE 12 VOLTSSUSTITUYE AL ELECTROMECHANICO DELCO REMY, PARA TODOS LOS ALTERNADORES TIPO CAMPO A TIERRA HASTA 70 amp.

## SWITCH DE ENCENDIDO



**CÓDIGO: 036-056-H5**

SWITCH DE ENCENDIDO PARA CHEVROLET 68-80

## SWITCH DE ENCENDIDO UNIVERSAL



**SWITCH FORD 8591**

**CÓDIGO: 036-047-H5**



## SINCHO FILTRO TRACTOCAMION



CODIGO	DESCRIPCION
0051	Sincho filtro tractocamion estandar

## GEL ABRILLANTADOR PARA LLANTAS



CODIGO

980030

Gel de color azul con esponja, restaurador abrillantador, evita la resequedad de las llantas de los autos, es de alto rendimiento y gran lustre de llantas, defensas plásticas y hules en general

## JUEGO DE LUCES LED



CODIGO	DESCRIPCION	CODIGO	DESCRIPCION
IOL-LHL-108	LUZ LED JUEGO 9005	IOL-LHL-102	LUZ LED JUEGO H4
IOL-LHL-109	LUZ LED JUEGO 9006	IOL-LHL-103	LUZ LED JUEGO H7
IOL-LHL-100	LUZ LED JUEGO H1	IOL-LHL-104	LUZ LED JUEGO H11
IOL-LHL-101	LUZ LED JUEGO H3	IOL-LHL-105	LUZ LED JUEGO H13

# LUZ LED BARRA



CODIGO	DESCRIPCION
IOL-LBLD-135	Barra de 18 pulgadas color claro con sus bases para instalación



CODIGO	DESCRIPCION
IOL-LFL-390	Juego de 2 Barras de 3 pulgadas color claro con sus bases para instalación



CODIGO	DESCRIPCION
IOL-LFL-191	Juego de 2 Barras de 3 pulgadas color claro con sus bases para instalación



CODIGO	DESCRIPCION
IOL-LBLD-123	Barra de 6 pulgadas color claro con sus bases para instalación



CODIGO	DESCRIPCION
IOL-LBLD-017	Barra de 12 pulgadas color ámbar con sus bases para instalación



CODIGO	DESCRIPCION
IOL-LBLD-041	Barra de 24 pulgadas color claro con sus bases para instalación



**Acca Accesorios**

Calle Sinaloa no. 3690 Col. Mexico Tijuana B.C. C.P 22150

**tel.** 6-34-50-38 - 700-0562

**e.mail:** [accesoriosacca@gmail.com](mailto:accesoriosacca@gmail.com)