

PHANTOM JL-JLU-JT Aluminum Tube Doors

EZTRUNK™ ASSEMBLY

— MANUAL —

#1918 0072 #1918 0074

MAKE IT EZ

**Print the latest manual &
Watch the EZTRUNK Video**



**Scan QR CODE for Video &
PDF MANUALS**

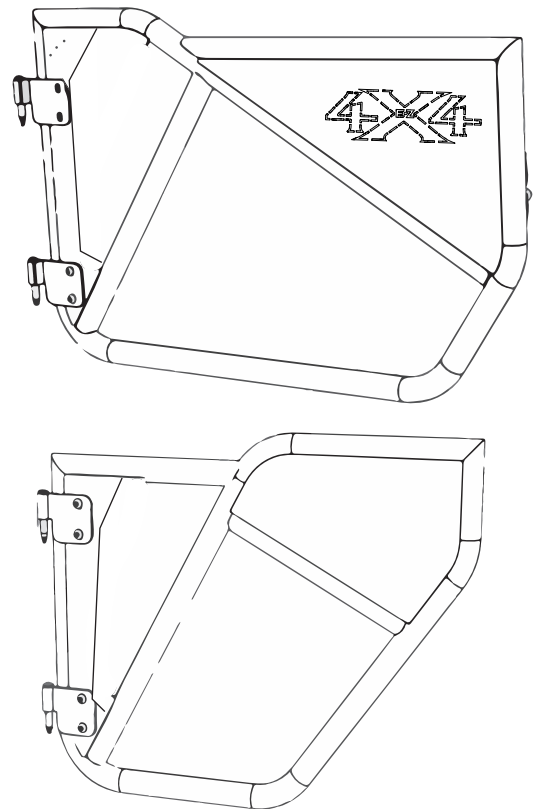

Customer Service

Any question? WE ARE HERE TO HELP!

Text or Call 203-901-0055 / Call 203-591-9060









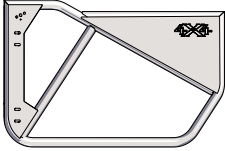
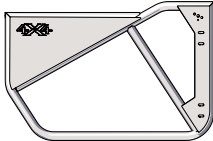
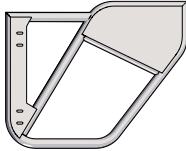
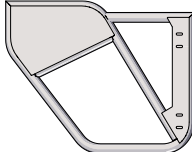
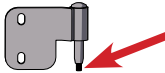

EMAIL US: SERVICE@EZTRUNK.NET

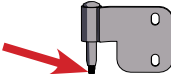
7 days a week 8:30 am EST

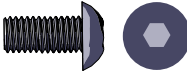
WE CAN HELP YOU!

PO# :

Please read instructions fully before beginning assembly

NO	Illustration	Description	Part#	2Dr QTY. #1918 0072	4Dr QTY #1918 0074
1		Driver / Left Front Door	1918007FD	1	1
2		Passenger / Right Front Door	1918007FP	1	1
3		Driver / Left Rear Door	1918007RD	\	1
4		Passenger / Right Rear Door	1918007RP	\	1
5		Driver Side Long Pin Upper Hinge	800701	1	2
6		Driver Side Short Pin Lower Hinge	800702	1	2
7		Passenger Side Long Pin Upper Hinge	800711	1	2
8		Passenger Side Short Pin Lower Hinge	800712	1	2
9		Hinge Bolt M8x20	28201	8+1 extra	16+1 extra
10		Hinge Lock Nut M8	10082	8+1 extra	16+2 extra
11		Metal Washer	1508012	16+1 extra	32+2 extra
12		Wrench	#13	1	1
13		Allen Wrench #5	#5	1	1
14		Allen Wrench #4	#4	1	1

WARNING This product is intended to provide added “off-road” convenience and utility to your vehicle. This product is not intended to provide occupant containment or protection in the event of an accident or rollover. Further, “on road” use may involve increased risk of serious injury in the event of side-impact accidents. To reduce risk from these types of injuries: Always wear seat belt and shoulder harness for all vehicle occupants. Keep arms and body inside vehicle. Drive safely, read and understand all manufacturers warnings and product instructions before installation. Periodically check and adjust all latches and fasteners, Failure to do so could result in the doors not latching securely.

BEFORE BEGINNING, SEE THE ASSEMBLY INSTRUCTION VIDEO ON EZTRUNK.NET

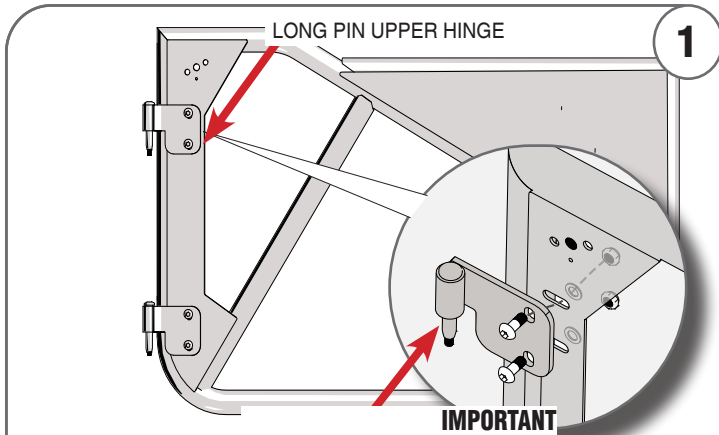

Attach the 2 door hinges to the new door using the 4 supplied M8x20 bolts and hardware. Leave the bolts snug only at this time, **IMPORTANT** Install the longer pin hinge on upper position of door and shorter pin hinge on lower position. The upper hinge with longer pin, which can be used to assist in guiding the door into place.

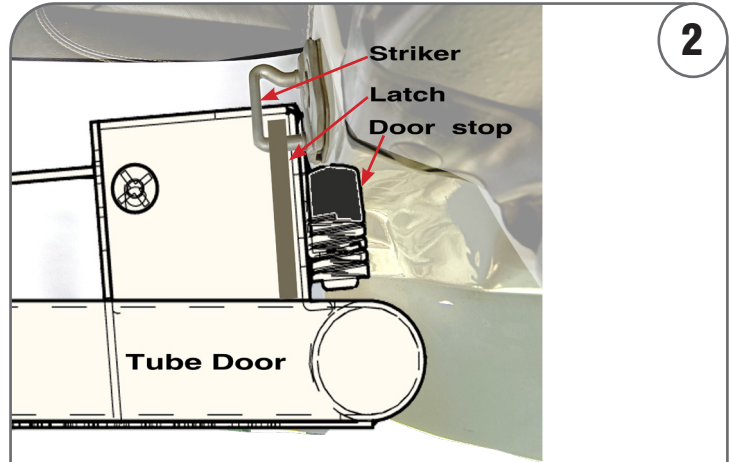

CAUTION ! To avoid risk of injury latch mechanism must be properly adjusted before use. Inspect and adjust as necessary should wear alter alignment of latch and striker. Do not use door/latch if damaged.

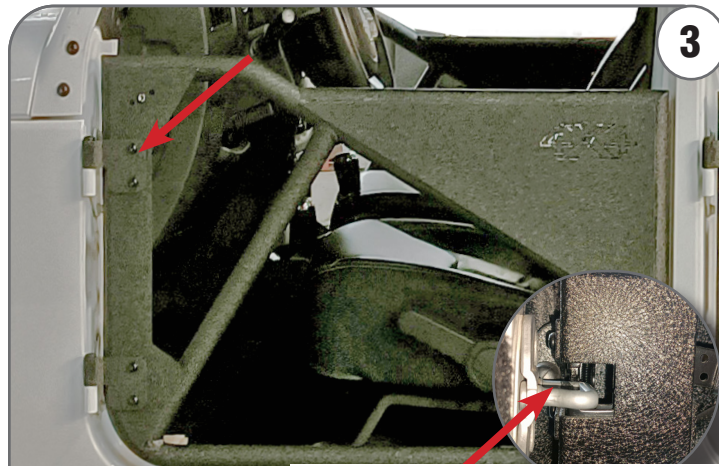

Leave a little space between the Jeep and the lock

With the door closed, loosen the four screws from the hinges (using a #5 allen wrench and #13 open wrench), adjust door 2 directions position as needed and proceed to tightened the screws.



Adjust the rubber stop so the doors do not move when driving. Turn the rubber to adjust. Adjust the 2 screws if needed.



Customer Service

Any question? WE ARE HERE TO HELP!

Text or Call **203-901-0055** / Call **203-591-9060**
EMAIL US: SERVICE@EZTRUNK.NET

7 days a week 8:30 am EST

WE CAN HELP YOU!