

NATIONAL TOWN CLASS
SPECIFICATIONS

PUBLISHED BY THE NATIONAL TOWN CLASS ASSOCIATION

TOWN CLASS

SPECIFICATIONS

CERTIFIED BY
THE NATIONAL TOWN CLASS ASSOCIATION

ISSUE #5

with revisions of
July 2000 (updated February 2004)

Specifications Committee

Brooks Corl, President
NTCA

Robert Cusack
Nahant Fleet

Bryn Evans, Secr./Treas.
NTCA

Tom Sadler
Touisset Fleet

Rex Antrim, Chairman
Specifications Committee

John Russell
Marblehead Fleet

Ralph F. Johnson, Jr.
Town class Builder

2004 Specifications Committee

Tom Sadler (Specs Committee Chmn.)

Peter Shaw (President – NTCA)

Rex Antrim (Nahant Fleet)

John Russell (Marblehead Fleet)

Matt Manlove (Touisset Fleet)

LOA 16½ FT.
BEAM 5'9"
DRAFT 7" CB UP
28" CB DOWN
SAIL AREA 152 SQ. FT.

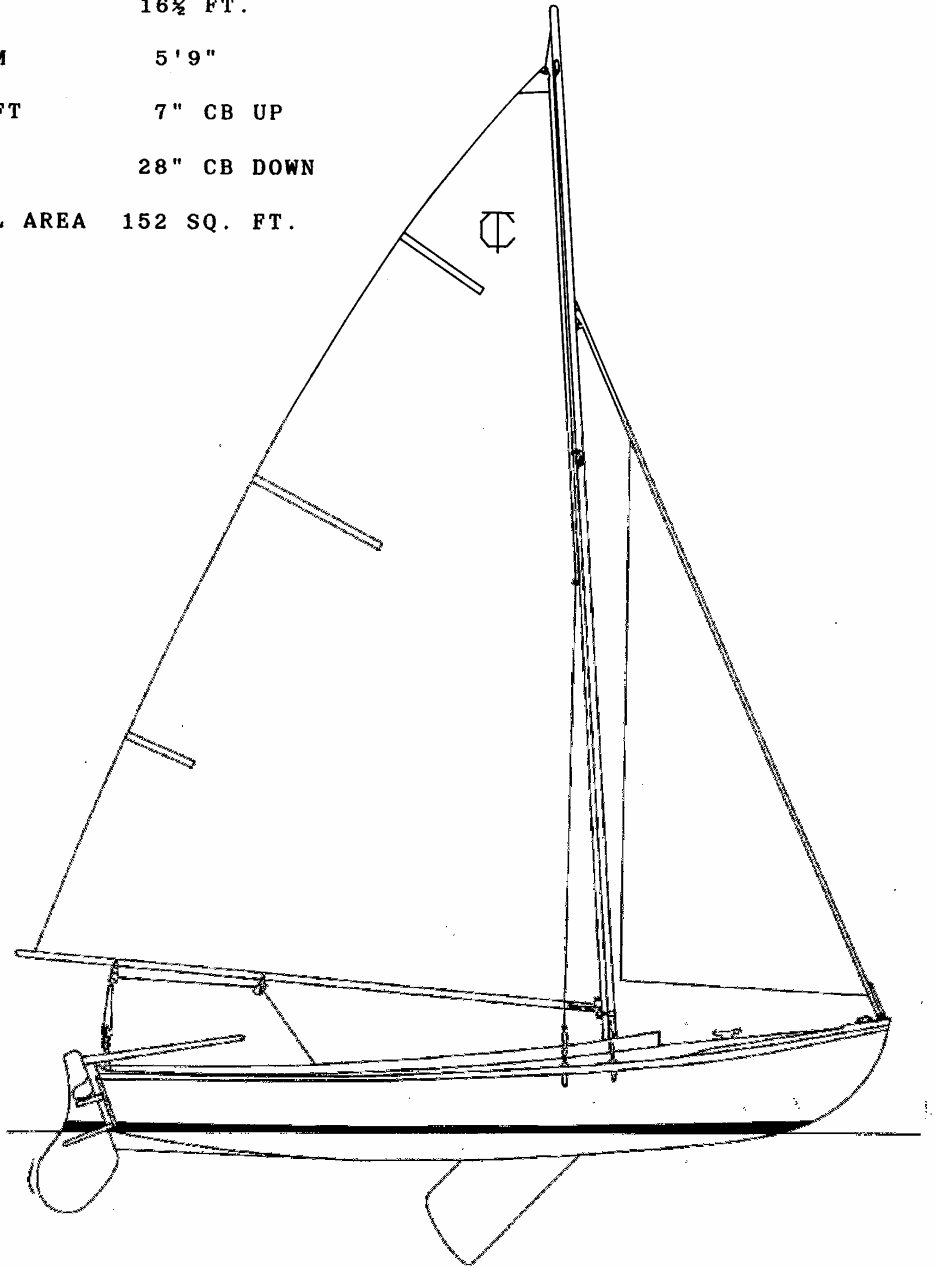

TOWN CLASS SLOOP

TOWN CLASS SPECIFICATIONS

ARTICLE I – GENERAL NOTES:

- A. These specifications describe the construction of the Town Class Sloop and must be adhered to. The Association will refuse to certify any yacht which does not conform to the Official Town Class Plans and Specifications. New boats must be certified prior to racing.
- B. Options – All materials must be as specified and dimensions as indicated except where otherwise stated. Nothing is optional in these specifications unless so noted in the article and then only within the limits described.
- C. Rulings – Specifications are to be used in conjunction with the Official Town Class plans. Where any point of difference exists, the specifications as written shall be final, and not the pictured description as shown on the Plans. Specifications, however complete, cannot anticipate every possible situation that may arise. If a point is not covered herein, or governed by the dictates of common sense, a ruling must be obtained from the Specifications Committee. In interpreting any point not covered or wording of obscure meaning, the Specifications Committee shall consider the intended meaning rather than any technical misconstruction that might be derived from the wording, and shall bear in mind at all times the basic principles of the specifications which are to maintain the Town Class as a one-design class.
- D. All boats must be built by the registered builder. Any boat whose origin cannot be proven will be subject to approval by the Specifications Committee.

ARTICLE II – GENERAL:

- A. Materials of Construction – The boat and all its parts, except as otherwise specified, shall be constructed of wood and/or resin and synthetic cloth, mat or roving.
- B. All dimensions given in these Specifications are nominal; tolerances are as interpreted by the builder. Any variances from the measurements are subject to review by the specifications Committee.

ARTICLE III – HULL:

- A. The nominal dimensions are:
 - 1. Length overall: 16' – 6"
 - 2. Beam: 5' – 9 ½ "
 - 3. Freeboard: 1' – 9"
 - 4. Draft: 0' – 7"

ARTICLE III – HULL (CONTINUED):

B. Detailed specifications of the wood hull are as follows:

1. Lapstrake wood planking 5/8" thick
2. Bottom wood planking 7/8" thick
3. Wood ribs ½" by 1" (optional)
4. Wood frames 7/8"
5. Wood decking 5/8" thick planking or ½" plywood, covering optional

C. Detailed specifications of the fiberglass hull are as follows:

1. Basic hull laminate:

Gel Coat – 20 mils thick

1 ¾ oz Mat

2 oz. Mat

2 24 oz. Woven Roving

1 2 oz. Mat

Lap depression filled with strand roving

To be laid up by hand in single ply

Resin: Reichold Chemical Co., Polyester No. 8001 or equal.

2. Flotation:

Flotation material tapered from 0" to 3" full length of the hull from top of the seats to hull sheer is mandatory. A 1" flotation material plank laid beneath the last two layers of mat, in the hull bottom, from chine to chine, bottom of stem to stern is optional. Should the flotation material plank be removed for any reason, replacement must be in one of two ways:

(a) A 1" flotation material plank laid beneath two layers of 2-oz. Mat in the hull bottom, from chine to chine, bottom of stem to stern;

or

(b) The addition of two layers of 2-oz. Mat in the hull bottom, from chine to chine, bottom of stem to stern.

3. All exposed mat surfaces to be rolled smooth without voids, wrinkles, irregular surfaces; these exposed surfaces to be impregnated with resin.

4. Deck laminate:

Gel coat to a thickness of 20 mils

1 ¾ oz. Mat

1 2 oz. Mat

1 24 oz. Roving

1 2 oz. Mat

1 24 oz. Roving

ARTICLE III – HULL (CONTINUED):

1 $\frac{3}{4}$ oz. Mat
deck frames (optional)

To be hand laid in single ply

Deck to be bonded to hull, using an acceptable mastic, and mechanically fastened to produce a water tight seam.

5. Seat risers and brackets to be encapsulated and attached to hull with two ply of 2 oz. Mat.
- D. Variations in weight are evident in new wood, old wood, fiberglass covered wood, and fiberglass boats in the same basic condition and built to the official plans. The racing weight, including hull, mast, boom, tiller, rudder, centerboard, all floorboards (wooden hull only), running and standard rigging, halyards, and one whisker pole; shall not be less than 750 pounds. Ballast must be added to an underweight boat to bring it to this minimum weight. Ballast may not be moved once a race has begun.
 - E. The entire hull or any part may be covered by the application of resin and synthetic cloth. Such must not be applied, however, in a manner designed to alter the basic shape of the hull.
 - F. The skeg shall be as shown in Figure 1 in this appendix and must measure no more than 5' 0" long, and no more than 7" deep at the after end and not greater than 1" maximum depth at the forward end.
 - G. For further hull dimensions, see the Official Town Class plans.

ARTICLE IV – CENTERBOARD, CENTERBOARD PIN, AND TRUNK:

- A. Centerboard – to be $\frac{3}{16}$ " thick, minimum of 45 pounds, maximum weight of 55 pounds. No projections or appendages allowed. Edges may be feathered. Other dimensions as in Figure 10 in this appendix.
- B. Centerboard Pin – Must not be greater than $\frac{3}{4}$ " in diameter. Washers not greater than $\frac{1}{2}$ " in diameter permitted on the pin inside the trunk. Pin must be located in the trunk as shown on the Plans.
- C. Centerboard trunk – The use of a gasket in or at the bottom of the centerboard trunk well is not permitted. However, the sides of the centerboard slot may be reinforced by angle from plates or pieces running lengthwise on either side. The width of the opening shall be not less than $\frac{1}{2}$ " nor more than 1". The slot must be substantially parallel for its entire length.
- D. The leading edge of the centerboard shall not be carried forward of vertical when racing.

ARTICLE V – COCKPIT, SEATS, FLOORBOARDS, ETC.:

- A. Cockpit – Must be of the size and shape as shown on the Plans.
- B. Seats – Must be as shown in the Plans. Removal of one full length slat from port and starboard seats to facilitate hiking is optional.
- C. Floorboards in Wooden Hulls – Must be of wood at least ½” thick as installed by builder, not including addition of cork or other nonskid material. Floorboards must not be removed for racing. Floorboards are not mandatory in fiberglass hulls.
- D. Lockers, Shelves and Drawers – May be installed.

ARTICLE VI – MAST STEP:

- A. Mast Step – The position may be changed for the purpose of better boat balance. Position of the mast step must not be altered while racing.
- B. Slotted Mast Steps – Must be fixed fore and aft.

ARTICLE VII – SPARS:

- A. Mast – To be rectangular wood as shown in the Plans and is subject to review of the Specifications Committee. Length 24’ 0”. Maximum height above deck 22’ 0”. Sails must be attached to the mast with 5/8” track and slides. A rotating mast is prohibited. A pair of bands shall be painted around the mast. They shall be 1” wide and their color shall contrast with that of the mast, preferably black on light colored spars and white on dark colored ones. The outer edges of a pair of bands shall be located 19’ 8” apart. If desired, additional pairs of bands may be used. The sail must be located within one pair of bands while racing.
- B. Boom – Must be solid rectangular wood as shown in Plans and is subject to review by the Specifications Committee. Cross section 2” by 1-5/8”, with tolerance of [+0” / -3/16”]. Foot of sail must fasten in a straight line in both plan and profile. No arched or curved tracks are allowed and no transverse movement is permissible in the foot of the sail. The sail must be attached to the boom with track and slides as on the mast spaced no greater than 18” apart. One band must be painted around the boom located 11’ 8” aft of the adjustment hole in the gooseneck which is used in racing. Boom vang may be used.
- C. Whisker Pole – Maximum overall length permitted is 7’ 0”. When in use it must be seated home against the mast. It cannot be held at one end by the crew. Fittings are optional. Telescoping poles must have an overall 7’ 0” limit.

ARTICLE VIII – RIGGING AND RIGGING FITTINGS:

- A. Rigging – Specifications of the rigging and rigging fittings are as follows:
1. The standing rigging will consist of one (1) fore stay, two (2) shrouds and two (2) lower back stays, all permanently attached.
 2. Stay and shroud length will be as shown on plans except the length can be changed to accommodate location of mast step, mast tangs, chain plates, and spreader length.
 3. The position of the attachment to the mast will be as specified on plans, plus or minus 1”.
 4. The length of stays and shrouds will not be changed during a race.
 5. All rigging will be stranded wire rope with a minimum breaking strength of 2,200 lbs.
- B. Spreaders – To be shown on plans as to position, length and diameter. Use of either hinged or fixed spreaders is permitted.

ARTICLE IX – HULL FITTINGS:

- A. The actual pattern is optional. However, they should equal or serve the purpose of those shown on the Plans.
- B. Chain Plates – Specifications are as follows:
1. Shrouds and back stays must be fixed to permanently located chain plates.
 2. The position of these may be chosen to achieve proper boat balance. The use of a bar attached to the chain plates in lieu of moving the chain plates is permitted.
 3. The forward shroud attachment at deck level shall not be forward of the center line of the mast with the fore stay taut.
 4. The distance between the back stay hole and the shroud hole in the shroud attachment shall be 12” minimum.
 5. The attachment of the fore stay will be as specified on the Plans and not be forward of the bow.
- C. Jib Sheet – Multiple jib leads to a track are permitted.
- D. Hiking Gear – Must be fastened to the hull only and no part of any hiking arrangement except the tiller extension shall extend or be carried outside the sheer line of the boat or above the deck level. Hiking from halyards or any trapeze is not permitted.
- E. Boom Traveler – A rope or wire traveler may be substituted for the regulation rigid traveler and any traveler may extend to the outer edge of the hull at the transom.

ARTICLE IX – HULL FITTINGS (CONTINUED):

- F. Midship traveler or similar device is not allowed.

ARTICLE X – RUDDER AND TILLER:

- A. Rudder – To be made of wood, or wood covered by resin and synthetic cloth, or completely of resin and synthetic cloth, or part metal and any combination of the above according to the dimensions set forth in the Plans. Rudders must be carried in the extreme downward position when racing.
- B. Kick-up rudders and “high aspect ratio” rudders are not allowed.
- C. Tiller – Dimensions are optional. Tiller extensions may be used.

ARTICLE XI – SAIL SPECIFICATIONS:

Sails made prior to January 1972 should be measured against the specifications contained in Issue 2 of the National Town Class Association Specifications, dated September 1970. In the interest of encouraging sailing in National Town Class regattas, all mainsails and jibs purchased prior to August 9, 1992 and meeting NTCA Specifications, Issue 4 or Issue 4 with 1991/92 Amendments will be grandfathered for use in future Town Class national regattas.

A. Definitions:

1. Mainsail – See Figure 2 in this appendix.

- a. Peak point – The peak point is the point of intersection of the uppermost portion of the headboard or sail and the luff or the luff extension. (See Figure 3 in this appendix.)
- b. Tack point – The tack point is the point of intersection of the actual foot and luff, or if rounded, the point of intersection of the actual foot and luff extensions.
- c. Clew point – The clew point is the point of intersection of the actual foot and leech, or, if rounded, the point of intersection of the actual foot and leech extensions.
- d. Luff line – the luff line is the line drawn from the peak point to the tack point.
- e. Leech line – the leech line is the line drawn from the peak point to the clew point.
- f. Foot line – The foot line is the line drawn from the tack point to the clew point.
- g. Cunningham – The cunningham is a required eye in the luff line of the sail no more than 12” above the tack point and no more than 2” from the edge of the sailcloth.

ARTICLE XI – SAIL SPECIFICATIONS (CONTINUED):

B. General:

No sails other than the standard mainsail and jib are allowed. The mainsail shall be attached to both spars with sail slides on 5/8” track. Windows of transparent material may be inserted in either sail. The jib window shall not exceed three square feet and the mainsail window shall not exceed five square feet.

The jib must be attached to the forestay when racing; however, the method of attachment may be either piston hanks or snap straps. Adjustable luff jibs are allowed. The jib luff shall not be reinforced with wire.

C. Weight and type of Cloth:

The mainsail and jib shall be made of synthetic woven fabric ~~other than yarn tempered~~ not lighter than 4.0 ~~and not heavier than 5.0~~ ounces per linear yard 28 ½” wide. (Feb 04)

D. Battens:

1. Mainsail – There shall be no more than four (4) equally spaced battens in the mainsail leech and their length shall not exceed 36”.
2. Jib – There shall be no more than three (3) equally spaced battens in the jib leech. Batten length shall not exceed 14”.

E. Measurements:

1. Tension – All measurements are to be taken with the sail lying flat with all wrinkles removed in the area of the dimension being taken. Any bungee cords or other elastic shortening devices shall be stretched to the extent allowed by the actual sail material, without stretching the sail material itself.
2. Mainsail dimensions – See Figure 2 in this appendix.
 - a. Luff – The distance from the tack point to the peak point shall not exceed 19’ 8”.
 - b. Foot – the distance from the tack point to the clew point shall not exceed 11’ 8”.
 - c. Leech – the distance from the clew point to the peak point shall not exceed 22’ 0”.
 - d. Girth – The girth of the mainsail is defined at two locations, the midpoints and quarter-points from the peak. See Figure 2. The midpoint girth is the length of a line joining the midpoints of the actual luff and leech between the peak point and tack point and clew point, respectively. This length shall not exceed 7’ 3”.

ARTICLE XI – SAIL SPECIFICATIONS (CONTINUED):

This page was revised and updated 2/2004

- e. Quarter Point - The quarter point is the length of a line joining points on the actual luff and leech that are half-way between the peak point and the midpoint measurement points. This length shall not exceed 4' 0".

For measurement purposes, the midpoint* of the actual luff can be obtained by folding the sail so that the tack and peak points are together and marking the position of the fold on the luff. The midpoint* of the leech is obtained similarly by putting the clew point and peak point together and marking the fold. The quarter-points* are obtained by making a second fold with the peak point and midpoints together. For sailmaking purposes, the "actual" points on the luff and leech are defined as being on lines drawn perpendicularly to the luff and leech lines through the midpoints and quarterpoints on these lines. See figure 2.

- f. Headboard – the headboard can not exceed 4 inches in width at the peak and must be placed to the edge of the sailcloth at the luff.

3. Jib (See Figures 4, 5, 6 and 7 in this appendix.)

- a. Luff – the length of the luff, measured between the extremities of the cloth on the luff and excluding eyes and bindings that project beyond the cloth, shall not exceed 12' 8" nor be less than 12' 4". If the luff of the sail is cut back at the lower extremity, the measurement shall be made to the intersection of the projection of the foot line (See 3b) and the projection of the leading edge of the luff. This measurement shall be made with the luff tensioned so that all wrinkles are removed.
- b. Foot – the length of the foot shall be measured along a line, defined as the foot line, from the forward lower extremity of the cloth on the luff (or the equivalent intersection point if the lower luff edge is cut back) to the clew point. The distance shall not exceed 5' 2".
- c. Leech – the length of the leech shall be measured along a line, defined as the leech line, from the forward upper extremity* of the cloth on the luff to the clew point. The distance from the forward edge of the cloth to the extreme lower edge* of the cloth at the clew shall not exceed 11' 4".
- d. Girth – the midpoint girth shall be determined as follows: the midpoint* of the luff shall be determined by folding the sail until the forward extremity of the cloth at the upper end of the luff is even with the forward extremity of the cloth at the lower end of the luff. The midpoint* of the leech shall be determined by folding the sail until the forward extremity of the cloth at the upper end of the luff is even with the lower extremity of the cloth as marked at the end of the leech line. The distance ___ between these midpoints, with the sail tensioned just sufficiently to remove wrinkles shall not exceed 3' 1".

ARTICLE XI – SAIL SPECIFICATIONS (CONTINUED):

- e. Leech Shape – The shape of the leech should be a smooth curve of as near constant radius as possible through the aft end of the battens and the measurement points at the peak and the clew. Straightness between battens is permissible.
 - f. Skirt – the perpendicular distance from the midpoint of the foot length as defined in 3b to the extremity of the sailcloth shall not exceed 5 ½”. The midpoint of the foot length shall be determined as follows: Tension the sailcloth between tack and clew until it forms a hard line. Mark the midpoint* on this line, release the tension, smooth out wrinkles, and measure from this mark to the extremity of the sail.
 - g. Foot Shape – The actual shape of the foot shall be a curve of as near constant radius as possible through the extremity of the batten (if any) and the measurement points at the clew and tack.
 - h. Location of Clew Grommet – The clew grommet shall be located such that the minimum distance from its center to the edge of the sail is not greater than 1 ¼”.
4. Certification of Sails – All sails used for racing shall have been measured by the Official Fleet Measurer and shall carry his initials and the date of measurement in indelible ink. Unless previously marked otherwise, these initials and date should be in the close vicinity of the tack points of the main and jib.

It is not required that sails be measured each year. Sails carrying initials and date of measurement shall be acceptable indefinitely without further measurement unless changes have been made, in which case remeasurement and certification is required.

Figures Attached:

Figures 1-7 and Figure 10, all Specification Drawings, are an integral part of these Specifications. Figures 8 and 9 have been intentionally omitted as they were obsolete.

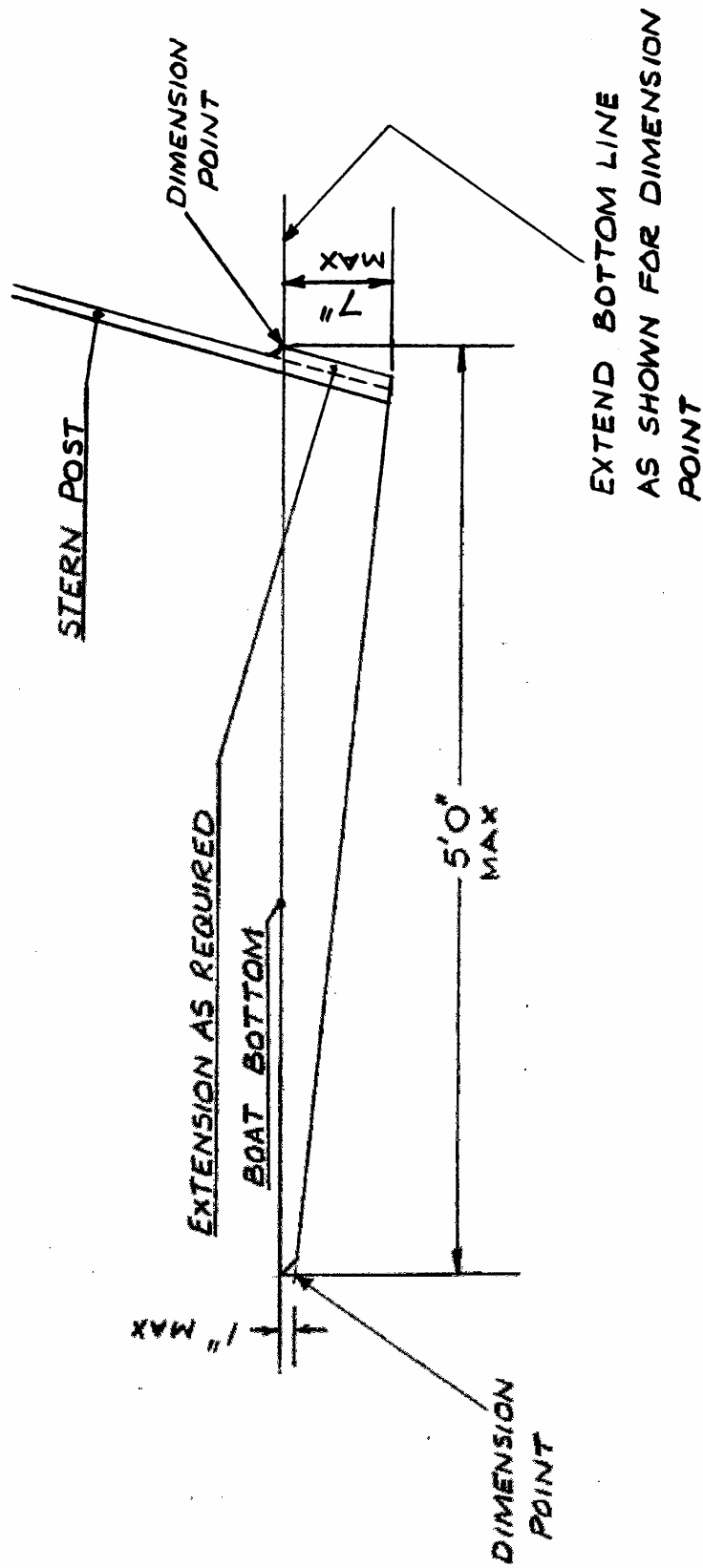

TOWN CLASS - SKEG DIMENSIONS

Fig. 1
Issue 4

TOWN CLASS MAINSAIL

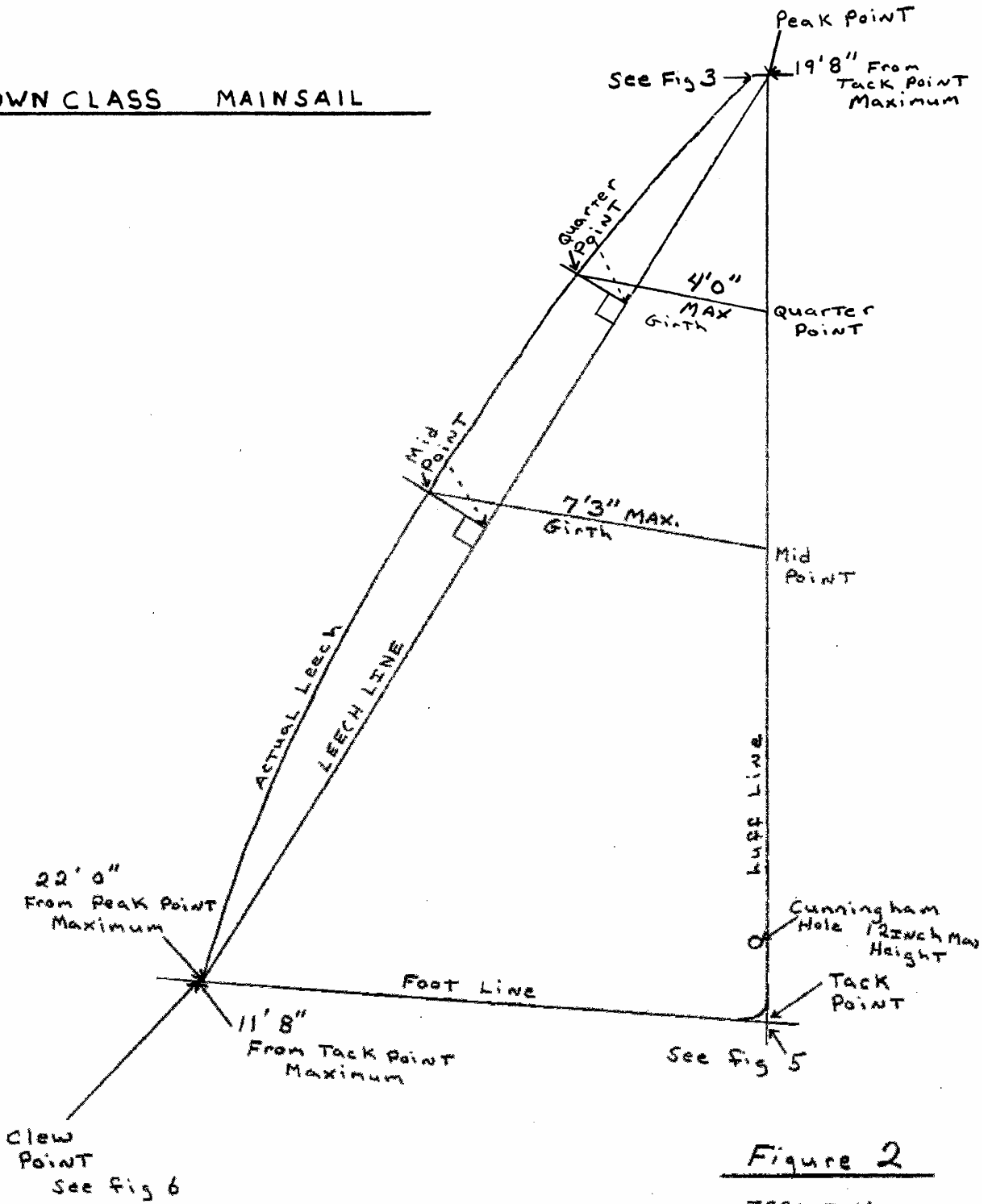
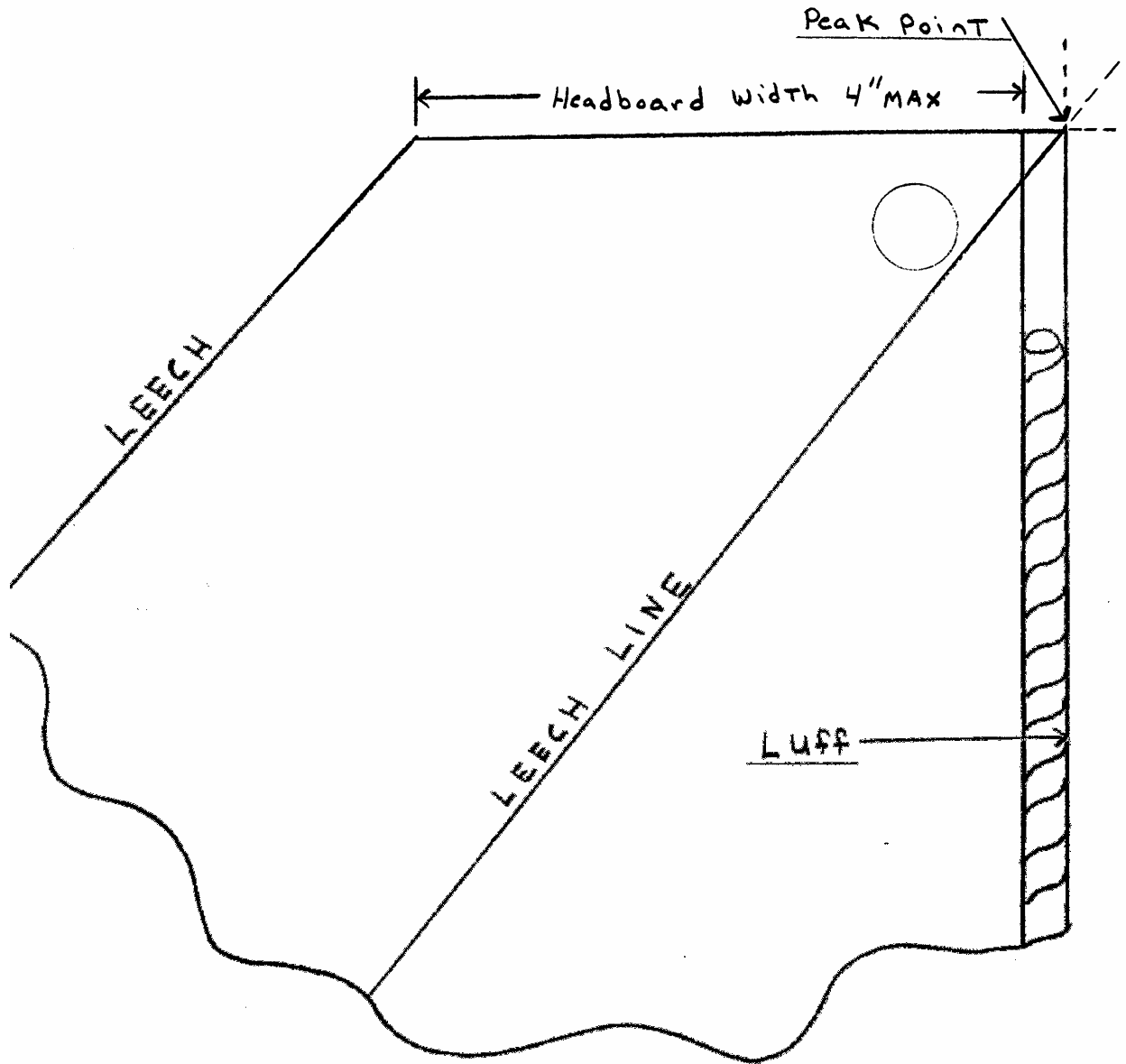

Figure 2

ISSUE 4
April 1987
NOT TO SCALE

This page was revised and updated 2/2004

TOWN CLASS



MAIN PEAK POINT

Figure 3
Issue 4
April 1987
Not to Scale

TOWN CLASS J1B

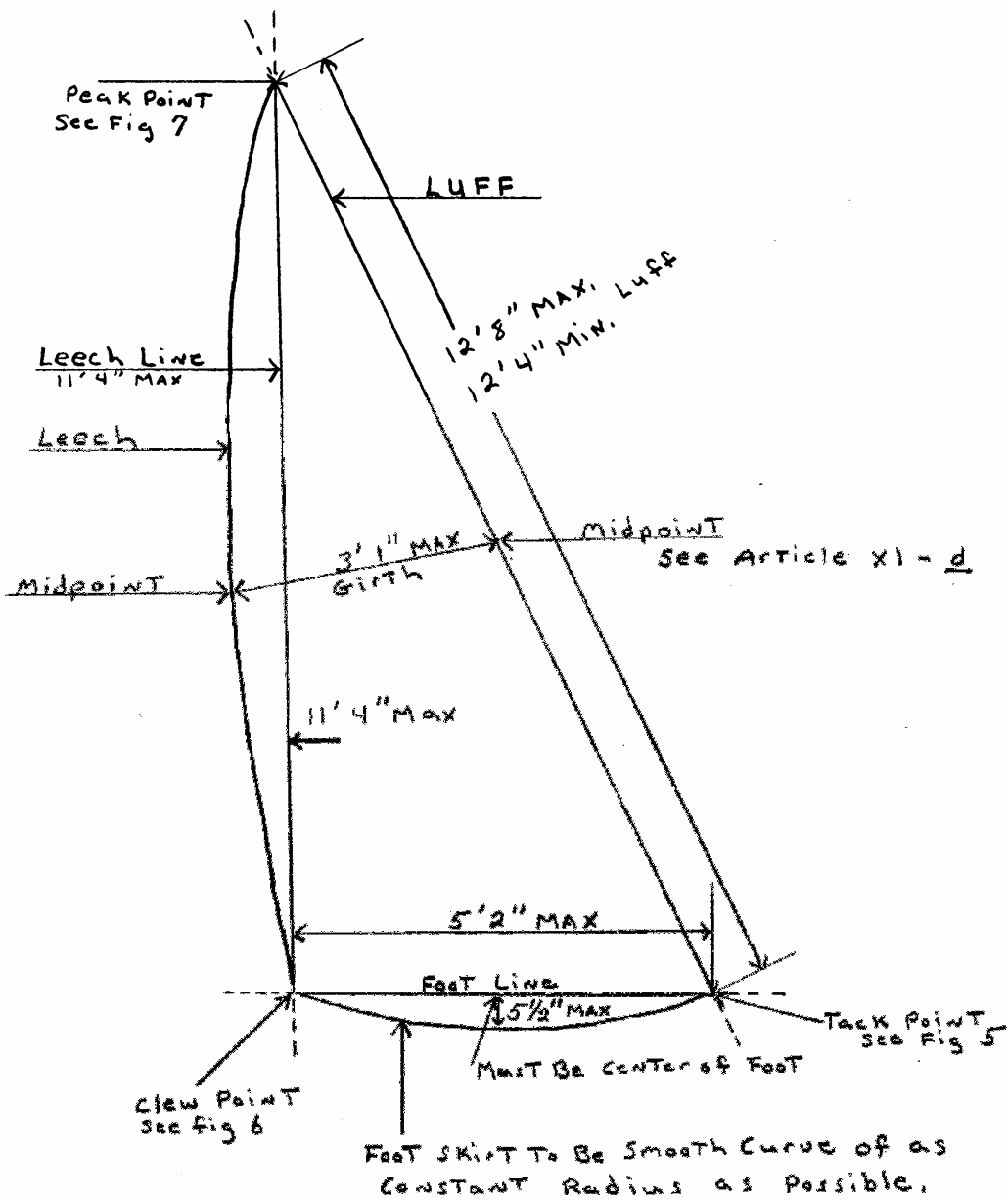
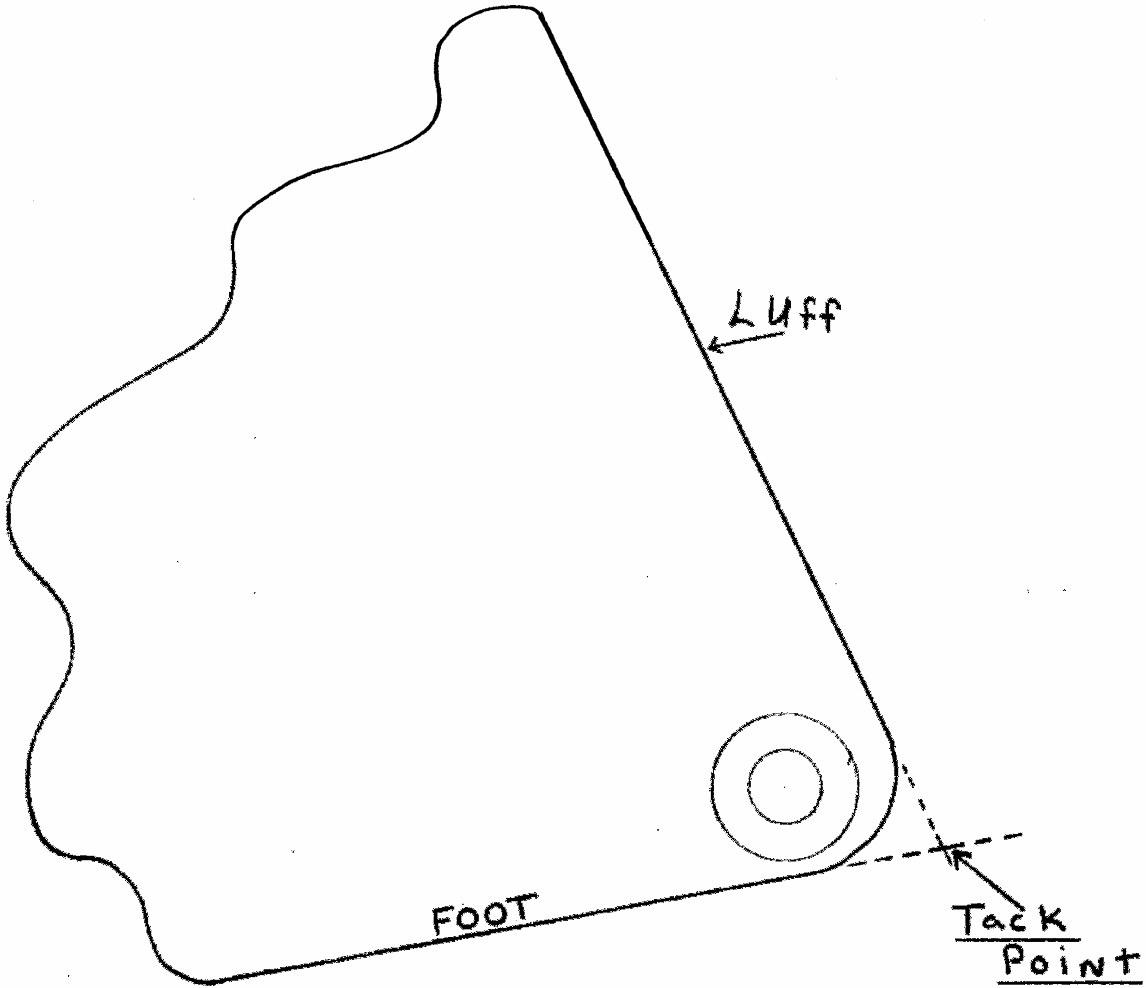

Figure 4
Issue 4
April 1987
NOT TO SCALE

TOWN CLASS



TACK POINT

Figure 5
Issue 4
April 1987
Not To Scale

TOWN CLASS

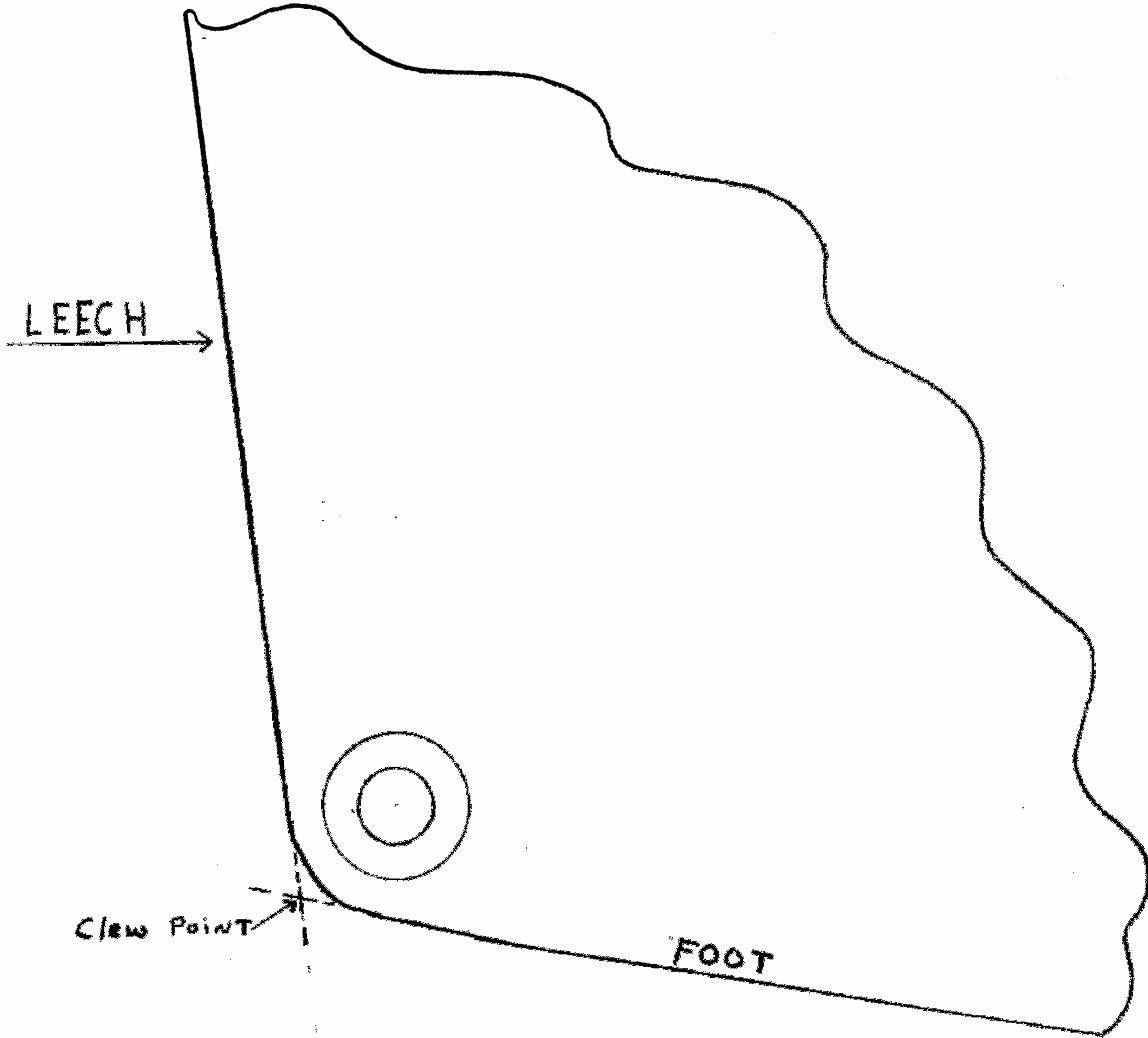

CLEW POINT

Figure 6

Issue 4

April 1987

NOT TO SCALE

TOWN CLASS

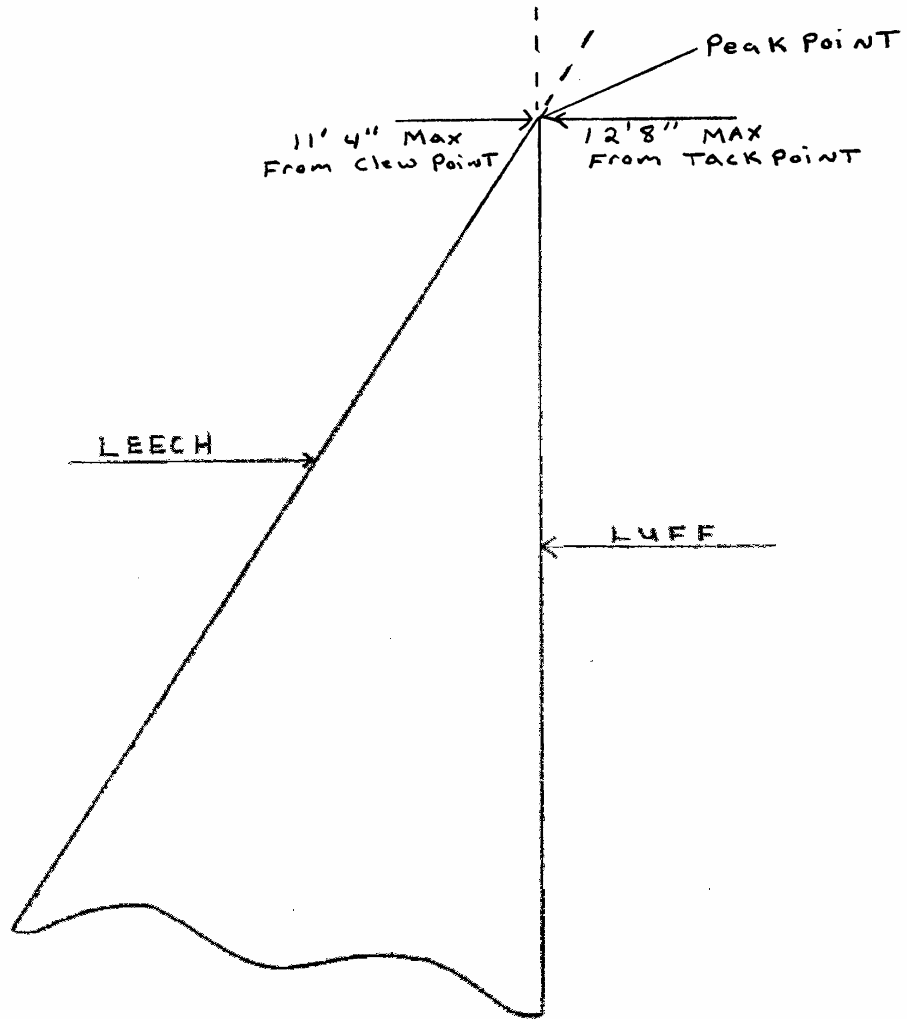

JIB PEAK POINT

Figure 7
Issue 4
April 1987
NOT TO SCALE

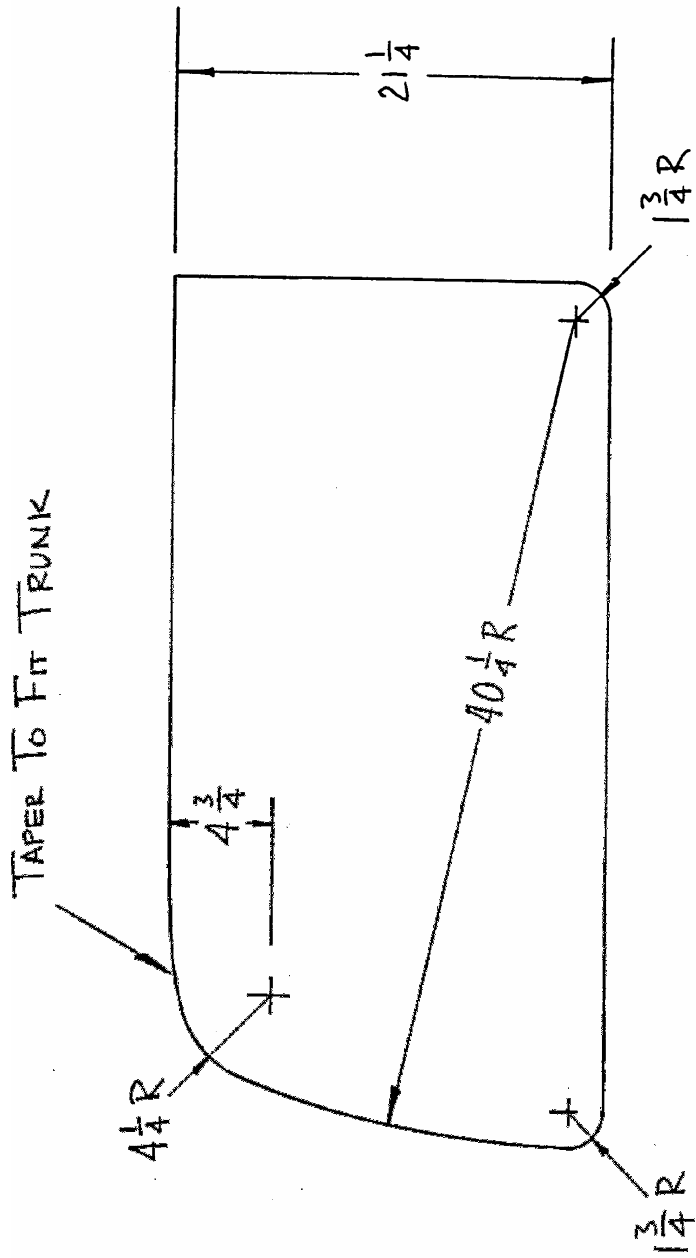

TOWN CLASS CENTERBOARD

MATERIAL: OPTIONAL $\frac{3}{16}$ THICK
 WEIGHT: 45 lbs MIN 55 lbs MAX

FIG 10.
 ISSUE 4