

**PERC**

1

"PER9" 6

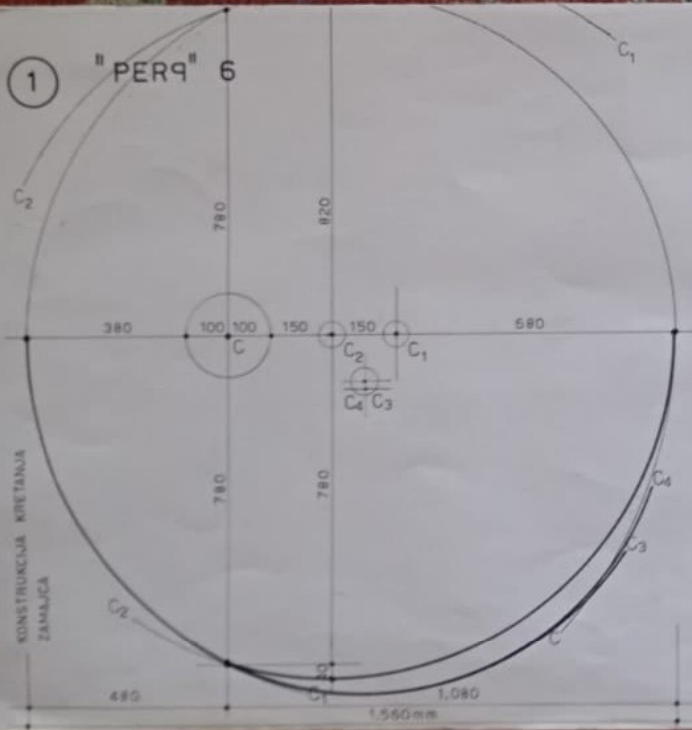

KRETANJE ZAMAJCA

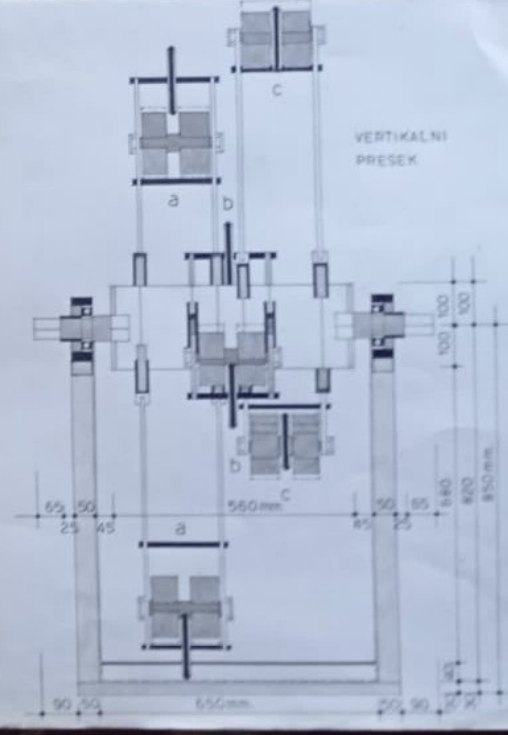
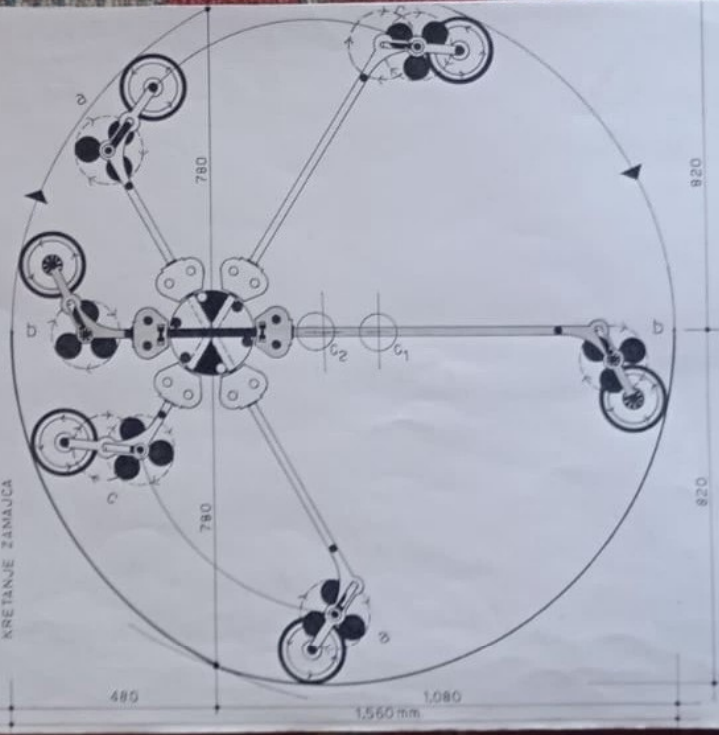

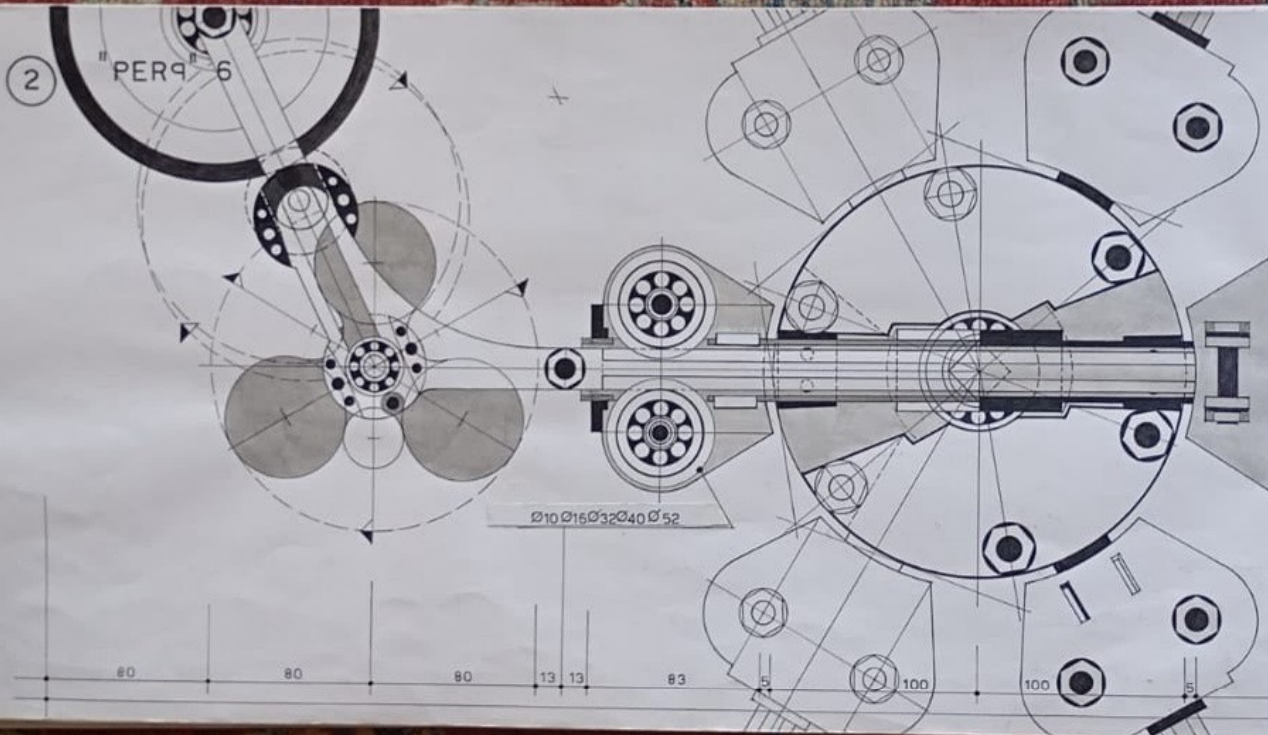

VERTIKALNI PRESEK / PRVOG DELA / KRAKA

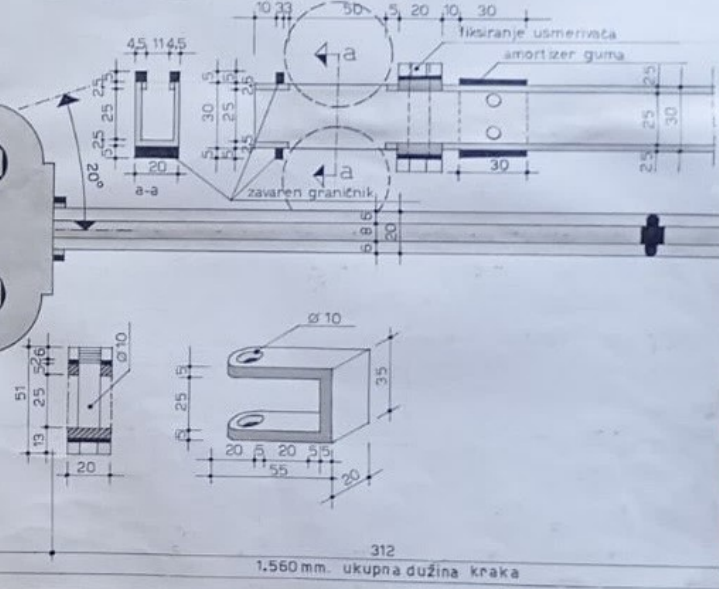

3

"PER9" 6

VERTIKALNI PRESEK / DRUGOG DELA / KRAKA

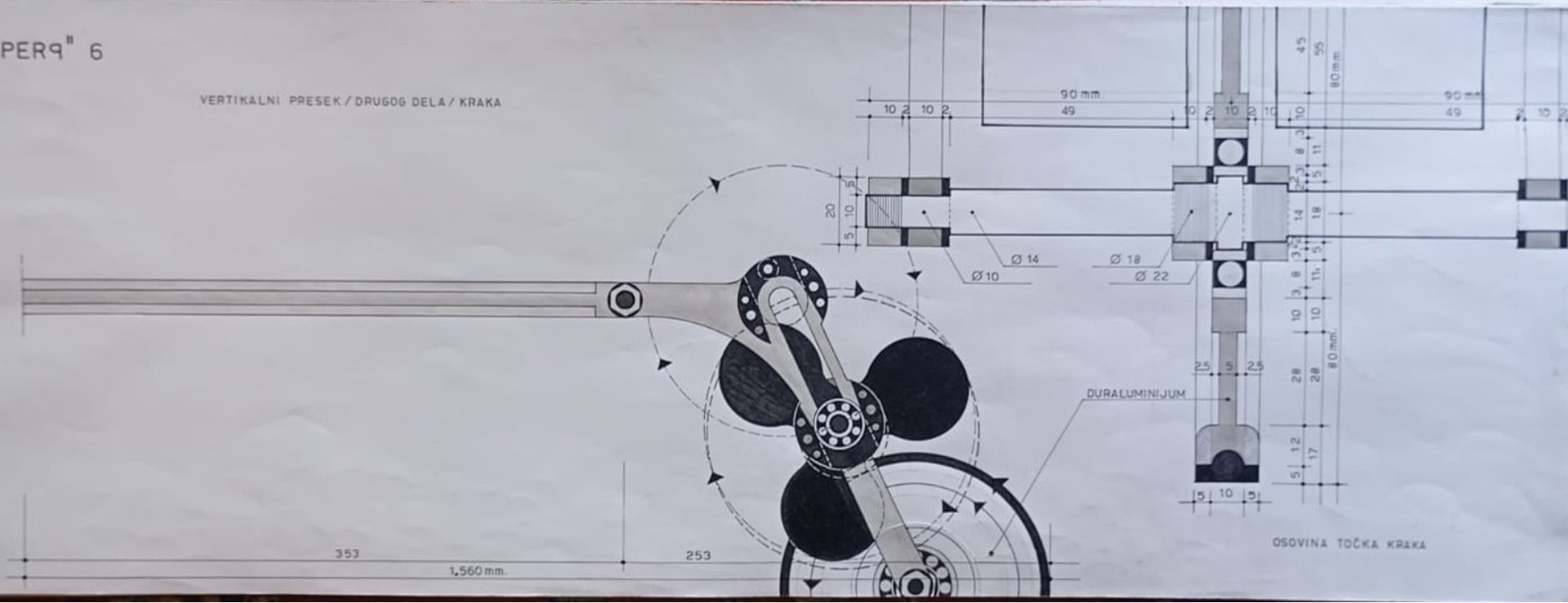

DURALUMINIJUM

OSOVIINA TOČKA KRAKA



4

"PERQ" 6

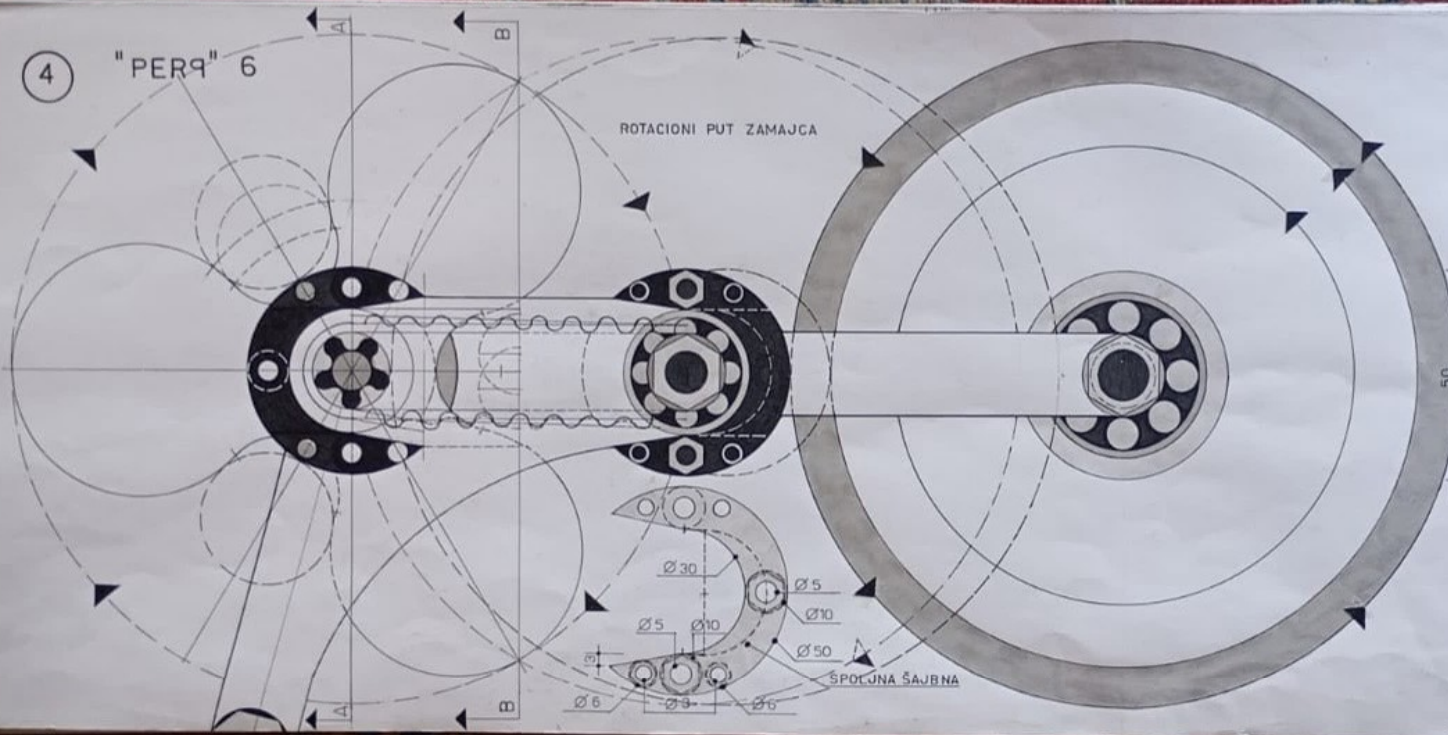

PRESEK A-A

SPOJNA ŠAJBNA 2mm

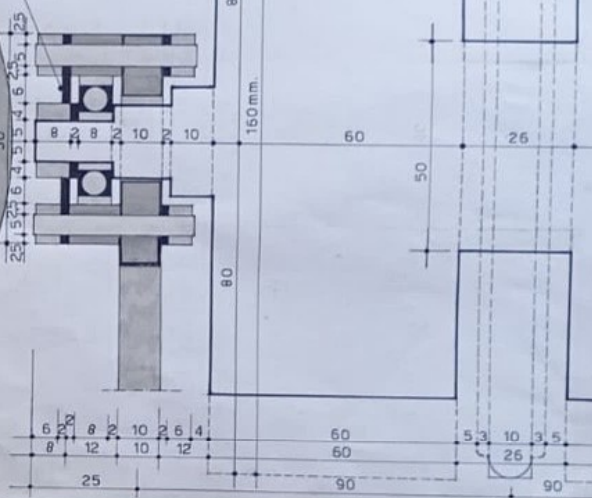

5

# "PERA" 6

ČELIČNA OSOVINA  $\varnothing 60$   $\varnothing 200$

CENTRALNA OSOVINA

DUR ALUMINIJUM

- LAGER  $\varnothing 50$   $\varnothing 100$
- LEŽIŠTE LAG.  $\varnothing 100$
- ŠAJBNA  $\varnothing 50$   $\varnothing 50$
- ŠRAF  $\varnothing 5$
- OSOVINA  $\varnothing 50$

AMORTIZER GUMA

$\varnothing 16$

ŠAJBNA  $\varnothing 16$   $\varnothing 50$

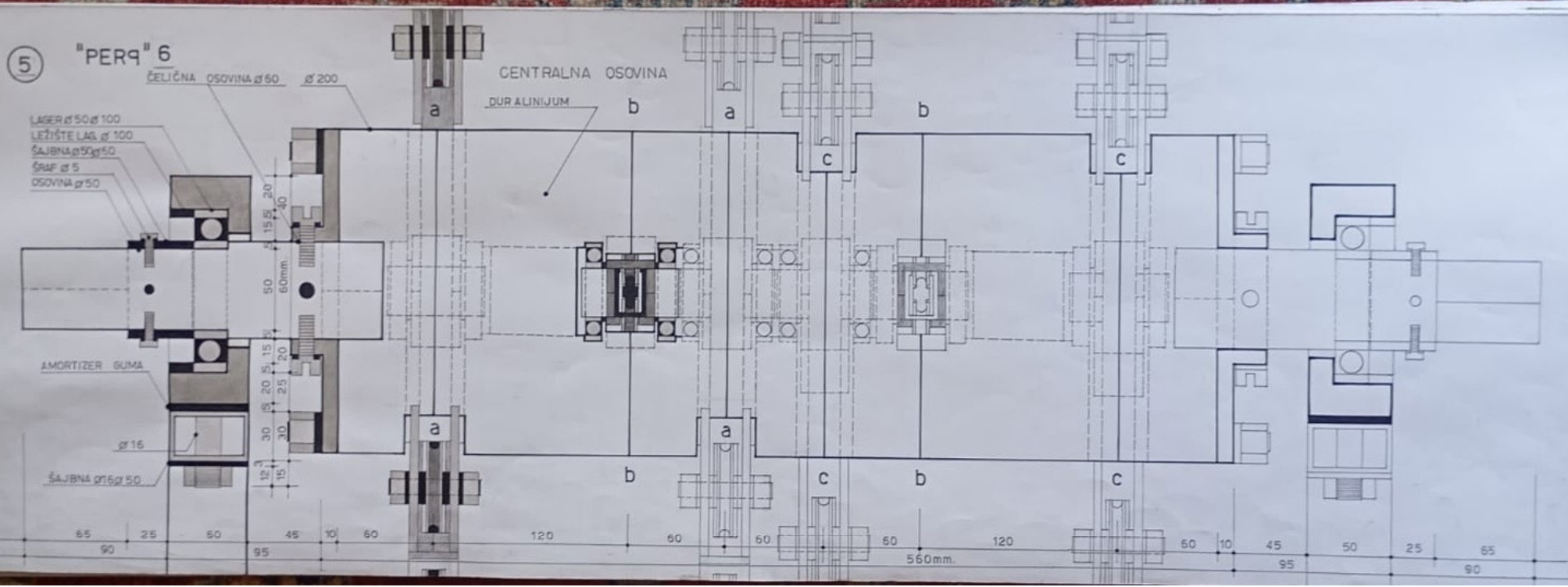

6 " PER9 " 6

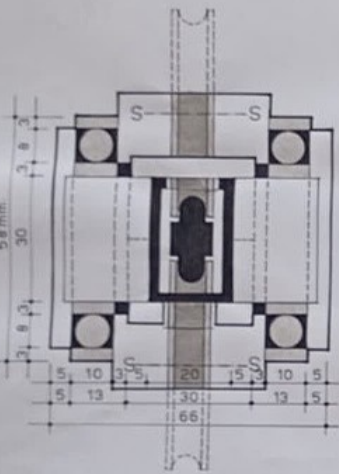

ČEONI PRESEK KLIZNO - ROTIRAJUĆE OSOVINE

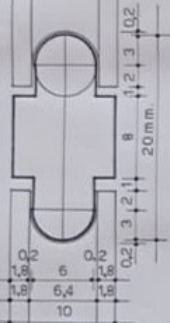

BOČNI IZGLED I PRESEK KLIZNO - ROTIRAJUĆE OSOVINE

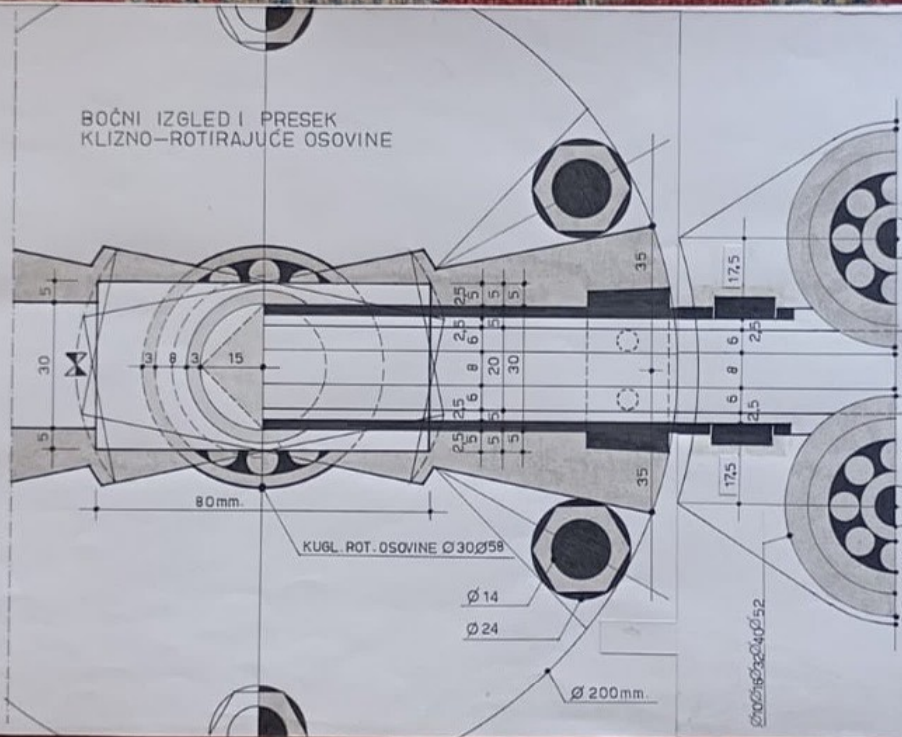

HORIZONTALNI IZGLED I PRESEK KLIZ. ROT. OSOVINE

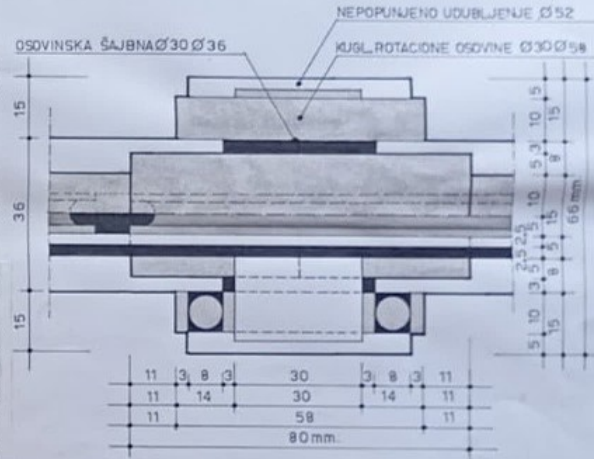



7

"PERQ" 6

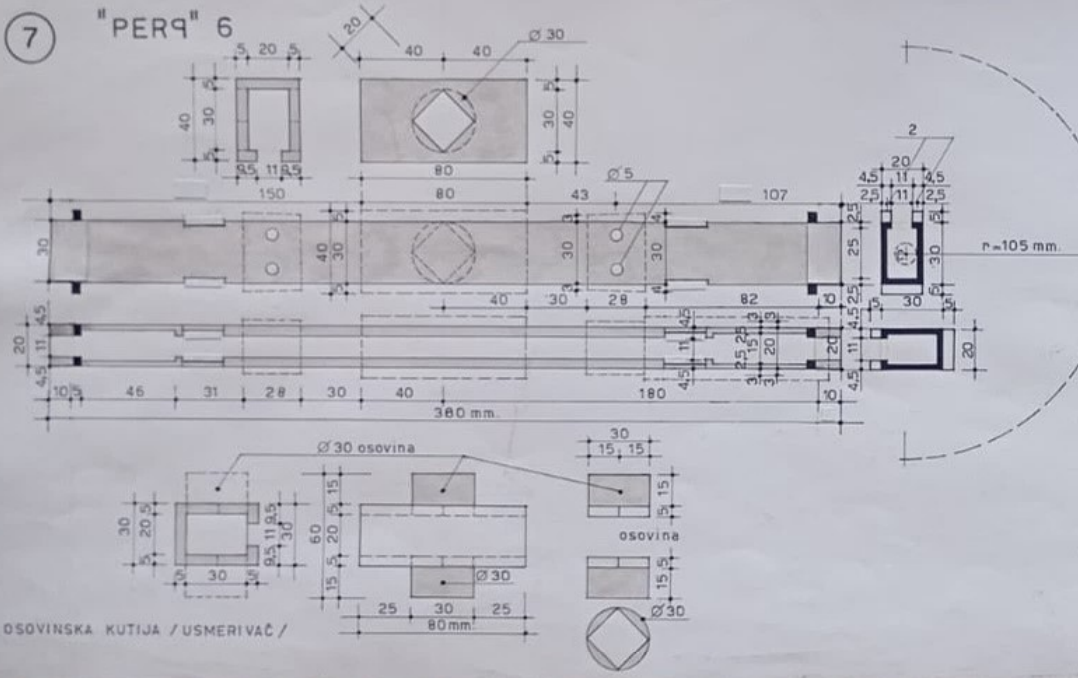

NOSAČ TOČKOVA USMERIVAČA KRAKA

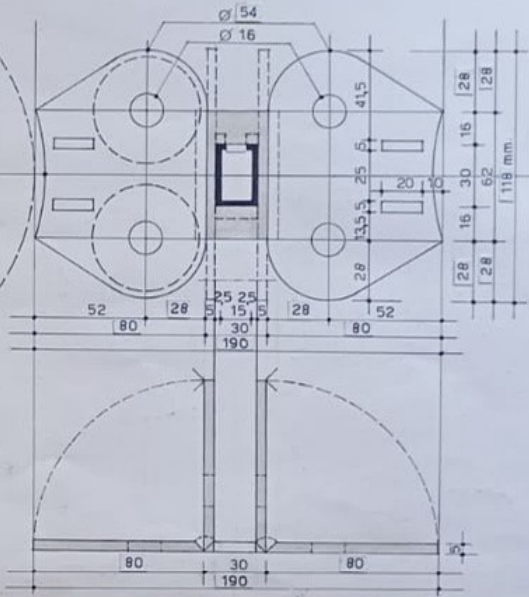

OSOVINA TOČKA USMERIVAČA

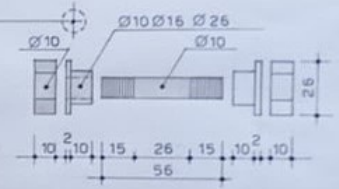



8

"PER9" 6

NOSEĆA KONSTRUKCIJA / PRESEK /

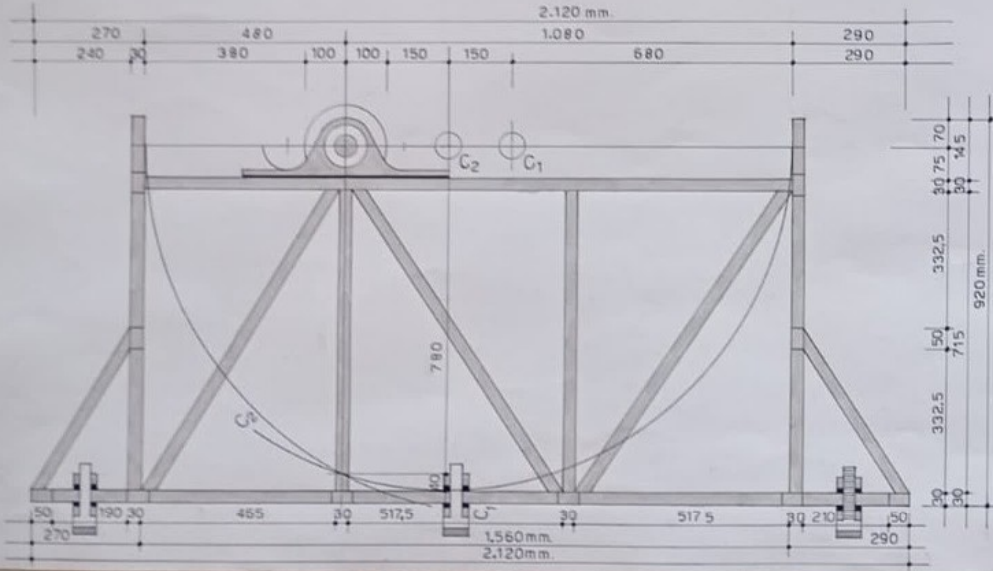

NOSEĆA KONSTRUKCIJA

/ BOČNI IZGLED /

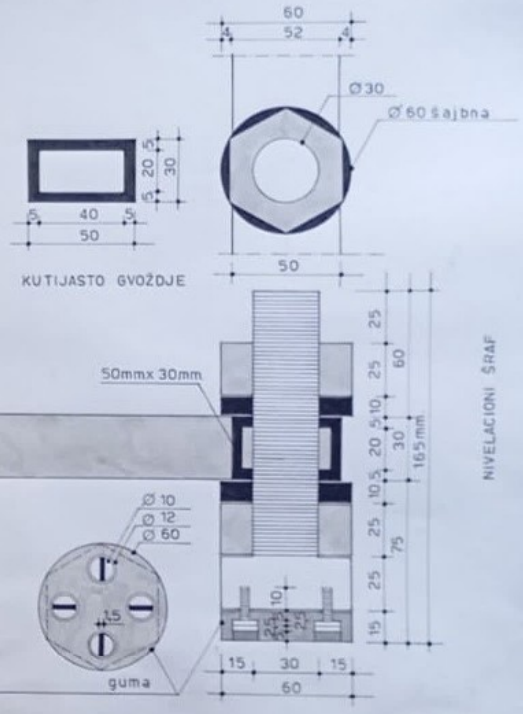
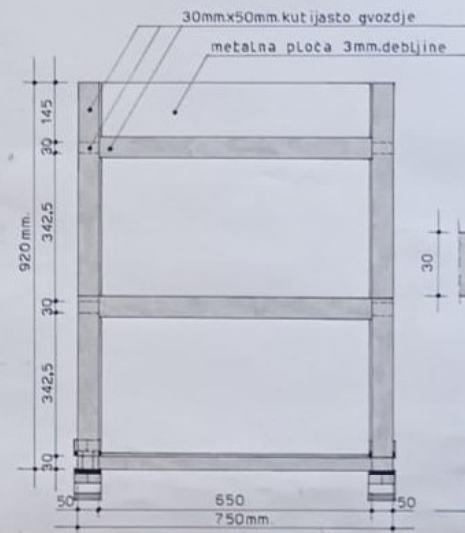

9

"PER9" 6

NOSAČ CENTRALNE OSOVINE

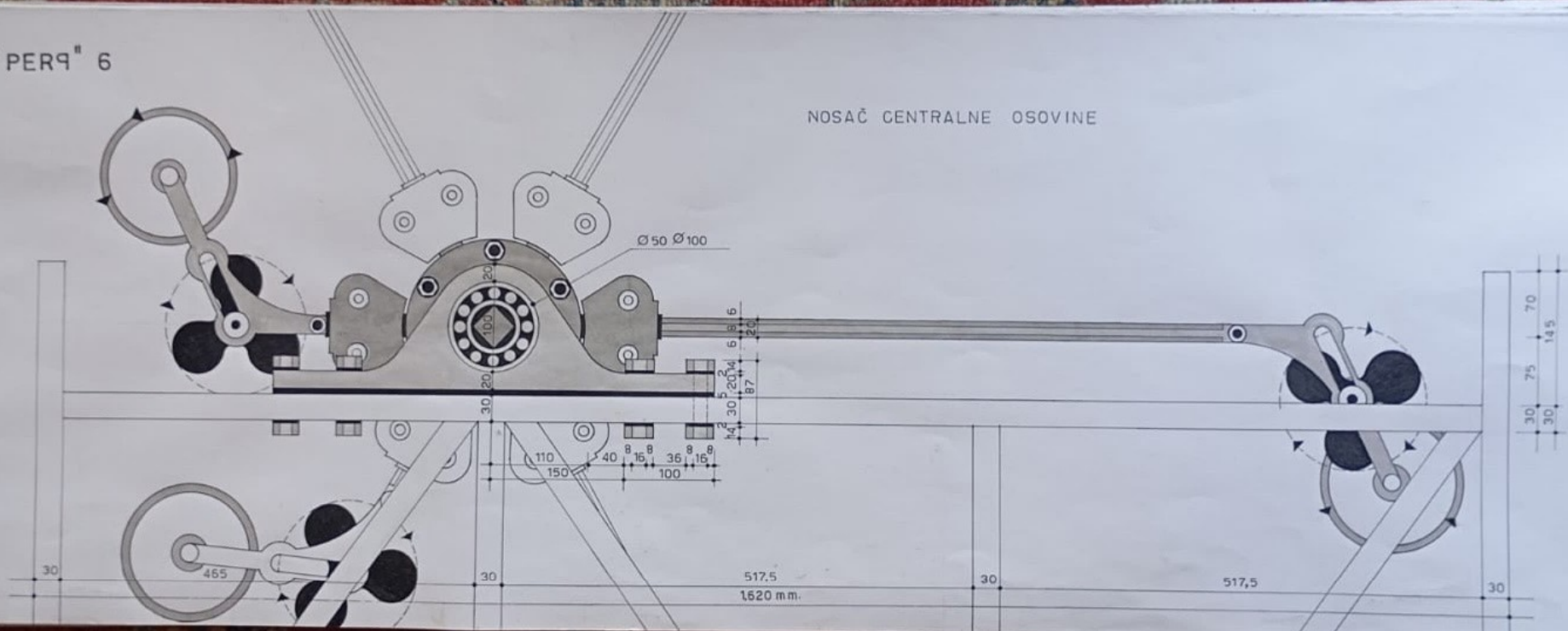

10

"PER9" 6

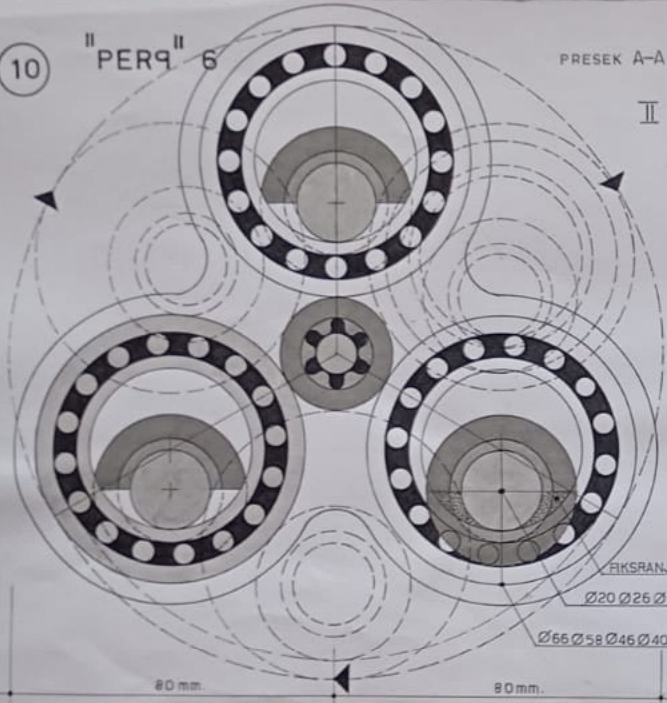

PRESEK A-A

II VARIJANTA ZAMAJCA

PRESEK B-B

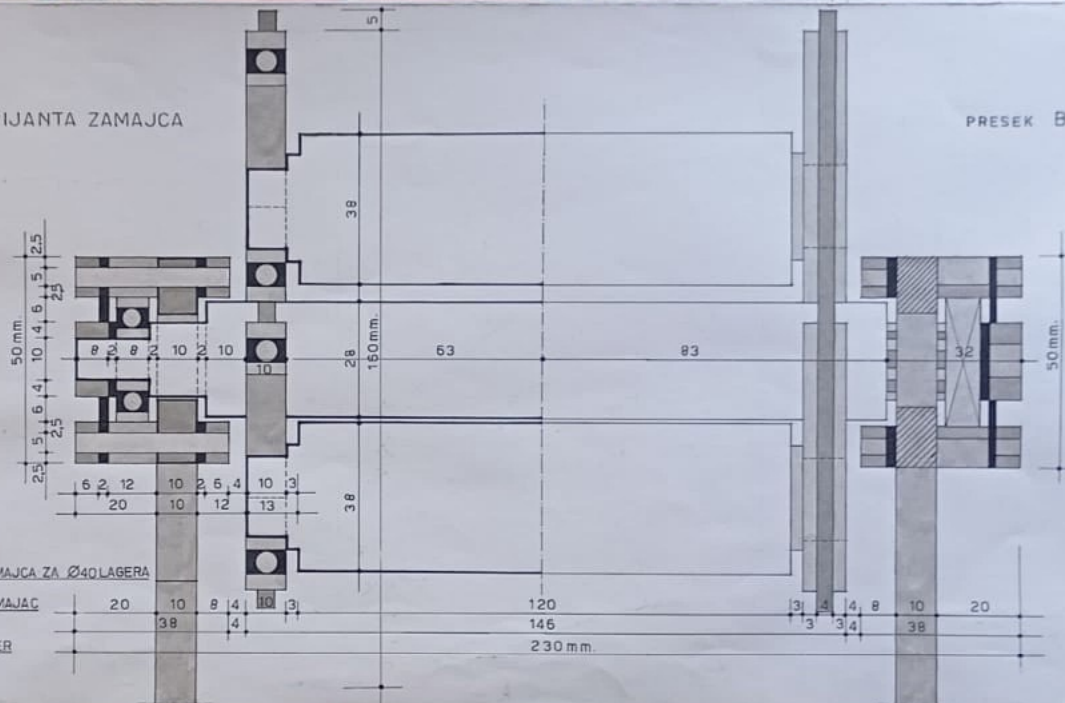

11

"PER9" 6

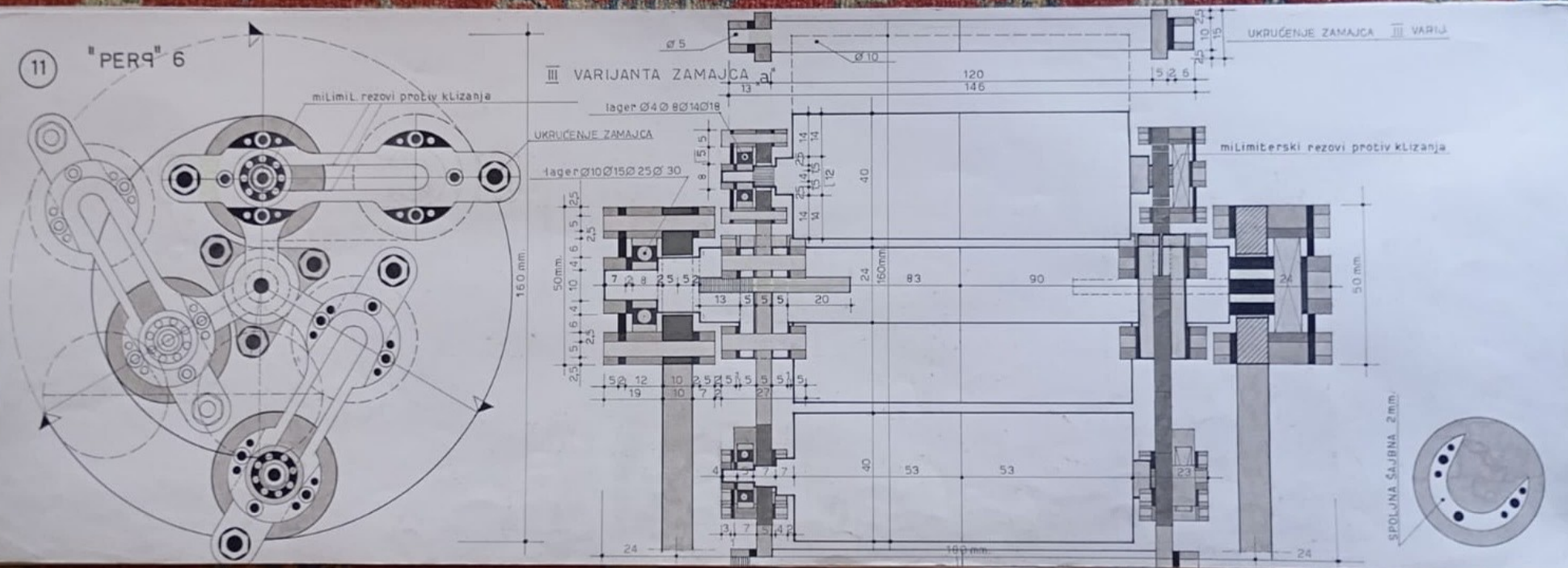



12

"PER9" 6

III VARIJANTA  
OSOVIINA ZAMAJCA

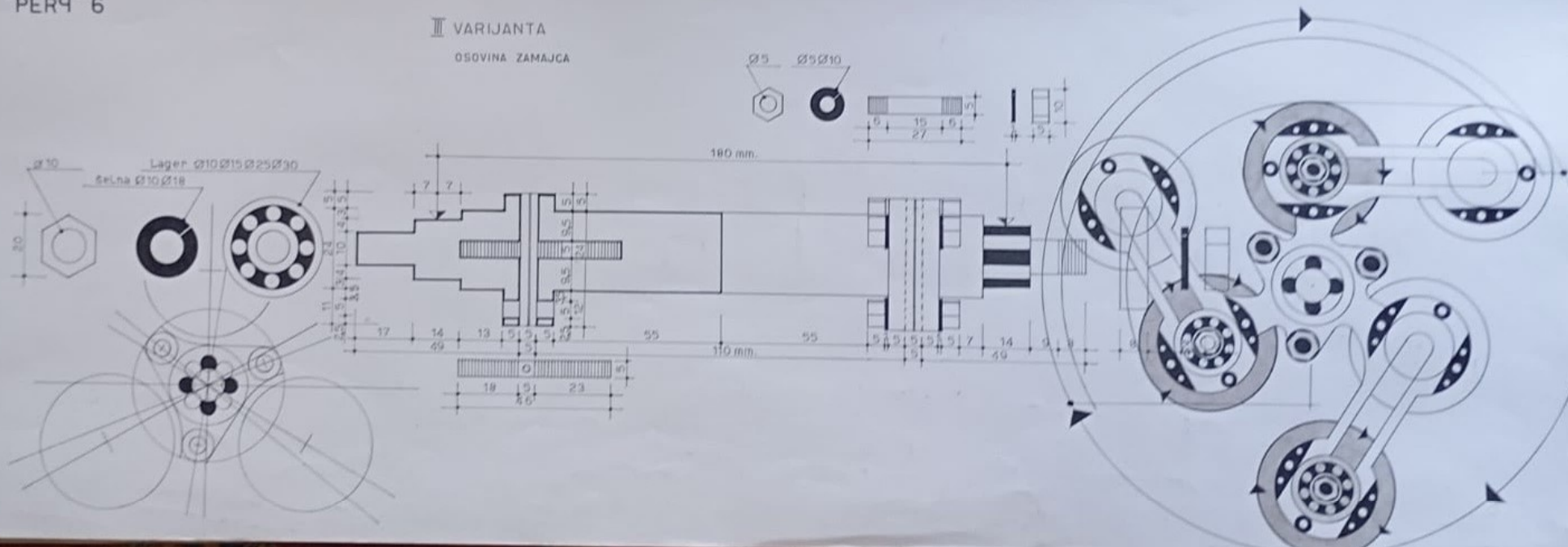

13

PER9 6

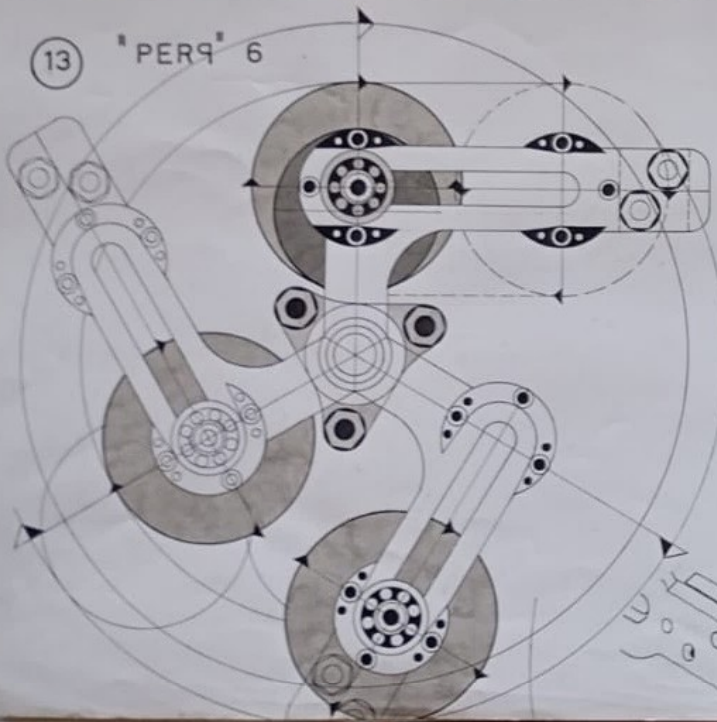

Ø 12 mm  
Ø 7 mm  
Ø 4 mm

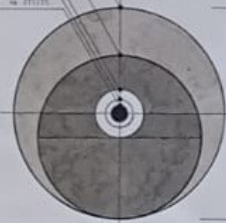

III VARIJANTA ZAMAJCA "b"

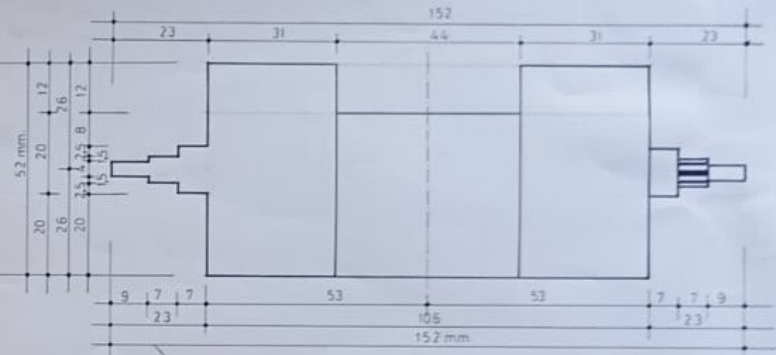
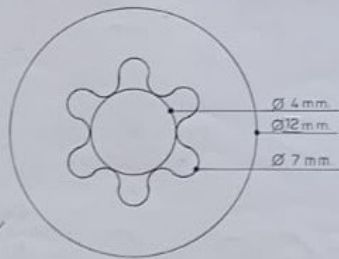

Ø 40 mm  
Ø 52 mm

14

"PERQ" 6

KUGLAGER Ø10 Ø30

MEKA / AMORTIZER / GUMA Ø10 Ø5

Ø 3,2 mm.

ROTACIONI PUT ZAMAJCA R-1 1/2 25

Ø 160mm.

TVRDA GUMA / AMORTIZER / LAGERA Ø10 Ø5

55 10 3 5 2 5 15 40 25 25 40 15 23 80 57 8 8 50 60

253 mm + 40 mm = 293 mm.

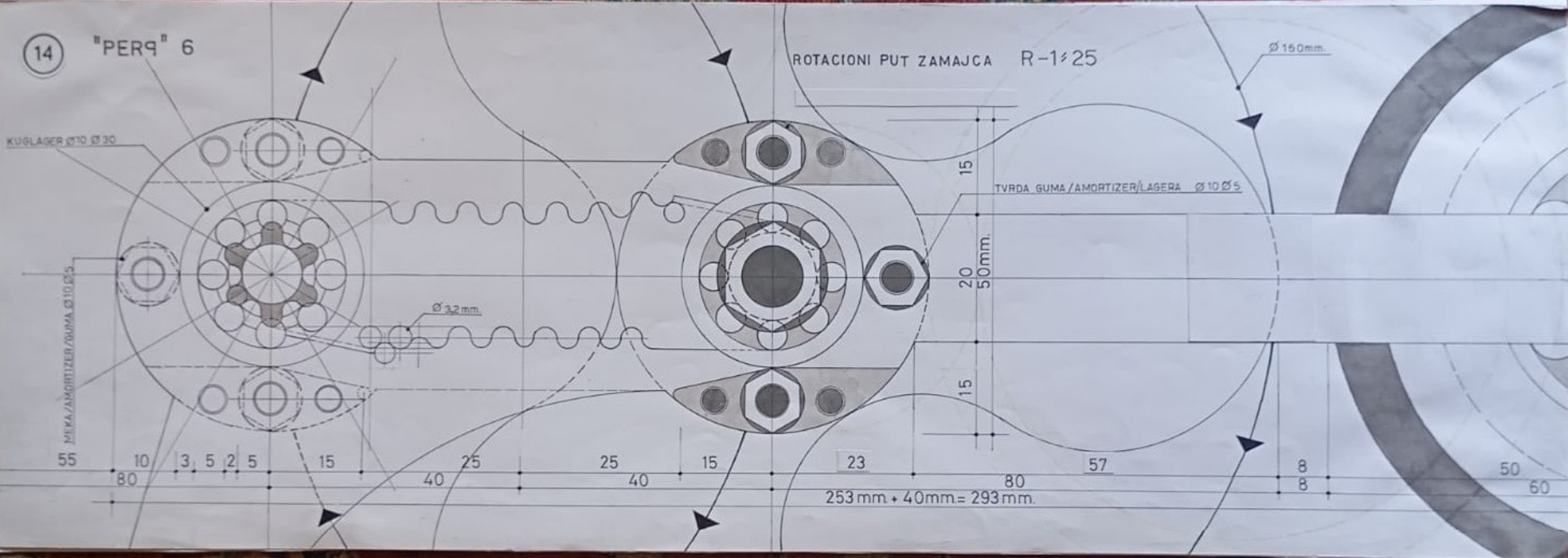

15 "PER9" 6

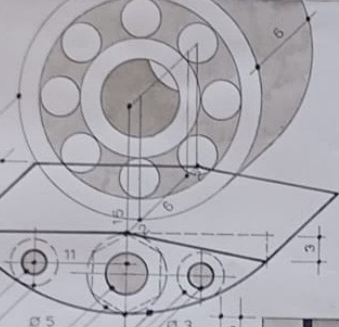

PRESEK OSOVINE TOČKA KRAKA "PER9" a R-1/50 IZGLJED TOČKA KRAKA "PER9" a R-1/50

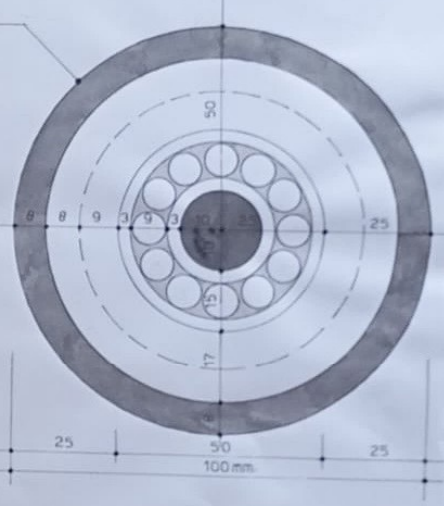
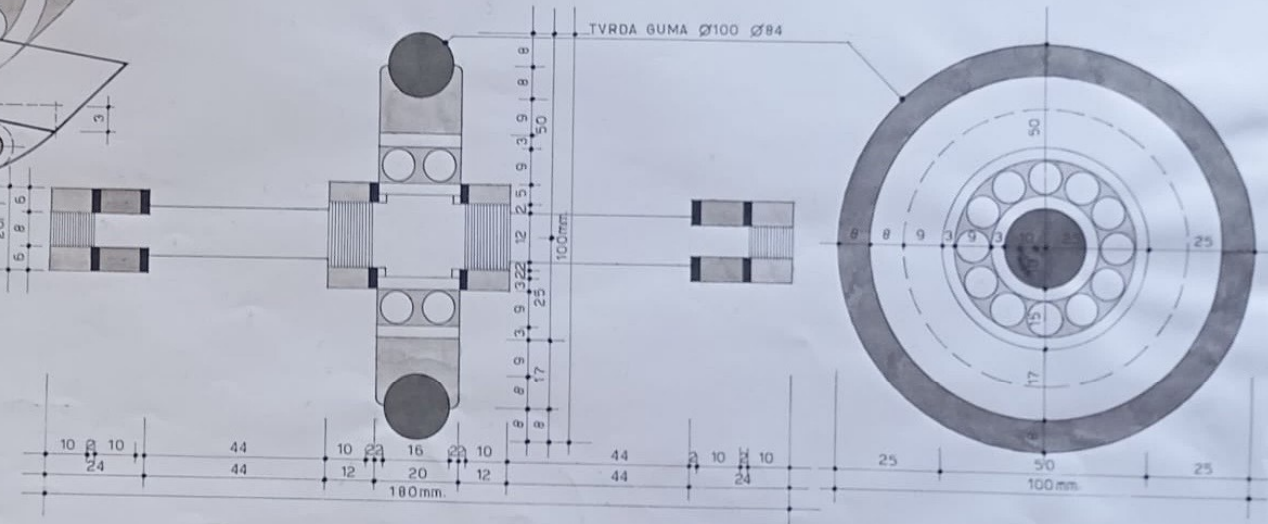
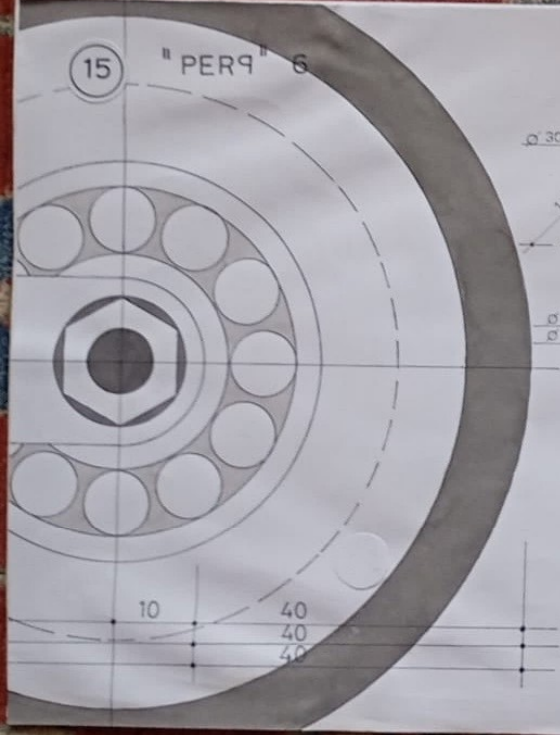



IV VARIJANTA ZAMAJCA II<sup>a</sup>

16

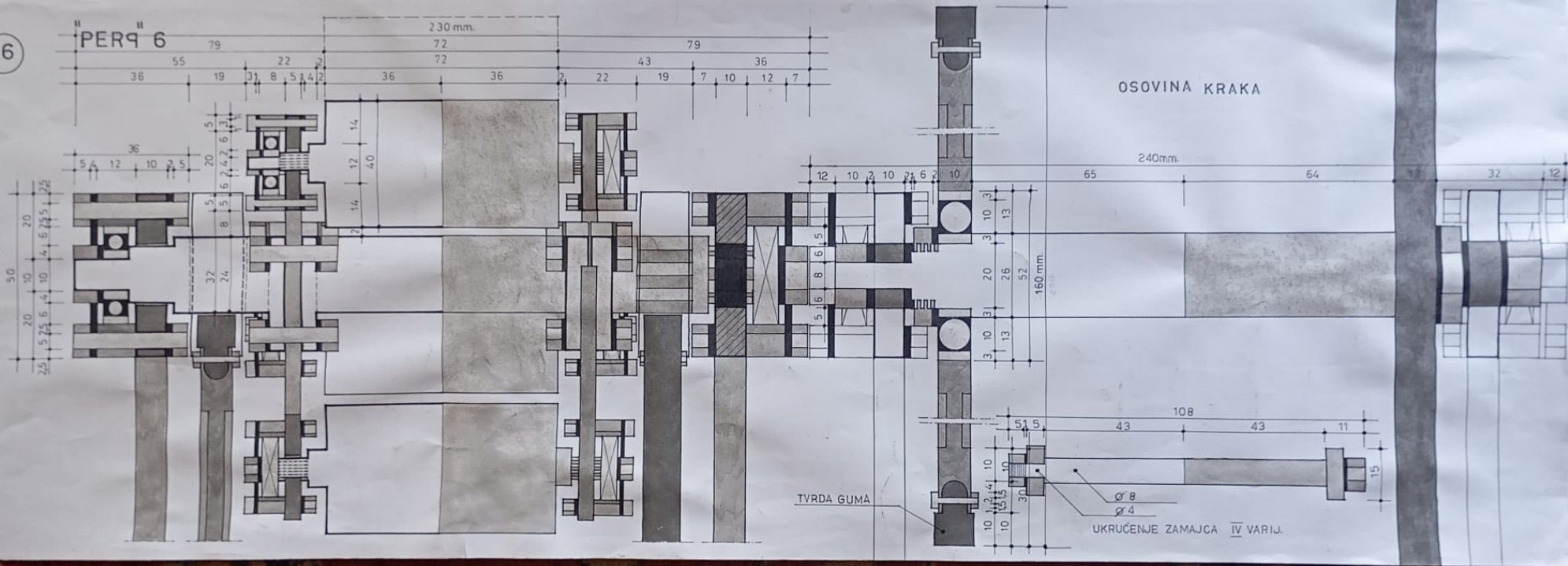

17

"PER9" 6

