



844-FLO-STOP | sales@mainlinecs.com | www.MainlineControlSystems.com

Mainline
Control Systems

Kleiss MCS60-38 System Manual

Flow Stopping System / 3" - 8" up to 60 psi

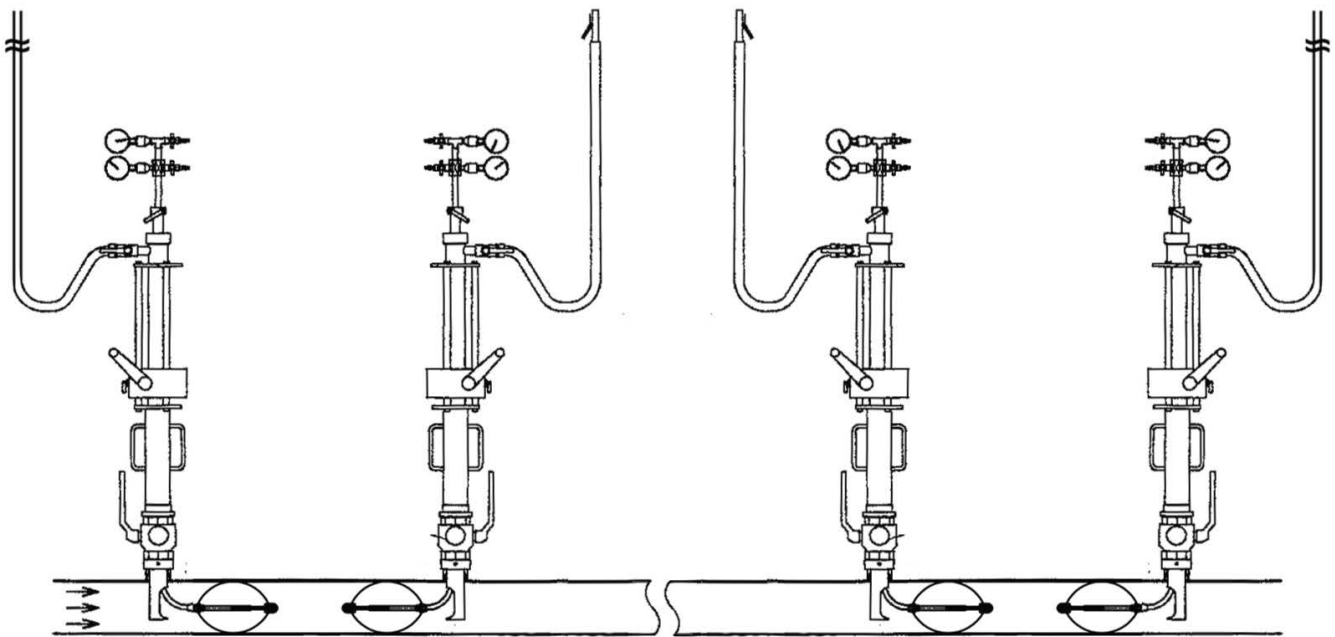



Kleiss MCS60-38 System Overview

The Kleiss inflatable stopping systems meet the needs of the North American Natural Gas LDCs by providing a flow control system that is easy to use and effective at stopping off flow in various pipe materials and a wide range of pipe diameters.

The Kleiss MCS60-38 System consists of four major components:

1) fitting to access the pipe, 2) tapping / completion tool, 3) inflatable stopper, and 4) stopping tool.

The Kleiss MCS60-38 System (all tools) has a maximum operating pressure of 60 psi. The inflatable stoppers have a design safety factor of 3. The balance of the tools have a design safety factor of 2.5.

The Kleiss MCS60-38 System is designed to handle flow control on pipe sizes 3” to 8” on all pipe material – cast iron, polyethylene, steel and PVC pipes. To accommodate the various pipe materials and sizes the tapping tool and stopping tool are outfitted with the appropriate fitting, cutter, chute, and stopper. See the Sizing Table in Section 4.0 to identify and install the correct components before operating the equipment.

The basic operation of the equipment is the same for all pipe materials. When working on non-metallic pipe materials, make sure the equipment is grounded per your company operating practices.

(Kleiss & Co., who developed the system, has reviewed and approved this manual.)

Table of Contents:

Table of Contents:	1
1.0 General Safety Information:	2
2.0 System Specifications:	2
3.0 Typical Site Set Up and Sequence:	4
4.0 Equipment:	9
5.0 Preparatory Steps:	16
6.0 Tapping Operation:	16
7.0 Stopping Operation:	25
8.0 Retrieving MDS Stopper:	34
9.0 Plugging Operation:	38
10.0 General Maintenance:	42
APPENDIX A: Stopper Testing and Verification.....	43
APPENDIX B: Tower Positioning and Distances	45
APPENDIX C: New Jacking Tool Instructions	49
APPENDIX D: Manual Updates	50

1.0 General Safety Information:

NOTE: Before using the Kleiss MCS60-38 System make certain you read the instruction manual completely and are comfortable and familiar with the operation of the tools. If you have any questions, concerns or feel there is conflicting information, please contact Mainline Control Systems (MCS) before proceeding at 844-FLO-STOP.

NOTE: The purpose of the Kleiss MCS60-38 System is to tap and stop flow in natural gas lines sizes 3” through 8” operating at a maximum of 60 psi. Review and follow your company safety procedures for operations involving tapping and stopping live natural gas lines.

NOTE: When operating the Kleiss MCS60-38 System on non-metallic pipe materials, please follow company procedures for grounding equipment for discharge of any static electricity.

2.0 System Specifications:

2.1 General

- A) Pipe diameter between 3” and 8”
- B) Pipe material of cast iron, polyethylene, steel or PVC
- C) Maximum operating pressure of 60 psi
- D) Tool to fitting connection of 2-1/2” BSP threads

NOTE: Tools are designed and built with a safety factor to allow +10% (+6 psi) for operation on 60 psi MAOP systems or in abnormal operating conditions.

2.2 Tapping Tool and Completion Tool Kit Specifications

- A) Maximum operating pressure of 60 psi (see NOTE in 2.1C)
- B) Cutters available
 - a) 2.2” (56.5 mm) cast iron and steel [Part #13200140]
 - b) 2.2” (56.5 mm) polyethylene and PVC [Part #1310080]
- C) 1/4” (6.3 mm) pilot drill used for all materials [Part #14300058]
- D) Air motor & compressor requirements
 - a) Connection to the air motor ~ 3/4” NPT
 - b) 90 psi measured at the inlet of the air motor during operation
 - c) Air volume through the motor should operate the air motor at 35 RPM’s load speed (cut) & 70-75 RPM’s free speed (non-cut)
 - d) Refer to manufacturer air motor specifications guide
- E) Oiler / separator required to be used to extend the life of the air motor
 - a) Use standard pneumatic oil in tool
- F) Weights
 - a) Tapping tool with cutter ~ 23 lbs.
 - b) Completion tool without completion plug attached ~ 13 lbs.
 - c) Air motor ~ 11 lbs.
 - d) Shipping weight in case ~ 65 lbs.
- G) Dimensions
 - a) Tapping tool height with cutter ~ 29”
 - b) Completion tool height ~ 17”
 - c) Storage case ~ 38” length x 18” width x 6” height

2.3 Stopping Tool Kit Specifications

- A) Maximum operating pressure of 60 psi (see NOTE in 2.1C)
- B) Weights
 - a) Stopping tool ~ 46 lbs.
 - b) Ball valve ~ 8 lbs.
 - c) Shipping weight in case ~ 94 lbs.
- C) Dimensions
 - a) Stopping tool height with stopper rod completely extended ~ 7 feet
 - b) Stopping tool height with stopper set ~ 4 feet
 - c) Storage case ~ 56" length x 16" width x 12" height
- D) By-pass / vent port
 - a) 3/4" tap size in tool
 - b) 1" cam lock male coupling

2.4 MDS Inflatable Stopper Specifications

- A) Sizes
 - a) 2.75" – 3.54" (70 mm – 90 mm) Pipe ID [Part #23100353]
 - b) 3.54" – 4.72" (90 mm – 120 mm) Pipe ID [Part #23100354]
 - c) 4.72" – 6.29" (120 mm – 160 mm) Pipe ID [Part #23100355]
 - d) 6.29" – 8.46" (160 mm – 215 mm) Pipe ID [Part #23100356]
- B) Inflation pressure of 120 psi or 2x system pressure if unable to achieve 120 psi by compressor or nitrogen
- C) Design burst pressure of 350 psi
- D) Operating temperature range of 5° F (- 15° C) to 140° F (60° C)
- E) Maximum temperature range of 158° F (70° C) for up to 30 minutes

2.5 Vent Stack Specifications

- A) Height assembled ~ 112"
- B) 1" cam lock male coupling
- C) Air hose to venturi connection
- D) Hose (standard) of 10 m, 1" cam lock connection F x F
- E) Ground rod included
- F) Weight (less hose) ~ 27 lbs.
- G) Air supply and flow capacity rates =

Air Supply		Flow Capacity
Working Pressure (PSI)	Air Consumption (ft ³ /min)	Blow Out Volume (ft ³ /hr)
80	13	24300
120	13	21200

2.6 Hand Pump (Pressure and Vacuum Pump)

- A) 1 positive pressure connection
- B) 1 negative pressure (vacuum) connection
- C) 10 foot air hose with quick disconnects included
- D) Weight ~ 12 lbs.

2.7 Maximum Flow Rates

- A) Maximum design flow rate = 60 ft/sec (18.29 m/sec)
- B) For reducing speed, use by-pass / vent port

NOTE: The system is designed to be used in controlled stop off applications, and is not intended to be used to stop flows in severely ruptured pipes. Flow should be reduced before attempting stop off.

3.0 Typical Site Set Up and Sequence:

It is important to understand the MCS stopping tools and their operation completely. It is also important to understand the complete job and sequence of steps to perform a safe stop. Safety of the operators on the job site is the most important factor so pre-plan the whole job including the stopping and retrieval sequences.

The following examples are typical installations. Example I (yellow background) illustrates stoppers positioned towards each other. Example II (blue background) illustrates stoppers positioned away from the work area. Both configurations work equally well. For additional set up illustrations, see Appendix B or contact your distributor / MCS representative.

Double block and bleed is the Kleiss preferred and recommended set up to allow for complete and safe isolation with the ability to purge, vent and bypass directly through the Kleiss tools. While double block and bleed is not required, it is the responsibility and liability of the utility or operators to determine safe alternate stopping configurations or practices used with other stopping equipment. The Kleiss System provides gauges and venting on both sides of the stopper to provide insight and safety of the project.

Remember to consider the ancillary steps like purging / venting the area to be worked on and back pressuring stoppers for removal. The features of the MCS60-38 offer options to make these processes efficient.

Plan accordingly to avoid launching or inflating stoppers under existing fittings, joints, or other obstructions.

Example I – Stopping Sequence: Stoppers Positioned Towards Each Other (Most Flexible)

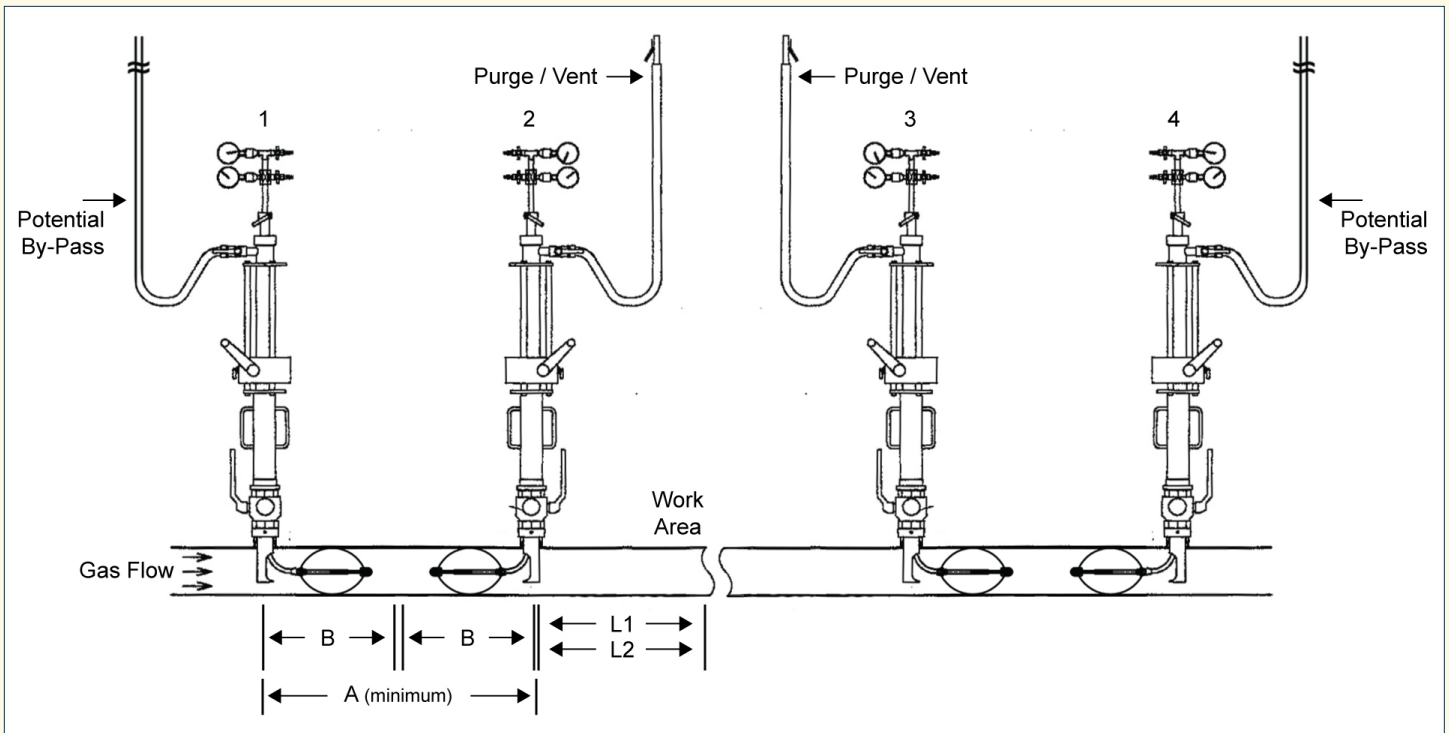

STOPPING TOWER DISTANCES

Nominal Pipe Size	A (minimum)	B	L1 = Steel Welding	L2 = PE, CI, and Mechanical
3"	40"	20"	18"	9" *
4"	44"	22"	24"	12" *
6"	52"	26"	30"	18" *
8"	72"	36"	36"	24" *

*A = minimum distance between towers | B = stopper length | L1 = minimum distance from stopper/tower to work area
L2 = distance from stopper/tower to work area (* measurement is a guide only, follow manufacturer's fitting recommendations)*

- 1) If a by-pass in the work area is being used (through our MCS tool or another), initiate the by-pass flow first.
- 2) Always insert first inflatable stopper WITH the flow of gas.
- 3) Always inflate the stopper as quickly as practical.
- 4) Suggested stopper setting sequence is tower #1, #2, #3, #4. Set all 4 stoppers.
- 5) First inflated stopper is now in a no flow condition. Reset stopper for best possible seal (deflate, reposition stopper rod, inflate).
- 6) Always allow stoppers to settle for 10 minutes prior to beginning pipeline work. This allows the stopper to acclimate to internal pipe conditions. Verify system pressures, inflation pressures, and any bleed-by before starting pipeline work. Adjust as necessary.
- 7) Use the by-pass / vent port on tower #2 or #3 to purge the work area. Utilize the MCS vent stack to assist in evacuating the work area. This connection can also be used to inject nitrogen into the work zone.
- 8) Keep by-pass / vent ports on towers #2 and #3 open to atmosphere during work to keep gas away from the work area. Follow company procedures for venting and purging gas.
- 9) This set up can easily be used on both single feed and dual feed systems.

Example I – Stopper Retraction Sequence: Stoppers Positioned Towards Each Other

NOTE: Always equalize pressure on both sides of the stopper before deflation or removal.

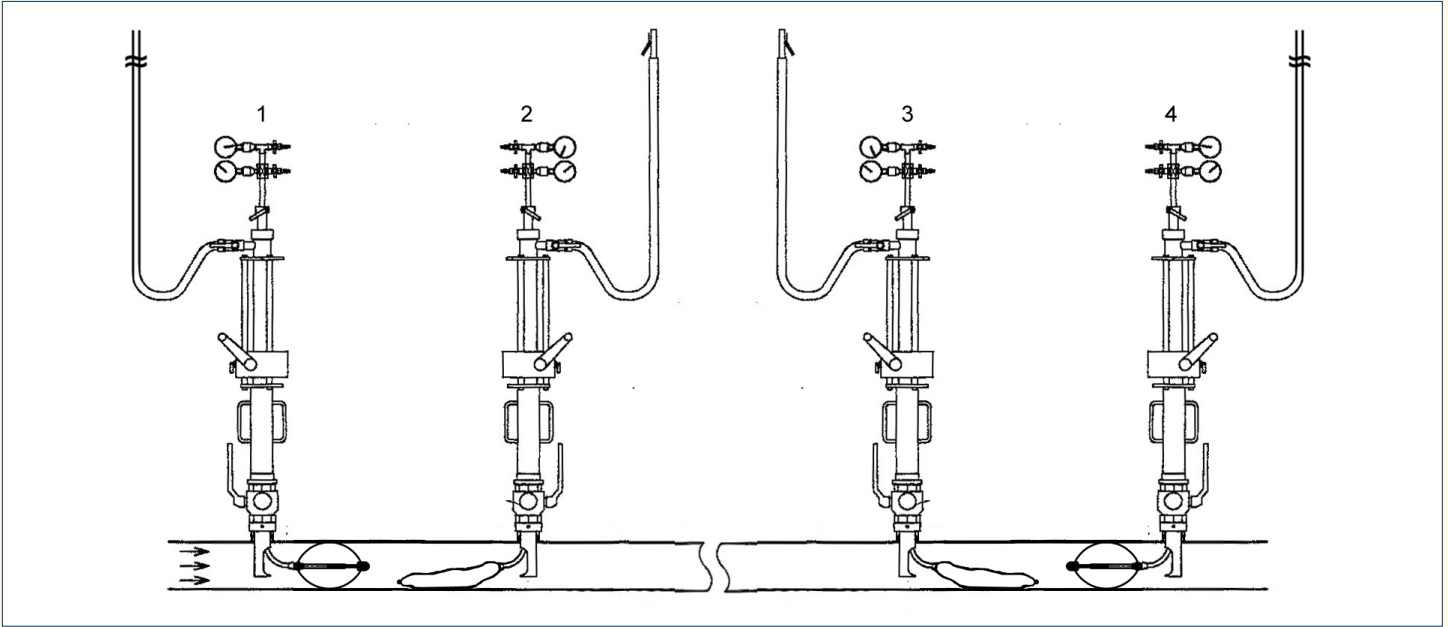

1) Deflate stoppers #2 and #3.

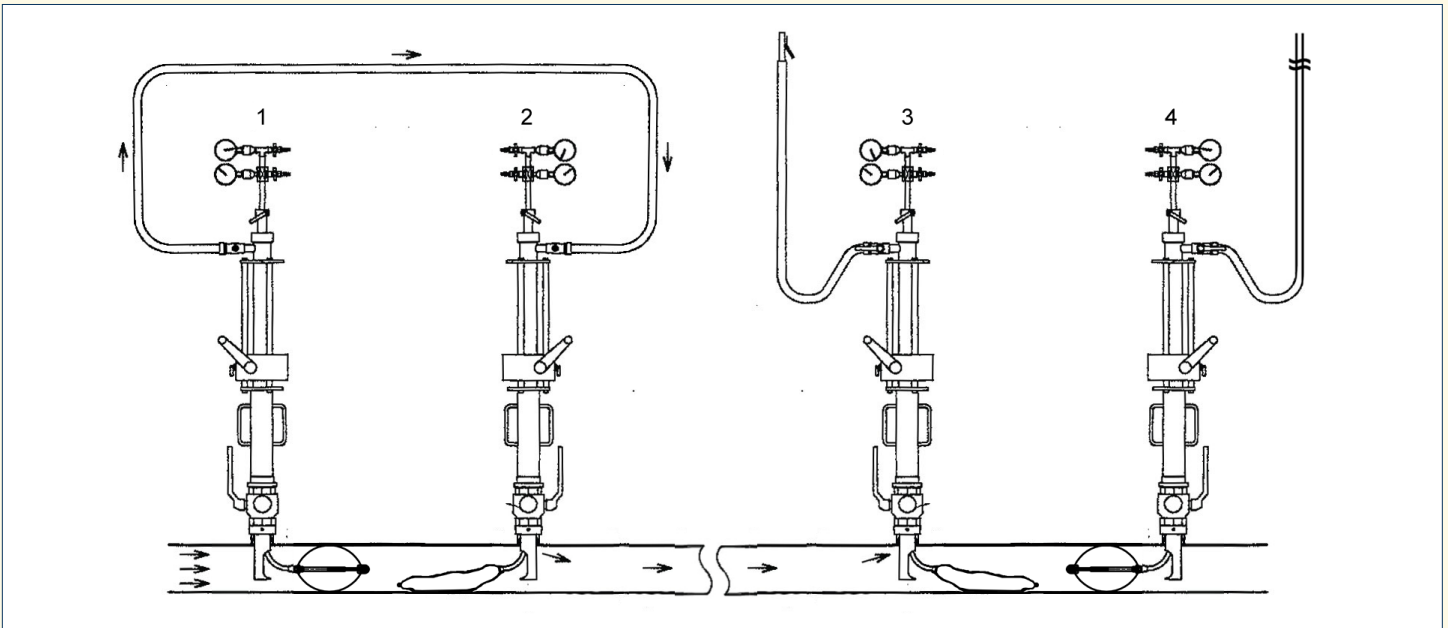

- 2) Use by-pass / vent ports on tower #1 and #2 to equalize pressures on stoppers #1 and #4. Equalize slowly.
- 3) Use by-pass / vent port on tower #3 to purge air from the repaired area.
- 4) Use system pressure gauge on tower #1, #2, #3, or #4 to determine if stoppers are equalized.
- 5) When pressure is equalized, deflate stoppers #1 and #4. Retract all stoppers.
- 6) Remove tools and install completion plugs.

Example II – Stopping Sequence: Stoppers Positioned Away From Work Area

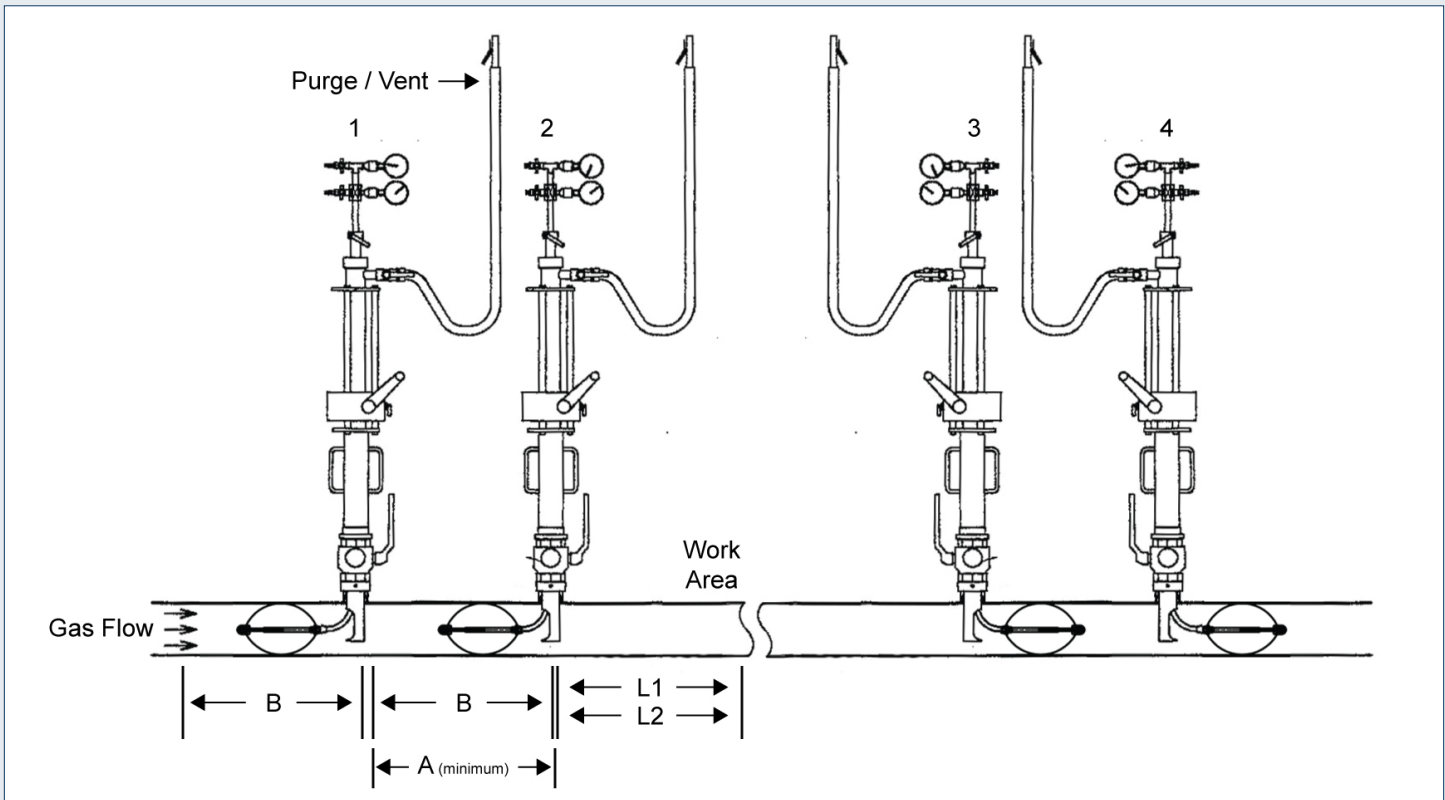

STOPPING TOWER DISTANCES

Nominal Pipe Size	A (minimum)	B	L1 = Steel Welding	L2 = PE, CI, and Mechanical
3"	20"	20"	18"	9" *
4"	22"	22"	24"	12" *
6"	26"	26"	30"	18" *
8"	36"	36"	36"	24" *

*A = minimum distance between towers | B = stopper length | L1 = minimum distance from stopper/tower to work area
L2 = distance from stopper/tower to work area (* measurement is a guide only, follow manufacturer's fitting recommendations)*

- 1) If a by-pass in the work area is being used (through our MCS tool or another), initiate the by-pass flow first.
- 2) Always insert first inflatable stopper WITH the flow of gas.
- 3) Always inflate the stopper as quickly as practical.
- 4) Suggested stopper setting sequence is tower #3, #4, #2, #1. Set all 4 stoppers.
- 5) First inflated stopper is now in a no flow condition. Reset stopper for best possible seal (deflate, reposition stopper rod, inflate).
- 6) Always allow stoppers to settle for 10 minutes prior to beginning pipeline work. This allows the stopper to acclimate to internal pipe conditions. Verify system pressures, inflation pressures, and any bleed-by before starting pipeline work. Adjust as necessary.
- 7) Use the by-pass / vent port on tower #2 or #3 to purge the work area. Utilize the MCS vent stack to assist in evacuating the work area. These connections can also be used to inject nitrogen into the work zone.
- 8) Keep all by-pass / vent ports on towers open to atmosphere during work to keep gas away from the work area. Follow company procedures for venting and purging gas.

Example II – Stopper Retraction Sequence: Stoppers Positioned Away From Work Area

NOTE: Always equalize pressure on both sides of the stopper before deflation or removal.

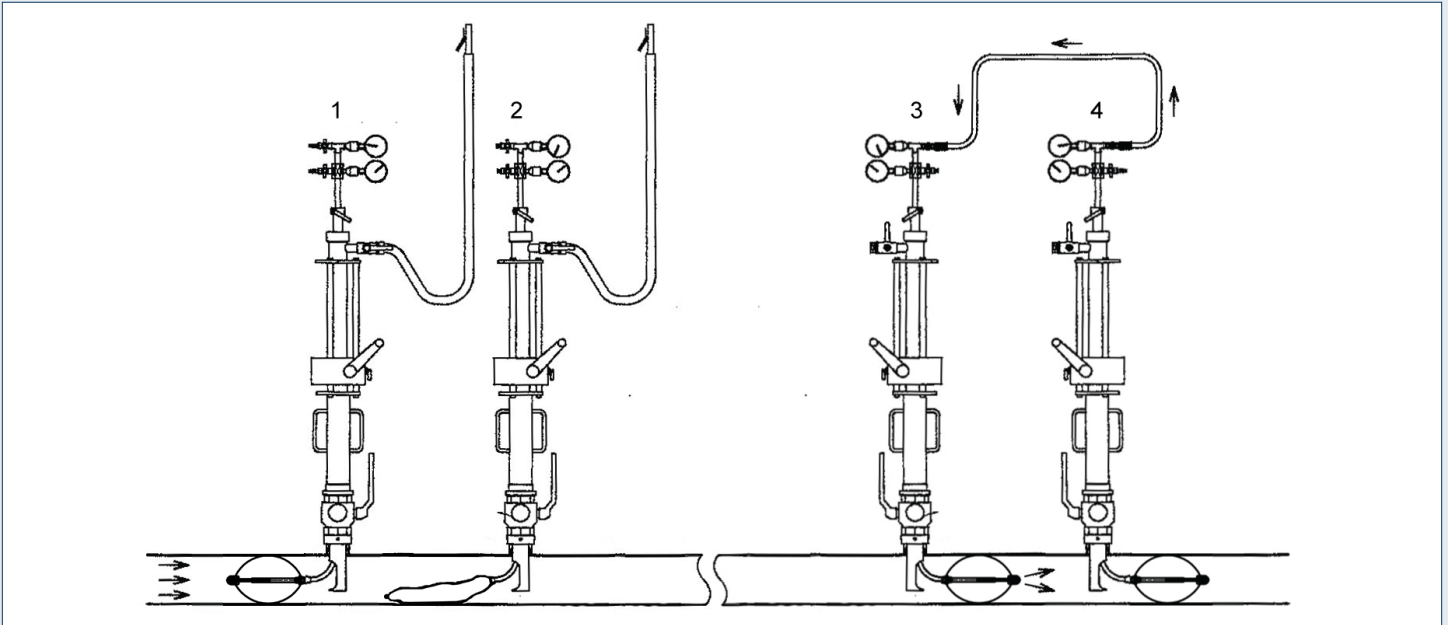

- 1) Deflate stopper #2.
- 2) Back pressure stopper #4 through the system pressure ports in towers #3 and #4.

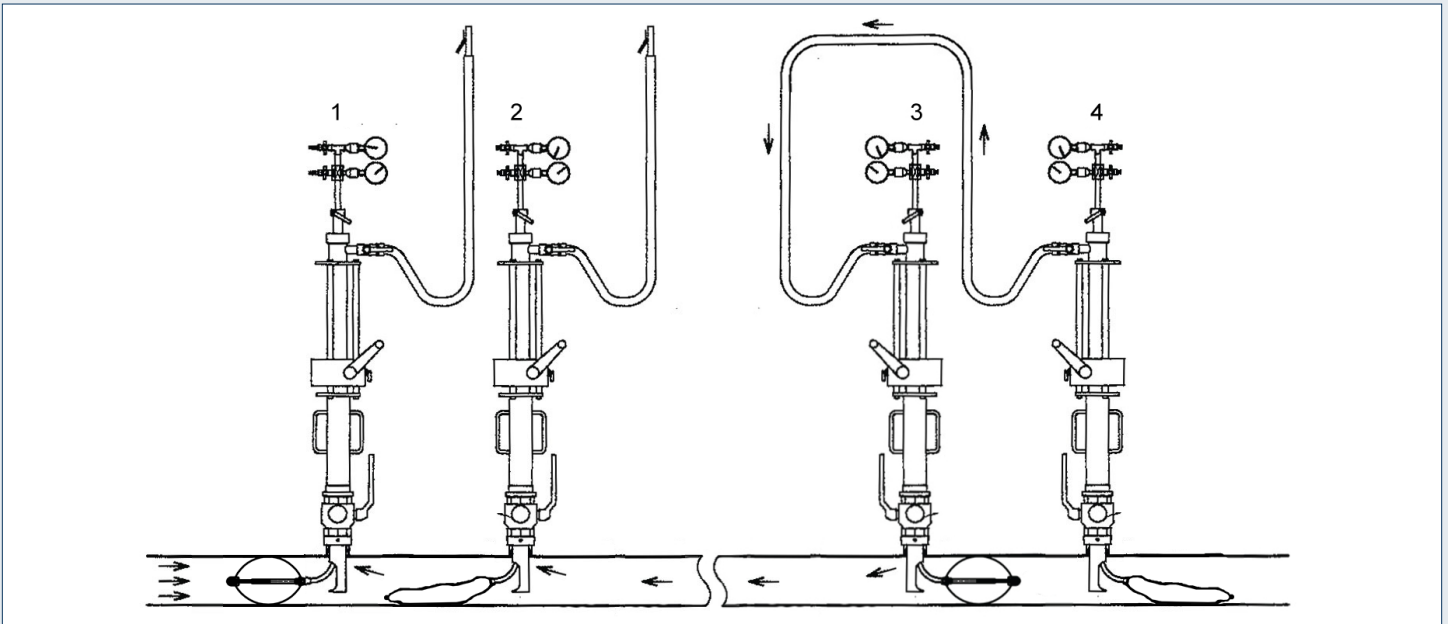

- 3) Deflate stopper #4.
- 4) Equalize pressure on stoppers #1 and #3 through the by-pass / vent port between towers #3 and #4.
- 5) Use the by-pass / vent port in tower #1 or #2 to purge air from repaired area.
- 6) Use system pressure gauge on tower #1 or #2 to determine stoppers are equalized.
- 7) Deflate and remove stoppers.
- 8) Remove tools and install completion plugs.

NOTE: For additional set up illustrations, see Appendix B.

4.0 Equipment:

Tapping Case [Part # MCSTK060-0308-001]:

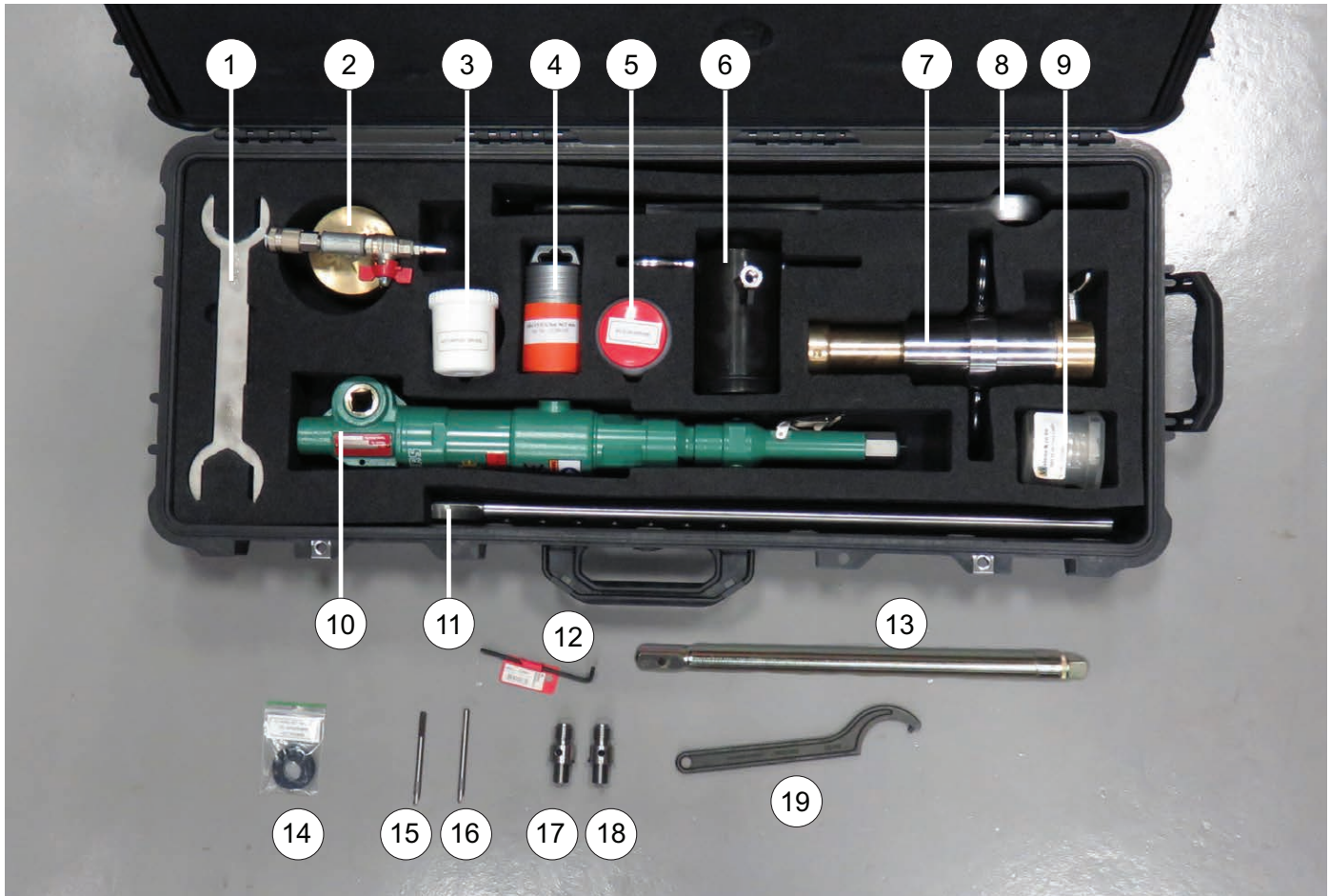

	PART #	DESCRIPTION
1)	10310835	Cutter Wrench (56.5 mm)
2)	90090035	Test Cap Assembly 2-1/2"
3)	14700015	Cutter Grease (250 ml)
4)	13200140	Steel and Cast Iron Cutter (1004HM 56.5 mm x 3/8")
5)	94200020	Silicone Grease Canister
6)	10310816	Drilling Dome (2-1/2")
7)	10310800	Tapping Device / Hot Tap Tool (LB-493HD)
8)	11000120	Ratchet (20 mm square)
9)	13100080	PE and PVC Cutter (1003 56.5 mm x 3/8")
10)	10800248	Air Motor (small 20 mm square)

	PART #	DESCRIPTION
11)	10310905	Drilling Rod (650 mm 25 mm x 20 mm square)
12)	99512506	Hexagonal Key (4 mm)
13)	10800846	Plug Spindle (20 mm square)
14)	10310830	Spare Seal Set
15)	14300058	Pilot Drill (6.3 mm with retainer spring)
16)	14300058	Pilot Drill (6.3 mm with retainer spring)
17)	10310780	Adapter (3/4" WW x 3/8")
18)	10310780	Adapter (3/4" WW x 3/8")
19)	11005310	Hook Assembly Wrench (58-62)
	99518863	Case (Peli 1700)
	99310015	Foam Interior

Tapping Tool and Completion Tool Components:

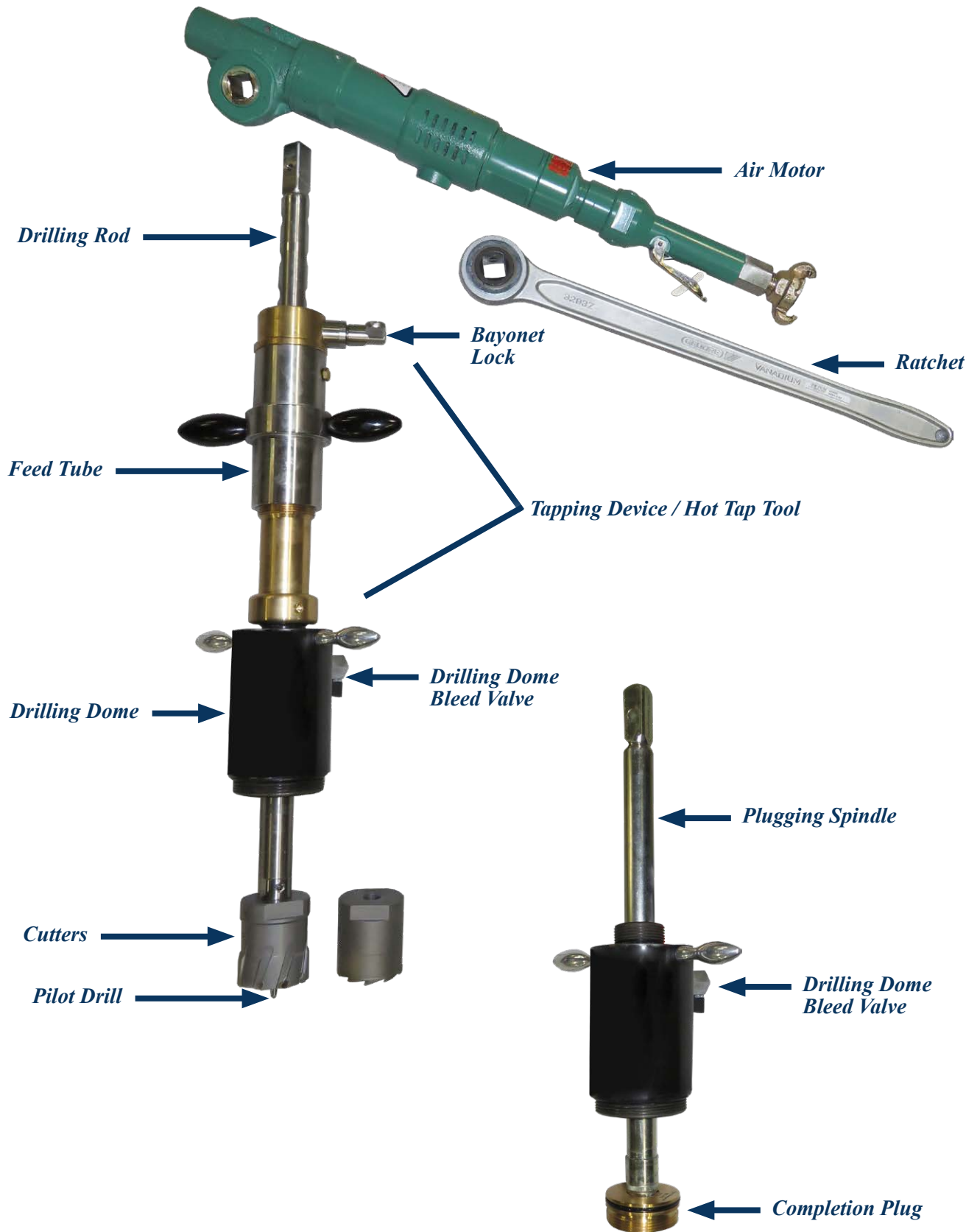

Stopping Case [Part # MCS060-0308-001]:

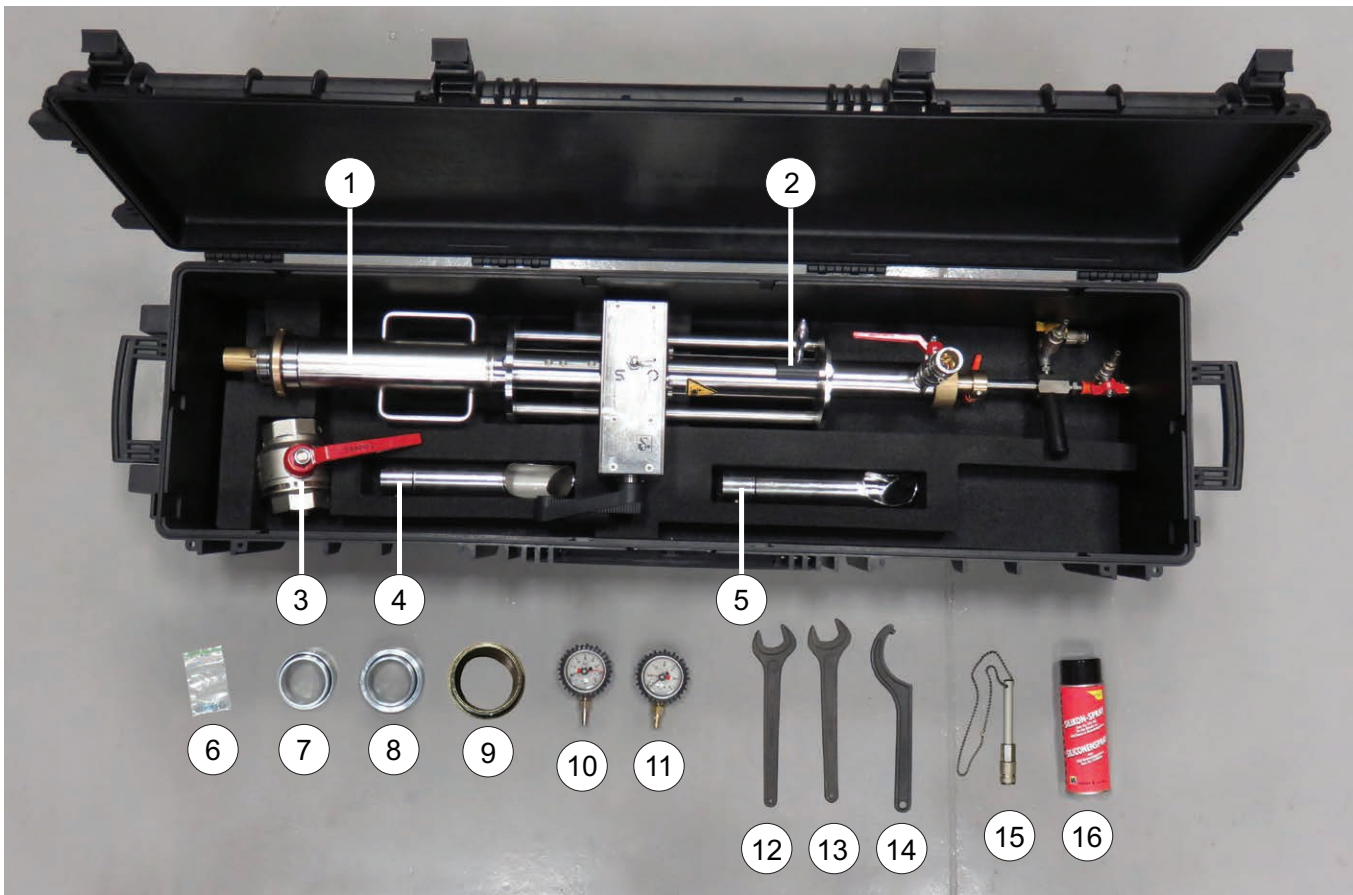

	PART #	DESCRIPTION
1)	12100025	Flow Stopping Tower MCS60-38
2)	12100741	Safety Bumper
3)	12100120	Full Bore Ball Valve (2-1/2")
4)	99518682	Chute # 2
5)	99518681	Chute # 1
6)	12100750	Gasket Set (MCS60-38)
7)	10311030	Ring Adapter for Steel and Stainless Steel Saddle Fittings (2-1/2" x 2-1/2" x 1-3/4" / stamped "S")
8)	10310955	Ring Adapter for PE Fittings (2-1/2" x 2-1/2" x 1-1/4" / stamped "P")
9)	10311031	3" Ring Adapter (For all 3" diameter and material applications)

	PART #	DESCRIPTION
10)	12100022	Inflation Pressure Gauge (-15 to 120 psi)
11)	12100023	Pipeline Pressure Gauge (0 to 60 psi)
12)	11000190	Wrench (32 mm)
13)	11000190	Wrench (32 mm)
14)	12100255	Hook Assembly Wrench (95-100 mm)
15)	12100740	Safety Fitting (silver)
16)	94200010	Silicone Grease Aerosol
	99500003	Case (Explorer)
	99500019	Foam Interior

Stopping Tool Components:

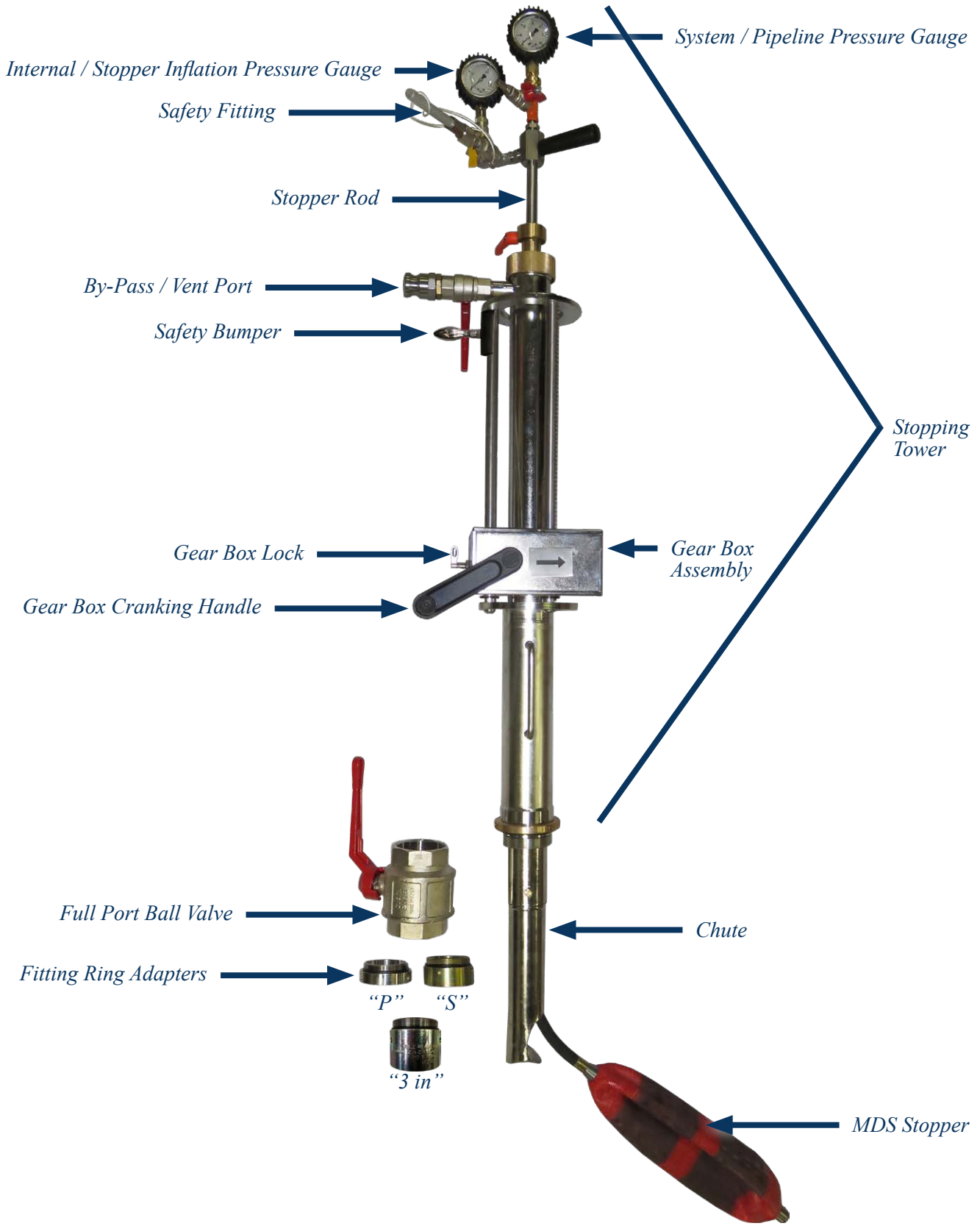

MDS Stoppers:



	PART #	DESCRIPTION
1)	23100353	MDS Stopper Size 2.75" – 3.54" (70 mm – 90 mm)
2)	23100354	MDS Stopper Size 3.54" – 4.72" (90 mm – 120 mm)
3)	23100355	MDS Stopper Size 4.72" – 6.29" (120 mm – 160 mm)
4)	23100356	MDS Stopper Size 6.29" – 8.46" (160 mm – 215 mm)

Fitting / Completion Plug / Completion Cap:

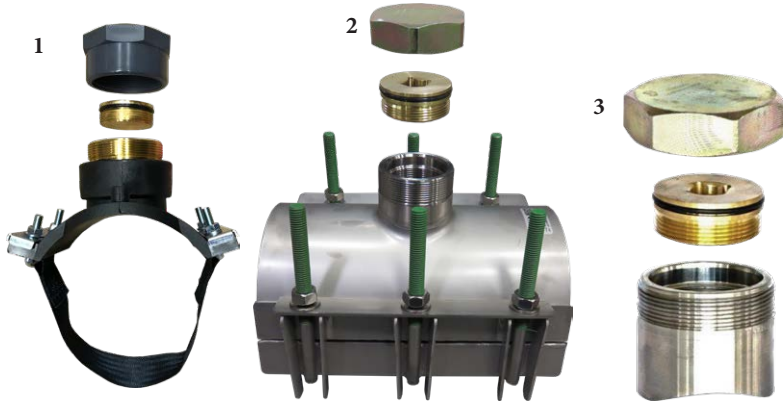

	PART #	DESCRIPTION
1)	90401010 to 90401040	Polyethylene Fitting (size specific)
2)	90004001 to 90004028	Stainless Steel Saddle Fitting (size specific)
3)	11009050	Steel Fitting (3" – 8")

Accessories:

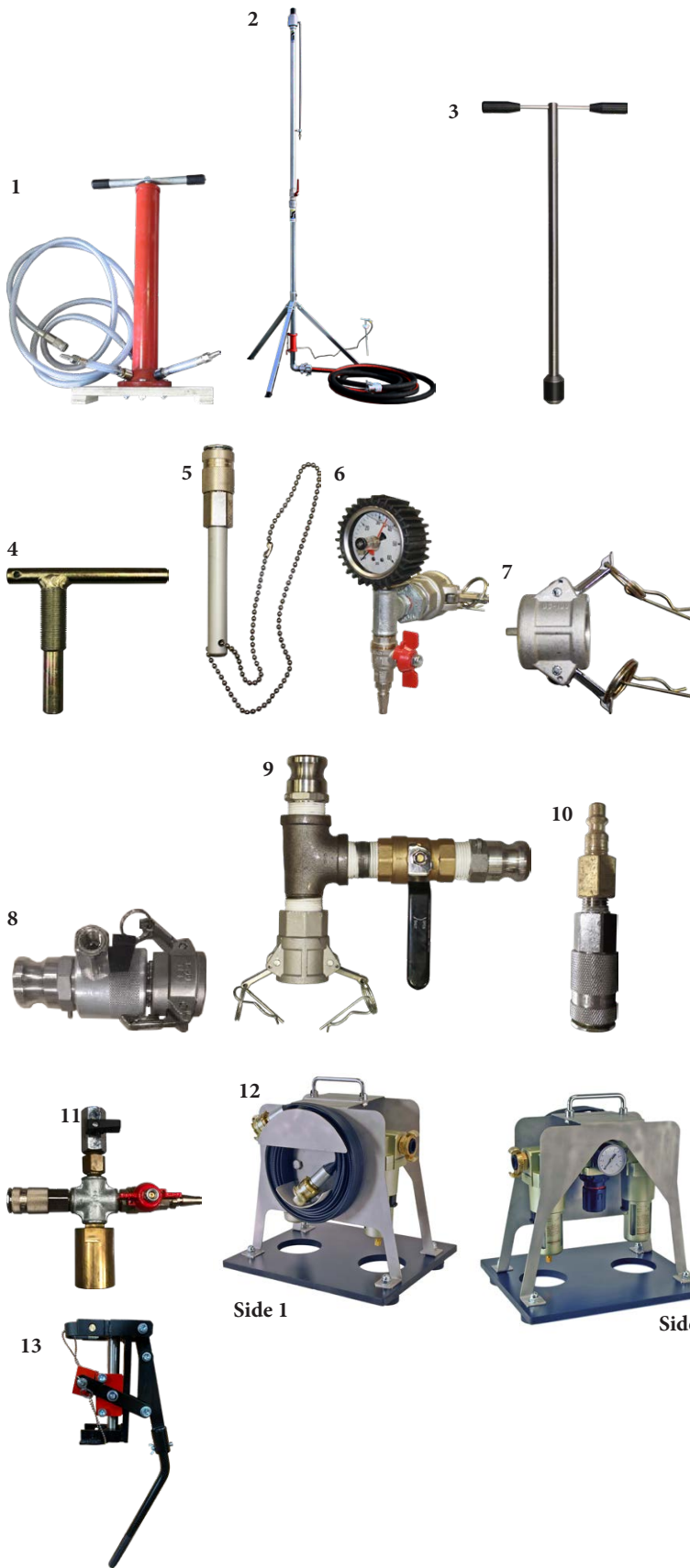

	PART #	DESCRIPTION
1)	22500011	Hand Pump with Hose
2)	59003176	1" Vent Stack with Hose
3)	10800854	Magnetic Spindle with Handle
4)	13200098	Coupon Remover (3/8" Connection)
5)	12100740	Safety Fitting (Silver)
6)	BPGT-1	By-Pass Gauge Tree
7)	BPC-1	By-Pass Cap
8)	BPVA-1	By-Pass Vent Adapter
9)	BPT-1	By-Pass Tee Assembly
10)	AHA-1	Air Hose Adapter
11)	12100731	MDS Stopper Test Adapter (MCS60-38)
12)	49101380	Air Motor Oiler / Water Separator Unit (Complete)
13)	12002451	Jacking System

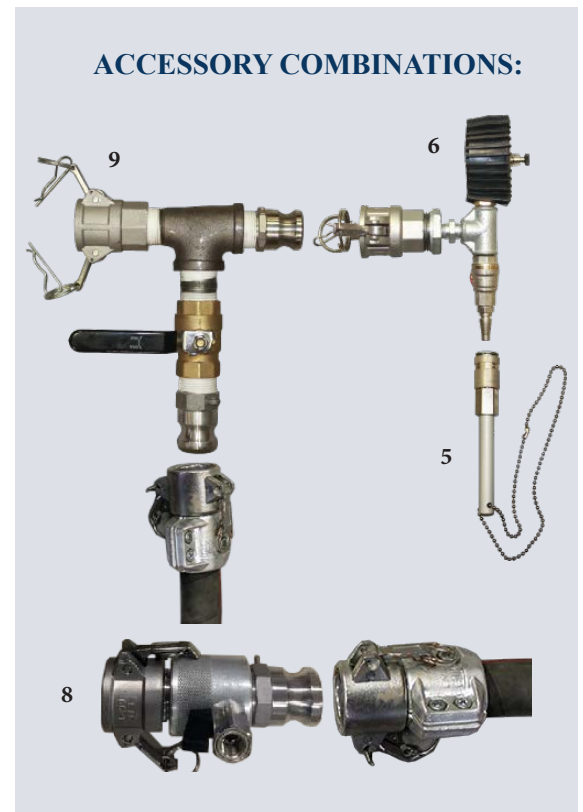

Sizing Table [Equipment Part #'s]:

POLYETHYLENE PIPE				
Nominal Pipe Size	3"	4"	6"	8"
Fitting	90401010	90401020	90401030	90401040
Ring Adapter	10311031	10310955 ("P")	10310955 ("P")	10310955 ("P")
Cutter	13100080	13100080	13100080	13100080
Pilot Drill	14300058	14300058	14300058	14300058
Chute	99518681 (#1)	99518681 (#1)	99518682 (#2)	99518682 (#2)
MDS Stopper <i>(Pipe ID Range)</i>	23100353 <i>(2.75" - 3.54" / 70 mm - 90 mm)</i>	23100354 <i>(3.54" - 4.72" / 90 mm - 120 mm)</i>	23100355 <i>(4.72" - 6.29" / 120 mm - 160 mm)</i>	23100356 <i>(6.29" - 8.46" / 160 mm - 215 mm)</i>

CAST IRON PIPE				
Pipe OD Range	3.46"-4.33"	4.49"-5.27"	6.61"-7.48"	8.85"-9.68"
Fitting	900004001	900004003	90004008	90004013
Ring Adapter	10311031	10311030 ("S")	10311030 ("S")	10311030 ("S")
Cutter	13200140	13200140	13200140	13200140
Pilot Drill	14300058	14300058	14300058	14300058
Chute	99518681 (#1)	99518681 (#1)	99518682 (#2)	99518682 (#2)
MDS Stopper <i>(Pipe ID Range)</i>	23100353 <i>(2.75" - 3.54" / 70 mm - 90 mm)</i>	23100354 <i>(3.54" - 4.72" / 90 mm - 120 mm)</i>	23100355 <i>(4.72" - 6.29" / 120 mm - 160 mm)</i>	23100356 <i>(6.29" - 8.46" / 160 mm - 215 mm)</i>

STEEL PIPE					
Nominal Pipe Size	3"	4"	5"	6"	8"
Fitting	11009050	11009050	11009050	11009050	11009050
Ring Adapter	10311031 ("3 in")	10311030 ("S")	10311030 ("S")	10311030 ("S")	10311030 ("S")
Cutter	13200140	13200140	13200140	13200140	13200140
Pilot Drill	14300058	14300058	14300058	14300058	14300058
Chute	99518681 (#1)	99518681 (#1)	99518682 (#2)	99518682 (#2)	99518682 (#2)
MDS Stopper <i>(Pipe ID Range)</i>	23100353 <i>(2.75" - 3.54" / 70 mm - 90 mm)</i>	23100354 <i>(3.54" - 4.72" / 90 mm - 120 mm)</i>	23100355 <i>(4.72" - 6.29" / 120 mm - 160 mm)</i>	23100355 <i>(4.72" - 6.29" / 120 mm - 160 mm)</i>	23100356 <i>(6.29" - 8.46" / 160 mm - 215 mm)</i>

PVC PIPE		
Nominal Pipe Size	3"	4"
Fitting <i>(Pipe OD Range)</i>	90004027 <i>(3.5")</i>	90004028 <i>(4.5")</i>
Ring Adapter	10311031	10311030
Cutter	13100080	13100080
Pilot Drill	14300058	14300058
Chute	99518681 (#1)	99518681 (#1)
MDS Stopper <i>(Pipe ID Range)</i>	23100353 <i>(2.75" - 3.54" / 70 mm - 90 mm)</i>	23100354 <i>(3.54" - 4.72" / 90 mm - 120 mm)</i>

5.0 Preparatory Steps:

<input type="checkbox"/>	Measure accordingly to avoid launching or inflating stopper under existing fittings, joints, or other obstructions.
<input type="checkbox"/>	Select proper MDS Stopper from the sizing table in Section 4.0.
<input type="checkbox"/>	Select proper fitting from the sizing table in Section 4.0.
<input type="checkbox"/>	Attach selected fitting, based on pipe material, per company standards and specifications.
<input type="checkbox"/>	Before welding steel fitting on main, remove the completion cap and plug from fitting.
<input type="checkbox"/>	When welding, if there is concerns about warping the fitting, install test cap assembly on fitting with valve open to vent heat.
<input type="checkbox"/>	After welding is complete, verify there is no weld slag in the fitting.
<input type="checkbox"/>	Kleiss Gastool PE fittings use a 4.0 mm fusion pin. Ensure you have the appropriate tips/adapters on your electrofusion processor that will fit the 4.0 mm pins.
<input type="checkbox"/>	When installing PE fittings, as part of the electrofusion process, make certain to allow the fitting to completely cool down for the entire “cooling time” before tapping the main.
<input type="checkbox"/>	Verify plug insertion and seals are intact
<input type="checkbox"/>	Pressure test attached fitting per company standards and specifications.

6.0 Tapping Operation:

- Mount the appropriate ring adapter onto the fitting and tighten the ring by means of the hooked wrench. Tighten completely.

For appropriate ring adapter, reference tables on page 15.



- ❑ Position the valve so that when the valve is open the handle is up.

Install the ball valve onto the adapter ring of the fitting and tighten the valve by hand to compress the o-ring.

Operate the valve to ensure smooth operation.



- ❑ Take the hot tapping device out of the case and inspect the device for dirt and debris. Make sure the threads are clean and the device operates freely.



- ❑ Visually inspect the drilling dome and verify o-rings are in place.



- ❑ Attach the drilling dome to the hot tapping device. Tighten the connection by means of the hooked wrench.



- Attach pilot drill to cutter adapter. Secure pilot drill with allen wrench. Then attach cutter adapter to cutter.

Figure A:
Steel and cast iron cutter [13200140] and pilot drill [14300058].

Figure B:
PE and PVC cutter [13100080] and pilot drill [14300058].



A:



B:

- If cutting through steel or cast iron, grease the cutter and pilot drill with the cutting grease for better drilling results.

If cutting through PE or PVC, skip this step.



- Grease rod with silicone grease for a smooth installation. Then, install the drilling rod through the hot tapping device and dome.



- Install the cutter onto the drilling rod and tighten the cutter.



- ❑ Retract the drilling rod and cutter completely into the drilling dome. No part of the cutter should be visible.

When retracted into the drilling dome, the cutter should be in the position as shown in the picture.



- ❑ Install the complete tapping tool onto the ball valve and tighten the tool.

When doing this, make certain the valve doesn't inadvertently turn.



- Identify which feed tube type that will be used.

Feed Tube A: Threaded at the top of the brass portion of the feed tube.

Feed Tube B: Has a stop line at the top of the brass portion of the feed tube.

A.



B.



- Make sure the ball valve is open. (The ball valve is open if the handle is in an upward position.)

- Hold the drilling rod firmly so it doesn't drop, pull out the bayonet lock on tapping device.

Carefully lower drilling rod until pilot drill touches the surface of the pipeline to be tapped.

When doing this, make sure the bayonet lock is in a free position and does not lock into the drilling rod.

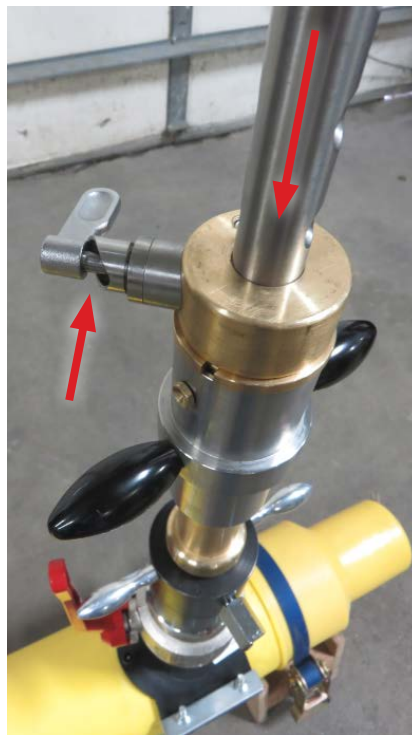

□ After the pilot drill is in contact with the pipeline, lock the feed tube to the drilling rod at the closest hole on the drilling rod using the bayonet lock. Do this by either rotating the feed tube until it locks in place or pulling up on drilling rod.



□ Turn the feed tube clockwise until the pilot bit is again in contact with the pipeline. Then, locate the maximum drilling depth by measuring 2" from the bottom of the feed tube. Place a mark on the brass tapping tube. (In picture, 1/2" black electrical tape was used.)

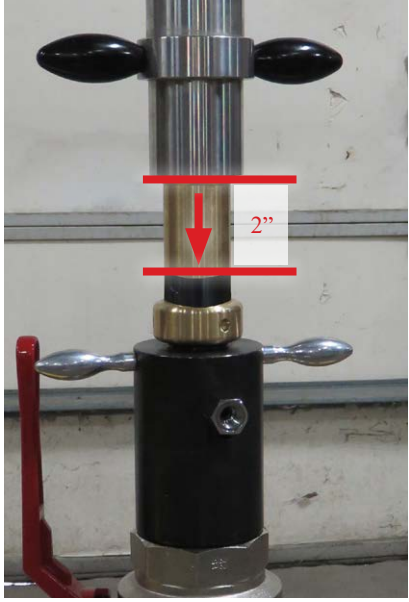

□ **Feed Tube A:** Rotate the feed tube counterclockwise until 3 additional threads are exposed. (This ensures the pilot drill is not on the pipe and is in the proper position to start drilling.)



Feed Tube B: Rotate the feed tube counterclockwise until flush with the stop line (This ensures the pilot drill is not on the pipe and is in the proper position to start drilling.).



- Place air motor on drilling rod square.

Operator should ensure the air compressor is working properly at 90 psi measured at the inlet of the air motor. Air volume through the motor should operate the air motor at 35RPM's load speed (cut) & 70-75 RPM's free speed (non-cut).

Make certain the oiler / separator is in place.

NOTE: If issues with air motor occur, tapping can be completed by hand using the ratchet.



- Use the air motor to turn the drilling rod clockwise.

While the drilling rod is rotating clockwise slowly hand feed the cutter downward by turning the feed tube handles clockwise to cut the pipe.

(Do not feed the cutter too quickly and cause a bind and potential cutter breakage. Especially on steel and cast iron.)



- The tapping procedure is finished when the drilling rod can rotate without any resistance or the maximum drilling depth mark is reached.

NOTE: You will feel less resistance twice - once in the beginning when the pilot drill has perforated the pipe wall and secondly when the cutter is completely through.



- ❑ To retract cutter and coupon, continue spinning the drilling rod clockwise while rotating the feed tube counterclockwise until you have reached the starting position.

Feed Tube A: 3 Threads Exposed
Feed Tube B: Stop Line

(NEVER turn the drilling rod counterclockwise. This can damage the cutter.)

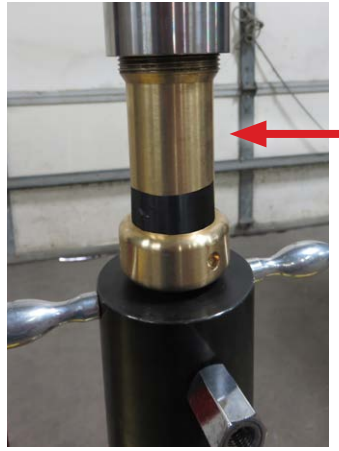

- ❑ **WARNING: Always control the drilling rod.**

Free the drilling rod by unlocking the bayonet lock. Then pull the drilling rod completely upwards above the ball valve.

(If assistance to get the cutter out is needed, turn the drilling rod clockwise.)

(NEVER turn the drilling rod counterclockwise. This can damage the cutter.)

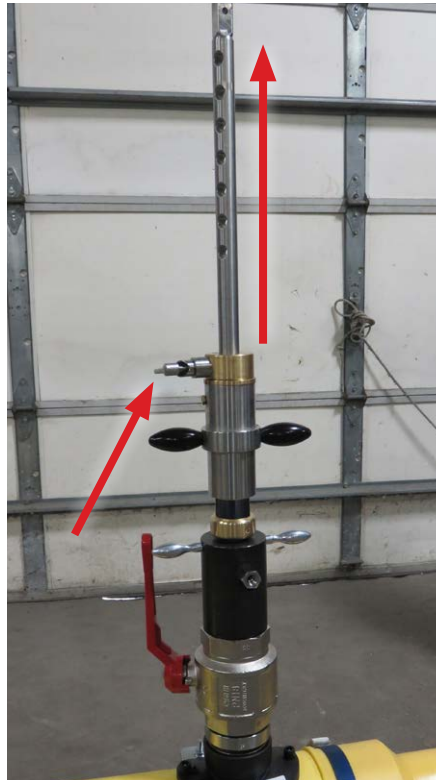

(Be aware of the fact that the pressure inside the pipeline may automatically move the rod upwards. Avoid being above the rod with your hands or face.)

WARNING: Always control the drilling rod.

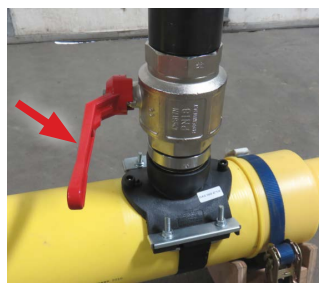

- ❑ Close the ball valve.



<p>❑ Release pressure from the dome by opening bleed valve.</p>	
<p>❑ Remove the complete tapping tool from the ball valve.</p> <p>When doing this, make certain the valve doesn't inadvertently turn.</p>	
<p>❑ Disassemble the tapping tool.</p> <p>Use hook assembly wrench [11005310] to remove tapping device from drilling dome.</p> <p>Use cutter wrench [10310835] to remove cutter from drilling rod.</p> <p>The cutter should contain the drilling coupon. Use the necessary tools [Coupon Remover - 13200098] to remove the coupon from the cutter.</p>	
<p>❑ After tapping steel pipe, to remove steel shavings from interior of pipe, use the magnetic spindle in combination with the drilling dome to clean the interior of the pipe. To remove the majority of the steel may take multiple insertions.</p>	
<p>❑ Clean and store tapping tool in its case.</p>	

7.0 Stopping Operation:

- Attach the appropriate gauges on the appropriate couplings at the top of the stopper rod.

Each gauge has a specific function. The gold connection gauge will indicate the pressure inside the pipeline in front of the MDS Stopper. The silver connection gauge indicates the inflation pressure of the inflatable stopper.

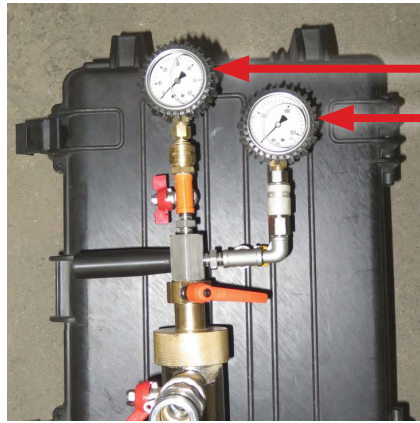

- Verify that the coupling on the bottom of the stopper rod contains a gasket.

The gasket should be in good visual condition. The condition of the gasket can be verified when conducting the vacuum test on the stopper prior to inserting the stopper into the gas system.

NOTE: Extra stopper rod gaskets should always be available.

Never use the stopping tool if the gasket is not inside the coupling.

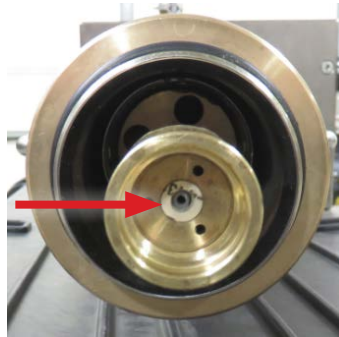

- Take the stopper you selected from the chart in Section 4.0 and visually inspect that the stopper is in good condition without weak spots or concern for integrity.

(If the condition of the stopper is uncertain, refer to Appendix A for additional stopper testing and verification.)

Pre-bend the hose of the MDS Stopper as this will facilitate the positioning of the stopper into the pipeline through the chute.

NEVER pre-bend the MDS Stopper on the frame!!! This can damage the frame and it will not help as the internal frame is rigid.



❑ Attach the MDS Stopper onto the stopper rod.
Tighten the connection by means of a pair of wrenches. Always use two wrenches to ensure tight connection and seal.



❑ Connect hand pump to the stopper inflation connection on the top end of the stopper rod. (This is the offset connection.)

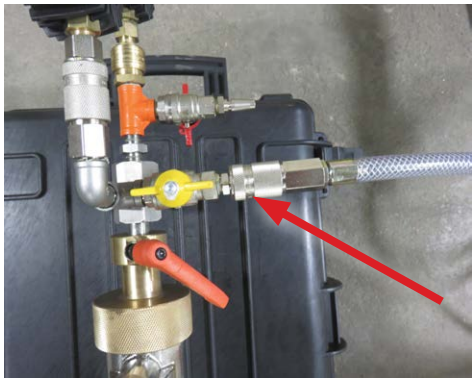

❑ With the valve open, pull a vacuum as close to -15 as achievable on the stopper to make it as compact as possible. An ideal stopper vacuum will range from -8 to -15. Use two operators for valve and pump control if necessary.



❑ Close the valve after evacuation.

❑ Verify negative pressure is maintained for 5 minutes to ensure seal and integrity of MDS Stopper and complete stopper rod.

This is what a well evacuated MDS Stopper looks like!



ADDITIONAL STOPPER TESTING BY INFLATION:
 If additional stopper testing is desired, insert the stopper into a piece of pipe within the stopper's pipe ID range.

(Make certain the test set up is in a safe place where the open end of the test pipe is pointed away from people.)

Inflate the stopper to the maximum allowable pressure either by using the stopper rod or a MDS Stopper Test Adapter [12100731].

After the stopper stabilizes, wait a minimum of 10 minutes to make certain the same pressure is maintained within the MDS Stopper.

NOTE: Do not inflate the stopper outside of a pipe as it can damage the stopper.

Using rod:



Using MDS Stopper Test Adapter:

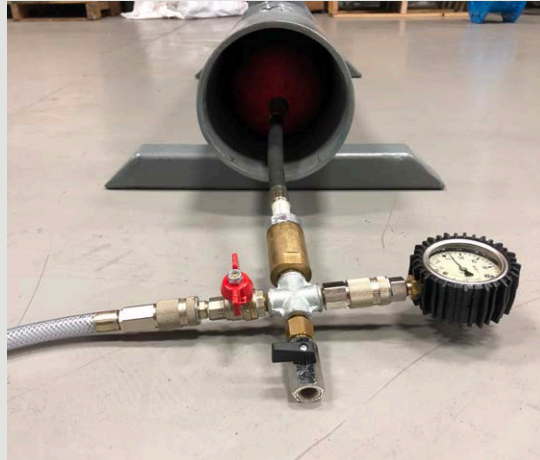

For proper MDS Stopper insertion into the pipeline, use Kleiss silicone spray to lubricate the stopper.







Spray the back of the stopper at the conical connection.

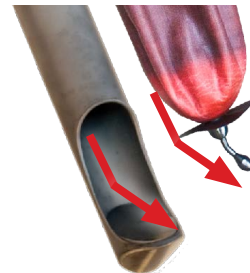

Spray the front of the stopper around the nose.

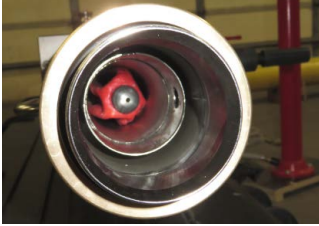
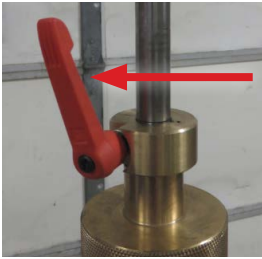
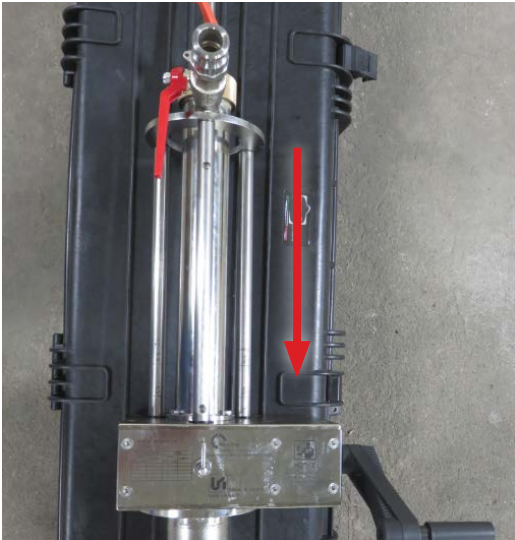
NOTE: For 8" only, make certain the stopper tip is rotated so the rounded curve of the stopper tip will slide along angled part of chute when deployed.



<ul style="list-style-type: none"> ❑ Pull stopper up into tower. 	
<ul style="list-style-type: none"> ❑ Lock the stopper rod by operating the orange handle. 	
<ul style="list-style-type: none"> ❑ Grease stopper rod with silicone grease. 	
<ul style="list-style-type: none"> ❑ Operate the gear handle and crank gear box to lowest position. 	
<ul style="list-style-type: none"> ❑ Select the proper chute from the sizing table in Section 4.0. <p>NOTE: Locate the chute identification number (stamped 1 or 2) on the bottom of the chute.</p>	
<ul style="list-style-type: none"> ❑ Connect the chute into the bottom of the stopping tower. <p>(There is only one way to connect the chute properly and that is to match the pin and hole. The chute fits the tower properly if a “click” is heard after insertion.)</p>	
<ul style="list-style-type: none"> ❑ Using the same Kleiss silicone spray you used on the stopper, lightly spray the open end of the chute. 	

❑ Operate the gear handle and crank gear box to highest position completely retracting the chute into the tower. (Locking pins will engage when in highest position.)

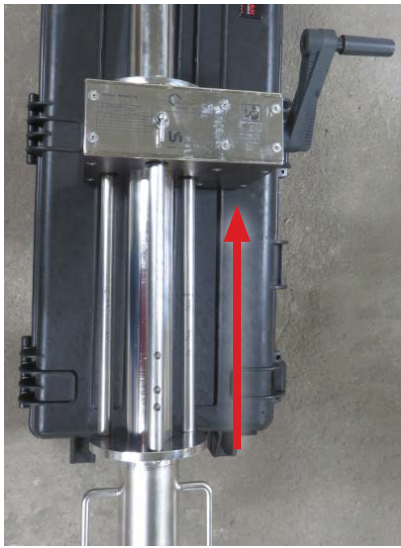

❑ Install the flow stopping tower onto the ball valve and turn the tower clockwise until some resistance is experienced.



❑ Position the stopping tower so stopper will be inserted into the correct position. (Reference arrow on gear box.)

NOTE: MDS Stopper is always deployed opposite of the by-pass / vent port.



❑ Tighten the brass collar by means of the hooked wrench and make sure the MDS Stopper stays in the right position.

When doing this, make certain the valve doesn't inadvertently turn.



❑ Close the valve of the by-pass / vent port.



❑ Open the ball valve and check for any leaks in the stopping tower. Use leak soap if necessary.

Correct any blow-by or leaks before continuing stopping operation.

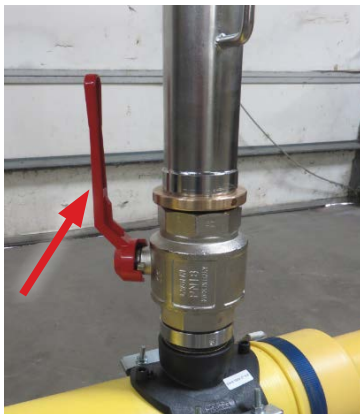

❑ Locate the proper height indication on the rods of the tower. (These indications identify the position of the chute inside the pipeline based on the size of the pipe.)

NOTE: The left rod shows indications for cast iron, polyethylene, and PVC pipelines. The right rod shows indications for steel pipelines.



❑ Control the crank handle on the gear assembly and unlock the gear assembly.

****Once you have unlocked the gearbox assembly, you now have pressure pushing upwards. Maintain control of the gearbox using the handle****

Using the crank handle, lower the gear box down until appropriate height indicator on rod is visible on top of the gear box. (This lowers the chute into the pipeline.)



❑ Lock the tower at this position. (The chute is now in the correct position inside the pipeline and you can commence inserting the stopper into the pipeline.)



❑ Attach safety bumper



❑ Unlock the stopper rod by operating the orange handle.

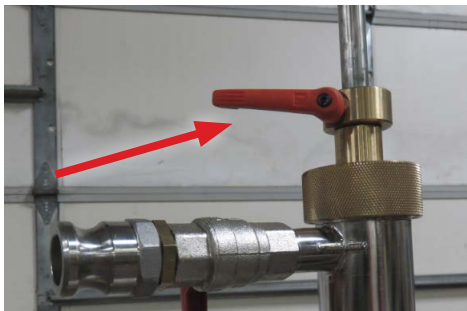

❑ Push the stopper rod downwards. You may have to use a little force to do so. **Try NOT to rotate the stopper rod when inserting.**

Stop pushing the stopper rod downwards when the depth indicator mark is at the brass locking component.



❑ Lock the stopper rod by operating the orange handle.

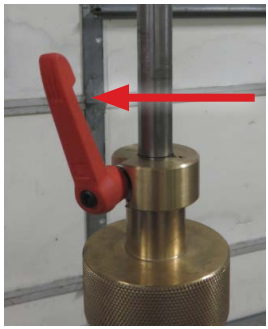

❑ *Recommended:* If needed or applicable, attach By-Pass Gauge Tree [BPGT-1] to by-pass / vent port.

NOTE: Additional options are available in the 4.0 Accessories section.

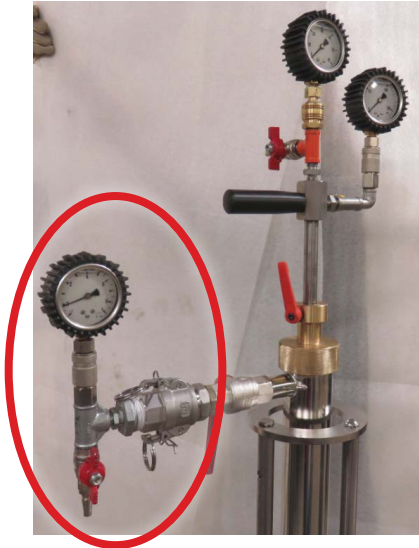

❑ Prior to stopper inflation, verify system / pipeline pressure is displaying on proper gauge.

The MDS Stopper inflation pressure gauge will be indicating a negative pressure.

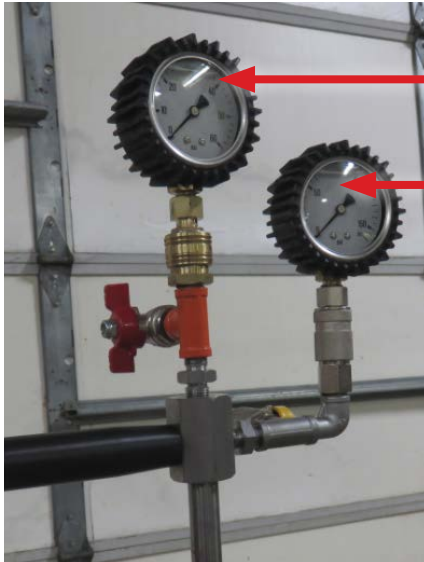

❑ Inflate the stopper to 120 psi via compressor or nitrogen source. Inflate stopper as rapidly as possible to ensure the best seal on pipeline wall.

NOTE: If 120 psi is not obtainable, then inflate to a minimum of 2 times system pressure to achieve stop off.

❑ Install safety fitting on inflation pressure port.



❑ Allow the stopper to stabilize inside the pipeline for at least 10 minutes.

❑ Evacuate or purge pipeline work area. Use the by-pass / vent port on tower and vent stack, if desired. (Do this in accordance with your gas company procedures.)



by-pass / vent port

❑ Verify inflation pressure and system pressure remains stable.

❑ You may now start your work on the pipeline.

NOTE: Continue to monitor gauges on stopping towers.

8.0 Retrieving MDS Stopper:

- ❑ **NOTE: Always equalize pressure on both sides of the stopper before deflation or removal.**

After the work on the pipeline is complete, equalize the pressure behind the MDS Stopper and in front of the MDS Stopper.

This can be done in a variety of ways. Refer to examples in Section 3.0 of this manual and your gas company procedures.

*** ALWAYS EQUALIZE PRESSURE ***

- ❑ Once pressure is equalized, open the inflation valve of the MDS Stopper to deflate the stopper. Pressure inside the pipeline will assist with the evacuation.



- ❑ Connect the hand pump to the stopper inflation connection and pull a vacuum on the stopper to make it as compact as possible.

❑ Unlock the stopper rod by operating the orange handle.

❑ Pull the stopper rod completely upwards until you feel resistance. Then turn the stopper rod clockwise continuously while lifting upward until the stopper is free.

Instructions to use the jacking accessory can be found in appendix C (page 49)



❑ Once the stopper is all the way retracted in the tower, lock the stopper rod by operating the orange handle.

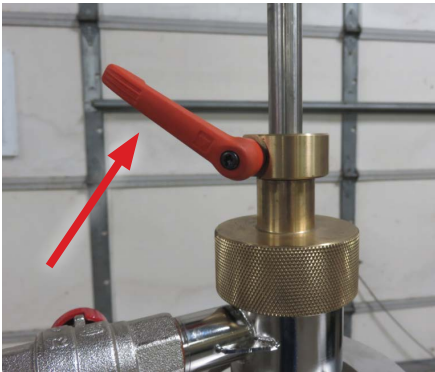

☐ Unlock the gear box assembly and crank the gear box to the highest position moving the chute out of the pipeline.

Once you have unlocked the gearbox assembly, you now have pressure pushing upwards. Maintain control of the gearbox using the handle



☐ Lock the gear assembly.

☐ Close the ball valve.







☐ Open the by-pass / vent valve in order to evacuate the stopping tool.



☐ Unlock the brass collar between the stopping tool and the ball valve by means of the hooked wrench.

When doing this, make certain the valve doesn't inadvertently turn.



<p><input type="checkbox"/> Remove the stopping tool from the ball valve.</p>	
<p><input type="checkbox"/> Remove the chute from the stopping tool. (Crank gear assembly to the lowest position to expose the chute.)</p>	
<p><input type="checkbox"/> Disconnect the MDS Stopper from the stopping tool. (Push stopper rod to lowest position to expose the stopper connection.)</p>	
<p><input type="checkbox"/> Clean and store MDS Stopper in transportation case. Do not leave it on the ground.</p> <p>Inspect the stopper for damages.</p> <p>Clean the stopper with a cloth.</p> <p>Place a protection cap over the thread.</p>	
<p><input type="checkbox"/> Remove gauges.</p>	
<p><input type="checkbox"/> Clean and store stopping tool in its case.</p>	

9.0 Plugging Operation:

- ❑ Assemble the plug spindle and drilling dome together. Verify bottom o-ring is in place.

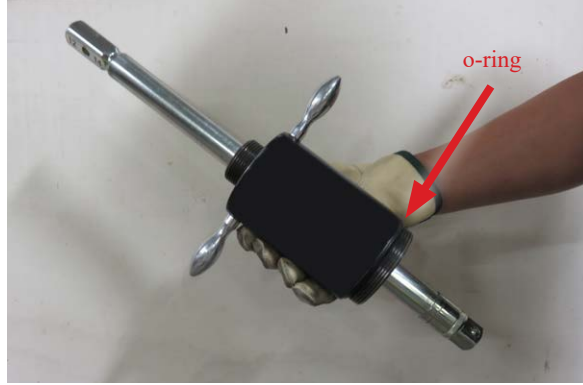

- ❑ Connect the completion plug onto the plug spindle. The connection is good when the detent balls of the plug spindle grip the completion plug. You will hear a positive click.



- ❑ Fully retract the plug into the dome.



- ❑ Install the dome onto the ball valve and tighten the dome by hand.



- ❑ Make certain the plugging spindle is at the top of the dome.

Keep control of the spindle.

Verify drilling dome bleed valve is closed.

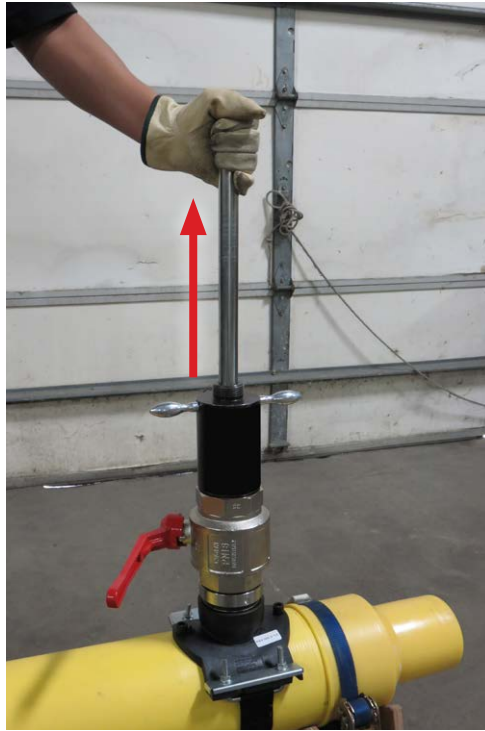

- ❑ Open the ball valve.



- ❑ Place the ratchet handle on top of the plug spindle.

Push the plugging spindle fully downwards.

- ❑ Screw the plug into the fitting with the ratchet until bottomed-out and tight.



❑ Test to make sure there is a seal by opening the bleed valve on the dome and relieving the pressure in the dome.



❑ After the plug seal has been verified, pull the plug spindle fully upwards (out of the completion plug).





❑ Remove the dome from the valve.



❑ Remove the valve from the ring adapter.



<p>❑ Remove the ring adapter from the fitting by means of the hooked wrench.</p>	
<p>❑ Prior to placing the completion cap, inspect the completion plug again for any leakage.</p>	
<p>❑ Screw the completion cap onto the fitting.</p>	
<p>❑ Disassemble the completion tool.</p>	
<p>❑ Clean and store the completion tool and valve in their respective cases.</p>	

10.0 General Maintenance:

All equipment should be cleaned and inspected for wear after each job to prolong the life of the equipment and ensure the safety of the operators.

<input type="checkbox"/>	Inventory all system components (refer to Section 4.0 Equipment)
<input type="checkbox"/>	Visually inspect the cutters and pilot drills
<input type="checkbox"/>	PE cutter - no missing or chipped teeth (13100080)
<input type="checkbox"/>	Steel and cast iron cutter - looks to be in good condition (13200140)
<input type="checkbox"/>	Pilot drill - looks to be in good condition (14300058)
<input type="checkbox"/>	NOTE: The best indication of the condition of the cutter and pilot drill is the coupon removed from the pipe. Smooth cuts indicate good condition and jagged / rough cuts indicate wear of the cutter and pilot drill.
<input type="checkbox"/>	Grease the tapping device, if needed (10310800)
<input type="checkbox"/>	Inspect gauges for any damage and ensure they are reading zero and function properly
<input type="checkbox"/>	Inspect stopper rod for bends and/or damage
<input type="checkbox"/>	Check to make sure the gear box is operating freely with no binding or grinding
<input type="checkbox"/>	Clean ALL threads and quick connections
<input type="checkbox"/>	Inspect and clean all chutes (quantity 2)
<input type="checkbox"/>	Inspect to make sure ball valve is opening and closing smoothly and functioning properly
<input type="checkbox"/>	Inspect all bolts, screws, and joints
<input type="checkbox"/>	Inspect MDS Stoppers for any excessive wear and replace if necessary (refer to Appendix A)
<input type="checkbox"/>	Make sure protective cap is on the stopper to protect the threads
<input type="checkbox"/>	Thoroughly clean off any dirt, debris, and grease on all tools and stoppers with a lint free cloth and water (well-maintained equipment extends the life)

NOTE: MCS recommends that the complete set of tools be inspected, serviced, and tested by an authorized MCS service center on a two year rotation or sooner.

APPENDIX A: Stopper Testing and Verification

- ❑ Visually inspect the stopper for weak spots and integrity.

Discard stopper if weak spots are found.

Continue with inspection if everything looks OK.

OK Examples:

Coating is coming off, but individual threads are not showing.



Bad Examples:

Discard stoppers shown below since individual threads are exposed, starting to fray, and loose from coating.

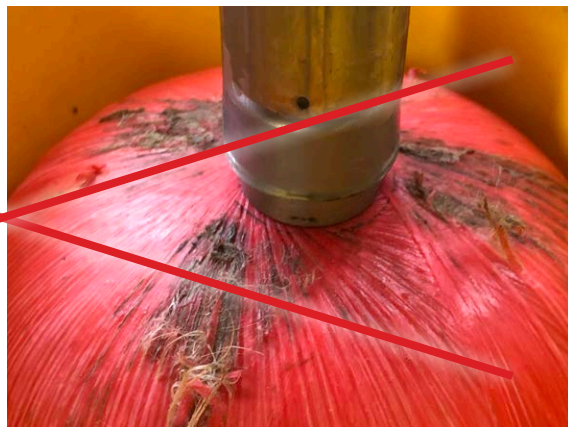
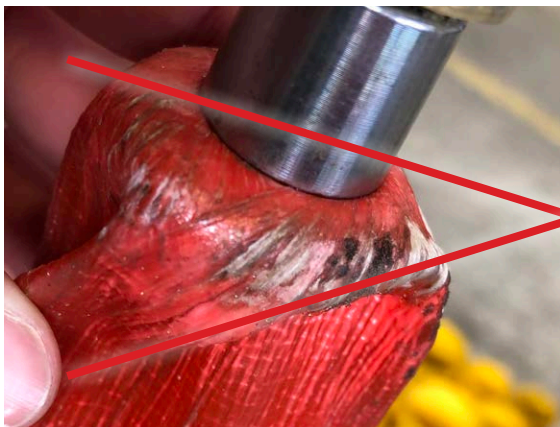

- ❑ Verify internal spring mechanism is still working.



- ❑ Pull a vacuum (negative pressure) on the stopper.

This can be done on the complete stopper rod of the tower (to ensure complete system is intact before a job) or using the MDS Stopper Test Adapter [12100731].

Verify fiber gasket in either device is intact.

Verify negative pressure is maintained for 5 minutes.

Using rod:



Using MDS Stopper Test Adapter:



- ❑ If the condition of the stopper is still uncertain or additional stopper testing is desired, insert the stopper into a piece of pipe within the stopper's pipe ID range.

(Make certain the test set up is in a safe place where the open end of the test pipe is pointed away from people.)

Inflate the stopper to the maximum allowable pressure either by using the stopper rod or a MDS Stopper Test Adapter as noted in the previous step.

After the stopper stabilizes, wait a minimum of 10 minutes to make certain the same pressure is maintained within the MDS Stopper.

NOTE: Do not inflate the stopper outside of a pipe as it can damage the stopper.

Using rod:



Using MDS Stopper Test Adapter:



APPENDIX B: Tower Positioning and Distances

Example I – Stoppers Positioned Towards Each Other [Illustration of One Side of Work Area]

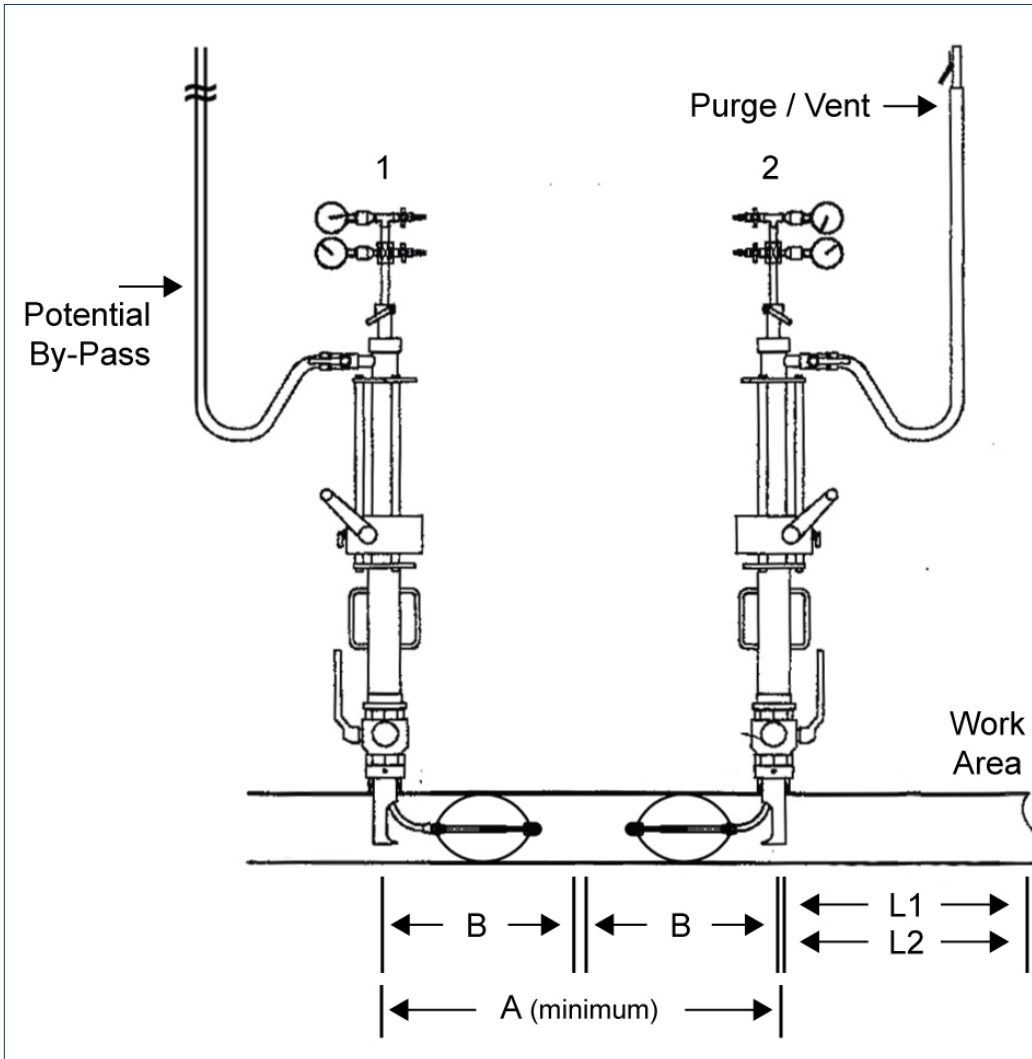

STOPPING TOWER DISTANCES

Nominal Pipe Size	A (minimum)	B	L1 = Steel Welding	L2 = PE, CI, and Mechanical
3"	40"	20"	18"	9" *
4"	44"	22"	24"	12" *
6"	52"	26"	30"	18" *
8"	72"	36"	36"	24" *

*A = minimum distance between towers | B = stopper length | L1 = minimum distance from stopper/tower to work area
L2 = distance from stopper/tower to work area (* measurement is a guide only, follow manufacturer's fitting recommendations)*

NOTE: Always inflate stopper #2 first, if possible.

**Example II – Both Stoppers Positioned Away From Work Area
[Illustration of One Side of Work Area]**

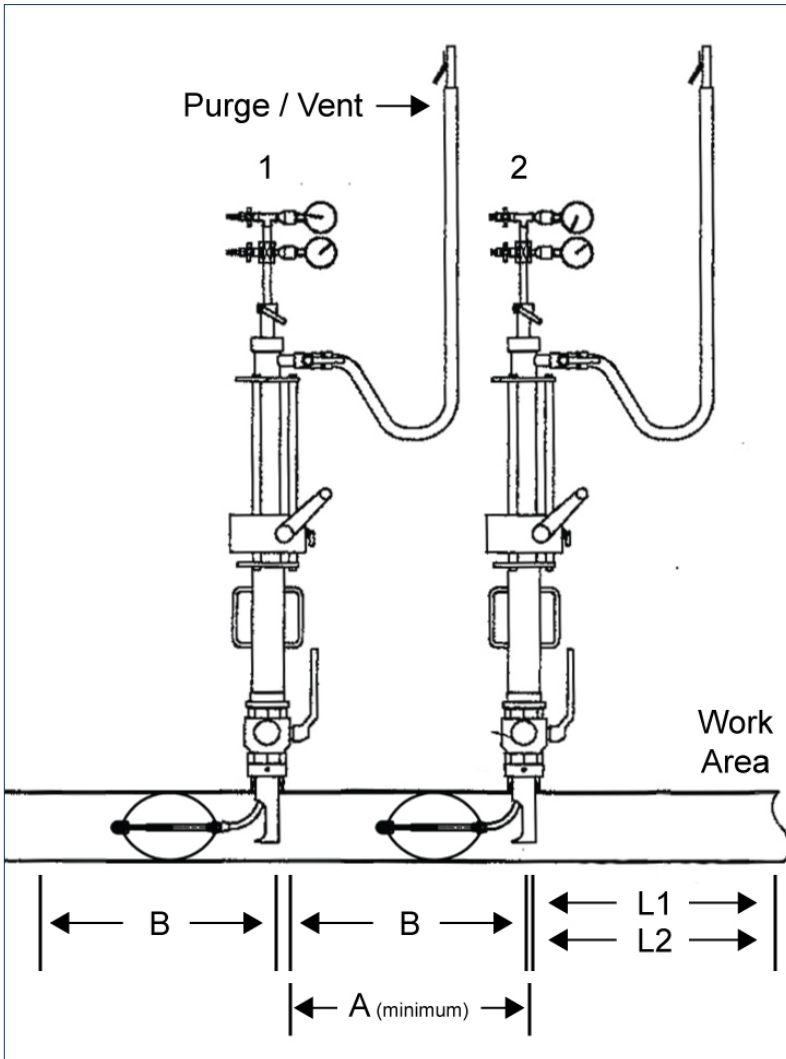

STOPPING TOWER DISTANCES

Nominal Pipe Size	A (minimum)	B	L1 = Steel Welding	L2 = PE, CI, and Mechanical
3"	20"	20"	18"	9" *
4"	22"	22"	24"	12" *
6"	26"	26"	30"	18" *
8"	36"	36"	36"	24" *

A = minimum distance between towers | B = stopper length | L1 = minimum distance from stopper/tower to work area

L2 = distance from stopper/tower to work area (measurement is a guide only, follow manufacturer's fitting recommendations)*

**Example III – Stoppers Positioned Away From Each Other
[Illustration of One Side of Work Area]**

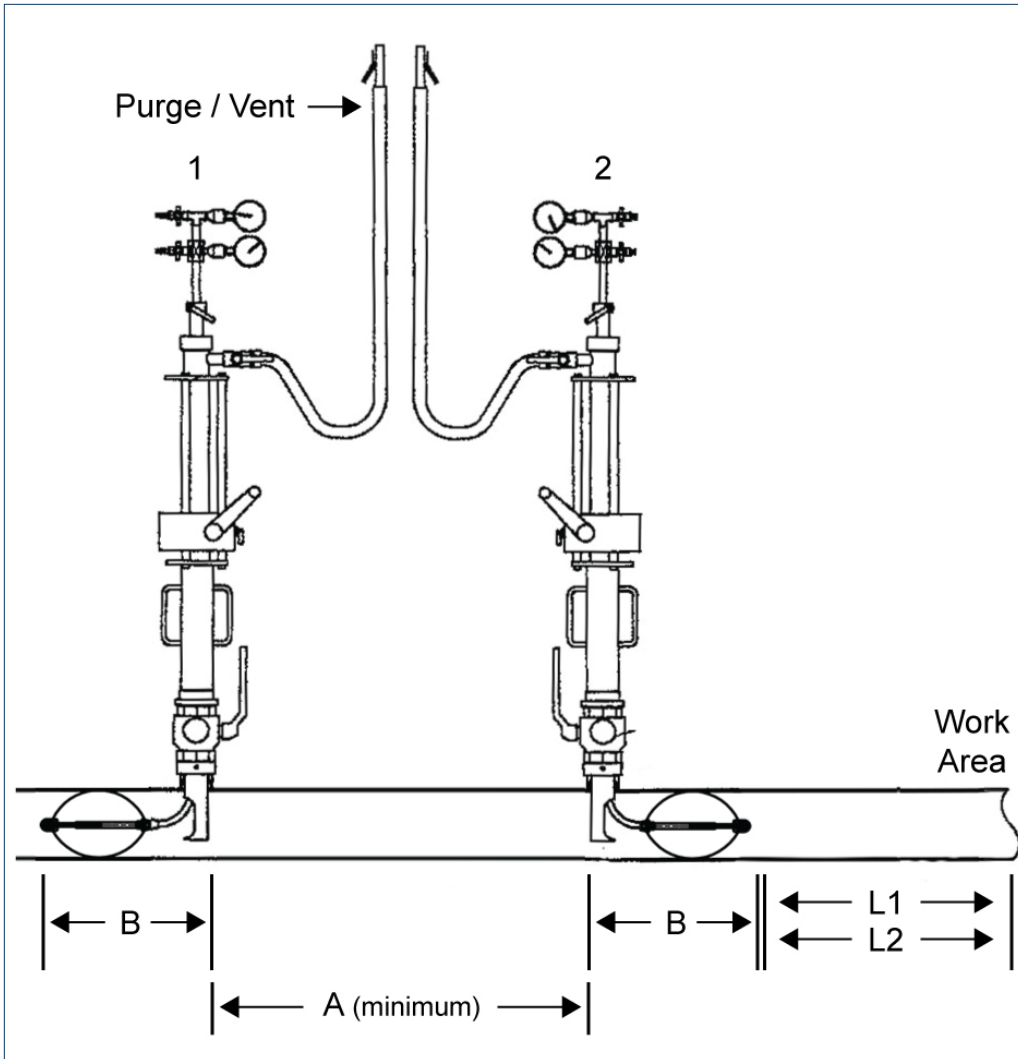

STOPPING TOWER DISTANCES

Nominal Pipe Size	A (minimum)	B	L1 = Steel Welding	L2 = PE, CI, and Mechanical
3"	24"	20"	18"	9" *
4"	24"	22"	24"	12" *
6"	24"	26"	30"	18" *
8"	24"	36"	36"	24" *

A = minimum distance between towers | B = stopper length | L1 = minimum distance from stopper/tower to work area

L2 = distance from stopper/tower to work area (measurement is a guide only, follow manufacturer's fitting recommendations)*

**Example IV – Both Stoppers Positioned Towards Work Area
[Illustration of One Side of Work Area]**

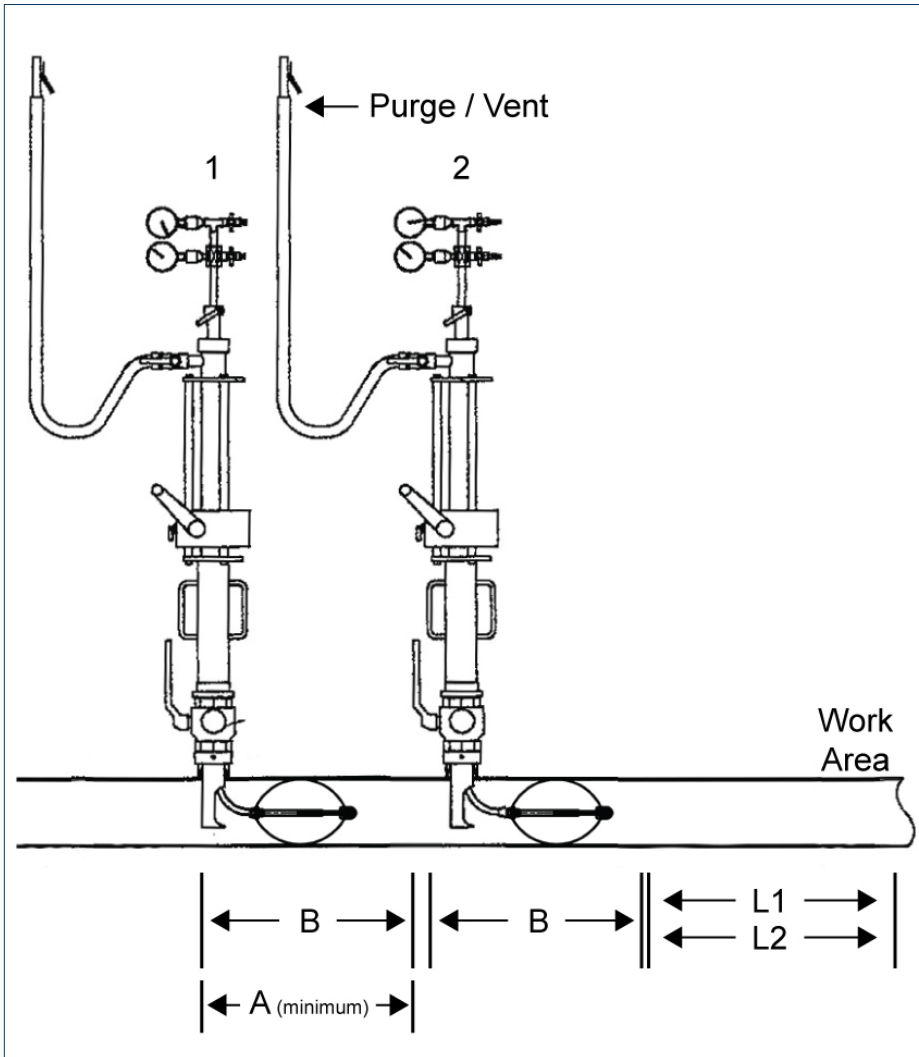

STOPPING TOWER DISTANCES

Nominal Pipe Size	A (minimum)	B	L1 = Steel Welding	L2 = PE, CI, and Mechanical
3"	20"	20"	18"	9" *
4"	22"	22"	24"	12" *
6"	26"	26"	30"	18" *
8"	36"	36"	36"	24" *

A = minimum distance between towers | B = stopper length | L1 = minimum distance from stopper/tower to work area

L2 = distance from stopper/tower to work area (measurement is a guide only, follow manufacturer's fitting recommendations)*

APPENDIX C: New Jacking Tool Instructions

MCS60-38 Jacking Tool for Stopper Extraction Assistance

After MDS stopper equalization, stopper deflation and stopper vacuum procedure from section 8.0 is complete:

- 1) Unlock stopper rod
- 2) Pull the stopper rod up until the knuckle & crimp of the stopper hose meet the top of the chute opening (stiff resistance will be met)
- 3) Re-lock the stopper rod
- 4) Attach the jacking tool, making sure the connection chains are free & not caught in any moving parts
- 5) Unlock stopper rod
- 6) Simultaneously turn the stopper rod in a clockwise direction and use the jack tool to assist with extraction of the rod and stopper from the pipeline
- 7) Slight resistance will be felt as the knuckle of the stopper passes up into the chute
- 8) Raise stopper rod to its highest position
- 9) Lock stopper rod, remove jack assist tool and continue

If the stopper rod is bending or there is too much resistance, stop immediately. Reset the stopper rod and restart.



APPENDIX D: Manual Updates

V15 May 2020

- 1) Updated steel welding distance (L1) in table in Section 3.0 and Appendix B
- 2) Edited cast iron pipe sizing/equipment table (section 4.0) from nominal pipe size to OD range
- 3) Tapping operation
 - a) Added step to rotate drilling rod clockwise to assist in retracting cutter
- 4) Stopper tower operation
 - Added new step of greasing stopper rod

V16 August 2021

- 1) Updated the max flow rate in Section 2.7
- 2) Added further instructions to Section 5.0
 - a) Verify there is no weld slag in the fitting
 - b) Verify plug insertion and seals are intact
- 3) Added bold statement to control the gearbox when the unit is unlocked due to upward pressure.
- 4) Added new style tapping device instruction to Section 6.0
- 5) Appendix C has been changed to instructions for the new jacking system

V17 September 2022

- 1) Updated the 3" adapter part number for all material types in Section 4.0

V18 January 2024

- 1) Updated the pilot drill part number for all material types
- 2) Added to Section 3.0 and Section 5.0 - avoid launching or inflating stopper near fittings, joints, or other obstructions
- 3) Removed note not to spray body of stopper in Section 7.0
- 4) Updated stopper removal procedure in Section 7.0
- 5) Updated jacking tool extraction assistance instructions in Appendix C

V19 August 2024

- 1) Updated vacuum range
- 2) Updated double block and bleed recommendations

