

# Energy- Related Best Practices:

A SOURCEBOOK FOR THE  
CHEMICAL INDUSTRY

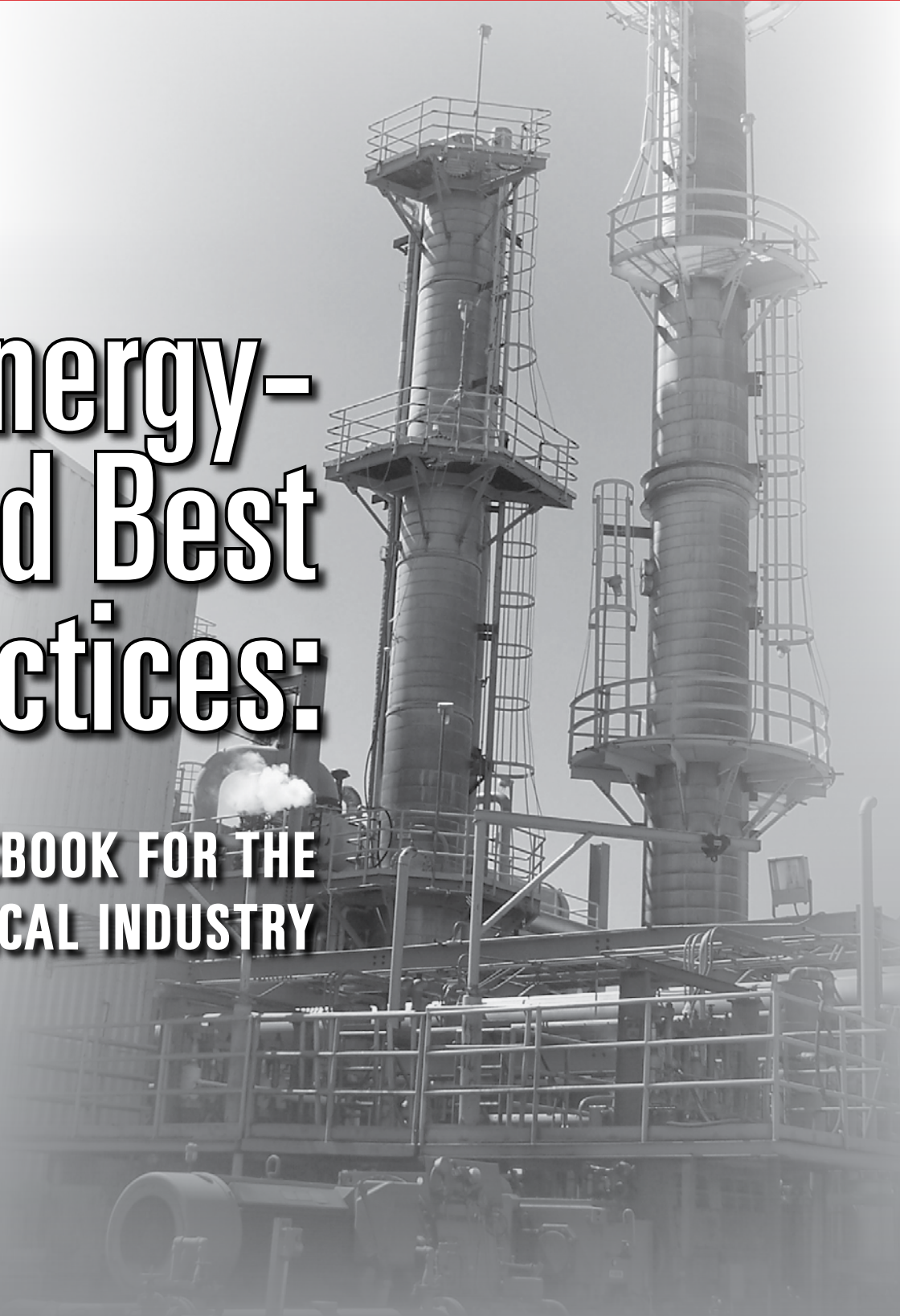

# **Energy-Related Best Practices: A Sourcebook for the Chemical Industry**

Coordinated by:



**November 2005**

# ACKNOWLEDGEMENTS

Many people have contributed to the creation and publishing of this document. Special thanks are extended to the individuals and companies noted below.

- Iowa Energy Center, Ames, especially Bill Haman, P.E., Industrial Program Manager
- Industrial Assessment Center at Iowa State University, Ames
- Fort Dodge Animal Health, Charles City, IA, especially Jerry Jenkins for allowing the project team to visit their site while developing the chiller and steam sections
- Procter and Gamble, Iowa City, IA, especially Theresa Harder and Jerry Ford for allowing the project team to visit their site while developing the steam section
- Monsanto, Muscatine, IA, especially Oscar Berryman and Bernie Becker for allowing the project team to visit their site while developing the steam and chiller sections
- Quad County Corn Processors, Galva, IA, especially Mike Jerke for allowing the project team to visit their site while developing the process heat section
- Terra Industries, Sergeant Bluff, IA, especially Clyde Knox and Dan Walters for allowing the project team to visit their site while developing the process heat section
- Koch Nitrogen, Fort Dodge, IA, especially Janelle Reese for allowing the project team to visit their site while developing the materials for the pump and motor section
- Diamond Vogel Paints, Orange City, IA, especially Scott Heemstra for allowing the project team to visit their site while developing the chiller section
- Arvind Thekdi, E3M Inc., North Potomac, MD, for his contributions to the process heating section
- Don Casada, Diagnostic Solutions, LLC, Knoxville, TN, for his contributions to the pump and motor section
- Bill Turpish, W. J. Turpish and Associates, Shelby, NC, for his contributions to the chiller section
- Kelly Paffel, Plant Support & Evaluation, Inc., Naples, FL, for his contributions to the process steam section
- Ronald Cox, Director, CIRAS, Iowa State University Extension
- Mike Strobe, CIRAS, Iowa State University Extension
- Trevor Gilbertson, CIRAS, Iowa State University Extension
- Rudy Pruszko, CIRAS, Iowa State University Extension

# ENDORSEMENTS

Individuals in companies within Iowa's chemical industry reviewed sections of this report. They have provided their endorsements and support for the study and its content. The companies are listed below:

- Fort Dodge Animal Health, Charles City, IA
- Procter and Gamble, Iowa City, IA
- Monsanto, Muscatine, IA
- Quad County Corn Processors, Galva, IA
- Terra Industries, Sergeant Bluff, IA
- Koch Nitrogen, Ft. Dodge, IA
- Diamond Vogel Paints, Orange City, IA

## Table of Contents

1. Introduction .....	5
2. Energy Management .....	9
3. Understanding The Energy Cost Structure.....	22
4. Process Heating Systems.....	25
5. Process Steam Systems .....	54
6. Chillers .....	78
7. Pumps and Motors .....	89
8. Available Resources.....	117

# 1. Introduction

## 1.1 The Chemical Industry

The North American Industry Classification System (NAICS) groups businesses into categories based on their primary activities. NAICS has replaced the older Standard Industry Codes (SIC) to provide a common basis for economic data collection and analysis for the United States, Canada, and Mexico. The chemical industry, which includes all chemicals from commodities (e.g. ethylene and ammonia) to finished products like cosmetics and pharmaceuticals, is part of the manufacturing sector. Its NAICS classification code is 325xxx. The sub-sectors are:

- 3251xx Basic Industrial Chemicals (including ethanol)
- 3252xx Resin, Synthetic Rubber, and Artificial Synthetic Fibers and Filaments
- 3253xx Pesticides, Fertilizers, and Other Agricultural Chemicals
- 3254xx Pharmaceuticals and Medicine
- 3255xx Paints, Coatings, and Adhesives
- 3256xx Soaps, Cleaning Compounds, and Toilet Preparation Chemicals
- 3259xx Other Chemical Products and Preparation Chemicals

An integral part of the U.S. economy since the 17<sup>th</sup> century, the modern chemical industry produces more than 70,000 diverse products. Indeed, few goods today are manufactured without some involvement with the chemical industry. Nearly 24% of all chemicals produced are used as feedstock in other chemical manufacturing processes, and nearly 30% of the total production yield is purchased as raw materials by the rest of the manufacturing sector.<sup>1</sup>

## 1.2 Economic Impact

Chemical manufacturing is one of the oldest and most important manufacturing sectors in the United States. The industry currently accounts for nearly 5% of the nation's gross domestic product (GDP). Chemical production rates have grown steadily over the previous two decades, setting record sales and shipment numbers in both the 1997 and 2002 economic censuses. Data provided by the federal government's *Advance Report of the 2002 Economic Census* shows that the chemical industry includes 13,098 individual companies with combined sales numbers equaling approximately \$427.3 billion, a workforce of more than 789,000 employees, and an annual payroll of more than \$40.7 billion. Comparison of the 1997 and 2002 economic censuses shows marked increases in several categories, indicating sustainable growth within the industry.

Chemical manufacturing is Iowa's second largest industry, trailing only food processing in total sales. It contributes \$2.88 billion to Iowa's Gross State Product (GSP), which is 10% of the manufacturing GSP. There are approximately 367 chemical manufacturing plants categorized by the NAICS code 325xxx within the state. Approximately 80% of these chemical companies are involved with agricultural fertilizers, pesticides, or other ag-related chemicals. The remaining

---

<sup>1</sup> U.S. Department of Energy: Office of Industrial Technologies, *Energy and Environmental Profile of the U.S. Chemical Industry*, May 2000.

companies are comprised of a vast segment of manufacturers ranging from paint to pharmaceuticals.

These plants employ over 9,800 people. Figure 1.1 gives a breakdown of chemical industry employment within the state by county.<sup>2</sup>

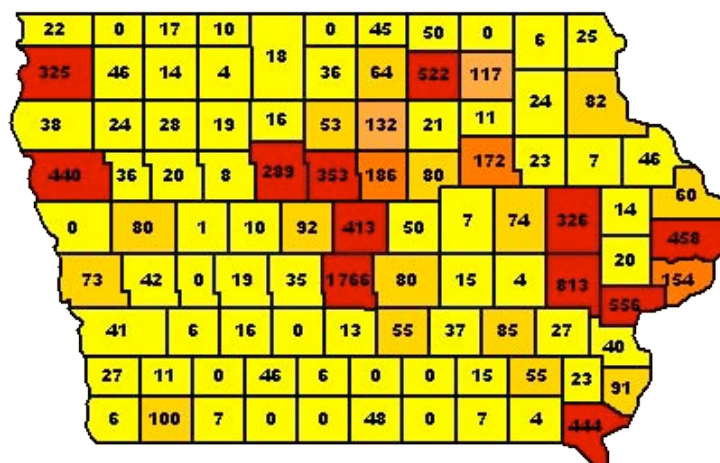

Figure 1.1 Breakdown of Employment by County<sup>2</sup>

### 1.3 Energy Consumption

The chemical industry is the second most energy-intensive enterprise in the United States, accounting for over 6500 trillion Btus (Tbtu) of energy use in 2002. This represents one-third of the total industrial energy used in America.<sup>3</sup> Over half of the energy consumed by the industry is in the form of feedstock (Figure 1.2). The rest is primarily used to provide heat, cooling, and power to manufacturing processes with only a small amount contributing to building utilities.

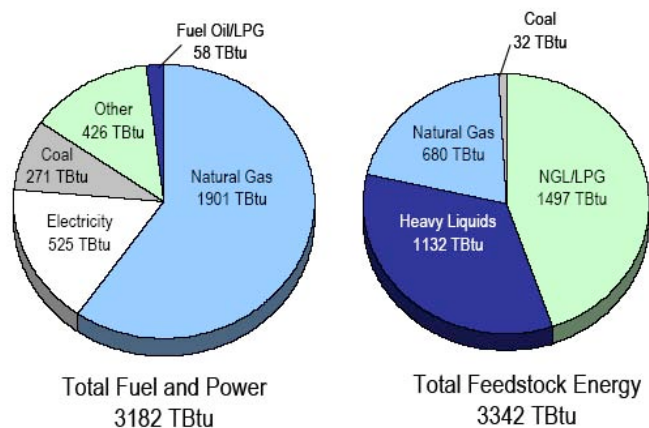

Figure 1.2 Energy Use in the U.S. Chemical Industry<sup>4</sup>

<sup>2</sup> Center for Industrial Research and Service, Iowa State University, *Chemicals Industry in Iowa*, <http://www.ciras.iastate.edu/industry.asp?i=325>.

<sup>3</sup> American Chemistry Council, *Guide to the Business of Chemistry 2003*, Washington D.C., 2003.

<sup>4</sup> American Chemistry Council, *Guide to the Business of Chemistry 2003*, Washington D.C., 2003.

Chemical processing requires large amounts of energy to convert raw materials into finished products, which makes the industry particularly vulnerable to fluctuations in energy prices. Chemical manufacturing is the largest consumer of natural gas in the United States, requiring more than 10% of the total amount used domestically.<sup>5</sup> Recent spikes in natural gas pricing have created a hardship for many chemical manufacturing companies; causing temporary shut downs in some regions of the country. The cost of fossil fuel energy sources are projected to continue to increase in the near future, causing further uncertainties in the chemical manufacturing markets.<sup>6</sup>

Energy efficiency has been a focus of chemical manufacturers since the 1970s. However, as Fig. 1.3 illustrates, significant improvements in this area did not come until the early 1990s. It is expected that rising energy costs will motivate the industry to continue refining energy efficiency measures in an effort to control costs and maintain competitiveness. The challenge faced by chemical manufacturers is how best to identify possible sources of improvement and implement changes that can take place quickly, while providing the most benefit with the smallest capital investment.

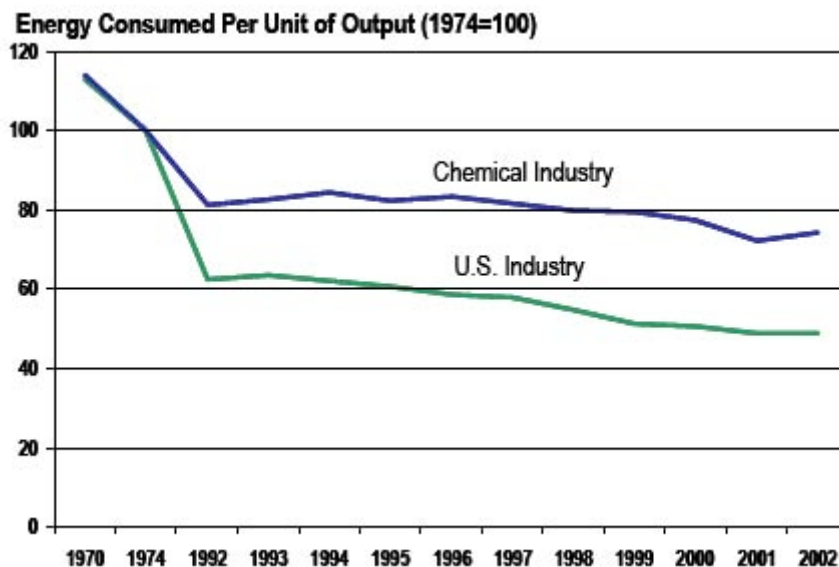

**Figure 1.3** Energy Intensity in the U.S. Chemical Industry<sup>7</sup>

#### 1.4 Purpose of Publication

This report serves two purposes: 1) to document the significance of energy management and efficiency to the chemical industry, and 2) to provide best practices for reducing energy consumption that are specific to Iowa's chemical industry. For purposes of this report, a best practice is defined as an activity or procedure that has been effective at conserving energy and

<sup>5</sup> U.S. Department of Energy: Office of Industrial Technologies, *Energy and Environmental Profile of the U.S. Chemical Industry*, May 2000.

<sup>6</sup> Brown, R., Chemical Marketing Reporter, *Energy Cost and Demand Issues are Key to Petrochemicals in 2004*, Vol. 265, No. 1, January 5, 2004.

<sup>7</sup> American Chemistry Council, *Guide to the Business of Chemistry 2003*, Washington D.C., 2003.



could be adapted to improve energy efficiency in other similar situation. Sponsorship from the Iowa Energy Center (IEC) and the Center for Industrial Research and Service (CIRAS) at Iowa State University provided funds to hire consultants to help identify best practices in Iowa's chemical industry and to create this best practices document.

### **1.5 Best Practices**

When analyzing systems for energy efficiency, it is often helpful to consider a systems approach, i.e., an analysis of the supply and demand side of a system and how each side interacts. An example of the supply side of a system would be replacing an oven burner with a more efficient design, thus reducing the natural gas consumed by the oven. An example of the demand side of a system would be improving the mechanical efficiency of a mixing process by changing the shape of the mixing device or by changing the motion of mixing. Thus, reducing the energy consumption per unit of product will save energy.

This publication will identify and discuss best practices from both supply and demand sides of the systems considered. While focusing on the two sides of a system is important, increasing efficiency on one side doesn't necessarily increase overall system efficiency, which is the ultimate goal of energy efficiency projects. The best practices discussed in this report are recommended to increase overall system efficiency, though it is important to understand how it will help a system as a whole.

## 2. Energy Management

### 2.1 Overview

While many chemical companies have tried to manage energy expenses by seeking cost-effective fuel sources, few have investigated the substantial savings inherent in energy management. Why? In simple terms, most manufacturing facilities lack organizational support for energy management despite the fact that it improves production, performance and profits.

The term “energy efficiency” refers to practices and standards set forth in an energy management plan. Energy efficiency initiatives should be selected for their ability to reduce expenses, build revenue, and contain operating risk.

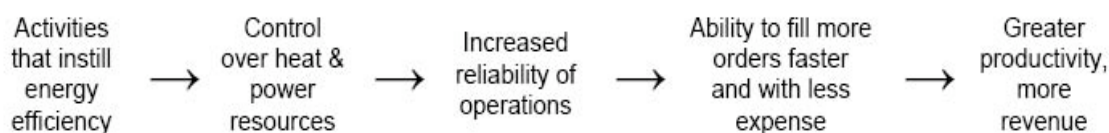

**Figure 2.1** Flow Chart of Energy Efficiency Activities<sup>8</sup>

As illustrated by Figure 2.1, unchecked energy expenditures impact every area of production and can actually decrease overall productivity. Facilities of all sizes, shapes, and functions use energy, so the potential for energy-based productivity gains is pervasive. Energy management is an ideal way to secure a competitive market advantage.<sup>8</sup>

### 2.2 Questions Concerning Current Management Plans

Companies that use management plans like Lean, Total Quality (TQ), Six Sigma, ISO 9000, and Theory of Constraints to achieve world-class performance may wonder whether an energy management (EM) program will work within their current initiatives and constraints. The answer, in *all* cases, is a resounding *yes!* EM will complement any initiative, regardless of a company’s state in the process. Whether a company’s just beginning TQ or is well into ISO 9000, it will still benefit from a strategic energy management program.

#### 2.2.1 Lean

According to the principles of Lean manufacturing, there are seven forms of waste: overproduction, unnecessary inventory, excessive transportation, inappropriate processing, unnecessary motion, waiting, and defects. At least five and arguably, all seven, involve energy waste. Clearly, efforts to manage energy are consistent with reducing waste.

#### 2.2.2 Total Quality

Parallels exist between Total Quality and energy management as well. Both start with a commitment from the top, are data driven, and involve a cultural change for all of the employees in the organization. TQ provides many tools to make an EM program more effective.

<sup>8</sup> Russell, C., Alliance to Save Energy, *Energy Management Pathfinding: Understanding Manufacturers’ Ability and Desire to Implement Energy Efficiency*, March 2005.

### 2.2.3 Six Sigma

Six Sigma, which is data driven, focuses on improving the quality of all processes, including energy management plans. Similar to TQ, the tools of Six Sigma can and should be used to enhance the quality of an effective EM program.

### 2.2.4 ISO 9000 and ISO 14000

ISO 9000 and ISO 14000 are also widely used in the chemical industry. These two standards will work with EM to simultaneously build high quality into the EM program and to improve the program as it develops over time.

### 2.2.5 Theory of Constraints

Theory of Constraints (TOC) is based on the concept that improving a few capacity constraint resources in a production system will have the greatest impact on the bottom line. In energy intensive industries like chemical processing, energy intensive equipment and operations are frequently the largest bottlenecks in the process. When such equipment is truly a physical constraint, reducing energy consumption per unit by increasing the flow rate at that piece of equipment will significantly improve bottom-line performance.

## 2.3 Energy Management Strategy Guide

While technology is fundamental to increasing efficiency through energy management, the real key (and often, the real hindrance) is the people charged with energy management duties. The main goal of any company attempting to reduce energy consumption through the use of an energy management plan should be to integrate the strategy into the daily operations and responsibilities of its management and employees.

The following energy management strategy guide may be useful to individual companies interested in developing a plan of action. It is important to note that energy management motives and approaches vary from company to company; there is no “one size fits all” plan. Therefore, prior to implementing a plan, companies must do an internal evaluation to determine the strategies that will work best for them.

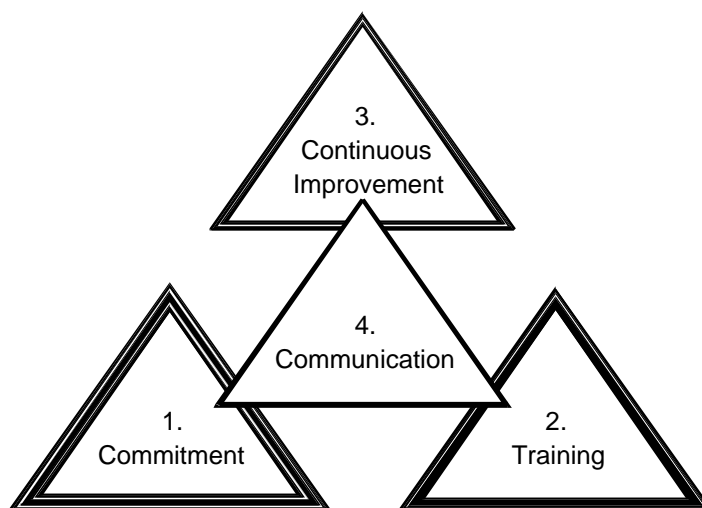

**Figure 2.2** Energy Management Guide

A strategic approach to energy management can result in significant energy savings and improved productivity for all types of chemical producers. A general guide for an energy management model is depicted in Figure 2.2. The model requires the coordination of four main issues:

1. Commitment from leadership.
2. Continuous training of personnel at all levels.
3. Continuous improvement through strategic goals and action plans.
4. Communication of all involved in the energy management concept.

This model draws on ideas from several existing programs, including the “Energy Star” program developed jointly by the U.S. Department of Energy and the Environmental Protection Agency.

### 2.3.1 Make the Commitment

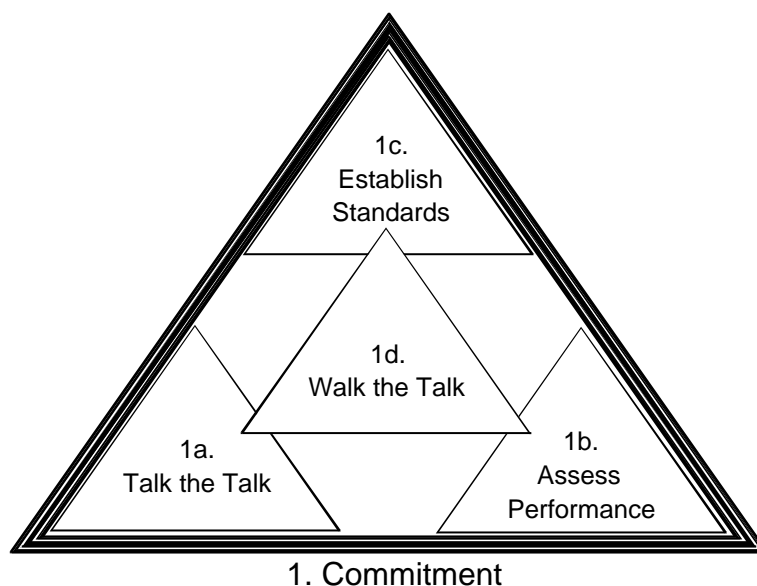

**Figure 2.3** Making the Commitment Guide

Dr. W. Edwards Deming, an Iowa native whom many consider to be the founder of the Total Quality (TQ or TQM) movement, refused to work with an organization unless its top leaders were involved in the improvement process. Commitment starts at the top, he believed. So it is with energy management—an effective EM program starts with the support and participation of company leaders. So, what constitutes real participation?

#### **Talk the Talk (1a Figure 2.3)**

Company leaders must be strong advocates for an EM program. In addition to supporting a corporate energy policy, they should make EM part of the corporate strategic plan, tying it to financial and environmental goals.

### Assess Performance (1b Figure 2.3)

Once energy management is truly on the corporate radar screen, an initial assessment of energy performance is necessary. It should include an understanding of the energy cost structure as well as an understanding of current energy use and trends. A more detailed discussion of these concepts follows.

#### *Understanding the Energy Cost Structure*

Utility companies generally determine the energy cost structure. Most utilities have multiple rate plans, which can complicate attempts to understand them. Customer service representatives work with businesses to ensure that the most favorable plan has been assigned. An onsite visit from the energy provider is one way to facilitate a discussion on energy needs and cost structures.

#### *Understanding Current Energy Usage and Trends*

Understanding current energy usage and trends goes hand-in-hand with understanding energy cost structures. Usage dictates the choice of rate plan, and the rate plan greatly influences cost-savings strategies. As much as feasible, energy usage should be tracked by both end use and fuel type.

#### *End Use*

An important step in energy management is determining the exact sources of energy consumption. The Centre for the Analysis and Dissemination of Demonstrated Energy Technologies (CADET) recommends establishing Energy Accountable Centers (EAC)<sup>9</sup> to facilitate this step of the process. These are production areas that are neither too small nor too large, in which energy consumption can be independently measured and reported. (It may be necessary to install meters for this purpose.) For example, it may be revealing to monitor the energy consumption of a separate building, a central boiler house, or a specific production line.

Many of the details of the end-use patterns can be defined by a technical assessment or energy audit. There are many sources for these audits. Larger companies may want to participate in the DOE's Plant Wide Assessment (PWA) program. "Plant-wide energy assessments investigate overall energy use in industrial facilities, and highlight opportunities for best practices in energy management, including the adoption of new, energy-efficient technologies and process and equipment improvements."<sup>10</sup> These projects, which require matching funds from the company, bring world-class experts into the facility. A very successful plant-wide assessment was done in Iowa at North Star Steel; details are available on the DOE website listed in the footnote below.<sup>11</sup> PWAs are competitive grants and most medium- and smaller-sized companies will not be able to participate in this large-scale project.

Another valuable resource for energy assessments is the DOE-funded Industrial Assessment Center (IAC). The IAC provides free energy audits to small- and medium-sized facilities. The

<sup>9</sup> *Energy Management in Industry, Analyses Series 17*, Centre for the Analysis and Dissemination of Demonstrated Energy Technologies, CADET 1995.

<sup>10</sup> DOE: *Plant Wide Assessment*, [http://www.oit.doe.gov/bestpractices/plant\\_wide\\_assessments.shtml](http://www.oit.doe.gov/bestpractices/plant_wide_assessments.shtml)

<sup>11</sup> *North Star Steel Company: Iowa Mini-Mill Conducts Plant-Wide Energy Assessment Using a Total Assessment Audit*, [http://www.oit.doe.gov/bestpractices/factsheets/steel\\_cs\\_northstar.pdf](http://www.oit.doe.gov/bestpractices/factsheets/steel_cs_northstar.pdf)

center that serves Iowa (and some of the area in surrounding states) is located on the Iowa State University campus. For more information about the program and complete eligibility requirements (less than 500 employees, \$100K to \$2.5M in energy costs, etc.) check out the website listed in the footnote below.<sup>12</sup>

A third resource for identifying potential energy efficiency assistance is CIRAS or the Iowa Manufacturing Extension Partnership (IMEP). CIRAS/IMEP can conduct onsite assessments and connect manufacturers with the appropriate programs or resources to help them with their energy needs.

### *Fuel Type*

Businesses that use multiple sources of fuel (e.g., electricity, natural gas, oil, and/or steam) are encouraged to keep records of the amount of each fuel type consumed. It can be useful to measure the distribution of major energy forms such as steam in order to know the total amount of steam used by any one piece of equipment.

### **Establish Standards (1c Figure 2.3)**

A system of energy accounting is needed to collect and track useful data. This involves defining the data to be collected and the measures to be generated. Each company should develop a customized prime measure to calculate whether the energy purchased is being productively utilized.

### *Energy Productivity Index*

The energy productivity index is a ratio of energy consumed, usually stated in British Thermal Units (Btu), to a chosen base unit. This performance measure is very important, so the base unit must be carefully chosen. Possible base units include:

- per square foot of space
- per piece manufactured or shipped
- per pound, gallon, or some other measure of output
- per dollar of sales
- per dollar of “value added”

Each of these possible base units has advantages and limitations. For example, using square footage makes more sense when HVAC is the primary energy consumer but less sense when process energy consumption is significant. The shortcoming to using dollars of sales is that, over time, the figure is distorted by inflation. Using pounds, gallons, or some other appropriate measure of output/volume that has a logical relationship to energy consumed is often a good approach. It may be advisable to use a monetary unit that’s directly related to business performance, like dollars of value added. Using both of these measures will give company leaders two important views: how energy management reduces energy cost when measured by cost per unit volume of output, and how energy costs compare to the prices that customers are willing to pay for value-added products.

---

<sup>12</sup> *Industrial Assessment Center*, <http://www.me.iastate.edu/iac/>

### *Energy cost index*

One additional useful index is the energy cost index. It compares the cost of energy to some base unit (as opposed to the number of Btus consumed). The base unit should be the same unit used for the energy utilization index.

### *Productivity Standards*

Most chemical processors have standards for judging the performance of their production system over time. Similarly, it is recommended that standards be established for energy usage so that the performance of the EM system can be judged over time. Two basic approaches to establishing standards are discussed in the following paragraphs.

Engineering data can be used to calculate energy and mass balances, and the amount of energy theoretically required when equipment in the plant is performing optimally. However, while this calculation is useful, the result is often not considered “realistic” or achievable “in the real world.” For this reason, some will reject using this as a standard.

A second method is to compile data on past energy consumption. This data should be segmented by EACs whenever possible. An average consumption over some period of time can be calculated and used as a standard. To be “realistic,” it may be necessary to consider factors such as time of year; the “standard” amount of required energy can vary greatly depending on outside temperature and humidity.

While average past energy consumption might accurately predict probable future energy consumption, it does not give any indication of how efficiently energy is being used in each EAC. For this purpose, a combination of the two methods may be useful. The calculations based on the engineering data that show theoretical optimal efficiency can be compared with the average (or seasonal average). This will give an idea of the “money on the table,” or theoretical potential savings from improving efficiency.

Companies may choose to set the standard at the statistical average or at a different point based on the theoretical optimum. In either case, performance can be monitored against the standard and variation can be managed appropriately according to each company’s chosen management approach.

Another possible source for setting a standard is benchmarking. This technique has strong supporters and opponents. To be effective, benchmarking requires enough demographic and quality information about another company to determine whether or not a comparison is appropriate. In other words, the comparison should be apples to apples, not apples to oranges.

It may be safer to benchmark against “best practices.” For example, DOE has developed computer-based tools that allow one company that uses steam to compare itself to another company that also uses steam. These tools are available at no cost at the website in the footnote below.<sup>13</sup>

---

<sup>13</sup> DOE Industrial Technologies Program, [http://www.oit.doe.gov/bestpractices/software\\_tools.shtml](http://www.oit.doe.gov/bestpractices/software_tools.shtml)

One of the basic tenets of Lean Manufacturing, a method for reducing waste, is “perfection.” Rather than being satisfied with meeting some benchmark, companies are urged to relentlessly pursue perfection or zero waste. Zero waste in energy consumption may be hard to define, unless the calculated theoretical energy balance point mentioned earlier is used. Opponents argue that perfection is not a realistic goal because it is impossible to achieve. On the other hand, advocates stress that it is the pursuit of perfection that forces managers to look for the breakthrough ideas that bring into reach that which was previously thought to be impossible.

#### *Assigning Causes for Variation*

Once energy accounting is established and standards are set, management should begin to compare actual performance to the standards. However, these comparisons alone do not give a complete picture of what is happening. In order to understand whether a variation is a “normal” statistical fluctuation or something more significant, there must be a thorough understanding of the complete set of measures.

For example, tracking the energy cost index helps management isolate one possible source of variation in the energy productivity index. If energy productivity has deteriorated in the most recent analysis period, some—or all—of the drop may be attributable to an increase in energy costs.

Additional information may be gained by tracking the trend of energy cost per Btu. This will help determine whether an increase in the energy cost index is attributable primarily to an increase in the base cost of energy/Btu or an increase in Btus per chosen unit of output.

Following are other common, identifiable sources of variation in energy costs. The time period for all such assignable factors should be noted on the data records.

- seasonal weather changes
- increases in total output
- product mix variations
- physical changes to the system such as the installation of pollution control devices
- use of an alternative fuel
- pilot programs
- specific conservation efforts

#### **Walk the Talk (1d Figure 2.3)**

The central component in Figure 2.3 is “Walk the Talk.” Company leaders must commit resources including time, talent, and money on an ongoing basis. Attention at the outset followed in a few months by a total disregard for EM will doom energy management efforts to mediocrity at best, and failure at worst.

Indications that senior leadership has an ongoing commitment to energy management include the following:

- A corporate champion is named, and, in larger companies, a team is identified.
- Accountability is clearly established.
- EM is an agenda item at all regular leadership meetings.



- The energy policy is evaluated regularly and updated as needed.
- Adequate budget is provided annually for effective EM.

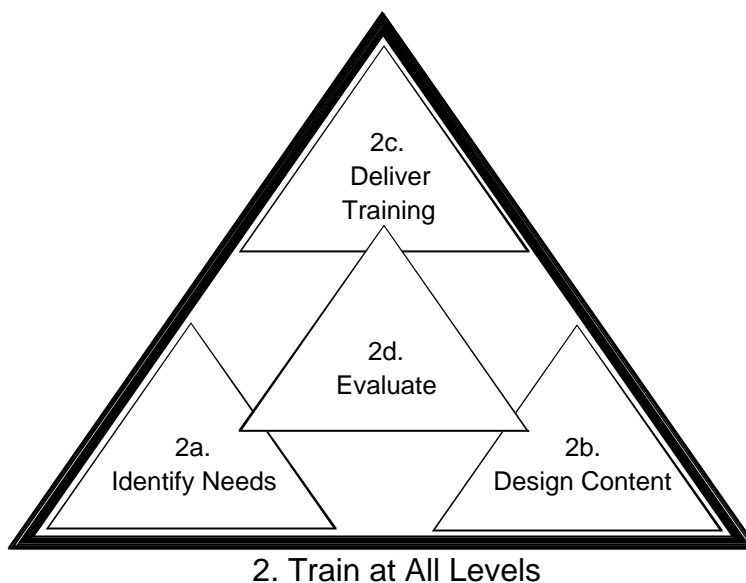

**Figure 2.4** Continuous Training of Personnel Guide

After company leaders have made the commitment to an EM program and after current energy performance has been assessed and standards set, it is time to provide training for all company personnel. Sharing information and increasing the knowledge level of employees is a prerequisite to the successful implementation of an EM plan. The opportunity to express personal opinions, ask questions, and get answers generally increases the level of engagement for individuals. Employees are more likely to be motivated to save energy if they feel engaged in the process. Steps for engaging workers follow.

#### **Identify Training Needs (2a Figure 2.4)**

Initially, every employee will need training on topics such as awareness of the corporate energy policy, current energy usage and trends, basic EM terminology, and energy measures. More specific topics such as boiler management or assessing return on investment in energy projects will be delegated to smaller groups. Be sure to take the time to identify the general and specific needs of the entire staff.

#### **Design Content (2b Figure 2.4)**

To create training content, begin by identifying the specific learning objectives for the targeted individuals. The delivery methods and materials should be chosen to maximize the likelihood of reaching the learning objectives. Training that is specific to a company program will probably have to be developed in-house. Training on more universal topics such as boiler management is commercially available from professional sources.

#### **Deliver Training (2c Figure 2.4)**

Planning and good intentions don't move an EM program forward. A training calendar should be established and all staff should be scheduled for training based on their needs and duties.

Follow-through is critical in establishing in the minds of employees that energy management is truly important to the organization. Training is best delivered during the staff's paid time in a facility that is conducive to learning and that is free of work interruptions.

### **Evaluate (2d Figure 2.4)**

It is important to determine the effectiveness of the training. Evaluate each learning objective in each session. In addition, it is usually beneficial to ask participants about the following:

- effectiveness of the instructor(s)
- effectiveness of the delivery methods (videos, etc.)
- value of any handout materials
- quality of the training facility

Of course, feedback is good, but it is worthless unless it's used! Use the feedback to make changes to subsequent training sessions. Re-evaluate and compare scores to determine the impact of the changes.

### **2.3.3 Continuous Improvement Cycle**

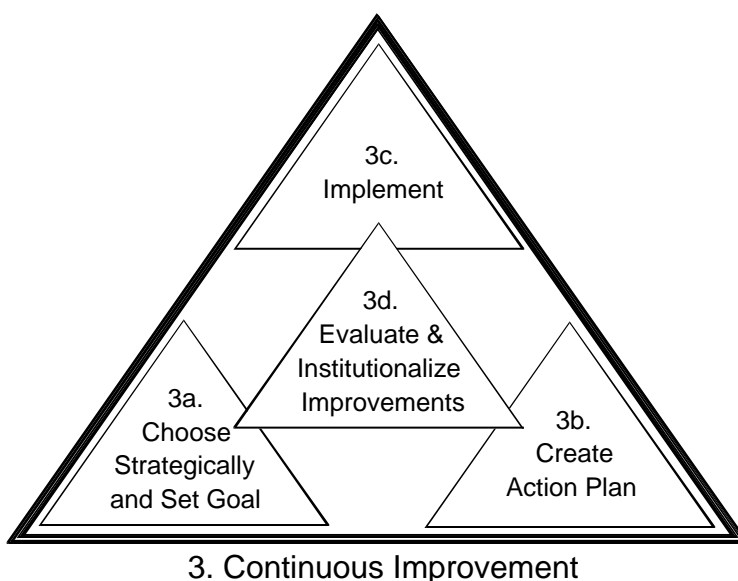

**Figure 2.5** Continuous Improvement Cycle Guide

Figures 2.3 and 2.4 illustrated the steps required to implement an Energy Management initiative. Depicted in Figure 2.5 are the steps of a continuous improvement cycle. These steps should be followed for each project in an EM initiative. As soon as one project is completed, the next opportunity is identified and strategies to meet it are undertaken.

### **Choose Energy Projects Strategically (3a Figure 2.5)**

The corporate strategic plan should include a section on energy management that, among other things, establishes a relationship between EM projects and non-energy issues in the strategic plan. This is not as difficult as it sounds. Energy costs are an unavoidable part of doing business and any money spent on energy cannot be spent on other activities such as marketing, training,

personnel, etc. Reducing energy costs frees up resources for the non-energy related components of the corporate strategic plan.

Specific energy management projects must be strategically chosen. This requires comparing two important factors: 1) the potential impact of a successful project to company finances, and, 2) the investment required for implementation.

A good strategy is to start with low investment projects that have moderate or high potential for savings. A significant portion of the savings generated by these projects should then be budgeted to finance the investment for more costly ventures. When identifying projects with the potential to save energy, be sure to solicit input from all employees. They frequently have ideas that are easy to implement and provide excellent results.

### *Assessing Financial Impact*

Although challenging, this is an important component because it is the key to strategic choice. The merits of a project may seem clear to those who work in a particular area, however, it may be difficult to get buy-in from the boss or the financial officer. These challenges can be minimized if the case is presented in financial terms. Three common types of financial analyses are:

- payback period
- rate of return
- total lifecycle cost

The *payback-period* analysis is commonly used, in part, because it is simple. To make the calculation, divide the cost of doing the project by the annual savings or return from a successful project. For example, if it would cost \$25,000 to implement changes and the annual savings are projected to be \$15,000, then the payback period would be 1.67 years ( $25,000/15,000$ ). Most companies set a maximum that is acceptable for a payback period and reject projects that do not meet the test.

The *rate of return* method involves other factors and more complex concepts such as net present value, interest rates, and depreciation. A detailed explanation of these factors is beyond the scope of this publication. There are resources available to explain these terms and even help to make the calculations. For example, DOE offers several software packages that will take information and calculate projected savings. These tools are available at the website in the footnote below.<sup>14</sup>

Although the *total lifecycle costing* method is a more complex way of evaluating projects, it is gaining support as a more accurate method of determining long-term impact. Depending on the complexity of the model, total lifecycle will consider owning and operating costs as well as such factors as environmental impact and costs, disposal/recycling costs, etc. For projects that may not meet the required investment threshold using other methods, this long-term look at costs may show that energy management practices are indeed a wise investment.

---

<sup>14</sup> DOE Industrial Technologies Program, [http://www.oit.doe.gov/bestpractices/software\\_tools.shtml](http://www.oit.doe.gov/bestpractices/software_tools.shtml)

No matter what method of financial analysis is used, it is *critical* to carefully account for not only the savings that come directly from a project, but also any measurable “returns” that are caused by the project or made possible because of it. These increases in revenues, for example, represent funds that were not available before, which further increases the value of the venture.

### **Set the Goal (3a Figure 2.5)**

Goal-setting can be controversial subject. Dr. Deming argued vehemently against what he called arbitrary numerical targets. However, others feel that setting an arbitrary goal can force an organization to commit to action and the setting of non-arbitrary goals. Many times the setting of an arbitrary goal generates dialogue that addresses the root problems that can affect the success of an energy management program. They can act as a catalyst for management to invest in performing assessments and initiating improvements.

Benchmarking can help avoid arbitrariness. By using benchmarking to compare your operation and its energy usage to other similar plants or industries, you can see how your organization stacks up to the competition or related industries. This information can then be used to set goals that are based on data, providing a goal that is both realistic and achievable.

Also needed is a systematic approach to continuous improvement. To give people a goal that requires improving the underlying system but not giving them the means to change/improve the system would be viewed by Dr. Deming as both arbitrary and de-motivating. The means to improving the system requires the authority that comes from management’s commitment to support the goals and the continuous improvement process.

### **Create an Action Plan (3b Figure 2.5)**

The steps needed to achieve improvement should be carefully planned and, at a minimum, should include the following:

- clear statement of desired outcomes and measures of success
- list of resources that are and are not available
- sequential list of steps involved
- list of key milestones or intermediate indicators of success
- expected completion date
- clear explanation of reporting requirements (frequency and scope)
- rewards for successfully achieving goals (if applicable)

Using a systems approach to balance the supply side against the demand side is a good way to create an action plan because it compares the inputs of an energy system to the outputs.

Be sure to consider the potential negative impacts on product flow and peak energy demand. It is usually advisable to pilot proposed changes, before full implementation, if possible. For example, if an action plan suggests adjusting four air compressors for a desired affect, change one unit and measure the impact before continuing with the other three.

### **Implement the Plan (3c Figure 2.5)**

Follow-through is the key to success. Execute the plan step-by-step. Monitor progress regularly and implement subsequent steps accordingly. Or, if the evaluation indicates a problem, make adjustments to the action plan.

### **Evaluate and Institutionalize Improvements (3d Figure 2.5)**

Evaluate the success of implementation against the goal established at the outset. If a pilot project is successfully implemented, changes should be phased in across the larger system. Challenges unique to the larger system can be evaluated during this transitional phase from the pilot project to the larger system. Data collected during the pilot project should make the computation of financial return easier and justify the additional investment in expanding the changes across the larger system.

### **Continue the Cycle**

As soon as a project is completed, begin the process anew by selecting the next project and setting goals for it. You should be prepared to repeat this cycle continuously, always striving to reduce energy consumption and increase productivity while contemplating cost and other impacts, until the return does not justify repeating the cycle again.

### **2.3.4 Communication**



**Figure 2.6** Communication Guide

The centerpiece of any successful EM model is ongoing communication. Knowledge must be shared in formats that are easily understood, readily accessible and appropriate for the audience. For example, senior management will probably require a format and content that differs from what is needed by engineers in the steam room. In addition, company leaders must regularly address the topic of EM and communicate the importance throughout the workforce. If energy management is not a regular topic of discussion throughout the company, it will soon be viewed as a meaningless gesture without any real priority. Ongoing training must be provided throughout all levels of the organization where information on energy performance should be shared with trainers to help them identify the needs of employees. Milestones must be

recognized and celebrated. Employees need to see that their efforts are appreciated and that they make a difference.

## **3. Understanding Energy Cost Structure**

Most utilities offer commercial customers different billing options depending on the level of energy used by the customer as well as the variation in the usage pattern. To determine the best billing method for a specific user, a customer service representative reviews the last 12 months of energy use and considers significant changes, if any, to future usage patterns. A brief explanation of the common factors included in a commercial billing plan follows.

### **3.1 Electrical Peak Demand Charges**

Electrical demand is measured in kilowatts (kW). Peak demand is the highest average kW usage during any one-demand interval (usually a 15- or 30-minute period) of the billing cycle. Utility companies are concerned with peak demand because the size of the equipment they use to generate and transmit electricity must be sufficient to handle the peak demand of its customers. For this reason, a portion of the charges from many utilities is based on peak demand. Billing rates for peak demand vary greatly by billing plan.

#### *Ratchet Clause*

Sometimes peak demand charges are based on the highest average peak demand in one demand interval during the past year (or during the summer months). This is known as a “ratchet” clause. In such cases, electric charges will be impacted every month for a single 15-minute period of high demand during the past year (or the last summer month period).

### **3.2 Managing Peak Demand**

Although it may not always be easy, there are ways to manage peak demand. Strategies include:

- sequenced start-up
- staggered or deferred usage
- sheddable loads
- permanent reduction of on-going loads

As the term implies, “sequenced start-up” means starting equipment at different times during the beginning of a shift. This lowers the overall demand for electricity at one time, eliminating (or at least reducing) peak demand charges. In addition, if multiple pieces of equipment require less than full-time operation (i.e. less than eight hours in a single shift or 24 hours in a three-shift operation), it may be feasible to stagger their use. In multiple shift operations, it may be possible to reduce peak demand by performing energy-intensive processes on different shifts. For example, a compressor driven by a large motor might run on a shift opposite a large pump that is also driven by a large motor, therefore reducing peak demand charges and overall energy costs.

Categorizing demand as either essential or non-essential can also result in energy savings. When discontinued for short periods of time, non-essential or “sheddable” loads lower energy usage without reducing productivity or comfort. Some examples include electric heaters, air

conditioners, pumps, snow-melting equipment, compressors, and water heaters.<sup>15</sup> It is possible to install monitoring equipment that alerts the energy manager when demand reaches a predetermined range, so that he or she can decide whether or not to begin shedding loads. Shutting down or restricting the sheddable loads once a certain demand in kW is reached can significantly reduce peak demand charges.

Any ongoing load that is reduced or eliminated during the peak will cut total usage and also reduce the peak. A good example is switching from traditional overhead lighting to newer cost-effective, energy-efficient lighting.

### **3.3 Electrical Energy (Usage) Charges**

The kilowatt-hour (kWh) is the basic unit of electrical power usage/consumption. Most utilities offer industrial customers a lower price per kilowatt hour (kWh) as consumption increases. The price typically changes at fixed levels of usage, so that there are two or more usage tiers. For example, in a three-tier system, the first 250 kWh may be billed at a one rate, the next 750 kWh at a somewhat lower rate, and any usage in excess of 1000 kWh is billed at an even lower rate.

Usage tiers may change depending on the time of year. In the summer there may be only one tier while the winter months may have multiple tiers. The cost of energy in each tier is also likely to change depending on the time of year. There may also be a change in costs depending on the time of day the energy is used. For example, a kWh consumed during “on peak” hours may have a higher charge than a kWh consumed during “off peak” hours.

One method of billing actually combines peak demand with energy usage. In this method, the number of hours in each tier is multiplied by the peak demand to determine the number of kilowatt hours charged at the rate for that tier. Since this type of billing also contains a separate demand charge, reducing peak demand can significantly reduce the total cost of electricity.

### **3.4 Reactive Demand Charges**

Commercial customers like chemical manufacturers use a lot of equipment (induction motors, transformers, florescent lights, induction heating devices, etc.) that requires magnetizing current, which is measured in “kilovolt-amperes reactive” (kVAR). Kilowatts (kW) are a measure of the work-producing current in the circuit. Total current, which is impacted by the combination of magnetizing current and work-producing current, is measured in kilovolt-amperes (kVA). The power factor is the ratio of kW to kVA. When the magnetizing current is zero, kW is equal to kVA and the power factor is 1.0. This is good for the utility and no additional charges accrue during a period where the power factor is 1.0.

In circuits that use magnetizing current the total current rises and the power factor drops below 1.0. A low power factor, 0.6 for example, means that the utility has provided a large quantity of reactive current (kVAR) that would not be covered by a charge for only the kilowatts (kW) delivered. For this reason, utilities often include some sort of reactive demand charge on the

---

<sup>15</sup> *Handbook of Energy Engineering, Fifth Edition*, Thumann and Hehta, The Fairmont Press, Inc. 2001.



electric bill. These charges can be very significant if the power factor is very low; however, this is typically not the case in Iowa.

The good news is that reactive demand charges can always be dramatically reduced, and often even eliminated. Capacitors can be installed that will provide the needed reactive current, thereby bringing the power factor close to 1.0. Review of at least one year's data on the maximum demand, power factor, typical energy usage, and reactive demand charges will help users calculate the amount of capacitance that must be installed to raise the power factor to an acceptable level. For help, consult with the electric utility or the Iowa State Industrial Assessment Center.<sup>16</sup>

### **3.5 Incentives and Rebates**

A variety of incentives and rebates on energy-efficient equipment are offered to commercial customers. Complete and updated lists of incentives and rebates are available from most utilities companies. A partial list of some of the most popular areas that have incentives and rebates is given below:

- fluorescent T-8 and T-5 lighting
- reduced wattage metal halide lamps
- chillers
- ground source heat pumps
- high efficiency natural gas boilers
- motors and variable speed drives
- compressed air system equipment

In addition, customized or special projects that save energy may also be considered for incentives or rebates.

The state of Iowa exempts a certain amount of electricity costs for industrial production loads from sales tax. A certificate of verification is required and must be renewed every three years. Once certified, commercial customers who have not previously been exempted may apply for a refund of overpaid taxes from previous years.

---

<sup>16</sup> The Industrial Assessment Center, funded by the US Department of Energy that serves Iowa is located at Iowa State University. Their website is <http://www.me.iastate.edu/iac/>, or call (515) 294-3080.

## 4. Process Heating Systems

Nearly all process heat used in chemical manufacturing can be classified as batch/continuous processes with indirect/direct heating methods provided by fuel or steam energy sources. This chapter will identify best practices in process heating for the chemical industry as a whole. Use of these practices will provide the highest energy savings for the lowest initial capital investment.

### 4.1 Overview

Process heating is essential to the production of consumer and industrial goods. Industry-wide, it accounts for 5.2 quads, or nearly 17% of total industrial energy consumption in the U.S. [USDOE OIT, 2001].<sup>17</sup> Figure 2.1 illustrates the types of energy used in process heating applications. As the figure indicates, about 92% of process heat energy is directly provided by fossil fuel sources.

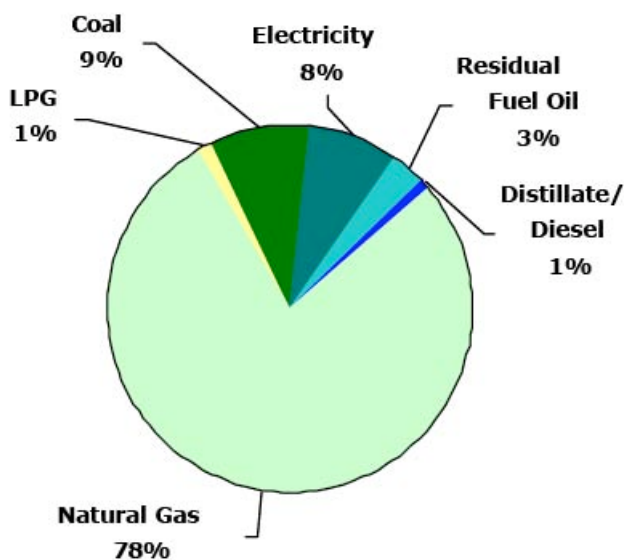
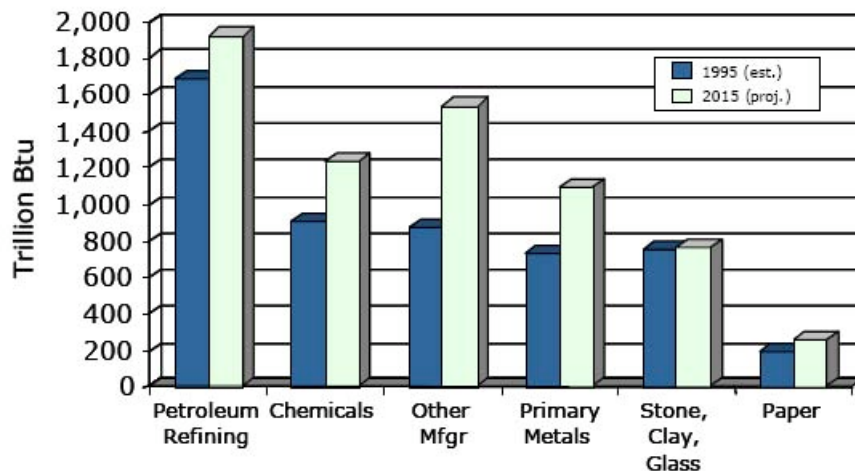

**Figure 4.1** Types of Energy Used for Process Heating<sup>18</sup>

Energy efficiency gains have helped to alleviate the demand for energy in process heating applications, and they are expected to help alleviate future energy consumption. The expected increase in energy demand for process heating will not be offset by the current gains in energy efficiency, therefore resulting in an overall net increase in the demand for energy as the chemical industry grows. Figure 4.2 displays projected energy demand increases for process energy by the year 2015 for several important industry sectors.

<sup>17</sup> U.S. Department of Energy: Office of Industrial Technologies, *Roadmap for Process Heating Technology*, March 2001.

<sup>18</sup> Energy Information Administration, *Manufacturing Consumption of Energy 1994*, Report Number DOE/EIA-0214, December 1997.



**Figure 4.2** Projected Energy Demand for Process Heat<sup>19</sup>

Within the chemical industry, approximately 1.05 quads are consumed for process heating alone. This represents about 32% of the total energy consumption of the industry. According to the projections displayed in Figure 4.2, by the year 2015 consumption will jump by 20% to nearly 1.25 quads of energy consumption for process heat use. Since nearly 92% of this energy will come from the volatile fossil fuel industry, energy efficiency measures must be taken.

Due to low efficiency levels of equipment currently being used in the chemical industry, the opportunity for energy savings is limited. The most simplest, most significant opportunities for savings using currently installed equipment lie in the application of energy efficiency measures known as best practices. Further research and development will improve the energy efficiency of new equipment. With the concurrent use of advanced technologies, new operating practices, and implementation of best practices, reductions of 5 to 25% in energy consumption are possible over the next 10 years.<sup>20</sup>

The rest of this chapter will provide additional general information on process heating and its applications in the chemical industry. This information may be useful in indicating where best practices can be implemented.

## 4.2 Explanation of Use

Process heat is used to supply heat energy during the manufacture of basic materials and goods. Process heating is very energy intensive, accounting for a large percentage (10% to 15%) of total production costs. Typical process heating components used in the chemical industry are boilers, fired heaters, heated reactors, distillation columns, calciners, dryers, heat exchangers etc. Common to all chemical process heating applications is the transfer of heat energy to the product material being treated. Process heating systems typically include a heating device that generates and supplies heat, heat transfer devices for transferring heat energy from the sources to the product, a heat containment structure, and a heat recovery device (Figure 4.3).<sup>21</sup>

<sup>19</sup> Gas Research Institute, *Industrial Trends Analysis 1997*, Report Number GRI-97/0016, January 1997.

<sup>20</sup> U.S. Department of Energy: Office of Industrial Technologies, *Roadmap for Process Heating Technology*, March 2001.

<sup>21</sup> U.S. Department of Energy: Office of Industrial Technologies, *Roadmap for Process Heating Technology*, March 2001.

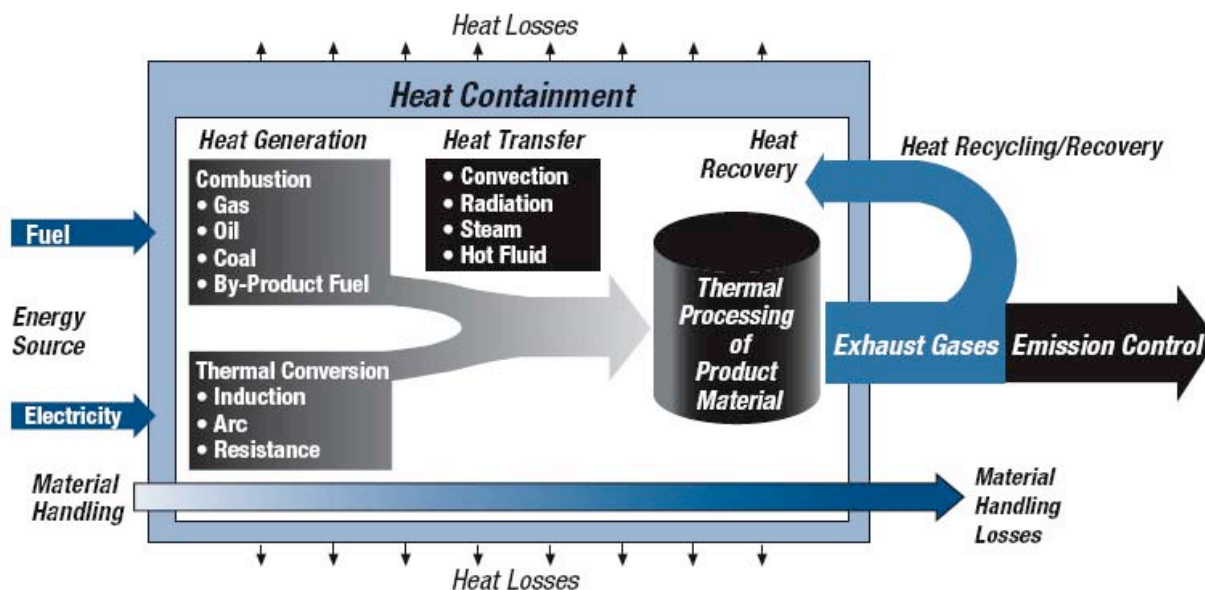

**Figure 4.3** General Schematic of a Typical Process Heating System<sup>22</sup>

In addition, most operations have control systems that coordinate the process, its materials handling, atmospheric needs, and safety. The means in which process heat is applied and the temperature used are dependant on the industrial application in the chemical industry. Temperatures can range from less than 300°F to more than 3,000°F. Some process heating operations are continuous and heat several tons of material per hour, while other operations are slow, precise, and heat small batches according to very accurate time/temperature profiles.

In all instances, heat is transferred to the product directly from the heat source, indirectly through the heat containment vessel, or through other mechanisms such as jets or hot gas recirculation. Typically, the operation is conducted in some form of heat containment enclosure. Depending on design, anywhere from 10 to 25% of the heat supplied may be lost through the enclosure. In addition, the flue gas exiting the heating equipment may contain anywhere from 20-70% of the heat input, especially in combustion-based heating equipment. Most enclosures, especially those performing high-temperature operations, include some type of heat recovery device to recycle waste heat. Improper cooling of the enclosure combined with inadequate heat recovery can result in losses of 5-20% of heat input. Finally, most chemical operations also incorporate control systems to optimized the performance of the process heat application, which, in turn, can save anywhere from 5-30% in energy costs.<sup>23</sup> For these reasons, the implementation of energy-reducing best practices is ideal in the realm of process heating.

#### 4.2.1 Generation

The first step in any chemical process system operation is generating heat for process heating. Although electricity can be used to generate the process heat being required, the chemical industry relies most heavily on the methods described below.

<sup>22</sup> U.S. Department of Energy: Office of Energy Efficiency and Renewable Energy, *Improving Process Heating System Performance a Sourcebook for Industry*, 2001.

- Direct-fired burners or heat transfer devices—These devices are intended to supply either direct or indirect heat to process streams containing the reactants and products essential to the manufacture of chemical goods, and to provide heat energy to heat transfer fluids needed for process operations. The most common heat transfer fluid is steam produced by boilers using direct-fired burners powered by natural gas, by-product gases, fuel oils, coal, or other types of solid fuels. (The generation of process steam, while extremely important to the chemical industry, can be considered in the same way as process heat generation. Further explanation on the generation of steam for process steam systems is provided in Chapter 5.) Other heat transfer fluids used in industry include water, hot oil, liquids, air, and other gases. In most cases, these heat-transfer fluids are heated directly by fuel-fired processes or indirectly by steam.
- Cogeneration systems—A boiler is used to produce steam that, in turn, powers a steam turbine that creates electricity and heat for process heating. An alternate route is to use a gas turbine and heat recovery boiler.

Steam heating is used for heating fluids through heat exchangers, direct contact heating of fluids, and other heating such as tracing of utility or product distribution lines, vessels and reactors.

#### **4.2.2 Process Uses**

Although there is a very broad range of process uses and operations in the chemical industry, commonalities allow them to be grouped into the following categories:

- fluid heating
- calcining
- drying
- curing and forming
- other process heating operations

Table 4.1 provides a list of specific processes linked to the five generic process use operations presented in section 4.2.2.

**Table 4.1** Typical Process Heating Applications Found in Industry<sup>23</sup>

Fluid Heating	Calcining	Drying	Curing and Forming	Other Heating
<ul style="list-style-type: none"> <li>- Air Heating</li> <li>- Cat Reforming</li> <li>- Distillation</li> <li>- Fluid Cracking</li> <li>- Hydro-treating</li> <li>- Liquid Heating</li> <li>- Quenching Systems</li> <li>- Reforming</li> <li>- Visbreaking</li> </ul>	<ul style="list-style-type: none"> <li>- Cement</li> <li>- Coke</li> <li>- Calcining</li> <li>- Mineral</li> <li>- Calcining</li> <li>- Ore Calcining</li> </ul>	<ul style="list-style-type: none"> <li>- Crude Oil</li> <li>- Food and Kindred Products</li> <li>- Ladle and Vessel</li> <li>- Molds and Cores</li> <li>- Natural Gas</li> <li>- Powder (Metal and Non Metal)</li> <li>- Pulp and Paper</li> <li>- Resin</li> </ul>	<ul style="list-style-type: none"> <li>- Ceramics</li> <li>- Clay</li> <li>- Glass</li> <li>- Metal (Ferrous and Non-Ferrous)</li> <li>- Resin and Plastic</li> <li>- Heat Forming</li> <li>- Thermal Forming</li> <li>- Paint and Organic Coatings</li> </ul>	<ul style="list-style-type: none"> <li>- Atmosphere Systems</li> <li>- Gas Cleaning</li> <li>- Gasification</li> <li>- Pyrolysis</li> <li>- Waste Treatment</li> <li>- Incineration</li> <li>- Regenerative Chambers</li> </ul>

### Fluid Heating

Fluid heating is performed for a wide range of purposes in chemical industry operations. Using fuel-fired heaters, steam-heated chemical reactors, or heat exchangers, fluids (gases or liquids) are heated in both batch and continuous processes to induce or moderate a chemical reaction. Steam heating, perhaps the most common type of fluid heating used in the chemical industry, is used in heat exchangers, direct contact heating of fluids, and other methods such as tracing of utility or product distribution lines, vessels and reactors. More information on steam system specifics is provided in Chapter 5.

### Calcining

Calcining is the removal of chemically bound water and/or gases, such as carbon dioxide, through direct or indirect heating. Calcining is common in the preparation of raw materials, as well as the production of intermediate or final products.

### Drying

Drying is the removal of free water through direct or indirect heating. It is common in the chemical industry where the moisture content of raw materials such as clay or sand must be reduced. Drying is also key to removing water from Distillers Dried Grain Products common to the ethanol industry. There are several types of dryers, including but not limited to, conveyor, fluidized bed, rotary, and cabinet.

### Curing and Forming

Heating material in a controlled manner to promote or control a chemical reaction is called curing. In chemical and plastics applications, curing is the cross-linking reaction of a polymer. Curing is common in the application of coatings to several products produced by the chemical industry. Forming operations, such as extrusion and molding, use process heating to improve the workability of rubber, dry substances such as powdered paints, and miscellaneous plastics.

<sup>23</sup> U.S. Department of Energy: Office of Energy Efficiency and Renewable Energy, *Improving Process Heating System Performance a Sourcebook for Industry*, 2001.

### Specific Heat Transfer Operations

Many process-heating applications do not fall into any of the above categories; however, they collectively account for a significant amount of industrial energy use. Common applications that use process heating include controlling a chemical reaction and establishing favorable physical or mechanical properties (e.g., plastics production). Some of the systems that fall under this classification are thermal oxidizers, high-temperature exothermic or endothermic processes using catalysts, thermal cleaners, flares etc.

Many previously mentioned processes use heat exchangers to transfer heat energy to the process stream. Freestanding heat exchangers are also used in the chemical industry, mostly in applications of heat recovery and further heating of process streams. Many different types and variations of heat transfer equipment can be applied to different applications. The major types are:

- plate coil
- plate-and-frame
- spiral heat exchanger
- bare tube
- finned tube
- shell-and-tube

Freestanding exchangers are the most common source of process heat exchange in the chemical industry. They serve many purposes ranging from complex temperature control of process streams in continuous flow operations to simple warming of batch processes. Two configurations are found— process streams on both sides and a process stream on one side with the heat transport medium on the other.<sup>24</sup> The heat transport medium is generally composed of steam, hot oil/gas/water, or another hot process stream.

Heat transfer units can be made of many different materials depending on the needs and requirements of the process. Each type of unit has criteria for proper application and design. In the selection process it is not only important to understand the advantages of each type of heat transfer unit, but it is equally important to understand the disadvantages. One type of heat transfer unit will work extremely well in one application, but may perform poorly in another.

The construction materials used in heat exchangers depend on the fluids, vapors, temperatures, and pressures in the system. To determine the most cost-effective unit for an application, initial costs must be measured against the expected lifecycle and maintenance requirements. The entire unit as well as any of its components can be made of stainless steel, copper-nickel, copper, Alloy 20, or other special alloys. Selection of materials involves careful consideration of these factors:

- initial cost
- longevity

---

<sup>24</sup> U.S. Department of Energy: Industrial Technologies Program, *Chemical Bandwidth Study*, December 2004.

- maintenance
- performance
- corrosion resistance

All units should be evaluated on a 10-year operation basis, including:

- initial cost
- maintenance cost
- down time losses, due to failure or performance loss
- replacement cost (if unit fails)
- heat transfer equipment can be made to last one year, five years, ten years or more, depending on the selection of materials and installation versus cost.

#### **4.2 Process Heating Best Practices**

Table 4.2 and Figure 4.4 are intended to be used as a quick reference to identify possible areas of improvement within a generic chemical process heating system, categorized by the type of process heating component being considered. The rest of the chapter provides more detailed information describing the best practices found in Table 4.2 and elaborates on additional energy efficiency measures that may be taken to ensure an efficiently operating process heating system.



**Table 4.2** General Process Heating Best Practice Information<sup>25</sup>

Process Heating Component	Energy Saving Method	Energy Saving Potential (% of current use)	Typical Implementation Period	Typical Payback	Example Activities
1. Heating Generation	Efficient combustion (burners) and operation of other heat generating equipment	5%-25%	1 week to 2 months	1 to 6 months	Maintain minimum required free oxygen (typically 1%-3%) in combustion products from burners for fuel-fired process heating equipment  Control air-fuel ration to eliminate formation of excess carbon monoxide (CO), typically more than 30-50 ppm, or unburned hydrocarbons.  Eliminate or minimize air leakage into the direct-fired furnaces or ovens.
2. Heat Transfer	Design, operation, and maintenance of furnaces and heating systems to increase heat transfer from heat source to process or load	5%-15%	3 months to 1 year	6 months to 1 year	Select burners and design furnaces that allow use of high convection or radiation in processes and loads.  Clean heat transfer surfaces frequently in indirectly heated systems, such as steam coils, radiant tubes, and electrical elements.  Replace indirectly heated systems, such as radiant tubes, and enclosed electrical heating elements, where possible.
3. Heat Containment	Reduction of heat losses	2%-15%	4 week to 3 months	3 months to 1 year	Use adequate and optimum insulation for the equipment. Conduct regular repair and maintenance of insulation.
4. Heat Recovery	Flue gas heat recovery	10%-25%	3to 6 months	6 months to 2 year	Preheat combustion air.  Preheat and/or dry the charge load.  Cascade heat from exhaust gases to the lower temperature process heating equipment.
5. Sensors and Controls	Improved process measurements, controls, and process equipment	5%-10%	1 to 10 week	1 to 6 months	Develop procedures for regular operations, calibration, and maintenance of process sensors (i.e. pressure, temperature, and flow) and controllers
6. Process Models and Tools	Process models and design simulation to optimize equipment design and operations	5%-10%	2 weeks to 6 months	1 months to 2 year	Set appropriate operating temperatures for part load operations to avoid long "soak" or overheating.
7. Advance Materials	Reduction of nonproductive loads	10%-25%	2 weeks to 3 months	3 months to 2 year	Use improved materials, design, and applications of load support (fixtures, trays, baskets, ect.) and other material systems.

<sup>25</sup> U.S. Department of Energy: Office of Industrial Technologies, *Roadmap for Process Heating Technology*, March 2001.

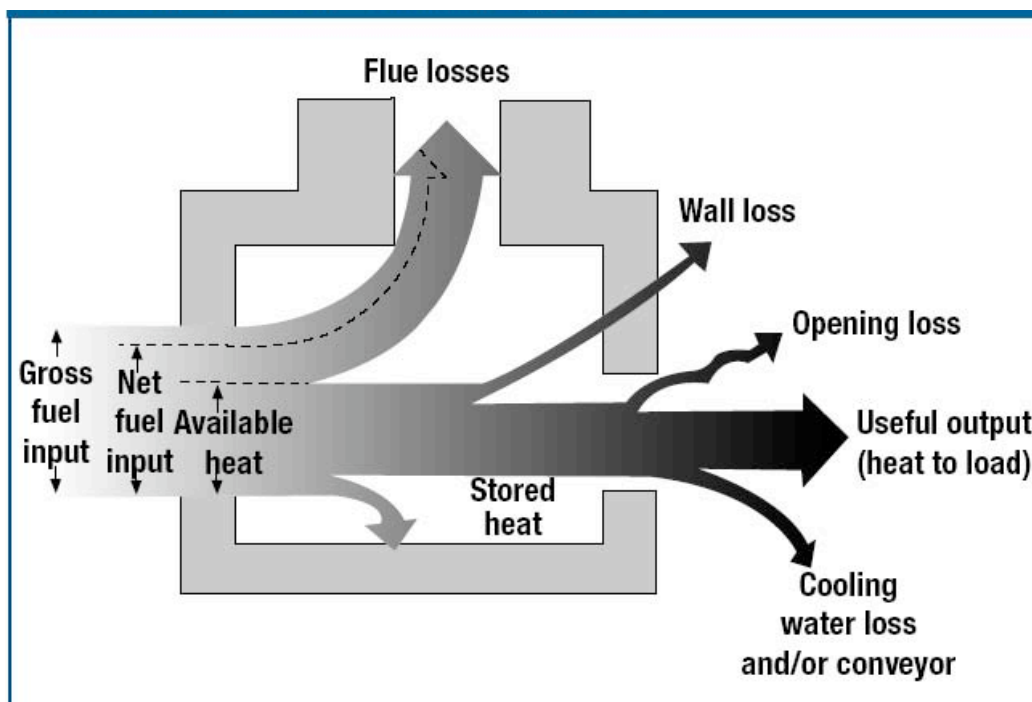

**Figure 4.4** Schematic Indicating Heat Losses in a Generic Process Heating Application<sup>26</sup>

#### 4.4 Heat Generation Best Practices

The best practices described in this section are applicable to all fired systems, including boilers and fired heaters. A single term—“process furnace” or just “furnace”—is used here to describe both of these fired systems. No matter their purpose, process furnaces typically are large sources of energy loss due to inefficient combustion, improper operation, and poor maintenance. Figure 4.4 provides a schematic of a generic process furnace; implementing best practices can minimize many of the energy losses noted in the diagram.

##### 4.4.1 Reduce Flue Gas Losses

Exhaust gas is the most significant form of heat loss in heat generation equipment. Commonly called flue gas or stack gas loss, it occurs when heat can't be transferred from the combustion products to the desired operation in the process furnace. The total amount of heat available minus losses through flue gases is known as the available heat. This is the heat that stays in the system and can be used for process heating. Figure 4.5 displays the percentage of total heat input that is lost through the stack vs. exhaust gas temperature. The chart clearly indicates that the temperature of the process or, more correctly, the temperature of the exhaust gases is a major factor in the energy efficiency of the furnace. The higher the temperature, the lower the efficiency. The chart also indicates that the percentage of excess air is very influential to the final thermal efficiency of the furnace.

<sup>26</sup> U.S Department of Energy: Office of Energy Efficiency and Renewable Energy, *Waste Heat Reduction and Recovery for Improving Furnace Efficiency, Productivity and Emissions Performance*, 2003.

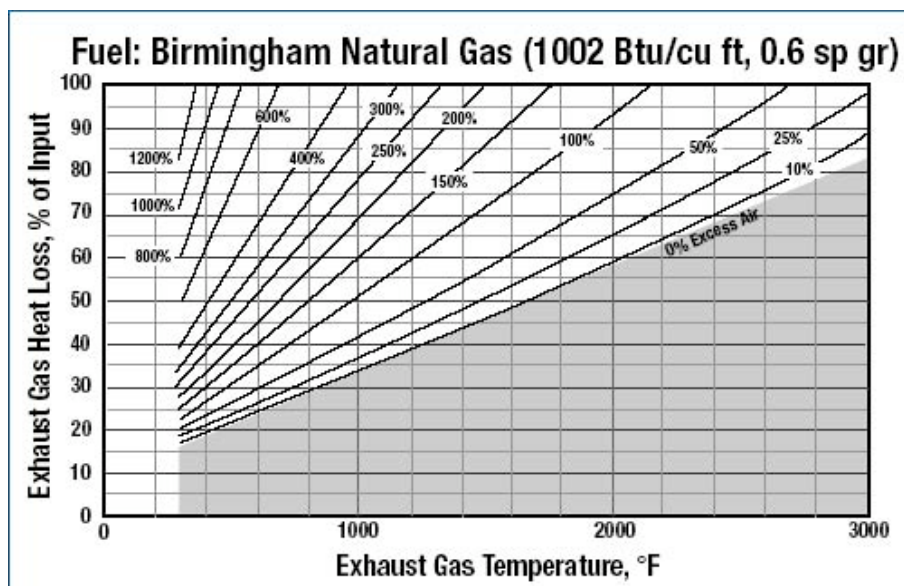

**Figure 4.5** Exhaust Gas Heat Losses vs. Exhaust Gas Temperature<sup>27</sup>

#### *Best Practices—Reducing Exhaust Gas Losses*

- Monitor and maintain the proper level of O<sub>2</sub> concentration, 2-3%, by operating at the correct air/fuel ratio for the burner.
- Wherever possible, use heat recovery of flue gas to preheat incoming combustion air.
- Eliminate or reduce all sources of undesired air infiltration into the furnace.
- Perform proper maintenance on a regular schedule to reduce soot and other deposits on heat transfer surfaces, thus ensuring efficient transfer of heat to the process.

Best practices for exhaust heat loss reduction are quite extensive and within each practice, there are several options that are dependant on the equipment, and process parameters. A discussion of these options follows. .

#### **Check Burner Air/Fuel Ratio**

For every fuel used, an optimum or stoichiometric amount of air is required to produce the most efficient, highest temperature flame with the least amount of emissions. As indicated in Figures 4.5 and 4.6, process heating efficiency is considerably reduced if the air supply is significantly higher or lower than the required stoichiometric amount of air.<sup>28</sup> Most high-temperature, direct-fired furnaces, heaters, and boilers operate with about 10-20% excess combustion air at high fire to prevent the formation of dangerous carbon monoxide and soot deposits on heat transfer surfaces and inside radiant tubes.

<sup>27</sup> U.S Department of Energy: Office of Energy Efficiency and Renewable Energy, *Waste Heat Reduction and Recovery for Improving Furnace Efficiency, Productivity and Emissions Performance*, 2003.

<sup>28</sup> U.S Department of Energy, Process Heat Tip Sheet Number 2, *Check Burner Air to Fuel Ratios*, May 2002.

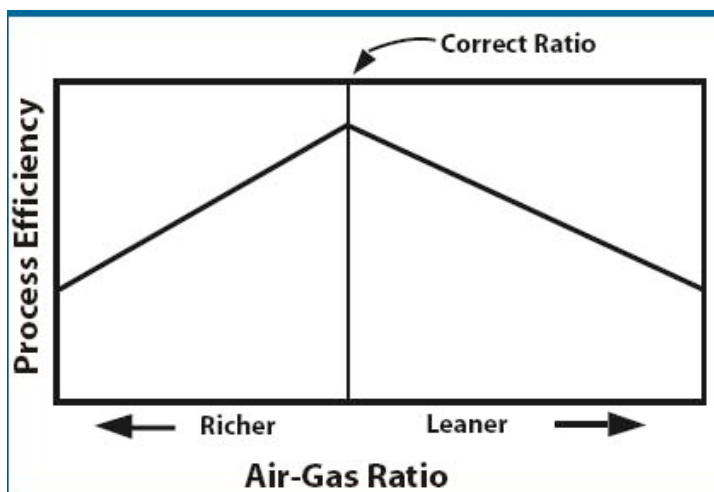

**Figure 4.6** Effect of Air/Fuel Ratio on Efficiency [USDOE EERE, 2003]

Air-gas ratios can be determined by flow metering, flue gas analysis, or, occasionally, a combination of both methods. Figure 4.5 indicates that the larger the percentage of excess air used while operating at a set exhaust gas temperature, the larger the amount heat lost through flue gas exiting the stack, and, therefore, the smaller amount of available heat for the process. Although this chart was developed for natural gas fuel, it can be used to approximate air-fuel fuels for propane, fuel oils, coal etc. It is not applicable for byproducts fuels containing large amount of H<sub>2</sub>, CO or noncombustible gases such as N<sub>2</sub>, CO<sub>2</sub>, etc.

#### *Best Practices—Check Burner Air/Fuel Ratio*

- Regularly monitor airflow rate or exhaust gas composition.
- Determine the optimum level of excess air for operating your equipment.
- Set combustion ratio controls to maintain that amount of excess air.
- Maintain excess air in the 10-20% range.
- Maintain a 2-3% O<sub>2</sub> concentration in exhaust gas.
- Maintain a CO concentration of no more than 350 ppm.

#### **Preheating of Combustion Air**

Waste heat recovery elevates furnace thermal efficiency because it extracts energy from the exhaust gases and recycles it to the chemical process. Significant improvements in efficiency can be achieved even on furnaces that are operating with improperly tuned burners. One of the most effective ways to recover waste heat from the exhaust gas is by using it to preheat incoming combustion air. A heat exchanger, placed in the exhaust stack or ductwork, can extract a large portion of the thermal energy in the flue gases and transfer it to the incoming combustion air. Recycling heat this way will reduce the amount of the purchased fuel needed by the furnace. Table 4.3 indicates the possible decrease in fuel energy input that can be obtained by preheating incoming combustion air.

**Table 4.3** Fuel Savings % from Using Preheated Combustion Air<sup>29</sup>

Furnace Exhaust Temperature, °F	Preheated Air Temperature, °F					
	600	800	1,000	1,200	1,400	1,600
1,000	13	18	—	—	—	—
1,200	14	19	23	—	—	—
1,400	15	20	24	28	—	—
1,600	17	22	26	30	34	—
1,800	18	24	28	33	37	40
2,000	20	26	31	35	39	43
2,200	23	29	34	39	43	47
2,400	26	32	38	43	47	51

Combustion air can be preheated with recuperators, which are gas-to-gas heat exchangers placed on the furnace stack. Internal tubes or plates transfer heat from the outgoing exhaust gas to the incoming combustion air, while keeping the two streams from mixing. They are available in a wide variety of styles, flow capacities, and temperature ranges. A typical installation used in chemical industry is shown in Figure 4.7. In this case, combustion air supplied by a forced draft (FD) air fan is preheated by using flue gases before using it in burners.

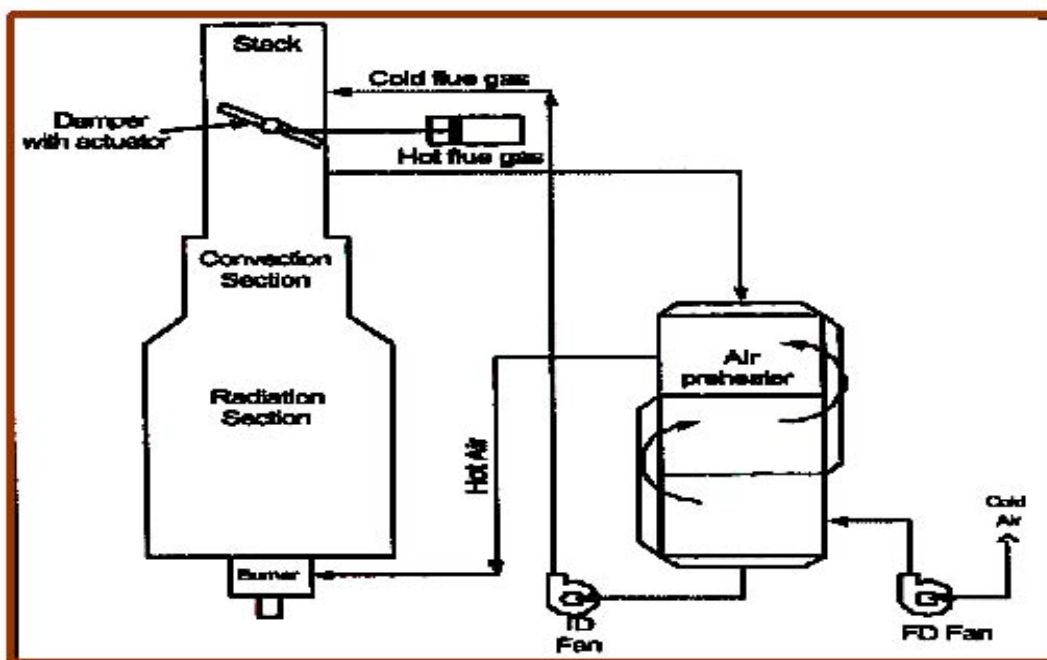
**Figure 4.7** Typical Recuperator Installations

<sup>29</sup> U.S. Department of Energy, Process Heat Tip Sheet Number 1, *Preheated Combustion Air*, May 2002.

### *Best Practices—Preheating of Combustion Air*

- Consider various options for recovering heat from flue gases.
- Rule of thumb for beginning analysis: Processes operating at or above 1600°F are good candidates for air preheating, while process operating near or below 1000°F may not be justified. Those operating within the range of 1000 to 1600° may still be good candidates but should be considered on a case-by-case basis.<sup>30</sup>

### **Reducing Air Infiltration into Furnace**

Excess air can enter the furnace by other means than combustion air. Air infiltration due to negative pressure and improper seals has the same effect on furnace efficiency as excess combustion air. The infiltrated air has to be heated to the flue gas temperature before it leaves the furnace through the stack, resulting in loss of energy and reduction in efficiency.

Furnace draft, or negative pressure, occurs in fuel-fired furnaces when high-temperature gases are discharged from the system at a level higher than the location of the furnace openings. This is commonly known as the "chimney effect." In a furnace operating at a fixed temperature, the negative pressure, or draft, changes with the heat input rate or mass flow of flue gases going through the stack.

Furnace pressure controllers regulate and stabilize the pressure in the working chamber of process-heating equipment. Typically, a pressure gauge in the furnace chamber or duct regulates the airflow to maintain a slightly positive pressure (a few one-hundredths of an inch of water gauge) in the furnace chamber. Airflow can be regulated by varying the speed of draft fans or by changing damper settings for the incoming combustion air or the exiting flue gas. Four different types of draft systems can be found in industrial furnaces used in the chemical industry.

- Natural (uses the *chimney effect*)—Gases inside the stack are less dense and will rise, creating a vacuum that draws air into the furnace.
- Induced—A fan draws air from the furnace into the stack.
- Forced—A fan pushes air into the furnace.
- Balanced—Both induced- and forced-draft fans are used.

Pressure controllers can be manual or automatic. An equipment operator, typically using a dial on a control panel, sets the pressure in manual systems. Automatic systems have a feedback loop and continuously monitor and regulate the pressure through an electronic control system.

Many process furnaces used in chemical industry employ a natural draft system to supply combustion air to the burners. In these instances, it's neither possible nor easy to control negative pressure in the furnace. In such cases, the only option is to take steps to eliminate or reduce the openings through which cold air enters the furnace, such as:

- Areas around the heater tubes, commonly known as heater penetration area
- Bolted casings that may have a small gap between the furnace casing and the bolted

---

<sup>30</sup> U.S. Department of Energy, Process Heat Tip Sheet Number 1, *Preheated Combustion Air*, May 2002.

- component (i.e. access doors etc.)
- Old, cracked or damaged gaskets used for seals or other areas
- Explosion doors that are not properly fitted

*Best Practices—Reducing Air Infiltration into Furnace*

- Use a draft (pressure) control system where possible to maintain a slightly positive pressure. The furnace pressure can be controlled using a damper on the combustion air blower or by installing a damper in the furnace exhaust stack.
- Minimize the draft (negative pressure) in an induced-draft system by reducing the openings through which cold air enters the furnace.
- Specify and use a forced-draft system with pressure control in future rebuilds or for new heaters.
- Check seals for leaks using a “smoke” device. Damaged seals will all air to leak into the furnace and therefore, must be repaired or replaced.
- Perform regular inspections. Bi-annual checks are recommended.

### **4.3.2 Proper Furnace Maintenance**

Proper maintenance should always be performed on the process furnace at scheduled intervals. Scheduled maintenance ensures long-term efficient operation. The key is proactive maintenance, not reactive repairs.

*Best Practices—Performing Proper Furnace Maintenance*

- Keep heat transfer surfaces on indirect heat generation furnaces clean and free of deposits and soot.
- Ensure burner is operating properly and most efficiently within the limits set by controls and operators.
- Continuously inspect the furnace enclosure for any forms of deterioration or safety issues.

## **4.4 Heat Transfer Best Practices**

While the most significant source of heat loss is exhaust, other heat loss areas are evident as well. Using best practices to increase the efficiency of heat transfer to process streams and other heat transfer mediums may also reduce energy consumption. Many of the best practices listed for heat transfer scenarios will be explained using steam as a heat transfer medium. Although it is not the only heat transfer medium used by industry, steam the most common. For additional information on steam as a heat transfer medium and its uses in industry, see Chapter 5.

### **4.4.1 Optimize Generation Heat Transfer**

Best practices often fall into the category of “using the proper equipment for the job.” If economically feasible, one should always select equipment for a retrofit or new installation to perform at the optimum level. In the area of increased heat transfer to a process stream, this often means using burners and furnaces that effectively utilize convection and radiation. Eliminating indirect heat transfer, where possible, also enhances the efficiency of heat transfer equipment. The more effectively heat transfer to a process stream occurs, the less energy is loss and fuel costs are, in turn, reduced.

*Best Practices—Optimize Generation Heat Transfer*

- When economically feasible, select high-heat, transfer-rated equipment for retrofits and new installations.
- When contacting a vendor, select burners and/or have the vendor design furnaces that allow use of high convection or radiation in processes and loads.
- Replace indirectly heated systems and enclosed electrical heating elements where possible.

#### 4.4.2 Optimize Heat Transfer Equipment Design

No matter the type of heat transfer equipment used—simple fin-tube heat exchanger or complex shell-and-tube heat exchanger—the design must be compatible with the desired operation. Thermal transfer can be increased by air elimination and proper space design. (Space design is equivalent to the surface area in direct contact with the steam or other heat transfer medium.) Optimum designs improve flow patterns and velocity over the heat transfer tube surfaces, fins, etc., which help scrub unwanted films away and account for the largest amount of heat transfer.

*Best Practices—Optimize Heat Transfer Equipment Design*

- When selecting new heat transfer equipment, make sure it's properly designed for the specific operation, employing the exact parameters inherent to the operation in order to eliminate trapped air and increase the heat transfer rate.
- Make sure all heat transfer units and equipment are installed and operating according to required TEMA (Tubular Exchanger Manufacturer Association) and ASME (American Society of Mechanical Engineers) designations, requirements, and codes. More information can be found at the respective websites, [www.tema.org](http://www.tema.org) and [www.asme.org](http://www.asme.org).
- Air or non-condensable entrainment is very problematic to steam heat exchanger equipment. For more explanation and best practices for removal see Section 5.6.3.

#### 4.4.3 Clean Heat Transfer Surfaces

Process heating systems in the chemical industry use a variety of methods to transfer heat to the load or material being processed. Heat transfer systems include direct heat transfer from flame or heated gases to the heater tubes and indirect heat transfer from radiant tubes, muffles, or heat exchangers. Indirect heating methods may use fuel firing, steam, or hot liquids to supply heat. In each of these cases, clean heat transfer surfaces can improve system efficiency. Deposits of soot, slag, and scale should be avoided.

Soot is a black substance formed by combustion that adheres to heat transfer surfaces. Slag is the residue formed by oxidation at the surface of molten metals; also it, too, can adhere to heat transfer surfaces. Soot and slag on heat transfer surfaces impedes the efficient transfer of heat and makes industrial heating systems less efficient. As shown in the Table 4.4, a layer of soot with a thickness of only 1/32-inch can reduce heat transfer by an estimated 2.5%.

**Table 4.4** Table Indicating Effect of Soot on Heat Transfer

Soot Layer Thickness, Inches	1/32	1/16	1/8
Efficiency Reductions due to Soot Deposits*	2.50%	4.50%	8.50%



The extent to which the efficiency of heat transfer surfaces is impacted by dirt can be estimated from an increase in stack temperature relative to a “clean operation” or baseline condition. For every 40°F increase in stack temperature, efficiency is reduced by approximately 1%. Contamination of heat transfer surfaces due to soot or slag residue from combustion is typically the result of:

- low air-to-fuel ratios
- improper fuel preparation
- malfunctioning burner
- oxidation of heat transfer surfaces in high-temperature applications
- Corrosive gases or constituents in heating medium
- stagnant or low velocity areas in contact with heat transfer surfaces for hot liquid or gas heating systems
- special atmospheres (e.g., cracking furnaces or reformers) that can produce soot during the heating process
- particulates from the material being processed

Contamination from flue gas can also decrease equipment life and lead to maintenance problems that can cause downtime.

Problem areas for indirectly heated systems, where heating mediums such as steam, air, or hot liquids are used, include scale, dirt, oxide film, and/or fouling on the heat transfer surfaces that are in contact with the heating medium. Figure 4.8 shows typical resistant film buildup on a tube used in an indirect steam heat transfer system.

## RESISTANT FILMS

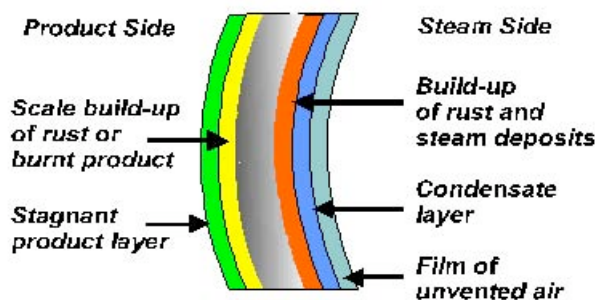

**Figure 4.8** Resistant Film Buildups on an Indirect Steam Heater Tube

Scale or internal deposits will reduce the internal surface temperature in contact with the product. This results in a lower product temperature and higher tube temperature, decreasing the efficiency of the system. A typical reaction to restoration of product temperature would be to increase steam pressure or reduce product flow, both of which will place the system outside its design parameters. An example would be an instantaneous water heater with scale build-up in the tubes. As scale deposits increase water temperature decreases. In an effort to increase the heat transfer, the temperature control valve will open wider. Eventually, the unit will not be able

to hold the set water temperature even at maximum steam pressure. To achieve original heating capacity, the water coil will need to be cleaned or replaced.

A properly designed heat exchanger will handle its rated load under the conditions for which it was specified. To compensate for products or vapors that inhibit or “foul” the process, it may be necessary to increase the heat transfer area. End users can specify a fouling factor to estimate the affect of vapors that inhibit or foul the process might have on the heat transfer area. This fouling factor is used to determine how much to increase the heat transfer area in the unit, thus allowing it to continue to meet performance standards when the fouling on the heat transfer surface occurs. The increased heat transfer area as a result of the fouling factor is typically a modest additional cost compared to the value it can provide to the process operation. It is also important to note that not all manufacturers include fouling considerations in their designs. There is no savings in assuming an optimistically low fouling factor even if it seems to make a more cost-effective heat exchanger. Later on, difficulties with reduced capacity, low process yields, frequent shutdown for cleaning, and extra maintenance can quickly dissipate this savings.

#### *Best Practices—Clean Heat Transfer Surfaces*

- Examine flue-side heat transfer surfaces on a regularly scheduled interval; remove deposits and contaminants.
- Use a soot blower to automatically clean heat transfer surfaces if required
- Use soot burnout practices for radiant tubes or muffles used in high-temperature furnaces.
- Use continuing agitation or other methods to avoid build-up of contaminants on heat-transfer surfaces.
- Clean heat-transfer surfaces frequently in indirectly heated systems, such as process stream coils, radiant tubes, and electrical elements.
- If necessary, add a fouling factor when designing a new system or selecting new heat transfer equipment.

#### **Concerns Using Water as Heat Transfer Medium**

Heat-transfer systems that use water and chemical processes that use water-based liquids are subject to scaling, which contain calcium, magnesium and silica deposits. Formed by layers of minerals accumulating on the waterside of heat-transfer surfaces, scale deposits have a thermal conductivity an order of magnitude less than bare metal. Efficiency losses from scale deposits can range from 1 to 7%. Primarily caused by inadequate water treatment, scale deposits can shorten the lifecycle of heat-transfer equipment, leading to its premature replacement. Scale removal can be achieved by mechanical means (manual brushing) or through acid cleaning.

#### *Best Practices—Concerns Using Water as Heat-Transfer Medium*

- Examine the waterside of heat-transfer surfaces for scale; remove any deposits.
- If scale is present, consult a local water treatment specialist about modifying chemical additives.

#### 4.4.4 Insulation for Heat Transfer Components

Exposed surface areas should be insulated. Please refer to the DOE Best Practices Steam Tip Sheet<sup>31</sup> on insulation for details on payback and material selection.

##### *Best Practices—Insulation for Heat Transfer Components*

- Insulate all heat transfer units and ancillary components.

#### 4.4.5 Maintenance and Servicing Considerations

Heat-transfer equipment must be designed and installed to allow easy access for cleaning. For example, a heat exchange application that requires constant cleaning should use a single-pass shell-and-tube heat exchanger or plate-and-frame unit that can be easily cleaned, either chemically or mechanically. Therefore, if you suspect that a heat exchanger will need to be cleaned frequently, make sure it is of a design that is easy to clean and installed so that cleaning can take place with minimal problems. Ensuring that the heat exchanger can be properly and quickly cleaned will further ensure that routine maintenance procedures will not hinder system operation.

##### *Best Practices—Maintenance and Servicing Considerations*

- The design and installation of heat-exchange equipment must permit access to the heat-transfer area for cleaning.
- Use the correct type of heat exchanger for the job. A process that requires constant cleaning should use a heat exchanger that is easy to clean, using either chemical or mechanical means.

### 4.5 Heat Containment Best Practices

The efficient operation of a system is contingent upon the ability to maximize heat retention. Best practices for containing heat are often the most cost-effective and easiest to implement. Examples of such practices include:

- Reducing containment vessel heat losses through the proper use of insulation.
- Reducing radiation losses from walls and openings.
- Eliminating unnecessary losses imposed from unnecessary or inefficient cooling.

#### 4.5.1 Reduce Containment Vessel Heat Losses

Heat energy is lost through the walls, roof, and floors of all process heating equipment, especially process furnaces. The walls of any process furnace containment vessel expel heat into the atmosphere by means of conduction, convection, and radiation heat transfer (Figure 4.9). To keep the walls at an equilibrium temperature during operation of the equipment, lost heat must be replaced. For most industrial furnaces or ovens, wall losses represent 3-10% of the total heat input in the furnace.

---

<sup>31</sup> DOE Best Practices Steam Tip Sheet, <http://www.oit.doe.gov/bestpractices/steam/>

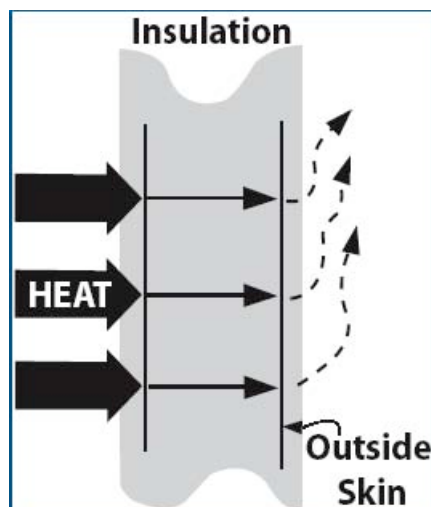

**Figure 4.9** Heat Losses through Wall<sup>32</sup>

The amount of heat conducted through insulation depends on the temperature difference between the interior and exterior of the furnace, the thickness of the insulation, and the insulating value (thermal conductivity) of the product being used. These factors also determine the temperature of the furnace wall that is exposed to the surroundings.

Using the proper type and thickness of insulation can reduce furnace heat losses. Insulation serves as a sort of thermal strainer, holding most of the heat in the furnace, while allowing only a small amount of it to escape. The incremental benefit of insulation in the walls decreases as the thickness of the insulation increases. Beyond a certain point, it is uneconomical to continue adding insulation. The challenge is to determine the combination of insulating material and thickness that is the best compromise between energy efficiency and installation cost.

If existing insulation is in good condition and its composition and thickness are known, technical literature or computer programs published by the insulation industry can be used to calculate the heat losses and forecast the effect of insulation changes on these losses. If the insulation materials are unknown or if they've deteriorated significantly, heat loss can be estimated using the chart in Figure 4.10. The key to using this chart is to first determine an average surface temperature across the walls of the equipment by taking many measurements. This is especially important if the walls exhibit a large differentiating temperature profile, indicating deterioration of the insulation. By using the average you obtain a more accurate assessment of the heat losses from the chart. Once the average temperature is known, the chart can be used to determine the amount of heat being lost and, subsequently, the cost of the energy or heat being lost. This, in turn, can be related to the expense of adding additional insulation to prevent those losses from occurring to find a cost effective solution to this heat loss problem.

<sup>32</sup> U.S Department of Energy: Office of Energy Efficiency and Renewable Energy, *Waste Heat Reduction and Recovery for Improving Furnace Efficiency, Productivity and Emissions Performance*, 2003.

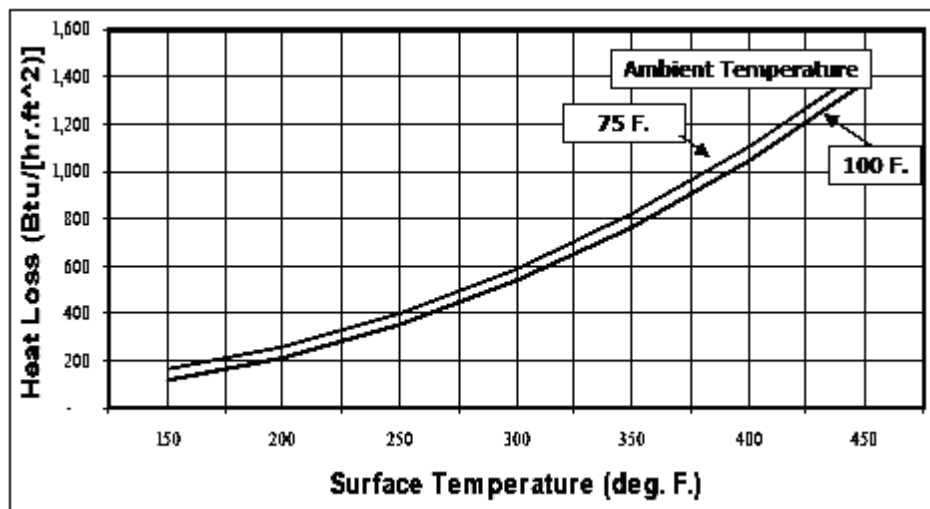

**Figure 4.10** Chart for Estimating Wall Heat Losses

*Best Practices—Reduce Containment Vessel Heat Losses*

- Create a temperature profile of the furnace wall surface using readings from an infrared thermograph or other temperature-measuring instrument.
- Identify “hot-spots” with higher than average temperature and check sources of excessive heat loss (e.g., openings, cracks, damaged or missing insulation etc.).
- If the average surface temperature exceeds 250°F, review the type and thickness of insulation; consult a furnace or insulation supplier to identify improvement opportunities.
- Use fiber insulation, replacing insulating bricks where possible.
- Always perform periodic maintenance of the insulation, inspecting for cracks and missing insulation; repair or replace as needed.

**General Insulation Needs**

Proper insulation is important to keep valuable heat energy from dissipating. Any undesirable heat loss has to be replaced by generating more heat, thus increasing fuel expenses.

*Best Practices—General Insulation Needs*

- Use proper insulation on all exposed piping, fittings, fixtures, traps, and process use equipment. Use the proper type of insulation for the application. Safety issues, temperature, and ambient environment can affect the choice of insulating materials.
- Fiber insulation, which is less costly and easier to install, should be used wherever possible.

**4.5.2 Reduce Radiation Losses from Openings**

Process furnaces operating at high temperatures, for example, above 1000°F, are very susceptible to large radiation heat losses. Also known as opening losses, radiation heat losses occur when the containment vessel is exposed to the atmosphere, allowing radiation heat energy to escape the vessel and transport to a colder surface (Figure 4.11). Anyone who has ever looked into a boiler or reformer can testify to the large amount of heat felt on one’s face.

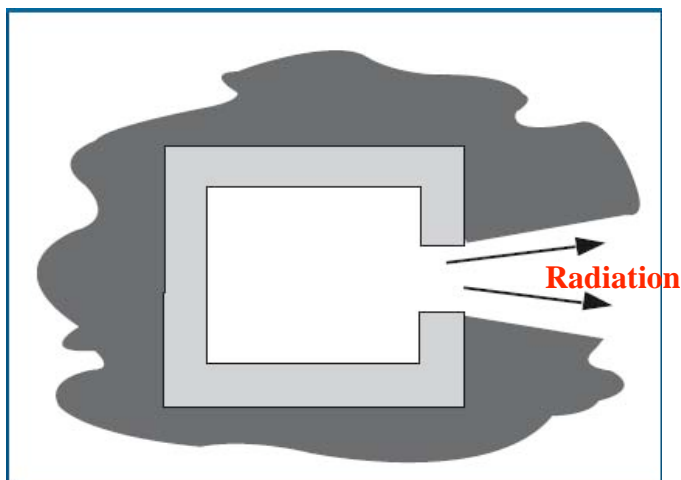

**Figure 4.11** Radiation Heat Losses from an Opening<sup>33</sup>

*Best Practices—Reduce Radiation Losses from Openings*

- Never allow an opening to be continuously ajar.
- Use and maintain proper seals to reduce or eliminate openings.
- Regularly inspect seals for cracks around components such as burners, feed pipes, and cooling tubes; repair as need.
- If closing or sealing doesn't eliminate openings, install a "radiation shield" such as a metal plate or a "ceramic fiber" curtain to reduce direct radiation losses (such as in the case of sight glass openings in a boiler or reformer). A simple shield may reduce radiation losses by half.

### 4.5.3 Reduce Cooling Losses

Some applications require the use of a cooling media to reduce the temperature of the physical structure of the process furnace. Heat energy that is transferred to the cooling medium represents heat loss from the operation that cannot be applied to the desired process, and therefore an additional fuel cost.

*Best Practices—Reduce Cooling Losses*

- Reduce the amount of equipment that must be cooled by using more advanced, less heat sensitive materials, especially in retrofits and new installation.
- Be sure to apply proper insulation to all parts cooled by a cooling medium.
- Always perform periodic maintenance of the insulation, inspecting for cracks and missing insulation, repairing and replacing as necessary.

### 4.6 Waste Heat Recovery Best Practices

The thermal efficiency of process heating equipment such as furnaces and ovens is defined as the ratio of heat delivered to the material being heated to the heat supplied to the heating equipment. For most fuel-fired heating equipment, a large amount of the heat exhaust or flue gases is

<sup>33</sup> U.S Department of Energy: Office of Energy Efficiency and Renewable Energy, *Waste Heat Reduction and Recovery for Improving Furnace Efficiency, Productivity and Emissions Performance*, 2003.

discharged from the furnace. These gases hold considerable thermal energy. In many fuel-fired heating systems, this waste heat is the single, most significant heat loss in the process, often greater than all of the other losses combined. In many cases, the energy efficiency of the system can be increased by using waste heat gas recovery systems to capture and use some of the energy in the flue gas. Benefits from using waste heat recovery include:

- Improved heating system efficiency; energy consumption can typically be reduced by 5-30%.
- A lower flue gas temperature in chimney.
- Increased flame temperature and efficiency.
- Faster furnace startup
- Increased productivity, particularly when waste heat is used for load preheating.

Reducing exhaust losses from the heating system should always be done before starting a waste heat recovery project (Section 4.3.1). The most commonly used waste heat recovery methods are listed below.

- Combustion air preheating (See Section 4.3.1.3)
- Load preheating
- Steam generation
- Use of direct contact water heater
- Cascading of heat to lower temperature processes

#### **4.6.1 Load Preheating**

If exhaust gases from the high-temperature portion of a chemical process can be brought into contact with a relatively cool incoming load (the material being heated), energy will be transferred to the load, preheating it and reducing overall energy consumption. Load preheating has the highest potential efficiency of any system that uses waste gases. Fuel savings using flue gases depend on the amount of heat (percentage of total required for heating) delivered to the load before it enters the heater as well as the available heat for the heater. Load preheating can also increase the productivity of existing equipment, often to a point that exceeds fuel cost savings.

It should be noted that load preheating systems can be difficult to retrofit and hard to implement for batch furnaces. Use of load preheating should be planned during the process design stage to ensure proper design of the heating equipment. A typical system used for fluid heaters in the chemical industry is shown in Figure 4.12. Flue gases from a heater convection section are used to preheat the fluid before entering the fluid heater. Fuel savings in the heater are much more than the actual heat transferred to the fluid in the pre-heater and represent the most effective method of waste heat recovery.

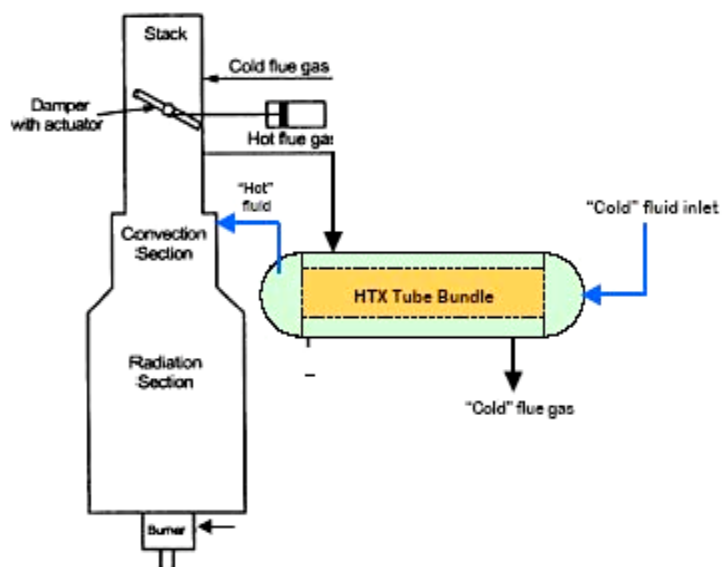

**Figure 4.12** Typical Load Preheating System Using Exhaust Gases

In a few cases, waste heat from other can be used for load preheating. For example, the incoming fluid for a fluid heating application can be preheated with steam or hot gases from other heating processes. In this case, fuel savings can still be realized; however, it is necessary to make sure that both processes are operating simultaneously.

#### *Best Practice—Load Preheating*

- Use hot furnace products or other waste heat from process streams to preheat incoming loads in a separate unit. This is especially applicable during retrofits or new installations.

#### **4.6.2 Waste Heat Boiler Steam Generation**

Steam is a major commodity that can be produced by utilizing waste heat. Boilers that use waste heat from process equipment (furnaces, heaters etc.) are commonly used throughout the chemical industry. These steam boilers are similar to conventional boilers but larger because exhaust gas temperatures are lower than the flame temperatures in conventional systems. Use of the waste heat boilers can reduce a plant's energy demand and, in many cases, eliminate the use of one or many of the boilers currently in operation.

Systems may be relatively small and often do not require special boiler operators, as long as local code and regulatory requirements of monitoring performance are met. Waste heat boilers can be used on most furnace applications, and there are special designs and materials available for systems with corrosive waste gases. They are an ideal option for plants seeking added steam capacity, although it must be remembered that steam is generated only when the fuel-fired process is running. A typical waste heat boiler steam generation system is shown in Figure 4.13.



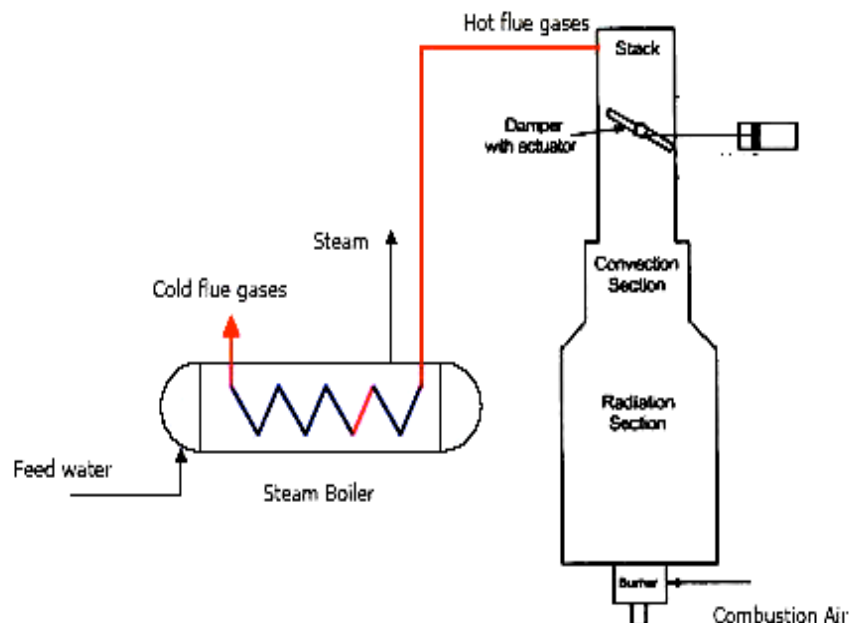

**Figure 4.13** Typical Waste heat Boiler Steam generation System

*Best Practices—Waste Heat Boiler Steam Generation*

- The addition of waste heat boilers to any process heating system is encouraged, especially if additional steam capacity is required or would be beneficial. The boiler can use the waste heat in hot gases as well as liquids from the flue gas of process furnaces or from hot process streams to produce steam. The additional steam capacity maybe sufficient enough to shut down or reduce the load on existing high energy consuming boilers.
- Check the steam demand schedule against the furnace-operating schedule, as steam from a waste heat boiler can be produced only when a source of waste heat is present.

**4.6.3 Waste Heat Hot Water Generation**

Even after primary heat recovery systems are implemented, a large amount of heat energy may escape through flue gases. The flue gas temperatures may range from 250°F to as high as 800°F. Commonly known as “low-grade” heat, this additional waste heat energy can be recovered and used to heat water in a direct contact water heater.

In a direct contact water heater (Figure 4.14), incoming water flows downward through a vertical column filled with stainless steel packing rings. As cold water comes into direct contact with rising hot gases from a heat source (e.g., exhaust gases from a process furnace) heat transfer occurs very rapidly, absorbing 95 to 99% of the heat energy into the water. Pure, heated water can then accumulate in a storage tank for "on demand" use, and clean CO<sub>2</sub> and H<sub>2</sub>O combustion gas can leave the stack at near ambient temperature.

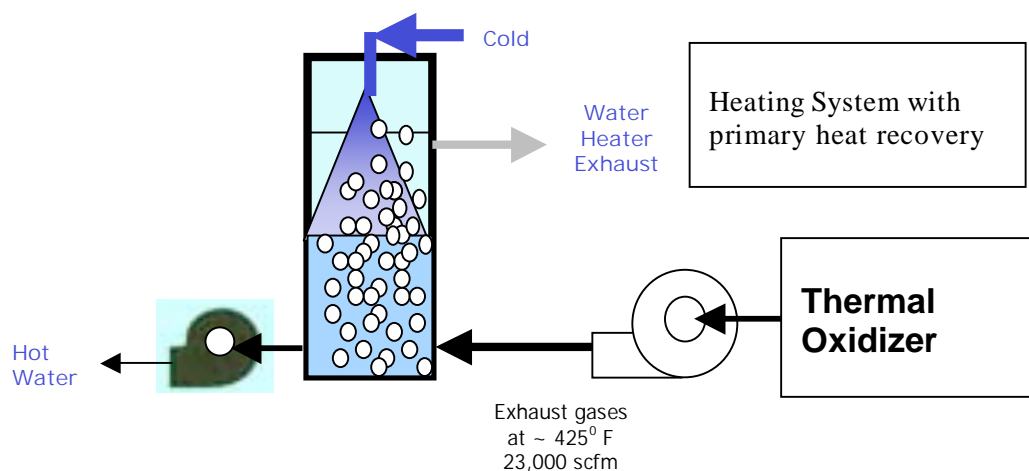

**Figure 4.14** Typical Direct Contact Water Heater Systems

It should be noted that the hot water might contain a very small amount of carbonic acid produced from  $\text{CO}_2$  dissolving in the water. This is not problematic for most one-time uses, such as cleaning vessels, washing, or certain processes where mild acidity is not a concern. In some cases, the presence of a small amount of carbonic acid may actually be beneficial. One should consider all possible consequences of carbonic acid before implementing this type of system. It is not advisable to use this water in a re-circulating loop because the carbonic acid may build up and cause undesirable effects on the system piping, pumps, or even the process itself. This particular system should not be used if flue gases are contaminated with other known or unknown components or potentially undesirable particulates.

*Best Practice—Waste Heat Hot Water Generation*

- Determine water quality requirements and where possible, use water from a direct contact water heater for one-time activities like general washing and sterilization. The slightly acidic water can also be used in chemical mixing tanks, certain aspects of grain mill operations, and general washing applications.

#### 4.6.4 Cascading of Heat to Lower Temperature Operations

The term “energy cascading” is used to describe the flow of energy from high temperature to low temperature in combination with an effective heat utilization system between the two different temperatures. In this process, thermal recovery systems are used to recapture heat that’s transferred between two temperature differentials in smaller temperature differentials or steps rather than all in one large differential. Such systems enable efficient utilization of thermal energy. Waste heat from a primary process may still contain enough energy to operate a secondary process, as long as its temperature is high enough to drive the energy to its intended destination. The goal of cascading heat is to use a continuous flow of waste gases through process after process, operating everything in the factory, until only a stream of lukewarm gases exits the building. Although theoretically possible, multiple process hookups like these are rarely practical. In the majority of cases, it’s feasible to drive only one secondary process.

A common example of cascading heat is the heating of high pressure water or heat transfer fluid with waste heat boilers that uses the exhaust of other high temperature process furnaces to heat the water. Another example is adding air to control the temperature of exhaust gases from high temperature furnaces and then using that mixture to heat lower-temperature flash or direct contact dryers or evaporators. Over the years, numerous companies have installed heat exchangers to create warm air for space heating.

The chart in Figure 4.15 shows heating processes that frequently operate on waste heat from higher temperature processes, and the approximate range of waste gas temperatures they require. These temperatures are only approximate – sometimes lower temperature gases can be used if the heat recovery device is deliberately oversized.

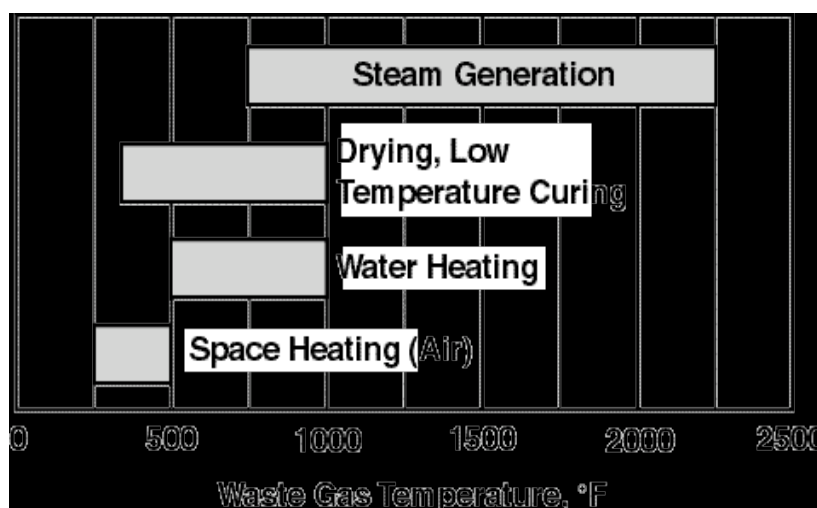

**Figure 4.15** Approximate Exhaust Temperatures Required to Support Secondary Processes

Tying two processes together using cascading heat requires more than just the correct temperatures and heat flows. To make the system operate effectively, the logistics must also be set up correctly. For example, if a chemical plant needs a constant supply of heated water for a specific process, and the water heater is totally dependent on the exhaust from an oven, then the oven has to be run continuously. If this is unacceptable, an auxiliary burner can be installed on the water heater to carry the load when the primary process isn't running. In contrast, as long as the oven is being operated, there will be a supply of hot water, whether it is needed or not.

Another key consideration is the placement of equipment. The closer the primary and secondary processes are situated, the better. Carrying exhaust gases through long runs of ductwork can create an expensive and difficult-to-maintain infrastructure, and the efficiency of energy recovery will be compromised by the heat losses between the two processes. This is of less concern if the primary energy source is liquid or hot oil because these heat transfer mediums can carry energy over greater distances.

The following questions should be considered when evaluating heat cascading in secondary processes with hot waste flue gases:

- Is the temperature of waste gases high enough to heat the secondary process?
- Do the waste gases contain enough transferable energy?
- Are the waste gases compatible with the secondary process (cleanliness, corrosiveness, etc.)?
- Do the primary and secondary processes operate on similar schedules?
- Are the two processes in close enough proximity to avoid excessive heat losses from waste gas ducting?
- Will the waste gases leave the secondary process at a high enough temperature to avoid problems with moisture condensation?
- Can the exhaust ductwork and secondary process be designed to avoid excessive pressure resistance to the waste gases? (Exhaust fans may be necessary.)

*Best Practices—Cascading Heat to Lower Temperature Operations*

- Review processes where heat is used at temperatures lower than the flue gas or other process stream temperatures. Evaluate appropriateness of applying cascading heat.
- Use flue gases or other high temperature process streams to lower temperature processes. This energy-saving method is most effective when the primary and secondary processes operate similar schedules.

#### **4.7 Process Sensors and Controls Best Practices**

Process controls should be installed to optimize the performance of components in the process heating system. Controls provide benefit in three areas:

- Improves process stream condition measurement, allowing better decisions to be made on management of the system as well as equipment selection and optimization.
- Ensures that the highest potential energy efficiency is being reached.
- Helps to decrease the amount of feedstock needed for the process, providing further savings.

*Best Practices—Process Sensors and Controls*

- Develop procedures for regular operation, calibration, and maintenance of process sensors. (For example, pressure temperature and flow sensors and controls)
- For further information about controls, visit [www.ashrae.org](http://www.ashrae.org).

#### **4.8 Additional Process Use Best Practices**

Many of the best practices for process use operations are intended to cover a wide variety of equipment and applications. The same practice often times applies to equipment varying from distillation columns and evaporators to piping and heat exchangers. General equipment best practices will be presented first in this section, followed by a few suggestions for specific equipment situations.

### 4.8.1 Proper Maintenance

Maintenance for process use equipment varies by type and use. However, to ensure continued, efficient operation and to prevent costly failures, preventative maintenance by a qualified person is critical.

#### *Best Practices—Proper Maintenance*

- Follow the manufacturer's suggested maintenance plan. If this is not possible, establish a regularly scheduled maintenance program that closely resembles the recommended plan.
- Assign a highly qualified person to maintain steam traps (may also supervise preventative maintenance, root cause analysis, purchasing, and equipment installation). Steam traps are a major source of heat loss and inefficiency for the chemical industry.
- Perform root cause analysis on failed parts to determine the impact of installation and placement. Determine the exact cause of failure; do not simply assume that the part failed due to non-preventative issues.
- Clean heat exchangers regularly; develop a schedule based on the level of fouling on surfaces.
- Ensure that water used for steam is properly treated.

### 4.8.2 Proper Equipment Selection

Process use equipment drives the efficiency and operation cost of the entire system: distillation columns, evaporators, dryers, steam traps, etc. Always use the correct equipment for the application. The selection of this equipment is dependant on process stream conditions. Poor equipment choice is another source of energy and productivity losses in the process heating system.

#### *Best Practices—Proper Equipment Selection*

- Use the proper selection criteria when ordering from a manufacturer.
- Best practices for proper equipment selection vary, but steam equipment can be used as one example. The process furnace may produce 100 psi steam, but at the point where the equipment is installed the pressure may be 90 psi. Therefore, the device should be used at this rating and not at 100 psi to ensure the most efficient operation.

### 4.8.3 Low Pressure Separation

A decrease in the pressure used in devices such as distillation columns and evaporators will result in a corresponding decrease in the temperature needed to separate constituents. And lower process temperatures mean lower fuel costs.

#### *Best Practice—Low Pressure Separation*

- Decrease pressure as much feasible in separation devices using electric vacuum pumps, thermo compressors, steam jets, and condensers. In turn, this will lower the heat input required for the process.

#### **4.8.4 Proper Energy Transfer Medium**

Operations such as tracing usually use steam or electricity to transfer energy to the process stream. Energy transfer mediums should be chosen based on the application and current utility prices.

#### **4.8.5 Proper Air Venting**

All process heat exchangers— shell and tube, plate and frame, or any other type—require air venting. Air is an insulator and , unless eliminated, will negatively influence start-up times, process operating temperatures, and heat transfer. For further information, see Section 5.6.3.

##### *Best Practices—Proper Air Venting*

- All heat transfer mechanisms should have air vents installed at the locations indicated by the manufacturer.
- Typical points of installation are close to the steam inlet or on the top portion of the unit.

## 5. Process Steam Systems

The chemical manufacturing industry depends heavily on steam for process applications. Given its prominence, it's discussed here in greater detail than other process heating operations. This chapter will focus on best practices in process heat systems; many of these practices yield high-energy savings for minimum initial capital investment.

### 5.1 Overview

Steam is a principle energy source for chemical industrial processes. It provides energy for process heating, pressure control, mechanical drives, and component separation, and is also a source of water for many industrial operations and chemical reactions. The popularity of steam as an energy source stems from its many advantages, which include low toxicity, transportability, high efficiency, high heat capacity, and low production costs relative to other energy transport mediums. [Steam Source Document DOE]

A 1997 study by the Gas Research Institute indicates that throughout industry steam production has been the second-most energy-intensive of all process applications in manufacturing operations (Figure 5.1).

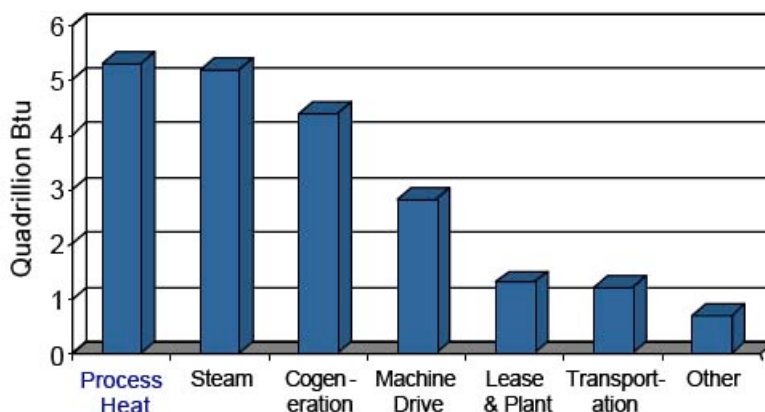

**Figure 5.1** Industrial Energy Use by Process Application [GRI, 1997]

According to Figure 5.1, steam production and steam process uses are responsible for the consumption of over 5 quadrillion Btus (quads) of energy within the manufacturing industry. Of this amount, the chemical industry consumes about 1.54 quads, or nearly 30% of the steam energy used by the industry. Natural gas is the dominant fuel source of process steam systems (Figure 5.2). Due to the increased volatility of the fossil fuel market, energy efficiency measures must be taken to ensure steam remains an economically favorable energy source in the future.

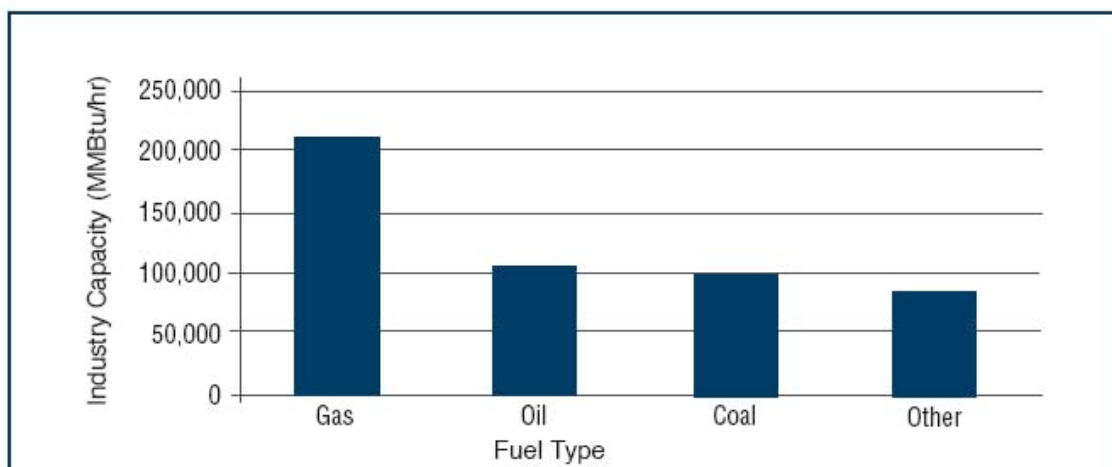

**Figure 5.2** Chemical Industry Boiler Capacity by Fuel Type [Steam Asses DOE]

Many manufacturing facilities have older, inefficient equipment. For them, applying energy efficiency measures known as best practices is the easiest way to realize energy savings. With the concurrent use of advanced technologies, new operating practices, and implementation of best practices, reductions of 20 to 30% in energy costs are possible [Steam Overview DOE].

## 5.2 Explanation of Use

The ability of steam to retain a significant amount of energy on a unit mass basis (between 1,000 and 1,250 Btu/lb) makes it ideal for use as an energy transport medium. Energy can be extracted from the steam in the form of mechanical work through a turbine or as heat for process heating. Since most of the heat contained in steam is in the form of latent heat, large quantities of energy can be transferred efficiently at a constant temperature, which is a useful attribute in many process-heating applications. Steam is also used in contact applications such as the reforming of natural gas for nitrogen fertilizer production. In addition, process steam systems are used to control the pressures and temperatures of many chemical processes, and in applications such as stripping of contaminants, facilitating fractionation of hydrocarbons, and in certain drying operations. [Steam Source Document DOE]

The configuration and operation of process steam systems used by chemical manufacturers are widely ranging. Many facilities do not disclose details of their systems, making it difficult to assess information and pass specific opportunities for savings on to others. This document will discuss four categories of process steam systems and then list best practices based that may be applied to nearly any process steam system. Figure 5.3 represents a typical process steam operation used by a chemical manufacturer.



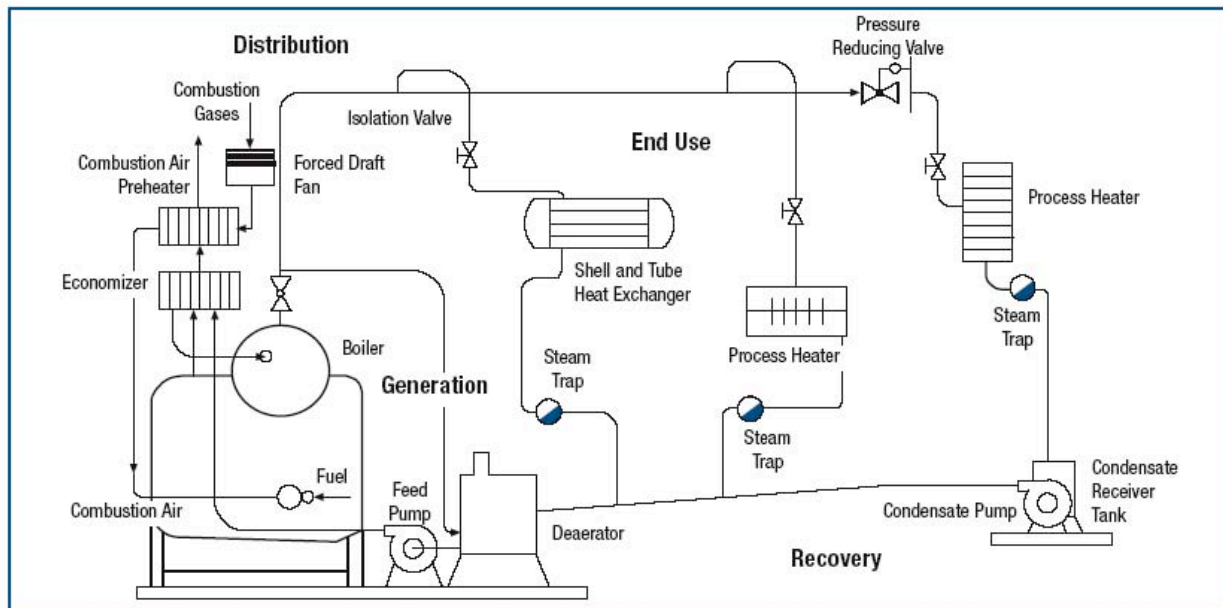

**Figure 5.3** A Typical Process Steam System Schematic

A process steam system consists of the four categories listed below:

- generation
- distribution
- end use
- recovery

### 5.2.1 Generation

Steam is normally generated in a boiler or waste heat recovery device by transferring heat from hot combustion gases or other hot process streams to water. The water absorbs the heat, facilitating the phase change necessary to produce steam. The steam is then transferred under pressure from the boiler to the distribution system. In general, two types of boilers are used to generate steam.

- Firetube boilers—Combustion gases pass through tubes, transferring heat to boiler water flowing over the tubes on the shell side. Benefits of this type of boiler include low initial costs as well as efficiency and durability. The boilers are limited, however, to lower pressure steam production temperatures, generally not exceeding 300 psig, due to the steam being contained in the shell.
- Watertube boilers—Boiler water passes through tubes while hot gases contained on the shell side circulate over the outside of the tubes, transferring heat. The fact that the steam is contained in the tubes and not the shell allows for much higher pressure steam production, on the order of up to 3000 psig is practical. For this reason, and due to their high efficiency, watertube boilers are ideal for applications that require saturated or superheated steam, especially those applications insisting on dry, high pressure, high heat energy steam. About 60% of the steam produced in the chemical industry lies in the range of 300 to 1000 psig. [Steam Assess DOE]

The two boiler types listed are both fuel-fired boilers; in addition, heat recovery devices such as waste heat recovery boilers (WHRB), heat recovery steam generators (HRSG), superheaters, and economizers are used in industry to generate steam.

### **5.2.2 Distribution**

The distribution system is critical because it carries the pressurized steam produced in the boilers to the end-use operations. Systems often have numerous take-off lines that operate at different steam pressures, which are achieved by using isolation valves, pressure regulating valves, and, in some cases, back pressure turbines to separate take-off lines from the original headers. The goal of any distribution system is to deliver to the end-user sufficient quantities of steam at a specified temperature and pressure. An efficient system requires proper pressure balance and regulation, good condensate drainage, and proper insulation. [Steam Source DOE] Typical steam distribution system components include:

- piping
- proper insulation
- valves or turbines
- steam separators, accumulators, and traps

### **5.2.3 End Use**

Steam end-use equipment transfers steam energy into other useful forms of energy that can then be used further in process applications. This document separates process steam end use operations into two categories: steam heat transfer and operational end uses. Steam heat transfer is explained in section 4.2.2.5, Specific Heat Transfer Operations. Section 5.2.3 focuses more on operational end uses that perform applications based on the concept of heat transfer to receive a desired outcome. Table 5.1 lists some of the equipment that is used for process steam operational end uses.

**Table 5.1** Key Steam End Use Equipment [Steam Source DOE]

Equipment	Process Application	Industry
Condenser	Steam turbine operation	Aluminum, Chemical Manufacturing, Forest Products, Glass, Metal Casting, Petroleum Refining, and Steel
Distillation tower	Distillation, fractionation	Chemical Manufacturing, Petroleum Refining
Dryer	Drying	Forest Products
Evaporator	Evaporation/concentration	Chemical Manufacturing, Forest Products Petroleum Refining
Process heat exchanger	Alkylation, Process air heating, Process water heating, Gas recovery/Light ends distillation, Isomerization, Storage tank heating Visbreaking/Coking	Aluminum, Chemical Manufacturing, Forest Products, Glass, Metal Casting, Petroleum Refining, and Steel
Reboiler	Fractionation	Petroleum Refining
Reformer	Hydrogen generation	Chemical Manufacturing, Petroleum Refining
Separator	Component separation	Chemical Manufacturing, Forest Products, Petroleum Refining
Steam ejector	Condenser operation, Vacuum distillation	Aluminum, Chemical Manufacturing, Forest Products, Glass, Metal Casting, Petroleum Refining, and Steel
Steam injector	Agitation/blending, Heating	Chemical Manufacturing, Forest Products, Petroleum Refining
Steam turbine	Power generation, Compressor mechanical drive, Hydrocracking, Naphtha reforming, Pump mechanical drive, Feed pump mechanical drive	Aluminum, Chemical Manufacturing, Forest Products, Glass, Metal Casting, Petroleum Refining, and Steel
Stripper	Distillation (crude and vacuum units), Catalytic cracking, Asphalt processing, Catalytic reforming, Component removal, Component separation, Fractionation, Hydrogen treatment, Lube oil processing	Chemical Manufacturing, Petroleum Refining
Thermocompressor	Drying, Steam pressure amplification	Forest Products

Within the chemical manufacturing industry, steam end-use operations vary widely by process application, as demonstrated by Table 5.1. However, despite the specific operation in use, it is obvious these operations are essential to the overall manufacturing scenario and, therefore, directly linked to productivity. Increases in the efficiency of end-use devices often are directly coupled to dramatic reductions in overall energy consumption.

The most common operational end uses employed by chemical manufacturers include: [Steam Asses DOE]

- stripping
- fractionation
- power generation
- mechanical drive
- process heating
- quenching
- dilution
- vacuum draw

- pressure regulation
- injection
- source of process water

*The information found in the section 5.2.3 was taken directly from material found in Steam System Opportunity Assessment for the Pulp and Paper, Chemical Manufacturing, and Petroleum Refining Industries provided by the Office of Energy Efficiency and Renewable Energy; U.S. Department of Energy [Steam Asses DOE]*

### **Stripping**

Steam is often used to facilitate the separation of components. In stripping towers, steam pulls unwanted contaminants from a process fluid. The steam used in these applications is not directly returned because the effluent has too many unwanted substances.

### **Fractionation**

In fractionation towers, steam is used to assist in the separation of chemical products that contain components with different boiling points. Steam is injected in the bottom of the towers along with a feedstock. The steam helps carry the more volatile products up the tower where they condense on trays that are maintained at the condensation temperature of the desired products. The steam provides a mass transport medium, helps prevent deposition on hot surfaces, and provides favorable viscosity properties of the product within the tower.

### **Power Generation**

In power generation, steam is often used to drive turbines, which, in turn, spin electric generators. Many chemical plants meet their electric power needs with a mixture of purchased power and on-site generation. The ratio between purchased power and self-generated power depends on several factors, including cost of electricity, availability, and capacity of on-sited power generation, anonymous on-sited demand for steam.

### **Mechanical Drive**

In many chemical manufacturing facilities, most mechanical drive energy is supplied by electric power; however, steam and natural gas account for a large portion of this energy component. Approximately 11% of the total mechanical drive energy comes from steam-powered turbines.

Steam is used because of its reliability, availability, and favorable economic feasibility under certain conditions. Because either a turbine or a motor can equally serve many processes, deciding which option to use is typically based on relative economic advantages. Important factors are the cost of steam and net electricity price (accounting for both energy and demand charges). In many critical applications, plants incorporate redundancy by installing both types of drives, thus preventing failure in one power source from causing a costly shutdown.

### **Process Heating**

Steam is used in many chemical process heating applications. Favorable characteristics for these applications include:

- constant temperature heat delivery

- effective temperature control through regulation of steam pressure
- large heat content per unit mass

Steam provides an excellent heat source for applications that require temperatures between 250-500°F. Competing sources of process heat include direct-fired furnaces and process fluid heat recovery heat exchangers. Although steam is used in applications with temperatures up to 700°F, the pressure requirement for it often makes its generation and distribution impractical. Direct-fired furnaces can typically achieve higher temperatures than steam can feasibly provide and are, therefore, widely used in many chemical industry applications. In addition, many chemical production processes involve exothermic reactions that provide opportunities for process heating with fluid-to-fluid heat exchangers.

### **Quenching**

An important part of controlling chemical reactions is the regulation of the reaction temperature. In many applications, steam controls process temperature by quenching. Many chemical processes involve exothermic reactions and the heat released affects the temperature of the reaction. Steam is often directly injected to regulate such processes. Steam has a large latent heat capacity and can often be separated from process streams in subsequent steps, especially with chemicals that have a low solubility in water.

### **Dilution**

Steam is often used to dilute a process gas, which, in turn, reduces coke formation on the surfaces of heat exchanger. Many chemical products, particularly hydrocarbons, tend to form deposits on high-temperature surfaces, thus reducing heat transfer. Because these deposits are difficult to remove, steam is often injected with process chemicals to minimize their surface formation. Steam helps by diluting these chemicals and by reducing localized hot spots.

Steam ejectors may be used in certain process equipment to produce a vacuum. Other equipment that serves this purpose includes motor-driven vacuum pumps. The amount of steam used for this purpose varies from plant to plant, depending on the manufacturing operation.

### **Pressure Regulation**

Steam is often used to control the partial pressure of a reaction. When steam is injected with reactants in a fixed-volume vessel, it can increase the pressure and cause a desired shift in the reaction. This use of steam is particularly effective when the reactants have low solubility in water. An example of this use is found in ethylene production, where steam is injected in the pyrolysis furnace to inhibit unwanted reactions.

### **Injection**

Steam is often directly injected into a process to help transport products. Steam effectively serves in these applications by providing a source of pressure or by acting as an entrainment medium. A favorable characteristic in such an application is the ability to separate water from the product in subsequent steps.

### **Source of Process Water**

Steam is also a source of water as a solvent and a feedstock. As a solvent, steam provides both heat and solubility. As a feedstock, it provides a source of pressure, temperature, and hydrogen (e.g., as in steam methane reforming in the ammonia industry).

#### **5.2.4 Recovery**

The purpose of the recovery system and its components is to collect and return the condensate back to the generation sector of the system. The benefits of using a condensate system are two-fold. The water returned by the condensate system, which has previously been chemically treated, can be reused as boiler feedwater within the process steam system, lowering the cost of treating new boiler feedwater. Second, the thermal gain of using condensate water instead of makeup boiler feedwater reduces energy consumption since the temperature of condensate water is considerably higher than makeup water. The cost savings from not purchasing, heating or treating the boiler makeup water often make investments in condensate recovery systems economically feasible. [Steam Source DOE]

Another benefit of a condensate recovery system is the use of flash steam vessels to produce low-quality steam. The low quality steam is produced by flashing the above ambient pressure condensate return water in a flash chamber at ambient pressure. It can then be used for operations such as space heating or the heating of water for personal use.

A typical condensate can and often does contain the following seven components.

- condensate return piping
- proper insulation
- condensate return tanks
- pumps
- flash steam vessels
- condensate meters
- filtration/cleanup equipment

### **5.3 Process Steam Systems Best Practices**

Table 5.2 is intended to be used as a first step to identify opportunities for possible reductions in energy consumption and improved efficiency for nearly all process steam systems. The table lists opportunities for improvement in energy generation, distribution, and recovery. In general, optimizing the efficiency of steam-supplied end uses requires a case-by-case assessment and is therefore not included in Table 5.2. The remainder of Chapter 5 will provide more detailed information describing the best practices found in Table 5.2 and elaborate further on additional energy efficiency measures, including those for steam end use operations.

**Table 5.2** Common Performance Improvement Opportunities of Process Steam Systems

Opportunity	Description
<b>Generation</b>	
Minimize excess air	Reduces the amount of heat lost up the stack, allowing more of the fuel energy to be transferred to the steam
Clean boiler heat transfer surfaces	Promotes effective heat transfer from the combustion gases to the steam
Install heat recovery equipment (feedwater economizers and/or combustion air preheaters)	Recovers available heat from exhaust gases and transfers it back into the system by preheating feedwater or combustion air
Improve water treatment to minimize boiler blowdown	Reduces the amount of total dissolved solids in the boiler water, which allows less blowdown and therefore less energy loss
Recover energy from boiler blowdown	Transfers the available energy in a blowdown stream back into the system, thereby reducing energy loss
Add/restore boiler refractory	Reduces heat loss from the boiler and restores boiler efficiency
Optimize deaerator vent rate	Minimizes avoidable loss of steam
<b>Distribution</b>	
Repair steam leaks	Minimizes avoidable loss of steam
Minimize vented steam	Minimizes avoidable loss of steam
Ensure that steam system piping, valves, fittings, and vessels are well insulated	Reduces energy loss from piping and equipment surfaces
Implement an effective steam-trap maintenance program	Reduces passage of live steam into condensate system and promotes efficient operation of end-use heat transfer equipment
Isolate steam from unused lines	Minimizes avoidable loss of steam and reduces energy loss from piping and equipment surfaces
Utilize backpressure turbines instead of PRVs	Provides a more efficient method of reducing steam pressure for low-pressure services
<b>Recovery</b>	
Optimize condensate recovery	Recovers the thermal energy in the condensate and reduces the amount of makeup water added to the system, saving energy and chemicals treatment
Use high-pressure condensate to make low-pressure steam	Exploits the available energy in the returning condensate

### 5.3.1 Institute Process Steam System Standard Operating Procedures

All steam systems must have a documented Standard Operation Procedure (SOP) to ensure proper operation. The instructions in the SOP should enable a user to complete a job safely, with no adverse impact on the environment (thus meeting compliance standards), and in a way that maximizes operational and production requirements. Planning, writing, and initiating should be the first steps in attempting to implement any best practice provided in this manual for process steam systems.

For many years, Quality Assurance people at large companies have been creating SOPs to help workers produce quality products to enhance a company's competitiveness. Operational personnel, maintenance staff, or even supervision personnel can lack a clear understanding of an operation. They can make mistakes when operating the steam system, causing premature failures and safety issues in the plant.

SOPs are written to:

- provide individuals who perform operations with all the safety, health, environmental, and operational information required to perform a job properly
- protect the health and safety of employees, and to protect the environment
- protect the system and the plant
- ensure that operations are done consistently in order to maintain quality control of processes and products
- ensure that processes continue and are completed on a prescribed schedule
- ensure that no failures occur in manufacturing or related processes that would harm employees or anyone in the plant
- ensure that approved procedures are followed in compliance with company and government regulations
- serve as a training document for teaching users about a process
- serve as an historical record when processes are modified or SOPs revised
- provide an explanation that can be used in incident investigations that seek to improve safety practices and operating conditions
- prevent premature failure of components due to improper startups
- teach new employees

## **5.4 Steam Generation Best Practices**

As indicated in Section 5.2.1, steam is generated by direct-fired firetube or watertube boilers, (the most common fuel being natural gas) or, in some cases, by utilizing waste heat or the heat energy of other chemical process streams. Therefore, steam generation best practices are intimately related to the heat generation, transfer, containment, waste recovery, and process controls best practices for process heating systems found in Chapter 4. The remainder of this section will list the best practices for chemical process steam generation; some best practices will simply be references back to Chapter 4, Process Heating Systems, while best practices not included in Chapter 4 will be explained in more detail.

### **5.4.1 Determine the Optimal Steam Pressure**

Steam pressure should be as low as possible for performance specifications. Care should be taken in selecting the correct steam pressure because pressure that's too high can cause control problems, require additional safety equipment, and result in different materials of construction, etc. In addition, it takes more energy to produce higher temperatures and pressure steam.

If the majority of steam end-use devices are operating at a lower steam pressure than what is produced for the main header and other higher steam pressure requiring equipment, it may be advisable to lower the operating pressure of the boiler. In such cases, the higher pressure equipment may benefit from an adjustment, such as the installation of a stand-alone boiler. This evaluation must be done on a case-to-case basis. As a rule of thumb, a 10-psig drop in steam pressure can lead to a 1% reduction in energy costs.



*Best Practices—Determine Optimal Steam Pressure*

- The boiler plant should produce steam at the lowest possible pressure level to meet the plant requirements.
- Provide a separate heat source for parts of processes that require high pressure steam or process heating fluid, thus minimizing the need to operate the entire plant at elevated pressures or temperatures.

**5.4.2 Reduce Boiler Flue Gas Losses**

The explanation and best practices for reducing boiler flue gas losses are the same as those found in Chapter 4, Process Heating Systems, Section 4.4.1 Reduce Flue Gas Losses. In addition, the information in Sections 4.4.1.1 through 4.4.1.3 provides further explanation of the best practices found in Section 4.4.1.

*Best Practices—Reducing Boiler Exhaust Gas Losses*

- Monitor and maintain the proper level of O<sub>2</sub> concentration, 2-3% by operating at the correct air/fuel ratio for the burner.
- Use heat recovery of flue gas where possible to preheat incoming combustion air.
- Eliminate or reduce all sources of undesired air infiltration into the furnace.
- Perform proper maintenance on a regular schedule to reduce soot and other deposits on heat transfer surfaces, thus ensuring efficient transfer of heat to the process.

**5.4.3 Performing Proper Boiler Maintenance**

For greatest efficiency, boilers need proper maintenance at scheduled intervals. Scheduled maintenance ensures efficient, reliable operation. The key is not to “fix it when it breaks,” but keep it from breaking in the first place.

*Best Practices—Performing Proper Boiler Maintenance*

- Ensure that heat transfer surfaces on indirect heat generation furnaces are clean and free of deposits and soot.
- Ensure burner is operating properly and most efficiently within the limits set by controls and operators.
- Continuously inspect the furnace enclosure for deterioration or safety problems.

**5.4.4 Use of Heat Recovery**

The use of heat recovery devices to produce steam is normally an economically sound investment, but all situations should be evaluated on a case-to-case basis. Typical heat recovery devices include: waste heat recovery boilers (WHRB), heat recovery steam generators (HRSG), super heaters, and economizers. Further information on waste heat recovery best practices can be found in Section 4.6, Waste Heat Recovery Best Practices, specifically, Section 4.6.2, Waste Heat Boiler Steam Generation.

*Best Practices—Use of Heat Recovery*

- The addition of waste heat boilers to any process heating system is encouraged, especially if additional steam capacity is required or would be beneficial. The boiler can use the waste heat in hot gases and/or liquids from the flue gas of process furnaces or from hot process streams to produce steam. The additional steam capacity maybe

sufficient enough to shut down or reduce the load on existing high energy consuming boilers.

- Check the steam demand schedule against the furnace operating schedule, as steam from a waste heat boiler can only be produced when a source of waste heat is present.

#### 5.4.5 Reduce Blowdown Energy Losses

Solids, either suspended or dissolved, are always present in water. High levels of total dissolved solids (TDS), which eventually become sludge and settle in the bottom of a boiler, can both lower the boiler's heat transfer capabilities and cause significant damage to the unit. High levels of TDS also lead to foaming and carryover of liquid water into the steam supply. This reduces the efficiency of the system and can lead to water hammer, which may damage pipes, control valves, steam traps, and end-use equipment.

Solids are removed from the boiler by a process known as blowdown. There are two types of blowdown: bottom and surface. Bottom blowdown is a manual process to remove the dissolved solids that have accumulated on the bottom of the boiler. The procedure is performed at regular intervals according to the type of boiler as well as steam and water usage. Surface or top blowdown removes solids that are floating on or near the surface of the water in the boiler. Boilers have a metered opening just below the water's surface; high pressure inside the boiler forces or blows hot water (and the TDS) through this opening. There are three types of surface blowdown: intermittent, continuous, and automatic. A typical blowdown system can be seen in Figure 5.4.

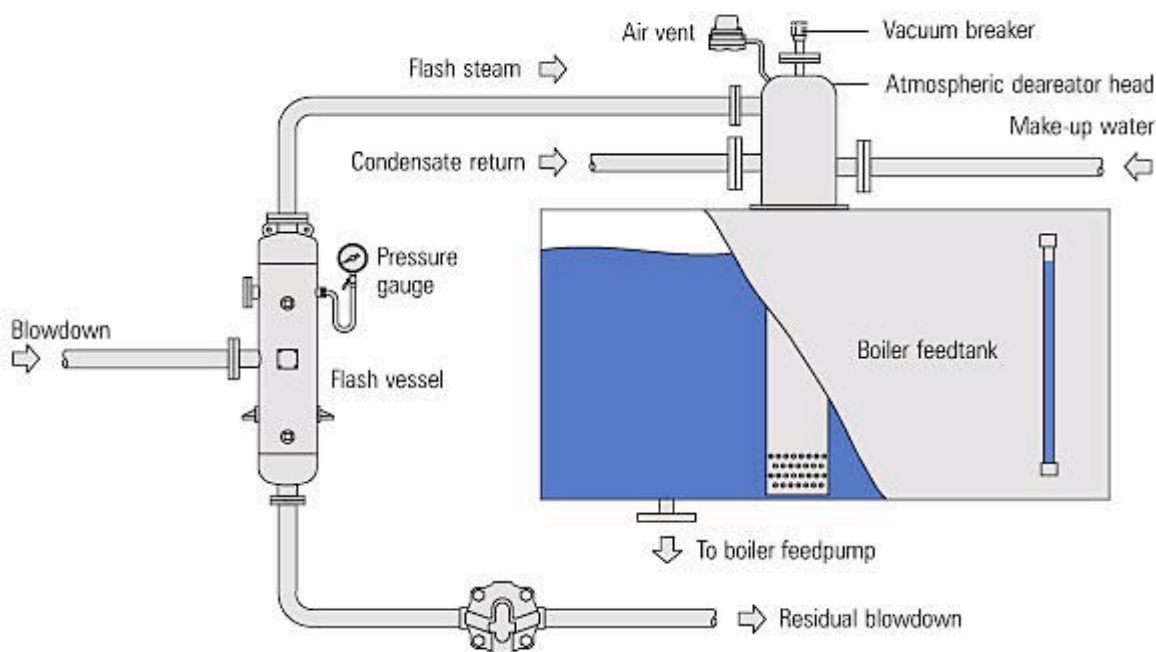

**Figure 5.4** Schematic of Blowdown System<sup>34</sup>

<sup>34</sup> The Energy Solution Center website

[http://www.energysolutionscenter.org/BoilerBurner/Eff\\_Improve/Efficiency/Blowdown\\_Heat\\_Recovery.asp](http://www.energysolutionscenter.org/BoilerBurner/Eff_Improve/Efficiency/Blowdown_Heat_Recovery.asp)

All blowdown procedures remove hot water and, therefore, energy from the steam system. This causes a decrease in total energy efficiency. Removing more water than is necessary to control TDS wastes energy as well as money if water treatment chemicals are unnecessarily removed. In order to reduce these wastes and improve steam reliability, installation of an automated system that optimizes the interval and quantity of blowdowns should be considered. An automated system consists of controls, a valve, piping (if needed), and equipment that indicates TDS levels based on some measurement, such as the conductivity or relative density of the water.

*Best Practices—Reduce Blowdown Energy Losses*

- Whenever possible, improve water treatment mechanism to reduce the amount of total dissolved solids in the boiler feedwater, in turn reducing the frequency of blowdown.
- Install an automated blowdown system to optimize the interval and quantity of blowdowns, so the least amount of energy is wasted.
- Install a blowdown heat recovery device. This will generally include two methods of recovery, heat exchanger and flash steam generation.

#### **5.4.6 Boiler Heat Containment**

Containment of the heat produced within or transferred to a piece of process heating equipment is essential for efficient operation of a system. Many times, best practices that fall into the category of heat containment are easy and cost-effective to implement. Boiler heat containment best practices are much the same as the heat containment best practices for process heating systems; Section 4.5 should therefore be reviewed for more information on this topic.

*Best Practices—Boiler Heat Containment*

- Reduce containment vessel heat losses through the proper use of insulation and refractory.
- Reduce radiation losses from walls and openings.
- Eliminate unnecessary losses imposed on the system by unnecessary or inefficient cooling.

### **5.5 Steam Distribution Best Practices**

While generating steam is a fuel-intensive process, transporting and using the steam require energy as well. The more efficiently all processes perform, the more efficiently the overall system will operate, requiring less fuel consumption for the same operation. This is called a systems approach to energy reduction thinking. The remainder of this section will provide best practices for improving the efficiency, reliability, and safety of the steam distribution system.

#### **5.5.1 Eliminate Steam Leaks and Venting**

Steam leaks and venting waste energy. Small leaks are often considered trivial and go unnoticed, never to be repaired. However, the cumulative loss from these leaks in the distribution and condensate recovery system can add up to tens of thousands of dollars. Figure 5.5 illustrates how even the smallest leak can result in large, unnecessary additional energy costs.

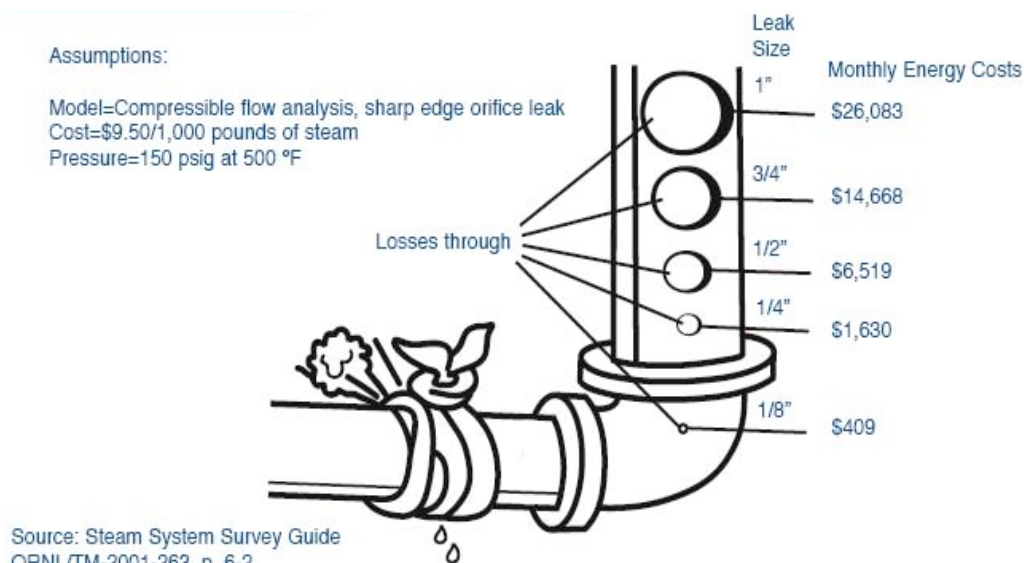

**Figure 5.5** Impact of Steam Leakage on Monthly Energy Cost [Steam Opportunity DOE]

*Best Practice—Eliminate Steam Leaks and Venting*

- Minimize all avoidable steam losses from leaks and/or venting.
- Continually inspect steam distribution and condensate return lines for leaks and repair as necessary.

**5.5.2 Proper Steam Line Materials and Installation**

The B31.1 Power Piping Code and, specifically for the chemical industry, B31.3, prescribes minimum requirements for constructing power and auxiliary service piping. However, the code does not include regulations for determining optimum system function and effective plant operations. It does not define any other measures necessary to assure the useful life of piping systems. These concerns are the responsibility of the designer and after construction turn-over, the operating company personnel are responsible for plant activities.

Granted, all plants should abide by the guidelines set forth in codes B31.1 and B31.3. In addition, every plant should have in place a standard for materials to be use for different steam applications. Several examples are suggested below, however, each scenario should be treated on a case-by-case basis and the best decision should be based on information specific to the situation.

**Steam Pipe**

- carbon steel
- stainless steel
- alloys (depending on pressure and temperatures)

**Steam Tube**

- carbon steel
- stainless steel
- alloys (depending on pressure and temperature)

**Condensate Line (Pipe material)**

- stainless steel
- carbon steel (sch. 80)

**Condensate Line (Tube material)**

- stainless steel

Steam and condensate piping systems can be installed with any of the following, or a combination of any of the following:

- threaded pipe
- welded pipe joints
- flanges
- tube material
- tube connectors

*Best Practices—Proper Steam Line Materials and Installation*

- Materials used for steam and condensate systems should be specified and applied based on codes B31.1 and B31.1, as well as internal requirements for performance and reliability.
- All pipes or tubes should be welded, which minimizes leaks as the pipe expands and contracts during heating and cooling cycles. Welding also eliminates leaks from corrosive carbonic acid in the system, which is formed from carbon dioxide in the air and water.
- Screwed connections should be used to install equipment that requires frequent maintenance such as traps, valves, check valves and pipes smaller than two inches. Flanges are utilized in applications larger than two inches where maintenance or removal may be required.
- All steam supply and condensate return pipes should be properly supported, guided, and anchored, allowing for expansion of the pipes during temperature changes. A structure that is too tight can deform pipes and cause leaks.

**5.5.3 Ensure Steam Quality**

Steam quality is an important characteristic. In thermodynamic terms, quality is used to define how much vapor, by mass, is in a vapor/liquid mixture. The steam boiler or steam generator induces energy to the boiler water; phase change occurs (steam is generated) and the state of the water moves to the right from point A toward point B at constant temperature, see Figure 5.6. After the steam has reached point B, any increase in the steam energy is known as superheat. When energy is extracted from the steam at point B (phase change back to the liquid) the steam travels back toward point A on the curve below.

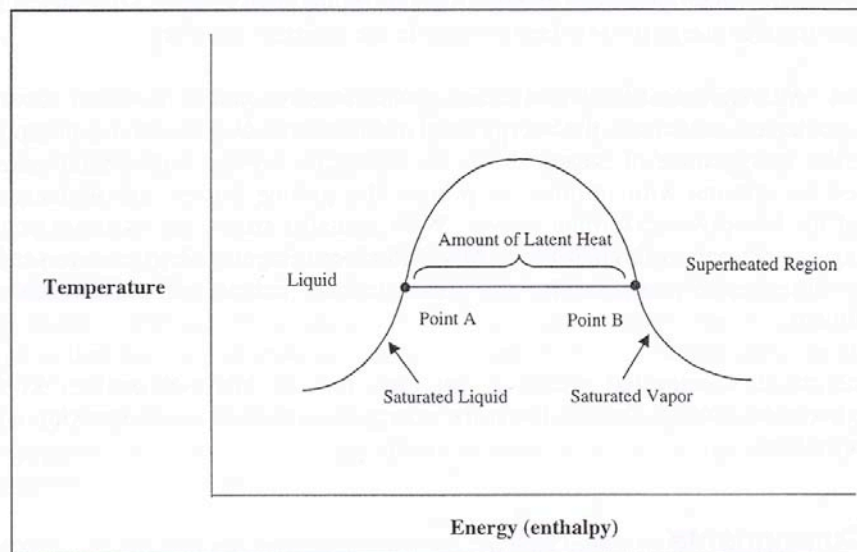

**Figure 5.6** Temperature Energy Curve for Typical Process Steam System

Steam quality indicates where an operation would be positioned on the latent heat line (see Figure 5.6). Based on a review of chemical industry process steam systems, most processes require saturated steam in vapor form (Point B in Figure 5.6), also known as 100% steam quality or steam with no minute droplets of condensate in the vapor. The addition of any energy to superheat the steam can cause problems with heat transfer processes if the original design does not accommodate the superheated condition of the steam. Furthermore, in order to handle the pressure and temperature of the steam, superheated steam temperatures may require material changes. On the other hand, wet steam or steam that is less than 95% vapor (meaning 5% percent by mass is moisture or liquid) can lead to erosion, reduced heat transfer efficiency, premature steam component failure, and other problems.

#### *Best Practices—Ensure Steam Quality*

- Steam should be delivered to the end-use operation in the desired condition. Normally 100% saturated steam vapor is used.
- Always connect the branch line to the top of the main steam line. This will ensure dry, saturated steam to the process.
- Use proper drip-pocket steam traps, correct branch connections, and installation procedures where applicable.
- Install and maintain proper insulation on all steam and condensate return lines.
- Ensure proper pipe sizing is used to maintain correct velocities in steam line based on specifications of operation.
- Install and maintain coalescing mechanical separators where applicable.
- Implement the use of steam filters throughout the process steam system.

#### **Use Proper Drip Pocket Steam Trapping**

To ensure steam quality remains constant in the distribution system, all steam lines must be adequately trapped for condensate removal. This helps ensure continuous, efficient operation of the system at its design parameters. Condensate may produce pipe hammering and can damage equipment by producing rust. Air can also cause condensate to form.

A drip pocket vertical branch line is a properly sized vertical line that will remove “drips” of condensate formed by thermal losses in the steam line, even if the line is properly insulated. A schematic of a typical drip pocket steam trap is shown in Figure 5.7. The ideal diameter of the drip pocket depends on the diameter of the steam piping. The following parameters serve as guidelines for installing a drip-pocket steam trap.

- 2-inch steam line, 2-inch drip pocket
- 3-inch steam line, 3-inch drip pocket
- 4-inch steam line, 4-inch drip pocket
- 6-inch steam line, 6-inch drip pocket
- 8-inch steam line or above, one pipe diameter smaller than the steam line for the drip pocket

In addition, the vertical branch line should extend at least 18 inches in front of the drain line to the steam traps is tapped into the drip pocket branch connection with an additional pocket length of three or more inches off the bottom of the drain line connection. Finally, a blow-off valve should be installed at the bottom of the drip pocket.

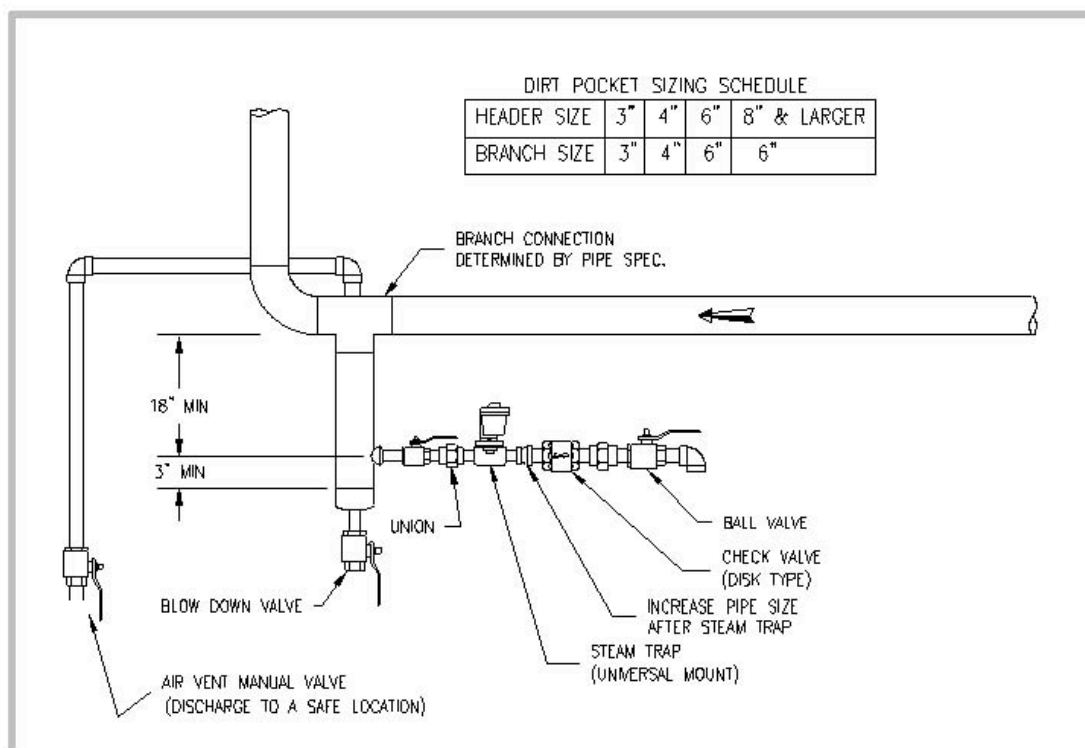

**Figure 5.7** Schematic of a Typical Drip Pocket Steam Trap Installation

All low points in the piping where condensate could collect during periods of little or no steam usage require steam traps. Manual blow-down lines should be provided where large start-up condensate loads are expected.

*Best Practices—Use Proper Drip Pocket Steam Trapping*

- Steam traps should be installed at all low points in the process steam distribution system.
- Steam traps should be installed wherever there is a sudden change in direction.
- All valves, especially those that will be in the off position, should have steam traps installed behind them in the distribution system.
- Drip pockets should be used in conjunction with steam traps.
- When using drip pockets, follow suggested guidelines and parameters, making sure drip pockets are properly sized and installed.

### **Utilize Proper Insulation on all Steam Lines**

As the temperature of the steam in the distribution system drops, energy is wasted. While some temperature drop is unavoidable, effectively insulating vessels, steam lines, valves, and even condensate return lines can help to reduce losses.

#### *Best Practices—Utilize Proper Insulation on all Steam Lines*

- Insulate as many steam lines, condensate return lines, and ancillary components as economically feasible.

### **Sizing Steam Lines**

Selecting the correct size for steam lines is just as important as selecting and sizing the steam control valve or the heat transfer rate of a piece of end-use equipment. Undersized steam lines lead to steam pressure starvation at the end user, a condition that often is mistaken for a heat transfer problem or control valve issue. In addition, correctly sized steam piping ensures that steam quality is maintained at the design value. Over-sizing is never a problem except for its additional cost.

When designing steam headers, branch lines, and condensate lines, there are general rules regarding velocities in the piping. Steam velocity raises the issue of noise (DBA) and excessive pressure drops, which should be considered carefully on all new designs or retrofits. Following are some rules to keep in mind while sizing steam piping:

- Steam heating system velocities are typically in the range of 4,000 to 6,000 feet per minute.
- Process steam velocities are acceptable up to 10,000 feet per minute.
- Condensate piping velocities (steam) must be kept lower than 4,500 feet per minute
- Condensate piping velocities (fluid only) must be kept to 3 to 7 feet per second

#### *Best Practices—Correct Pipe Sizing*

- Follow the guidelines provided in Section 5.5.4.3 when sizing piping for a new design or retrofit.
- Steam line velocities should never exceed 10,000 feet per minute.



### 5.5.5 Additional Steam Line Needs

All steam lines must have either automatic or manual air vent devices to remove air during plant start-up (see Figure 5.7). If the system has no air venting capability, then all of the air in the steam line at start-up will flow into the process equipment. In addition, pressure gauges should be located throughout the system to provide pressure drop information. Pressure indication also provides information on the steam line sizing. If the line is too small for the steam load, the pressure drop will be high.

#### *Best Practices—Additional Steam Line Needs*

- Air vents and pressure gauges should be installed on all steam lines.
- Standard operating procedures for using air vents at startup should be instituted.
- Ball valves with a class four shutoff should be used in conjunction with air vents.

### 5.5.6 Proper Maintenance

Maintenance must be considered when designing and installing piping and associated devices. If these components are not accessible, there will be very little or no maintenance. Steam and condensate piping systems must be maintained. They are as important as the equipment they tie together. The first thing required is a chemical treatment program. The proper chemicals will allow the system to run at a neutral pH and provide a protective coating on the inside of the piping to suppress corrosion.

#### *Best Practices—Proper Maintenance*

- Steam and condensate piping should be checked periodically and repaired, if needed.
- Steam piping should be checked periodically for thickness using an ultrasonic thickness meter. Physical inspection during downtimes is also a good practice.
- Consider corrosion coupons for the piping of condensate systems. This will help determine chemical treatment effectiveness and gauge the condition of the piping.

## 5.6 Steam End Use Best Practices

As stated previously, optimizing the efficiency of steam-supplied operational end-uses generally requires a case-by-case assessment. This section will provide best practices that cover generalities of steam heat transfer and operational end-use equipment in the chemical industry.

### **Installation Guidelines:**

Improper installation will cause:

- Premature failure of all components including:
  - Heat exchanger equipment
  - Steam traps
  - Control valves
  - Piping
- Poor control
- Waterhammer

*Proper installation guidelines:*

- Install a condensate drip pocket with a steam trap ahead of the steam control valve.
- Use ball valves with locking handles for pipes with diameters less than two inches. This provides the best safety procedure for lock out–tag out. Be sure to check with the appropriate persons to ensure compliance with any company, local, state, or federal regulations concerning lock out–tag out procedures.
- Install a strainer ahead of the control valve.
- Control valves selection is influenced by required turndown capabilities. A turndown capability is the valve’s ability to control at a low point of operation. A valve that has a 40:1 turndown with a maximum flow of 1000 lbs. per hour, the turndown ratio is the highest output divided by the lowest. For example, a valve that requires 1000 lbs. per hour flow rate (max.) and a minimum flow rate of 25 lbs. per hour has a turndown ratio of 40.
  - Cage control = 40:1 turndown with the highest degree of controllability
  - Globe control valve = 30:1 turndown
  - Regulating valve = 20:1 turndown
- Install pressure gauges before and after the control valve.
- Control valve outlet piping must be increased to be equal to or larger than the inlet connection to the heat transfer unit. The control valve should be located at least 10 pipe diameters away from the heat transfer unit with the expanded pipe.
- Install a vacuum breaker and an air vent on the heat transfer unit or the steam supply inlet.
- Condensate drainage pipes should have a vertical drop away from the heat transfer unit of at least 18 inches or greater.
- The horizontal distance from the vertical drop leg (condensate outlet of heat exchanger) to the steam trap should never be more than eight inches to avoid steam locking.
- For capacities of 8,000 lbs. per hour or less, use a steam trap.
- For capacities of 8,000 lbs per hour or greater, use a control valve trap with a level controller instead of a steam trap.
- Install a test valve or a visual sight glass after the steam trap for visual indication of performance.
- Never take a RISE (rise in the vertical height elevation) in the condensate line after the condensate drain device if there is a modulating control valve (A control valve is responding to a PID controller –the valve can be at 0 or 100% or any place in between to meet the requirement of the system) off the inlet of the heat transfer unit. Condensate discharge piping rising (elevation) after a drain device is one of the most significant causes of premature failure of heat transfer equipment primarily due to the condensate not being readily removed from the process and causing water hammer.
- If gravity drainage is not achievable then a pumping steam trap or liquid mover must be installed to accommodate the lifting of condensate.

### 5.6.1 Get Necessary Heat Transfer Information

#### A few of the key issues with steam heat transfer

Several issues surfaced as we reviewed the operation of different chemical plants, prepared this document and analyzed numerous industrial heat-transfer applications. The more prevalent, which can be prevented with properly selected heat transfer components include:

- incorrect steam pressures
- code violations
- waterhammer
- poor temperature control
- premature failures
- dirt build-up
- improper trap selections
- condensate back pressure problems (including overhead condensate returns)

One of the most common comments from chemical manufacturers regarding the selection of the correct heat transfer unit is lack of specific requirements for the application. For example, when selecting the correct steam pressure, the end user does not normally know the steam supply pressure at the exact point the heat transfer equipment is going to be installed. Often an end user is unaware of the parameters that are required to determine the proper heat transfer. When a heat exchanger has failed, the end user will often simply purchase a replacement without doing root-cause analysis.

Very little consideration is given to design, selection, longevity, performance or failure (e.g., the maximum and minimum flows and normal operating conditions of the heat transfer.) This must be done with all components that are going to be selected in process applications. The end user needs to give the control valve manufacturer the correct minimum, maximum, and normal flow requirements for the process application. This is also true for the manufacturers of steam traps and other related steam equipment. Therefore, in every heat transfer process application, certain criteria must be provided to the manufacturer to ensure the correct heat exchange equipment is sized and selected. The following information should be determined for proper sizing and selection of heat transfer equipment and associated components for a chemical plant.

#### Process conditions:

- Process fluid or vapor
- Maximum flow
- Minimum flow
- Normal
- Process pressure
- Design pressure
- Maximum allowable pressure drop
- Inlet temperature
- Outlet temperature

- Specific heat
- Specific gravity
- Weight per pound
- Foul factor

**Steam conditions:**

- Steam pressure, temperature (upstream of control valve)
- Steam pressure, temperature (downstream of control valve)
- Design pressure
- Maximum pressure
- Minimum pressure
- Operating pressure
- Steam flow
- Design flow
- Maximum flow
- Minimum flow
- Operating flow
- Condensate return flow

**5.6.2 Economics of Heat Exchanger Selection**

Economic Considerations in Heat Exchanger Selection —There are economic considerations associated with the different types of heat transfer units. For example, low-steam pressure has several different heat transfer options. A plate-and-frame heat exchanger will have a lower initial cost compared to a shell-and-tube design, although both designs will meet performance specifications. But when steam pressure is increased to 100 psig, the selection of heat transfer equipment becomes limited to a shell-and-tube unit whose design is able to withstand higher steam pressure and temperature. A plate-and-frame unit will have a lower temperature and pressure rating due to the rating of its gasket materials.

Higher steam pressure can decrease the required heat transfer surface area, a result of the higher temperature differential between the steam and process. Pressure drops permitted by the system affect heat exchanger size. The highest allowable pressure drop results in savings if the heat exchanger surface area. As important as the pressure drop limitations are on the process side, it is as crucial to understand pressure drops on the steam side, when selecting the external components of the heat transfer unit.

Space restrictions sometimes affect heat exchanger costs. If a shell-and-tube heat transfer unit design must change to conform to a length or height restriction of an installation area, it will typically be more expensive to make the unit.

A shell-and-tube heat exchanger is more cost-effective to manufacture when designed with a long, small diameter shell, but the tube bundle typically must be removed for repair. Therefore, to accommodate removal of the bundle, the overall space for installation requirements is double the length of the shell. A shell-and-tube unit can also be shortened with multiple passes or bends but this design type is difficult to clean.

The end user must take into consideration all variables of the heat transfer design for installation.

### 5.6.3 Air in a Steam System

#### *Air or non-condensable entrainment*

The existence of air in a steam system has several detrimental effects on heat transfer. The following is a discussion of where the air comes from and how it affects heat transfer efficiency.

When steam is turned off, the vacuum formed by the condensing steam draws air into the system. When the system is re-energized with steam, the spaces fill with a steam/air mixture. The air will eventually be removed through steam traps and properly located air vents in the system. However, systems without proper venting will experience problems from the continued existence of air mixed with steam. Air is also introduced into the system when it's in operation. All steam systems require some amount of make-up water. This water contains mineral impurities that release air (gases) when the water is boiled to produce steam. These gases mix with the steam and exit the boiler into the piping system and heat exchangers. Air in the system can form thin films on heat transfer surfaces. Air is a very efficient insulator (thermal conductivity 0.2). A film of air of only 1/1000-inch thick has the same effect as a thickness of 13 inches of copper or 3 inches of cast iron. This dramatically reduces the heat flux of the heat transfer surface.

In addition to its insulating qualities, air also reduces transfer rate by lowering the temperature of the steam. The saturation temperature of steam is reduced when mixed with air in accordance with the law of partial pressures. Air contributes to the pressure of the mixture but does not contribute to the heat content. In a mixture of 80% steam and 20% air at a pressure of 100 psig, the saturation temperature is that of 80 psig steam and not of 100 psig. Just a small amount of air in the steam will reduce the saturated temperature several degrees. This reduction in temperature reduces the heat transfer rate by lowering the temperature differential.

#### *Air or non-condensable removal*

Steam equipment is fitted with vacuum breakers to prevent vacuums in the line from forming when steam is shut off. When steam collapses, it creates a vacuum that then draws condensate back into the heat transfer equipment. If allowed to cool, condensate can lead to carbonic acid corrosion. All heat transfers components, whether shell-and-tube, plate-and-frame, or other configuration, require vacuum breakers. When the vacuum breaker opens air is drawn into the system. Therefore, in addition to a vacuum breaker, it is again recommended that all heat transfer devices have an air vent. Both air vents and vacuum breakers are installed at points designated by the heat transfer manufacturer. The normal locations are close to the steam inlet or on the top portion of the heat transfer unit. This is the area where the steam condenses very rapidly. Air vents on heat transfer equipment and lines is an automatic device for venting air; it could be a modified steam trap to do this job.

*Best Practices—Remove Air from the Steam System*

- All heat transfer units require air-venting mechanisms.
- All heat transfer units require vacuum breakers. (Check valves that have been installed backwards do not suffice as vacuum breakers.)

#### **5.6.4 Steam Valve Selection**

Valves are classified for leak rates. In steam applications, Class 4 shut off or higher is the standard. This leak rate classification is from the American National Standard Institute (ANSI).

**Types of valves:**

- Check valve (prevents back flow)
- Gate (on/off services)
- Globe (modulating steam)
- Ball (on/off)
- Butterfly (on/off, limited by temperature and pressure)
- Test valves
  - Test valves are installed for a variety of reasons. They are typically installed to check flow, manually measure flow, identify performance, and for line sampling.
- Warm-Up valve
  - When installing an isolation or shut-off valve on the steam supply system (3 inches or larger) it is necessary to install a small valve around the isolation valve. At start-up, the smaller valve is opened first to allow the system to warm gradually, thus preventing any water hammer or thermal shock.

**Turndown requirements**

- 20 to 1—Regulator
- 30 to 1—Globe valve
- 40 to 1—Cage control valve

## 6. Chillers

### 6.1 Explanation of Use

Refrigeration systems in the chemical industry range in capacity from one ton to thousands of tons. Typically, most of these are specially engineered, one-of-a-kind systems; equipment used in normal commercial applications may be unacceptable for chemical plant service. (2002 ASHRAE Refrigeration Handbook). Two types of systems are commonly found in this industry, mechanical and absorption. Recently, absorption equipment has seen little use in chemical plants, even in settings where waste process heat may be available to operate it because of the proximity of the heat source to the refrigeration requirements (2002 ASHRAE Refrigeration Handbook).

Chillers are typical refrigerant equipment that uses heat transfer between two different fluids to achieve desired temperatures. Chillers are air-cooled or water-cooled, depending on the capacity of the refrigeration system as well as the operating conditions of the system. The three primary components of a chiller are condensers, compressors, and evaporators (see Figure 6.1).

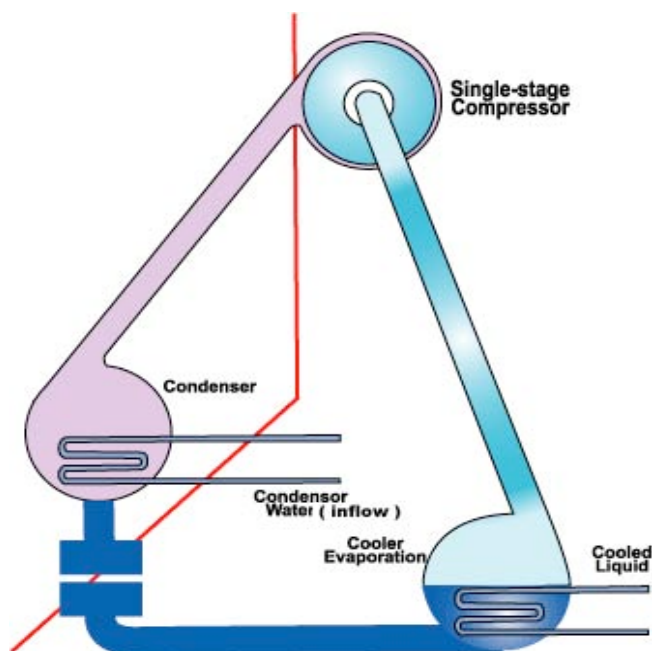

**Figure 6.1** Centrifugal Single-Stage Compressors Diagram<sup>35</sup>

Typical chiller operation follows this general cycle:

1. Refrigerant flows over evaporator tube bundle and evaporates, removing heat energy from the fluid.

<sup>35</sup> Illustration recreated for the web sit for FEMP O&M Best Practices website by Technologist Inc. using graphics supplied by The boiler Efficiency Institute, Auburn, Alabama to PNL, for use on FEMP O&M website as a model at [http://www.eere.energy.gov/femp/operations\\_maintenance/technologies/chillers/types.cfm](http://www.eere.energy.gov/femp/operations_maintenance/technologies/chillers/types.cfm)

2. The refrigerant vapor is drawn out of the evaporator by a compressor that “pumps” the vapor to the condenser.
3. The refrigerant condenses on the condenser cooling coils giving its heat energy to the cooling fluid; the condensed refrigerant heads back to the evaporator.

## 6.2 Chiller Best Practices

### 6.2.1 Maintain an Accurate Log of System Operations

Proper maintenance procedures and accurate operating logs are important tools in any approach to improving chiller and cooling system efficiency. Proper maintenance ensures that a system operates as designed. To monitor and/or improve efficiency, you first must have accurate records of operating conditions. A daily operating log is the best method of tracking performance and detecting any changes. Without this information, system deficiencies cannot be readily detected. Maintenance needs may go unnoticed, increasing operating costs and risking major damage. Without accurate logs, it will be difficult to execute energy-saving strategies.

#### *Best Practice—System Logs*

- Maintain an accurate log of the primary indications of system operations. This should include condenser and evaporator entering and leaving temperatures, chiller load, various pressures (oil, refrigerant, etc) depending on chiller type, equipment in operation, motor voltage and amperage, weather conditions, and any other important factors.

### 6.2.2 Demand Limiters and Staggered Start

Most electric utilities base their demand charges on the amount of energy used during any 15- or 30-minute interval. This may be monthly or, in some instances, the demand rate may be set annually. Peak demand occurs during chiller startup; the most severe demand usually occurs on a hot summer morning when chillers are started and the system water is warm.

#### *Best Practice—Use of Demand Limiters and Staggered Start*

- The use of demand limiting can save significantly energy cost on utility bills in the category of demand charges. Most centrifugal chillers have either manual or automatic demand limiters. The use of these limiters can reduce the demand in any one period. When starting multiple chillers, stagger the starts at least by one demand period. Start the second chiller after the first has loaded.

### 6.2.3 Chill Water Reset

Many chiller and tower systems are designed for peak conditions that are experienced only a few days per year. At reduced loads, the cooling coils can produce the required cooling at higher chilled water temperatures because there is less need for dehumidification. Raising the chilled water temperature lowers the compressor head, resulting in decreased energy consumption. For centrifugal chillers at constant speed (not VSD equipped chillers), this strategy saves 0.5% to 0.75% per degree of reset. The efficiency of a constant-speed chiller, operating below 40% load, may lose efficiency by increasing the leaving chilled water temperature.

Centrifugal chillers equipped with variable-speed drives and operating at loads of 80% down to 10% will consume 2% to 3% less energy per degree of chilled water reset.



*Best Practice—Chill Water Reset*

- Reset the chill water temperature to the maximum that is required to meet the load on the system. This is best accomplished with automated controls and programming to reset on a dynamic basis.

**6.2.4 Monitor for Refrigerant and Air Leaks**

Any leaks in the closed-loop refrigerant system should be eliminated. In high-pressure chillers, refrigerant will leak out, reducing refrigerant charge, and air will leak into low-pressure chillers. In low-pressure refrigerant chillers, air collects in the condenser and displaces refrigerant vapor, resulting in higher condenser pressure and temperature. For every 1°F increase in condenser leaving temperature, energy consumption increases about 1.5%. Most low-pressure chillers use a purge unit to remove air. To reduce air problems, ensure the purge unit is functioning properly.

*Best Practice—Monitor for Refrigerant and Air Leaks*

- Periodically check low-pressure systems for excess air and high-pressure systems for proper refrigerant levels. Maintain a log of the results.

**6.2.5 Monitor Refrigerant Levels**

Incorrect levels of refrigerant limit a chiller's capacity, increasing head pressure and energy consumption. Incorrect levels also can decrease the evaporator temperature. For every 1°F that the evaporator temperature can be raised, 1.5% of the full-load energy can be saved.

*Best Practice—Refrigerant Level Monitoring*

- For centrifugal chillers, monitor and log the sight glass levels in the evaporator shell. Check for bubbles in the liquid line sight glass on reciprocating units, which indicate low level and high discharge pressure or low refrigerant temperature leaving the condenser for high levels. Maintain the level according to the manufacturer's instructions.

**6.2.6 Use Optimum Condenser Temperature**

Chiller manufacturers specify a minimum temperature for condenser water flowing into each chiller. Check with the manufacturer for recommended minimums for your model. Energy consumption is a function of the condenser pressure and temperature. Lowering the condenser water temperature reduces the refrigerant condensing temperature and condensing pressure. This reduces the lift required by the compressor and results in lower head pressure and reduced compressor energy consumption. Energy savings, at full-load, will be 1.5% per degree of reduction in entering condenser water temperature.

*Best Practice—Condenser (cooling tower) Temperature*

- Maintain the lowest condenser temperature recommended by the chiller manufacturer. Tower fans may consume some of the increased energy, but savings from the much larger compressor will offset it.

**6.2.7 Maintain Optimum Cooling Tower Discharge Temperature**

Condenser water temperature should be monitored at the cooling tower and at the condenser inlet to ensure that the lowest possible temperature is being maintained. If the entering condenser

water temperature is more than 1-2°F higher than the temperature at the cooling tower, identify the cause and take corrective action. Many systems have a cooling tower bypass valve to mix warm return water with the water to the condenser for startup or cold weather operation. Check this valve for proper operation and adjustment. Pipe insulation may be warranted.

*Best Practice—Maintain Cooling Tower Discharge Temperature*

- Ensure that neither mechanical nor insulation issues are responsible for any temperature increases between the cooling tower and the chiller.

### **6.2.8 Maintain Chiller Condenser Tubes**

Fouling of the condenser tubes (e.g., scale formation, sedimentation, slime, and algae growth) results from poor water treatment and/or poor maintenance of the system's waterside. Fouling is an insulator that impedes transfer between the refrigerant and the water. It increases both the condensing temperature and the head pressure. Increasing head pressure increases compressor energy use. Fouling can increase the temperature difference needed between the leaving condenser water temperature and the refrigerant condensing temperature to maintain the same cooling load. Each increase in temperature of 1°F increases the full load energy consumed by 1%.

*Best Practice—Maintain Chiller Condenser Tubes in a Clean Condition*

- The first line of defense is to follow good water treatment practices. This includes taking steps to control biocides, algae, and suspended solids. Filtration will assist in suspended solids control. Brush or high-pressure water cleaning of condenser tubes should be done annually at a minimum.

### **6.2.9 Maintain Optimum Condenser Water Flow Rate**

Low water flow in the condenser increases head pressure and therefore energy consumption. A 20% reduction in the condenser flow rate will increase full-load energy consumption by 3%. Common causes of reduced flow are partially closed or damaged valves, clogged hot-deck nozzles in the cooling tower, clogged line strainers, sediment in the condenser tubes, and air in the system piping.

*Best Practice—Condenser Water Flow*

- Verify the condenser water flow by measuring it at least annually. A clamp-on or insertion flow meter can achieve this, if permanent measurement tools are not installed.

### **6.2.10 Monitor Motor Cooling**

Chiller motor maintenance is a major area that is often neglected. The compressor motor is the largest energy consumer in the chiller system. Motor cooling is the most common cause of declining motor efficiency. If an increase in current draw is noted without a decrease in voltage, the motor may have a cooling problem brought on by blocked refrigerant lines in hermetic chillers, dirt-clogged air passages, or blocked air filters. Poor chiller room ventilation may also contribute to the cooling issue.

*Best Practice—Motor Cooling*

- When reviewing chiller logs, pay particular attention to the motor amperage vs. voltage to detect increases in amp draw. Check the motor for cooling problems. This should be a part of all annual chiller reviews.

**6.2.11 Optimize Chiller Sequencing**

Employing a chiller sequence can have a major impact on overall energy efficiency of the chiller plant. Usually, a centrifugal chiller is more efficient at full or nearly full load, while rotary screw chillers usually have the best efficiency at partial load. Reciprocating chillers vary and the exact unit specifications should be verified. When operating multiple chillers, always load the one that has the best efficiency for the current cooling demand before loading the other chillers, which use more energy. When starting a second or subsequent chiller, consider the characteristics of the other chillers. Operate the centrifugal chillers at full load and swing with the screw chiller if available. The use of variable speed drive chillers provides the ultimate in chiller employment efficiency.

*Best Practice—Chiller Employment*

- Always consider efficiency vs. load when starting and stopping chillers. Various chiller designs have different partial load and full load efficiencies. Also, consider the efficiency of the chillers on line as a group. Choose the best combination for the best energy efficiency.

**6.2.12 Chiller Water Flow Isolation**

Effective management of water flow to the chiller is a source of potential energy savings. Start and stop chill water and condenser pumps when the associated chiller is operated. Isolate inactive chillers from the chill water and condenser water loops when they are not in operation. Water pumped through idle chillers consumes unnecessary energy by adding temperature to the water. This can be as much as 2-2.5°F. The use of automatic shut-off valves is recommended.

*Best Practice—Chiller Water Flow Isolation*

- Isolate both the chiller evaporator and condenser from the system when the chiller is not in service. Automatic valves are the ideal solution.

**6.2.13 Variable Speed Drive Chillers**

The use of chillers equipped with variable speed drives greatly enhances their energy efficiency. This enables the chiller to match the speed of the compressor to the load at the maximum efficiency. It also allows the chiller to function, without damage, at much lower condenser water temperatures. This further reduces operating costs.

*Best Practice—Variable Speed Drive Chillers*

- The availability of variable speed chillers has improved in recent years, thus reducing initial purchase costs. The use of drives allows the chiller to exactly match the compressor speed to the load and provides the ultimate in employment matching. When using multiple chillers, employment can be controlled to use the VSD-equipped chiller as the swing chiller and maximize the benefit if only one chiller is equipped with a VSD.

### 6.2.14 Automate Chiller System

The use of automation for chiller employment and control can significantly reduce energy consumption. An automation system can provide 24-hour electronic monitoring and control of chiller plant operation, and can report information to a control center or cell phone. This type of system can report operational problems and even dispatch a service call. It can detect and report problems earlier and prevent equipment damage. Control functions include employment (on-off), demand limiting, chill water reset, pump employment, and water flow control. Additional duties can be monitoring of maintenance items, filters, oil changes and out of range conditions. Automated systems can also pickup many of the logging duties for operators. A control system does not replace a good operator and/or the normal inspections required for sound operating practices.

#### *Best Practice—Chiller Plant Automation, Reporting, and Control*

- The use of a well-designed automation package can greatly reduce the energy consumption of a chiller plant and provide an improved level of monitoring and reliability.

### 6.2.15 Automatic Tube Cleaning Systems

Automatic tube cleaning systems consisting of captured brushes in each tube and a flow-reversing valve with controls are excellent energy savers in cases where chiller or condenser fouling is a problem. The system typically cleans the tubes four times per day. Common applications are river water condensers, process evaporators, and condensers on towers or systems where fouling is critical. Energy savings commonly range from 15-20% on condensers and 15%-plus on process evaporators. Additional savings from reduced maintenance and less downtime are possible.

#### *Best Practice—Automatic Tube Cleaning Systems*

- On evaporators and condensers in high fouling applications, automatic tube cleaning systems can save significant energy by maintaining tube heat transfers surfaces in clean condition.

### 6.2.16 Free-Cooling With a Plate Heat Exchanger

Free-cooling (systems above 36°F) for systems that are not equipped to use outside air can be done by utilizing a plate-heat exchanger and a cooling tower. The tower must be setup for cold operation and have sufficient heater capacity to prevent freezing in cases of low load and severely cold weather. The effectiveness of free-cooling depends on the chill water temperature required in winter months and the hours of wet bulb temperatures for the location. The plate-heat exchanger is used like a chiller but the heat exchanger does not require additional power input.

#### *Best Practice—Free Cooling on the Waterside*

- A careful analysis of free-cooling opportunities is required when winter cooling is needed and outside air is not available (or cannot be used for other reasons). Attention should be paid to the required chill water temperature in cold weather, as typically the chill water temperature can be higher than in the summer months. This is usually due to lower loads in the winter. The warmer the chill water temperature required, the longer free-cooling

can be used. Free-cooling applications have been used successfully in the southeastern U.S. for many years. Depending on the application and installation, paybacks of less than one year have been achieved. Automation of the controls for change over is recommended, as it will greatly increase the number of hours of use.

### **6.2.17 Free Cooling With Fin-Fan Coils**

Free-cooling (systems below 36°F) can be achieved with fin-fan coils. This is usually applied on systems that are operating below freezing and are using a brine solution (glycol/water, etc.) The brine is circulated to a fin-fan coil outside and cooled by cold air that's forced over a coil.

#### *Best Practice—Free Cooling for Low Temperatures*

- The use of a fin-fan coil to cool brine solutions to temperatures below 36°F is a source of winter energy savings. The outside coil acts as the chiller and only requires a small amount of energy for the fan(s).

## **6.3 Cooling Tower Best Practices**

Cooling towers are heat rejection devices that divert waste process heat into the atmosphere. They are commonly used in air-conditioning, manufacturing, and electric power generation. Cooling towers may be direct (open circuit) or indirect (closed circuit), depending on the specific application. Direct-cooling towers require the cooling fluid to have direct contact with air; in indirect-cooling towers air and cooling fluid are separated.

### **6.3.1 Cooling Tower Water Filtration**

Cooling tower water filtration is the single most effective way to reduce fouling and maintenance on a cooling water system. The dirt particles typically found in cooling water consist of airborne dust, pollen, dirt, bacteria, and other organic material ingested by the tower. The typical cooling tower moves millions of cubic feet of air each day. All of the foreign material in air is washed out into the cooling water. This material provides food for the bacteria normally present in cooling tower water. It also forms a sludge blanket in the basin or tower sump, which harbors bacteria and corrosion-causing conditions. If a sludge blanket becomes an inch or more thick, biocides can no longer penetrate it to kill bacteria.

#### *Best Practice—Cooling Tower Water Filtration*

- The use of side-stream sand filters is the most effective way to remove the suspended solids in cooling tower water. Filters designed for this purpose can remove 90-95% of all suspended solids larger than 5 microns. This level of filtration, which is equal to or better than drinking water, will eliminate the problems associated with dirty cooling tower water. Selection and sizing is site-, equipment-, and location-dependant. Because the solids are small and airborne (making them low in specific gravity), centrifugal separators are not effective for this application.
- A filtration system should include a properly designed basin sweeper system to reduce or eliminate the sludge blanket that forms in tower basins.

### **6.3.2 Cooling Tower Hot Deck Covers**

Cooling tower hot decks provide another defense against airborne solids and algae growth. Hot

decks are a common method of water distribution in most cooling towers (some towers use pressure nozzle system). Algae cannot grow in cooling water without sunlight. The most common source of sunlight in cooling towers is uncovered hot decks.

*Best Practice—Hot Deck Covers*

- On cooling towers with hot decks, install and maintain hot deck covers. Ensure that procedures require the replacement of the covers following maintenance activities.

### **6.3.3 Monitor Hot Deck Nozzles**

To ensure efficient operation of a cooling tower, the tower must have the appropriate flow of water and air in the fill at all times. The most common disruption to adequate water flow is hot deck nozzle plugging (in towers with hot decks). This causes unbalanced and uneven water flow through the fill affecting the tower performance. This nozzle plugging is usually large pipe scale pieces and other debris in the system that cannot pass through deck nozzles. Regular monitoring of hot deck conditions is recommended.

*Best Practice—Hot Deck Nozzles*

- Hot deck nozzles should be inspected on a monthly basis in normal operating conditions. Where frequent problems are encountered with nozzle plugging, install a line strainer on the return line to the tower. The perforations in the strainer should be one-half the size of the smallest opening in the hot deck nozzle. Install a 2-inch ball valve in a convenient location for blow down of the strainer, and check it frequently.

### **6.3.4 Cooling Tower Basins**

Cooling tower basins usually collect a large amount of dirt and sludge from the solids washed out of the airflow. These solids create a sludge blanket on the bottom of the tower basin. When sludge thickness reaches 1-inch, the biocide and corrosion inhibitor used as cooling water treatment cannot reach the basin bottom. If the basin is galvanized steel, rapid corrosion can cause severe damage in a short time. The most common form is anaerobic bacterial corrosion. This is caused from the growth of bacteria, which thrives in an atmosphere with no oxygen. The first-line defense for this occurrence is the use of stainless steel basins and filtration with a basin sweeper system.

*Best Practice—Cooling Tower Basins*

- Order new cooling towers with stainless steel basin for longer life and reduced maintenance costs. Use epoxy or elastomeric coatings to extend the life of galvanized cooling tower basins. See also “Cooling tower water filtration.”

### **6.3.5 Cooling Tower Selection**

The design of the cooling tower has an impact on energy efficiency. The most efficient design is the induced draft, counter-flow design. For most applications, this is also the most cost-effective tower design if lifecycle costing is used. It may not be the lowest first-cost unit. In some instances, there may be site restrictions or conditions that would affect this choice.

#### *Best Practice—Cooling Tower Type Selection*

- The most efficient tower type, for most conditions, is the induced draft, counter-flow design. Consider operating efficiency and lifecycle costs when selecting a cooling tower design.

### **6.3.6 Shutdown Vibration Switches**

Most cooling towers use fans to push or pull air through the fill, and cool the water by evaporation. Fan blades are subject to fatigue, other mechanical stresses, and manufacturing defects. When a fan blade loses a blade tip or experiences abnormal wear, it becomes unbalanced. This causes excessive vibration in the gearbox, mounting, and other structures.

#### *Best Practice—Vibration Switches*

- All cooling tower fans should be equipped with a shutdown vibration switch. In the event of an unbalanced situation, the fan will shut down before causing additional blade failure and the possibility of a safety hazard. Care should be taken to install the vibration switch in the correct plane for cooling towers. Switches installed in the wrong plane will not function. Switches should be checked on an annual basis for correct operation.

### **6.3.7 Upgrading Cooling Tower Capacity**

Cooling tower performance may require improvement if loads have increased over time. There are a number of options to improve the capacity of an existing cooling tower. These include fill upgrades, fan blade adjustment, fan and motor replacement, etc.

#### *Best Practice—Cooling Tower Upgrades*

- Consult a knowledgeable company to evaluate the improvements available to enhance the capacity of an existing cooling tower.

### **6.3.8 Drift Elimination**

Water lost through the cooling tower fan is called drift. This water, when excessive, reduces the overall efficiency to the cooling tower. Water use rises, chemical costs increase, and environmental damage can occur from the water droplets.

#### *Best Practice—Drift Control*

- Maintain drift eliminators in good condition. If drift is a problem, consider replacing the drift eliminators. Drift eliminators affect the tower performance by increasing the pressure drop and, therefore, the airflow across the tower. There is a trade-off between energy, performance, and drift control. Use the type of drift eliminator that meets the requirements, not necessarily the best one available.

### **6.3.9 Drain Basin Tanks**

Drain-back tanks are useful in cold climates where tower freezing is an issue. The use of polyethylene tanks to hold the sump water is an effective method of eliminating the basin heaters and heater controls. Locate the tank in an area that is heated.

*Best Practice—Winter Tower Freeze Control*

- The use of a drain-back tank is a cost-effective way to avoid tower freezing and the cost of heaters, controls, and heater operation. Space must be available in a heated area at an elevation lower than the base of the tower.

**6.3.10 Cooling Tower Cleaning**

Cooling towers should be cleaned at least annually. New standards from the Cooling Tower Institute suggest that more frequent cleaning may be warranted. Cleaning schedules will vary depending on the tower load, location, the use of filtration, and other environmental conditions.

*Best Practice—Cooling Tower Cleaning*

- The cleaning of cooling towers should be done often enough to prevent any significant buildup of dirt in the tower and tower fill.

**6.4 Heat Exchanger Best Practices****6.4.1 Heat Exchanger Selection**

Heat exchanger selection is an increasingly difficult task. Many types of heat exchangers are available and each type is outstanding for select applications. For liquid-to-liquid applications where solids are not a problem, plate heat exchangers excel. When cleaning or solids are an issue, spiral plate heat exchangers are an excellent choice. Applications with a large approach are suited for tube-and-shell heat exchangers.

*Best Practice—Heat Exchangers*

- The various types of heat exchangers should be considered before purchasing a unit. For most HVAC applications, plate-and-frame units or tube-and-shell units are the most common. A variation on the plate-and-frame heat exchanger, the brazed plate heat exchanger, is an excellent unit for small heating, cooling, and condensing applications.

**6.4.1 Back Flushing System**

Heat exchangers that are subject to frequent fouling can benefit from back flushing. The use of a four-way valve to periodically reverse flow to dislodge fouling and sediment allows cleaning on-line. This can be applied to most heat exchangers. On some tube-and-shell type heat exchangers, catch baskets and brushes can be installed to brush the tubes when the flow reverses.

*Best Practice—On-line Heat Exchanger Cleaning*

- When using dirty or fouling-type liquids in heat exchangers, consider using back flushing for on-line cleaning. In certain tube-and-shell units, captured brushes can be used.

**6.4.1 Fluid Selection**

The use various additives to prevent freezing of fluids affect the heat transfer capabilities of the solution. Ethylene and propylene glycol are the most commonly used fluids. As the temperature of operation decreases, greater amounts of glycol are required. As this percentage increases, the heat transfer abilities decline and flow must be increased.



### Freezing Point

Concentration by volume	Ethylene Glycol	Propylene Glycol
55%	-50F	-40F
50%	-37F	-28F
40%	-14F	-13F
30%	+2F	+4F
20%	+15F	+17F

### Glycol Properties

	Ethylene Glycol	Propylene Glycol
<b>Heat transfer @180F with no increase in flow rate</b>		
20% solution	.96	.97
50% solution	.87	.90
<b>Flow Rate Correction Required (with no change in pump curve)</b>		
100F	116%	
140F	115%	
180F	114%	110%
<b>Pump Head Correction Required (with increase in flow)</b>		
100F	149%	
140F	132%	
180F	123%	123%
Specific Gravity @ STP	1.125 -1.135	1.045 -1.055
Pounds/Gallon @ 60	9.42	8.77
pH (of glycol concentrate)	9.3	9.5
Note: Except as indicated, comparisons are of 50% glycol solution to water.		

#### *Best Practice—Glycol Additions for Antifreeze*

- Use the least amount of glycol possible to prevent freezing, to maximize heat transfer and minimize the flow required for the application.

## **7. Pumps and Motors**

The focus of this publication is to identify best practices in energy efficiency for the chemical industry. While there are some standard approaches that are almost universally beneficial in pumping systems, it is vital to emphasize from the outset that rules of thumb provided in this document should not be used solely to determine the implementation of best practices; rather they should help identify best practices that have potential energy savings. Resources shall be provided with these rules of thumb to offer more in-depth information and suggestions on proceeding with the implementation of a best practice.

### **7.1 Explanation of Use**

Pumping systems are the single largest type of industrial end-user of motor-driven electricity in the United States, accounting for 25% of industrial motor energy usage.<sup>36</sup> Also, pumping systems account for nearly 20% of the world's demand for electric energy.<sup>37</sup> While pumps typically operate to serve various chemical process support equipments such as chillers, cooling towers, material transfer, etc., pumping is considered an individual process separate from the processes of the aforementioned equipment.

A pump is a device used to raise, compress, or transfer fluids. The motors that power most pumps can be the focus of many best practices. It is common to model the operation of pumps via pump and system curves. Pump curves offer the horsepower, head, and flow rate figures for a specific pump at a constant rpm. System curves describe the capacity and head required by a pump system. An example of both of these curves may be seen in Figure 7.1.

---

<sup>36</sup> United States Industrial Motor Systems Market Opportunities Assessment, report by Xenergy for Oak Ridge National Laboratory and the U.S. Department of Energy, 1998, available for free download at <http://www.oit.doe.gov/bestpractices/pdfs/mtrmkt.pdf>

<sup>37</sup> Pump Lifecycle Costs: A Guide to LCC Analysis for Pumping Systems, Europump and Hydraulic Institute, 2001. An executive summary can be downloaded free from the U.S. Department of Energy at: [http://www.oit.doe.gov/bestpractices/pdfs/pumplec\\_1001.pdf](http://www.oit.doe.gov/bestpractices/pdfs/pumplec_1001.pdf)

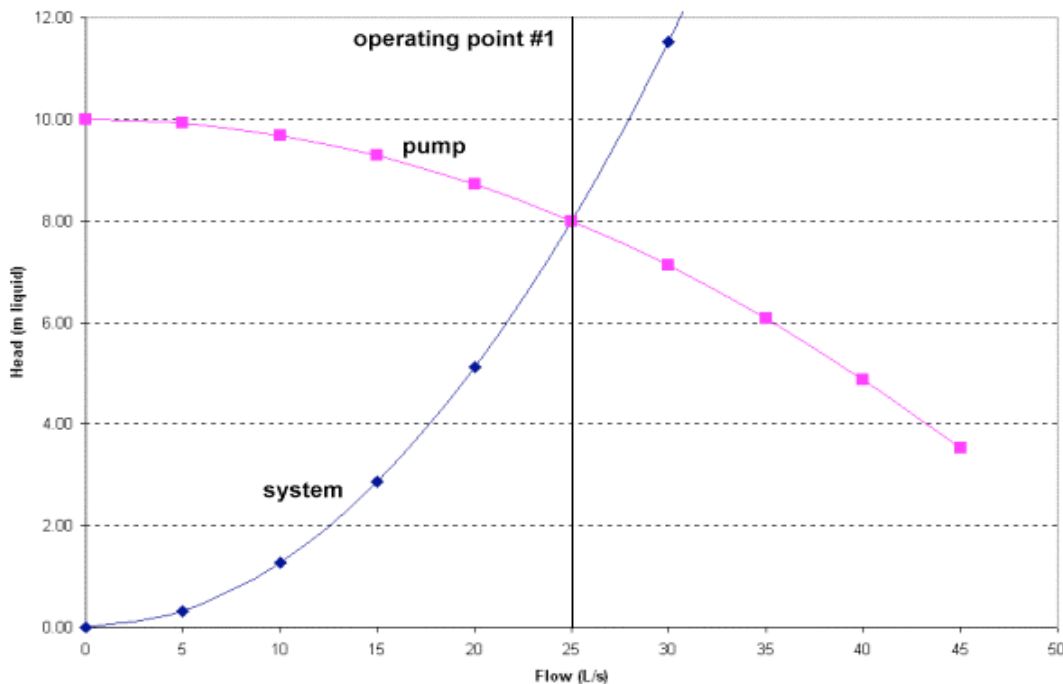

Figure 7.1 [www.cheresources.com/vpumpzz.shtml](http://www.cheresources.com/vpumpzz.shtml) (example of pump and system curve, there may be better graphics available)

Pump operation may be modeled by a system of affinity laws that show a relationship between rpm, flow rate, and power. Understanding these basic relationships, shown below, is very important in considering the performance of a pumping system.

$$\frac{Q_1}{Q_2} = \frac{N_1}{N_2} \quad Q = \text{Flowrate}$$

$$\frac{H_1}{H_2} = \left(\frac{N_1}{N_2}\right)^2 \quad H = \text{Head}$$

$$\frac{P_1}{P_2} = \left(\frac{N_1}{N_2}\right)^3 \quad P = \text{Power}$$

### 7.1.1 Pump Types

Various types of pumps are used in the chemical industry, including centrifugal, reciprocating, and helical rotor pumps.

Centrifugal pumps operate by applying a centrifugal force to fluids, many times with the assistance of impellers. These pumps are typically used in moderate to high flow applications with low-pressure head, and are very common in chemical process industries. There are three types of centrifugal pumps—radial, mixed, and axial flow pumps. In the radial pumps, pressure is developed completely through a centrifugal force, while in axial pumps pressure is developed by lift generated by the impeller. Mixed flow pumps develop flow through a centrifugal force and the impeller.

Reciprocating pumps compress liquid in small chambers via pistons or diaphragms. These pumps are typically used in low-flow and high-head applications. Piston pumps may have single or multiple stages and are generally not suitable for transferring toxic or explosive material. Diaphragm pumps are more commonly used for toxic or explosive materials.

Helical rotor pumps use a rotor within a helical cavity to develop pressure. These pumps are useful for submersible and waste applications.

### **7.1.2 A Pump Lifecycle Analysis**

Energy usage is a critical factor in determining the lifecycle costs of pumps and their motors. As an illustration of how significant the energy cost can be, Figure 7.2 shows the 10-year lifecycle distribution of costs for a 250-hp motor driven pump used in a relatively benign service (e.g., clean water) and operated about 80% of the time: Energy accounts for over 85% of the ownership cost for the pump and motor. But even if the equipment is operated only half of the time and is exposed to a more severe service (therefore increased purchase and maintenance costs), energy is still the dominant lifecycle element, as shown in Figure 7.3. Assumptions used in developing the Fig. 7.2 and 7.3 pie charts are listed below the figures.

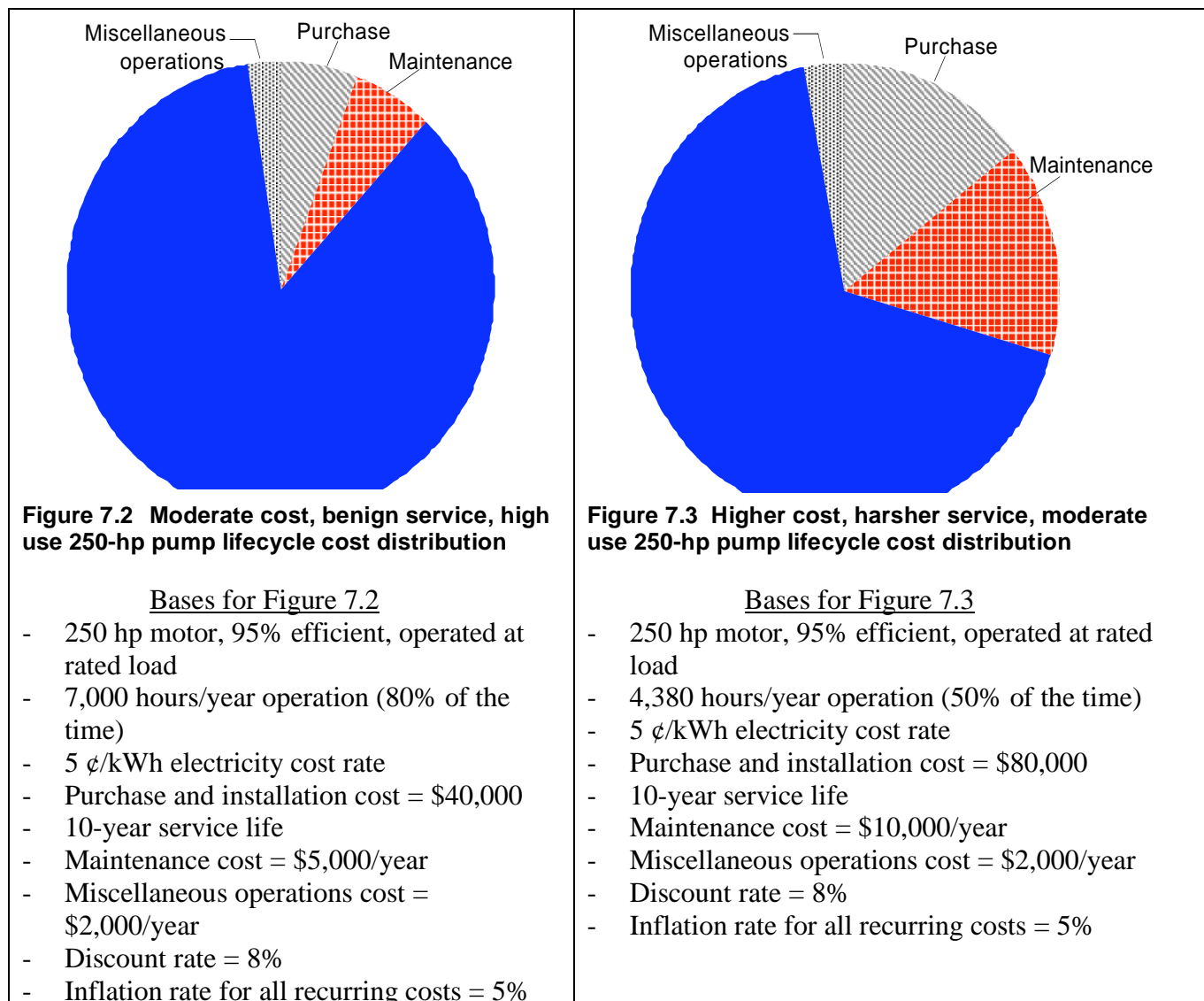

**Figure 7.2 and 7.3**

It might be noted that the energy costs of the *first year of operation* for the Figure 7.2 data would be over \$68,000, or 170% of the purchase and installation cost.

Europump and the Hydraulic Institute, two industry trade associations, collaborated to produce a lifecycle cost (LCC) analysis document that provides some detailed discussion on both technical and economic factors involved in doing a lifecycle cost analysis.<sup>38</sup> The executive summary of the LCC document can be downloaded from either the U.S. Department of Energy or the Hydraulic Institute at no cost.<sup>39</sup>

<sup>38</sup> Pump Lifecycle Costs: A Guide to LCC Analysis for Pumping Systems, Europump and Hydraulic Institute, 2001. An executive summary can be downloaded free from the U.S. Department of Energy at: [http://www.oit.doe.gov/bestpractices/pdfs/pumplcc\\_1001.pdf](http://www.oit.doe.gov/bestpractices/pdfs/pumplcc_1001.pdf)

<sup>39</sup> The full document can be purchased from Hydraulic Institute at [www.pumps.org](http://www.pumps.org); an executive summary (and other useful documents) can be requested free of charge from Hydraulic Institute at [http://www.pumps.org/public/pump\\_resources/energy/index.html](http://www.pumps.org/public/pump_resources/energy/index.html).

## 7.2 Control Strategy Best Practices

There is no single control strategy that is optimal for all pumping systems. In one case, on/off control is clearly preferred while in another, pump speed control is the obvious choice.

However, there are many systems for which the choice is not so clear or in which two or more different control schemes would work equally well. And there are some systems that merit a combination of controls, such as multiple parallel pumps with adjustable speed drives for each pump.

Each system must be evaluated on its own terms. The nature of the system curve, the performance characteristics of the installed pumps, the nature of the load variability, and other factors influence the decision process. It is important to note that all of these best practices are likelihoods, not necessarily guarantees.

The following best practices will be discussed in the context of control strategies:

- Understand the fundamental nature of the system head requirements
- Understand the variability of the required flow rate and head
- Systems with essentially constant requirements and/or large storage inventories
- Systems with continuously varying requirements (and lacking stored inventory)
- Systems that operate in two or three principal operating zones
- Minimize the use of throttling valves or bypass operation for flow regulation
- Demand charge minimization

The most commonly selected control strategies for regulation of pumping systems are:

- Control valve throttling
- Bypass (pump recirculation) valve operation
- Multiple parallel pump operation
- On/off control
- Pump speed control
- Combinations of the above
- No control – the pumps just run

### 7.2.1 Understand the Fundamental Nature of System Head Requirements

This is absolutely a critical best practice. Note that it is not an equipment choice or simple rule of thumb. It is recognized that knowledge and understanding are essential to proper equipment selection.

#### **Nature of System Head Requirements: An illustrative example**

Assume that the system designer indicates that 5,000 gpm and 200 feet of head should be the pump design point, and that the flow rate is not expected to remain very constant. That would seem to indicate that a pump that operates at its best efficiency point at 5000 gpm and 200 feet of head would be a straightforward, lowest capital and operating cost choice.

Of course, some might note that even in this simplest of situations, equipment redundancy and potential protection from transients such as water hammer, (sudden changes in fluid velocity which cause catastrophic component failure) are control issues that would need to be considered. The addition of a parallel pump for redundancy, use of a soft starter, application of air release

and/or vacuum breaker, and check valves with carefully selected closing response to address startup and shutdown hydraulic transients might be needed in all of these systems.

But what if the flow requirements are expected to vary between 1,000 and 5,000 gpm, and the 5,000 gpm at 200 feet head is simply the maximum design basis condition? Three different system curves that share one common point—5,000 gpm and 200 feet of head—are shown in Figure 7.4. These three hypothetical systems have static head requirements that range from 0 to 180 feet. But they also have different levels of frictional resistance to fluid flow.

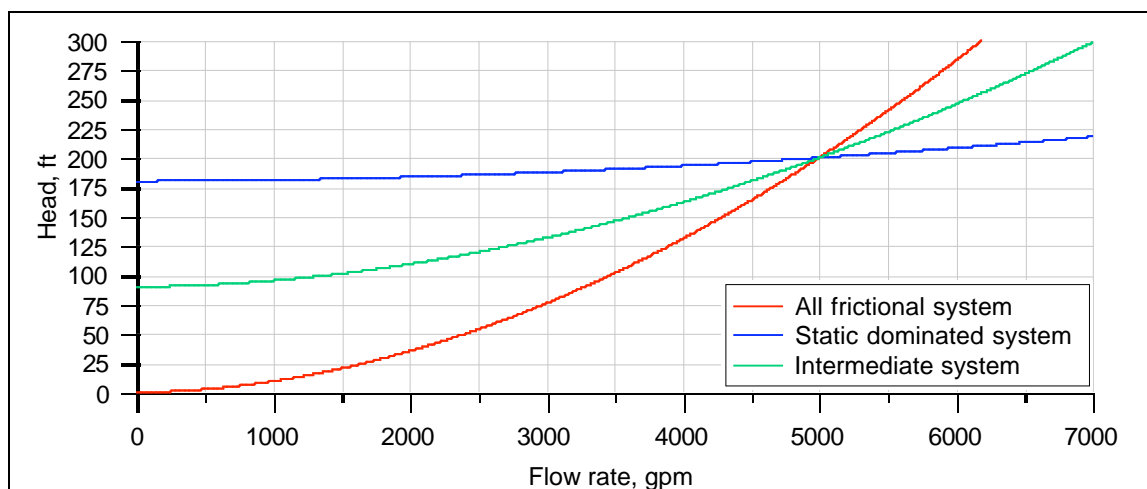

**Figure 7.4 Three different system curves with a single common flow rate/head point (5000 gpm/200 ft)**

While the three systems do share the same head requirement at 5,000 gpm, at 1,000 gpm the required head varies from 9 to 181 feet. This divergence should affect the choice of not only the control system but the pump itself. Some general tendencies will be discussed below, but the point to be made here are that the nature of the static and frictional head distributions absolutely should be considered in selecting a control strategy. It is, therefore, an essential best practice that the control designer must understand the system curve characteristic.

It might also be noted that the transient protection considerations mentioned above would need to factor into the nature of the system, including the static head as well as the general piping distribution—even when the system only operates at a single flow rate. So even in the simplest of control arenas, the nature of the system curve must be considered.

#### *Best Practice—Consider and Apply the Best Control System and Pump*

- Consider the divergence of system curves based on the frictional and static head distributions of the pumping system in order to select/modify pumps and their control systems.
- Adjust the control system to fit the most appropriate system curve.

## 7.2.2 Understand the Variability of the Required Flow Rate and Head

Integrally linked with the fundamental nature of the system curve is the need to understand the variability of the flow and head requirements. This is also a knowledge-and-understanding-based best practice.

### Nature of System Head Requirements: An illustrative example (continued)

For the three systems represented in Figure 3, the control strategy decision would be affected by the head-flow curve shape as well as the variation in flow requirements. The optimal control strategy for a situation where the flow requirements vary between 1,000 and 5,000 gpm in any of the three systems would almost certainly be different than the strategy chosen if the range of variability was between 4,500 and 5,000 gpm (particularly for the static dominated system).

For existing systems, an excellent way of capturing the variability is by monitoring flow rate (and/or head) over time and creating a histogram such as those shown in Figures 7.5 and 7.6 to help clarify the time distribution requirements.

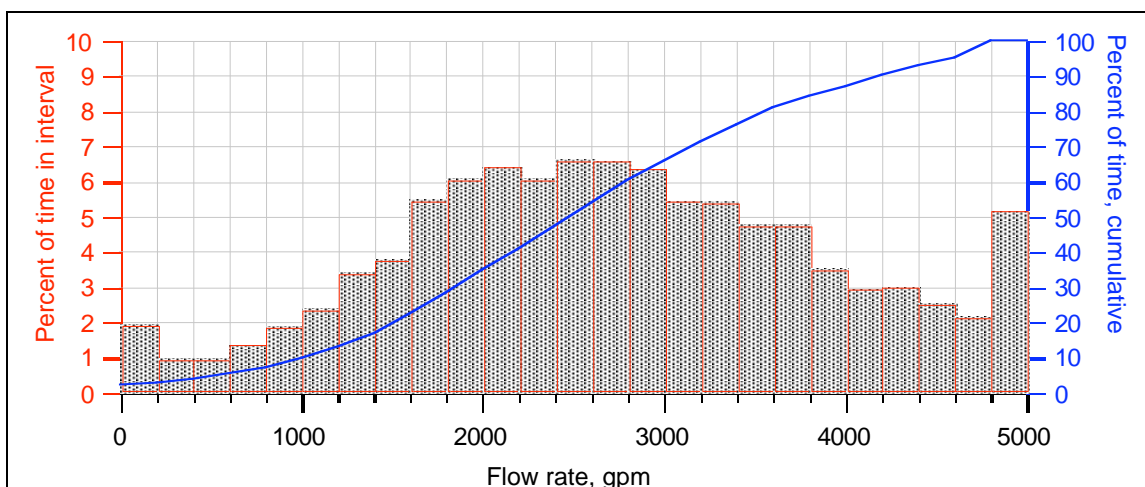

Figure 7.5 Flow histogram for a system with continuously variable flow requirements

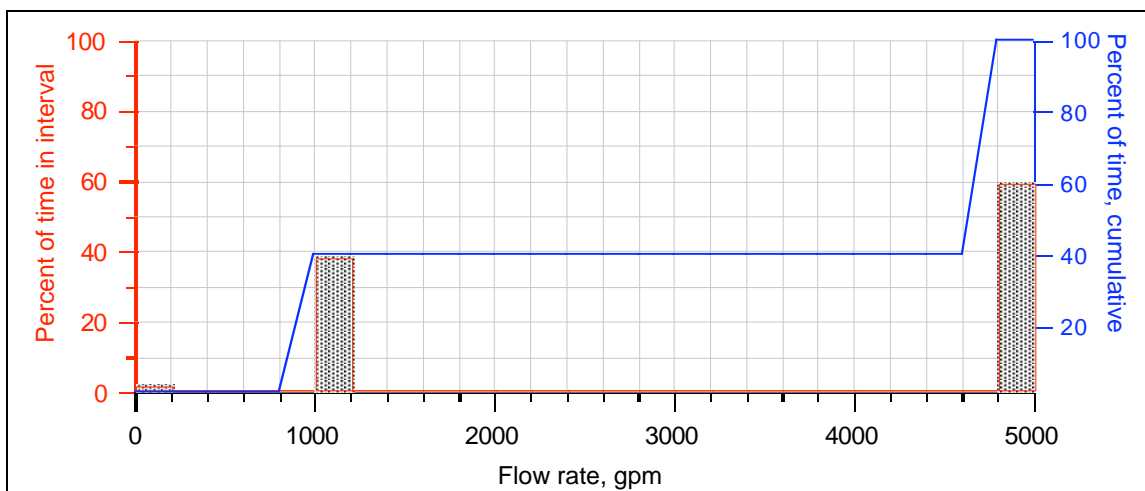

Figure 7.6 Flow histogram for a system with two basic operating regimes



*Best Practice—Monitor System Variability*

- Monitor the flow rate over time to help clarify time distribution requirements.
- Select a flow system that is in concordance with observations of the flow rate.

### **7.2.3 ON/OFF Controls**

Systems in which neither the flow rate nor head need to be regulated (under normal, steady-state conditions) are prime candidates for on/off control. This is a general rule of thumb and does not apply to all systems.

An excellent example of this type of system is the municipal water system, where filtered and treated water is pumped from the clear well of a chemical plant to elevated storage tanks. Although customer demands vary with the time of day and weather conditions, the system storage in most municipal operations provides a sufficient buffer to meet these demand fluctuations. The elevated tanks, of course, also provide a relative constant source of pressure.

Some municipalities do use adjustable speed drives to both regulate flow and minimize the effect of start and stop transients, and some even employ them to minimize demand charges (Section 7.2.7). However, for many applications, a properly selected pump and motor will provide the lowest capital and operating cost for systems with constant requirements and/or large storage capacity.

*Best Practice—Select an ON/OFF Control System for Systems with no Flow Rate or Head Regulations*

- If a study of the variability and regulations of the system (Sections 7.1.1, 7.1.2) shows that flow rate and head do not need regulating, investigate an ON/OFF system, which will likely provide the lowest capital and operating costs.

### **7.2.4 Adjustable Capacity Controls**

Generally speaking, systems that experience continuously variable demand are good candidates for adjustable speed drive consideration. The phrase "continuously variable" is intended to portray a load profile similar to that shown in Figure 7.5, where the flow requirements vary across a broad range.

But it is also important to note that the nature of the system curve becomes very important here. If the Figure 7.5 flow profile was applied to the all-frictional system curve of Figure 7.4, a single adjustable speed driven pump would likely be suitable to the entire flow range (with the possible exception of extremely low flow rates). However, if the Figure 4 flow profile was applied to the static-dominated system curve of Figure 7.4, it is a virtual certainty that an adjustable speed driven pump would not only become inefficient, but also be problematic from a control standpoint as the required flow rate dropped below 1000 gpm or so.

The use of either multiple parallel pumps might well be a preferred alternative in a high static head case, where the optimal set of pumps might not all be the same size. Or it may be that using a combination of parallel pumps with adjustable speed drives would be the preferred choice.

*Best Practices—Adjustable Speed Drive or Multiple Parallel Pump Controls*

- Installing a variable speed drive on the motor will adjust the pump operation to meet a variable demand system.
- In cases with high static head, parallel pumps may be a more effective alternative.

**7.2.5 Multiple Flow Regime (Parallel Pump) Controls**

Systems with varying flow requirements that operate in discrete regimes can generally be well served by a parallel pump operation, where pumps are properly sized and selected for the individual flow regimes. The histogram shown in Figure 5 might be a good candidate for parallel pump control.

It should be noted that the two different flow regimes in Figure 7.6 could have similar or quite different head requirements. If the all-frictional system of Figure 7.1 applied, the head at 1000 gpm would be about 9 feet while the head at 5000 gpm would be 200 feet. Clearly, two entirely different pumps would be needed. It might be noted that an adjustable speed-driven pump would also work reasonably well under this system and load profile type, but the inherent drive losses and the much higher capital cost for a drive for the larger pump would certainly favor the dual pump design configuration.

In the case of the static-dominated system, two options would merit consideration. Two pumps could be chosen to operate solo under the two flow regimes. Or, one pump could be used for the lower flow regime (1000 gpm) and a second pump turned on to run in parallel with the smaller pump to meet the 5000 gpm requirement.

One important note regarding distinct regime operation: In some cases, the intervals for these flow regimes are long and in others, they're short. The parallel pump operation is most readily applied to the longer intervals (such as once per shift). Where the cycles occur in relatively quick fashion (minutes), special care is needed. Frequent direct across-the-line motor starting is hard on switchgear, motors, pumps, and systems. If frequent starting is needed, the use of electronic soft starters or other alternatives (such as adjustable speed drives) should definitely be considered.

*Best Practice —Parallel Pump Control*

- If there are multiple obvious flow regimes noticed from the system, investigate the option of parallel pumps to handle the different regimes.

**7.2.6 Minimize the Use of Throttling Valves or Bypass Operation**

One generic best practice is to minimize the use of valve throttling and bypass losses in system control. Throttled valves convert hydraulic energy that the pump has imparted to the fluid into frictional heat, thus wasting a portion of the pump's energy. Bypass control simply routes some of the fluid that the pump has energized right back where it came from (dissipating the energy into heat in the process).

Even this best practice, which is about as close as one can get to simplistic rules of thumb in pumping systems, has its exceptions. And those exceptions are strongly influenced by the two previously mentioned knowledge-and-understanding best practices (Sections 7.2.1 and 7.2.2). Two examples of the exceptions are provided here.

- For pumping systems with very high static head requirements, such as boiler feed water applications, the fundamental nature of the pump and system curves often dictates that some level of adjustable friction (i.e., control valve) be injected into the system in order for it to be controllable across the entire operating range. It is simply not practical to use an adjustable speed drive (for example) to provide all of the flow regulation, particularly at reduced load conditions.
- For systems that operate in a very narrow window of flow rate and head but do not require relatively tight regulation, the use of a control valve may, almost paradoxically, be the lowest energy cost alternative. For example, consider the pump and system curves shown in Figure 7.7 below. The pump was selected based on flow and head requirements at 5000 gpm. While an adjustable speed drive could be used to slow the pump down to achieve the 4700 gpm instead of regulating with the control valve, the end result would be additional cost.

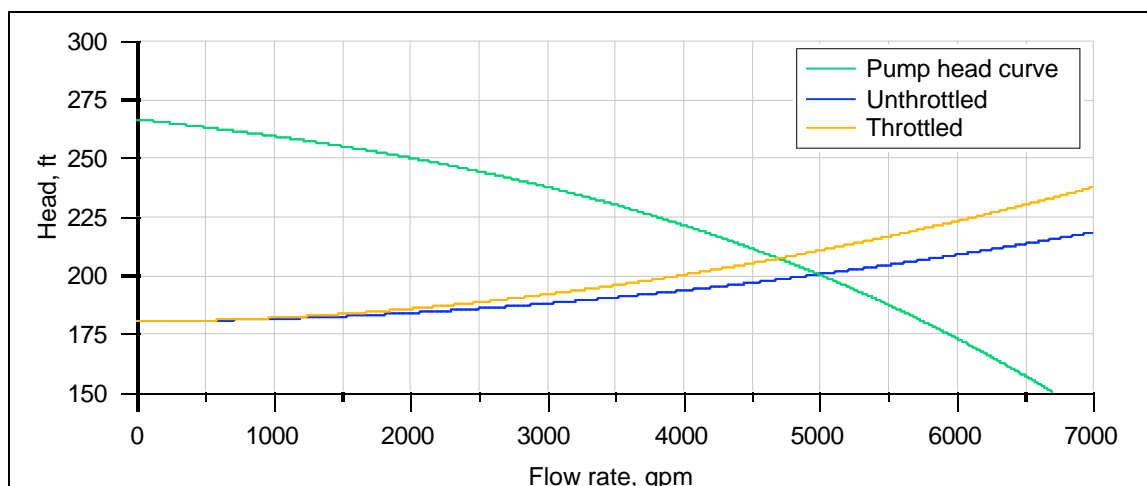

**Figure 7.7 System curves to vary flow rate between 4700 and 5000 gpm**

The reason for this is that the drive is not a perfectly efficient device. When operated near full-speed conditions, the drive would consume 3-4% of the input energy (converting electrical energy into heat). The drive itself would consume as much electrical energy at all flow conditions between 4700 and 5000 gpm as the maximum electrical energy that would be required to overcome the valve frictional losses at 4700 gpm. Thus, the use of the control valve – lightly throttled – would be the lowest energy cost alternative.

It should also be noted that while the use of bypass controls on centrifugal pump systems as a part of overall system process regulation is almost always a poor idea from an energy standpoint, not all bypass or re-circulation flow is a bad thing. In fact, it is essential in some cases. Minimum flow lines are designed to protect the pump against deadhead or no flow operation. Particularly for high-energy pumps, operation at no flow can result in nearly immediate equipment damage.

However, minimum flow protection and bypass operation for process control are two different things. It is when considerable flow is being diverted through a bypass line (and for a sizable portion of the time) that the wasted energy flag needs to be raised.

*Best Practice—Minimize the Use of Throttling and Bypass Controls*

- Use only the optimum number of throttling and bypass valves to reduce frictional losses in the system.
- Be aware that installing a control valve or bypass valve may be a better alternative to other control methods, such as using adjustable speed drives.

### **7.2.7 Demand Charge Minimization**

Control systems can also be an integral part of reducing electrical demand charges. Demand charges are common electric rate elements for industrial plants. The precise billing structure and magnitude varies significantly. Some utilities impose relatively mild demand charges, while for others the demand cost can be in the same ballpark as the energy charge component.

One very common misconception about demand charge is that motor starting is a critical component, since the motor inrush current (and power) are much higher than normal full load conditions during startup. However, the startup transient only lasts a few seconds, and the demand interval is typically 15 to 30 minutes in duration. It is the average power over that period that establishes the interval demand value. Either soft starters or adjustable speed drives can, in fact, reduce the inrush current, and be quite helpful in minimizing the mechanical and electromagnetic transient. But the associated reduced current inrush impact on the demand charge will not be measurable.

There are two best practices that do apply to demand charge reduction. These are simple rules of thumb, but unlike those noted above, they are both straightforward and essentially without exception.

#### **Low-use equipment**

Some equipment operates a relatively small portion of the time; for example, a pump might only run for a few minutes a day or maybe for an hour once a week. Coordinating these run times with the overall plant load—when possible—can pay healthy dividends.

#### **Power factor penalty**

In many cases, electric utilities include a power factor charge in the rate structure. Perhaps the most common way of including a power factor charge (or "penalty") is to specify a demand charge that is based on kVA (apparent power) rather than kW (true power). In many cases, the demand will be the greater of two values:

- the peak interval true power (kW), or
- 0.85 times the peak interval kVA (note: 0.85 is a common threshold, but values in excess of 0.9 are also found)

The effect of this structure is that if the plant's overall power factor is greater than 0.85 (or whatever the threshold value is), they will not be penalized. But if the power factor is less than 0.85, the demand charge will be multiplied by 0.85 and then divided by the actual power factor.

There are several things that can be done to improve power factor. First, motors that are severely under loaded will contribute to an overall lower power factor. Ensuring that motors are reasonably well sized to the load will help.

Second, power factor correcting capacitors can be used. These capacitors are individually coupled to specific motors. In some cases, capacitor banks are connected to the main bus instead of individual motors.

It might be noted that adjustable frequency drives (AFDs)—especially when accompanied by input line reactors—also tend to have relatively high power factors. There are some caveats here, since the true rms power factor and the displacement power factor are different for AFDs. The displacement power factor will usually be at 0.95 or greater, and the true rms power factor somewhat below that. But it is also important to mention that adjustable frequency drives and capacitor banks are not good companions.

An excellent third choice is to use synchronous motors to assist in power factor correction. Generally synchronous motors are quite large, such as the compressor motor shown in Figure 7.8. The power factor for synchronous motors can be adjusted to be leading, thereby compensating for the lagging power factor of induction motors and other inductive loads. Since synchronous motors are generally large (the one in Figure 7.8 is rated at 3850 hp), they can cancel the effects of numerous smaller inductive motors.



**Figure 7.8** Synchronous 3850-hp Motor

*Best Practices—Demand Charge Minimization*

- Coordinate equipment operation times to level out demand peaks.
- Install capacitors on motors to improve the power factor.
- Use synchronous motors to increase the power factor.

### **7.3 Equipment Selection and Installation Best Practices**

In most cases, the selection and installation of pumping system equipment in new applications involves significant conservatism. There are a host of factors involved, including uncertainties in component losses and equipment performance. The fundamental driving force, however, is that design engineers want to ensure that plant requirements are met.

Conservatism in component selection and system design inherently leads to excess energy consumption. Given the significance of energy in the overall lifecycle cost of ownership, it is important that personnel responsible for designing, installing, and operating pumping systems be aware of the potential effects of excessive conservatism. The following example is derived from actual experience.

#### **System and pump design An example of conservatism**

An example is used here to illustrate the impact of conservatism in design. The process —and end result—is representative of a considerable portion of existing process systems.

*Step 1: Identify the system design flow rate and head*

Flow rate basis: Plant production specification

Head basis: Calculations based on assumed pipe and pipe fitting loss characteristics at the design basis flow rate. Note that approximately 70% of the system frictional head is for control valve allowance.

*Step 2: Add system flow margin*

Add 10% to the Step 1 design flow rate basis

*Step 3: Add pump wear margin*

Add 10% to the Step 1 design head basis

Figure 7.9 shows the static head and the flow/head points corresponding to Steps 1 and 3.

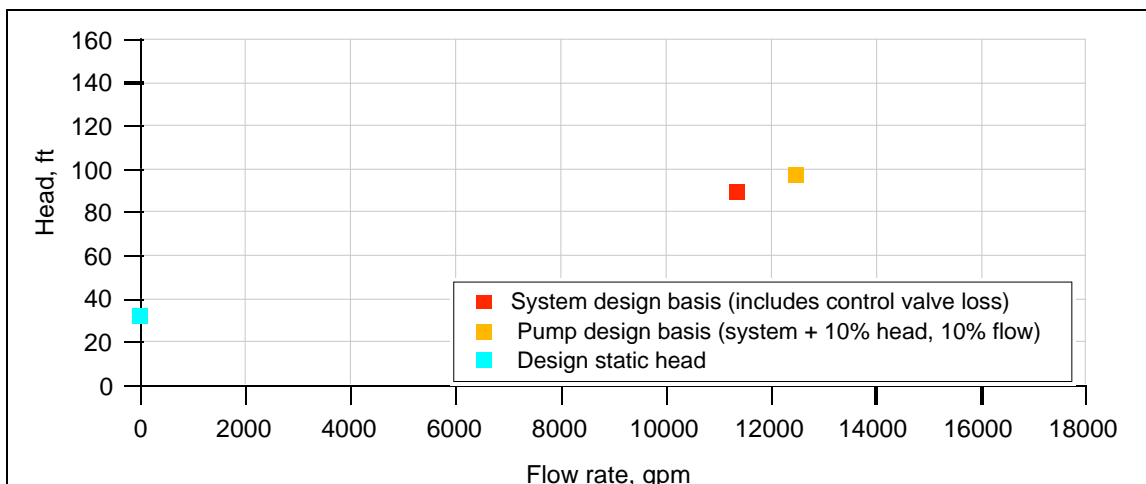
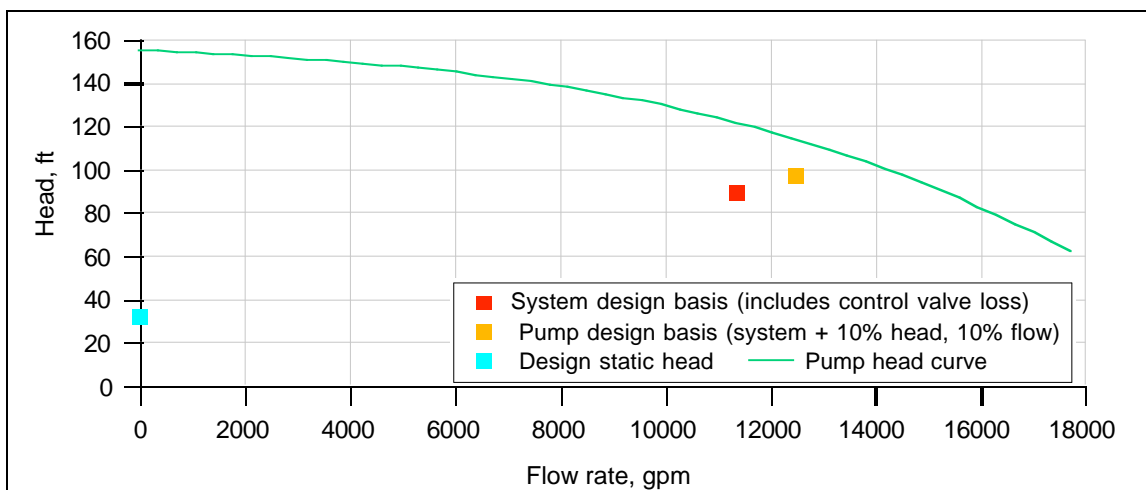

**Figure 7.9 Design points (correspond to after Step 1 and Step 3 above)**

*Step 4: Margin included in the pump selection process (independent of above margins)*

The last step in pump procurement is to use the Step 3 design point (12,500 gpm and 97 feet) to select a pump. The pump supplier will help with the selection of the right pump since they want to be sure that the equipment meets customers' needs. As part of the procurement process, which often includes a factory witness test requirement, the factory test encourages additional conservatism in pump selection.

The pump head-capacity curve of the selected model is added to the design points and shown in Figure 7.10. The actual pump includes roughly an additional 10% margin for both the head and capacity.



**Figure 7.10 Design points and manufacturer's curve for the selected and installed pump**

Typical performance points were measured in the field (flow rate and head), and are plotted in Figure 7.11. Note that the measured data fall above the pump curve, indicating that the pump is performing better than the generic pump manufacturer's performance curve. An estimated actual system curve, based on the field data (including significant losses across the system control valve) is included.

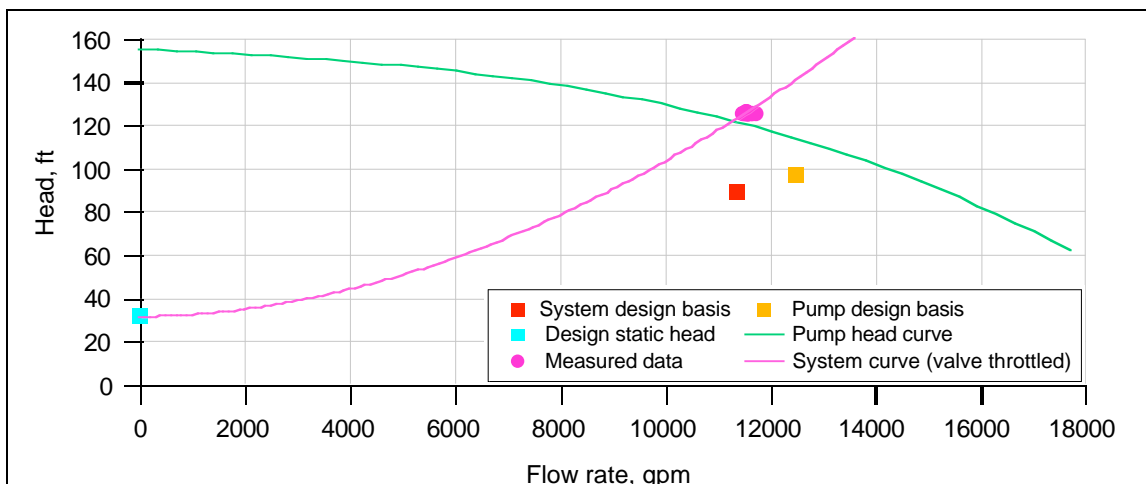
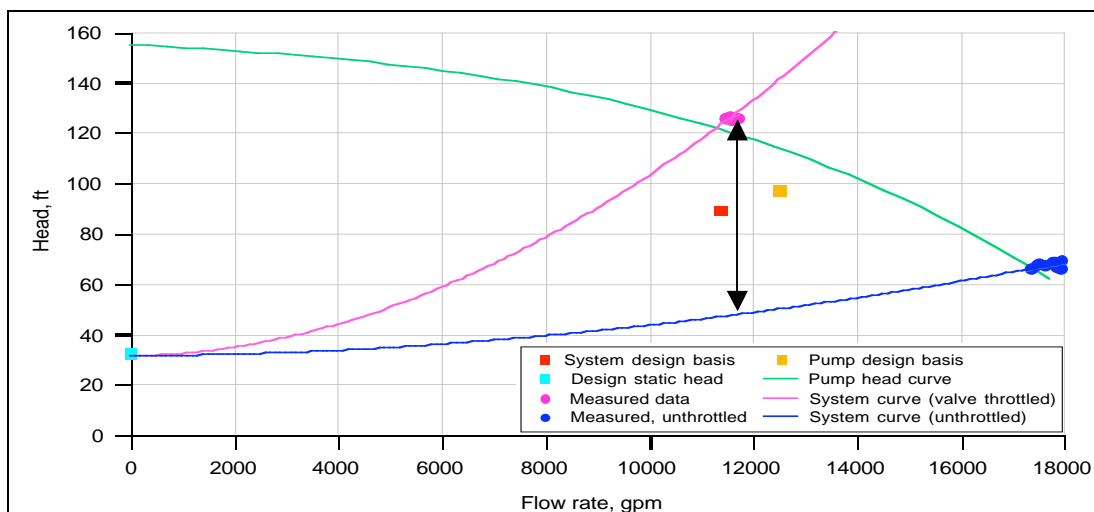

**Figure 7.11 Design and observed performance data**

There were clearly significant valve losses in this system. In order to determine how an unthrottled system curve would look, a special test was conducted to run the pumps with the control valve fully open for a few minutes (overflowing the receiving tank). The measured data and the unthrottled system curve are added to the above data and shown in Figure 7.12. The difference between the normal operating head (125.5 feet) and the unthrottled system head curve at the same flow rate (47 feet) is 78.5 feet.

The effect is that the pump adds 125.5 feet of head to the fluid, and the control valve then dissipates over 60% of the energy imparted by the pump.

Conservative design, at many levels, was responsible for creating this situation. At each step along the path, the conservatism assigned generally seemed reasonable (with the possible exception of a 40-foot allowance for control valve loss). But the conservatism at each of the steps accumulated until the actual installed equipment was vastly oversized for the true needs of the system.



**Figure 7.12 Design and observed field data, including unthrottled operation and related system curve**



The preceding example illustrates perhaps the most fundamental and important reason that there are significant energy-reduction opportunities in some pumping systems. While it may not be possible or even desirable to eliminate all of the conservatism, there are a few practices that may be helpful in minimizing its consequences.

*Best Practice—Prevent Excessive Conservatism in Design*

- Base purchase and design decisions on lowest lifecycle costs.
- Match true system requirements.
- Select the pump that is closest to the BEP (Best Efficiency Point on pump diagram).
- Select equipment with future changes in mind
- Ensure that installation follows standard recommended practices (particularly for suction)

### **7.3.1 Purchase and Design Decisions**

The importance of energy in the lifecycle costs of pumping systems was discussed in section 7.1.2. One way to minimize the effects of excessive conservatism is to ensure that lifecycle costs are recognized and included throughout the design specification and equipment selection processes.

Consider control valves, for example. The fluid power associated with 12,500 gpm and 40 feet of head is 126 hp. Assuming a combined pump and motor efficiency of 80% (which would be excellent), the electric power attributable to the valve loss would be 117 kW. Over the course of a year, more than 1 million kWh of energy will be dissipated by the valve. At a cost of 5 cents/kWh, the annual cost of the valve design allowance would exceed \$51,000.

The same sort of process could be applied to other conservative approaches, such as the 10% wear allowance for pumps. By tabulating and segregating costs in this fashion, there will be at least an element of feedback to counter the excessive conservatism in the design and procurement process.

Non-energy costs, such as the increased capital expenditure associated with significantly larger-than-necessary equipment, the purchase and maintenance costs for the control valve, etc., should also be factored in.

*Best Practice—Conduct a Lifecycle Cost Analysis*

- Conduct a lifecycle cost analysis to improve the accuracy of design and equipment selections. (Section 7.1.2)

### **7.3.2 Ensure that True System Requirements are Met**

This practice is intended to reinforce the very basic idea of doing what needs to be done, but no more. Designs will continue to be conservative, even when lifecycle costs are fully considered during the design and procurement process.

A good practice to implement for new systems follows:

1. Design with a reasonable amount of conservatism to ensure that the system meets plant needs, being sure to consider lifecycle costs in the process.

2. Complete the installation, startup testing and early operational phases.
3. When stable operation has been achieved (typically, within a few months), review the actual system performance to determine the cost of the differences between actual operation and an operating environment with a reasonable chunk of the excess losses eliminated (by equipment resizing, for example). The goal is to size pumping equipment as close to true system requirements as possible.

Including lifecycle costs in the design and procurement stages will help ensure that the equipment that is chosen will operate near its BEP. But, in conjunction with the previous practice of reviewing the system operation to make sure that the pumping system equipment is as closely matched to the true system requirements as practical, reconsideration of the actual operating pump efficiency is a useful practice.

Not only does this help verify that the equipment is operating near its BEP, it also provides a baseline reference for establishing trends over time.

*Best Practice—Test the System After It Is Installed*

- After installation, startup testing, early operational phases, and stable operation have been achieved, review actual system performance to determine the cost of the differences between actual operation and an operating environment.
- Resize equipment to eliminate losses.
- Select the pump to operate close to the Best Efficiency Point (BEP).

### **7.3.3 Plan for Future Capacity Increases**

In the design example above, margin was included for both pump wear and for "flow margin." The intent was to ensure that the installed equipment not only met today's requirements, but also had the capability of supporting increased production.

Considering future requirements is a very important part of the design process. However, installing equipment that is capable of doing more than is currently needed creates considerable energy-related cost burdens. A more intelligent process is to select equipment that can easily be upgraded by, for example, installing a larger impeller in the same pump casing. In other words, select the equipment with future modifications in mind, but don't install the modifications until they are actually needed.

It should be noted that the cost of oversized motors and switchgear is significantly lower than the cost of oversized pumps. While extreme over sizing of the motor is certainly to be discouraged, it is important that future pump modifications not be made excessively costly by upgrades to the motor and switchgear. In a case where the motor, cabling, and switchgear have to be upgraded to accommodate a larger impeller or a new pump, the modification costs can go up by almost an order of magnitude.

The absence of margin in motor sizes is also often a limiting factor in the ability to change existing operations to reduce energy costs. Take, for example, the case of a system that has two pumps, where the original design intent was to provide redundancy. If production increases change things to where a single pump is not quite capable of meeting the flow needs, the pump

that was originally intended to be redundant will be used to provide supplemental capability. It may be that with a slightly larger impeller, a single pump could meet the system needs and require only 70% of the power required by the two existing pumps. While cost of a new impeller would be easy to justify, the option will be unattractive if the motor, starter, and cables must also be upgraded.

There is no single best approach in this area—each situation must be considered on its own merits. But it is certainly a best practice to consider the future, but to do so from a lifecycle cost perspective.

*Best Practice—Consider the Future when Selecting New Equipment*

- Install a pump model that efficiently meets current needs but can be easily and cost effectively upgraded (or downgraded) in the future by adding stages or changing impellers.
- Install a pump with an adjustable speed drive, and adjust pump speed to meet both current and future needs.
- Provide sufficient space for equipment replacement or augmentation, as needs change.

### **7.3.4 Follow Standard Installation Practices**

Recommended best practices for pump installation, including foundation size and preparation, base plate installation and grouting, equipment alignment, intake design, and other important installation factors are included in the Hydraulic Institute standards<sup>40,41</sup>.

One particular area that the author has commonly observed to be out of bounds involves suction piping. The suction piping configuration establishes the flow profile for fluid approaching the pump impeller. Two examples of poor suction configuration are shown in Figures 7.13 and 7.14.

The horizontal split case pumps shown in Figure 7.13 include short radius elbows in a horizontal plane connected to the pump suction flange. This creates an unbalanced distribution of flow between the two sides of the impeller (which has a double suction). As a consequence, the pumps cavitate, operate inefficiently, and create a higher thrust load for the thrust bearing (which runs hot). In Figure 7.14, the eccentric reducer is turned upside down. As a result, air present in the pumped fluid, which comes out of a solution, tends to accumulate in the upper side of the pipe. Occasional slugs of air are pulled into the pump, resulting in a frothy discharge.

The suction configuration shown in Figure 7.15 is a much better design. The eccentric reducer's flat side is on top, and there are several pipe diameters of straight pipe upstream of the suction.

*Best Practice—Avoid Pump Geometries that Cause Unbalanced Flow Distribution*

- Ensure that the flow maintains a balanced distribution entering the pump inlet to prevent cavitations.

<sup>40</sup> ANSI/HI 1.4, American National Standard for Centrifugal Pumps for Installation, Operation and Maintenance, Hydraulic Institute, 9 Sylvan Way, Parsippany, New Jersey, <http://www.pumps.org/>

<sup>41</sup> ANSI/HI 9.8, American National Standard for Pump Intake Design, Hydraulic Institute, 9 Sylvan Way, Parsippany, New Jersey, <http://www.pumps.org/>



Figure 7.13 Pumping system layout with poor suction geometry (and little opportunity for improvement)

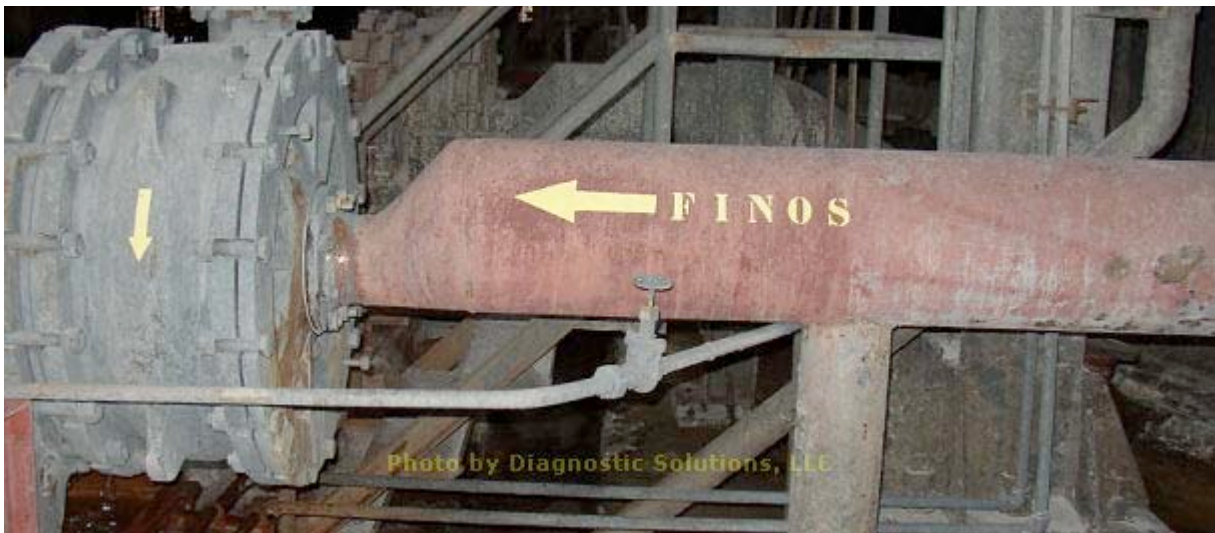

Figure 7.14 Inverted eccentric reducer allows air accumulation

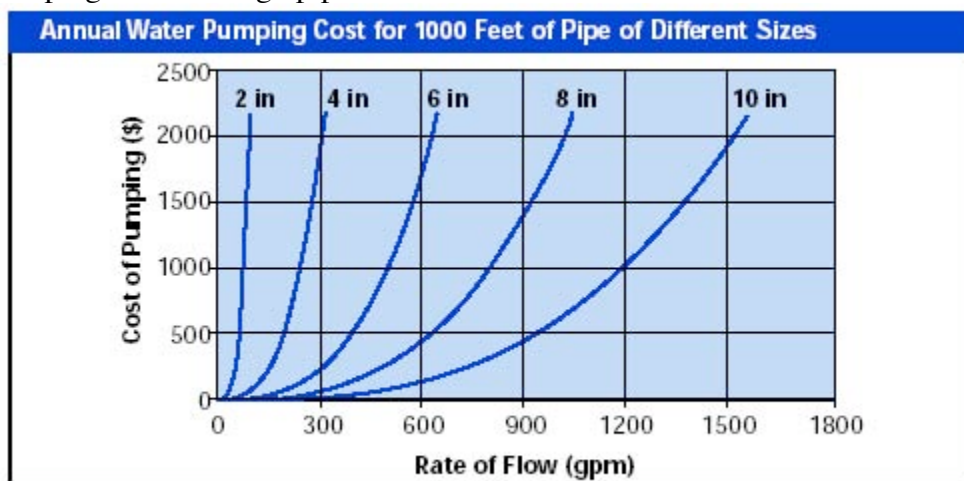

Figure 7.15 Pump suction with properly oriented eccentric reducer, well-developed suction flow profile

### 7.3.4 Optimize Pipe Sizes

The power required to overcome static head varies linearly with flow, and there isn't much that can be done to minimize the static component of the system requirements. However, there are many energy- and money-saving opportunities to reduce the head required to overcome frictional losses in a pumping system.

There are several parameters that affect friction, such as flow rate, pipe diameter, pipe length, pipe characteristics (i.e. surface roughness, etc.), and properties of the liquid being pumped. The diagram in Figure 7.16., taken from a fact sheet provided by the DOE,<sup>42</sup> shows estimates of the costs for pumping water through pipes of various diameters.



Based on 1000 ft. for clean iron and steel pipes (schedule 40) for pumping 70°F water. Electricity rate—0.05 \$/kWh and 8,760 operating hours annually. Combined pump and motor efficiency—70%.

Figure 7.16 Annual Water Pumping Cost

<sup>42</sup> Obtained from DOE website <http://www.oit.doe.gov/bestpractices/pdfs/motor1.pdf>

### *Best Practice—Optimize Pipe Sizes*

- Compute annual and lifecycle costs for the system before making an engineering decision.
- In systems dominated by frictional head, consider multiple options when trying to accommodate pipe size with lowest overall lifecycle cost.
- Search for ways to reduce the friction factor of the system. Certain piping materials, (if applicable), may reduce the friction factor by as much as 40%, proportionally reducing pumping costs.

## **7.4 Equipment Maintenance and Monitoring Best Practices**

Equipment reliability is critical in any production environment, especially the chemical plant environment when it comes to using pumps. Chemical processes rely on the movement of fluids through process equipment and pumps are the main method of fluid transfer. There are several diagnostic methods that are very helpful in monitoring equipment health. Well-implemented programs can often recognize degradation in the incipient stage. In some cases, the root cause of the problem can be identified and mitigated before further damage is done. In others, developing problems can be monitored carefully and trended, allowing preventive or corrective actions to be initiated in a planned environment instead of having to address failures that cause unplanned outages.

Rotating equipment can fail in any number of ways. With pumps, seals and bearings represent the most common areas where failures and, subsequently, repairs occur. For motors, it's bearings and motor windings. As a consequence of advances in digital processing capability, machinery diagnostic monitoring has reached a state of relative maturity in the last 20 years.

In addition to the now commonly implemented predictive techniques, a complementary method that is often overlooked—performance monitoring—can provide important insights into areas of pumps that are not well monitored by the diagnostic techniques.

### **7.4.1 Predictive or Diagnostic Monitoring**

Vibration monitoring is an excellent technique for measuring and trending rotating equipment balance, alignment, and bearing conditions. Analysis and trending software programs have automated detection and alarming of many of the critical degradation mechanisms that vibration measurements can detect, such as characteristic bearing flaw frequencies. Human analysis is still required, however.

Some equipment is so essential that dedicated, full-time monitoring with remote indication and alarm is merited. The use of routine routes with portable analyzers (see Figure 20) to acquire and store data for subsequent analysis is the best way to monitor other equipment. The frequency of monitoring is commonly dictated by both the criticality and previous measurement results. For example, if a pump bearing shows early indications of wear, the monitoring interval might be dropped from quarterly to monthly.

Other predictive methods that are effective in equipment health monitoring include lubricant analysis, infrared thermography, and various motor diagnostics (e.g., meggering, inductive and impedance unbalance measurements, and motor current signature analysis).

### **Equipment scope**

An important best practice related to any predictive monitoring effort is the scope and breadth of equipment that is included in the program. As noted above, certain equipment merits continuous diagnostic monitoring while other equipment can be effectively managed by periodic checks. And it is important to point out that some equipment simply does not warrant the time and expense associated with diagnostic monitoring. It is often the case that a relatively small part of the overall equipment population merits a large share of attention. (It should be noted that this is also true with respect to energy reduction opportunities).

When selecting equipment to be monitored and establishing the priority it receives, several factors must be considered, including safety, reliability and downtime, potential environmental release, cost of repair, and redundancy. Similarly, recognizing that each diagnostic technique has its own strengths and weaknesses, it is important to establish a program that matches the primary failure modes and mechanisms of concern for each piece of equipment with a monitoring protocol that is effective at detecting developing problems.

#### *Who should be involved?*

There are different schools of thought regarding who is best suited to perform diagnostic testing, and it is beyond the scope of this report to discuss all of the pros and cons of different approaches. However, when the chemical plant organizational structure permits it, diagnostic monitoring by the same maintenance staff responsible for equipment repairs is excellent. This is not always practical, but it is strongly encouraged.

### **7.4.2 Performance Monitoring**

Although equipment performance monitoring is normally considered a diagnostic tool, the fact is that, at least with pumps, it is an excellent preventative technique. In fact, most pump hydraulic degradation is essentially not detectable by any of the standard predictive tools (such as vibration monitoring), but can be detected by flow, head, and power measurements.

Very few facilities have well-developed performance monitoring programs. This is, in part, due to the fact that many fluid systems lack adequate instrumentation. However, portable instruments, such as the portable ultrasonic flow meter, can be used for field testing.

The Pumping System Assessment Tool<sup>43</sup>, which, as previously noted, is available as a free download from the U.S. DOE, can be effective in not only assessing the opportunity for energy savings, but in periodic performance monitoring as well. One of the reported values from the PSAT analysis is an "optimization rating," which is akin to an exam grade, with a value of 100 indicating that the equipment measured is not only very well suited to the fluid conditions, but is in excellent health. The DOE and several other organizations host one-day [end-user training](#) workshops several times a year; two-day qualified specialist workshops are also available.<sup>44</sup>

---

<sup>43</sup> Pumping System Assessment Tool, developed by Diagnostic Solutions, LLC for Oak Ridge National Laboratory and the U.S. Department of Energy. Available for free download at: [http://www.oit.doe.gov/bestpractices/software\\_tools.shtml#psat](http://www.oit.doe.gov/bestpractices/software_tools.shtml#psat)

<sup>44</sup> Pumping System Assessment Tool Specialist Qualification workshop, developed by Diagnostic Solutions, LLC for Oak Ridge National Laboratory and the U.S. Department of Energy. Information available at: [http://www.oit.doe.gov/bestpractices/software/psat\\_cert.shtml](http://www.oit.doe.gov/bestpractices/software/psat_cert.shtml)

PSAT input data and results for two pumps are shown in Figures 7.17 and 7.18. The "Condition A" data in Figure 7.17 represents field data for a newly installed vertical turbine pump at a water treatment facility. Note that the Optimization rating (bottom right, green background) is 97.8, indicating an excellent pump. On the other hand, the "Condition B" data of Figure 7.18 applies to a cooling tower vertical turbine pump. A few months after this measurement, the "Condition B" pump failed catastrophically (see pictures in Figure 7.19).

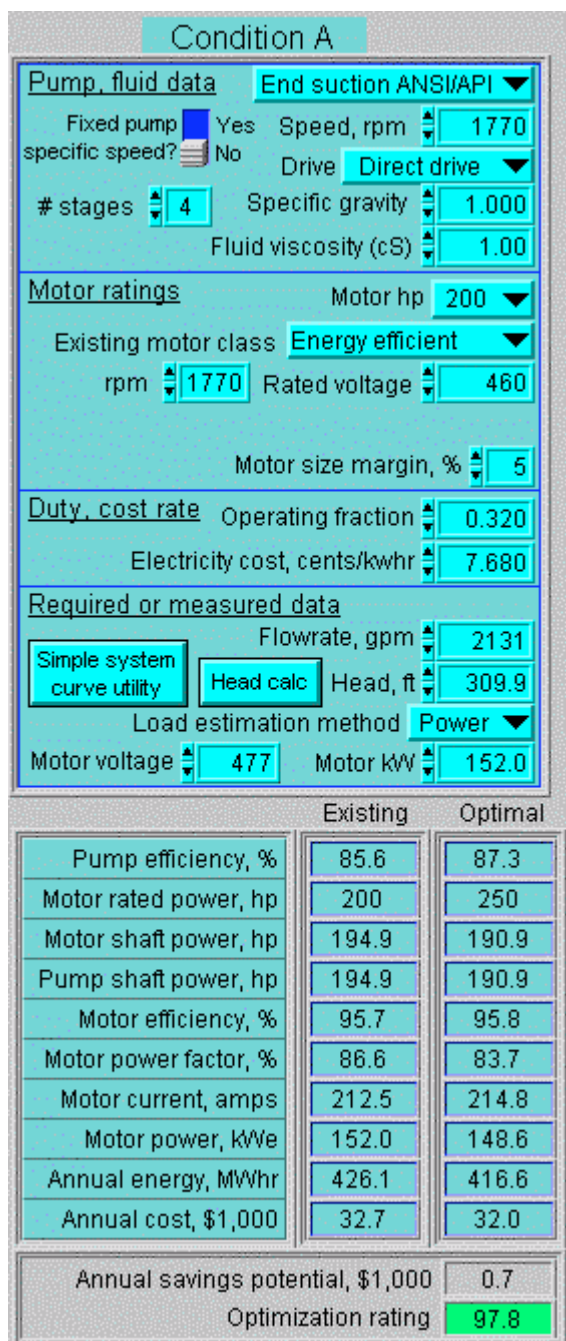

Figure 7.17 Newly installed pump, water treatment plant

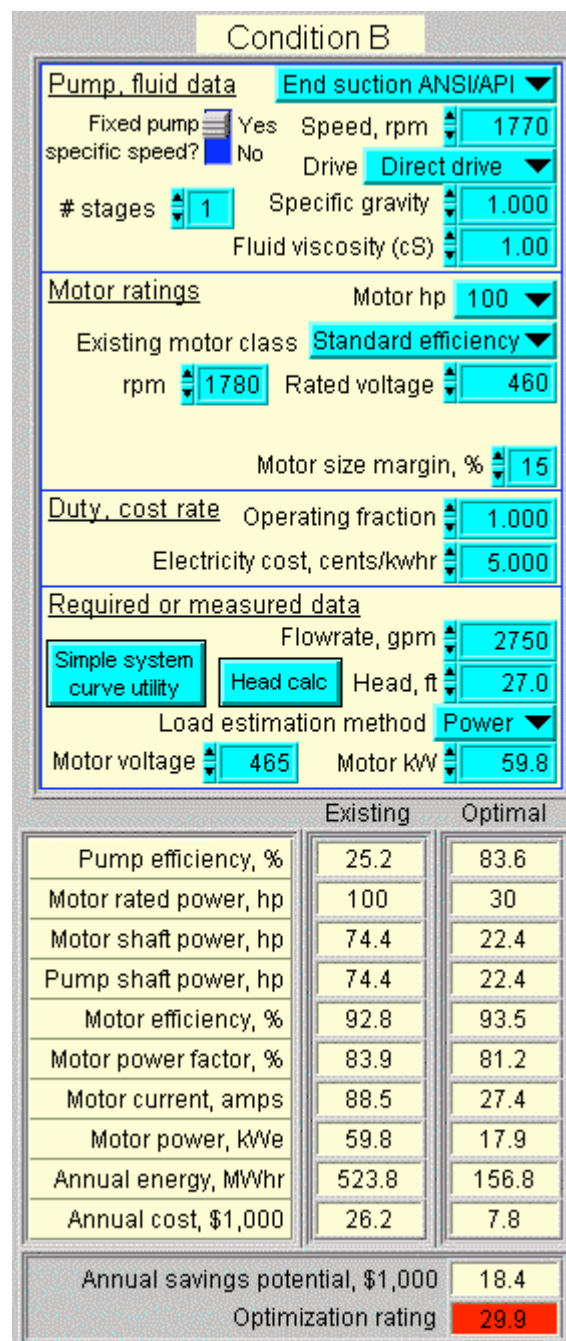

Figure 7.18 Significantly degraded tower water pump





**Figure 7.19** Impeller and bowl bolts from the tower water pump evaluated by PSAT in Figure 7.18

### **Selecting equipment for performance monitoring**

Quantifying the effective operation of a particular system requires detailed measurements of pressures, flow rates, and electrical input power. In some cases, these measurements are readily available but in others, there is little or no reliable process instrumentation. Particularly in the latter case, considerable time may be needed to install temporary instruments to acquire the necessary data. Furthermore, in many industrial facilities, there are literally hundreds of pumping systems. It is neither practical nor cost-effective to attempt to characterize each system.

In support of the PSAT software program and associated training, the U.S. Department of Energy's Best Practices program has developed prescreening guidance that is largely symptom-based. It has been found to be quite effective in identifying pumping systems that are most likely to yield cost-effective energy reduction potential. Several of the symptoms in the prescreening guide are directly linked to the existing control scheme.

It should be noted that the prescreening guide was specifically developed to flag systems that are *most likely* to yield energy reduction opportunities. There is no guarantee that energy reductions will, in fact, be realized. There is also no guarantee that systems without any of these symptoms could not be improved significantly. However, this symptoms-based approach has been demonstrated in a broad variety of process facilities, including steel, aluminum, mining, chemical and petroleum processing, paper, and others.

The first step in the prescreening process is to focus on the larger equipment that runs most of the time, for obvious reasons. Centrifugal pumping systems that do not use adjustable speed controls are selected in the second step. The third step involves identifying the presence of one or more of the following symptoms. The potential for savings increases with an increase in symptoms.

- Throttle valve-controlled systems
- Bypass (re-circulation) line normally open
- Multiple parallel pump system with same number of pumps always operating
- Constant pump operation in a batch environment or frequent cycle batch operation in a continuous process
- Cavitation noise (at pump or elsewhere in the system)
- High system maintenance
- Systems that have undergone a change in function

It should be noted that this prescreening process is strictly qualitative—it does not quantify opportunities. But it is an extremely valuable approach to identifying those systems for which a PSAT-based analysis (which *does* quantify the energy reduction opportunities), should be applied.

*Best Practice—Use Prescreening Processes to Identify Systems with Energy Savings Potential*

- Use PSAT-based analysis to identify potential energy saving opportunities.

### **7.4.3 Corrective Maintenance**

Although predictive maintenance and performance monitoring approaches are important to maximizing reliability and minimizing energy consumption, failures are inevitable. There are some recommended practices for both pump and motor failures that not only help to restore equipment to like-new condition, but also have the potential to improve reliability and reduce energy costs.

#### *Repair/replace policy*

An important element for both motor and pump maintenance is the establishment of a repair/replacement program.

Establishing a repair/replace policy for motors is a reasonably straightforward process. The cost of repair is weighed against the cost of replacement; the potential for reducing energy costs by installing a more efficient motor is also considered. Many users have a defined motor horsepower threshold below which a major motor failure automatically triggers a replacement. But above that threshold, the motor is sent to a repair shop.

An integral best practice connected with the repair part of the program is the selection of a shop that follows motor repair guidelines set by the Electrical Apparatus Service Association (EASA).<sup>45</sup> This ensures that work will be done in a manner that not only returns the motor to service, but avoids a reduction in efficiency.

A repair/replace policy is one part of a motor management program. The [Motor Decisions Matter](#) organization, which was developed from collaborative efforts of manufacturers, trade associations, utilities, and the U.S. Department of Energy, has additional information and guidance on recommended motor management activities.

There currently is not an equivalent organization for pumps. However, it is equally important for users to recognize that similar types of decision-making processes are appropriate for pumps. In many cases, the potential savings from either replacing or modifying an existing pump can be an order of magnitude greater than those available from a motor upgrade. Although it is generally not practical to complete a detailed analysis on all equipment, it is possible to do so for major energy using pumps. Performance monitoring of pumps, as discussed above, provides a critical insight into which pumps need a contingency plan for modification or replacement in the event of failure.

To help clarify the need for a contingency maintenance upgrade program, consider an example where replacing or modifying an existing pump could reduce energy costs by \$30,000 per year. But because of the critical nature of the pump, the cost of downtime associated with an outage to complete the modification or replacement is \$100,000. While a lifecycle cost analysis might suggest that this is the right thing to do, the reality is that it won't happen. However, if preparations are made for the point in time when the pump is removed from service—either for periodic overhaul or as the result of a failure – the picture becomes entirely different. If removal from service is the result of a failure, the urgencies associated with getting the equipment back on line will take precedence *unless a contingency plan is already in place*.

The U.S. DOE's PSAT workshop series uses case studies to describe examples of contingency-based upgrades.<sup>46</sup> In one example, a repair effort was used as leverage to make a design change that is saving over \$50,000 per year.

#### *Best Practice—Implement a Motor/Pump Maintenance Program*

- Develop and use a maintenance program

---

<sup>45</sup> EASA AR100-1998 Recommended Practice for the Repair of Rotating Electrical Apparatus, Electrical Apparatus Service Association, Inc., 1331 Baur Blvd., St. Louis, Missouri 63132, [www.easa.com](http://www.easa.com).

<sup>46</sup> Pumping System Assessment Tool Specialist Qualification workshop, developed by Diagnostic Solutions, LLC for Oak Ridge National Laboratory and the U.S. Department of Energy. Information available at: [http://www.oit.doe.gov/bestpractices/software/psat\\_cert.shtml](http://www.oit.doe.gov/bestpractices/software/psat_cert.shtml)

## **7.5 Motors**

The U.S. Department of Energy (DOE) estimated in a 1994 study that electrical motors in industrial facilities use roughly 23% of the electricity sold in the country. Motors are widely used by industry and efficiencies have increased in recent years due to market pressure and regulations.

The following paragraphs describe various factors that can result in energy savings; if available, the accepted best practices associated with each factor is also given. Motor upgrades should be considered since, in large applications, energy savings will quickly offset the initial investment.

### **7.5.1 Motor Efficiency Upgrades**

Always purchase the most efficient motor available when replacing an existing unit. Energy-efficient motors can cost 10-20% more than standard motors but energy savings normally offset this cost in less than two years. Often, motors are replaced by low-efficiency equipment because a fast work order is needed. To ensure the availability of energy-efficient equipment, make advanced purchases of replacement motors for equipment that tends to fail.

### **7.5.2 Motor Sizing and Loading**

Most industrial motors are most efficient when running from 65% to 100% of the rated power. The maximum efficiency is normally 75% of the load. Most motors tend to dramatically lose efficiency at loads below 50%. Power factor also deteriorates as loads decrease. Motors are considered under loaded when running below 65% load. On the other hand, motors are considered overloaded when running for long periods of time above their rated power. Overloaded motors will overheat and lose efficiency. Consider replacing all motors operating constantly below 40% or at any point above the rated load.

In many cases, motors are oversized because of safety factors incorporated during the design stage. All systems, including pumps, fans, and compressors, are designed to accommodate changes in the system, but designers should size motors to run within the best efficiency band (65-100% of the load). Variable frequency drives (VFD) or variable speed motors can accommodate changes in the load as well. Following are some opportunities for reducing the load requirements on the system:

- Eliminate bypass loops and unnecessary flows
- Increase pipe diameter to reduce friction
- Use holding tanks to better match pumping flows and production requirements
- Reduce equipment (e.g., pump, fan, etc.) size to match load
- Install parallel systems for varying loads
- Reduce system pressure

### **7.5.3 Voltage Unbalance**

Voltage unbalance occurs when there are different voltages on the lines of a polyphase motor. This leads to vibrations and stress on the motor as well as overheating and reductions in shaft power. It is recommended that the electrical distribution system be checked for voltage unbalances in excess of 1%. Polyphase motors with unequal voltage supplies lose efficiency and

those losses are drastic for unbalances beyond 1%. According to the DOE, common causes of unbalances include:<sup>47</sup>

- faulty operation of power factor correction equipment
- unbalanced or unstable utility supply
- unbalanced transformer bank supplying a three-phase load that is too large for the bank
- unevenly distributed single-phase loads on the same power system
- unidentified single-phase to ground faults
- an open circuit on the distribution system primary

### **Pump and Motor References**

1. United States Industrial Motor Systems Market Opportunities Assessment, report by Xenergy for Oak Ridge National Laboratory and the U.S. Department of Energy, 1998, available for free download at <http://www.oit.doe.gov/bestpractices/pdfs/mtrmkt.pdf>
2. Water and Wastewater Industries: Characteristics and Energy Management Opportunities, EPRI Report CR-106941, by Franklin L Burton, 1996.
3. Pump Lifecycle Costs: A Guide to LCC Analysis for Pumping Systems, Europump and Hydraulic Institute, 2001. An executive summary can be downloaded free from the U.S. Department of Energy at:  
[http://www.oit.doe.gov/bestpractices/pdfs/pumplcc\\_1001.pdf](http://www.oit.doe.gov/bestpractices/pdfs/pumplcc_1001.pdf)  
The full document can be purchased from the Hydraulic Institute at [www.pumps.org](http://www.pumps.org); an executive summary (and other useful documents) can be requested free of charge from Hydraulic Institute at  
[http://www.pumps.org/public/pump\\_resources/energy/index.html](http://www.pumps.org/public/pump_resources/energy/index.html).
4. ANSI/HI 1.4, American National Standard for Centrifugal Pumps for Installation, Operation and Maintenance, Hydraulic Institute, 9 Sylvan Way, Parsippany, New Jersey, <http://www.pumps.org/>
5. ANSI/HI 9.8, American National Standard for Pump Intake Design, Hydraulic Institute, 9 Sylvan Way, Parsippany, New Jersey, <http://www.pumps.org/>
6. Pumping System Assessment Tool, developed by Diagnostic Solutions, LLC for Oak Ridge National Laboratory and the U.S. Department of Energy. Available for free download at: [http://www.oit.doe.gov/bestpractices/software\\_tools.shtml#psat](http://www.oit.doe.gov/bestpractices/software_tools.shtml#psat)
7. EASA AR100-1998 Recommended Practice for the Repair of Rotating Electrical Apparatus, Electrical Apparatus Service Association, Inc., 1331 Baur Blvd., St. Louis, Missouri 63132, [www.easa.com](http://www.easa.com).
8. Pumping System Assessment Tool Specialist Qualification workshop, developed by Diagnostic Solutions, LLC for Oak Ridge National Laboratory and the U.S. Department of Energy. Information available at:  
[http://www.oit.doe.gov/bestpractices/software/psat\\_cert.shtml](http://www.oit.doe.gov/bestpractices/software/psat_cert.shtml)
9. Motor Tip Sheets, Eliminate Voltage Unbalance, [www.oit.doe.gov/bestpractices/pdfs/motor2.pdf](http://www.oit.doe.gov/bestpractices/pdfs/motor2.pdf)
10. <http://www.roymech.co.uk/Related/Pumps.html>
11. <http://www.oit.doe.gov/bestpractices/pdfs/motor1.pdf>

---

<sup>47</sup> Motor Tip Sheets, Eliminate Voltage Unbalance, [www.oit.doe.gov/bestpractices/pdfs/motor2.pdf](http://www.oit.doe.gov/bestpractices/pdfs/motor2.pdf)

## **8. Available Resources**

### **8.1 The Industrial Assessment Center**

In an effort to reduce the energy consumption of U.S. industry, the Department of Energy funded the Industrial Technologies program. This program seeks to educate those who work in industry in the following areas: tools development and training, plant assessments, showcase demonstrations, emerging technologies, Allied Partnerships, and technical information development.

The Industrial Assessment Center (IAC) was created for the Industrial Technologies program. There are 26 centers across the United States, offering free energy audits to mid-size manufacturing facilities; an engineering professor and student engineering team conduct the audits. The goals of each center are to increase energy savings in industry and offer graduate and undergraduate engineering students hands-on experience in manufacturing facilities.

Recommendations from energy audits offered by these centers have averaged savings around \$55,000 for each audited manufacturing facility. A recommendation is written when the audit team discovers a process, machine, or area that could yield significant energy savings. The amount of savings per recommendation can vary from hundreds of dollars to millions of dollars.

For the purposes of this project, a search on Industrial Assessment Center databases was conducted on the chemical industry in Iowa and also the United States. This search used SIC codes to separate chemical industry audits from other audits. While the recommendations offered by these energy audits do not include small or large manufacturing facilities, they do provide insight and options for facilities that aren't able to afford energy-consulting services.

Common recommendations in the U.S. chemical industry were found along with average savings, implementation costs, and the percentage of recommendations that were actually implemented. Table 8.1 shows some of the more common recommendations; these represent general areas of energy savings that were recommended by Industrial Assessment Centers nationally.

Table 8.1

<b>Recommendation</b>	<b>Ave. Savings</b>	<b>Ave. Cost</b>	<b>% Implemented*</b>	<b># Rec.</b>
<b>STEAM</b>				
Improve Combustion Air to Fuel Ratio	\$11,592	\$1,652	72%	125
Recover Energy From Boiler Blowdown	\$4,194	\$3,843	63%	8
Implement/Improve Condensate Return	\$304,892	\$49,808	54%	28
Install/Replace Boiler	\$112,480	\$85,751	22%	9
Reduce Steam Pressure	\$5,269	\$5,134	25%	12
Repair Steam Leaks	\$319,154	\$7,741	80%	40
Install/Replace Steam Traps	\$53,606	\$5,112	75%	36
Implement a Cogeneration System	\$547,317	\$1,330,231	22%	18
Install Fire Tube Turbulators	\$4,196	\$2,910	56%	9
<b>COMPRESSED AIR</b>				
Repair Compressed Air Leaks	\$4,284	\$708	77%	124
Bring Outside Air into Compressor Intakes	\$1,179	\$678	46%	136
Reduce Operating Pressure Of Compressor	\$5,999	\$1,194	45%	78
Install/Replace Air Compressor	\$7,190	\$14,162	46%	11
<b>PROCESS HEATING</b>				
Install Heat Exchanger/Economizer on Process	\$11,840	\$11,903	28%	29
Recover Waste Heat from Equipment	\$6,827	\$12,319	38%	79
Use Flue Gases for Preheating Combustion	\$23,567	\$21,455	33%	45
Insulate Equipment and Piping	\$4,059	\$2,782	51%	188
<b>EQUIPMENT</b>				
Install a Variable Frequency Drive on Machine	\$16,899	\$23,814	21%	48
Install/Replace/Modify HVAC Equipment	\$39,367	\$53,783	43%	47
Install Premium Efficiency Motors	\$4,596	\$12,579	64%	201
Install Cogged V-belts on Equipment	\$4,738	\$2,873	56%	119
Install Setback Timers and Thermostats	\$3,317	\$1,770	45%	78
<b>LIGHTING</b>				
Install High Efficiency Lighting	\$3,542	\$5,724	60%	376
Reduce Illumination/Delamp Areas	\$3,070	\$909	58%	86
Install Occupancy Sensors	\$1,856	\$1,330	23%	88
Implement Photosensors/Daylighting Strategies	\$9,365	\$11,110	29%	28

\*Percent Implemented represents what companies have currently reported, and this statistic doesn't take into account recommendations that may be implemented at a later date.

NOTE: These numbers represent approximations obtained from the October 2004 IAC National Database. To view the database, visit the internet address provided below.

Table 8.2 represents the recommendations found for the chemical industry in the state of Iowa, and only represents recommendations common with Table 8.1.

Table 8.2

Recommendation	Ave. Savings	Ave. Cost	% Implemented	# Rec.
Improve Combustion Air to Fuel Ratio	\$12,578	\$1,750	0%	2
Install/Replace Steam Traps	\$688	\$1,980	100%	1
Repair Compressed Air Leaks	\$2,273	\$212	67%	6
Bring Outside Air into Compressor Intakes	\$825	\$359	44%	9
Reduce Operating Pressure Of Compressor	\$17,286	\$36	33%	6
Install/Replace Air Compressor	\$1,533	\$9,824	100%	1
Install a Heat Exchanger/Economizer on Process	\$310	\$520	0%	1
Install a Variable Frequency Drive on Machine	\$2,732	\$16,938	0%	2
Install Premium Efficiency Motors	\$1,485	\$3,236	50%	4
Install/Replace/Modify HVAC Equipment	\$4,028	\$68,000	100%	1
Install Setback Timers and Thermostats	\$3,963	\$5,250	33%	3
Install High Efficiency Lighting	\$1,689	\$3,474	57%	14
Install Occupancy Sensors	\$1,100	\$1,009	0%	6

All of the common recommendations listed in the tables above were grouped into five main categories, which are steam, compressed air, process heating, equipment, and lighting.

Steam heating systems use boilers to produce steam, which is used in process equipment throughout a facility. There are many places throughout the steam distribution system where modifications or repairs can be made to help improve overall efficiency.

*Improve Combustion Air to Fuel Ratio*—Monitoring the oxygen levels of the leaving combustion gases can increase the efficiency of the steam system. (See: Section 4.4.1)

*Recovery Energy From Boiler Blowdown*—Solids (suspended or dissolved) are always present in water. When water in a steam system has a high concentration of solids, its efficiency is reduced and damage to components of the system becomes a concern. A process called “blowdown” removes the solids from the system. (See: Section 5.4.5)

*Implement/Improve Condensate Return*—Recovering water in a steam system can improve the efficiency of the system. The quality of newly condensed water in a steam system is very high and, as a result, less energy is required to change its state from water to steam. (Section: Steam)

*Install/Replace Boiler*—Occasionally old boilers have such low efficiencies that a surprising amount of energy can be saved by investing in a new, higher efficiency model. Improvements can also be made on current boilers to help improve the efficiency of the system. (Section: Steam)

*Reduce Steam Pressure*—Reducing the steam system pressure to an optimal/minimal setting can yield significant energy savings. When the system operates at a lower pressure, there are potential savings from labor and maintenance costs due to decreases in leakage and transportation resistance. (See Section 5.4.1)



*Repair Steam Leaks*—Steam leaks represent a large loss of energy as well as a hazard to equipment in the steam line, especially a boiler. To prevent large energy and repair costs, check for steam leaks on a regular basis. (See Section 5.5.1)

*Install/Replace Steam Traps*—Steam traps that are not functioning properly can waste energy, harm production, and damage equipment in the steam system. (See Section 5.5.3)

*Install Fire Tube Turbulators*—Installing turbulators in the “fire” tubes of fire-tube boilers can increase the efficiency of a steam system. These turbulators increase turbulence in the flow through the boiler, which increases overall heat transfer. Further information is provided in (Section: Steam).

Compressed air is sometimes referred to as the most expensive “utility” for manufacturing facilities. Air compressors consume great amounts of energy, thus these systems have great potential for energy savings.

*Repair Compressed Air Leaks*—Large amounts of energy are required to compress air, and any air that leaves the system through means other than the end applications wastes the energy used to compress that air. Further information is provided in (Section: Compressed air)

*Bring outside Air into Compressor Intakes*—Air at lower temperatures has a higher density and using air from outside is usually the lowest nearby air temperature to feed the compressor. Because the density is higher, more air mass will be compressed per volume. This recommendation is typically given for reciprocating compressors.

*Reduce Operating Pressure of Compressor*—Similar to reducing the operating pressure of a steam system, reducing the operating temperature of a compressed air system can reduce energy, labor, and maintenance costs. Further information is provided in (Section: Compressed air).

*Install/Replace Compressor*—Occasionally facilities will operate compressors that are inefficient. (Section: Compressed air)

Process heating is important in the chemical industry. Process heating is used to raise the temperature of materials during manufacturing. Because process heating is an energy-intensive process, there is large potential for energy savings.

*Install Heat Exchanger/Economizer on Process*—Wherever energy carried within process fluids is wasted, there is potential to add a heat exchanger or economizer to recover some of the wasted energy to serve other purposes. (See Section 5.6.2)

*Recover Waste Heat from Equipment*—Occasionally there are process applications where equipment generates a substantial amount of energy. If there is a nearby application where the energy may be utilized, such as supplemental heating during the winter, then there is a potential for energy savings. (See section 5.4.4)

*Use Flue Gases for Preheating Combustion Air*—If combustion flue gases are exiting the stack at a high enough temperature, the energy carried in the gas may be transferred to entering combustion air to reduce the energy consumed by the burner. (See Section 4.4.1)

*Insulate Equipment and Piping*—To prevent heat losses, ensure that all heating equipment and piping is properly insulated. (See Sections 5.5.2-5.5.3)

Pumps, motors, HVAC, and other equipment consume significant amounts of energy. Thus, any modifications or improvements to this equipment can yield significant energy savings.

*Install a Variable Frequency Drive on Machine*—Many machines in industry are run at full load even though they may require lower load conditions. Variable Frequency Drives (VFDs) modulate the speeds of motors operating equipment to match the optimum power output with the load required. (See Section: Equipment)

*Install/Replace/Modify HVAC Equipment*—Many manufacturing facilities are currently using HVAC equipment that is inefficient or operating at non-optimum levels. Software, product information, and consultant help can be used to optimize this equipment and realize energy savings. (See Section: Equipment)

*Install Premium Efficiency Motors*—Premium efficiency motors offer higher operating efficiencies than standard motors. Though purchasing a premium efficiency motor may involve a greater capital investment, the energy savings will more than pay for the price differential between the premium and standard motors. Utility companies may also offer rebates for premium efficiency motors. (See Section 7.5.1)

*Install Cogged V-Belts on Equipment* —Using cogged or “notched” v-belts can result in marginal energy savings. There’s less slipping with cogged belts, although it should be noted that some applications run better with slipping.

*Install Setback Timers and/or Thermostats*—These units help control the conditioning of air in an area, using the optimal amount of conditioning.

*Install High Efficiency Lighting* —Replace standard lighting with higher efficiency bulbs or ballasts. Reduce the amount of unnecessary lighting present in the facility.

*Reduce Illumination/De-lamp Areas*—Some energy savings can be realized by eliminating excess lighting.

*Install Occupancy Sensors*—In low occupancy areas, installing sensors may prove to be a cost effective way to control lighting.

*Implement Photosensors/Daylighting Strategies*—Photosensors and daylighting strategies are implemented to utilize the free lighting from the sun.

For more information about the Industrial Assessment Center, visit <http://iac.rutgers.edu/database/main.php> on the Internet or contact the Industrial Assessment Center at Iowa State University at (515) 294-3080.

### **IAC Resources:**

US DOE, Energy Efficiency and Renewable Energy  
<http://www.eere.energy.gov/industry/deployment.html>  
<http://iac.rutgers.edu/database/main.php>

## **8.2 Online Resources**

There are many Internet-based assessment tools, programs, and sources of information available to chemical manufacturing facilities. Most of these resources are free and fairly easy to access, especially those provided by the Department of Energy. The DOE provides software tools, case studies, research and development projects/solicitations, and additional information for the chemical industry.

### **8.2.1 Software Tools**

A good source for software tools is the DOE website, [www.doe.gov](http://www.doe.gov). This website branches off into sub-sites, many which provide the items discussed above. The following software tools are available from the DOE Industrial Technologies Program:

DOE-EERE, [http://www.oit.doe.gov/bestpractices/software\\_tools.shtml](http://www.oit.doe.gov/bestpractices/software_tools.shtml)

- AIRMaster+, a compressed air assessment package
- Fan System Assessment Tool, a fan optimization package for various fan system configurations
- MotorMaster+ 4.0, an energy efficient motor selection guide and management tool
- NOx and Energy Assessment Tool, a software package that helps assess NOx emissions and applications of energy efficiency improvements
- Process Heating and Assessment Survey Tool, a program which provides introductions to process heating methods as well as tools to help improve the thermal efficiency of heating equipment
- Pumping System Assessment Tool 2004, helps industrial users assess the efficiency of pumping system operations
- Steam System Tool Suite, collection of tools which help identify steam system improvements

DOE-EERE, [http://www.eere.energy.gov/industry/chemicals/chemicals\\_ind\\_tools\\_cd.html](http://www.eere.energy.gov/industry/chemicals/chemicals_ind_tools_cd.html)

- Chemical Industry Tools CD, provides resources and tools such as new innovative energy efficient technologies, energy analysis software tools, hands-on tips, plant assessment information, financial assistance and more

DOE-EERE, <https://sslserver.com/bcstools.net/CPAT/login.asp>

- CPAT 2.2, user inputs provide a measure of the potential commercial deployment of new processes, technologies, and practices

### 8.2.2 Case Studies and R&D Projects

Case studies offer information about energy audits conducted on manufacturing facilities. This information includes descriptions of the processes modified, successes, and experiences from the audits. Along with information from previous studies, the DOE Energy Efficiency and Renewable Energy Program offers information on active studies. The DOE is currently looking for companies to participate in these studies. The following websites provide information pertaining to case studies as well as current and past research and development projects:

DOE-EERE, [http://www.oit.doe.gov/bestpractices/case\\_studies\\_pwa.shtml](http://www.oit.doe.gov/bestpractices/case_studies_pwa.shtml)

- These case studies describe the energy improvement projects, process improvement projects, and assessments at the plant level.

DOE-EERE, [http://www.oit.doe.gov/bestpractices/emerg\\_tech/chem.shtml](http://www.oit.doe.gov/bestpractices/emerg_tech/chem.shtml)

- This website provides contact information on emerging technologies in the chemical industry.

DOE-EERE, <http://www.eere.energy.gov/industry/chemicals/portfolio.html>

- This website provides information on past and current research and development projects, DOE partnerships in Industry, and current events being held by the DOE.

STEAMING AHEAD, <http://www.steamingahead.org/casestudies/index.php>

- Search through a case study database to find case studies applied to different facility types.

COMPRESSED AIR CHALLENGE, <http://www.compressedairchallenge.org/>

- This website contains a case study index dedicated to the improvement of compressed air systems.

### 8.2.3 Organizations

Many alliances, partnerships, etc. provide resources on energy conservation, including:

- Alliance to Save Energy, <http://www.ase.org/>
- American Council for an Energy Efficient Economy, <http://www.aceee.org/>
- Association of Energy Engineers, <http://www.aeecenter.org/>
- Boiler Efficiency Institute, [www.boilerinstitute.com](http://www.boilerinstitute.com)
- Center for Analysis and Dissemination of Demonstrated Energy Technologies (CADDET) [www.caddet.org](http://www.caddet.org)
- Center for Industrial Research and Service <http://www.ciras.iastate.edu>
- Compressed Air Challenge, <http://www.compressedairchallenge.org>
- Council of Industrial Boiler Owners, <http://www.cibo.org/>
- Energy Information Bridge, <http://www.osti.gov/bridge>

- Energy Manager Training, [http://www.energymanagertraining.com/new\\_index.php](http://www.energymanagertraining.com/new_index.php)
- Energy Services, <http://www.energyexperts.org/>
- Energy Star, <http://www.energystar.gov/>
- Environmental Energy Technologies Division, Energy Analysis Department, <http://eetd.lbl.gov/EA.html>
- International Energy Agency, [www.iea.org](http://www.iea.org)
- Iowa Energy Center, [www.energy.iastate.edu](http://www.energy.iastate.edu)
- Iowa State University Industrial Assessment Center (IAC), (515) 294-3080  
[www.me.iastate.edu/iac](http://www.me.iastate.edu/iac)
- MidAmerican Energy <http://www.midamericanenergy.com>
- Cheresources, <http://www.cheresources.com/pinchtech1.shtml>
- Steaming Ahead, <http://www.steamingahead.org/casestudies/index.php>
- Simply Insulate, <http://www.simplyinsulate.com/>

**Coordinated by:**



The **Center for Industrial Research and Service (CIRAS)** works with Iowa State University Extension and the College of Engineering to enhance the performance of Iowa industry. This is accomplished by providing research, education and technical assistance in the areas of engineering, management, procurement, productivity and quality.

Center for Industrial Research and Service (CIRAS)  
2272 Howe Hall, Suite 2620  
Ames, IA 50011

For questions regarding manufacturing and industry contact:  
CIRAS  
(515) 294-3420  
[www.ciras.iastate.edu](http://www.ciras.iastate.edu)

**Sponsored by:**

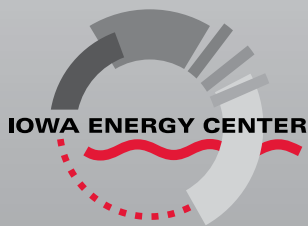

The **Iowa Energy Center** is dedicated to improving Iowa's energy efficiency and use of renewable energy through research, demonstration, and education. The Energy Center develops in-house energy-related research and education programs and sponsors energy projects developed by other groups. The Energy Center also administers the Alternate Energy Revolving Loan Program.

2521 Elwood Drive, Suite 124  
Ames, Iowa 50010  
[www.energy.iastate.edu](http://www.energy.iastate.edu)