

Improving Steam System Performance

a sourcebook for industry

One of a
series of
industrial
energy
efficiency
sourcebooks



Office of Industrial Technologies
Energy Efficiency and Renewable Energy
U.S. Department of Energy

Acknowledgements

Improving Steam System Performance: A Sourcebook for Industry is a development of the BestPractices Program under the U. S. Department of Energy's Office of Industrial Technologies (OIT). BestPractices undertook this project as a series of sourcebook publications. Other topics in this series include: compressed air systems, pumping systems, fan systems, and motor and drive systems. For more information about DOE's BestPractices, see *OIT and BestPractices* in the the *Programs, Contacts, and Resources* section in this publication.

OIT, Lawrence Berkeley National Laboratory, and Resource Dynamics Corporation wish to thank the staff at the many organizations that so generously assisted in the collection of data for this Sourcebook. The Alliance to Save Energy, the Council of Industrial Boiler Operators, the National Insulation Association, and the North American Insulation Manufacturers Association provided valuable assistance in developing, compiling, and reviewing this publication.

The BestPractices Steam program appreciates the participation of the Steam Technical Subcommittee. Special thanks are extended to its co-chairs, Dr. Anthony Wright, Oak Ridge National Laboratory, and Glenn Hahn, Spirax Sarco, an Allied Partner, for providing extensive technical guidance and review throughout the preparation of this publication. The efforts of these program and committee participants are greatly appreciated.

Additionally, the contributions of the following participants are appreciated for their review of and suggestions for this Sourcebook:

Deborah Bloom, ONDEO-Nalco
Sean Casten, Turbosteam Corporation
Bruce Gorelick, Enercheck Systems
Robert Griffin, Enbridge Consumers Gas, Canada
Dr. Greg Harrell, Energy, Environment and Resources Center, University of Tennessee-Knoxville
Thomas Henry, Armstrong Service
Carroll Hooper, Steam Solutions, Inc.
James Kumana, Kumana and Associates
Andrew W. Larkin, Trigen Energy Corporation
Lloyd Mason, Condensate Return Specialists
Gil McCoy, Office of Industrial Technologies Clearinghouse
Kelly Paffel, Plant Support and Evaluations, Inc.
W. Randall Rawson, American Boiler Manufacturers Association
Douglas Riley, Millennium Chemical
Thomas Scheetz, BASF
John Todd, Yarway Corporation

Prepared for: The United States Department of Energy
Office of Industrial Technologies

Prepared by: Lawrence Berkeley National Laboratory
Washington, DC
Resource Dynamics Corporation
Vienna, VA

Cover photo credit: NREL/PIX 05559. The Leathers geothermal power plant located in the Salton Sea, California.
Photo by Warren Gretz.

Contents

Acknowledgements	i
Table of Contents	ii
List of Figures and Tables	iii
Quick Start Guide	1
Section 1: Steam System Basics	3
Why Steam?	3
Steam System Operation	3
Generation	5
Distribution	11
End Use	15
Recovery	21
Section 2: Performance Improvement Opportunities	25
Overview	25
Systems Approach	25
Common Performance Improvement Opportunities	25
BestPractices Steam System Improvement Tools	26
Overview of Financing Steam System Improvements	28
Section 3: Programs, Contacts, and Resources	33
OIT and BestPractices	33
Directory of Contacts	35
Resources and Tools	36
Appendices	55
Appendix A: Glossary of Terms	57
Appendix B: Steam Tip Sheets	61
Appendix C: Guidelines for Comment	101

List of Figures

Figure 1. Steam System Schematic	4
Figure 2. Firetube Boiler	5
Figure 3. Watertube Boiler	6
Figure 4. Thermostatic Steam Trap with a Bellows Element	13
Figure 5. Thermostatic Steam Trap with a Bimetallic Element	13
Figure 6. Inverted Bucket Steam Trap	14
Figure 7. Float and Thermostatic Steam Trap	14
Figure 8. Thermodynamic Disc Steam Trap	14
Figure 9. Shell and Tube Heat Exchanger	18
Figure 10. Components of a Plate and Frame Heat Exchanger	18
Figure 11. Configuration of a Jacketed Kettle Heat Exchanger	18
Figure 12. Thermocompressor Operation	20
Figure 13. Condensate Receiver Tank and Pump Combination	22
Figure 14. Flash Steam Recovery Vessel	23

List of Tables

Table 1. Key IOF Steam End-Use Equipment	16
Table 2. Common Performance Improvement Opportunities for the Generation, Distribution, and Recovery Parts of Industrial Steam Systems	26

Quick Start Guide

This Sourcebook is designed to provide steam system users with a reference that describes the basic steam system components, outlines opportunities for energy and performance improvements, and discusses the benefits of a systems approach in identifying and implementing these improvement opportunities. The Sourcebook is divided into three main sections as outlined below.

This Sourcebook is not intended to be a comprehensive technical guide on improving steam systems, but rather a document that makes users aware of potential performance improvements, provides some practical guidelines, and directs the user to helpful resources. A systems approach analyzes the supply and the demand sides of the system and how they interact, essentially shifting the focus from individual components to total system performance. The cost-effective operation and maintenance of a steam system require attention not only to the needs of individual pieces of equipment, but also to the system as a whole. Often, operators are so focused on the immediate demands of the equipment, they overlook the broader question of how system parameters affect the equipment.

◆ Section 1: Steam System Basics

For users unfamiliar with the basics of steam systems, or for users seeking a refresher, a brief discussion of the terms, relationships, and important system design considerations is provided. Users already familiar with industrial steam system operation may want to skip this section. This section describes steam systems using four basic parts: generation, distribution, end use, and recovery.

◆ Section 2: Performance Improvement Opportunities

This section discusses important factors that should be considered when industrial facilities seek to improve steam system performance and to lower operating costs. This section also provides an

overview of the finance considerations related to steam system improvements. Additionally, this section discusses several resources and tools developed by the U. S. Department of Energy's (DOE) BestPractices Steam Program to identify and assess steam system improvement opportunities.

◆ Section 3: Programs, Contacts, and Resources

This section provides a directory of associations and other organizations involved in the steam system marketplace. This section also provides a description of the BestPractices Steam Program, a directory of contacts, and a listing of available resources and tools, such as publications, software, training courses, and videos.

◆ Appendices

The Sourcebook includes three appendices. Appendix A is a glossary defining terms used in steam systems. Appendix B contains a series of steam system tip sheets. Developed by DOE's BestPractices Steam Program, these tip sheets discuss common opportunities that industrial facilities can use to improve performance and reduce fuel use. Appendix C provides guidelines for submitting suggested changes and improvements to the Sourcebook.

Section 1: Steam System Basics

Why Steam?

There are three principal forms of energy used in industrial processes: electricity, direct-fired heat, and steam. Electricity is used in many different ways, including mechanical drive, heating, and electrochemical reactions. Direct-fired energy directly transfers the heat of fuel combustion to a process. Steam provides process heating, pressure control, mechanical drive, component separation, and is a source of water for many process reactions.

Steam has many performance advantages that make it an indispensable means of delivering energy. These advantages include low toxicity, ease of transportability, high efficiency, high heat capacity, and low cost with respect to the other alternatives. Steam holds a significant amount of energy on a unit mass basis (between 1,000 and 1,250 Btu/lb) that can be extracted as mechanical work through a turbine or as heat for process use. Since most of the heat content of steam is stored as latent heat, large quantities of heat can be transferred efficiently at a constant temperature, which is a useful attribute in many process heating applications.

Steam is also used in many direct contact applications. For example, steam is used as a source of hydrogen in steam methane reforming, which is an important process for many chemical and petroleum refining applications. Steam is also used to control the pressures and temperatures of many chemical processes. Other significant applications of steam are to strip contaminants from a process fluid, to facilitate the fractionation of hydrocarbon components, and to dry all types of paper products.

The many advantages that are available from steam are reflected in the significant amount of energy that industry uses to generate it. For example, in 1994, industry used about 5,676 trillion Btus of steam energy, which represents about 34 percent of the total energy used in industrial applications for product output¹.

Steam use in the Industries of the Future² is especially significant. For example, in 1994, the pulp and paper industry used approximately 2,197 trillion Btu of energy to generate steam, accounting for about 83 percent of the total energy used by this industry. The chemicals industry used approximately 1,855 trillion Btu of energy to generate steam, which represents about 57 percent of the total energy used in this industry. The petroleum refining industry used about 1,373 trillion Btus of energy to generate steam, which accounts for about 42 percent of this industry's total energy use³.

Steam System Operation

This Sourcebook uses four categories to discuss steam system components and ways to enhance steam system performance: generation, distribution, end use, and recovery. These four areas follow the path of steam as it leaves the boiler and returns via the condensate return system.

◆ Generation

Steam is generated in a boiler or a heat recovery steam generator by transferring the heat of combustion gases to water. When water absorbs enough heat, it changes phase from liquid to steam. In some boilers, a superheater further increases the energy content of the steam. Under pressure, the steam then flows from the boiler or steam generator and into the distribution system.

¹ Arthur D. Little, *Overview of Energy Flow for Industries in Standard Industrial Classifications 20–39*, December, 2000.

² DOE's Industries of the Future (IOF) include: agriculture, aluminum, chemicals, forest products, glass, metal casting, mining, petroleum refining, and steel.

³ Resource Dynamics Corporation estimates.

◆ **Distribution**

The distribution system carries steam from the boiler or generator to the points of end use. Many distribution systems have several take-off lines that operate at different pressures. These distribution lines are separated by various types of isolation valves, pressure regulating valves, and, sometimes, backpressure turbines. A properly performing distribution system delivers sufficient quantities of high quality steam at the right pressures and temperatures to the end uses. Effective distribution system performance requires proper steam pressure balance, good condensate drainage, adequate insulation, and effective pressure regulation.

◆ **End Use**

There are many different end uses of steam. Examples of steam's diverse uses include process heating, mechanical drive, moderation of chemical reactions, and fractionation of hydrocarbon components. Common steam system end-use equipment includes heat exchangers, turbines, fractionating towers, strippers, and chemical reaction vessels.

In a heat exchanger, the steam transfers its latent heat to a process fluid. The steam is held in the heat exchanger by a steam trap until it condenses,

at which point the trap passes the condensate into the condensate return system. In a turbine, the steam transforms its energy to mechanical work to drive rotating machinery such as pumps, compressors, or electric generators. In fractionating towers, steam facilitates the separation of various components of a process fluid. In stripping applications, the steam pulls contaminants out of a process fluid. Steam is also used as a source of water for certain chemical reactions. In steam methane reforming, steam is a source of hydrogen.

◆ **Recovery**

The condensate return system sends the condensate back to the boiler. The condensate is returned to a collection tank. Sometimes the makeup water and chemicals are added here while other times this is done in the deaerator. From the collection tank the condensate is pumped to the deaerator, which strips oxygen and non-condensable gases. The boiler feed pumps increase the feedwater pressure to above boiler pressure and inject it into the boiler to complete the cycle.

Figure 1 provides a general schematic description of the four principal areas of a steam system. The following sections discuss the components in these areas in greater detail.

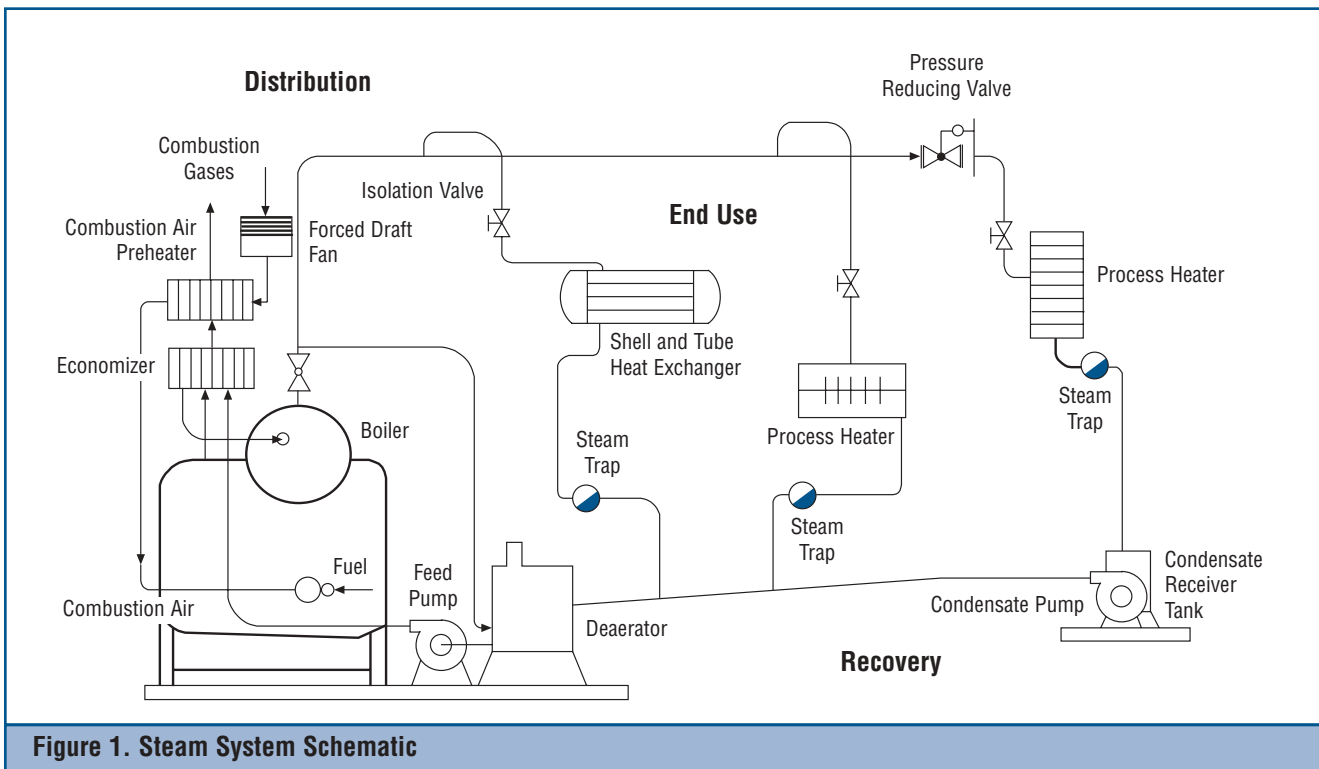

Figure 1. Steam System Schematic

Generation

The generation part of a steam system uses a boiler to add energy to a feedwater supply to generate steam. The energy is released from the combustion of fossil fuels or from process waste heat. The boiler provides a heat transfer surface (generally a set of tubes) between the combustion products and the water. The most important parts of the generating system include the boiler, the fuel supply, combustion air system, feedwater system, and exhaust gases venting system. These systems are related, since problems or changes in one generally affect the performance of the others.

◆ Boilers

There are two basic types of boilers: firetube and watertube. The fundamental difference between these boiler types is which side of the boiler tubes contains the combustion gases or the boiler water/steam.

Firetube Boilers. In firetube boilers, the combustion gases pass inside boiler tubes, and heat is transferred to water on the shell side. A representative firetube boiler is shown in Figure 2. Scotch marine boilers are the most common type of industrial firetube boiler. The Scotch marine boiler is an industry workhorse due to low initial cost, and advantages in efficiency and durability. Scotch marine boilers are typically cylindrical shells with horizontal tubes configured such that the exhaust gases pass through these tubes, transferring energy to boiler water on the shell side.

Scotch marine boilers contain relatively large amounts of water, which enables them to respond to load changes with relatively little change in pressure. However, since the boiler typically holds a large water mass, it requires more time to initiate steaming and more time to accommodate changes in steam pressure. Also, Scotch marine boilers generate steam on the shell side, which has a large surface area, limiting the amount of pressure they

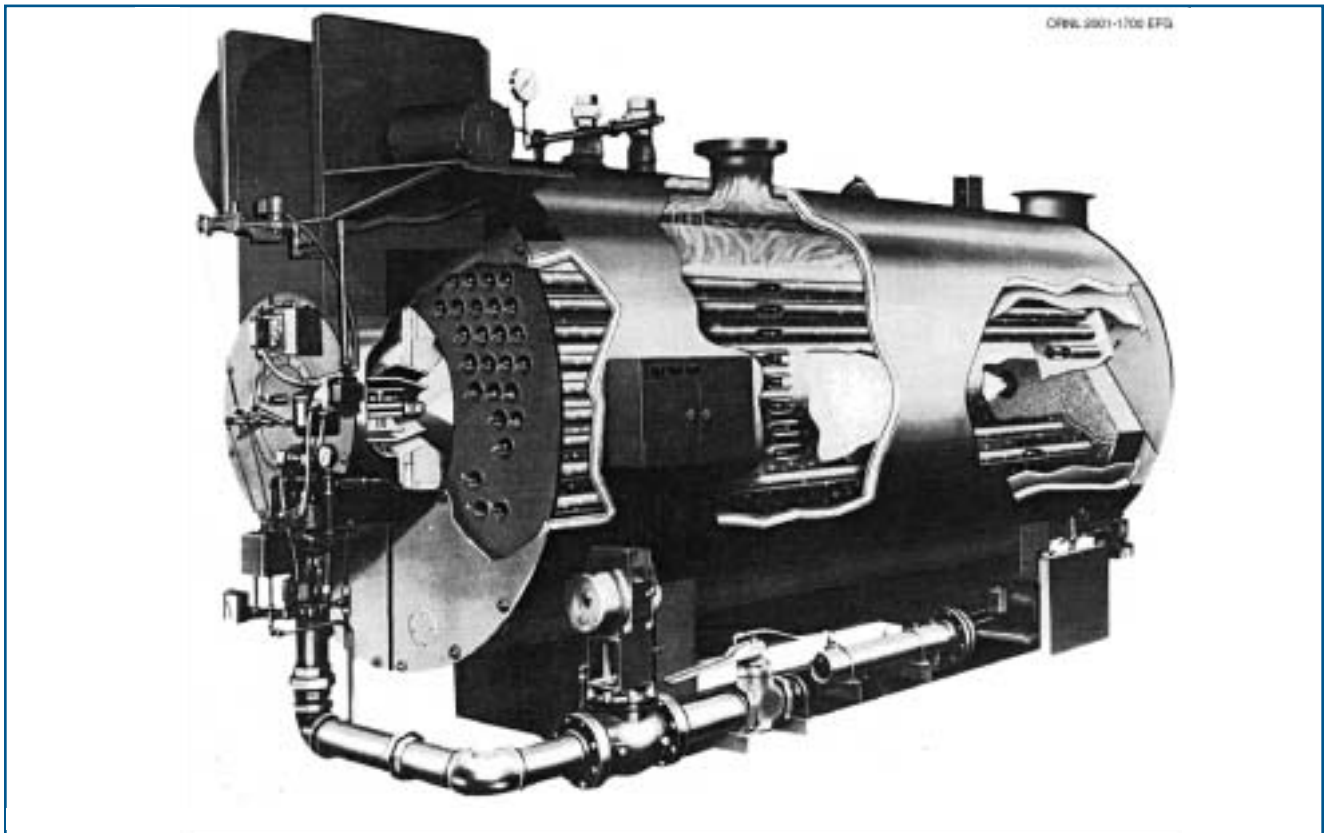

Figure 2. Firetube Boiler⁴

⁴ Guideline for Gas and Oil Emission Factors for Industrial, Commercial, and Institutional (ICI) Boilers, American Boiler Manufacturer's Association, Arlington, Virginia, 1997.

can generate. In general, Scotch marine boilers are not used where pressures above 300 psig are required. Today, the biggest firetube boilers are over 1,500 boiler horsepower (about 50,000 lbs/hr)⁵.

Firetube boilers are often characterized by their number of passes, referring to the number of times the combustion (or flue) gases flow the length of the pressure vessel as they transfer heat to the water. Each pass sends the flue gases through the tubes in the opposite direction. To make another pass, the gases turn 180 degrees and pass back through the shell. The turnaround zones can be either dryback or water-back. In dryback designs, the turnaround area is refractory-lined. In water-back designs, this turnaround zone is water-cooled, eliminating the need for the refractory lining.

Watertube Boilers. In watertube boilers, boiler water passes through the tubes while the exhaust gases remain in the shell side, passing over the tube surfaces. A representative watertube boiler is shown in Figure 3. Since tubes can typically withstand higher internal pressure than the large chamber shell in a firetube, watertube boilers are used where high steam pressures (3,000 psi, sometimes higher) are required. Watertube boilers are also capable of high efficiencies and can generate saturated or superheated steam. In fact, the ability of watertube boilers to generate superheated steam makes these boilers particularly attractive in applications that require dry, high-pressure, high-energy steam, including steam turbine power generation.

The performance characteristics of watertube boilers make them highly favorable in process industries, including chemical manufacturing, pulp and paper manufacturing, and refining. Although

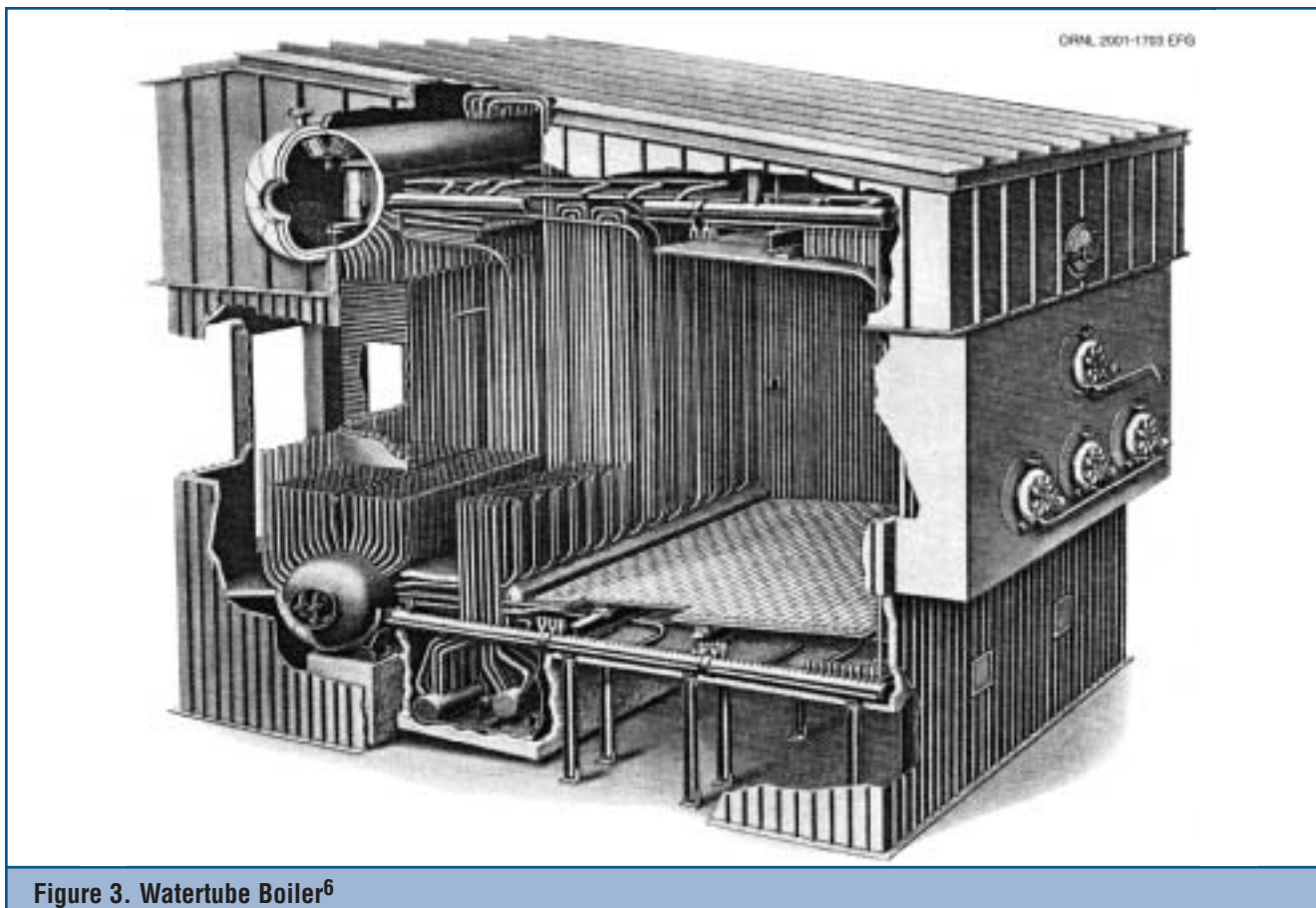

Figure 3. Watertube Boiler⁶

⁵ 1 boiler horsepower = 33,475 Btu/hr

⁶ *Guideline for Gas and Oil Emission Factors for Industrial, Commercial, and Institutional (ICI) Boilers*, American Boiler Manufacturer's Association, Arlington, Virginia, 1997.

firetube boilers account for the majority of boiler sales in terms of units, watertube boilers account for the majority of boiler capacity⁷.

Waste Heat Recovery Boiler (WHRB). These boilers may be either firetube or watertube design and use heat that would otherwise be discarded to generate steam. Typical sources of heat for WHRBs include exhaust gases or high temperature products from an external manufacturing process in refineries and chemical manufacturing facilities or combustion of a waste fuel in the boiler furnace.

Heat Recovery Steam Generators (HRSGs). HRSGs transfer energy from the exhaust of a gas turbine to an unfired or supplementary fired heat-recovery steam generator to produce steam. Exhaust gases leave the gas turbine at temperatures of 1000°F (538°C) or higher and can represent more than 75 percent of the total fuel energy input. This energy can be recovered by passing the gases through a heat exchanger (steam generator) to produce hot water or steam for process needs. If the amount of steam needed by the process exceeds the amount produced by simple heat recovery, then supplementary fuel can be burned in the ducting between the gas turbine and the HRSG.

Superheaters. Superheaters add energy to steam, resulting in a steam temperature that exceeds the saturation temperature at a specific pressure. Superheaters can be convective or radiant. Radiative superheaters rely on the energy transferred directly from the combustion flame to increase the energy level of the steam while convective superheaters rely on the transfer of additional energy from the flue gases to the steam.

Economizers. In many boilers, the flue gases still have useful amounts of energy even after they have passed through the boiler. In many of these applications, economizers provide effective methods of increasing boiler efficiency by transferring the heat of the flue gases to incoming feedwater. There are two principal types of economizers: non-condensing and condensing. Non-condensing economizers are usually air-to-water heat exchangers. Since these economizers are not

designed to handle flue gas condensation, non-condensing economizers must be operated at temperatures that are reasonably above the dew points of the flue gas components. The dew point of the flue gases depends largely on the amount of water in the gas, which, in turn, is related to the amount of hydrogen in the fuel. For example, to avoid condensation in the exhaust gases produced by burning natural gas, the exhaust gas temperature should typically be kept above 250°F. Condensing economizers are designed to allow condensation of the exhaust gas components. Due to latent heat recovery, these economizers typically extract more energy than do non-condensing economizers. Often, special materials are required.

For more information on economizers see the Steam Tip Sheet Number 3 titled *Use Feedwater Economizers for Waste Heat Recovery* in Appendix B.

Combustion Air Preheaters. Combustion air preheaters are similar to economizers in that they transfer energy from the flue gases back into the system. In these devices, however, the energy is transferred to the incoming combustion air. The efficiency benefit is roughly 1 percent for every 40°F increase in the combustion air temperature⁸.

◆ Boiler Insulation

The walls and combustion regions of boilers are typically lined with insulating materials to reduce energy loss and to prevent leakage. There are several types of boiler insulating materials, including brick, refractory, insulation and lagging. The selection and design of boiler insulating materials depend largely on the age and design of the boiler. Since the insulating lining is exposed to high temperatures and is subject to degradation, it should be periodically inspected and repaired when necessary.

◆ Boiler Control System

Boiler control systems are designed to protect the boiler and to ensure proper boiler operation. These systems include the combustion control system, flame safeguard, water level control, and fuel control.

⁷ GRI, Analysis of the Industrial Boiler Population, Final Report No.-96/0200, 1996.

⁸ Boiler Efficiency Institute, *Boiler Efficiency Improvement*, 1991.

Combustion Control System. The combustion control system regulates the fuel air mixture to achieve safe and efficient combustion and maintains steam system pressure. Control systems have varying levels of sophistication. Simple systems use a fixed linkage between the fuel-regulating valve and the combustion air damper. This is called single point positioning. A change in steam pressure makes a proportional change in the combustion air and fuel. Advanced systems rely on signals from transmitters to determine independent fuel valve and air damper positions. This is called a full monitoring system.

For more information see the Steam Tip Sheet Number 4 titled *Improve Your Boiler's Combustion Efficiency* in Appendix B.

Burner Flame Safeguard System. A flame safeguard system is an arrangement of flame detection systems, interlocks, and relays which will sense the presence of a proper flame in a furnace and cause fuel to be shut off if a hazardous condition develops. Modern combustion systems are closely interlocked with flame safeguard systems and also pressure-limit switches, low-water level cutoffs, and other safety controls that will stop the energy input to a boiler when an unsafe condition develops. The flame safeguard system senses the presence of a good flame or proper combustion and programs the operation of a burner system so that motors, blowers, ignition, and fuel valves are energized only when they are needed and then in proper sequence.

Safety Shutoff Valve. Safety shutoff valves isolate the fuel supply to the boiler in response to certain conditions such as low or high gas pressure or satisfied load demand. The type of safety shutoff valves and the settings are often determined by code or insurance requirements.

Water Level Control. The boiler water level control system ensures a safe water level in the boiler. Typically, the control system provides a signal to the feedwater control valve to regulate the feed rate. Simple water level control systems that only sense water level are single element systems. More complex systems incorporate additional data such as steam flow rate (dual element system) and feedwater flow (triple element system) and will provide better water level control during abrupt load changes.

Safety Valve. The safety valve is the most important valve on the boiler and keeps the boiler from exceeding its maximum allowable working pressure (MAWP).

Steam Pressure Control. Steam pressure controls regulate the combustion equipment to maintain a constant pressure in the steam header. As the pressure rises above or falls below the pressure setting, the control adjusts the burner firing rate to bring the pressure back to the setpoint.

Nonreturn Valve. The nonreturn valve is a combination shutoff and check valve that allows steam out of the boiler, but prevents backflow from the steam header in the event the boiler pressure drops below that of the header. The valve is opened only when the pressure inside the boiler rises slightly above the steam header pressure.

Steam Flow Meter. Steam flow meters are helpful in evaluating the performance of the system and can provide useful data in assessing boiler performance, calculating boiler efficiency, and tracking the amount of steam required by the system. In some systems, steam flow meters provide a measurement signal for the boiler control system. Additionally, steam flow meters can be useful in benchmarking efforts.

There are three basic types of steam flowmeters: differential pressure (DP), vortex, and Coriolis. Differential pressure flowmeters rely on the change in pressure as steam flows by an element such as a nozzle, orifice, or venturi. This pressure difference provides an indication of flow velocity, which, in turn, can be used to determine the flow rate. Vortex flowmeters rely on the principal that flow past an element creates vortices that have frequencies that correspond to the flow velocity. Coriolis flowmeters rely on tubes placed in the steam flow path that twist according to the velocity of the flow.

◆ Boiler Feedwater System

The boiler feedwater system supplies water to the boiler. Sources of feedwater include returning condensate and makeup water. Feedwater is typically stored in a collecting tank to ensure that a steady supply of heated water is available to the boiler.

Feedwater Flow Control Valve. A modulating feedwater flow control valve moves up or down in response to the water level transmitter(s). On smaller firetube boilers, it is not uncommon for the feedwater valve to operate in a closed or open position, depending on the water level transmitter signal.

Softener. Softeners remove hardness minerals, such as calcium, magnesium, and iron, from a water supply. The presence of hardness in boiler water leads to many problems, including scale buildup and foaming, which reduce boiler efficiency and can cause tube failure. Softeners reduce this problem through an ion exchange process. As the hard water passes through a chamber filled with resin, an exchange occurs that removes hardness minerals from the water. The sodium that replaces the hardness minerals has a higher solubility in water and generally will not form scale.

Pretreatment Equipment. Pretreatment equipment improves the quality of the incoming water so that it may be used in the boiler without excessive scaling or foaming, which can reduce boiler efficiency and cause tube failure. Pretreatment equipment includes, but is not limited to, clarifiers, filters, softeners, dealkalizers, decarbonators, reverse osmosis (RO) units, and demineralizers.

Deaerator, Deaerating Heater, and Atmospheric Deaerator. The presence of oxygen in the boiler system can be a significant problem due to its corrosivity at high temperatures. Deaerators and deaerating heaters use heat, typically steam, to reduce the oxygen content in water. Deaerators and deaerating heaters are typically pressurized tanks that raise the water temperature to the point of saturation. They also break the incoming water into either fine droplets or thin sheets to facilitate the removal of oxygen and other noncondensable gases. Depending on the design, the feedwater oxygen content can be reduced to levels ranging from 7 to 40 parts per billion (ppb).

Atmospheric deaerators are typically found in smaller, lower-pressure boiler systems. They operate at atmospheric pressure, so the maximum operating temperature is 212°F. Most will operate at temperatures lower than this. Atmospheric deaerators can not achieve the same level of oxygen

removal as deaerators and deaerating heaters, typically providing water with oxygen levels of 0.5 to 1 parts per million (ppm).

In applications that require lower oxygen levels than achievable with a deaerator, deaerating heater, or open feedwater heater, a chemical agent, known as an oxygen scavenger, can be used to remove more oxygen. In most systems, an oxygen scavenger is part of the system's water treatment program.

For more information on these devices see the Steam Tip Sheet Number 18 titled *Deaerators in Industrial Steam Systems*, provided in Appendix B.

Feedwater Pump. Feedwater pumps transfer water from the deaerator to the boiler. Feedwater pumps are driven by electric motors or by steam turbines. In a modulating feedwater system, the feedwater pumps run constantly as opposed to an on-off operation in relatively small boilers.

Collecting/Storage Tank. The return of condensate is often erratic due to changing steam requirements by the end uses. The condensate is usually returned to a condensate receiver or directly to the deaerator if the system does not have a receiver. Pretreated water may also be stored in a tank prior to use. This provides the boiler system with additional water capacity in case the pretreatment equipment malfunctions. The condensate and pretreated water, or makeup, are transferred from the storage tanks to the deaerator prior to being sent to the boiler.

◆ Boiler Combustion Air System

The combustion air system supplies the oxygen necessary for the combustion reaction. To provide enough air for the amount of fuel used in industrial boilers, fans are typically required. Dampers, inlet valves, or variable speed drives typically control the amount of air allowed into the boiler.

Forced Draft Fan. A forced draft fan is located at the inlet of a boiler and pushes ambient air into the burner region, ensuring that adequate air is delivered to the combustion process. These fans either pull air directly from the boiler room or connect to a duct system that allows outside air to be drawn into the boiler.

Induced Draft Fan. Induced draft fans are located on the outlet gas side of the boiler and pull flue gases out. The induced draft fan creates a slightly negative furnace pressure that is controlled by outlet dampers on the boiler. In some systems where a bag house, mechanical collector, or precipitator is involved, special considerations should be given in sizing and selection of this fan.

Damper. Dampers control the amount of air allowed into and out of a combustion chamber. Dampers, in combination with fuel regulating devices, are positioned by the combustion control system to achieve certain fuel:air ratios. Dampers on the boiler outlet are used to regulate the negative furnace draft.

◆ Boiler Fuel System

There are many different types of fuels used in boilers, requiring several different types of fuel handling systems. Fossil fuels such as coal, oil, and gas are most commonly used. Waste fuels are used in many industries, particularly the forest products, petroleum refining, and chemical manufacturing industries where there is an available supply of waste products such as bark, wood chips, black liquor, and refinery gas.

Fuel Regulating Valve. In gaseous and liquid fuels, regulating valves control the fuel delivered to the boiler. In many systems these valves can be quickly shut in response to an operating problem.

Fuel. The fuel types that are commonly used in boilers include natural gas, coal, propane, fuel oils, and waste fuels (for example, black liquor, bark, and refinery gas). Fuel type significantly affects boiler operation, including efficiency, emissions, and operating cost. Natural gas accounts for about 36 percent of the total U.S. industry boiler capacity. Coal accounts for about 14 percent of the boiler capacity. Fuel oils account for about 21 percent. Other fuels, which include waste fuels, account for about 29 percent of the boiler capacity⁹.

Fuel Flow Meter. Fuel meters measure the amount of fuel delivered to a boiler. Fuel meters provide essential data in determining boiler efficiency. Since fuel flow meters measure volume or mass of

fuel, it is important to know the energy content of the fuel when determining boiler efficiency.

For more information see the Steam Tip Sheet Number 15 titled *Benchmark the Fuel Cost of Steam Generation* in Appendix B.

Burner. Burners combine the fuel and air to initiate combustion. There are many different types of burners due to the many different types of fuels. Additionally, burners have different performance characteristics and control requirements. Some burners are on/off while others allow precise setting of the fuel:air mixture over a range of conditions. Some burners can fire different types of fuel, allowing boiler operation to continue despite the loss of one fuel supply.

◆ Boiler Blowdown System

The boiler blowdown system includes the valves and the controls for the continuous blowdown and bottom blowdown services. Continuous blowdown removes a specific amount of boiler water (often measured in terms of percentage of feedwater flow) in order to maintain a desired level of total dissolved solids in the boiler. Setting the flow for the continuous blowdown is typically done in conjunction with the water treatment program. Some continuous blowdown systems rely on the input of sensors that detect the level of dissolved solids in the boiler water.

The bottom blowdown is performed to remove particulates and sludge from the bottom of the boiler. Bottom blowdowns are periodic and are typically performed a certain number of times per shift or according to a set schedule. In some systems, bottom blowdowns are controlled by an automatic timer. Bottom blowdown should never be permitted unless it is recommended by the boiler manufacturer. This is because in higher pressure boilers, especially those above 700 psig, bottom blowdown may cause water starvation in some portions of the boiler circuit.

Boiler Blowdown Heat Exchangers and Flash Tank.

The continuous blowdown water has the same temperature and pressure as the boiler water. Before this high energy water is discharged into the environment, it is often sent to a heat exchanger

⁹ Derived from GRI, Analysis of the Industrial Boiler Population, Final Report No.-96/0200, 1996.

and flash tank. Flash tanks permit the recovery of low-pressure flash steam, which can be used in deaeration or process heating. They also permit the use of a smaller heat exchanger than would be required without the flash tank. Blowdown heat exchangers are most often used to preheat boiler makeup water.

For more information on boiler blowdowns, see the Steam Tip Sheets Numbers 9 and 10 titled *Minimize Boiler Blowdown*, and *Recover Heat from Boiler Blowdown* in Appendix B.

Distribution

The distribution system transports steam from the boiler to the various end uses. Although distribution systems may appear to be passive, in reality, these systems regulate the delivery of steam and respond to changing temperature and pressure requirements. Consequently, proper performance of the distribution system requires careful design practices and effective maintenance. The piping should be properly sized, supported, insulated, and configured with adequate flexibility. Pressure regulating devices such as pressure reducing valves and backpressure turbines should be configured to provide proper steam balance among the different steam headers. Additionally, the distribution system should be configured to allow adequate condensate drainage, which requires adequate drip leg capacity and proper steam trap selection. Steam distribution systems can be broken down into three different categories: buried pipe, above-ground, and building sections, and selection of distribution components (piping, insulation, etc.) can vary depending on the category.

◆ Piping

Steam piping transports steam from the boiler to the end-use services. Important characteristics of well-designed steam system piping are that it is adequately sized, configured, and supported. Installation of larger pipe diameters may be more expensive, but can create less pressure drop for a given flow rate. Additionally, larger pipe diameters help to reduce the noise associated with steam flow. As such, consideration should be given to the type of environment in which the steam piping will be located when selecting the pipe diameter.

Important configuration issues are flexibility and drainage. With respect to flexibility, piping, especially at equipment connections, needs to accommodate thermal reactions during system startups and shutdowns. Additionally, piping should be equipped with a sufficient number of appropriately sized drip legs to promote effective condensate drainage. Additionally, the piping should be pitched properly to promote the drainage of condensate to these drip lines. Typically these drainage points experience two very different operating conditions: normal operation and start-up; both load conditions should be considered in the initial design.

◆ Insulation

Thermal insulation provides important safety, energy savings, and performance benefits. In terms of safety, insulation reduces the outer surface temperature of the steam piping, which lessens the risk of burns. A well-insulated system also reduces heat loss to ambient workspaces, which can make the work environment more comfortable. Consequently, the energy saving benefits include reduced energy losses from the steam system and reduced burden on the cooling systems that remove heat from workspaces. In addition to its safety and energy benefits, insulation increases the amount of steam energy available for end uses by decreasing the amount of heat lost from the distribution system.

Important insulation properties include thermal conductivity, strength, abrasion resistance, workability, and resistance to water absorption. Thermal conductivity is the measure of heat transfer per unit thickness. Thermal conductivity of insulation varies with temperature; consequently, it is important to know the right temperature range when selecting insulation. Strength is the measure of the insulation's ability to maintain its integrity under mechanical loads. Abrasion resistance is the ability to withstand shearing forces. Workability is a measure of the ease with which the insulation is installed. Water absorption refers to the tendency of the insulation to hold moisture. Insulation blankets (fiberglass and fabric) are commonly used on steam distribution components (valves, expansion joints, turbines, etc.) to enable easy removal and replacement for maintenance tasks.

Some common insulating materials used in steam systems include calcium silicate, mineral fiber, fiberglass, perlite, and cellular glass. The American Society for Testing and Materials (ASTM) provides standards for the required properties of these and other insulation materials.

Additionally, the North American Insulation Manufacturers Association (NAIMA) has developed a software program titled 3E Plus that allows users to determine the energy losses associated with various types and thicknesses of insulation. The 3E Plus program facilitates the assessment of various insulation systems to determine the most cost-effective solution for a given installation. See Section 2, page 27 for more about 3E Plus Insulation software, which can help steam users assess insulation opportunities.

For more information on insulation, refer to Steam Tip Sheets Numbers 2 and 17 titled *Insulate Steam Distribution and Condensate Return Lines and Install Removable Insulation on Uninsulated Valves and Fittings*. Both can be found in Appendix B.

◆ Valves

In steam systems, the principal functions of valves are to isolate equipment or system branches, to regulate steam flow, and to prevent overpressurization. The principal types of valves used in steam systems include gate, globe, swing check, pressure reducing, and pressure relief valves. Gate, globe, and swing check valves typically isolate steam from a system branch or a component. Pressure reducing valves (PRV) typically maintain certain downstream steam pressure conditions by controlling the amount of steam that is passed. These reducing valves are often controlled by transmitters that monitor downstream conditions. Pressure relief valves release steam to prevent overpressurization of a system header or equipment.

◆ Steam Separators

In some steam systems, wet steam is generated. This wet steam contains water droplets that can reduce the effectiveness of the steam system. Water droplets erode turbine blades and passages reducing efficiency and life. Water droplets also tend to erode pressure reducing valves. Furthermore, liquid water can significantly reduce heat transfer rates in heat

exchange components as well as result in water hammer. Removing water droplets before they reach end-use equipment is necessary.

Steam separators remove water droplets, generally relying on controlled centrifugal flow. This action forces the entrained moisture to the outer wall where it is removed from the separator. The means of moisture removal could be a steam trap or a drain. Some manufacturers include the trap as an integral part of the unit. Additional accessories include water gage connections, thermometer connections, and vent connections.

Steam separators can be installed in either a horizontal or vertical line. They are capable of removing 99% of particulate entrainment 10 microns and larger over a wide range of flows. Separators are often designed in accordance with ASME Code, Section VIII, Division 1 with pressures to 300 psig.

◆ Steam Accumulators

A steam accumulator is a large insulated pressure vessel, partially filled with hot water (saturated liquid). When steam supply exceeds demand, the excess high-pressure steam is charged into the accumulator through special charging nozzles. The steam is condensed, giving up its latent heat, to raise the pressure, temperature, and heat content of the water body. When the steam demand exceeds the supply, the pressure in the accumulator drops and the additional required steam flashes from the water, taking back the heat previously stored. A simple system of control valves and check valves regulates the charging and discharging. The excess steam is charged quietly and smoothly, and when steam is needed, it is available with the speed of a control valve operation. There is also an accumulator design that stores hot water for use as boiler feedwater.

◆ Steam Traps

Steam traps are essential for proper distribution system performance. During system startups, traps allow air and large quantities of condensate to escape. During system operation, the traps allow collected condensate to pass into the condensate return system, while minimizing the accompanying loss of steam. There are three primary types of traps: thermostatic, mechanical, and thermodynamic¹⁰.

¹⁰The following discussion of steam traps is based extensively on C. B. Oland, Review of Orifice Plate Steam Traps, Oak Ridge National Laboratory, January 2001.

◆ **Thermostatic Traps**

Thermostatic traps use temperature differential to distinguish between condensate and live steam. This differential is used to open or close a valve. Under normal operating conditions, the condensate must cool below the steam temperature before the valve will open. Common types of thermostatic traps include bellows and bimetallic traps.

Bellows Traps. Bellows traps include a valve element that expands and contracts in response to temperature changes. Often a volatile chemical such as alcohol or water is inside the element. Evaporation provides the necessary force to change the position of the valve. At start up, the bellows trap is open due to the relative cold condition. This operating condition allows air to escape and provides maximum condensate removal when the load is the highest. Bellows traps can fail either open or closed. The configuration of a bellows steam trap is shown in Figure 4.

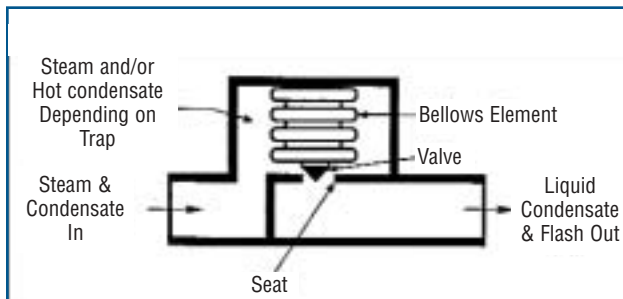

Figure 4. Thermostatic Steam Trap with a Bellows Element

Bimetallic Traps. Bimetallic traps rely on the bending of a composite strip of two dissimilar metals to open and close a valve. Air and condensate pass freely through the valve until the temperature of the bimetallic strip approaches the steam temperature. After steam or relatively hot condensate heats the bimetallic strip and causes it to close the valve, the trap remains shut until the temperature of the condensate cools sufficiently to allow the bimetallic strip to return to its original shape and thereby open the valve. Bimetallic traps can fail in either the open or closed position. The configuration of a bimetallic steam trap is shown in Figure 5.

◆ **Mechanical Traps**

Mechanical traps use the difference in density between condensate and live steam to produce a change in the position of a float or bucket. This

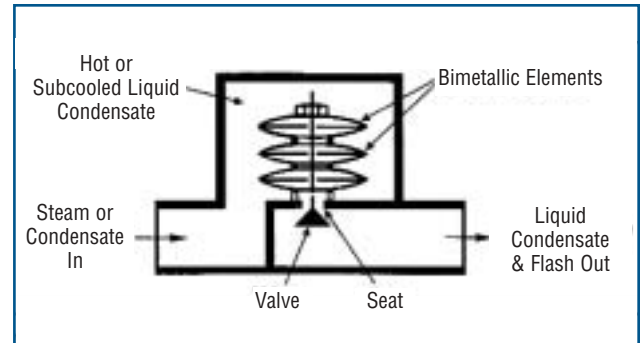

Figure 5. Thermostatic Steam Trap with a Bimetallic Element

movement causes a valve to open or close. There are a number of mechanical trap designs that are based on this principle. They include ball float, float and lever, inverted bucket, open bucket, and float and thermostatic traps.

Ball Float Traps. Ball float traps rely on the movement of a spherical ball to open and close the outlet opening in the trap body. When no condensate is present, the ball covers the outlet opening, thereby keeping air and steam from escaping. As condensate accumulates inside the trap, the ball floats and uncovers the outlet opening. This movement allows the condensate to flow continuously from the trap. Unless they are equipped with a separate air vent, ball float traps cannot vent air on start up.

Float and Lever Traps. Float and lever traps are similar in operation to ball float traps except the ball is connected to a lever. When the ball floats upward due to accumulation of condensate inside the trap body, the attached lever moves and causes a valve to open. This action allows condensate to continuously flow from the trap. If the condensate load decreases and steam reaches the trap, downward ball movement causes the valve to close thereby keeping steam from escaping. Unless they are equipped with a separate air vent, float and lever traps cannot vent air on start up. See the discussion on float and thermostatic traps.

Inverted Bucket Traps. Inverted bucket traps are somewhat more complicated than float and lever traps. At start up, the inverted bucket inside the trap is resting on the bottom of the trap body and the valve to which the bucket is linked is wide open. The trap is initially filled with condensate.

As steam enters the trap and is captured inside the bucket, it causes the bucket to move upward. This upward movement closes the valve and keeps steam from escaping. When the condensate collects and cools the steam, the bucket moves downward. This movement causes the valve to open thereby allowing the condensate to escape. Unlike closed float traps, inverted bucket traps have intermittent discharge. These traps can be depleted of their “condensate seal” when applied in superheated steam service. If this occurs, the trap will continuously discharge “live steam.” This trap type is not recommended for superheated steam service, unless special installation conditions are met. The configuration of an inverted bucket steam trap is shown in Figure 6.

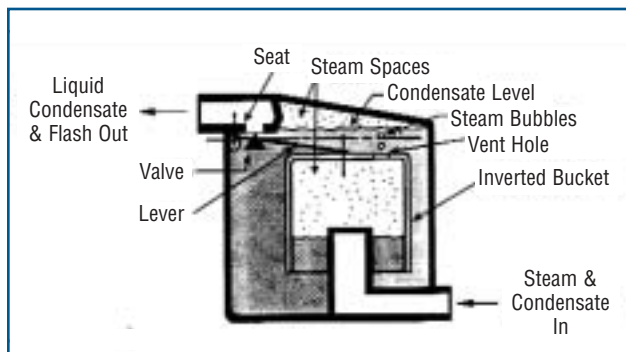

Figure 6. Inverted Bucket Steam Trap

Open Bucket Traps. Open bucket traps consist of an upright bucket that is attached to a valve. At start up, the bucket rests on the bottom of the trap body. In this position, the valve is wide open. As condensate accumulates in the trap body on the outside of the bucket, the bucket floats upward causing the valve to close. When sufficient condensate accumulates outside the bucket, it spills over the top and fills the inside of the bucket. At this time, the bucket sinks causing the valve to open. This trap is also prone to failure when applied in superheated steam service because of the loss of the condensate seal. Like inverted bucket traps, open bucket traps have intermittent discharge.

Float and Thermostatic (F&T) Traps. Float and thermostatic (F&T) traps are similar to float and lever traps except they include a thermostatic element that allows air to be discharged at start up and during operation. The thermostatic elements used in these traps are the same as those used in thermostatic traps. The configuration of a float and thermostatic steam trap is shown in Figure 7.

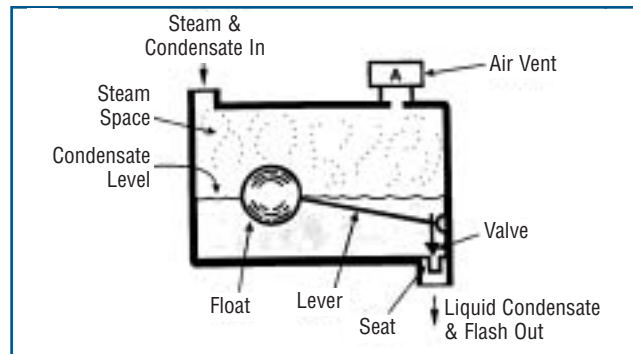

Figure 7. Float and Thermostatic Steam Trap

◆ **Thermodynamic Traps**

Thermodynamic traps use the difference in kinetic energy (velocity) between condensate and live steam to operate a valve. The disc trap is the most common type of thermodynamic trap, but piston or impulse traps are sometimes used.

Disc Traps. Disc traps use the position of a flat disc to control steam and condensate flow. When condensate flows through the trap, the disc is raised thereby causing the trap to open. As steam and air pass through the trap the disc moves downward. The force that causes the disc to move downward is generated by the difference in pressure between the low-velocity steam above the disc and the high-velocity steam that flows through the narrow gap beneath the disc. Disc traps commonly have an intermittent discharge and, when they fail, they normally fail open. The configuration of a disc steam trap is shown in Figure 8. Generally, the air

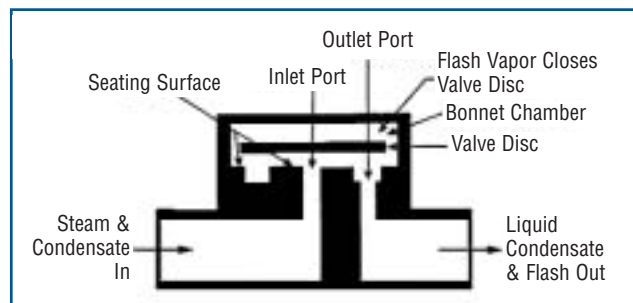

Figure 8. Thermodynamic Disc Steam Trap

removal capability of this trap type is poor unless equipped with additional components (like the float and thermostatic trap).

Piston Traps. Piston or impulse traps utilize the heat energy in hot condensate, and the kinetic energy in steam, to open and close a valve. Like

disc traps, piston traps are phase detectors that sense the difference between a liquid and gas or vapor. They continuously discharge any air and condensate. Their primary failure mode is open.

Lever Traps. Lever traps are a variation of the thermodynamic piston trap. They operate on the same principal as a piston trap but with a lever action to pass large amounts of condensate and air on a continuous basis. Their primary failure mode is open.

Orifice Traps. Orifice traps are of two basic types: orifice plate and short tube. Both trap types operate under the exact same principles. A simple orifice plate steam trap consists of a thin metal plate with a small-diameter hole (orifice) drilled through the plate. When installed, condensate that accumulates is continuously removed as the steam pressure forces the condensate through the orifice. During conditions when no condensate is present, a limited amount of steam flows through the orifice. The report *Review of Orifice Plate Steam Traps* in Resources: Reports and Technical Papers on page 51 of the Programs, Contacts, and Resources Section, provides information for making informed decisions about when orifice plate steam traps should be considered for use in new or existing steam systems.

Additional information regarding steam traps is available in the Steam Tip Sheet Number 1 titled *Inspect and Repair Steam Traps*, found in Appendix B.

◆ Steam Meters

The use of flowmeters within the distribution system can provide important data for monitoring the efficiency of a process or an end use. Tracking the amount of steam required can be particularly useful in benchmarking efforts. The types of steam flowmeters are discussed in the Generation Section.

End Use

Steam system end-use equipment transfers steam energy into other forms of useful energy. Common

end-use equipment includes heat exchange devices to transfer thermal energy and turbines to recover mechanical energy. In manufacturing industries, steam end uses often directly support production, making their performance and reliability essential to plant productivity. Improvements in end-use efficiency and effectiveness also tend to result in better performance and increased reliability. There is a wide range of end-use equipment, largely due to the advantages of steam that are discussed in the Introduction. Some of the major end-use components are discussed in this section.

For the purposes of this discussion, steam end-use equipment is grouped into three basic categories:

- Industries of the Future¹¹ (IOF) key end-use equipment;
- Conditioning and control equipment; and
- Additional equipment.

The key IOF equipment category includes the largest uses of steam in those industries. Although IOF facilities use steam for other services as well, the key end uses account for the largest amount of steam use. The conditioning equipment category includes equipment that facilitates the effective use of steam. The additional equipment category includes equipment that is used in other industries and, though significant, does not account for most of the steam use in IOF industries.

◆ Industries of the Future Key End-Use Equipment

In the three IOF industries of forest products, petroleum refining, and chemicals, steam accounts for the largest amount of end-use energy. In another IOF industry, steel production, steam represents a significant amount of end-use energy and is used to generate most of that industry's on-site electric power. Table 1 provides a list of key steam-supplied end-use equipment for IOF industries.

◆ Condensers

In steam applications, condensers are associated with condensing steam turbines and with multiple stage ejector systems. In steam turbine applications, condensers typically operate under a vacuum.

¹¹ Industries of the Future (IOF) include: agriculture, aluminum, chemicals, forest products, glass, metal casting, mining, petroleum refining, and steel.

Table 1. Key IOF Steam End-Use Equipment

Equipment	Process Application	Industry
Condenser	Steam turbine operation	Aluminum, Chemical Manufacturing, Forest Products, Glass, Metal Casting, Petroleum Refining, and Steel
Distillation tower	Distillation, fractionation	Chemical Manufacturing, Petroleum Refining
Dryer	Drying	Forest Products
Evaporator	Evaporation/concentration	Chemical Manufacturing, Forest Products Petroleum Refining
Process heat exchanger	Alkylation, Process air heating, Process water heating, Gas recovery/Light ends distillation, Isomerization, Storage tank heating Visbreaking/Coking	Aluminum, Chemical Manufacturing, Forest Products, Glass, Metal Casting, Petroleum Refining, and Steel
Reboiler	Fractionation	Petroleum Refining
Reformer	Hydrogen generation	Chemical Manufacturing, Petroleum Refining
Separator	Component separation	Chemical Manufacturing, Forest Products, Petroleum Refining
Steam ejector	Condenser operation, Vacuum distillation	Aluminum, Chemical Manufacturing, Forest Products, Glass, Metal Casting, Petroleum Refining, and Steel
Steam injector	Agitation/blending, Heating	Chemical Manufacturing, Forest Products, Petroleum Refining
Steam turbine	Power generation, Compressor mechanical drive, Hydrocracking, Naphtha reforming, Pump mechanical drive, Feed pump mechanical drive	Aluminum, Chemical Manufacturing, Forest Products, Glass, Metal Casting, Petroleum Refining, and Steel
Stripper	Distillation (crude and vacuum units), Catalytic cracking, Asphalt processing, Catalytic reforming, Component removal, Component separation, Fractionation, Hydrogen treatment, Lube oil processing	Chemical Manufacturing, Petroleum Refining
Thermocompressor	Drying, Steam pressure amplification	Forest Products

They remove energy from the exhaust steam allowing it to be recovered as condensate. In steam ejector applications, condensers increase the effectiveness of the ejectors by condensing both the motive steam and condensables pulled from the process, reducing the amount of motive steam required.

Condensers can be surface type or barometric. Surface condensers are supplied with cooling water that circulates through condenser tubes providing a cool surface area that causes steam condensation. The condensate is typically collected in a condensate well, and pumped into the condensate return system. Barometric condensers rely on direct contact between the cooling water and the steam. In petroleum refining and chemical manufacturing

applications, condensers are also used to condense components from gaseous mixtures. In these applications, the condensers use a cooling medium to extract energy from the gases and collect the condensed components.

◆ **Distillation Towers**

The petroleum refining and chemical manufacturing industries use large amounts of steam to facilitate the separation of crude oil or chemical feedstocks into various components. This separation process relies on differences in the boiling points of these hydrocarbon components. Fractionating towers use a furnace to heat crude oil above 700°F. As the volatile components boil off and rise up the tower, they cool and condense on trays. Steam is injected

into the bottom of these towers to reduce the partial pressures of the hydrocarbons, which facilitates their separation, and to reduce coke formation on tray and tower surfaces.

◆ **Dryers**

Dryers reduce the water content of a solid. Dryers account for the largest end use of steam in the pulp and paper industry¹². The chemical manufacturing, textiles, and food processing industries also use large amounts of steam for drying. Dryers can be indirect or direct. Indirect dryers remove moisture thermally as energy is transferred from condensing steam, flue gases, or high temperature process fluid to the product being dried. Common indirect dryer types are coil and rotating drum. Direct dryers use hot gases that have been heated with steam or flue gases to directly contact and dry a product.

Dryers, like evaporators, can be arranged in multiple-stage configurations. Multiple-stage steam dryers use a cascading set of steam pressures, allowing steam released from an upstream stage to supply steam to the next stage. In many multiple-stage dryers, thermocompressors are used to increase the steam pressure of downstream-effect stages.

◆ **Evaporators**

Evaporators reduce the water content of a liquid, generally by heating it with steam in order to concentrate the product. Evaporators are used extensively in industries such as food processing, chemical manufacturing, steel, forest products, and textiles.

In most cases, evaporators are shell and tube heat exchangers with the steam on the shell side and the product being concentrated in the tubes. Evaporators can be single effect or multiple effect. A single effect evaporator uses steam at one set of pressure and temperature conditions to boil off the vapor from a product. Multiple-effect evaporators take the vapor produced from one evaporator and use it to heat the product in a lower-pressure evaporator. Multiple-effect evaporators are generally more efficient at concentrating a fluid than single-effect evaporators.

◆ **Heat Exchangers**

Heat exchangers transfer thermal energy from one fluid to another. In manufacturing facilities, steam is a common source of heat for many reasons, some of which are discussed in the Introduction. There is a wide range of heat exchanger designs that use steam, largely due to the wide range of products that are heated with steam. Many process and product considerations must be incorporated into the selection of a heat exchanger. Some basic heat exchanger types are discussed below, including:

- Tubular;
- Plate and frame;
- Jacketed; and
- Coil.

Tubular Heat Exchanger. Tubular heat exchangers are tube bundles that are surrounded by the heated or heating medium. This type of heat exchanger includes finned tube and shell and tube designs as shown in Figure 9. Finned tube heat exchangers are often used to heat air for drying and space heating applications. Shell and tube heat exchangers are often used for liquid heating and evaporation. Since the tube side of shell and tube heat exchangers can be designed to withstand high pressures, sometimes exceeding 1,500 psig, heat exchangers of this type are often used in high temperature and high-pressure applications.

Plate and Frame Heat Exchanger. In plate and frame heat exchangers, the two heat exchange fluids are separated by plates. The plates are corrugated, or ridged, as shown in Figure 10, to increase the surface area available for heat transfer. Plate and frame heat exchangers are often used in low-viscosity applications, where the risk of clogging is less severe. The plate ends are typically sealed by gasketed covers that can be removed to allow disassembly and cleaning. This heat exchanger type is used when temperatures and pressures are moderately low, typically below 300°F and 370 psi. Plate and frame heat exchangers also have a common design variation that has the plates welded or brazed together. This allows higher temperature service but eliminates the possibility of mechanical cleaning.

¹² Giese & Associates, *Scoping Study of the Pulp and Paper Industry*, EPRI, 1988.

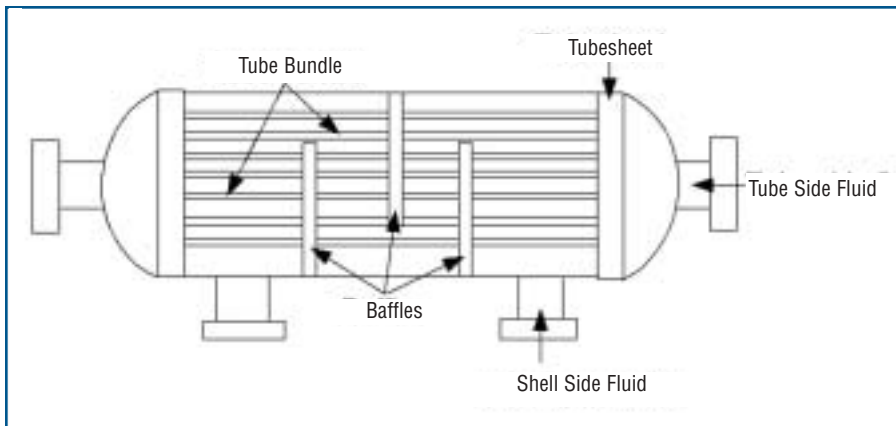

Figure 9. Shell and Tube Heat Exchanger

drawn from a fractionating tower. These volatile components are sent downstream for further processing. The residual components are sent back into the fractionating tower or sent on to a vacuum distillation process. There are several types of reboilers, including jacketed kettle, kettle, internal reboiler, and thermosyphon reboiler. These designs differ from one another in the way the product is heated with steam.

Jacketed Heat Exchangers. Jacketed heat exchangers use an enclosure to surround the vessel that contains the heated product. A common example of a jacketed heat exchanger is the jacketed kettle. A representation of a jacketed heat exchanger is shown in Figure 11. Jacketed heat exchangers are practical for batch processes and for product types that tend to foul or clog tube bundles or coils.

Coil Heat Exchangers. Coil heat exchangers characteristically use a set of coils immersed in the medium that is being heated. Coil heat exchangers are generally compact, offering a large heat transfer area for the size of the heat exchanger.

◆ **Reboilers**

Reboilers are typically used in distilling processes to increase component separation. Reboilers use heat, often provided by steam, to evaporate the volatile components of a product that has been

◆ **Reformers**

Steam reformers are used to generate hydrogen, typically from a hydrocarbon feedstock such as methane (the largest component of natural gas). In turn, hydrogen is used in many petroleum refining and chemical manufacturing processes. Reformers use steam for both energy and as a source of hydrogen. Steam is injected with the hydrocarbon feedstock to initiate the following reaction:

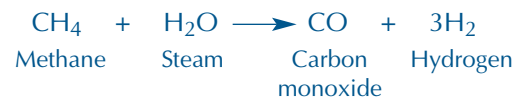

Reformers often have secondary stages that are used to convert the carbon monoxide to carbon dioxide and additional hydrogen. Although large amounts of steam are used throughout the reforming processes, steam is also generated by the reformers and is sometimes exported for other uses.

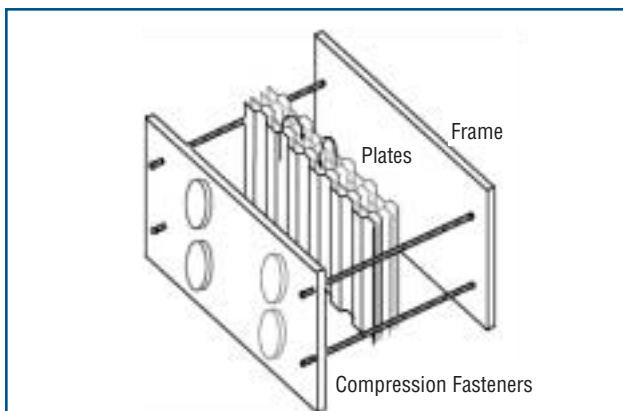

Figure 10. Components of a Plate and Frame Heat Exchanger

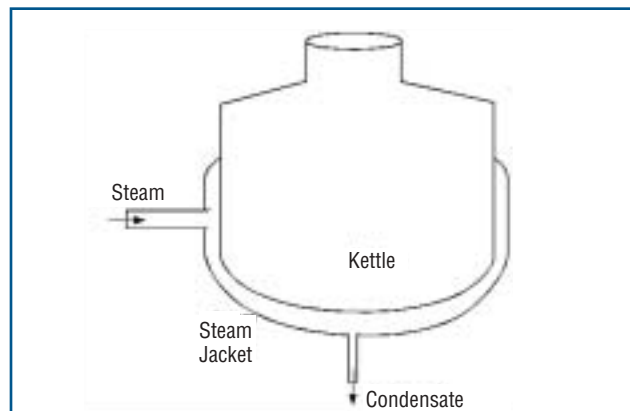

Figure 11. Configuration of a Jacketed Kettle Heat Exchanger

◆ **Steam Ejectors**

Steam ejectors use steam flow through a nozzle to create a vacuum (similar in operation to thermo-compressors). They are used in several different types of system applications and process equipment. Low-pressure conditions promote the evaporation of liquids at reduced temperatures. Consequently, many chemical manufacturing processes use steam ejectors to increase the concentration of a product. In petroleum refining, steam ejectors are commonly used in the vacuum distillation of heavy hydrocarbon products. Steam ejectors are also used to initiate and maintain vacuum conditions in the condensers of condensing turbines.

◆ **Steam Injectors**

Steam injectors are used to inject steam directly into a tank or a pipe containing a process fluid, generally for heating purposes. Many injector types use a nozzle and a diffuser to pull process fluid into the steam before the mixture is injected into the process fluid to promote an even distribution of heat. Important performance characteristics of injectors include accurate control of the amount of steam injected and effective mixing of the steam and process.

◆ **Steam Turbines**

Steam turbines are used to drive electric generators or other rotating machinery such as compressors, pumps, and fans. Steam turbines are used in many different system designs, depending on the relative requirements for steam, electricity, or other mechanical loads. Steam turbines provide an effective means of stepping down steam pressure while extracting mechanical work.

Additional information regarding steam turbines is available in Steam Tip Sheets Numbers 15 and 21 titled *Benchmark the Fuel Costs of Steam Generation and Consider Steam Turbine Drives for Rotating Equipment*, found in Appendix B.

Some turbines have interstage take-offs that allow steam to be extracted at various pressures before reaching the turbine exhaust. These extractions provide flexibility in meeting competing requirements of both the steam system and the mechanical load. For example, if the turbine is connected to an electric generator, adjusting the

amount of extracted steam can allow more or less electric power to be generated, while making respectively less or more steam available to the plant.

Backpressure Turbines. Backpressure turbines exhaust steam at pressures that are higher than atmospheric, and the exhaust steam is then used for other services. By extracting mechanical work from steam, backpressure turbines can provide an efficient means of supplying lower-pressure steam from a high-pressure header.

Condensing Turbines. Condensing turbines exhaust steam to vacuum (sub-atmospheric) conditions. This steam is condensed in a heat exchanger, referred to as a condenser, and transferred to the condensate return system. Condensing turbines typically require a source of cooling water to condense the steam.

◆ **Strippers**

Steam strippers are used to remove contaminants from a solution. Strippers are commonly found in petroleum refining and chemical manufacturing applications, where process solutions contain components that have different boiling points and removal of one or more of the components is necessary. Injecting steam into the process solution lowers the partial pressure of volatile components, allowing some of them to vaporize and get transported away with the steam. Steam can also raise the temperature of the mixture, lowering the solubility of the objectionable material and causing it to strip off with the steam. Often, the steam and the contaminants are condensed and separated, allowing recovery of the condensate and disposal or further processing of the contaminant.

◆ **Thermocompressors**

Thermocompressors combine high-pressure and low-pressure steam to form an intermediate-pressure steam supply. (See Figure 12.) Often the low-pressure steam does not have enough energy to be feasibly used; however, discharging it to the condensate return system can be an unnecessary energy loss. Thermocompressors use a high-pressure steam source to recover the energy from this low-pressure source, providing an intermediate steam supply that can be feasibly used.

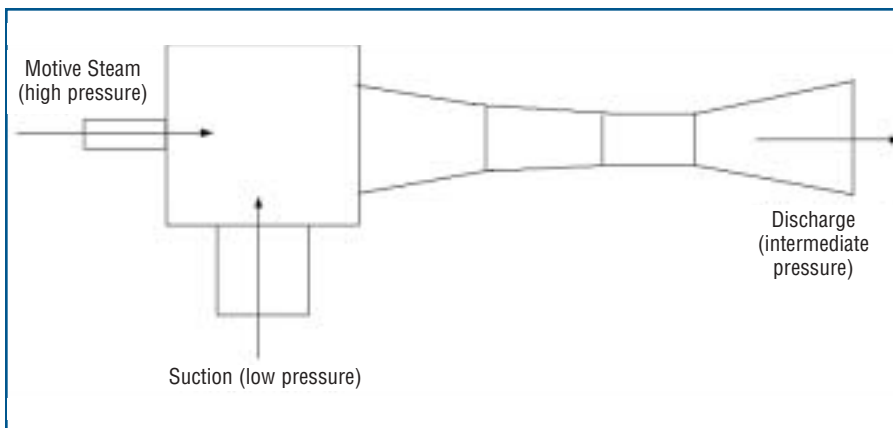

Figure 12. Thermocompressor Operation

increasing the risk of corrosion by condensate. Vacuum breakers are pressure-controlled devices that essentially vent a heat exchanger or system branch in which a vacuum has formed. By allowing in air when they open, vacuum breakers restore pressure and allow the condensate to drain.

◆ **Air Vents**

Before startup, the steam system contains air that must be removed. The presence of air in

a steam system reduces heat transfer effectiveness and promotes condensate corrosion. Air vents remove this air. Air vents are often thermostatic devices, similar to thermostatic steam traps that rely on the temperature difference between air and steam. When exposed to the lower temperature air in the system side, the vent opens. As the higher temperature steam reaches the vent, it closes, preventing the escape of steam.

◆ **Conditioning and Control Equipment**

Conditioning equipment is generally used to improve the performance of, or to protect the end-use equipment. For example, desuperheaters are often used to control the energy of a steam supply to end-use equipment to reduce the risk of damage to the equipment or to effectively improve temperature control of the process.

◆ **Desuperheaters**

The purpose of a desuperheater is to remove the superheat from steam. The majority of heating and process equipment performs more efficiently using saturated rather than superheated steam. Desuperheaters inject a very fine mist of high-purity water, such as condensate, into the steam flow. The superheated vapor gives up heat to the water mist, and by doing so, reduces its temperature.

◆ **Vacuum Breakers**

Vacuum conditions can develop in a steam system when steam flow into a component or a branch is throttled or shut off. If the rate of downstream steam use exceeds the steam supply, the pressure decreases and vacuum conditions can form. Vacuum conditions also result when the load on the heat exchanger is significantly less than the heat exchanger capacity. If the pressure in the heat exchanger drops too far, the condensate will not drain from the trap due to a higher pressure on the trap's downstream side. If uncorrected, the condensate level will rise in the heat exchanger, reducing the available heat transfer area and

◆ **Traps**

Steam traps are important to the performance of end-use equipment. Traps provide for condensate removal with little or no steam loss. If the traps do not function properly, excess steam will flow through the end-use device or the condensate will back up into it. Excess steam loss will lead to costly operation while condensate backup will promote poor performance and may lead to water hammer. Traps can also remove noncondensable gases that reduce heat exchanger effectiveness. There are several different types of steam traps, which are discussed in the Distribution section of this Sourcebook.

◆ **Insulation**

End-use equipment, such as heat exchangers and turbines, should generally be insulated due to the significant heat loss that the surface areas of this equipment can provide. The various types of insulation are discussed in the Distribution section of this Sourcebook. Where end-use equipment requires frequent inspection or maintenance, removable insulation should be considered.

◆ Additional Equipment

The additional equipment category refers to end uses throughout industry, which, though still significant users of steam, generally account for less steam energy than the key IOF end uses.

◆ Absorption Chillers

Absorption chillers provide cooling using an interesting variation of the vapor compression cycle. Instead of a compressor, which is generally used in chillers, absorption chillers exploit the ability of one substance to absorb a refrigerant at one temperature and then release it at another. In ammonia-based systems, water is the absorbent and ammonia is the refrigerant. In lithium bromide-based systems, lithium bromide is the absorbent, while water is the refrigerant.

An absorption chiller uses a pump instead of a compressor to increase refrigerant pressure. Once it is at the higher pressure, the absorbent/refrigerant solution is heated, often with steam, which releases the refrigerant. Although absorption chillers generally have lower coefficients of performance (COP) (indicating lower thermodynamic efficiency) than traditional chillers, they use less electric power per ton of cooling and are well suited for use with steam systems.

◆ Humidifiers

Humidifiers inject steam into an air or other gas source to increase its water vapor content. In humidification, steam is used as a source of both water and energy. Humidification applications are found in the chemical manufacturing industry where control of ambient temperature and moisture content are critical for product quality.

◆ Preheat/Reheat Air Handling Coils

Steam is often used in space heating applications to preheat and reheat air. In many HVAC systems, the conditioned air must have both its temperature and humidity adjusted. In preheat applications, steam is used to heat an air supply, which is typically a mixture of return air and outside air. The air is then conditioned to achieve a certain humidity and temperature. In reheat applications, the air is cooled to a particular dew point to remove water and achieve a desired humidity. As a result, before the air is delivered back to the

workspaces, steam coils must reheat the process air stream up to the proper temperature. In both reheat and preheat applications, finned tube heat exchangers are generally used.

◆ Tracing

In tracing applications, steam is used to maintain the temperature of a fluid in a pipe. A common application of tracing lines is to prevent the freezing of a process fluid in piping that runs outside of a temperature controlled area. Since tracing lines are exposed to freezing conditions, proper insulation, steam flow, and condensate drainage are essential to prevent freezing of the tracing lines as well as the process piping.

◆ Meters

Steam meters are used to measure steam flow, and are important for tracking the steam use of a particular part of a steam system or a particular end use. Discussion of different meter types is provided in the Steam Generation section of this Sourcebook.

Recovery

The recovery components of a steam system collect and return condensate back to the generation part of the system. Condensate recovery provides thermal and water treatment benefits. Condensate that is not returned must be compensated for by the addition of makeup water, which is generally much cooler than condensate. Condensate temperature often exceeds 200°F while makeup water temperature is typically between 50°F and 80°F. As a result, the enthalpy difference between condensate and makeup water is generally over 120 Btu/lb, an amount of energy that is often more than 10 percent of the energy in the boiler generated steam.

Additionally, makeup water is generally treated with chemicals that remove minerals and establish certain pH levels in the boiler water and in the system. Reducing the amount of makeup water added to the system reduces chemical use. Additionally, some of the treatment chemicals that are contained in condensate are problematic to a plant's wastewater treatment facility.

Industrial steam plants often extend across large areas. Recovering condensate from steam systems requires piping, collecting tanks, pumping equipment, and, in many cases, flash steam separators, meters, and filtration/cleanup equipment. However, the cost savings available from avoiding the purchase, treatment, and heating of makeup water often make investments in condensate recovery systems highly feasible.

For more information on condensate recovery, see the Steam Tip Sheet Number 8 titled *Return Condensate to the Boiler*, provided in Appendix B.

◆ Condensate Return Piping

Condensate return piping transports condensate as it drains from distribution and end-use equipment piping back to the boiler. Condensate piping should be adequately sized and insulated. Although the installation of larger pipe diameters is more expensive, larger pipes create less pressure drop for a given flow rate; this reduces the load on the condensate pumps. Larger pipe diameters also reduce the noise associated with condensate flow and are more suitable for carrying flash steam. Insulating the condensate piping helps to retain the thermal energy that provides much of the benefits of a condensate recovery system.

◆ Insulation

Insulation provides energy savings and safety benefits. In terms of energy savings, insulation reduces heat loss from the condensate piping and recovery equipment surfaces, which can make the surrounding work environment more comfortable. Reducing this heat loss can also reduce the burden on the cooling systems that support surrounding workspaces. In terms of safety, insulation reduces the outer surface temperature of the piping, which lessens the risk of burns. Important insulation properties and characteristics of piping insulation are discussed in the Distribution section of this Sourcebook.

◆ Condensate Receiver Tanks

Condensate receiver tanks collect and store condensate. These tanks are usually located remotely around the condensate system and are configured in conjunction with condensate pumps, as shown in Figure 13. Condensate flows can be highly variable due to changes in steam demand,

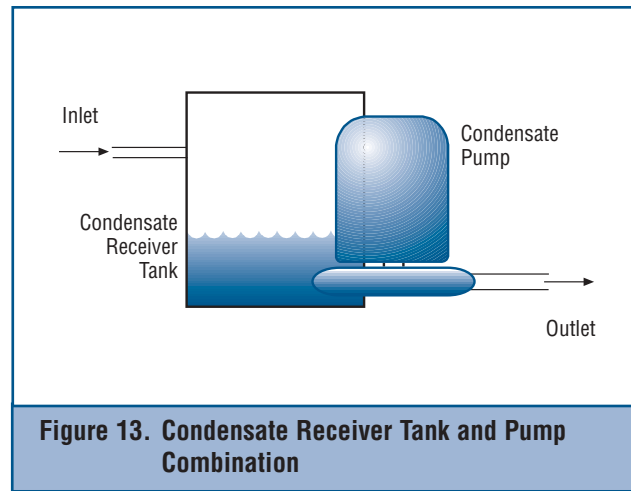

Figure 13. Condensate Receiver Tank and Pump Combination

especially during system startups. Receiver tanks minimize the effects of this flow variability on condensate pumps by providing storage, which maintains a minimum water level that prevents downstream condensate pumps from running dry. Since many condensate pumps are centrifugal types, it is important to keep a certain suction pressure to prevent cavitation damage. By maintaining a minimum condensate level, receiver tanks provide enough static pressure to avoid cavitation.

Most systems also contain a large condensate receiver tank that collects all the condensate returned from the system. This tank may also be used to store pretreated water.

◆ Condensate Pumps

Condensate pumps move condensate from receiver tanks back to the boiler room. Condensate pumps can be driven by electric motors, steam, or compressed air, depending on the availability of these sources. Motor-driven condensate pumps are usually centrifugal type pumps. In many cases, receiver tanks and motor driven pumps are packaged together and equipped with a control system that de-energizes the pump under low water level conditions. Steam or compressed air powered condensate pumps are used where electrical pumps would not be suitable, and are generally pressure powered pumps.

Condensate pumps also can be important to the performance of end-use equipment. Effective use of condensate pumps can eliminate condensate back up into end-use equipment, improving process

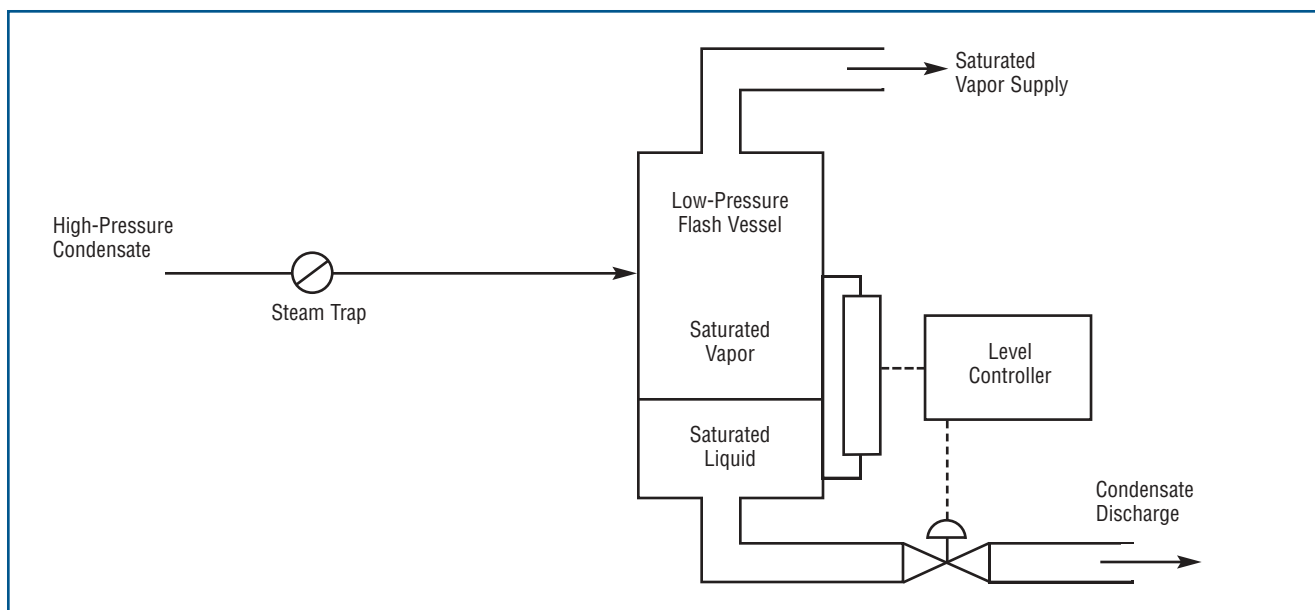

Figure 14. Flash Steam Recovery Vessel

control and reducing potential equipment problems from condensate acidification and water hammer.

◆ Flash Steam Vessels

Flash steam vessels allow the recovery of steam from condensate lines as illustrated in Figure 14. By removing steam from the condensate system, flash steam vessels provide an efficient source of steam to low-pressure end uses. For example, 250°F condensate has a saturation pressure of about 15 psig. Consequently, steam that is separated by flash steam vessels can be used in low-pressure steam applications such as space heating and preheating.

For more information on flash steam vessels, see the Steam Tip Sheet Number 12 titled *Flash High-Pressure Condensate to Regenerate Low-Pressure Steam* provided in Appendix B.

◆ Condensate Meters

Condensate meters measure the flow rate of condensate in the return system. Knowing the condensate flow rate can be helpful in monitoring the condensate system and the condition of steam traps. Condensate meters are often inline rotary types, relying on turbine or scroll rotation to measure flow rate.

◆ Filtration/Cleanup Equipment

In many systems, the flow of steam and condensate picks up rust, scale, and trace contaminants that are either carried over from the boiler or that form in carbon steel piping and on copper alloy heat exchange surfaces. Although strainers and filters are used to catch the particulate matter, some contaminants are dissolved in the condensate and can cause problems if returned to the boiler. In systems that require a high level of cleanliness, condensate polishers are used. Condensate polishers use ion exchange to remove these contaminants, preventing the redeposition of these contaminants on boiler surfaces.

Section 2: Performance Improvement Opportunities

Overview

This section of the Sourcebook discusses important factors that should be considered when industrial facilities seek to improve steam system performance and to lower operating costs. Improving steam system performance requires assessing the entire system, identifying opportunities, and selecting and implementing the most feasible projects. In turn, this requires a systems approach. Similarly, proper selection of the best projects requires quantifying the benefits and costs of each project. Successful implementation of these projects requires the participation of all system stakeholders including production, maintenance, and management. Generally, obtaining management participation requires communication of the analyses in economic terms. To address these considerations, this section of the Sourcebook discusses:

- The systems approach;
- Common performance improvement opportunities;
- Resources that can assist to identify and assess opportunities; and
- The economics related to steam system improvements.

Systems Approach

Because of the many industrial uses for steam, there are wide ranges of steam system sizes, configurations, end-use applications, and operating practices. As a result, there are many different ways to improve steam system performance and to identify improvement opportunities. In general, performance is most effectively optimized when a systems approach is used.

A systems approach analyzes both the supply and demand sides of the system and how they interact, essentially shifting the focus from individual components to total system performance. Often,

operators are so focused on the immediate demands of the equipment that they overlook the broader issue of how system parameters affect the equipment. Similarly, a common engineering approach is to break a system down into its basic components or modules, optimize the selection or the design of these components, and then assemble these components to form the system. An advantage to this approach is that it simplifies problems. However, a disadvantage is that it often overlooks the interaction of these components. In contrast, a systems approach evaluates the entire system to determine how the end-use requirements can be most effectively and efficiently served.

A systems approach also recognizes that system efficiency, system reliability, and performance are closely related. For example, an efficiency loss such as heat loss across uninsulated pipe surfaces reduces energy available to the end uses and requires boilers to work harder to meet a given demand. Often, energy losses create additional system stresses that accelerate wear and that can create loads for which the system was not originally designed.

Common Performance Improvement Opportunities

Several steam system improvement opportunities are common to many industrial facilities. These opportunities can be categorized according to the part of the system in which they are implemented. Common performance opportunities for the generation, distribution, and recovery areas of a steam system are listed in Table 2.

◆ End-Use Improvement Opportunities

There are many ways to optimize steam use, depending on the process and the equipment. Specific End Uses for Industries of the Future (IOF) steam systems can be found in Table 1 of the End Use section. In some cases, equipment can be

Table 2. Common Performance Improvement Opportunities for the Generation, Distribution, and Recovery Parts of Industrial Steam Systems

Opportunity	Description
Generation	
Minimize excess air	Reduces the amount of heat lost up the stack, allowing more of the fuel energy to be transferred to the steam
Clean boiler heat transfer surfaces	Promotes effective heat transfer from the combustion gases to the steam
Install heat recovery equipment (feedwater economizers and/or combustion air preheaters)	Recovers available heat from exhaust gases and transfers it back into the system by preheating feedwater or combustion air
Improve water treatment to minimize boiler blowdown	Reduces the amount of total dissolved solids in the boiler water, which allows less blowdown and therefore less energy loss
Recover energy from boiler blowdown	Transfers the available energy in a blowdown stream back into the system, thereby reducing energy loss
Add/restore boiler refractory	Reduces heat loss from the boiler and restores boiler efficiency
Optimize deaerator vent rate	Minimizes avoidable loss of steam
Distribution	
Repair steam leaks	Minimizes avoidable loss of steam
Minimize vented steam	Minimizes avoidable loss of steam
Ensure that steam system piping, valves, fittings, and vessels are well insulated	Reduces energy loss from piping and equipment surfaces
Implement an effective steam-trap maintenance program	Reduces passage of live steam into condensate system and promotes efficient operation of end-use heat transfer equipment
Isolate steam from unused lines	Minimizes avoidable loss of steam and reduces energy loss from piping and equipment surfaces
Utilize backpressure turbines instead of PRVs	Provides a more efficient method of reducing steam pressure for low-pressure services
Recovery	
Optimize condensate recovery	Recovers the thermal energy in the condensate and reduces the amount of makeup water added to the system, saving energy and chemicals treatment
Use high-pressure condensate to make low-pressure steam	Exploits the available energy in the returning condensate

installed to make the process more efficient; for example, multiple-stage dryers are often more efficient than single-stage dryers. However, in general, optimizing the efficiency of steam-supplied end uses requires a case-by-case assessment.

BestPractices Steam System Performance Tools

The U. S. Department of Energy (DOE) BestPractices Steam effort has developed several resources and tools that can be used to identify and assess steam system improvement opportunities. These resources

and tools are described in this section of the Sourcebook. Additional steam improvement resources and tools are identified in the Resources section of the Sourcebook.

◆ Steam System Scoping Tool

The Steam System Scoping Tool is a spreadsheet program that can assist steam operation and management personnel to assess their steam systems. The program is intended for use by steam system energy managers and operations personnel in industrial plants. This tool also helps assess steam system operations against identified best practices.

The Steam System Scoping Tool contains seven worksheets:

1. Introduction—provides instructions on how to use the guide and what is indicated by the results.
2. Basic data—prompts the user to answer general questions such as the amount of fuel used, amount of steam generated, and other general system data.
3. System profiling—assesses how the user tracks steam costs, benchmarks steam use, and measures important general operating parameters.
4. Operating practices of the total system—queries the user regarding practices such as trap maintenance, water treatment, insulation condition, leak repair, and general equipment inspection.
5. Operating practices of the boiler plant—queries the user on boiler efficiency, heat recovery equipment, steam quality, and general boiler operation.
6. Operating practices of the distribution, end-use, and recovery portions of the steam system—queries the user about the use of pressure reducing valves, condensate recovery, and the use of condensate to generate low-pressure steam.
7. Summary sheet—provides scores based on user responses.

◆ Steam System Survey Guide

The *Steam System Survey Guide* is a reference document that is intended for use by plant energy managers and system operations personnel. The Survey Guide provides a technical basis for identifying and assessing many potential steam system improvement opportunities. Although several of these opportunities can be identified directly with the survey guide, others require more sophisticated measurements and data gathering methods.

The Scoping Tool and the Survey Guide are complementary. The Scoping Tool allows a user to determine how well the system is performing and is also useful in tracking the effectiveness of system improvements. The Survey Guide provides a more quantitative description of the system operation and how to quantify some of the potential steam

system improvement opportunities. These tools are available from DOE's Office of Industrial Technologies (OIT) BestPractices Web site at www.oit.doe.gov/bestpractices. The Web site also offers links to other resources that can assist end users in improving the performance and efficiency of their energy-intensive utility systems.

◆ 3E Plus Insulation Appraisal Software

Because insulation is used in every steam system, its restoration, replacement, or installation are common improvement opportunities. A lack of awareness regarding the energy losses and the associated costs often results in a low prioritization of restoring or properly installing insulation on steam system surfaces. As a result, a software program known as 3E Plus was developed by the North American Insulation Manufacturers Association (NAIMA). The program increases awareness among steam system operations and management personnel of the benefits of insulation and assists these stakeholders in assessing insulation opportunities.

3E Plus assists the user in assessing important insulation project factors such as energy savings, installation cost, and payback period for various insulation materials and thicknesses. Users of 3E Plus can estimate energy losses from uninsulated surfaces as well as potential savings from various insulation options.

The program has general data for insulation costs by type and can analyze insulation cross-sections that use several different insulation types. It also accounts for labor rates and productivity by region, estimating how difficult the installation process will be based on general piping characteristics. Users can quickly determine the economic feasibility of various insulation thicknesses. Since the program also allows the user to evaluate various combinations of insulation types, 3E Plus can help the user optimize the material thicknesses within an insulation system. Download 3E Plus from the BestPractices Web site at www.oit.doe.gov/bestpractices.

◆ NIA's Insulation Appraisal Program

The National Insulation Association (NIA), an OIT Allied Partner, has developed a training program

that offers certification to professionals who conduct insulation appraisals or specify insulation requirements. This program is intended to provide credibility to insulation professionals and to increase consistency of the message that is presented to clients. This program has four key components:

- **Awareness Building**—an important way to increase awareness of the potential cost savings from insulation projects is to effectively promote insulation appraisal as a professional service.
- **Information Gathering**—determining the parts of the system that have the most attractive insulation improvement opportunities usually requires input from the plant personnel. Improving the interview techniques of insulation professionals can increase the usefulness of these assessments.
- **3E Plus**—the 3E Plus program is an important tool for insulation professionals and specifying engineers. Learning to effectively use this tool can improve the quality of the assessment findings, presentation of recommendations, and cost-effective specification of new insulation.
- **Reporting**—accurately and effectively reporting the results of an insulation assessment can significantly increase the probability that the recommendations will be implemented.

Information regarding the Insulation Energy Appraisal Program (IEAP) can be obtained from the NIA, 99 Canal Center Plaza, Suite 222, Alexandria, VA 22314, or from their Web site at www.insulation.org.

◆ Steam Tip Sheets

Some improvement opportunities are available to many different systems. To increase industry awareness of several fundamental improvement opportunities, OIT has developed steam tip sheets through its BestPractices Program.

These steam tip sheets provide concise descriptions of common improvement opportunities. Because BestPractices continues to develop and identify energy improvement programs, additional steam tip sheets are expected. Steam tip sheets available by this Sourcebook's publication date can be found in Appendix B. Additionally, steam tip sheets can be found on the BestPractices Steam Web site at www.oit.doe.gov/bestpractices/steam.

Overview of Financing Steam System Improvements

Very often, industrial facility managers must convince upper management that an investment in steam efficiency is worth the effort. The communication of this message can often be more difficult than the actual engineering behind the concept. The corporate audience will respond more readily to an economic impact than to a discussion of Btu, pounds of steam, and efficiency ratios. By adopting a financial approach, the facility manager relates steam efficiency to corporate goals. Collaboration with financial staff can yield the kind of proposal that is needed to convince corporate officers who have the final word about capital investments such as steam system upgrades.

Before laying out some recommendations for how to justify steam improvement projects, it is useful to understand the world as the corporate office usually sees it.

◆ Understanding Corporate Priorities

Corporate officers are held accountable to a chief executive, a board of directors, and an owner (or shareholders, if the firm is publicly held). It is the job of these officers to create and grow the equity value of the firm. The corporation's industrial facilities do so by generating revenue that exceeds the cost of owning and operating the facility itself. Plant equipment—including steam system components—are assets that must generate an economic return. The annual earnings attributable to the sale of goods produced by these assets, divided by the value of the plant assets themselves, describe the rate of return on assets. This is a key measure by which corporate decision-makers are held accountable.

Financial officers seek investments that are most certain to demonstrate a favorable return on assets. When faced with multiple investment opportunities, the officers will favor those options that lead to both the largest and fastest returns.

This corporate attitude may impose (sometimes unpleasant) priorities on the facility manager: assure reliability in production, avoid unwanted

surprises by sticking with familiar technology and practices, and contribute to cost control today by cutting a few corners in maintenance and upkeep. This may result in industrial decision-makers concluding that steam efficiency is a “luxury” that cannot be afforded.

Fortunately, our story does not end here. What follows is a discussion of ways that industrial steam efficiency can save money and contribute to corporate goals while effectively reducing energy consumption and cutting noxious combustion emissions.

◆ **Measuring the Dollar Impact of Steam Efficiency**

Steam efficiency improvements can move to the top of the list of corporate priorities if the proposals respond to distinct corporate needs. Corporate challenges are many and varied, which in turn opens up more opportunities to “sell” steam efficiency as a solution. Steam systems offer many opportunities for improvement; the particulars are shared elsewhere in this Sourcebook. Once the selections are made, the task is one of communicating the proposals in corporate financial language.

The first step is to identify and enumerate the total dollar impact of a steam efficiency measure. One framework for this is known as “life-cycle cost analysis.” These analyses capture the sum total of expenses and benefits associated with an investment. The result—a net gain or loss on balance—can be compared to other investment options or to the anticipated outcome if no investment is made. As a comprehensive accounting of an investment option, the life-cycle cost analysis for a steam efficiency measure would include projections of:

- Search and selection costs for seeking an engineering implementation firm;
- Initial capital costs, including asset purchase, installation, and costs of borrowing;
- Maintenance costs;
- Supply and consumable costs;
- Energy costs over the economic life of the implementation;
- Depreciation and tax impacts;

- Scrap value or cost of disposal at the end of the equipment’s economic life; and
- Impacts on production such as product quality and downtime.

One revelation that typically emerges from this exercise is that fuel costs may represent as much as 96 percent of life-cycle costs, while the initial capital outlay is only 3 percent, and maintenance a mere one percent. These findings may be true for boilers with a 20-year life operating at high rates of capacity utilization. Clearly, any measure that reduces fuel consumption (while not impacting reliability and productivity) will certainly yield positive financial impacts for the company.

◆ **Financing Steam Efficiency Improvements**

As with any corporate investment, there are many ways to measure the financial impact of steam efficiency investments. Some methods are more complex than others are, and proposals may use several analytical methods side-by-side. The choice of analyses used will depend on the sophistication of the presenter and the audience.

A simple and widely used measure of project economics is the payback period. This is defined as the period of time required for a project to “break even.” It is the time needed for the net benefits of an investment to accrue to the point where they equal the cost of the initial outlay. For a project that returns benefits in consistent, annual increments, the simple payback equals the initial investment divided by the annual benefit. Simple payback does not take into account the time value of money; in other words, it makes no distinction between a dollar earned today versus a dollar of future (and therefore uncertain) earnings. Still, the measure is easy to use and understand and many companies use simple payback for a quick “go/no-go” decision on a project. Five important factors to remember when calculating a simple payback:

- It is an approximation, not an exact economic analysis;
- All benefits are measured without considering their timing;
- All economic consequences beyond the payback are ignored;

- Payback calculations will not always find the best solution (for the two reasons immediately above) when choosing among several project options; and
- Payback does not consider the time value of money or tax consequences.

More sophisticated analyses take into account factors such as discount rates, tax impacts, the cost of capital, etc. One approach involves calculating the net present value of a project, which is defined in the equation below:

$$\text{Net present value} = \text{Present worth of benefits} - \text{Present worth of costs}$$

Another commonly used calculation for determining economic feasibility of a project is internal rate of return, which is defined as the discount rate that equates future net benefits (cash) to an initial investment outlay. This discount rate can be compared to the interest rate at which a corporation borrows capital.

Many companies set a threshold (or hurdle) rate for projects, which is the minimum required internal rate of return for a project to be considered viable. Future benefits are discounted at the threshold rate, and the net present worth of the project must be positive in order for the project to be a “go.”

◆ Relating Steam Efficiency to Corporate Priorities

Saving money, in and of itself, should be a strong incentive for adopting steam efficiency. Still, that may not be enough for some corporate observers. The facility manager’s case can be strengthened by relating a positive life-cycle cost outcome to specific corporate needs. Some suggestions for interpreting the benefits of fuel cost savings include the following (finance staff can suggest which of these approaches are best for the current corporate climate):

- **A new source of permanent capital.** Reduced fuel expenditures—the direct benefit of steam efficiency—can be thought of as a new source of capital for the corporation. The investment that makes this efficiency possible will yield annual savings each year over the economic life of the improved steam system. Regardless of how

the steam efficiency investment is financed—borrowing, retained earnings, or third party financing—the annual savings will be a permanent source of funds as long as the steam efficiency savings are maintained on a continuous basis.

- **Added shareholder value.** Publicly held corporations usually embrace opportunities to enhance shareholder value. Steam efficiency can be an effective way to capture new value. Shareholder value is the product of two variables: annual earnings and the price-to-earnings (P/E) ratio. The P/E ratio describes the corporation’s stock value as the current stock price divided by the most recent annual earnings per share. To take advantage of this measure, the steam efficiency proposal should first identify annual savings (or rather, addition to earnings) that the proposal will generate. Multiplying that earnings increment by the P/E ratio yields the total new shareholder value attributable to the steam efficiency implementation.
- **Reduced cost of environmental compliance.** Facility managers can proactively seek to limit the corporation’s exposure to penalties related to environmental emissions compliance. Steam efficiency, as total-system discipline, leads to better monitoring and control of fuel use. Combustion emissions are directly related to fuel consumption: they rise and fall in tandem. By implementing steam efficiency, the corporation enjoys two benefits: decreased fuel expenditures per unit of production, and fewer incidences of emission-related penalties.
- **Improved worker comfort and safety.** Steam system optimization requires ongoing monitoring and maintenance that yields safety and comfort benefits in addition to fuel savings. The routine involved in system monitoring will usually identify operational abnormalities before they present a danger to plant personnel. Containing these dangers precludes threats to life, health, and property.
- **Improved reliability and capacity utilization.** Another benefit to be derived from steam efficiency is more productive use of steam assets. The efforts required to achieve and maintain energy efficiency will largely contribute to operating efficiency. By ensuring the integrity of steam system assets, the facility manager can

promise more reliable plant operations. The flip side, from the corporate perspective, is a greater rate of return on assets employed in the plant.

◆ **Call to Action**

A proposal for steam efficiency implementation can be made attractive to corporate decision-makers if the facility manager:

- Identifies opportunities for achieving steam efficiency;
- Determines the life-cycle cost of attaining each option;
- Identifies the option(s) with the greatest net benefits;
- Collaborates with financial staff to identify current corporate priorities (for example, added shareholder value, reduction of environmental compliance costs, and improved capacity utilization); and
- Generates a proposal that demonstrates how the steam efficiency project's benefits will directly respond to current corporate needs.

◆ **Summary**

Increased awareness of the potential improvements in steam system efficiency and performance is an important step toward increasing the competitive capabilities of energy-intensive industries. Some of the useful steam resources and tools developed by BestPractices have been described in this section. Additional steam resources and tools and where to obtain them are described in the Resources and Tools section of this Sourcebook.

Section 3: Programs, Contacts, and Resources

This portion of the Sourcebook lists resources that can help end users increase the cost-effective performance of steam systems. The section is organized into three sections, described below:

◆ Programs

This section describes the U.S. Department of Energy's Office of Industrial Technologies (OIT) BestPractices Program, a national effort aimed at improving the performance of industrial steam systems. This section provides a list of associations and other organizations involved in the steam system marketplace.

◆ Contacts

This section provides a list of associations and other organizations involved in the steam system marketplace.

◆ Resources

This section provides information on books and reports, other publications, government and commercial statistics and market forecasts, software, training courses, and other sources of information that can help end users make informed steam system equipment purchase and system design decisions.

OIT and BestPractices

◆ Overview

Industrial manufacturing consumes 36 percent of all energy used in the United States. OIT has programs to assist industry in achieving significant energy and process efficiencies. OIT develops and delivers advanced energy efficiency, renewable energy, and pollution prevention technologies and practices for industrial applications. Through an industry-driven initiative called the Industries of the Future, OIT works with the nation's most energy- and resource-intensive industries to develop

a vision of their future and roadmaps on how to achieve these visions over a 20-year timeframe. This collaborative process aligns industry goals with federal resources to accelerate research and development of advanced technologies identified as priorities by industry.

The advancement of energy- and process-efficient technologies is complemented by OIT's energy management best practices for immediate savings results. OIT's BestPractices assists the nine Industries of the Future—agriculture, aluminum, chemicals, forest products, glass, metal casting, mining, petroleum, and steel—to identify and realize their best energy efficiency and pollution prevention options from a system and life-cycle cost perspective. Through activities such as plant-wide energy assessments, implementation of emerging technologies, and energy management of industrial systems, BestPractices delivers energy solutions for industry that result in significant energy and cost savings, waste reduction, pollution prevention, and enhanced environmental performance.

◆ Plant Assessments

Depending on the industry, energy can account for 10 percent or more of total operating costs. Energy assessments identify opportunities for implementing new technologies and system improvements. Many recommendations from energy assessments have payback periods of less than 18 months and can result in significant energy savings.

- Plant-wide assessments help manufacturers develop comprehensive plant strategies to increase efficiency, reduce emissions, and boost productivity. Annual competitive solicitations offer a 50 percent cost share of up to \$100,000 in matching funds.
- Small- to medium-sized manufacturers can qualify for free assessments from the university-based Industrial Assessment Centers.

◆ Emerging Technologies

Emerging technologies are those that result from research and development and are ready for full-scale demonstration in real-use applications. OIT recognizes that companies may be reluctant to invest capital in these new technologies, even though they can provide significant energy and process improvements. However, through technology implementation solicitations, OIT helps mitigate the risk associated with using new technologies that are supported by IOF partnerships. By sharing implementation and providing third-party validation and verification of performance data, the energy, economic, and environmental benefits can be assessed to accelerate new technology to acceptance.

◆ Energy Management

OIT encourages manufacturers to adopt a comprehensive approach to energy use that includes assessing industrial systems and evaluating potential improvement opportunities. Efficiency gains in compressed air, motor, process heating, pumping, and steam systems can be significant and usually result in immediate energy and cost savings. OIT offers software tools and training in a variety of system areas to help industry become more energy and process efficient, reduce waste, and improve environmental performance.

◆ Allied Partnerships

Allied Partners are manufacturers, associations, industrial service and equipment providers, utilities, and other organizations that voluntarily work with OIT. Allied Partners seek to increase energy efficiency and productivity for those industries that participate in OIT's Industries of the Future strategy by participating in, endorsing, and promoting OIT programs, products, and services. Allied Partnerships help OIT achieve industrial energy efficiency goals by extending delivery channels through the partners' existing networks. In turn, partners realize benefits, such as achieving their own corporate, institutional, or plant goals and objectives by expanding services to customers and suppliers. Allied Partners also gain access to technical resources, such as software, technical publications, and training; and they can gain recognition as leaders in the implementation of energy-efficient technologies and practices. Allied

Partners who successfully complete training and a qualifying exam on the use of OIT software programs are recognized as Qualified Specialists. For more on Allied Partnerships, contact the OIT Clearinghouse at 800-862-2086.

◆ Technical Resources

OIT offers a variety of resources to help industry achieve increased energy and process efficiency, improved productivity, and greater competitiveness.

OIT Clearinghouse. The OIT Clearinghouse fields questions on OIT products and services including those focused on the Industries of the Future. They can also answer questions about industrial systems such as compressed air, motors, process heating, and steam. The OIT Clearinghouse can be the first stop in finding out what's available from OIT. Contact the Clearinghouse at 800-862-2086 or clearinghouse@ee.doe.gov.

OIT and BestPractices Web Sites. The OIT and BestPractices Web sites offer a large array of information, products, and resources to assist manufacturers who are interested in increasing the efficiency of their industrial operations. You can gain access to Web pages for the nine Industries of the Future, learn about upcoming events and solicitations and much more through the OIT site. Visit the OIT site at www.oit.doe.gov.

The BestPractices site offers case studies of companies that have successfully implemented energy efficient technologies and practices, software tools, tip sheets, training events, and solicitations for plant assessments. You can see these and other resources at www.oit.doe.gov/bestpractices.

Software Tools and Training. OIT and its partners have developed several software tools for systems improvements to help you make decisions about implementing efficient practices in your manufacturing facilities. Tools for assessing the efficiency of fan and process heating systems are in development and will be ready in late 2002. The following software tools are available from OIT:

- **AirMaster+** provides comprehensive information on assessing compressed air systems, including modeling, existing and future system upgrades,

and evaluating savings and effectiveness of energy efficiency measures.

- An energy-efficient motor selection and management tool, **MotorMaster+ 3.0** software includes a catalog of over 20,000 AC motors. Version 3.0 features motor inventory management tools, maintenance log tracking, efficiency analysis, savings evaluation, energy accounting, and environmental reporting capabilities.
- The **Pumping System Assessment Tool (PSAT)** helps industrial users assess the efficiency of pumping system operations. PSAT uses achievable pump performance data from Hydraulic Institute standards and motor performance data from the MotorMaster+ database to calculate potential energy and associated cost savings.
- **The Steam System Scoping Tool** is designed to help steam system energy managers and operations personnel for large industrial plants. This spreadsheet program will profile and grade steam system operations and management. This tool will help you to evaluate your steam system operations against identified best practices.
- With **3E Plus** software you can easily determine whether boiler systems can be optimized through the insulation of boiler steam lines. The program calculates the most economical thickness of industrial insulation for a variety of operating conditions. You can make calculations using the built-in thermal performance relationships of generic insulation materials or supply conductivity data for other materials.

Training sessions in industrial systems improvements using OIT software tools are offered periodically through Allied Partners. Visit the BestPractices Web site for more information: www.oit.doe.gov/bestpractices.

Newsletters. See page 37 to learn about the *Energy Matters* and *OIT Times* newsletters.

Directory of Contacts

Information on improving the performance of industrial energy systems is available from several resources. To improve the profitability of U.S. industry, OIT's BestPractices offers many resources for steam system management. These resources complement Industries of the Future technology development programs, which address other industrial systems, such as motor, compressed air, combined heat and power, and process heating, in addition to efforts by the Industrial Assessment Centers and Financing Assistance programs. Collectively, these efforts assist industry in adopting near-term and long-term energy-efficient practices and technologies. For assistance in these areas contact:

The U.S. Department of Energy Office of Industrial Technologies

OIT Clearinghouse
P.O. Box 43171
Olympia, WA 98504-3171
Phone: 800-862-2086
Fax: 360-586-8303
www.oit.doe.gov/bestpractices

For specific information regarding steam systems, including assistance in locating steam system specialists and equipment vendors, BestPractices Steam provides an excellent set of helpful resources. Together with industrial end users, equipment suppliers, and resource organizations, BestPractices Steam helps industry stay competitive and promotes the comprehensive upgrade of industrial steam systems.

Alliance to Save Energy

The Alliance to Save Energy
1200 18th Street, NW, Suite 900
Washington, DC 20036
Phone 202-857-0666
Fax 202-331-9588
www.ase.org

The Alliance to Save Energy is a nonprofit coalition of prominent business, government, environmental, and consumer leaders who promote the efficient and clean use of energy worldwide to benefit the environment, the economy, and national security.

American Boiler Manufacturers Association

4001 North 9th Street, Suite 226
Arlington, VA 22303-1900
Phone: 703-522-7350
Fax: 703-522-2665
www.abma.org

The American Boiler Manufacturers Association (ABMA) is a trade association of manufacturers of boilers, related fuel burning equipment, users of boiler and boiler-related equipment, and companies that provide products and services to the boiler industry.

Council of Industrial Boiler Operators

6035 Burke Centre Parkway, Suite 360
Burke, VA 22015
Phone: 703-250-9042
Fax: 703-239-9042
www.cibo.org

The Council of Industrial Boiler Operators (CIBO) provides information and advocacy to achieve solutions to industrial energy, environmental and legislative issues and policies. Objectives of CIBO include:

1. Information exchange among members, government and the public concerning policies, laws and regulations that affect industrial energy systems.
2. Technically sound, equitable, cost-effective laws and regulations.
3. Improved reliability and cost-effectiveness of industrial energy systems.

National Insulation Association

99 Canal Center Plaza, Suite 222
Alexandria, VA 22314
Phone: 703-683-6422
Fax: 703-549-4838
www.insulation.org

The National Insulation Association is a service organization that promotes the general welfare of the commercial and industrial insulation and asbestos abatement industries and works to improve the service to the general public performed by the commercial and industrial insulation and asbestos abatement industries.

North American Insulation Manufacturers Association

44 Canal Center Plaza, Suite 310
Alexandria, VA 22314
Phone: 703-684-0084
Fax: 703-684-0427
www.naima.org

North American Insulation Manufacturers Association (NAIMA) is a trade association of North American manufacturers of fiberglass, rock wool, and slag wool insulation products. NAIMA concentrates its efforts on promoting energy efficiency and environmental preservation through the use of fiber glass, rock wool, and slag wool insulation products, while encouraging safe production and use of these products.

STEAM-LIST

The STEAM-LIST is a discussion forum that promotes the exchange of information, problem solving, and discussion of steam generators, piping, and equipment. Included among the components and issues that are discussed are boilers, boiler feed pumps, water treatment, corrosion and scaling, valves, PRVs, traps, turbines, flow metering, heating coils, condensate pumps, district heating, and system modeling. This list is intended to promote practical discussions, rather than theoretical or academic discussions.

Subscription information can be obtained by contacting: listproc@lists.cc.utexas.edu.

Resources and Tools

A wide range of information is available on the application and use of steam systems. This section of the Sourcebook will focus on resources and tools as follows:

- Key DOE Resources
- Books
- Other Publications (Guides, Manuals, and Standards)
- Software
- Periodicals
- Reports and Technical Papers

- Training Courses and Technical Services
- Videos

Note: the description accompanying the following sources have generally been taken directly from the publisher/author/developer. Inclusion of these sources does not imply endorsement by the U.S. Department of Energy.

Key DOE Resources

Several other resources are available that describe current tools, technologies, and practices that can help improve steam system operating efficiency and performance. Many of these resources are intended to increase awareness of the benefits of energy improvement projects and to identify where the industry professional can go for more help.

◆ OIT Clearinghouse

The OIT Clearinghouse provides technical information for several industrial utility systems, including compressed air, motors, pumps, combined heat and power, process heating, and steam. The OIT Clearinghouse is staffed by engineers and technical experts who are trained to provide information about resources and tools that are available to industry. Call the Clearinghouse at 1-800-862-2086, or e-mail at clearinghouse@ee.doe.gov.

◆ Steaming Ahead

Steaming Ahead is a bimonthly e-mail newsletter published by the Alliance to Save Energy that describes the activities and information products of the BestPractices Steam effort. BestPractices Steam outreach and promotion is performed by the Alliance to Save Energy. *Steaming Ahead* promotes best-in-class practices and technology applications in steam system design and management. Additional information on *Steaming Ahead* can be found at www.steamingahead.org.

◆ Energy Matters

Energy Matters is a quarterly newsletter published by the Industrial Technologies Program that provides news, technical tips, and case studies. *Energy Matters* informs industrial end users of energy-efficiency opportunities, technical issues, new products and services, and events related to steam

systems and other industrial utilities such as motor and compressed air systems. To subscribe, contact the OIT Clearinghouse or subscribe online at www.oit.doe.gov/bestpractices/energymatters/.

◆ OIT Times

OIT Times is a quarterly newsletter full of information on the activities of the Industries of the Future and other OIT programs. Learn about upcoming events and solicitations, technology R&D awards, financial assistance, industry trends, and much more. To subscribe to the *OIT Times*, contact the OIT Clearinghouse or complete the online form at www.oit.doe.gov/news/oittimes.

◆ Steam Case Studies

Steam Case Studies provide practical examples of successful steam system improvement projects. Typically, these case studies describe how a facility assessed its steam system, then identified opportunities to improve its operation and/or performance and implemented one or more of these opportunities. Discussion of successful improvement projects can reduce the uncertainty associated with making steam system improvements. Case studies also increase awareness of the systems approach that is often an essential part of any successful performance or efficiency improvement.

Documented steam case studies are available from the BestPractices Web site at www.oit.doe.gov/bestpractices.

Books

Armstrong International, Inc.

816 Maple Street
 Three Rivers, MI 49093 USA
 616-273-1415
www.armintl.com

Handbook N101—Steam Conservation Guidelines for Condensate Drainage

Description: This Handbook summarizes general principles of installation and operation of steam traps. It also includes Recommendation Charts which summarize findings on which type of trap will give optimum performance in a given situation and why.

ASHRAE

1791 Tullie Circle, NE
Atlanta, GA 30329
www.ashrae.org

ASHRAE Handbook of HVAC Systems and Equipment, 2000

Description: Complete guide to steam systems design and equipment.

Association for Facilities Engineering

888-222-0155
www.afe.org

Boiler Plant and Distribution Optimization Manual

Description: Guide for boiler and plant operators to optimize the efficiency of their boilers and distribution systems.

Babcock and Wilcox

20 S. Van Buren Avenue
Barberton, OH, 44203-0351
800-BABCOCK
www.babcock.com

Steam: Its Generation and Use, 40th Edition

Description: This book is intended to help design, procure, construct, maintain, and/or operate equipment in a way that will provide reliable performance.

GE Betz

4636 Somerton Road
Trevose, PA 19053-6783
215-942-5350
www.gebetz.com

Handbook of Industrial Water Conditioning, 9th Edition

Prepared by: Betz Laboratories Inc.
Description: This handbook presents detailed information on external treatment: boiler and cooling water systems, air conditioning, refrigeration and total energy systems; chemical treatment feeding and control; and problems encountered in special industrial cases.

Boiler Efficiency Institute

Boiler Efficiency Institute
P.O. Box 2255
Auburn, AL 36831-2255
800-669-6948
www.boilerinstitute.com

Steam Efficiency Improvement

Description: An introductory text for establishing a program for reducing losses in the use of steam. The text is divided into three areas: steam transmission; steam consuming processes; and condensate return systems.

CANMET Energy Technology Centre

580 Booth Street
Ottawa, Ontario, Canada
K1A 0E4
613-943-0792

An Energy Efficiency and Environment Primer for Boilers and Heaters

Prepared by: Federal Industrial Boiler Program, CANMET Energy Technology Centre
Description: This guide is intended to provide a basic discussion of combustion processes, their emissions, and techniques for reducing energy consumption and environmental emissions.
ISBN: 0-7778-9536-6

Council of Industrial Boiler Operators

6035 Burke Centre Parkway, Suite 360
Burke, VA 22015
703-250-9042
www.cibo.org

Energy Efficiency Handbook

Description: The Energy Efficiency Handbook was prepared to help owners and operators to get the best and most energy-efficient performance out of their boiler systems. Some of the handbook chapters include Water Treatment, Boilers, Controls, Heat Recovery, Energy Auditing, and Steam Systems.

Energy Institute Press

Energy Institute Press
3969 Lantern Drive
Wheaton, MD 20902
888-280-2665

Energy Efficiency Manual

Author: Donald R. Wulfinghoff

Description: A comprehensive treatment of energy efficiency applications in industrial, commercial, and residential settings. Industrial boiler operators will be interested in Section 1, "Boiler Plant," which devotes 225 pages solely to steam systems. Dozens of tips are provided, each with an assessment of their potential for savings, rate of return, reliability, and ease of initiation. ISBN: 0965792676

The Fairmont Press

700 Indian Trail
Lilburn, GA 30047
770-925-9388
www.fairmontpress.com

Efficient Boiler Operations Source Book, Fourth Edition

Authors: F. William Payne and Richard E. Thompson

Description: Reviews the fundamentals of boiler combustion and the factors that affect boiler efficiency. This book is intended for operators and supervisors of boiler plants. ISBN: 01353226885

Energy Management Handbook

Author: Wayne C. Turner

Description: This book discusses steam and condensate systems, waste heat recovery, cogeneration, and industrial insulation. ISBN: 013728098X

Handbook of Energy Audits, Fourth Edition

Author: Albert Thumann

Description: Contains information on boilers, steam traps, insulation, and a chapter on computer software for energy audits. ISBN: 0-13-975202-1

Plant Engineer's and Manager's Guide to Energy Conservation, Seventh Edition

Author: Albert Thumann

Description: Contains information on: steam tracing; steam generation using waste heat recovery; steam trap maintenance; cogeneration; the transition from energy audits to industrial assessments; a review of industrial operations and maintenance energy measures; and an integrated approach to achieving energy cost savings at a corporate headquarters. ISBN: 0-13-020738-1

Stationary Engineering Handbook

Author: K. L. Petrocelli, SMA/CPE

Description: A book that discusses steam generation and water treatment from the operating engineer's perspective.

The Steam Trap Handbook

Author: James F. McCauley

Description: This book is intended for engineers and technicians to help them optimize the performance of their steam systems by focusing on steam traps. This book discusses proper selection and sizing, application, operation, and maintenance of steam traps.

International District Energy Association

125 Turnpike Road, Suite 4
Westborough, MA 01581-2841
508-366-9339
www.districtenergy.org

District Heating Handbook, Fourth Edition

Description: A guide for engineers to understand district heating and how best to use it.

John Wiley & Sons

www.wiley.com

Handbook of Energy Systems Engineering Production and Utilization

Author: Leslie Wilbur (Editor)

Description: This book covers all aspects of energy system engineering from a user's perspective. It presents a holistic approach to understanding these systems from fuels to end-use technologies for mechanical and electric production and utilization in industry today. The extensive list of references provided are invaluable to anyone interested in energy production and utilization. Publication, 1985.

Krieger Publishing Company

PO Box 9542

Melbourne, FL 32902-9542

321-724-9542

Handbook of Thermal Insulation Design Economics for Pipes and Equipment

Authors: William C. Turner and John F. Malloy

Description: This handbook discusses topics such as: heat transfer; insulation materials properties; selection/application/installation; and energy savings.

Marcel Dekker, Inc.

270 Madison Avenue

New York, NY 10016-0602

212-696-9000

www.dekker.com

Steam Plant Calculations Manual

Author: Ganapathy, V.

Description: Provides solutions to nearly 200 practical questions related to the planning, design, operation, and maintenance of steam plant systems.

McGraw-Hill

1221 Avenue of the Americas

New York, NY 10020

800-352-3566

www.bookstore.mcgraw-hill.com

Marks Standard Handbook for Mechanical Engineers

Authors: Eugene Avallone and

Theodore Baumeister, III, (Editors)

Description: Provides descriptions of different heat distribution systems including low-pressure steam systems. ISBN: 0070049971

A Practical Guide to Steam Turbine Technology

Author: Heinz P. Bloch

Description: This book is written for plant, mechanical, design, and maintenance engineers, and will assist end users with selecting, operating, and maintaining steam-driven systems. It includes design and manufacturing data for steam turbines and compressors, as well as the other operational components. ISBN: 0070059241

Shreve's Chemical Process Industries, Fifth Edition

Author: G. T. Austin

Description: The book provides an overview of the chemical processing of raw materials into useful and profitable products. It provides process descriptions and process diagrams for many chemical processing operations.

A Working Guide to Process Equipment

Authors: Norman P. Lieberman and Elizabeth T. Lieberman

Description: Explains the basic technical issues that need to be known to troubleshoot process equipment problems. Provides diagnostic tips, worked out calculations, practical examples, and illustrations.

ONDEO-Nalco Chemical Company

One Nalco Center
Naperville, IL 60563
708-305-1000
www.nalco.com

NALCO Guide to Boiler Failure Analysis

Authors: Robert D. Port and Harvey M. Herro
Description: This book is a comprehensive field guide to boiler system failures. It is intended to aid in-plant detection and diagnosis. Correction procedures can usually be specified once the cause of system failures has been determined.

NALCO Water Handbook, Second Edition

Author: Frank N. Kemmer (Editor)
Description: This reference discusses the use of water and steam in water treatment unit operations, the use of water and steam in a number of major process industries, and specialized water treatment technologies in boilers and other systems.

Pennwell Publishing

www.pennwell.com

Petrochemicals in Nontechnical Language, Third Edition

Authors: Donald L. Burdick and William L. Leffler
Description: Provides an overview of the key processes and operations in the petrochemicals industry.

Petroleum Refining in Nontechnical Language, Third Edition

Author: William L. Leffler
Description: Provides an overview of the key processes and operations in the petroleum refining industry for professionals in finance and marketing.

Prentice Hall

Upper Saddle River, NJ 07458
800-382-3419
www.prenhall.com

Energy Analysis of 108 Industrial Processes

Authors: Harry Brown, Bernard Hamel, and Bruce Hedman
Description: A reference for identifying the quantity and quality of industrial waste energy, which can be economically practical to recover. Presents detailed heat and material balances developed from the process flow diagrams for 108 industrial processes.

Handbook of Industrial Power & Steam Systems

Author: Paul Garay
Description: Describes the design and operation features of industrial power plants, considering such aspects as environmental concerns, basic energy and steam, electrical systems, heat recovery, energy conservation, codes and standards, and information sources. Publication, 1995.
ISBN: 0131474146

Spirax Sarco Application Engineering Department

1150 Northpoint Boulevard
Blythewood, SC 29016
803-714-2000
www.spirax-sarco.com

Hook-Ups—Design of Fluid Systems

Description: The Hook-Up Book is intended to serve as a reference in the design, operation, and maintenance of steam, air, and liquid systems. A learning tool to teach engineers how to design productive steam systems efficiently and cost effectively.

Steam Utilization—Design of Fluid Systems

Description: The Steam Utilization Book is intended to serve as a reference in steam fundamentals to the most efficient use of steam heat content. The book describes proper steam trapping, controls, and condensate recovery.

TAPPI Press

www.tappi.org

Energy Cost Reduction in the Pulp and Paper Industry

Prepared by: Paprican (Canada)

Description: Provides an overview of cost reduction opportunities available in pulp and paper plants.

TLV Company Ltd.

6701K North Park Boulevard
Charlotte, NC 28216-2383
704-597-9070
www.tlv.com

Condensate Drainage and Recovery

Description: This handbook provides a practical introduction to draining condensate from equipment and returning it to the boiler system. Publication, 1997.

Efficient Use of Process Steam

Description: This handbook provides a practical introduction to steam properties, and a basic awareness of how steam can be successfully and beneficially used in industry. Publication, 1996.

Steam Trapping Principles

Description: This handbook explains the technology of steam trapping, and provides data to correctly select and install steam traps for the benefit of maximum plant efficiency.

Yarway Corporation

P.O. Box 350
480 Norristown Road
Blue Bell, PA 19422-0760
610-825-2100
www.yarway.com

Industrial Steam Trapping Handbook

Description: Focuses on good steam piping/system/application practices. Includes extensive information on different steam trap technologies, condensate line sizing and steam trap testing techniques.

Other Publications (Guides, Manuals, and Standards)

American Boiler Manufacturers Association

950 North Glebe Road, Suite 160
Arlington, VA 22203-1824
703-522-7350
www.abma.com

Boiler Water Limits and Steam Purity Recommendations for Watertube Boilers

Description: Guidelines for steam purity.

American Gas Association

400 N. Capitol Street, N.W.
Washington, DC 20001
202-824-7000
www.aga.org

Boiler NO_x Control Field Manual, 1994

Description: This manual provides an applications reference and guidebook to assist gas utility marketing personnel in working with industrial customers to address the control oxides of nitrogen.

American National Standards Institute

Fluid Control Institute of America, ANSI
11 West 42nd Street
New York, New York 10036
212-642-4900
www.ansi.org

ANSI/Fluid Control Institute 69-1-1989 (revised 1994)

Description: Pressure ratings for steam traps.

ANSI/Fluid Control Institute 85-1-1994

Description: Standard for production testing of steam traps.

ANSI Fluid Control Institute 87-1-1994

Description: Classifications and operating principles of steam traps.

Fluid Control Institute 97.1

Description: Standard for production testing of secondary pressure drainers (condensate return

pumps).

American Society of Mechanical Engineers

800-THE-ASME
www.asme.org

ANSI/ASME PTC 39.1, Performance Testing

Description: Reviews all the necessary information to conduct performance tests on steam traps for efficient use of plant steam.

ASME B31.1 Power Piping Code 1995 Edition

Description: Code of standards for pressure piping.

ASME Boiler/Pressure Vessel Code

Description: Construction specifications associated with boilers and their operation.

Consensus on Operating Practices for the Control of Feedwater and Boiler Water Chemistry in Modern Industrial Boilers (CRTD-Vol. 34)

Description: Guidelines aimed at minimizing boiler deposition.

A Practical Guide to Avoiding Steam Purity Problems in the Industrial Plant (CRTD-Vol. 35)

Description: Guidelines aimed at avoiding steam purity related problems.

Armstrong International, Inc.

816 Maple Street
Three Rivers, MI 49093 USA
616-273-1415
www.armintl.com

Armstrong Service Guide Bulletin-301

Description: Steam trap installation and maintenance.

Chart 1101 - A Quick Way to Find How Much Steam You Need to Heat Water

Description: Chart showing amount of steam and the boiler horsepower you require to heat water.

Chart 1121 - How to Size Condensate Return Lines

Description: The sizing of condensate return lines presents several problems which differ from those of sizing steam or water lines, the most significant of these being the handling of flash steam. The chart contains formulas to size condensate lines and

return line capacity data.

Installation and Testing of Inverted Bucket Steam Traps-Bulletin - 307

Description: Steam trap testing for Inverted Bucket traps.

Steam Trap Testing Guide for Energy Conservation

Description: Trap testing for all trap styles.

British Standards Institution

www.bsi.org.uk

Recommendations for Treatment of Water for Steam Boilers and Water Heaters (BS 2486:1997)

Description: The standard gives recommendations for the control of waterside conditions in steam boilers and water heaters. It also includes information on the preparation of feedwater required for these systems.

National Board of Boiler and Pressure Vessel Inspectors

1055 Crupper Avenue
Columbus, OH 43229
614-888-8320
www.nationalboard.org

National Board Inspection Code, ANSI/NB-23 National Board of Boiler and Pressure Vessel Inspectors

Description: The purpose of the National Board Inspection Code is to "Maintain the integrity of pressure retaining items after they have been placed into service by providing rules for inspection, repair, and alteration..."

National Insulation Association

703-683-6422
www.insulation.org

National Commercial and Industrial Insulation Standards

Description: This is a national standard for designing, specifying, and installing thermal mechanical insulation for commercial and industrial pipe, equipment, vessels, and ducting systems.

Plant Support & Evaluations, Inc.

2921 South 160th Street
New Berlin, WI 53151
888-615-3559
www.plantsupport.com

Steam System Specialist Level One - Training Manual

Description: The training manual covers all aspects of the steam system. It provides the necessary basic information on steam, heat transfer, boilers, piping, heat exchangers, insulation, and steam traps.

Steam System Specialist Level Two - Training Manual

Description: The training manual covers all aspects of the steam system. This manual is more in-depth than Level One in the following areas: steam, heat transfer, boilers, piping, heat exchangers, insulation, and steam traps.

Spirax Sarco Application Engineering Department

1150 Northpoint Boulevard
Blythewood, SC 29016
803-714-2000
www.spirax-sarco.com

Spirax Sarco Products, Applications and Systems for the Steam and Condensate Loop “Wall Chart”

Description: Wall chart of a total steam system, showing steam Generation, Distribution, End-Use and Recovery Guidelines.

Spirax Sarco Specification Guide and Designers Notes

Description: Guideline specification and designer note requirements for Industrial, HVAC, and clean steam systems.

Steam Distribution. Technical Reference Guide (TR-GCM-03)

Description: This guide looks at the distribution of dry saturated steam as a conveyor of heat energy to the point of use, for either process heat exchange applications or space heating. It covers the issues associated with the implementation of an efficient steam system.

TAPPI Press

800-332-8686
www.tappi.org

Paper Machine Steam and Condensate Systems

Description: Provides information to solve drying-related problems and gives a basic understanding of paper machine steam and condensate systems.

United Kingdom Energy Efficiency

Best Practices Program
www.etsu.com

Guidance for Coal-Fired Boiler Operation

Description: Guidelines for boiler operation for boilers fueled by coal.

Guidance for Gas-Fired Boiler Operation

Description: Guidelines for boiler operation for boilers fueled by gas.

Guidance for Oil-Fired Boiler Operation

Description: Guidelines for boiler operation for boilers fueled by oil.

U.S. Army Corps of Engineers

202-761-1494
www.usacpw.belvoir.army.mil

Industrial Water Treatment Procedures, PWTB 420-49-5

Description: Guide for boiler plant operators to properly set up, maintain, and control boiler system water chemistry. Applies to boiler systems operating below 600 psi. Includes guidelines for water treatment for other HVAC systems.

**U.S. Department of Energy (DOE)
Information Bridge**

865-576-8401
www.osti.gov/bridge

**Guide to Low-Emission Boiler and Combustion
Equipment Selection**

Description: Guide presents topics pertaining to industrial, commercial, and institutional (ICI) boilers. Background information about various types of commercially available boilers is provided along with discussions about the fuels that they burn and the emissions that they produce. Use of the guide is primarily intended for those involved in either expanding current steam or hot water generating capacity or developing new capacity. Document reference: ORNL/TM-2002/19.

U.S. Environmental Protection Agency

800-459-WISE
www.epa.gov

Wise Rules Tool Kit

Description: Rules and measures for estimating potential energy, cost, and greenhouse gas emissions savings with information on boilers, steam systems, furnaces, process heating, waste heat recovery, cogeneration, compressed air

Software

systems, and process cooling.

Armstrong International, Inc.

816 Maple Street
Three Rivers, MI 49093 USA
616-273-1415
www.armintl.com

Armstrong Coil Sizing Software

Developer: Armstrong International
Description: Coil sizing and selection instructions for specific applications.

Armstrong Humidifier Sizing Software

Developer: Armstrong International
Description: Steam humidifier sizing and selection instructions for specific applications.

Armstrong Preventative Maintenance APM+ Software

Developer: Armstrong International
Description: Pressure Reducing Valve (PRV) sizing and selection instructions for specific applications.

Armstrong PRV Sizing Software

Developer: Armstrong International
Description: Coil sizing and selection instructions for specific applications.

Armstrong Steam Eye Software

Developer: Armstrong International
Description: Software designed to constantly monitor steam traps in a system.

Armstrong Trap Sizing Software

Developer: Armstrong International
Description: Steam trap sizing and selection instructions for specific applications.

ChemicalLogic Corporation

www.chemicallogic.com

SteamTab Software

Developer: ChemicalLogic Corporation
Description: SteamTab is a tool designed for steam property users in the scientific, engineering, plant operation, and educational communities. SteamTab uses fundamental equations to calculate all steam properties with interpolation or curve fits to raw steam data. SteamTab products support spreadsheet applications.

Conserv-It Software

13000-F York Road, #116
Charlotte, NC 28178
704-841-9550
www.conserv-it.com

SteamWorks Pro

Developer: Conserv-It Software, Inc.
Description: This software assists in tracking steam trap maintenance efforts.

Control Dynamics, Inc.

804-744-3612

Boiler Control Package Tool

Developer: Licensed by Fisher-Rosemount Performance Solutions

Description: The Boiler Control Package is a pre-configured control strategy for use with control systems for steam generators; i.e., boilers, heat recovery generators, and thermal oxidizers. Controls include the water side for single or three-element drum level controls, combustion controls for parallel metering and cross-limiting of one or more fuels, with oxygen trim. Steam header pressure controls are included as well as a simulation for training.

EPD

www.epdtech.com

DataTemp 2 Software

Developer: EPD

Description: DataTemp 2 Software records, stores and graphs temperature data over time. For maintenance operations and process monitoring and control, temperature trend data is critical. If that data is in a form you can't use, you have a problem. DataTemp 2 provides a simple solution. Using an EPD PM infrared for input and your computer as a data logger and recorder, DataTemp 2 lets you take accurate temperature measurements at programmable time intervals.

Field Data Specialists, Inc.

800-932-9543

www.trapbase.com

TrapBase97 for Windows Software

Developer: Field Data Specialists, Inc.

Description: TrapBase was designed as a field tool to assist in developing a systematic steam system program. The software has features for data entry, directed surveys, field reporting, maintenance work orders/history, field data analysis, and savings results analysis. Existing data from other software or from spreadsheets can be imported into TrapBase. A version of the software was written to be used with the TrapTech Palm PC.

Honeywell Corporation

800-343-0228

www.iac.honeywell.com

Turbo Economic Load Allocation

Developer: Honeywell Corporation

Description: Calculates optimum loading for all boilers at all possible steam loads.

Linnhoff March

www.linnhoffmarch.co.uk

PROSTEAM Software

Developer: Linnhoff March

Description: PROSTEAM is an engineering add-in model for a Microsoft Excel spreadsheet. It provides steam and water thermodynamic and transport property calculations, and steam utility systems modeling.

National Insulation Association

703-683-6422

www.insulation.org

Mechanical Insulation Energy Appraisal Program

Description: This program will demonstrate to plant owners, engineers, specifiers, and contractors the enormous energy (Btu) savings in dollars through the use of insulation on hot and cold piping, ducts, vessels, and equipment in a facility. In addition, savings will be quantified in CO₂, NO_x, and CE (greenhouse gas) emission levels. The key program elements consist of an appraisal worksheet, 3E Plus computer software, inventory spreadsheets, and final appraisal of Btu and dollars saved and emission level savings.

National Institute of Standards and Technology

301-975-2208

www.nist.gov

NIST/ASME Steam Properties

Developer: National Institute of Standards and Technology

Description: Database of steam and water thermodynamic properties.

Nelson & Roseme, Inc.

P.O. Box 30024
Walnut Creek, CA 94598
925-280-0327

VisualMesa

Developer: Nelson & Roseme, Inc.

Description: First principles model for complicated energy systems.

Ogontz Corporation

800-523-2478
www.ogontz.com

Ogontz Energy Savings Potential

Developer: Ogontz Corporation

Description: This software calculates the dollars that can be saved using steam controls and traps in an existing facility or new construction project. The software provides cost savings information for unit heaters, winterization steam tracing, temperature control of traced process piping, and other temperature control applications.

Spirax Sarco Application Engineering Department

1150 Northpoint Boulevard
Blythewood, SC 29016
803-714-2000
www.spirax-sarco.com

SNAP3 Steam Needs Analysis Program

Developer: Spirax Sarco

Description: Total Steam System Software Program for sizing and selecting: piping for steam/condensate/water; steam conditioning stations; pressure reducing stations; temperature control stations; steam traps (all types and applications); condensate recovery stations; flash steam recovery systems; clean/pure steam systems.

STMS Steam Trap Management System

Developer: Spirax Sarco

Description: Windows based software designed for the easy collection, storage, organization, and sorting of steam trap data. It lets you create custom databases from survey sheets or a handheld Data Collector then analyze by maintenance schedules, trap performance, trap application or cost of steam loss, etc.

Steam Conservation Systems

12 Laurel Lane
East Greenwich, RI 02818 USA
401-886-4164
www.trapo.com

Steam \$\$ and the Trap Demo

Developer: Steam Conservation Systems

Description: Calculates annual steam distribution system costs and efficiency, shows costs of energy lost through piping insulation, shows costs of different ways of managing steam trap, shows investment, costs, payback and ROIs for changing to predictive maintenance.

Thermon Corporation

800-820-4328
www.thermon.com

SteamTrace 1.3

Developer: Thermon Corporation

Description: Steam heat tracing design software.

TLV Company, Ltd.

6701K North Park Boulevard
Charlotte, NC 28216-2383 USA
704-597-9070
www.tlv.com

TLV SE-1 STEAM Software

Developer: TLV Company, Ltd.

Description: Software to perform calculations for steam system components. Modules include Engineering Calculations, Steam Trap Selection, Pressure Reducing Valve Selection, Air Trap Selection, Gas Trap Selection, Air Vent Selection, Power Trap Selection, and Separator Selection.

UE Systems

800-223-1325
www.uesystems.com

Ultraprobe 9000

Developer: UE Systems

Description: Ultrasonic inspection and information storage system.

U.S. Army Construction Engineering Laboratory

800-USA-CERL
www.cecer.army.mil

HEATER Software

Description: A computer modeling tool that incorporates the HEATMAP software. HEATER allows steam/condensate/utility systems to be modeled, and provides inventory and O&M condition indices that can be used to prioritize repairs/ replacement. Predictive modeling can estimate time to failure.

U.S. Department of Energy

Office of Industrial Technologies
800-862-2086
www.oit.doe.gov/bestpractices

3E Plus Insulation Thickness Computer Program

Developer: North American Insulation Manufacturers Association
Description: Calculates insulation thickness to determine economic, energy, and environmental savings for piping and equipment. Includes calculations for heat gain or heat loss, surface temperature requirements, condensation control, heat loss efficiencies versus bare pipe, payback periods, and emissions reductions.

Veritech Corporation

22960 Shaw Road, Suite 620
Sterling, VA 20166
703-435-7881

ESteam

Developer: Veritech Corporation
Description: A steam system simulation program developed in a Microsoft Excel environment. The model performs heat and mass balances and allows flexibility for specifying condensate return, flash steam blowdown and deaeration schemes, letdown arrangements, and desuperheating configurations.

Washington State University

Cooperative Extension Energy Program
925 Plum Street, SE, Building 4
Olympia, WA 98504-3165
800-373-2139

HEATMAP Software

Description: HEATMAP is a software program that was specifically developed to help plan, analyze, and operate district heating and cooling systems.

Yarway Corporation

P.O. Box 350
480 Norristown Road
Blue Bell, PA 19422-0760
610-825-2100
www.yarway.com

TrapMaster

Developer: Yarway Corporation
Description: Windows based software designed for the collection, storage, organization, and sorting of steam trap data. It lets you create custom databases from survey sheets or a handheld Data Collector, then analyzes it in many different ways. It is possible to create a historical record of an individual trap's performance over many surveys. An extensive database of Steam Trap manufacturer's models and performance data is built in for easy access.

Periodicals

ASHRAE Journal, American Society of Heating, Refrigeration, and Air Conditioning Engineers, Atlanta, GA, www.ashrae.org.

Chemical Engineering, Chemical Week Publishing, New York, NY, www.che.com

Chemical Processing, Putman Media, Itasca, IL, www.chemicalprocessing.com

Consulting-Specifying Engineer, Cahners Publishing Company, www.cahners.com

Energy Engineering, Association of Energy Engineers, Lilburn, GA, www.aeecenter.com

Energy User News, Business News Publishing, Troy, MI, www.energyusernews.com

Heating/Piping/Air Conditioning, HPAC, Engineering, Penton Publishing, Cleveland, OH, www.penton.com.

Industrial Maintenance & Plant Operation (IMPO), Cahners Publishing Company, www.cahners.com

Mechanical Engineering, American Society of Mechanical Engineers (ASME), American Society of Mechanical Engineers (ASME), New York, NY, www.asme.org.

Plant Engineering, Cahners Publishing Company, www.cahners.com

Plant Services, Putnam Publishing, Itasca, IL, www.plantservices.com.

Process Heating, Business News Publishing, Troy, MI, www.process-heating.com

Reports and Technical Papers

American Gas Association

400 N. Capitol Street, NW
Washington, DC 20001
202-824-7000
www.aga.org

Energy Analysis

Description: Contains information on boilers in leading manufacturing industries as it relates to natural gas.

Solving Boiler Efficiency Problems

Publication: Gas Technology: Natural Gas Applications in Industry, Summer 1996.

Armstrong International, Inc.

816 Maple Street
Three Rivers, MI 49093
616-273-1415
www.armintl.com

Capturing Energy Savings with Steam Traps

Authors: Richard G. Bockwinkel and Scott A. French

Gas Research Institute

8600 West Bryn Mawr Avenue
Chicago, IL 60631-3562
773-399-8100
www.gri.org

Analysis of the Industrial Boiler Population

Description: Report that identifies and characterizes the current industrial boiler population by fuel type and consumption, geographic location, industry, end user, and age. Publication, June 1993.

United Kingdom Energy Efficiency

Best Practices Program
www.etsu.com

The Economic Thickness of Insulation for Hot Pipes

Program: Available in: Fuel Efficiency Booklet 8, 1994.

Improving Boiler Efficiency through Water Treatment

Publication: Good Practice Guide 221, March 1998.

Reducing Energy Consumption Costs by Steam Metering

Publication: Good Practice Guide 18, 1991.

U.S. Department of Energy Information Bridge

www.osti.gov/bridge

Review of Orifice Plate Steam Traps

Description: This report describes orifice traps and mechanical steam traps. It also provides information to help make decisions regarding applications for which orifice traps should be considered.

U.S. Department of Energy

Office of Industrial Technologies
800-862-2086
www.oit.doe.gov/bestpractices

Overview of Energy Flow for Industries in Standard Industrial Classifications 20-39

Description: This report, sponsored by the Department of Energy's Industry of the Future BestPractices initiative, identifies and quantifies the energy supply and consumption in U.S. industry for heat and power by application.

Training Courses and Technical Services

AESYS Technologies

693 North Hills Road
York, PA 17402-2212
717-755-1081
www.aesystech.com

Area(s) covered: AESYS Technologies offers courses in both boiler operation and maintenance and facility operations and maintenance.

American Society of Mechanical Engineers

800-THE-ASME
www.asme.org

Area(s) covered: The ASME gives courses on repairs and alterations of boilers and pressure vessels.

Armstrong International, Inc.

816 Maple Street
Three Rivers, MI 49093
616-273-1415
www.armintl.com

Area(s) covered: Armstrong International has training facilities in which it sponsors Steam Energy Seminars and Education, and online steam training through Armstrong Steam University.

Association of Energy Engineers

4025 Pleasantdale Road, Suite 420
Atlanta, GA 30340
770-447-5083
www.aeecenter.org

Area(s) covered:

- Industrial Energy Conservation
- Strategies that Work
- Optimizing Boiler Performance

Babcock & Wilcox

20 S. Van Buren Avenue
Barberton, OH, 44203-0351
800-BABCOCK
www.babcock.com

Area(s) covered: Babcock & Wilcox provide courses in:

- Boiler Condition Assessment and Monitoring
- Boiler Performance Analysis
- Industrial Water-Tube Boiler
- Oil/Gas-Fired Boilers
- Recovery Boiler

Boiler Efficiency Institute

P.O. Box 2255
Auburn, AL 36831-2255
800-669-6948
www.boilerinstitute.com

Area(s) covered:

- Steam Plant Improvement
- Workshop Engineering Fundamentals

CDT Micrographics

137 Water Street
Exeter, NH 03833
603-778-6140
www.cdtmicrographics.com

Area(s) covered: Hazards of Steam

Center for Professional Advancement

Box 1052
144 Tices Lane
East Brunswick, NJ 08816-1052
732-238-1600
www.cfpa.com

Area(s) covered: The CFPA offers courses in:

- Boiler and Steam System Management
- Boiler Water Treatment
- Piping Design, Analysis, and Fabrication
- Pressure Vessel Design and Analysis
- Project Management for Plant Retrofits & Shutdowns
- Shell-and-Tube Heat Exchangers
- Steam Turbines and Auxiliaries

Donlee Technologies, Inc.

693 North Hills Road
York, PA USA 17402-2212
800-366-5334
www.donleetechn.com

Area(s) covered: Donlee Technologies offers courses in both boiler operation and maintenance and facility operations and maintenance.

Eclipse Combustion, Inc.

1665 Elmwood Road
Rockford, IL 61103
815-877-3031
www.eclipsenet.com

Area(s) covered: Eclipse Combustion Workshop

Enercheck Systems, Inc.

P.O. Box 49426
Charlotte, NC 28277
704-841-9550

Area(s) covered:

- Performing a Steam Trap Survey
- Performing a Compressed Air/Inert Gas Survey
- How to Make a Steam System Efficient

Johnson Controls Institute

800-524-8540
www.johnsoncontrols.com

Area(s) covered:

- Heat Pump Controls
- Boiler Maintenance
- Specifying Facility Management Systems

New York State Energy Research and Development Association (NYSERDA)

Corporate Plaza West
286 Washington Avenue Extension
Albany, NY 12203-6399
518-862-1090
www.nyserdera.org

Area(s) covered: NYSERDA offers the following workshops related to steam systems: Boiler Plant Water Treatment, Energy Efficient Small Boiler Plant Operation and Maintenance, and Steam Plant Improvement.

North American Manufacturing Company

4455 East 71st Street
Cleveland, OH 44105
216-271-6000

Area(s) covered:

- Combustion and Kiln Control
- Effective Combustion and Its Control
- Optimizing Gas-Fired Industrial Heating Processes

North Carolina State University Center for Boiler Studies

Industrial Extension Services
Campus Box 7902
Raleigh, NC 27695-7902
919-515-5438
www.ies.ncsu.edu

Area(s) covered:

- Energy Management Techniques
- Customized On-Site Boiler Seminars
- Measuring and Improving Boiler Efficiency
- An Evaluation of Oil vs. Natural Gas Firing in Boilers
- Improving Boiler Efficiency Through the Use of Natural Gas

PGS Energy Training

Carnegie Office Park
600 N. Bell Avenue
Bldg. 2, Suite 2708
Carnegie, PA 15106
412-279-9298

Area(s) covered: Managing Industrial Energy Procurement

Plant Support & Evaluations, Inc.

2921 S. 160th Street
New Berlin, WI 53151
888-615-3559
www.plantsupport.com

Area(s) covered: Plant Support and Evaluations offers courses on complete systems as well as four levels of training.

Power Specialties Company Inc. & Power Specialties Service

P.O. Box 197
34 Scanlon Drive
Randolf, MA 02368
781-963-8910
Email: john@powerspecialties.com
www.powerspecialties.com

Area(s) covered: Power Specialties Company Inc. offers seminars to help optimize steam systems.

Spirax Sarco

1150 Northpoint Boulevard
Blythewood, SC 29016
803-714-2000
www.spirax-sarco.com

Area(s) covered: Spirax Sarco offers an open university program on clean steam utilization and a continuing education program on steam systems.

Steam Conservation Systems

12 Laurel Lane
East Greenwich, RI 02818
401-886-4164

Area(s) covered: Steam Conservation Systems offers programs for reducing the costs and hassles of maintaining a steam distribution system.

Steam Economies Company

9325 Sutton Place
Hamilton, OH 45011
800-362-4994
www.steameconomies.com

Area(s) covered:

- Boiler & Steam System Fundamentals
- Understanding Your Steam Boiler System

University of Tennessee Energy, Environment and Resources Center

311 Conference Center Building
Knoxville, TN 37996-4134
865-974-4251
www.eerc.ra.utk.edu

Area(s) covered:

- Boiler & Steam System Fundamentals
- Energy Management Techniques
- Customized On-Site Boiler Seminars
- Measuring and Improving Boiler Efficiency
- Onsite Assessments

University of Wisconsin-Madison/Extension

Department of Engineering and Professional Development
432 N. Lake Street
Madison, WI 53706
608-262-2061

Area(s) covered: The University of Wisconsin at Madison offers a course in Basic Boiler Water Treatment.

Yarway Corporation

480 Norristown Road
Blue Bell, PA 19422-0760
610-825-2100
www.yarway.com

Area(s) covered: 1 or 2 1/2 day courses covering Steam Conservation, Steam and Condensate Systems, Steam Trapping, Installation and Maintenance.

Videos

Armstrong International, Inc.

816 Maple Street
Three Rivers, MI 49093
616-273-1415
www.armintl.com

Guidelines for the Prevention of Water Hammer

Description: Video identifies the most likely causes of water hammer and provides solutions that can be implemented to prevent it. (16 minutes)

Guidelines for Steam System Efficiency

Description: Video explaining basic considerations in the design, piping, and trapping of steam systems. (15 minutes)

Guidelines for Steam Trap Troubleshooting and Testing

Description: Video outlining the need for establishing a preventive maintenance program and details what to look and listen for in testing steam traps. (18 minutes)

Let's Talk Steam Traps/Update

Description: Video explaining the operating principles of the three types of steam traps: mechanical, thermostatic, and thermodynamic. Tape helps users understand the internal operation of inverted bucket, F&T, thermostatic, and disc traps. (32 minutes)

What Is Steam?

Description: Video explaining the basics of steam. (15 minutes)

International District Energy Association

125 Turnpike Road, Suite 4
Westborough, MA 01581-2841
508-366-9339
www.districtenergy.org

Steam Distribution System Safety – A Video Training Program

Description: The purpose of this video training program is to present the operating features of a typical District Heating System with special emphasis on hazards and safety procedures.

Spirax Sarco Application Engineering Department

1150 Northpoint Boulevard
Blythewood, SC 29016
803-714-2000
www.spirax-sarco.com

Effective Condensate Drainage from Heat Exchangers

Description: This video highlights the operation of steam process equipment during change in demand to address known problems of water hammer and temperature fluctuations. (15 minutes)

Steam Boilers: The Inside Information

Description: The video highlights internal boiler response to on/off demand, high steam demand, reduced boiler pressure, and change in total dissolved solids (TDS). (12 1/2 minutes)

Appendices

The following appendices have been included in the Sourcebook:

◆ **Appendix A: Glossary of Terms**

This appendix contains a glossary of terms used in steam systems.

◆ **Appendix B: Tip Sheets**

This appendix contains a series of steam system tip sheets. Developed by the U.S. Department of Energy, these tip sheets discuss common opportunities that industrial facilities can use to improve performance and reduce fuel use.

◆ **Appendix C: Guidelines for Comment**

This appendix contains a form that provides a vehicle for submitting comments for improving the Sourcebook.

Appendix A: Glossary of Terms

Absorption chilling—This is a water chilling process in which cooling of a solution is accomplished by the evaporation of a fluid (usually water), which is then absorbed by a different solution (usually lithium bromide), then evaporated under heat and pressure. The fluid is then condensed with the heat of condensation rejected through a cooling tower.

Air vent—A device that allows the release of non-condensable gases from a steam system.

Alkalinity—A measure of the concentration of carbonate, bicarbonate, and hydroxyl ion in water, usually expressed in equivalent ppm (parts per million) of calcium carbonate.

Backpressure turbine—A turbine that exhausts steam above atmospheric pressure. The exhaust steam is usually sent to other services.

Biomass—Organic matter which is available on a renewable basis, including agricultural crops and agricultural wastes and residues, wood and wood wastes and residues, animal wastes, municipal wastes, and aquatic plants.

Blowdown ratio—For boilers, the ratio of water removed by blowdown to the amount of feedwater provided to the boiler in equivalent units for the same time period (both usually reported in pounds per hour).

Boiler—A vessel or tank in which heat produced from the combustion of fuels such as natural gas, fuel oil, wood, or coal is used to generate hot water or steam for applications ranging from building space heating to electric power production or industrial process heat.

Boiler blowdown—The periodic or continuous removal of water from a boiler to remove concentrations of dissolved solids and/or sludges accumulating in the boiler.

Boiler horsepower—A unit of rate of water evaporation equal to the evaporation per hour of 34.5 pounds of water at a temperature of 212°F into steam at 212°F. One boiler horsepower equals 33,475 Btu per hour.

British thermal unit (Btu)—The amount of heat required to raise the temperature of one pound of water one degree Fahrenheit; equal to 252 calories. It is roughly equal to the heat of one kitchen match.

Chlorides—Chemical compounds found in boiler water consisting of metallic ions with chlorine atoms, part of a group of compounds called salts. The most prevalent are magnesium chloride and sodium chloride.

Cogeneration—The simultaneous production of electrical or mechanical work and thermal energy from a process, thus reducing the amount of heat or energy lost from the process. Also known as combined heat and power (CHP).

Combined Heat and Power (CHP)—The simultaneous production of electrical or mechanical work and thermal energy from a process, thus reducing any waste heat or energy lost from the process. Also known as cogeneration.

Combustion efficiency—This measure represents the amount of fuel energy extracted from flue gases. It is a steady state measure and does not include boiler shell losses or blowdown losses. The losses identified in this efficiency calculation are the stack losses. Stack loss is an indication of the amount of energy remaining in the flue gases as they exit the boiler.

Combustion turbine—A turbine that generates electric power from the combustion of a fuel.

Condensate—Condensed steam.

Condensate pump—A pump that pressurizes condensate allowing it to flow back to a collection tank, or boiler plant.

Condenser—A device that condenses steam. Surface condensers use a heat exchanger to remove energy from the steam, and typically operate under vacuum conditions.

Condensing turbine—A turbine that exhausts steam to typically sub-atmospheric conditions where the steam is condensed. These turbines are usually used in power generation applications.

Continuous blowdown—The process of removing water, on a continuous basis, from a boiler to remove high concentrations of dissolved solids, chlorides, and other products. Water is replaced by treated make-up water added to the condensate return. The withdrawn blowdown water is usually discharged to a sanitary drain.

Deaerator—A device that uses steam to strip feedwater of oxygen and carbon dioxide.

Desuperheater—A device used in steam systems to control the energy level and/or temperature of steam supplied to an end use, typically by injecting a fine mist of condensate into the steam flow.

Dew point—The temperature to which a vapor must be cooled, in order for saturation or condensation to occur.

Dissolved solids—The minerals and impurities in boiler make-up water. These increase in concentration as water is boiled into steam.

Distillation column—A device that separates components of a compound relying on differences in boiling points.

Dryer—A device that removes moisture from a solid.

Duty cycle—The duration and periodicity of the operation of a device.

Excess air—Excess air in a combustion process is that amount of air present in excess of the theoretically required air for complete combustion.

Excess air absorbs some of the heat of combustion and is carried away as waste heat with the exhaust combusted gasses.

Evaporator—A device that removes moisture from a liquid, resulting in increased concentration of the remaining compounds.

Feedwater—Water sent into a boiler or a steam generator. Feedwater typically meets cleanliness criteria, contains treatment chemicals, and has been stripped of oxygen.

Feedwater pump—A pump that sufficiently pressurizes feedwater to supply a boiler or generator.

Full load efficiency—The stated efficiency (in percent) of a process in terms of energy or work output divided by energy input at rated production (full load).

Greenhouse gas emissions—Those gases, such as water vapor, carbon dioxide, tropospheric ozone, methane, and low level ozone that are transparent to solar radiation, but opaque to long wave radiation, and which are believed to contribute to climate change.

Heat exchanger—A device used to transfer heat from one medium by either direct or indirect contact.

Heating, Ventilating and Air Conditioning (HVAC)—All the components of the appliance or system used to condition the interior air of a facility.

Heat Recovery Steam Generator (HRSG)—A device that captures the thermal energy in an exhaust stream or a process stream and transfers it to water to generate steam.

Kilowatt hour (kWh)—A unit of measure of electricity supply or consumption of 1,000 Watts over the period of one hour; equivalent to 3,412 Btu.

Latent heat—The change in heat content that occurs with a change in phase and without change in temperature. Changes in heat content that affect a change in temperature are called sensible heat changes.

Life Cycle Cost (LCC)—The sum of all the costs both recurring and nonrecurring, related to a product, structure, system, or service during its life span or specified time period.

Make-up water—Water brought into a boiler system from outside to replace condensate not returned to the boiler plant, water used in blow-down, steam lost through leaks, or water lost through evaporation or mist.

MMBtu—A unit of one million British thermal units (Btu).

Payback—The amount of time required for positive cash flows to equal the total investment costs. This is often used to describe how long it will take for energy savings resulting from using more energy-efficient equipment to equal the premium paid to purchase the more energy-efficient equipment.

Potable water—Water that is suitable for drinking, as defined by local health officials.

Pounds per square inch gauge (psig)—A unit of pressure in pounds force in comparison to local atmospheric pressure (as measured by a gauge).

Pressure Reducing Valve (PRV)—A valve that regulates the amount of steam allowed from a high-pressure service to a low-pressure service.

Radiant energy—Energy (transfer of heat through matter or space by means of electromagnetic waves) that transmits away from its source in all directions.

Reboiler—A heat exchanger used in petroleum refining and chemical manufacturing applications that adds heat to a process stream.

Reformer—A device that produces hydrogen from a hydrocarbon compound such as methane, typically by using steam.

Relative humidity—A measure of the percent of moisture actually in the air compared with what would be in it if it were fully saturated at that temperature. When the air is fully saturated, its relative humidity is 100 percent.

R-Value—A measure of the capacity of a material (or assembly of materials) to resist heat transfer, sometimes called thermal resistance. The R-Value is the reciprocal of the heat transfer coefficient (U-Value). The larger the R-Value, the greater its insulating properties.

Silica—The concentration of silica dioxide found in water measured in parts per million. Silica forms a tenacious scale with low thermal conductance. Silica is soluble in steam and can carry over into steam where it can condense on turbine blades or erode surfaces.

Sludge—A general term applied to a relatively loose accumulation of material that has settled to the bottom of a boiler.

Stack heat loss—Sensible and latent heat contained in combustion gases and vapor emitted to the atmosphere.

Stand-alone—A device that operates independent of or is not connected to other systems.

Standby losses—In boiler systems, standby losses are energy losses that are associated with natural draft through a boiler in a standby operating mode.

Steam ejector—A device that uses a relatively high-pressure motive steam flow through a nozzle to create a low pressure or suction effect.

Steam injector—A device that injects steam into a process, often used in direct steam heating applications.

Steam trap—A steam trap is an automatic control valve that allows for the release of condensate, air, CO₂, and other noncondensable gases, yet keeps live steam in the system.

Stripper—A device that separates components from a compound.

Surface blowdown—Boiler blowdown taken from the upper part of the boiler just below the water surface to reduce the amount of dissolved solids.

Thermal conductivity—This is a positive constant, k , that is a property of a substance and is used in the calculation of heat transfer rates for materials. It is the amount of heat that flows through a specified area and thickness of a material over a specified period of time when there is a temperature difference of one degree between the surfaces of the material.

Thermal load factor—A term used to describe the relative stability of use of heating in a facility or a process. Often used in cogeneration where a “high” factor denotes a continuous use of steady heating.

Thermocompressor—A device that uses high pressure steam to increase the pressure of a low-pressure steam supply to generate a more useful steam service.

Throttling—Regulating flow rate by closing a valve in the system.

Turbine—A device that converts the enthalpy of steam into mechanical work. See condensing turbine and backpressure turbine.

Vacuum breaker—A device that responds to the formation of vacuum conditions in equipment such as a heat exchanger by allowing in air which promotes condensate drainage.

Variable Frequency Drive (VFD)—A type of variable speed motor drive in which the motor is supplied with electrical power at frequencies other than standard 60 Hertz through a converter.

Variable Air Volume (VAV)—Variable air volume is a term for changing the quantity of air flow to meet heating, cooling, or exhaust loads rather than changing air temperatures.

Waste heat—Heat that is discharged from a mechanical process, wastewater, or ventilation exhaust system that could be reclaimed for useful purposes.

Water hammer—A shock that results from the sudden collapse of a steam pocket in a two phase line such as a condensate return line. Also the impingement of a water slug carried by relatively high velocity steam.

Appendix B: Steam Tip Sheets

Some improvement opportunities are available to many different systems. To increase industry awareness of several fundamental improvement opportunities, the U.S. Department of Energy's Office of Industrial Technologies has developed the following tip sheets through its BestPractices program.

1. Inspect and Repair Steam Traps
2. Insulate Steam Distribution and Condensate Return Lines
3. Use Feedwater Economizers for Waste Heat Recovery
4. Improve Your Boiler's Combustion Efficiency
5. Tip Sheet Number Skipped
6. Tip Sheet Number Skipped
7. Clean Boiler Waterside Heat Transfer Surfaces
8. Return Condensate to the Boiler
9. Minimize Boiler Blowdown
10. Recover Heat from Boiler Blowdown
11. Use Vapor Recompression to Recover Low-Pressure Waste Steam
12. Flash High-Pressure Condensate to Regenerate Low-Pressure Steam
13. Use a Vent Condenser to Recover Flash Steam Energy
14. Use Low-Grade Waste Steam to Power Absorption Chillers
15. Benchmark the Fuel Costs of Steam Generation
16. Minimize Boiler Short Cycling Losses
17. Install Removable Insulation on Uninsulated Valves and Fittings
18. Deaerators in Industrial Steam Systems
19. Cover Heated Open Vessels
20. Replace Pressure-Reducing Valves with Backpressure Turbogenerators
21. Consider Steam Turbine Drives for Rotating Equipment

These tip sheets provide concise descriptions of common improvement opportunities. Since the BestPractices continues to develop and identify energy improvement programs, additional tip sheets are expected.

Energy Tips

Tip Sheet #1 • June 1999



Steam



Motors



Compressed Air

Recommended Steam Trap Testing Intervals

- High Pressure (150 psig and above): Weekly to Monthly
- Medium Pressure (30 to 150 psig): Monthly to Quarterly
- Low Pressure (Below 30 psig): Annually

Inspect and Repair Steam Traps

In steam systems that have not been maintained for 3 to 5 years, between 15% to 30% of the installed steam traps may have failed—thus allowing live steam to escape into the condensate return system. In systems with a regularly scheduled maintenance program, leaking traps should account for less than 5% of the trap population. If your steam distribution system includes more than 500 traps, a steam trap survey will probably reveal significant steam losses.

Example

In a plant where the value of steam is \$4.50 per thousand pounds (\$/1,000 lbs), an inspection program indicates that a trap on a 150 psig steam line is stuck open. The trap orifice is 1/8 inch in diameter. The table shows the estimated steam loss as 75.8 lbs/hr. By repairing the failed trap, annual savings are:

$$\text{Savings} = 75.8 \text{ lbs/hr} \times 8,760 \text{ hrs/yr} \times \$4.50/1,000 \text{ lbs} = \$2,988/\text{yr}$$

Leaking Steam Trap Discharge Rate

Trap Orifice Diameter (inches)	Steam Loss (lbs/hr)			
	Steam Pressure (psig)			
	15	100	150	300
1/32	0.85	3.3	4.8	-
1/16	3.4	13.2	18.9	36.2
1/8	13.7	52.8	75.8	145
3/16	30.7	119	170	326
1/4	54.7	211	303	579
3/8	123	475	682	1,303

From the Boiler Efficiency Institute. Steam is discharging to atmospheric pressure.

Steam Trap Testing Facts

Steam traps are tested to determine if they are functioning properly and not cold plugging or failing in an open position and allowing live steam to escape into the condensate return system. There are four basic ways to test steam traps: temperature, sound, visual, and electronic.

Suggested Actions

Steam traps are tested primarily to determine whether they are functioning properly and not allowing live steam to blow through. Establish a program for the regular systematic inspection, testing, and repair of steam traps. Include a reporting mechanism to ensure thoroughness and to provide a means of documenting energy and dollar savings.

Steam Tip Sheet information adapted from material provided by the Industrial Energy Extension Service of Georgia Tech and reviewed by the DOE BestPractices Steam Technical Subcommittee. For additional information on steam system efficiency measures, contact the OIT Clearinghouse at (800) 862-2086.



OFFICE OF INDUSTRIAL TECHNOLOGIES
ENERGY EFFICIENCY AND RENEWABLE ENERGY • U.S. DEPARTMENT OF ENERGY

About DOE's Office of Industrial Technologies

The Office of Industrial Technologies (OIT), through partnerships with industry, government, and non-governmental organizations, develops and delivers advanced energy efficiency, renewable energy, and pollution prevention technologies for industrial applications. OIT is part of the U.S. Department of Energy's Office of Energy Efficiency and Renewable Energy.

OIT encourages industry-wide efforts to boost resource productivity through a strategy called Industries of the Future (IOF). IOF focuses on the following nine energy- and resource-intensive industries:

- Agriculture
- Aluminum
- Chemicals
- Forest Products
- Glass
- Metal Casting
- Mining
- Petroleum
- Steel

OIT and its BestPractices program offer a wide variety of resources to industrial partners that cover motor, steam, compressed air, and process heating systems. For example, BestPractices software can help you decide whether to replace or rewind motors (MotorMaster+), assess the efficiency of pumping systems (PSAT), compressed air systems (AirMaster+), steam systems (Steam Scoping Tool), or determine optimal insulation thickness for pipes and pressure vessels (3E Plus). Training is available to help you or your staff learn how to use these software programs and learn more about industrial systems. Workshops are held around the country on topics such as "Capturing the Value of Steam Efficiency," "Fundamentals and Advanced Management of Compressed Air Systems," and "Motor System Management." Available technical publications range from case studies and tip sheets to sourcebooks and market assessments. The *Energy Matters* newsletter, for example, provides timely articles and information on comprehensive energy systems for industry. You can access these resources and more by visiting the BestPractices Web site at www.oit.doe.gov/bestpractices or by contacting the OIT Clearinghouse at 800-862-2086 or via email at clearinghouse@ee.doe.gov.



BestPractices is part of the Office of Industrial Technologies' (OIT's) Industries of the Future strategy, which helps the country's most energy-intensive industries improve their competitiveness. BestPractices brings together the best-available and emerging technologies and practices to help companies begin improving energy efficiency, environmental performance, and productivity right now.

BestPractices emphasizes plant systems, where significant efficiency improvements and savings can be achieved. Industry gains easy access to near-term and long-term solutions for improving the performance of motor, steam, compressed air, and process heating systems. In addition, the Industrial Assessment Centers provide comprehensive industrial energy evaluations to small and medium-size manufacturers.

FOR ADDITIONAL INFORMATION, PLEASE CONTACT:

Peter Salmon-Cox
Office of Industrial Technologies
Phone: (202) 586-2380
Fax: (202) 586-6507
Peter.Salmon-Cox@hq.doe.gov
www.oit.doe.gov/bestpractices

OIT Clearinghouse
Phone: (800) 862-2086
Fax: (360) 586-8303
clearinghouse@ee.doe.gov

Please send any comments, questions, or suggestions to webmaster.oit@ee.doe.gov

Visit our home page at www.oit.doe.gov

Office of Industrial Technologies
Energy Efficiency
and Renewable Energy
U.S. Department of Energy
Washington, DC 20585-0121



DOE/GO-10099-733
June 1999
Steam Tip Sheet #1

Energy Tips

Tip Sheet #2 • June 1999



Steam



Motors



Compressed Air

Insulation Optimization Software Available

The North American Insulation Manufacturers Association has developed a software package (3EPlus) that determines the optimum thickness for a wide variety of insulating materials. Outputs include the simple payback period, surface heat loss, and surface temperature for each specified insulation thickness. 3EPlus is available at no cost through the Information Clearinghouse.

Use Insulating Jackets

Removable insulating jackets are available for valves, flanges, steam traps, and other fittings. Remember that a 6-inch gate valve may have over 6 square feet of surface area from which to radiate heat.

Steam Tip Sheet information adapted from material provided by the Industrial Energy Extension Service of Georgia Tech and reviewed by the DOE BestPractices Steam Technical Subcommittee. For additional information on steam system efficiency measures, contact the OIT Clearinghouse at (800) 862-2086.



Insulate Steam Distribution and Condensate Return Lines

Uninsulated steam distribution and condensate return lines are a constant source of wasted energy. The table shows typical heat loss from uninsulated steam distribution lines. Insulation can typically reduce energy losses by 90% and help ensure proper steam pressure at plant equipment. Any surface over 120°F should be insulated, including boiler surfaces, steam and condensate return piping, and fittings.

Insulation frequently becomes damaged or is removed and never replaced during steam system repair. Damaged or wet insulation should be repaired or immediately replaced to avoid compromising the insulating value. Eliminate sources of moisture prior to insulation replacement. Causes of wet insulation include leaking valves, external pipe leaks, tube leaks, or leaks from adjacent equipment. After steam lines are insulated, changes in heat flows can influence other parts of the steam system.

Heat Loss per 100 feet of Uninsulated Steam Line

Distribution Line Diameter (inches)	Heat Loss per 100 feet of Uninsulated Steam Line (MMBtu/yr)			
	Steam Pressure (psig)			
	15	150	300	600
1	140	285	375	495
2	235	480	630	840
4	415	850	1,120	1,500
8	740	1,540	2,030	2,725
12	1,055	2,200	2,910	3,920

Based on horizontal steel pipe, 75°F ambient air, no wind velocity, and 8,760 operating hr/yr.

Example

In a plant where the value of steam is \$4.50/MMBtu, a survey of the steam system identified 1,120 feet of bare 1-inch diameter steam line, and 175 feet of bare 2-inch line both operating at 150 psig. An additional 250 feet of bare 4-inch diameter line operating at 15 psig was found. From the table, the quantity of heat lost per year is:

1-inch line: 1,120 feet x 285 MMBtu/yr per 100 ft = 3,192 MMBtu/yr

2-inch line: 175 feet x 480 MMBtu/yr per 100 ft = 840 MMBtu/yr

4-inch line: 250 feet x 415 MMBtu/yr per 100 ft = 1,037 MMBtu/yr

Total Heat Loss = 5,069 MMBtu/yr

The annual operating cost savings from installing 90% efficient insulation is:

$$0.90 \times \$4.50/\text{MMBtu} \times 5,069 \text{ MMBtu/yr} = \$20,530$$

Suggested Actions

Conduct a survey of your steam distribution and condensate return piping, install insulation, and start to save.

OFFICE OF INDUSTRIAL TECHNOLOGIES
ENERGY EFFICIENCY AND RENEWABLE ENERGY • U.S. DEPARTMENT OF ENERGY

About DOE's Office of Industrial Technologies

The Office of Industrial Technologies (OIT), through partnerships with industry, government, and non-governmental organizations, develops and delivers advanced energy efficiency, renewable energy, and pollution prevention technologies for industrial applications. OIT is part of the U.S. Department of Energy's Office of Energy Efficiency and Renewable Energy.

OIT encourages industry-wide efforts to boost resource productivity through a strategy called Industries of the Future (IOF). IOF focuses on the following nine energy- and resource-intensive industries:

- Agriculture
- Aluminum
- Chemicals
- Forest Products
- Glass
- Metal Casting
- Mining
- Petroleum
- Steel

OIT and its BestPractices program offer a wide variety of resources to industrial partners that cover motor, steam, compressed air, and process heating systems. For example, BestPractices software can help you decide whether to replace or rewind motors (MotorMaster+), assess the efficiency of pumping systems (PSAT), compressed air systems (AirMaster+), steam systems (Steam Scoping Tool), or determine optimal insulation thickness for pipes and pressure vessels (3E Plus). Training is available to help you or your staff learn how to use these software programs and learn more about industrial systems. Workshops are held around the country on topics such as "Capturing the Value of Steam Efficiency," "Fundamentals and Advanced Management of Compressed Air Systems," and "Motor System Management." Available technical publications range from case studies and tip sheets to sourcebooks and market assessments. The *Energy Matters* newsletter, for example, provides timely articles and information on comprehensive energy systems for industry. You can access these resources and more by visiting the BestPractices Web site at www.oit.doe.gov/bestpractices or by contacting the OIT Clearinghouse at 800-862-2086 or via email at clearinghouse@ee.doe.gov.



BestPractices is part of the Office of Industrial Technologies' (OIT's) Industries of the Future strategy, which helps the country's most energy-intensive industries improve their competitiveness. BestPractices brings together the best-available and emerging technologies and practices to help companies begin improving energy efficiency, environmental performance, and productivity right now.

BestPractices emphasizes plant systems, where significant efficiency improvements and savings can be achieved. Industry gains easy access to near-term and long-term solutions for improving the performance of motor, steam, compressed air, and process heating systems. In addition, the Industrial Assessment Centers provide comprehensive industrial energy evaluations to small and medium-size manufacturers.

FOR ADDITIONAL INFORMATION, PLEASE CONTACT:

Peter Salmon-Cox
Office of Industrial Technologies
Phone: (202) 586-2380
Fax: (202) 586-6507
Peter.Salmon-Cox@hq.doe.gov
www.oit.doe.gov/bestpractices

OIT Clearinghouse
Phone: (800) 862-2086
Fax: (360) 586-8303
clearinghouse@ee.doe.gov

Please send any comments, questions, or suggestions to webmaster.oit@ee.doe.gov

Visit our home page at www.oit.doe.gov

Office of Industrial Technologies
Energy Efficiency
and Renewable Energy
U.S. Department of Energy
Washington, DC 20585-0121



DOE/GO-10099-807
June 1999
Steam Tip Sheet #2

Energy Tips

Tip Sheet #3 • June 1999



Steam



Motors



Compressed Air

Exhaust Gas Temperature Limits

The lowest temperature to which flue gases can be cooled depends on the type of fuel used: 250°F for natural gas, 300°F for coal and low sulphur content fuel oils, and 350°F for high sulphur fuel oils. These limits are set to prevent condensation and possible corrosion of the stack.

Potential Economizer Applications

A feedwater economizer is appropriate when insufficient heat transfer surface exists within the boiler to remove combustion heat. Boilers that exceed 100 boiler hp, operating at pressures exceeding 75 psig or above, and that are significantly loaded all year long are excellent candidates for an economizer retrofit.

Steam Tip Sheet information adapted from material provided by the Industrial Energy Extension Service of Georgia Tech and reviewed by the DOE BestPractices Steam Technical Subcommittee. For additional information on steam system efficiency measures, contact the OIT Clearinghouse at (800) 862-2086.



Use Feedwater Economizers for Waste Heat Recovery

A feedwater economizer reduces steam boiler fuel requirements by transferring heat from the flue gas to incoming feedwater. Boiler flue gases are often rejected to the stack at temperatures more than 100°F to 150°F higher than the temperature of the generated steam. Generally, boiler efficiency can be increased by 1% for every 40°F reduction in flue gas temperature. By recovering waste heat, an economizer can often reduce fuel requirements by 5% to 10% and pay for itself in less than 2 years. The table provides examples of the potential for heat recovery.

Recoverable Heat from Boiler Flue Gases				
Initial Stack Gas Temperature, °F	Recoverable Heat, MMBtu/hr			
	Boiler Thermal Output, MMBtu/hr			
	25	50	100	200
400	1.3	2.6	5.3	10.6
500	2.3	4.6	9.2	18.4
600	3.3	6.5	13.0	26.1

Based on natural gas fuel, 15% excess air, and a final stack temperature of 250°F.

Example

A boiler generates 45,000 lb/hr of 150 psig steam by burning natural gas. Condensate is returned to the boiler and mixed with makeup water to yield 117°F feedwater. The stack temperature is measured at 500°F. Determine the annual energy savings that will be achieved by installing an economizer given 8,400 hours per year of boiler operation at an energy cost of \$4.50/MMBtu.

From the steam tables, the following enthalpy values are available:

For 150 psig saturated steam: 1,195.5 Btu/lb

For 117°F feedwater: 84.97 Btu/lb

Boiler thermal output = 45,000 lb/hr × (1,195.5 – 84.97) Btu/lb = 50 million Btu/hr

The recoverable heat corresponding to a stack temperature of 500°F and a natural gas-fired boiler load of 50 MMBtu/hr is read from the table (above) as 4.6 MMBtu/hr.

Annual savings = 4.6 MMBtu/hr × \$4.50/MMBtu × 8,400 hr/yr = \$173,880/yr

Suggested Actions

- Determine the stack temperature after the boiler has been tuned to manufacturer's specifications. The boiler should be operating at close-to-optimum excess air levels with all heat transfer surfaces clean.
- Determine the minimum temperature to which stack gases can be cooled subject to criteria such as dew point, cold-end corrosion, and economic heat transfer surface. (See sidebar: Exhaust Gas Temperature Limits.)
- Study the cost-effectiveness of installing a feedwater economizer or air preheater in your boiler.

OFFICE OF INDUSTRIAL TECHNOLOGIES
ENERGY EFFICIENCY AND RENEWABLE ENERGY • U.S. DEPARTMENT OF ENERGY

About DOE's Office of Industrial Technologies

The Office of Industrial Technologies (OIT), through partnerships with industry, government, and non-governmental organizations, develops and delivers advanced energy efficiency, renewable energy, and pollution prevention technologies for industrial applications. OIT is part of the U.S. Department of Energy's Office of Energy Efficiency and Renewable Energy.

OIT encourages industry-wide efforts to boost resource productivity through a strategy called Industries of the Future (IOF). IOF focuses on the following nine energy- and resource-intensive industries:

- Agriculture
- Aluminum
- Chemicals
- Forest Products
- Glass
- Metal Casting
- Mining
- Petroleum
- Steel

OIT and its BestPractices program offer a wide variety of resources to industrial partners that cover motor, steam, compressed air, and process heating systems. For example, BestPractices software can help you decide whether to replace or rewind motors (MotorMaster+), assess the efficiency of pumping systems (PSAT), compressed air systems (AirMaster+), steam systems (Steam Scoping Tool), or determine optimal insulation thickness for pipes and pressure vessels (3E Plus). Training is available to help you or your staff learn how to use these software programs and learn more about industrial systems. Workshops are held around the country on topics such as "Capturing the Value of Steam Efficiency," "Fundamentals and Advanced Management of Compressed Air Systems," and "Motor System Management." Available technical publications range from case studies and tip sheets to sourcebooks and market assessments. The *Energy Matters* newsletter, for example, provides timely articles and information on comprehensive energy systems for industry. You can access these resources and more by visiting the BestPractices Web site at www.oit.doe.gov/bestpractices or by contacting the OIT Clearinghouse at 800-862-2086 or via email at clearinghouse@ee.doe.gov.



BestPractices is part of the Office of Industrial Technologies' (OIT's) Industries of the Future strategy, which helps the country's most energy-intensive industries improve their competitiveness. BestPractices brings together the best-available and emerging technologies and practices to help companies begin improving energy efficiency, environmental performance, and productivity right now.

BestPractices emphasizes plant systems, where significant efficiency improvements and savings can be achieved. Industry gains easy access to near-term and long-term solutions for improving the performance of motor, steam, compressed air, and process heating systems. In addition, the Industrial Assessment Centers provide comprehensive industrial energy evaluations to small and medium-size manufacturers.

FOR ADDITIONAL INFORMATION, PLEASE CONTACT:

Peter Salmon-Cox
Office of Industrial Technologies
Phone: (202) 586-2380
Fax: (202) 586-6507
Peter.Salmon-Cox@hq.doe.gov
www.oit.doe.gov/bestpractices

OIT Clearinghouse
Phone: (800) 862-2086
Fax: (360) 586-8303
clearinghouse@ee.doe.gov

Please send any comments, questions, or suggestions to webmaster.oit@ee.doe.gov

Visit our home page at www.oit.doe.gov

Office of Industrial Technologies
Energy Efficiency
and Renewable Energy
U.S. Department of Energy
Washington, DC 20585-0121



DOE/GO-10099-809
June 1999
Steam Tip Sheet #3

Energy Tips

Tip Sheet #4 • June 1999



Steam



Motors



Compressed Air

Flue Gas Analyzers

The percentage of oxygen in the flue gas can be measured by inexpensive gas-absorbing test kits. More expensive (\$500-\$1,000) hand-held, computer-based analyzers display percent oxygen, stack gas temperature, and boiler efficiency. They are a recommended investment for any boiler system with annual fuel costs exceeding \$50,000.

Oxygen Trim Systems

When fuel composition is highly variable (such as refinery gas, hog fuel, or multi-fuel boilers), or where steam flows are highly variable, an on-line oxygen analyzer should be considered. The oxygen "trim" system provides feedback to the burner controls to automatically minimize excess combustion air and optimize the air-to-fuel ratio.

Steam Tip Sheet information adapted from material provided by the Industrial Energy Extension Service of Georgia Tech and reviewed by the DOE BestPractices Steam Technical Subcommittee. For additional information on steam system efficiency measures, contact the OIT Clearinghouse at (800) 862-2086.



Improve Your Boiler's Combustion Efficiency

Combustion Efficiency

Operating your boiler with an optimum amount of excess air will minimize heat loss up the stack and improve combustion efficiency. Combustion efficiency is a measure of how effectively the heat content of a fuel is transferred into usable heat. The stack temperature and flue gas oxygen (or carbon dioxide) concentrations are primary indicators of combustion efficiency.

Given complete mixing, a precise or stoichiometric amount of air is required to completely react with a given quantity of fuel. In practice, combustion conditions are never ideal, and additional or "excess" air must be supplied to completely burn the fuel.

The correct amount of excess air is determined from analyzing flue gas oxygen or carbon dioxide concentrations. Inadequate excess air results in unburned combustibles (fuel, soot, smoke, and carbon monoxide) while too much results in heat lost due to the increased flue gas flow—thus lowering the overall boiler fuel-to-steam efficiency. The table relates stack readings to boiler performance.

Excess %		Combustion Efficiency				
		Flue gas temperature less combustion air temp, °F				
Air	Oxygen	200	300	400	500	600
9.5	2.0	85.4	83.1	80.8	78.4	76.0
15.0	3.0	85.2	82.8	80.4	77.9	75.4
28.1	5.0	84.7	82.1	79.5	76.7	74.0
44.9	7.0	84.1	81.2	78.2	75.2	72.1
81.6	10.0	82.8	79.3	75.6	71.9	68.2

Assumes complete combustion with no water vapor in the combustion air.

On well-designed natural gas-fired systems, an excess air level of 10% is attainable. An often stated rule of thumb is that boiler efficiency can be increased by 1% for each 15% reduction in excess air or 40°F reduction in stack gas temperature.

Example

A boiler operates for 8,000 hours per year and consumes 500,000 MMBtu of natural gas while producing 45,000 lb/hr of 150 psig steam. Stack gas measurements indicate an excess air level of 44.9% with a flue gas less combustion air temperature of 400°F. From the table, the boiler combustion efficiency is 78.2% (E1). Tuning the boiler reduces the excess air to 9.5% with a flue gas less combustion air temperature of 300°F. The boiler combustion efficiency increases to 83.1% (E2). Assuming a steam value of \$4.50/MMBtu, the annual cost savings are:

$$\begin{aligned} \text{Cost Savings} &= \text{Fuel Consumption} \times (1 - E1/E2) \times \text{steam cost} \\ &= 29,482 \text{ MMBtu/yr} \times \$4.50/\text{MMBtu} = \$132,671 \text{ annually} \end{aligned}$$

Suggested Actions

Boilers often operate at excess air levels higher than the optimum. Periodically monitor flue gas composition and tune your boilers to maintain excess air at optimum levels.

OFFICE OF INDUSTRIAL TECHNOLOGIES
ENERGY EFFICIENCY AND RENEWABLE ENERGY • U.S. DEPARTMENT OF ENERGY

About DOE's Office of Industrial Technologies

The Office of Industrial Technologies (OIT), through partnerships with industry, government, and non-governmental organizations, develops and delivers advanced energy efficiency, renewable energy, and pollution prevention technologies for industrial applications. OIT is part of the U.S. Department of Energy's Office of Energy Efficiency and Renewable Energy.

OIT encourages industry-wide efforts to boost resource productivity through a strategy called Industries of the Future (IOF). IOF focuses on the following nine energy- and resource-intensive industries:

- Agriculture
- Aluminum
- Chemicals
- Forest Products
- Glass
- Metal Casting
- Mining
- Petroleum
- Steel

OIT and its BestPractices program offer a wide variety of resources to industrial partners that cover motor, steam, compressed air, and process heating systems. For example, BestPractices software can help you decide whether to replace or rewind motors (MotorMaster+), assess the efficiency of pumping systems (PSAT), compressed air systems (AirMaster+), steam systems (Steam Scoping Tool), or determine optimal insulation thickness for pipes and pressure vessels (3E Plus). Training is available to help you or your staff learn how to use these software programs and learn more about industrial systems. Workshops are held around the country on topics such as "Capturing the Value of Steam Efficiency," "Fundamentals and Advanced Management of Compressed Air Systems," and "Motor System Management." Available technical publications range from case studies and tip sheets to sourcebooks and market assessments. The *Energy Matters* newsletter, for example, provides timely articles and information on comprehensive energy systems for industry. You can access these resources and more by visiting the BestPractices Web site at www.oit.doe.gov/bestpractices or by contacting the OIT Clearinghouse at 800-862-2086 or via email at clearinghouse@ee.doe.gov.



BestPractices is part of the Office of Industrial Technologies' (OIT's) Industries of the Future strategy, which helps the country's most energy-intensive industries improve their competitiveness. BestPractices brings together the best-available and emerging technologies and practices to help companies begin improving energy efficiency, environmental performance, and productivity right now.

BestPractices emphasizes plant systems, where significant efficiency improvements and savings can be achieved. Industry gains easy access to near-term and long-term solutions for improving the performance of motor, steam, compressed air, and process heating systems. In addition, the Industrial Assessment Centers provide comprehensive industrial energy evaluations to small and medium-size manufacturers.

FOR ADDITIONAL INFORMATION, PLEASE CONTACT:

Peter Salmon-Cox
Office of Industrial Technologies
Phone: (202) 586-2380
Fax: (202) 586-6507
Peter.Salmon-Cox@hq.doe.gov
www.oit.doe.gov/bestpractices

OIT Clearinghouse
Phone: (800) 862-2086
Fax: (360) 586-8303
clearinghouse@ee.doe.gov

Please send any comments, questions, or suggestions to webmaster.oit@ee.doe.gov

Visit our home page at www.oit.doe.gov

Office of Industrial Technologies
Energy Efficiency
and Renewable Energy
U.S. Department of Energy
Washington, DC 20585-0121



DOE/GO-10099-808
June 1999
Steam Tip Sheet #4

Energy Tips

Tip Sheet #7 • Revised June 2001



Steam



Motors



Compressed Air

Monitor Flue Gas Temperature

An indirect indicator of scale or deposit formation is flue gas temperature. If the flue gas temperature rises (with boiler load and excess air held constant), the effect is possibly due to the presence of scale.

Perform Visual Inspections

Visually inspect boiler tubes when the unit is shut down for maintenance. Scale removal can be achieved by mechanical means or acid cleaning. If scale is present, consult with your local water treatment specialist and consider modifying your feedwater treatment or chemical additives schedule.

Clean Boiler Waterside Heat Transfer Surfaces

Even on small boilers, the prevention of scale formation can produce substantial energy savings. Scale deposits occur when calcium, magnesium, and silica, commonly found in most water supplies, react to form a continuous layer of material on the waterside of the boiler heat exchange tubes.

Scale creates a problem because it typically possesses a thermal conductivity an order of magnitude less than the corresponding value for bare steel. Even thin layers of scale serve as an effective insulator and retard heat transfer. The result is overheating of boiler tube metal, tube failures, and loss of energy efficiency. Fuel waste due to boiler scale may be 2% for water-tube boilers and up to 5% in fire-tube boilers. Energy losses as a function of scale thickness and composition are given in the table below.

Energy Loss Due to Scale Deposits*			
Scale Thickness, inches	Fuel Loss, % of Total Use		
	"Normal"	Scale Type High Iron	Iron Plus Silica
1/64	1.0	1.6	3.5
1/32	2.0	3.1	7.0
3/64	3.0	4.7	–
1/16	3.9	6.2	–

Note: "Normal" scale is usually encountered in low-pressure applications. The high iron and iron plus silica scale composition results from high-pressure service conditions.

*Extracted from National Institute of Standards and Technology, Handbook 115, Supplement 1.

Example

A boiler annually uses 450,000 million Btu (MMBtu) of fuel while operating for 8,000 hours at its rated capacity of 45,000 pounds-per-hour (lbs/hr) of 150-psig steam. If scale 1/32nd of an inch thick is allowed to form on the boiler tubes, and the scale is of "normal" composition, the table indicates a fuel loss of 2%. The increase in operating costs, assuming energy is priced at \$3.00/MMBtu, is:

$$\begin{aligned} \text{Annual Operating Cost Increase} &= 450,000 \text{ MMBtu/year} \times \$3.00/\text{MMBtu} \times 0.02 \\ &= \$27,000 \end{aligned}$$

Steam Tip Sheet information adapted from material provided by the Industrial Energy Extension Service of Georgia Tech and reviewed by the DOE BestPractices Steam Technical Subcommittee. For additional information on steam system efficiency measures, contact the OIT Clearinghouse at (800) 862-2086.



OFFICE OF INDUSTRIAL TECHNOLOGIES
ENERGY EFFICIENCY AND RENEWABLE ENERGY • U.S. DEPARTMENT OF ENERGY

Suggested Actions

Any scale in a boiler is undesirable. The best way to deal with scale is not to let it form in the first place. Scale formation is prevented by:

- Pretreatment of boiler make-up water (using water softeners, demineralizers, and reverse osmosis to remove scale-forming minerals),
- Chemical injection into the boiler feedwater, and
- Adopting proper boiler blowdown practices.



BestPractices is part of the Office of Industrial Technologies' (OIT's) Industries of the Future strategy, which helps the country's most energy-intensive industries improve their competitiveness. BestPractices brings together the best-available and emerging technologies and practices to help companies begin improving energy efficiency, environmental performance, and productivity right now.

BestPractices focuses on plant systems, where significant efficiency improvements and savings can be achieved. Industry gains easy access to near-term and long-term solutions for improving the performance of motor, steam, compressed air, and process heating systems. In addition, the Industrial Assessment Centers provide comprehensive industrial energy evaluations to small and medium-size manufacturers.

FOR ADDITIONAL INFORMATION, PLEASE CONTACT:

Peter Salmon-Cox
Office of Industrial Technologies
Phone: (202) 586-2380
Fax: (202) 586-6507
Peter.Salmon-Cox@hq.doe.gov
www.oit.doe.gov/bestpractices

OIT Clearinghouse
Phone: (800) 862-2086
Fax: (360) 586-8303
clearinghouse@ee.doe.gov

Please send any comments, questions, or suggestions to webmaster.oit@ee.doe.gov

Visit our home page at www.oit.doe.gov

Office of Industrial Technologies
Energy Efficiency
and Renewable Energy
U.S. Department of Energy
Washington, DC 20585-0121



DOE/GO-10099-952
Revised June 2001
Steam Tip Sheet #7

About DOE's Office of Industrial Technologies

The Office of Industrial Technologies (OIT), through partnerships with industry, government, and non-governmental organizations, develops and delivers advanced energy efficiency, renewable energy, and pollution prevention technologies for industrial applications. OIT is part of the U.S. Department of Energy's Office of Energy Efficiency and Renewable Energy.

OIT encourages industry-wide efforts to boost resource productivity through a strategy called Industries of the Future (IOF). IOF focuses on the following nine energy- and resource-intensive industries:

- | | | |
|---------------|-------------------|-------------|
| • Agriculture | • Forest Products | • Mining |
| • Aluminum | • Glass | • Petroleum |
| • Chemicals | • Metal Casting | • Steel |

OIT and its BestPractices program offer a wide variety of resources to industrial partners that cover motor, steam, compressed air, and process heating systems. For example, BestPractices software can help you decide whether to replace or rewind motors (MotorMaster+), assess the efficiency of pumping systems (PSAT), or determine optimal insulation thickness for pipes and pressure vessels (3E Plus). Training is available to help you or your staff learn how to use these software programs and learn more about industrial systems. Workshops are held around the country on topics such as "Capturing the Value of Steam Efficiency," "Fundamentals and Advanced Management of Compressed Air Systems," and "Motor System Management." Available technical publications range from case studies and tip sheets to sourcebooks and market assessments. The *Energy Matters* newsletter, for example, provides timely articles and information on comprehensive energy systems for industry. You can access these resources and more by visiting the BestPractices Web site at www.oit.doe.gov/bestpractices or by contacting the OIT Clearinghouse at 800-862-2086 or via email at clearinghouse@ee.doe.gov.

Energy Tips

Tip Sheet #8 • Revised June 2001



Steam

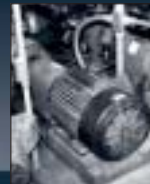

Motors



Compressed Air

Condensate Recovery Produces Savings

A large specialty paper plant reduced its boiler makeup water rate from about 35% of steam production to between 14% and 20% by returning additional condensate. Annual savings added up to more than \$300,000.

Suggested Actions

Reduce operating costs through maximizing the return of hot condensate to the boiler.

Consider the following actions:

- If a condensate return system is absent, estimate the cost of a condensate return and treatment system (as necessary) and install one if economically justified.
- Repair steam distribution and condensate return system leaks.
- Insulate condensate return system piping to conserve heat and protect personnel against burns.

Steam Tip Sheet information adapted from material provided by the Industrial Energy Extension Service of Georgia Tech and reviewed by the DOE BestPractices Steam Technical Subcommittee. For additional information on steam system efficiency measures, contact the OIT Clearinghouse at (800) 862-2086.



Return Condensate to the Boiler

When steam transfers its heat in a manufacturing process, heat exchanger, or heating coil, it reverts to a liquid phase called condensate. An attractive method of improving your power plant's energy efficiency is to increase the condensate return to the boiler.

Returning hot condensate to the boiler makes sense for several reasons. As more condensate is returned, less make-up water is required, saving fuel, make-up water, and chemicals and treatment costs. Less condensate discharged into a sewer system reduces disposal costs. Return of high purity condensate also reduces energy losses due to boiler blowdown. Significant fuel savings occur as most returned condensate is relatively hot (130°F to 225°F), reducing the amount of cold make-up water (50°F to 60°F) that must be heated.

A simple calculation indicates that energy in the condensate can be more than 10% of the total steam energy content of a typical system. The graph shows the heat remaining in the condensate at various condensate temperatures, for a steam system operating at 100 psig, with make-up water at 55°F.

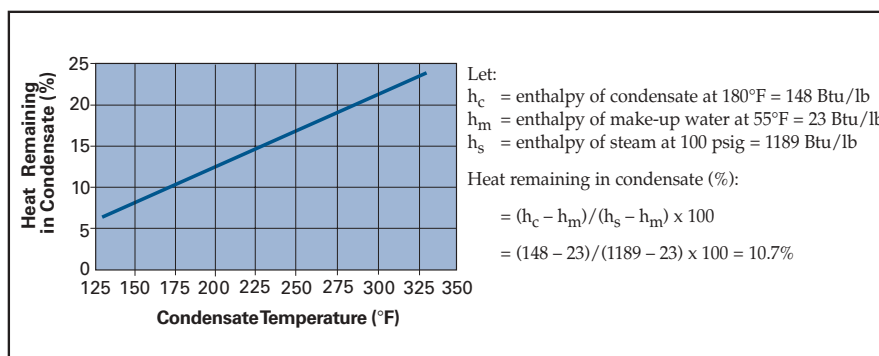

Example

Consider a steam system that returns an additional 10,000 lbs/hr of condensate at 180°F due to distribution modifications. Assume this system operates 8,000 hours annually with an average boiler efficiency of 82%, and make-up water temperature of 55°F. The water and sewage costs for the plant are \$0.002/gal, and the water treatment cost is \$0.002/gal. The fuel cost is \$3.00 per Million Btu (MMBtu). Assuming a 12% flash steam loss*, calculate the overall annual savings.

Annual Water, Sewage, and Chemicals Savings = (1 – Flash Steam Fraction) × (Condensate Load in lbs/hr) × Annual Operating Hours × (Total Water Costs in \$/gal) ÷ (Water Density in lbs/gal)

$$= \frac{(1 - 0.12) \times 10,000 \times 8,000 \times \$0.004}{8.34} = \$33,760$$

*When saturated condensate is reduced to some lower pressure, some condensate flashes off to steam again. This amount is the flash steam loss.

OFFICE OF INDUSTRIAL TECHNOLOGIES
 ENERGY EFFICIENCY AND RENEWABLE ENERGY • U.S. DEPARTMENT OF ENERGY

Annual Fuel Savings = (1 – Flash Steam Fraction) × (Condensate Load in lbs/hr) × Annual Operating Hours × (Makeup Water Temperature rise in °F) × (Fuel Cost in \$/Btu) ÷ Boiler Efficiency

$$= \frac{(1 - 0.12) \times 10,000 \times 8,000 \times (180 - 55) \times \$3.00}{0.82 \times 10^6} = \$32,195$$

Total Annual Savings Due to Return of an Additional 10,000 lbs/hr of Condensate

$$= \$33,760 + \$32,195 = \$65,955$$

About DOE's Office of Industrial Technologies

The Office of Industrial Technologies (OIT), through partnerships with industry, government, and non-governmental organizations, develops and delivers advanced energy efficiency, renewable energy, and pollution prevention technologies for industrial applications. OIT is part of the U.S. Department of Energy's Office of Energy Efficiency and Renewable Energy.

OIT encourages industry-wide efforts to boost resource productivity through a strategy called Industries of the Future (IOF). IOF focuses on the following nine energy- and resource-intensive industries:

- Agriculture
- Aluminum
- Chemicals
- Forest Products
- Glass
- Metal Casting
- Mining
- Petroleum
- Steel

OIT and its BestPractices program offer a wide variety of resources to industrial partners that cover motor, steam, compressed air, and process heating systems. For example, BestPractices software can help you decide whether to replace or rewind motors (MotorMaster+), assess the efficiency of pumping systems (PSAT), or determine optimal insulation thickness for pipes and pressure vessels (3E Plus). Training is available to help you or your staff learn how to use these software programs and learn more about industrial systems. Workshops are held around the country on topics such as "Capturing the Value of Steam Efficiency," "Fundamentals and Advanced Management of Compressed Air Systems," and "Motor System Management." Available technical publications range from case studies and tip sheets to sourcebooks and market assessments. The *Energy Matters* newsletter, for example, provides timely articles and information on comprehensive energy systems for industry. You can access these resources and more by visiting the BestPractices Web site at www.oit.doe.gov/bestpractices or by contacting the OIT Clearinghouse at 800-862-2086 or via email at clearinghouse@ee.doe.gov.



BestPractices is part of the Office of Industrial Technologies' (OIT's) Industries of the Future strategy, which helps the country's most energy-intensive industries improve their competitiveness. BestPractices brings together the best-available and emerging technologies and practices to help companies begin improving energy efficiency, environmental performance, and productivity right now.

BestPractices focuses on plant systems, where significant efficiency improvements and savings can be achieved. Industry gains easy access to near-term and long-term solutions for improving the performance of motor, steam, compressed air, and process heating systems. In addition, the Industrial Assessment Centers provide comprehensive industrial energy evaluations to small and medium-size manufacturers.

FOR ADDITIONAL INFORMATION, PLEASE CONTACT:

Peter Salmon-Cox
Office of Industrial Technologies
Phone: (202) 586-2380
Fax: (202) 586-6507
Peter.Salmon-Cox@hq.doe.gov
www.oit.doe.gov/bestpractices

OIT Clearinghouse
Phone: (800) 862-2086
Fax: (360) 586-8303
clearinghouse@ee.doe.gov

Please send any comments, questions, or suggestions to webmaster.oit@ee.doe.gov

Visit our home page at www.oit.doe.gov

Office of Industrial Technologies
Energy Efficiency
and Renewable Energy
U.S. Department of Energy
Washington, DC 20585-0121



DOE/GO-10099-953
Revised June 2001
Steam Tip Sheet #8

Energy Tips

Tip Sheet #9 • Revised June 2001



Steam



Motors



Compressed Air

Automatic Blowdown Control Systems

These systems optimize surface blowdown by regulating water volume discharged in relation to amount of dissolved solids present. Conductivity, TDS, silica or chlorides concentrations, and/or alkalinity are reliable indicators of salts and other contaminants dissolved in boiler water. A probe provides feedback to a controller driving a modulating blowdown valve. An alternative is proportional control—with blowdown rate set proportional to makeup water flow.

Cycles of Concentration

“Cycles of concentration” refers to the accumulation of impurities in the boiler water. If the boiler water contains ten times the level of impurities in the makeup water, it is said to have ten cycles of concentration.

Steam Tip Sheet information adapted from material provided by the Industrial Energy Extension Service of Georgia Tech and reviewed by the DOE BestPractices Steam Technical Subcommittee. For additional information on steam system efficiency measures, contact the OIT Clearinghouse at (800) 862-2086.



Minimize Boiler Blowdown

Minimizing your blowdown rate can substantially reduce energy losses, as the temperature of the blown-down liquid is the same as that of the steam generated in the boiler. Minimizing blowdown will also reduce makeup water and chemical treatment costs.

As water evaporates in the boiler steam drum, solids present in the feedwater are left behind. The suspended solids form sludge or sediments in the boiler, which degrades heat transfer. Dissolved solids promote foaming and carryover of boiler water into the steam. To reduce the levels of suspended and total dissolved solids (TDS) to acceptable limits, water is periodically discharged or blown down from the boiler. Mud or bottom blowdown is usually a manual procedure done for a few seconds on intervals of several hours. It is designed to remove suspended solids that settle out of the boiler water and form a heavy sludge. Surface or skimming blowdown is designed to remove the dissolved solids that concentrate near the liquid surface. Surface blowdown is often a continuous process.

Insufficient blowdown may lead to carryover of boiler water into the steam, or the formation of deposits. Excessive blowdown will waste energy, water, and chemicals. The optimum blowdown rate is determined by various factors including the boiler type, operating pressure, water treatment, and quality of makeup water. Blowdown rates typically range from 4% to 8% of boiler feedwater flow rate, but can be as high as 10% when makeup water has a high solids content.

Example

Assume that the installation of an automatic blowdown control system (see sidebar) reduces your blowdown rate from 8% to 6%. This example assumes a continuously operating natural-gas-fired, 150-psig, 100,000-pound-per-hour steam boiler. Assume a makeup water temperature of 60°F, boiler efficiency of 82%, with fuel valued at \$3.00 per million Btu (MBtu), and the total water, sewage and treatment costs at \$0.004 per gallon. Calculate the total annual cost savings.

$$\begin{aligned} \text{Boiler Feedwater: Initial} &= \frac{100,000}{(1 - 0.08)} = 108,695 \text{ lbs/hr} \\ \text{Final} &= \frac{100,000}{(1 - 0.06)} = 106,383 \text{ lbs/hr} \end{aligned}$$

$$\begin{aligned} \text{Makeup Water Savings} &= 108,695 - 106,383 = 2312 \text{ lbs/hr} \\ \text{Enthalpy of boiler water} &= 338.5 \text{ Btu/lb; for makeup water at } 60^\circ\text{F} = 28 \text{ Btu/lb} \\ \text{Thermal Energy Savings} &= 338.5 - 28 = 310.5 \text{ Btu/lb} \end{aligned}$$

$$\text{Annual Fuel Savings} = \frac{2312 \text{ lbs/hr} \times 8760 \text{ hrs/yr} \times 310.5 \text{ Btu/lb} \times \$3.00/\text{MBtu}}{0.82 \times 10^6} = \$23,007$$

$$\text{Annual Water and Chemical Savings} = \frac{2312 \text{ lbs/hr} \times 8760 \text{ hrs/yr} \times \$0.004/\text{gal}}{8.34 \text{ lbs/gal}} = \$9,714$$

$$\text{Annual Cost Savings} = \$23,007 + \$9,714 = \$32,721$$

OFFICE OF INDUSTRIAL TECHNOLOGIES
ENERGY EFFICIENCY AND RENEWABLE ENERGY • U.S. DEPARTMENT OF ENERGY

Suggested Actions

Review your blowdown practices to identify energy saving opportunities. Examine operating practices for boiler feedwater and blowdown rates developed by the American Society of Mechanical Engineers (ASME). Considerations include operating pressure, steam purity, and deposition control. Consider an automatic blowdown control system (see sidebar).

References and Footnotes

1. "Consensus Operating Practices for Control of Feedwater/Boiler Water Chemistry in Modern Industrial Boilers", published by the ASME, 1994.
2. "Recommended Rules for the Care and Operation of Heating Boilers", Section VI of the ASME Boiler and Pressure Vessel Code, 1995.
3. "Recommended Guidelines for the Care of Power Boilers", Section VII of the ASME Boiler and Pressure Vessel Code, 1995.

About DOE's Office of Industrial Technologies

The Office of Industrial Technologies (OIT), through partnerships with industry, government, and non-governmental organizations, develops and delivers advanced energy efficiency, renewable energy, and pollution prevention technologies for industrial applications. OIT is part of the U.S. Department of Energy's Office of Energy Efficiency and Renewable Energy.

OIT encourages industry-wide efforts to boost resource productivity through a strategy called Industries of the Future (IOF). IOF focuses on the following nine energy- and resource-intensive industries:

- Agriculture
- Aluminum
- Chemicals
- Forest Products
- Glass
- Metal Casting
- Mining
- Petroleum
- Steel

OIT and its BestPractices program offer a wide variety of resources to industrial partners that cover motor, steam, compressed air, and process heating systems. For example, BestPractices software can help you decide whether to replace or rewind motors (MotorMaster+), assess the efficiency of pumping systems (PSAT), or determine optimal insulation thickness for pipes and pressure vessels (3E Plus). Training is available to help you or your staff learn how to use these software programs and learn more about industrial systems. Workshops are held around the country on topics such as "Capturing the Value of Steam Efficiency," "Fundamentals and Advanced Management of Compressed Air Systems," and "Motor System Management." Available technical publications range from case studies and tip sheets to sourcebooks and market assessments. The *Energy Matters* newsletter, for example, provides timely articles and information on comprehensive energy systems for industry. You can access these resources and more by visiting the BestPractices Web site at www.oit.doe.gov/bestpractices or by contacting the OIT Clearinghouse at 800-862-2086 or via email at clearinghouse@ee.doe.gov.



BestPractices is part of the Office of Industrial Technologies' (OIT's) Industries of the Future strategy, which helps the country's most energy-intensive industries improve their competitiveness. BestPractices brings together the best-available and emerging technologies and practices to help companies begin improving energy efficiency, environmental performance, and productivity right now.

BestPractices focuses on plant systems, where significant efficiency improvements and savings can be achieved. Industry gains easy access to near-term and long-term solutions for improving the performance of motor, steam, compressed air, and process heating systems. In addition, the Industrial Assessment Centers provide comprehensive industrial energy evaluations to small and medium-size manufacturers.

FOR ADDITIONAL INFORMATION, PLEASE CONTACT:

Peter Salmon-Cox
Office of Industrial Technologies
Phone: (202) 586-2380
Fax: (202) 586-6507
Peter.Salmon-Cox@hq.doe.gov
www.oit.doe.gov/bestpractices

OIT Clearinghouse
Phone: (800) 862-2086
Fax: (360) 586-8303
clearinghouse@ee.doe.gov

Please send any comments, questions, or suggestions to webmaster.oit@ee.doe.gov

Visit our home page at www.oit.doe.gov

Office of Industrial Technologies
Energy Efficiency
and Renewable Energy
U.S. Department of Energy
Washington, DC 20585-0121



DOE/GO-10099-954
Revised June 2001
Steam Tip Sheet #9

Energy Tips

Tip Sheet #10 • Revised June 2001



Steam



Motors

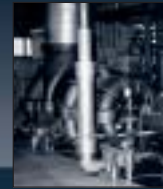

Compressed Air

Blowdown Energy Recovery

Blowdown waste heat can be recovered with a heat exchanger, a flash tank, or flash tank in combination with a heat exchanger. Lowering the pressure in a flash tank allows a portion of the blowdown to be converted into low pressure steam. This low pressure steam is most typically used in deaerators. Drain water from the flash tank is then routed through a heat exchanger. Cooling the blowdown has the additional advantage of helping to comply with local codes limiting the discharge of high temperature liquids into the sewer system.

Recover Heat from Boiler Blowdown

Heat can be recovered from boiler blowdown by using a heat exchanger to preheat boiler makeup water. Any boiler with continuous blowdown exceeding 5% of the steam rate is a good candidate for the introduction of blowdown waste heat recovery. Larger energy savings occur with high-pressure boilers. The following table shows the potential for heat recovery from boiler blowdown.

Recoverable Heat from Boiler Blowdown					
Blowdown Rate, % Boiler Feedwater	Heat Recovered, Million Btu per hour (MMBtu/hr)				
	Boiler Operating Pressure, psig				
	50	100	150	250	300
2	0.45	0.5	0.55	0.65	0.65
4	0.9	1.0	1.1	1.3	1.3
6	1.3	1.5	1.7	1.9	2.0
8	1.7	2.0	2.2	2.6	2.7
10	2.2	2.5	2.8	3.2	3.3
20	4.4	5.0	5.6	6.4	6.6

Based on a steam production rate of 100,000 pounds per hour, 60°F makeup water, and 90% heat recovery.

Example

In a plant where the fuel cost is \$3.00/MMBtu, a continuous blowdown rate of 3,200 pounds per hour (lbs/hr) is maintained to avoid the buildup of high concentrations of dissolved solids. What are the annual savings if a makeup water heat exchanger is installed that recovers 90% of the blowdown energy losses? The 82% efficient boiler produces 50,000 lbs/hr of 150-psig steam. It operates for 8000 hours per year. The blowdown ratio is:

$$\text{Blowdown Ratio} = \frac{3200}{3200 + 50,000} = 6.0\%$$

From the table, the heat recoverable corresponding to a 6% blowdown ratio with a 150-psig boiler operating pressure is 1.8 MMBtu/hr. Since the table is based on a steam production rate of 100,000 lbs/hr, the annual savings for this plant are:

$$\text{Annual Energy Savings} = \frac{1.67 \text{ MMBtu/hr} \times (50,000 \text{ lbs/hr} / 100,000 \text{ lbs/hr}) \times 8000 \text{ hrs/yr}}{0.82} = 8146 \text{ MMBtu}$$

$$\text{Annual Cost Savings} = 8146 \text{ MMBtu/year} \times \$3.00/\text{MMBtu} = \$24,438$$

Steam Tip Sheet information adapted from material provided by the Industrial Energy Extension Service of Georgia Tech and reviewed by the DOE BestPractices Steam Technical Subcommittee. For additional information on steam system efficiency measures, contact the OIT Clearinghouse at (800) 862-2086.



OFFICE OF INDUSTRIAL TECHNOLOGIES
ENERGY EFFICIENCY AND RENEWABLE ENERGY • U.S. DEPARTMENT OF ENERGY

Suggested Actions

If there is a continuous blowdown system in place, consider installing a heat recovery system. If there is a non-continuous blowdown system, then consider the option of converting it to a continuous blowdown system coupled with heat recovery.

About DOE's Office of Industrial Technologies

The Office of Industrial Technologies (OIT), through partnerships with industry, government, and non-governmental organizations, develops and delivers advanced energy efficiency, renewable energy, and pollution prevention technologies for industrial applications. OIT is part of the U.S. Department of Energy's Office of Energy Efficiency and Renewable Energy.

OIT encourages industry-wide efforts to boost resource productivity through a strategy called Industries of the Future (IOF). IOF focuses on the following nine energy- and resource-intensive industries:

- Agriculture
- Aluminum
- Chemicals
- Forest Products
- Glass
- Metal Casting
- Mining
- Petroleum
- Steel

OIT and its BestPractices program offer a wide variety of resources to industrial partners that cover motor, steam, compressed air, and process heating systems. For example, BestPractices software can help you decide whether to replace or rewind motors (MotorMaster+), assess the efficiency of pumping systems (PSAT), or determine optimal insulation thickness for pipes and pressure vessels (3E Plus). Training is available to help you or your staff learn how to use these software programs and learn more about industrial systems. Workshops are held around the country on topics such as "Capturing the Value of Steam Efficiency," "Fundamentals and Advanced Management of Compressed Air Systems," and "Motor System Management." Available technical publications range from case studies and tip sheets to sourcebooks and market assessments. The *Energy Matters* newsletter, for example, provides timely articles and information on comprehensive energy systems for industry. You can access these resources and more by visiting the BestPractices Web site at www.oit.doe.gov/bestpractices or by contacting the OIT Clearinghouse at 800-862-2086 or via email at clearinghouse@ee.doe.gov.



BestPractices is part of the Office of Industrial Technologies' (OIT's) Industries of the Future strategy, which helps the country's most energy-intensive industries improve their competitiveness. BestPractices brings together the best-available and emerging technologies and practices to help companies begin improving energy efficiency, environmental performance, and productivity right now.

BestPractices focuses on plant systems, where significant efficiency improvements and savings can be achieved. Industry gains easy access to near-term and long-term solutions for improving the performance of motor, steam, compressed air, and process heating systems. In addition, the Industrial Assessment Centers provide comprehensive industrial energy evaluations to small and medium-size manufacturers.

FOR ADDITIONAL INFORMATION, PLEASE CONTACT:

Peter Salmon-Cox
Office of Industrial Technologies
Phone: (202) 586-2380
Fax: (202) 586-6507
Peter.Salmon-Cox@hq.doe.gov
www.oit.doe.gov/bestpractices

OIT Clearinghouse
Phone: (800) 862-2086
Fax: (360) 586-8303
clearinghouse@ee.doe.gov

Please send any comments, questions, or suggestions to webmaster.oit@ee.doe.gov

Visit our home page at www.oit.doe.gov

Office of Industrial Technologies
Energy Efficiency
and Renewable Energy
U.S. Department of Energy
Washington, DC 20585-0121



DOE/GO-10099-955
Revised June 2001
Steam Tip Sheet #10

Energy Tips

Tip Sheet #11 • May 2001



Steam



Motors



Compressed Air

Conduct a Pinch Analysis

Based on the actual application, there may be other options to vapor recompression. The industry best practice is to conduct a pinch analysis on the steam system to reveal cost-effective alternatives and optimize steam use by eliminating inefficiencies.

Vapor Recompression Limits

Vapor recompression is limited to applications where the compressor inlet pressure is above atmospheric and the compression ratio is less than two per stage.

System Pressure Boosting

Vapor recompression can be used in steam distribution systems to boost system pressures that have dropped to unacceptably low levels.

Steam Tip Sheet information adapted from material provided by the Industrial Energy Extension Service of Georgia Tech and reviewed by the DOE BestPractices Steam Technical Subcommittee. For additional information on steam system efficiency measures, contact the OIT Clearinghouse at (800) 862-2086.



Use Vapor Recompression to Recover Low-Pressure Waste Steam

Low-pressure steam exhaust from industrial operations such as evaporators or cookers is usually vented to the atmosphere or condensed in a cooling tower. Simultaneously, other plant operations may require intermediate-pressure steam at 20 to 50 pounds per square inch gauge (psig). Instead of letting down high-pressure steam across a throttling valve to meet these needs, low-pressure waste steam can be mechanically compressed or boosted to a higher pressure so that it can be reused.

Vapor recompression relies upon a mechanical compressor or steam jet ejector to increase the temperature of the latent heat in steam to render it usable for process duties. Recompression typically requires only 5 to 10 percent of the energy required to raise an equivalent amount of steam in a boiler.

Energy Required for Steam Recompression

Inlet Pressure (psig)	Compressor Work, Btu/lb of Steam Produced				
	Compression Ratio				
	1.2	1.4	1.6	1.8	2.0
0	17.8	33.2	46.8	58.8	69.6
15	18.6	34.7	48.7	61.2	72.6

Assuming adiabatic compression with a compressor efficiency of 75 percent. 80°F water is sprayed into the steam to eliminate superheat.

Example

Consider a petrochemical plant that vents 15-psig steam to the atmosphere. At the same time, a process imposes a continuous requirement on the boiler for 5,000 lbs/hr of 40-psig steam. If 15-psig waste steam is recompressed to 40 psig by an electrically driven compressor, the compression ratio is:

$$\text{Compression Ratio} = (40 + 14.7) / (15 + 14.7) = 1.84$$

From the table above, the compressor requires 63.5 Btu/lb of delivered steam. Assuming that electricity is priced at \$0.05/kWh, the annual cost of driving the compressor is:

$$\text{Compressor Operating Cost} = 63.5 \text{ Btu/lb} \times 5,000 \text{ lbs/hr} \times 8,760 \text{ hrs/yr} \times \$0.05/\text{kWh} / 3413 \text{ Btu/kWh} = \$40,745/\text{year}$$

If an equivalent quantity of 40-psig steam (enthalpy for saturated steam is 1176 Btu/lb) were to be supplied by an 82-percent efficient natural-gas-fired boiler, the steam production costs with fuel priced at \$4.50/MMBtu and 70°F feedwater (enthalpy is 38 Btu/lb), are:

$$\text{Steam Production Costs} = 5,000 \text{ lbs/year} \times (1176 - 38 \text{ Btu/lb}) \times 8,760 \text{ hrs/yr} \times \$4.50/\text{MMBtu} / 0.82 = \$273,536/\text{year}$$

$$\text{Annual Vapor Recompression Cost Savings} = \$273,536 - \$40,745 = \$232,791$$

OFFICE OF INDUSTRIAL TECHNOLOGIES
ENERGY EFFICIENCY AND RENEWABLE ENERGY • U.S. DEPARTMENT OF ENERGY

Suggested Actions

A vapor recompression project analysis consists of matching recovered waste heat with the need for low-pressure steam for process or space heating. To perform this analysis:

- Conduct a plant audit to identify sources of low-pressure waste steam.
- Estimate the heat recovery potential.
- Inventory all steam-utilizing equipment and list pressure requirements, energy consumption, and patterns of use.
- Estimate the cost-effectiveness of installing recompression equipment and connecting piping.



BestPractices is part of the Office of Industrial Technologies' (OIT's) Industries of the Future strategy, which helps the country's most energy-intensive industries improve their competitiveness. BestPractices brings together the best-available and emerging technologies and practices to help companies begin improving energy efficiency, environmental performance, and productivity right now.

BestPractices focuses on plant systems, where significant efficiency improvements and savings can be achieved. Industry gains easy access to near-term and long-term solutions for improving the performance of motor, steam, compressed air, and process heating systems. In addition, the Industrial Assessment Centers provide comprehensive industrial energy evaluations to small and medium-size manufacturers.

FOR ADDITIONAL INFORMATION, PLEASE CONTACT:

Peter Salmon-Cox
Office of Industrial Technologies
Phone: (202) 586-2380
Fax: (202) 586-6507
Peter.Salmon-Cox@hq.doe.gov
www.oit.doe.gov/bestpractices

OIT Clearinghouse
Phone: (800) 862-2086
Fax: (360) 586-8303
clearinghouse@ee.doe.gov

Please send any comments, questions, or suggestions to webmaster.oit@ee.doe.gov

Visit our home page at www.oit.doe.gov

Office of Industrial Technologies
Energy Efficiency
and Renewable Energy
U.S. Department of Energy
Washington, DC 20585-0121



DOE/GO-102001-1274
May 2001
Steam Tip Sheet #11

About DOE's Office of Industrial Technologies

The Office of Industrial Technologies (OIT), through partnerships with industry, government, and non-governmental organizations, develops and delivers advanced energy efficiency, renewable energy, and pollution prevention technologies for industrial applications. OIT is part of the U.S. Department of Energy's Office of Energy Efficiency and Renewable Energy.

OIT encourages industry-wide efforts to boost resource productivity through a strategy called Industries of the Future (IOF). IOF focuses on the following nine energy- and resource-intensive industries:

- | | | |
|---------------|-------------------|-------------|
| • Agriculture | • Forest Products | • Mining |
| • Aluminum | • Glass | • Petroleum |
| • Chemicals | • Metal Casting | • Steel |

OIT and its BestPractices program offer a wide variety of resources to industrial partners that cover motor, steam, compressed air, and process heating systems. For example, BestPractices software can help you decide whether to replace or rewind motors (MotorMaster+), assess the efficiency of pumping systems (PSAT), or determine optimal insulation thickness for pipes and pressure vessels (3E Plus). Training is available to help you or your staff learn how to use these software programs and learn more about industrial systems. Workshops are held around the country on topics such as "Capturing the Value of Steam Efficiency," "Fundamentals and Advanced Management of Compressed Air Systems," and "Motor System Management." Available technical publications range from case studies and tip sheets to sourcebooks and market assessments. The *Energy Matters* newsletter, for example, provides timely articles and information on comprehensive energy systems for industry. You can access these resources and more by visiting the BestPractices Web site at www.oit.doe.gov/bestpractices or by contacting the OIT Clearinghouse at 800-862-2086 or via email at clearinghouse@ee.doe.gov.

Energy Tips

Tip Sheet #12 • May 2001



Steam

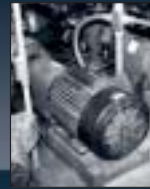

Motors

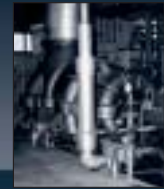

Compressed Air

Proximity Is a Plus

The source of high-pressure condensate should be relatively close to the low-pressure steam header to minimize piping and insulation costs.

Match Availability and Use

The economics of heat recovery projects are most favorable when the waste steam heat content is high and the flow is continuous. Seasonal space heating is not the most desirable end use.

Flash High-Pressure Condensate to Regenerate Low-Pressure Steam

Low-pressure process steam requirements are usually met by throttling high-pressure steam, but a portion of the process requirements can be achieved at low cost by flashing high-pressure condensate. Flashing is particularly attractive when it is not economically feasible to return the high-pressure condensate to the boiler. In the table below, the quantity of steam obtained per pound of condensate flashed is given as a function of both condensate and steam pressures.

High-Pressure Condensate Flashing				
High-Pressure Condensate (psig)	Percent of Condensate Flashed, lb steam/lb condensate			
	Low-Pressure Steam (psig)			
	50	30	15	5
200	10.4	12.8	15.2	17.3
150	7.8	10.3	12.7	14.9
100	4.6	7.1	9.6	11.8
75	2.5	5.1	7.6	9.9

Example

In a plant where the cost of steam is \$4.50 per million Btu (MMBtu), saturated steam at 150 pounds per square inch gauge (psig) is generated, and a portion of it throttled to supply 30-psig steam. Assuming continuous operation, determine the annual energy savings of producing low-pressure steam by flashing 5,000 pounds per hour of 150-psig condensate. The average temperature of the boiler make-up water is 70°F.

From the table above, when 150-psig condensate is flashed at 30 psig, 10.3 percent of the condensate vaporizes.

$$\text{Low-Pressure Steam Produced} = 5,000 \text{ lbs/hr} \times 0.103 = 515 \text{ lbs/hr}$$

From the ASME Steam Tables, the enthalpy values are:

$$\begin{aligned} \text{For 30-psig saturated steam} &= 1171.9 \text{ Btu/lb} \\ \text{For 70°F make-up water} &= 38.0 \text{ Btu/lb} \end{aligned}$$

Annual savings are obtained as follows:

$$\begin{aligned} \text{Annual Savings} &= 515 \text{ lb/hr} \times (1171.9 - 38.0) \text{ Btu/lb} \times 8,760 \text{ hours/year} \times \$4.50/\text{MMBtu} \\ &= \$23,019 \end{aligned}$$

Steam Tip Sheet information adapted from material provided by the Industrial Energy Extension Service of Georgia Tech and reviewed by the DOE BestPractices Steam Technical Subcommittee. For additional information on steam system efficiency measures, contact the OIT Clearinghouse at (800) 862-2086.



OFFICE OF INDUSTRIAL TECHNOLOGIES
ENERGY EFFICIENCY AND RENEWABLE ENERGY • U.S. DEPARTMENT OF ENERGY

Suggested Actions

Determine the potential for high-pressure condensate flashing by completing a plant survey that:

- Identifies all sources of high-pressure condensate.
- Determines condensate flow and duration, as well as the heat recovery potential due to flashed steam production.
- Identifies compatible uses for low-pressure steam.
- Estimates the cost effectiveness of installing appropriate heat-recovery devices and interconnecting piping.

About DOE's Office of Industrial Technologies

The Office of Industrial Technologies (OIT), through partnerships with industry, government, and non-governmental organizations, develops and delivers advanced energy efficiency, renewable energy, and pollution prevention technologies for industrial applications. OIT is part of the U.S. Department of Energy's Office of Energy Efficiency and Renewable Energy.

OIT encourages industry-wide efforts to boost resource productivity through a strategy called Industries of the Future (IOF). IOF focuses on the following nine energy- and resource-intensive industries:

- Agriculture
- Aluminum
- Chemicals
- Forest Products
- Glass
- Metal Casting
- Mining
- Petroleum
- Steel

OIT and its BestPractices program offer a wide variety of resources to industrial partners that cover motor, steam, compressed air, and process heating systems. For example, BestPractices software can help you decide whether to replace or rewind motors (MotorMaster+), assess the efficiency of pumping systems (PSAT), or determine optimal insulation thickness for pipes and pressure vessels (3E Plus). Training is available to help you or your staff learn how to use these software programs and learn more about industrial systems. Workshops are held around the country on topics such as "Capturing the Value of Steam Efficiency," "Fundamentals and Advanced Management of Compressed Air Systems," and "Motor System Management." Available technical publications range from case studies and tip sheets to sourcebooks and market assessments. The *Energy Matters* newsletter, for example, provides timely articles and information on comprehensive energy systems for industry. You can access these resources and more by visiting the BestPractices Web site at www.oit.doe.gov/bestpractices or by contacting the OIT Clearinghouse at 800-862-2086 or via email at clearinghouse@ee.doe.gov.



BestPractices is part of the Office of Industrial Technologies' (OIT's) Industries of the Future strategy, which helps the country's most energy-intensive industries improve their competitiveness. BestPractices brings together the best-available and emerging technologies and practices to help companies begin improving energy efficiency, environmental performance, and productivity right now.

BestPractices focuses on plant systems, where significant efficiency improvements and savings can be achieved. Industry gains easy access to near-term and long-term solutions for improving the performance of motor, steam, compressed air, and process heating systems. In addition, the Industrial Assessment Centers provide comprehensive industrial energy evaluations to small and medium-size manufacturers.

FOR ADDITIONAL INFORMATION, PLEASE CONTACT:

Peter Salmon-Cox
Office of Industrial Technologies
Phone: (202) 586-2380
Fax: (202) 586-6507
Peter.Salmon-Cox@hq.doe.gov
www.oit.doe.gov/bestpractices

OIT Clearinghouse
Phone: (800) 862-2086
Fax: (360) 586-8303
clearinghouse@ee.doe.gov

Please send any comments, questions, or suggestions to webmaster.oit@ee.doe.gov

Visit our home page at www.oit.doe.gov

Office of Industrial Technologies
Energy Efficiency
and Renewable Energy
U.S. Department of Energy
Washington, DC 20585-0121



DOE/GO-102001-1275
May 2001
Steam Tip Sheet #12

Energy Tips

Tip Sheet #13 • May 2001



Steam



Motors



Compressed Air

Distilled Water Recovery

A useful rule of thumb is that every 500 lbs/hr of recovered flash steam provides 1 gallon per minute (gpm) of distilled water.

Materials Considerations

Depending on the specific application, the vent condenser materials can be either all stainless or mild steel shell with copper tubes. For deaerator vent condensing, a stainless steel heat exchanger is recommended to avoid corrosion due to the high concentrations of gases. Mild steel can be used for receiver tank vent condensing.

Steam Tip Sheet information adapted from material provided by the Industrial Energy Extension Service of Georgia Tech and reviewed by the DOE BestPractices Steam Technical Subcommittee. For additional information on steam system efficiency measures, contact the OIT Clearinghouse at (800) 862-2086.



Use a Vent Condenser to Recover Flash Steam Energy

When the pressure of saturated condensate is reduced, a portion of the liquid “flashes” to low-pressure steam. Depending on the pressures involved, the flash steam contains approximately 10 to 40 percent of the energy content of the original condensate. In most cases, including condensate receivers and deaerators, the flashing steam is vented and its energy content lost. However, a heat exchanger can be placed in the vent to recover this energy. The following table indicates the energy content of flash steam at atmospheric pressure.

Energy Recovery Potential of a Vent Condenser					
Pipe Diameter (inches)	Energy Content, MMBtu/year*				
	Steam Velocity, feet/min				
	200	300	400	500	600
2	90	140	185	230	280
4	370	555	740	925	1,110
6	835	1,250	1,665	2,085	2,500
10	2,315	3,470	4,630	5,875	6,945

* Assumes continuous operation, 70°F make-up water, and condensed steam at 100°F.

Example

Consider a vent pipe with the following conditions:

Velocity of flash steam:	300 feet per minute
Diameter of vent pipe:	4 inches
Hours of operation:	8,000 hours per year
Boiler efficiency:	82 percent
Cost of fuel:	\$4.50 per million Btu (MMBtu)

A vent condenser could condense the flashed steam, transfer its thermal energy to incoming make-up water, and then return it to the boiler. Energy is recovered in two forms: hotter make-up water and clean, distilled condensate ready for productive use in your operation.

Referring to the table above, the potential energy recovered from the flashed steam is 555 MMBtu, based on 8,760 hours of annual operation. Correct this value for actual operating hours and boiler efficiency:

$$\begin{aligned} \text{Annual Energy Recovered} &= 555 \text{ MMBtu/year} \times 8,000 \text{ hrs/yr} / 8,760 \text{ hrs/yr} \times 1 / 0.82 \\ &= 618 \text{ MMBtu} \end{aligned}$$

$$\begin{aligned} \text{Annual Potential Fuel Cost Savings} &= 618 \text{ MMBtu/yr} \times \$4.50/\text{MMBtu} \\ &= \$2,781^{**} \end{aligned}$$

** Note that the annual fuel savings are per vent. Often, there are several such vents in a steam facility, and the total savings can be a significantly larger number. The additional heat exchanger cost still needs to be considered, but available literature shows a quick payback for the measure.

OFFICE OF INDUSTRIAL TECHNOLOGIES
ENERGY EFFICIENCY AND RENEWABLE ENERGY • U.S. DEPARTMENT OF ENERGY

Suggested Actions

- Inspect vent pipes of receiver tanks and deaerators for excessive flash steam plumes.
- Re-examine deaerator steam requirements.
- Eliminate remaining flash steam energy loss with a vent condenser.
- Consult manufacturers for materials specifications, as well as size and cost recommendations for the vent condenser.



BestPractices is part of the Office of Industrial Technologies' (OIT's) Industries of the Future strategy, which helps the country's most energy-intensive industries improve their competitiveness. BestPractices brings together the best-available and emerging technologies and practices to help companies begin improving energy efficiency, environmental performance, and productivity right now.

BestPractices focuses on plant systems, where significant efficiency improvements and savings can be achieved. Industry gains easy access to near-term and long-term solutions for improving the performance of motor, steam, compressed air, and process heating systems. In addition, the Industrial Assessment Centers provide comprehensive industrial energy evaluations to small and medium-size manufacturers.

FOR ADDITIONAL INFORMATION, PLEASE CONTACT:

Peter Salmon-Cox
Office of Industrial Technologies
Phone: (202) 586-2380
Fax: (202) 586-6507
Peter.Salmon-Cox@hq.doe.gov
www.oit.doe.gov/bestpractices

OIT Clearinghouse
Phone: (800) 862-2086
Fax: (360) 586-8303
clearinghouse@ee.doe.gov

Please send any comments, questions, or suggestions to webmaster.oit@ee.doe.gov

Visit our home page at www.oit.doe.gov

Office of Industrial Technologies
Energy Efficiency
and Renewable Energy
U.S. Department of Energy
Washington, DC 20585-0121



DOE/GO-102001-1276
May 2001
Steam Tip Sheet #13

About DOE's Office of Industrial Technologies

The Office of Industrial Technologies (OIT), through partnerships with industry, government, and non-governmental organizations, develops and delivers advanced energy efficiency, renewable energy, and pollution prevention technologies for industrial applications. OIT is part of the U.S. Department of Energy's Office of Energy Efficiency and Renewable Energy.

OIT encourages industry-wide efforts to boost resource productivity through a strategy called Industries of the Future (IOF). IOF focuses on the following nine energy- and resource-intensive industries:

- Agriculture
- Aluminum
- Chemicals
- Forest Products
- Glass
- Metal Casting
- Mining
- Petroleum
- Steel

OIT and its BestPractices program offer a wide variety of resources to industrial partners that cover motor, steam, compressed air, and process heating systems. For example, BestPractices software can help you decide whether to replace or rewind motors (MotorMaster+), assess the efficiency of pumping systems (PSAT), or determine optimal insulation thickness for pipes and pressure vessels (3E Plus). Training is available to help you or your staff learn how to use these software programs and learn more about industrial systems. Workshops are held around the country on topics such as "Capturing the Value of Steam Efficiency," "Fundamentals and Advanced Management of Compressed Air Systems," and "Motor System Management." Available technical publications range from case studies and tip sheets to sourcebooks and market assessments. The *Energy Matters* newsletter, for example, provides timely articles and information on comprehensive energy systems for industry. You can access these resources and more by visiting the BestPractices Web site at www.oit.doe.gov/bestpractices or by contacting the OIT Clearinghouse at 800-862-2086 or via email at clearinghouse@ee.doe.gov.

Energy Tips

Tip Sheet #14 • May 2001



Steam

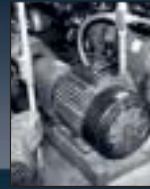

Motors



Compressed Air

Reduce Demand Charges

Absorption chillers can reshape facility thermal and electric load profiles by shifting cooling from an electric to a thermal load. If you are served by an electric utility with a ratcheted demand charge, you may be able to reduce demand charges throughout the year by reducing your summer peak loads.

Utility Incentives

Some gas utilities offer reduced rates during the summer. In some areas, electric utilities provide rebates or incentives to replace mechanical chillers with steam absorption units.

Use Low-Grade Waste Steam to Power Absorption Chillers

Absorption chillers use heat, instead of mechanical energy, to provide cooling. The mechanical vapor compressor is replaced by a thermal compressor (see figure) that consists of an absorber, a generator, a pump, and a throttling device. The refrigerant vapor from the evaporator is absorbed by a solution mixture in the absorber. This solution is then pumped to the generator where the refrigerant is revaporized using a waste steam heat source. The refrigerant-depleted solution is then returned to the absorber via a throttling device. The two most common refrigerant/absorbent mixtures used in absorption chillers are water/lithium bromide and ammonia/water.

Comparison of Mechanical and Thermal Vapor Compression Systems*

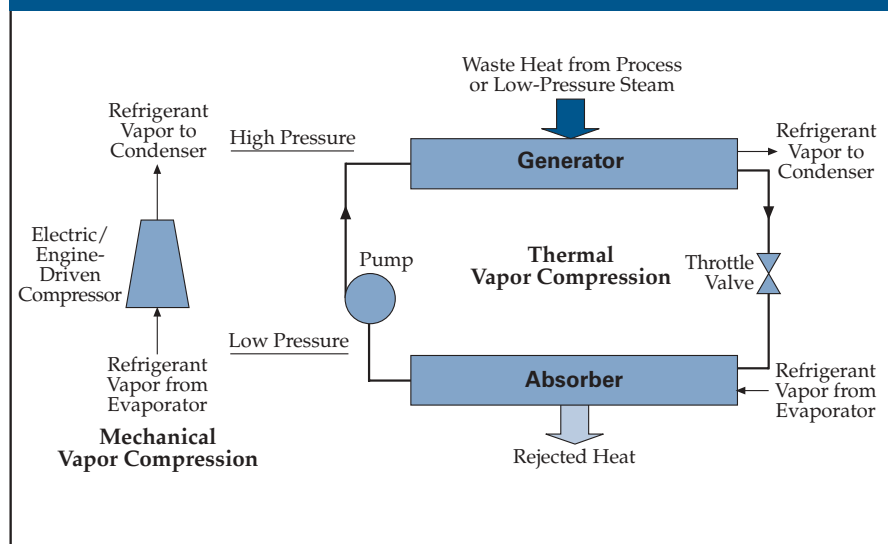

* The evaporator and the condenser, required for both systems, are not shown in the figure.

Compared to mechanical chillers, absorption chillers have a low coefficient of performance (COP = chiller load/heat input). Nonetheless, they can substantially reduce operating costs because they are energized by low-grade waste heat, while vapor compression chillers must be motor- or engine-driven.

Low-pressure, steam-driven absorption chillers are available in capacities ranging from 100 to 1,500 tons. Absorption chillers come in two commercially available designs: single-effect and double-effect. Single-effect machines provide a thermal COP of 0.7 and require about 18 pounds of 15-psig steam per ton-hour of cooling. Double-effect machines are about 40 percent more efficient, but require a higher grade of thermal input, using about 10 pounds of 100- to 150-psig steam per ton-hour.

Steam Tip Sheet information adapted from material provided by the Industrial Energy Extension Service of Georgia Tech and reviewed by the DOE BestPractices Steam Technical Subcommittee. For additional information on steam system efficiency measures, contact the OIT Clearinghouse at (800) 862-2086.



OFFICE OF INDUSTRIAL TECHNOLOGIES
ENERGY EFFICIENCY AND RENEWABLE ENERGY • U.S. DEPARTMENT OF ENERGY

Example

In a plant where low-pressure steam is currently being exhausted to the atmosphere, a mechanical chiller with a COP of 4.0 is used 4,000 hours per year to produce an average of 300 tons of refrigeration. The cost of electricity at the plant is \$0.05 per kilowatt-hour.

An absorption unit requiring 5,400 lbs/hr of 15-psig steam could replace the mechanical chiller, providing annual electrical cost savings of:

Annual Savings = 300 tons x (12,000 Btu/ton / 4.0) x 4,000 hrs/year x \$0.05/kWh x kWh/3,413 Btu = \$52,740

Suggested Actions

Determine the cost-effectiveness of displacing a portion of your cooling load with a waste steam absorption chiller by taking the following steps:

- Conduct a plant survey to identify sources and availability of waste steam.
- Determine cooling load requirements and the cost of meeting those requirements with existing mechanical chillers or new installations.
- Obtain installed cost quotes for a waste steam absorption chiller.
- Conduct a life cycle cost analysis to determine if the waste steam absorption chiller meets your company's cost-effectiveness criteria.

About DOE's Office of Industrial Technologies

The Office of Industrial Technologies (OIT), through partnerships with industry, government, and non-governmental organizations, develops and delivers advanced energy efficiency, renewable energy, and pollution prevention technologies for industrial applications. OIT is part of the U.S. Department of Energy's Office of Energy Efficiency and Renewable Energy.

OIT encourages industry-wide efforts to boost resource productivity through a strategy called Industries of the Future (IOF). IOF focuses on the following nine energy- and resource-intensive industries:

- | | | |
|---------------|-------------------|-------------|
| • Agriculture | • Forest Products | • Mining |
| • Aluminum | • Glass | • Petroleum |
| • Chemicals | • Metal Casting | • Steel |

OIT and its BestPractices program offer a wide variety of resources to industrial partners that cover motor, steam, compressed air, and process heating systems. For example, BestPractices software can help you decide whether to replace or rewind motors (MotorMaster+), assess the efficiency of pumping systems (PSAT), or determine optimal insulation thickness for pipes and pressure vessels (3E Plus). Training is available to help you or your staff learn how to use these software programs and learn more about industrial systems. Workshops are held around the country on topics such as "Capturing the Value of Steam Efficiency," "Fundamentals and Advanced Management of Compressed Air Systems," and "Motor System Management." Available technical publications range from case studies and tip sheets to sourcebooks and market assessments. The *Energy Matters* newsletter, for example, provides timely articles and information on comprehensive energy systems for industry. You can access these resources and more by visiting the BestPractices Web site at www.oit.doe.gov/bestpractices or by contacting the OIT Clearinghouse at 800-862-2086 or via email at clearinghouse@ee.doe.gov.



BestPractices is part of the Office of Industrial Technologies' (OIT's) Industries of the Future strategy, which helps the country's most energy-intensive industries improve their competitiveness. BestPractices brings together the best-available and emerging technologies and practices to help companies begin improving energy efficiency, environmental performance, and productivity right now.

BestPractices focuses on plant systems, where significant efficiency improvements and savings can be achieved. Industry gains easy access to near-term and long-term solutions for improving the performance of motor, steam, compressed air, and process heating systems. In addition, the Industrial Assessment Centers provide comprehensive industrial energy evaluations to small and medium-size manufacturers.

FOR ADDITIONAL INFORMATION, PLEASE CONTACT:

Peter Salmon-Cox
Office of Industrial Technologies
Phone: (202) 586-2380
Fax: (202) 586-6507
Peter.Salmon-Cox@hq.doe.gov
www.oit.doe.gov/bestpractices

OIT Clearinghouse
Phone: (800) 862-2086
Fax: (360) 586-8303
clearinghouse@ee.doe.gov

Please send any comments, questions, or suggestions to webmaster.oit@ee.doe.gov

Visit our home page at www.oit.doe.gov

Office of Industrial Technologies
Energy Efficiency
and Renewable Energy
U.S. Department of Energy
Washington, DC 20585-0121



DOE/GO-102001-1277
May 2001
Steam Tip Sheet #14

Energy Tips

Tip Sheet #15 • December 2000



Steam



Motors



Compressed Air

Effective Cost of Steam

The effective cost of steam depends on the path it follows from the boiler to the point of use. Take a systems approach and consider the entire boiler island, including effect of blow-down, parasitic steam consumption, deaeration, etc. Further complications arise due to the process steam loads at different pressures, multiple boilers, and waste heat recovery systems. To determine the effective cost of steam, use a combined heat and power simulation model that includes all the significant effects.

Multi-Fuel Capability

For multi-fuel capability boilers, take advantage of volatility in fuel prices by periodically analyzing the steam generation cost and use the fuel that provides the lowest steam generation cost.

Higher Versus Lower Heating Values

Fuel is sold based on its gross or higher heating value (HHV). If, at the end of the combustion process, water remains in the form of vapor, the HHV must be reduced by the latent heat of vaporization of water. This reduced value is known as the lower heating value (LHV).

Steam Tip Sheet information has been reviewed by the DOE BestPractices Steam Technical Subcommittee. For additional information on industrial energy efficiency measures, contact the OIT Clearinghouse at (800) 862-2086.



Benchmark the Fuel Cost of Steam Generation

Benchmarking the fuel cost of steam generation (\$/1000 lbs of steam) is an effective way to assess the efficiency of your steam system. This cost is dependent upon fuel type, unit fuel cost, boiler efficiency, feedwater temperature, and steam pressure. This calculation provides a good first approximation for the cost of generating steam and serves as a tracking device to allow for boiler performance monitoring. Table 1 shows the heat input required to produce one pound of saturated steam at different operating pressures and varying feedwater temperatures. Table 2 lists the typical energy content and boiler combustion efficiency for several common fuels.

Table 1. Energy Required to Produce One Pound of Saturated Steam (Btu)*

Operating Pressure, psig	Feedwater Temperature, °F				
	50	100	150	200	250
150	1,178	1,128	1,078	1,028	977
450	1,187	1,137	1,087	1,037	986
600	1,184	1,134	1,084	1,034	984

* Calculated from steam tables based on the difference between the enthalpies of saturated steam and feedwater.

Table 2. Energy Content and Combustion Efficiency of Fuels

Fuel Type (sales unit)	Energy Content (Btu/sales unit)	Combustion Efficiency (%)
Natural Gas (therm)	100,000	81.7
Natural Gas (cubic foot)	1,030	81.7
Distillate/No. 2 Oil (gallon)	138,700	84.6
Residual/No. 6 Oil (gallon)	149,700	86.1
Coal (ton)	27,000,000	87.6

Note: Combustion efficiency is based on boilers equipped with economizers and air preheaters and 3% oxygen in flue gas.

Data from the above tables can be used to determine the cost of usable heat from a boiler or other combustion unit. The calculations can also include operating costs of accessories such as feedwater pumps, fans, fuel heaters, steam for fuel atomizers and soot blowing, treatment chemicals, and environmental and maintenance costs.

Example

A boiler, fired with natural gas costing \$0.30/therm, produces 450 psig saturated steam and is supplied with 230°F feedwater. Using values from the tables, calculate the cost of producing steam.

$$\text{Steam Cost} = \frac{0.3 (\$/\text{therm})}{100,000 (\text{Btu}/\text{therm})} \times 1000 \times 1006 (\text{Btu}/\text{lb}) \times \frac{100}{81.7} = \$3.69/1000 \text{ lbs}$$

Suggested Actions

- Determine your annual fuel costs based on utility bills.
- Install a steam flowmeter in your facility and calculate your steam generation cost. Compare this with the benchmark value.
- Using a systems approach, do a thermoeconomic analysis to determine the effective cost of steam. (See sidebar: Effective Cost of Steam)

OFFICE OF INDUSTRIAL TECHNOLOGIES
ENERGY EFFICIENCY AND RENEWABLE ENERGY • U.S. DEPARTMENT OF ENERGY

About DOE's Office of Industrial Technologies

The Office of Industrial Technologies (OIT), through partnerships with industry, government, and non-governmental organizations, develops and delivers advanced energy efficiency, renewable energy, and pollution prevention technologies for industrial applications. OIT is part of the U.S. Department of Energy's Office of Energy Efficiency and Renewable Energy.

OIT encourages industry-wide efforts to boost resource productivity through a strategy called Industries of the Future (IOF). IOF focuses on the following nine energy- and resource-intensive industries:

- Agriculture
- Aluminum
- Chemicals
- Forest Products
- Glass
- Metal Casting
- Mining
- Petroleum
- Steel

OIT and its BestPractices program offer a wide variety of resources to industrial partners that cover motor, steam, compressed air, and process heating systems. For example, BestPractices software can help you decide whether to replace or rewind motors (MotorMaster+), assess the efficiency of pumping systems (PSAT), compressed air systems (AirMaster+), steam systems (Steam Scoping Tool), or determine optimal insulation thickness for pipes and pressure vessels (3E Plus). Training is available to help you or your staff learn how to use these software programs and learn more about industrial systems. Workshops are held around the country on topics such as "Capturing the Value of Steam Efficiency," "Fundamentals and Advanced Management of Compressed Air Systems," and "Motor System Management." Available technical publications range from case studies and tip sheets to sourcebooks and market assessments. The *Energy Matters* newsletter, for example, provides timely articles and information on comprehensive energy systems for industry. You can access these resources and more by visiting the BestPractices Web site at www.oit.doe.gov/bestpractices or by contacting the OIT Clearinghouse at 800-862-2086 or via email at clearinghouse@ee.doe.gov.



BestPractices is part of the Office of Industrial Technologies' (OIT's) Industries of the Future strategy, which helps the country's most energy-intensive industries improve their competitiveness. BestPractices brings together the best-available and emerging technologies and practices to help companies begin improving energy efficiency, environmental performance, and productivity right now.

BestPractices focuses on plant systems, where significant efficiency improvements and savings can be achieved. Industry gains easy access to near-term and long-term solutions for improving the performance of motor, steam, compressed air, and process heating systems. In addition, the Industrial Assessment Centers provide comprehensive industrial energy evaluations to small and medium-size manufacturers.

FOR ADDITIONAL INFORMATION, PLEASE CONTACT:

Peter Salmon-Cox
Office of Industrial Technologies
Phone: (202) 586-2380
Fax: (202) 586-6507
Peter.Salmon-Cox@hq.doe.gov
www.oit.doe.gov/bestpractices

OIT Clearinghouse
Phone: (800) 862-2086
Fax: (360) 586-8303
clearinghouse@ee.doe.gov

Please send any comments, questions, or suggestions to webmaster.oit@ee.doe.gov

Visit our home page at www.oit.doe.gov

Office of Industrial Technologies
Energy Efficiency
and Renewable Energy
U.S. Department of Energy
Washington, D.C. 20585



DOE/GO-102000-1115
December 2000
Steam Tip Sheet #15

Energy Tips

Tip Sheet #16 • December 2000



Steam



Motors

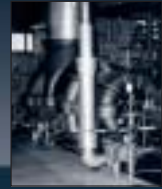

Compressed Air

Multiple Boiler Operations

The most efficient boilers should be brought on-line as loads increase, with less-efficient units taken off-line first as loads drop. Subject to emissions, operations, or firing rate limits, shift loads from a boiler where steam production is expensive to one where it is less expensive.

Use automatic controllers that determine the incremental costs (change in steam cost/change in load) for each boiler in the facility, and then shift loads accordingly. This maximizes efficiency and reduces energy costs. If possible, schedule loads to help optimize boiler system performance. Powerhouses containing multiple boilers that are simultaneously operated at low-fire conditions offer energy-saving opportunities by using proper boiler allocation strategies.

Boiler Downsizing

Fuel savings can be achieved by adding a smaller boiler sized to meet average loads at your facility, or by re-engineering the power plant to consist of multiple small boilers. Multiple small boilers offer reliability and flexibility to operators to follow load swings without over-firing and short cycling. Facilities with large seasonal variations in steam use operate small boilers when demand drops rather than operating their large boilers year-round.

Steam Tip Sheet information has been reviewed by the DOE BestPractices Steam Technical Subcommittee. For additional information on industrial energy efficiency measures, contact the OIT Clearinghouse at (800) 862-2086.



Minimize Boiler Short Cycling Losses

Boiler "short cycling" occurs when an oversized boiler quickly satisfies process or space heating demands, and then shuts down until heat is again required. Process heating demands can change over time. Boilers may have been oversized for additions or expansions that never occurred. Installing energy conservation or heat recovery measures may also reduce the heat demand. As a result, a facility may have multiple boilers, each rated at several times the maximum expected load.

Boilers used for space heating loads are often oversized, with their capacity chosen to meet total building heat losses plus heating of ventilation and infiltration air under extreme or design-basis temperature conditions. No credit is taken for thermal contributions from lights, equipment, or people. Excess capacity is also added to bring a facility to required settings quickly after a night setback.

Cycling Losses

A boiler cycle consists of a firing interval, a post-purge, an idle period, a pre-purge, and a return to firing. Boiler efficiency is the useful heat provided by the boiler divided by the energy input (useful heat plus losses) over the cycle duration. This efficiency decreases when short cycling occurs or when multiple boilers are operated at low-firing rates.

This decrease in efficiency occurs, in part, because fixed losses are magnified under lightly loaded conditions. For example, if the radiation loss from the boiler enclosure is 1% of the total heat input at full-load, at half-load the losses increase to 2%, while at one-quarter load the loss is 4%. In addition to radiation losses, pre- and post-purge losses occur. In the pre-purge, the fan operates to force air through the boiler to flush out any combustible gas mixture that may have accumulated. The post-purge performs a similar function. During purging, heat is removed from the boiler as the purged air is heated.

Example

A 1,500 hp (1 hp = 33,475 Btu/hr) boiler with a cycle efficiency of 72.7% (E_1) is replaced with a 600 hp boiler with a cycle efficiency of 78.8% (E_2). Calculate the annual cost savings.

$$\begin{aligned} \text{Fractional Fuel Savings} &= (1 - E_1/E_2) \\ &= (1 - 72.7/78.8) \times 100 = 7.7\% \end{aligned}$$

If the original boiler used 200,000 MMBtu of fuel annually, the savings from switching to the smaller boiler (given a fuel cost of \$3.00/MMBtu) are:

$$\text{Annual Savings} = 200,000 \text{ MMBtu} \times 0.077 \times \$3.00/\text{MMBtu} = \$46,200$$

Suggested Actions

- Determine the efficiency and operating cost of each of your boilers and adopt a control strategy for maximizing overall efficiency of multiple boiler operations. (See sidebar)
- Avoid short cycling by adding small boilers to your boiler facility to provide better flexibility and high efficiency at all loads. (See sidebar: Boiler Downsizing)

OFFICE OF INDUSTRIAL TECHNOLOGIES
ENERGY EFFICIENCY AND RENEWABLE ENERGY • U.S. DEPARTMENT OF ENERGY

About DOE's Office of Industrial Technologies

The Office of Industrial Technologies (OIT), through partnerships with industry, government, and non-governmental organizations, develops and delivers advanced energy efficiency, renewable energy, and pollution prevention technologies for industrial applications. OIT is part of the U.S. Department of Energy's Office of Energy Efficiency and Renewable Energy.

OIT encourages industry-wide efforts to boost resource productivity through a strategy called Industries of the Future (IOF). IOF focuses on the following nine energy- and resource-intensive industries:

- Agriculture
- Aluminum
- Chemicals
- Forest Products
- Glass
- Metal Casting
- Mining
- Petroleum
- Steel

OIT and its BestPractices program offer a wide variety of resources to industrial partners that cover motor, steam, compressed air, and process heating systems. For example, BestPractices software can help you decide whether to replace or rewind motors (MotorMaster+), assess the efficiency of pumping systems (PSAT), compressed air systems (AirMaster+), steam systems (Steam Scoping Tool), or determine optimal insulation thickness for pipes and pressure vessels (3E Plus). Training is available to help you or your staff learn how to use these software programs and learn more about industrial systems. Workshops are held around the country on topics such as "Capturing the Value of Steam Efficiency," "Fundamentals and Advanced Management of Compressed Air Systems," and "Motor System Management." Available technical publications range from case studies and tip sheets to sourcebooks and market assessments. The *Energy Matters* newsletter, for example, provides timely articles and information on comprehensive energy systems for industry. You can access these resources and more by visiting the BestPractices Web site at www.oit.doe.gov/bestpractices or by contacting the OIT Clearinghouse at 800-862-2086 or via email at clearinghouse@ee.doe.gov.



BestPractices is part of the Office of Industrial Technologies' (OIT's) Industries of the Future strategy, which helps the country's most energy-intensive industries improve their competitiveness. BestPractices brings together the best-available and emerging technologies and practices to help companies begin improving energy efficiency, environmental performance, and productivity right now.

BestPractices focuses on plant systems, where significant efficiency improvements and savings can be achieved. Industry gains easy access to near-term and long-term solutions for improving the performance of motor, steam, compressed air, and process heating systems. In addition, the Industrial Assessment Centers provide comprehensive industrial energy evaluations to small and medium-size manufacturers.

FOR ADDITIONAL INFORMATION, PLEASE CONTACT:

Peter Salmon-Cox
Office of Industrial Technologies
Phone: (202) 586-2380
Fax: (202) 586-6507
Peter.Salmon-Cox@hq.doe.gov
www.oit.doe.gov/bestpractices

OIT Clearinghouse
Phone: (800) 862-2086
Fax: (360) 586-8303
clearinghouse@ee.doe.gov

Please send any comments, questions, or suggestions to webmaster.oit@ee.doe.gov

Visit our home page at www.oit.doe.gov

Office of Industrial Technologies
Energy Efficiency
and Renewable Energy
U.S. Department of Energy
Washington, D.C. 20585



DOE/GO-102000-1116
December 2000
Steam Tip Sheet #16

Energy Tips

Tip Sheet #17 • December 2000



Steam



Motors



Compressed Air

Availability

Insulation supply companies are located regionally to expedite delivery and to meet site-specific job requirements. Most supply companies can take measurements on-site to ensure the best fit on irregular surfaces. For customized applications, manufacturers can provide instructions regarding the installation and removal of insulating pads.

Noise Control Benefits

Specify insulating pads that contain built-in barriers for noise control.

Insulation for Steam Traps

Effectively insulate inverted bucket traps with removable and reusable snap-on insulation. Thermostatic and disk traps should be insulated according to manufacturers' recommendations to ensure proper operation.

Caution

Before removal of all or any insulation, a check for asbestos should be done in accordance with OSHA regulations.

Steam Tip Sheet information adapted from material provided by the Industrial Energy Extension Service of Georgia Tech and reviewed by the DOE BestPractices Steam Technical Subcommittee. For additional information on steam system efficiency measures, contact the OIT Clearinghouse at (800) 862-2086.



Install Removable Insulation on Uninsulated Valves and Fittings

During maintenance, insulation over pipes, valves, and fittings is often damaged or removed and not replaced. Uninsulated pipes, valves, and fittings can be safety hazards and sources of heat loss. Removable and reusable insulating pads are available to cover almost any surface. The pads are made of a non-combustible inside cover, insulation material, and a non-combustible outside cover that is tear- and abrasion-resistant. Materials used in the pads are oil- and water-resistant and can be designed for temperatures up to 1600°F. The pads are held in place by wire laced through grommets or by using straps and buckles.

Applications

Reusable insulating pads are commonly used in industrial facilities for flanges, valves, expansion joints, heat exchangers, pumps, turbines, tanks, and other irregular surfaces. The pads are flexible and vibration resistant and can be used with equipment that is horizontally or vertically mounted or difficult to access. Any high-temperature piping or equipment should be insulated to reduce heat loss, reduce emissions, and improve safety. As a rule of thumb, any surface over 120°F should be insulated for protection of personnel. Insulating pads can be easily removed for periodic inspection or maintenance and replaced as needed. Insulating pads can also contain built-in acoustical barriers for noise control.

Energy Savings

The table below summarizes energy savings due to the use of insulating valve covers for a range of valve sizes and operating temperatures.

Energy Savings (Btu/hr) from Using Removable Insulated Valve Covers ^{a,b}						
Operating Temperature, °F	Valve Size, inches					
	3	4	6	8	10	12
200	1,690	2,020	3,020	4,030	4,790	6,050
300	3,630	4,340	6,500	8,670	10,300	13,010
400	6,260	7,470	11,210	14,940	17,750	22,420
500	9,700	11,680	17,375	23,170	27,510	34,750
600	14,150	16,900	25,340	33,790	40,130	50,690

^a Based on 2-inches of insulation on 150 pound class flanged valves with an ambient temperature of 65°F.

^b From a personal communication and with permission from E.J. Bartells Co.

Example

Using the table above, calculate the annual fuel and dollar savings from a 2-inch thick insulating pad installed on an uninsulated 6-inch gate valve in a 250 psig saturated steam line (406°F). Assume continuous operation with natural gas at a boiler efficiency of 80% and a fuel price of \$3.00 per million Btu.

$$\text{Annual Fuel Savings} = 11,210 \text{ Btu/hr} \times 8760 \text{ hours} \times 1/0.80 = 122.75 \text{ MMBtu}$$

$$\text{Annual Dollar Savings} = 122.75 \text{ MMBtu} \times \$3.00/\text{MMBtu} = \$368 \text{ per 6-inch gate valve}$$

Suggested Actions

- Conduct a survey of your steam distribution system to identify locations where removable and reusable insulation covers can be used.
- Use removable insulation on components requiring periodic inspections or repair.

OFFICE OF INDUSTRIAL TECHNOLOGIES
ENERGY EFFICIENCY AND RENEWABLE ENERGY • U.S. DEPARTMENT OF ENERGY

About DOE's Office of Industrial Technologies

The Office of Industrial Technologies (OIT), through partnerships with industry, government, and non-governmental organizations, develops and delivers advanced energy efficiency, renewable energy, and pollution prevention technologies for industrial applications. OIT is part of the U.S. Department of Energy's Office of Energy Efficiency and Renewable Energy.

OIT encourages industry-wide efforts to boost resource productivity through a strategy called Industries of the Future (IOF). IOF focuses on the following nine energy- and resource-intensive industries:

- Agriculture
- Aluminum
- Chemicals
- Forest Products
- Glass
- Metal Casting
- Mining
- Petroleum
- Steel

OIT and its BestPractices program offer a wide variety of resources to industrial partners that cover motor, steam, compressed air, and process heating systems. For example, BestPractices software can help you decide whether to replace or rewind motors (MotorMaster+), assess the efficiency of pumping systems (PSAT), compressed air systems (AirMaster+), steam systems (Steam Scoping Tool), or determine optimal insulation thickness for pipes and pressure vessels (3E Plus). Training is available to help you or your staff learn how to use these software programs and learn more about industrial systems. Workshops are held around the country on topics such as "Capturing the Value of Steam Efficiency," "Fundamentals and Advanced Management of Compressed Air Systems," and "Motor System Management." Available technical publications range from case studies and tip sheets to sourcebooks and market assessments. The *Energy Matters* newsletter, for example, provides timely articles and information on comprehensive energy systems for industry. You can access these resources and more by visiting the BestPractices Web site at www.oit.doe.gov/bestpractices or by contacting the OIT Clearinghouse at 800-862-2086 or via email at clearinghouse@ee.doe.gov.



BestPractices is part of the Office of Industrial Technologies' (OIT's) Industries of the Future strategy, which helps the country's most energy-intensive industries improve their competitiveness. BestPractices brings together the best-available and emerging technologies and practices to help companies begin improving energy efficiency, environmental performance, and productivity right now.

BestPractices focuses on plant systems, where significant efficiency improvements and savings can be achieved. Industry gains easy access to near-term and long-term solutions for improving the performance of motor, steam, compressed air, and process heating systems. In addition, the Industrial Assessment Centers provide comprehensive industrial energy evaluations to small and medium-size manufacturers.

FOR ADDITIONAL INFORMATION, PLEASE CONTACT:

Peter Salmon-Cox
Office of Industrial Technologies
Phone: (202) 586-2380
Fax: (202) 586-6507
Peter.Salmon-Cox@hq.doe.gov
www.oit.doe.gov/bestpractices

OIT Clearinghouse
Phone: (800) 862-2086
Fax: (360) 586-8303
clearinghouse@ee.doe.gov

Please send any comments, questions, or suggestions to webmaster.oit@ee.doe.gov

Visit our home page at www.oit.doe.gov

Office of Industrial Technologies
Energy Efficiency
and Renewable Energy
U.S. Department of Energy
Washington, D.C. 20585



DOE/GO-102000-1117
December 2000
Steam Tip Sheet #17

Energy Tips

Tip Sheet #18 • December 2000



Steam



Motors

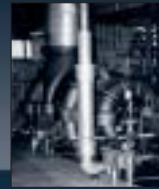

Compressed Air

Additional Benefits

Deaerators provide the water storage capacity and the net positive suction head necessary at the boiler feed pump inlet. Returned condensate is mixed with makeup water within the deaerator. Operating temperatures range from 215 to over 350°F, which reduces the thermal shock on downstream preheating equipment and the boiler.

Insulation

The deaerator section and storage tank and all piping conveying hot water or steam should be adequately insulated to prevent the condensation of steam and loss of heat.

Function Clarification

The deaerator is designed to remove oxygen that is dissolved in the entering water, not entrained air. Sources of "free air" include loose piping connections on the suction side of pumps and improper pump packing.

Pressure Fluctuations

Sudden increases in free or "flash" steam can cause a spike in deaerator vessel pressure, resulting in re-oxygenation of the feedwater. A dedicated pressure-regulating valve should be provided to maintain the deaerator at a constant pressure.

Steam Tip Sheet information has been reviewed by the DOE BestPractices Steam Technical Subcommittee. For additional information on industrial energy efficiency measures, contact the Information Clearinghouse at (800) 862-2086.



Deaerators in Industrial Steam Systems

Deaerators are mechanical devices that remove dissolved gases from boiler feedwater. Deaeration protects the steam system from the effects of corrosive gases. It accomplishes this by reducing the concentration of dissolved oxygen and carbon dioxide to a level where corrosion is minimized. A dissolved oxygen level of 5 parts per billion (ppb) or lower is needed to prevent corrosion in most high pressure (>200 psig) boilers. While oxygen concentrations of up to 43 ppb may be tolerated in low pressure boilers, equipment life is extended at little or no cost by limiting the oxygen concentration to 5 ppb. Dissolved carbon dioxide is essentially completely removed by the deaerator.

How They Work

The design of an effective deaeration system depends upon the amount of gases to be removed and the final gas (O₂) concentration desired. This in turn depends upon the ratio of boiler feedwater makeup to returned condensate and the operating pressure of the deaerator.

Deaerators use steam to heat the water to the full saturation temperature corresponding to the steam pressure in the deaerator and to scrub out and carry away dissolved gases. Steam flow may be parallel, cross, or counter to the water flow. The deaerator consists of a deaeration section, a storage tank, and a vent. In the deaeration section, steam bubbles through the water, both heating and agitating it. Steam is cooled by incoming water and condensed at the vent condenser. Non-condensable gases and some steam are released through the vent.

Steam provided to the deaerator provides physical stripping action and heats the mixture of returned condensate and boiler feedwater makeup to saturation temperature. Most of the steam will condense, but a small fraction (usually 5 to 14%) must be vented to accommodate the stripping requirements. Normal design practice is to calculate the steam required for heating, and then make sure that the flow is sufficient for stripping as well. If the condensate return rate is high (>80%) and the condensate pressure is high compared to the deaerator pressure, then very little steam is needed for heating, and provisions may be made for condensing the surplus flash steam.

Deaerator Steam Consumption

The deaerator steam consumption is equal to the steam required to heat incoming water to its saturation temperature, plus the amount vented with the non-condensable gases, less any flashed steam from hot condensate or steam losses through failed traps. The heat balance calculation is made with the incoming water at its lowest expected temperature. The vent rate is a function of deaerator type, size (rated feedwater capacity), and the amount of makeup water. The operating vent rate is at its maximum with the introduction of cold, oxygen-rich makeup water.

Suggested Actions

- Deaerator steam requirements should be re-examined following the retrofit of steam distribution system, condensate return, or heat recovery energy conservation measures.
- Install continuous dissolved oxygen monitoring devices to aid in identifying operating practices that result in poor oxygen removal.

OFFICE OF INDUSTRIAL TECHNOLOGIES
ENERGY EFFICIENCY AND RENEWABLE ENERGY • U.S. DEPARTMENT OF ENERGY

About DOE's Office of Industrial Technologies

The Office of Industrial Technologies (OIT), through partnerships with industry, government, and non-governmental organizations, develops and delivers advanced energy efficiency, renewable energy, and pollution prevention technologies for industrial applications. OIT is part of the U.S. Department of Energy's Office of Energy Efficiency and Renewable Energy.

OIT encourages industry-wide efforts to boost resource productivity through a strategy called Industries of the Future (IOF). IOF focuses on the following nine energy- and resource-intensive industries:

- Agriculture
- Aluminum
- Chemicals
- Forest Products
- Glass
- Metal Casting
- Mining
- Petroleum
- Steel

OIT and its BestPractices program offer a wide variety of resources to industrial partners that cover motor, steam, compressed air, and process heating systems. For example, BestPractices software can help you decide whether to replace or rewind motors (MotorMaster+), assess the efficiency of pumping systems (PSAT), compressed air systems (AirMaster+), steam systems (Steam Scoping Tool), or determine optimal insulation thickness for pipes and pressure vessels (3E Plus). Training is available to help you or your staff learn how to use these software programs and learn more about industrial systems. Workshops are held around the country on topics such as "Capturing the Value of Steam Efficiency," "Fundamentals and Advanced Management of Compressed Air Systems," and "Motor System Management." Available technical publications range from case studies and tip sheets to sourcebooks and market assessments. The *Energy Matters* newsletter, for example, provides timely articles and information on comprehensive energy systems for industry. You can access these resources and more by visiting the BestPractices Web site at www.oit.doe.gov/bestpractices or by contacting the OIT Clearinghouse at 800-862-2086 or via email at clearinghouse@ee.doe.gov.



BestPractices is part of the Office of Industrial Technologies' (OIT's) Industries of the Future strategy, which helps the country's most energy-intensive industries improve their competitiveness. BestPractices brings together the best-available and emerging technologies and practices to help companies begin improving energy efficiency, environmental performance, and productivity right now.

BestPractices focuses on plant systems, where significant efficiency improvements and savings can be achieved. Industry gains easy access to near-term and long-term solutions for improving the performance of motor, steam, compressed air, and process heating systems. In addition, the Industrial Assessment Centers provide comprehensive industrial energy evaluations to small and medium-size manufacturers.

FOR ADDITIONAL INFORMATION, PLEASE CONTACT:

Peter Salmon-Cox
Office of Industrial Technologies
Phone: (202) 586-2380
Fax: (202) 586-6507
Peter.Salmon-Cox@hq.doe.gov
www.oit.doe.gov/bestpractices

OIT Clearinghouse
Phone: (800) 862-2086
Fax: (360) 586-8303
clearinghouse@ee.doe.gov

Please send any comments, questions, or suggestions to webmaster.oit@ee.doe.gov

Visit our home page at www.oit.doe.gov

Office of Industrial Technologies
Energy Efficiency
and Renewable Energy
U.S. Department of Energy
Washington, D.C. 20585



DOE/GO-102000-1118
December 2000
Steam Tip Sheet #18

Energy Tips

Tip Sheet #19 • January 2002



Steam



Motors



Compressed Air

Heat Loss Detail

- Eliminating internal heat gains will also result in electrical energy savings if the open tanks are located within a conditioned space.
- Heat losses are a strong function of both wind velocity and ambient air humidity. A wind velocity of 3 miles per hour will more than double the rate of heat loss from a tank.
- Radiation heat transfer is a secondary source of tank surface heat losses. Radiation losses increase from 90 Btu/hr-ft² at a liquid temperature of 110° F to 290 Btu/hr-ft² at 190° F.

Cover Heated Open Vessels

Open vessels that contain heated liquids often have a high heat loss due to surface evaporation. Both energy and liquid losses are reduced by covering open vessels with insulated lids. Table 1 provides an estimate of the evaporative heat loss per square foot of uncovered vessel surface area for various water and dry ambient air temperatures. It is assumed that the ambient air is dry with no wind currents. A fan pulling air over the uncovered tank could more than double the heat losses.

Table 1. Evaporative Heat Loss from Water in Open Tanks, Btu/hr-ft²

Liquid Temperature, °F	Ambient Air Temperature, °F				
	65	75	85	95	105
110	244	222	200	177	152
130	479	452	425	397	369
150	889	856	822	788	754
170	1,608	1,566	1,524	1,482	1,440
190	2,900	2,845	2,790	2,737	2,684

Note: Table 1 is extracted from "Steam Efficiency Improvement" by the Boiler Efficiency Institute at Auburn University

Example

A rinse tank is four feet wide and ten feet long. It is maintained at a constant temperature of 170 °F. Determine the evaporative heat loss from the tank if the ambient temperature is 75 °F.

$$\text{Area of Evaporating Surface} = 4 \text{ ft} \times 10 \text{ ft} = 40 \text{ ft}^2$$

Total Heat Loss for

$$\text{Uncovered Liquid Surface} = 1,566 \text{ Btu/hr-ft}^2 \times 40 \text{ ft}^2 = 62,640 \text{ Btu/hr}$$

Cover the Tank with an Insulated Top

Assume that the rinse tank is heated during two shifts per day, five days per week, and 50 weeks per year. What are the annual energy savings that may be attained by covering the tank? What is the heating cost reduction in a plant where the cost of steam is \$6.50/MMBtu? Assume that covering the rinse tank with an insulated lid effectively reduces the heat losses from the liquid surface to a negligible value.

$$\begin{aligned} \text{Annual Energy Savings} &= 62,640 \text{ Btu/hr} \times 2 \text{ shifts/day} \times 8 \text{ hrs/shift} \times 250 \text{ days/yr} \\ &= 250 \text{ MMBtu/yr} \end{aligned}$$

$$\text{Heating Cost Reduction} = 250 \text{ MMBtu/yr} \times \$6.50/\text{MMBtu} = \$1,625/\text{yr}$$

Suggested Actions

- Conduct a survey to determine the number of open vessels that contain heated liquid within your plant. For each tank, determine the operating schedule, liquid temperature, ambient temperature, and the square feet of exposed area.
- Estimate the annual heat loss from the uncovered tanks and determine the potential annual fuel cost savings.
- Evaporation and heat losses can be reduced by lowering the liquid temperature, reducing the exposed liquid area, minimizing flow of air over the tank, or by installing an insulated cover.
- Obtain cost quotations for insulated covers. Install covers when they are economically justified.

Steam Tip Sheet information adapted from an EnergyTIPS fact sheet that was originally published by the Industrial Energy Extension Service of Georgia Tech and reviewed by the DOE BestPractices Steam Technical Subcommittee. For additional information on steam system efficiency measures, contact the OIT Clearinghouse at (800) 862-2086.



OFFICE OF INDUSTRIAL TECHNOLOGIES
ENERGY EFFICIENCY AND RENEWABLE ENERGY • U.S. DEPARTMENT OF ENERGY

About DOE's Office of Industrial Technologies

The Office of Industrial Technologies (OIT), through partnerships with industry, government, and non-governmental organizations, develops and delivers advanced energy efficiency, renewable energy, and pollution prevention technologies for industrial applications. OIT is part of the U.S. Department of Energy's Office of Energy Efficiency and Renewable Energy.

OIT encourages industry-wide efforts to boost resource productivity through a strategy called Industries of the Future (IOF). IOF focuses on the following nine energy- and resource-intensive industries:

- Agriculture
- Aluminum
- Chemicals
- Forest Products
- Glass
- Metal Casting
- Mining
- Petroleum
- Steel

OIT and its BestPractices program offer a wide variety of resources to industrial partners that cover motor, steam, compressed air, and process heating systems. For example, BestPractices software can help you decide whether to replace or rewind motors (MotorMaster+), assess the efficiency of pumping systems (PSAT), or determine optimal insulation thickness for pipes and pressure vessels (3E Plus). Training is available to help you or your staff learn how to use these software programs and learn more about industrial systems. Workshops are held around the country on topics such as "Capturing the Value of Steam Efficiency," "Fundamentals and Advanced Management of Compressed Air Systems," and "Motor System Management." Available technical publications range from case studies and tip sheets to sourcebooks and market assessments. The *Energy Matters* newsletter, for example, provides timely articles and information on comprehensive energy systems for industry. You can access these resources and more by visiting the BestPractices Web site at www.oit.doe.gov/bestpractices or by contacting the OIT Clearinghouse at 800-862-2086 or via email at clearinghouse@ee.doe.gov.



BestPractices is part of the Office of Industrial Technologies' (OIT's) Industries of the Future strategy, which helps the country's most energy-intensive industries improve their competitiveness. BestPractices brings together the best-available and emerging technologies and practices to help companies begin improving energy efficiency, environmental performance, and productivity right now.

BestPractices focuses on plant systems, where significant efficiency improvements and savings can be achieved. Industry gains easy access to near-term and long-term solutions for improving the performance of motor, steam, compressed air, and process heating systems. In addition, the Industrial Assessment Centers provide comprehensive industrial energy evaluations to small and medium-size manufacturers.

FOR ADDITIONAL INFORMATION, PLEASE CONTACT:

Peter Salmon-Cox
Office of Industrial Technologies
Phone: (202) 586-2380
Fax: (202) 586-6507
Peter.Salmon-Cox@hq.doe.gov
www.oit.doe.gov/bestpractices

OIT Clearinghouse
Phone: (800) 862-2086
Fax: (360) 586-8303
clearinghouse@ee.doe.gov

Please send any comments, questions, or suggestions to webmaster.oit@ee.doe.gov

Visit our home page at www.oit.doe.gov

Office of Industrial Technologies
Energy Efficiency
and Renewable Energy
U.S. Department of Energy
Washington, DC 20585-0121



DOE/GO-102002-1477
January 2002
Steam Tip Sheet #19

Energy Tips

Tip Sheet #20 • January 2002



Steam



Motors

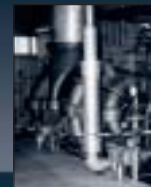

Compressed Air

Life and Cost of Backpressure Turbogenerators

Turbogenerators with electrical switchgear cost about \$700/kW for a 50 kW system to less than \$200/kW for a 2,000 kW system. Installation costs varies, but typically averages 75 percent of equipment costs.

Backpressure steam turbines are designed for a 20-year minimum service life and are known for needing low maintenance.

Suggested Actions

Consider replacing PRVs with backpressure turbogenerators when purchasing new boilers or if your boiler operates at a pressure of 150 psig or greater.

- Develop a current steam balance and actual process pressure requirements for your plant.
- Develop steam flow/duration curves for each PRV station.
- Determine plant electricity, fuel cost, and operating voltage.
- Consider either one centralized turbogenerator, or multiple turbogenerators at PRV stations.

Steam Tip Sheet information adapted from material provided by the TurboSteam Corporation and reviewed by the DOE BestPractices Steam Technical Subcommittee. For additional information on steam system efficiency measures, contact the OIT Clearinghouse at (800) 862-2086.



Replace Pressure-Reducing Valves with Backpressure Turbogenerators

Many industrial facilities produce steam at a higher pressure than is demanded by process requirements. Steam passes through pressure-reducing valves (PRVs, also known as letdown valves) at various locations in the steam distribution system to let down or reduce its pressure. A non-condensing or backpressure steam turbine can perform the same pressure-reducing function as a PRV, while converting steam energy into electrical energy.

In a backpressure steam turbogenerator, shaft power is produced when a nozzle directs jets of high-pressure steam against the blades of the turbine's rotor. The rotor is attached to a shaft that is coupled to an electrical generator. The steam turbine does not consume steam. It simply reduces the pressure of the steam that is subsequently exhausted into the process header.

Cost-Effective Power Generation

In a conventional, power-only steam turbine installation, designers increase efficiency by maximizing the pressure drop across the turbine. Modern Rankine-cycle power plants with 1,800 psig superheated steam boilers and condensing turbines exhausting at near-vacuum pressures can generate electricity with efficiencies of approximately 40%.

Most steam users do not have the benefit of ultra-high-pressure boilers and cannot achieve such high levels of generation efficiency. However, by replacing a PRV with a backpressure steam turbine, where the exhaust steam is provided to a plant process, energy in the inlet steam can be effectively removed and converted into electricity. This means the exhaust steam has a lower temperature than it would have if its pressure was reduced through a PRV. In order to make up for this heat loss, steam plants with backpressure turbine installations increase their boiler steam throughput.

Thermodynamically, the steam turbine still behaves the same way as it would in a conventional Rankine power cycle, achieving isentropic efficiencies of 20 to 70 percent. Economically, however, the turbine generates power at the efficiency of your steam boiler (modern steam boilers operate at approximately 80 percent efficiency), which then must be replaced with an equivalent kWh of heat for downstream purposes. The resulting power generation efficiencies are well in excess of the average U.S. electricity grid generating efficiency of 33 percent. Greater efficiency means less fuel consumption; backpressure turbines can produce power at costs that are often less than 3 cents/kWh. Energy savings are often sufficient to completely recover the cost of the initial capital outlay in less than 2 years.

Applicability

Packaged or "off-the-shelf" backpressure turbogenerators are now available in ratings as low as 50 kW. Backpressure turbogenerators should be considered when a PRV has constant steam flows of at least 3,000 lbs/hr, and when the steam pressure drop is at least 100 psi. The backpressure turbine is generally installed in parallel with the PRV.

Estimating Your Savings

To make a preliminary estimate of the cost of producing electrical energy from a backpressure steam turbine, divide your boiler fuel cost (in \$/MMBtu) by your boiler efficiency. Then convert the resulting number into cost per kWh, as shown in the sample calculation on the next page:

OFFICE OF INDUSTRIAL TECHNOLOGIES
ENERGY EFFICIENCY AND RENEWABLE ENERGY • U.S. DEPARTMENT OF ENERGY

$$\text{Electricity cost} = \frac{\text{Fuel cost (\$/MMBtu)} \times 0.003412 \text{ MMBtu/kWh}}{\text{Boiler efficiency}}$$

Example: $\frac{\$5.00/\text{MMBtu} \times 0.003412 \text{ MMBtu/kWh}}{0.80} = \$0.021/\text{kWh}$

To estimate the potential power output at a PRV, refer to Figure 1, which shows lines of constant power output (expressed in kW of electrical output per 1,000 pounds per hour of steam throughput) as a function of turbine inlet and exhaust pressures. Look up your input and output pressure on the horizontal and vertical axes, and then use the reference lines to estimate the backpressure turbogenerator power output per Mlb/hour of steam flow. Then estimate the total installed generating capacity (kW) by multiplying this number by your known steam flow rate. The annual cost savings from the backpressure turbine can then be estimated as:

$$\text{Power output (kW)} \times \text{Steam duty (hrs/year)} \times (\text{Cost of grid power} - \text{cost of generated power, \$/kWh})$$

Figure 1. Backpressure Turbogenerator Generating Potential (kW/Mlb-hour)

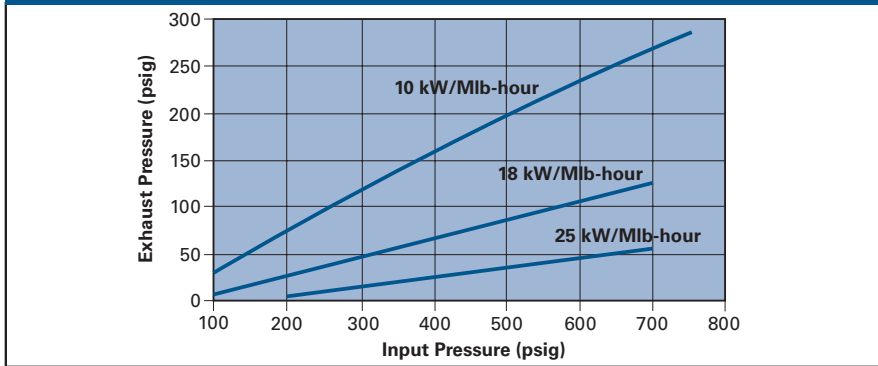

Note: Assumes a 50% isentropic turbine efficiency, a 96% efficient generator, and dry saturated inlet steam

About DOE's Office of Industrial Technologies

The Office of Industrial Technologies (OIT), through partnerships with industry, government, and non-governmental organizations, develops and delivers advanced energy efficiency, renewable energy, and pollution prevention technologies for industrial applications. OIT is part of the U.S. Department of Energy's Office of Energy Efficiency and Renewable Energy.

OIT encourages industry-wide efforts to boost resource productivity through a strategy called Industries of the Future (IOF). IOF focuses on the following nine energy- and resource-intensive industries:

- Agriculture
- Aluminum
- Chemicals
- Forest Products
- Glass
- Metal Casting
- Mining
- Petroleum
- Steel

OIT and its BestPractices program offer a wide variety of resources to industrial partners that cover motor, steam, compressed air, and process heating systems. For example, BestPractices software can help you decide whether to replace or rewind motors (MotorMaster+), assess the efficiency of pumping systems (PSAT), or determine optimal insulation thickness for pipes and pressure vessels (3E Plus). Training is available to help you or your staff learn how to use these software programs and learn more about industrial systems. Workshops are held around the country on topics such as "Capturing the Value of Steam Efficiency," "Fundamentals and Advanced Management of Compressed Air Systems," and "Motor System Management." Available technical publications range from case studies and tip sheets to sourcebooks and market assessments. The *Energy Matters* newsletter, for example, provides timely articles and information on comprehensive energy systems for industry. You can access these resources and more by visiting the BestPractices Web site at www.oit.doe.gov/bestpractices or by contacting the OIT Clearinghouse at 800-862-2086 or via email at clearinghouse@ee.doe.gov.



BestPractices is part of the Office of Industrial Technologies' (OIT's) Industries of the Future strategy, which helps the country's most energy-intensive industries improve their competitiveness. BestPractices brings together the best-available and emerging technologies and practices to help companies begin improving energy efficiency, environmental performance, and productivity right now.

BestPractices focuses on plant systems, where significant efficiency improvements and savings can be achieved. Industry gains easy access to near-term and long-term solutions for improving the performance of motor, steam, compressed air, and process heating systems. In addition, the Industrial Assessment Centers provide comprehensive industrial energy evaluations to small and medium-size manufacturers.

FOR ADDITIONAL INFORMATION, PLEASE CONTACT:

Peter Salmon-Cox
Office of Industrial Technologies
Phone: (202) 586-2380
Fax: (202) 586-6507
Peter.Salmon-Cox@hq.doe.gov
www.oit.doe.gov/bestpractices

OIT Clearinghouse
Phone: (800) 862-2086
Fax: (360) 586-8303
clearinghouse@ee.doe.gov

Please send any comments, questions, or suggestions to webmaster.oit@ee.doe.gov

Visit our home page at www.oit.doe.gov

Office of Industrial Technologies
Energy Efficiency
and Renewable Energy
U.S. Department of Energy
Washington, DC 20585-0121



DOE/GO-102002-1476
January 2002
Steam Tip Sheet #20

Energy Tips

Tip Sheet #21 • January 2002



Steam

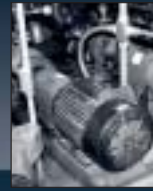

Motors



Compressed Air

Steam Turbine Flexibility

Equipment redundancy and improved reliability can be obtained by mounting a steam turbine drive and an electric motor on opposite ends of the driven-equipment shaft. You can then select either the motor or turbine as the prime mover by increasing or decreasing the turbine speed relative to the synchronous speed of the motor.

Suggested Actions

Consider replacing electric motors with steam turbine drives if your facility:

- Contains a high-pressure boiler or a boiler designed to operate at a higher pressure than process requirements.
- Has time-of-use (eg. on/off peak, real-time, etc.) energy purchase and resale contracts with periods when electric power costs are substantially higher than fuel costs.
- Has pumps or other rotating equipment requiring variable speed operation.
- Requires continued equipment operation during electrical power supply interruptions.

Steam Tip Sheet information adapted from material provided by the TurboSteam Corporation and reviewed by the DOE BestPractices Steam Technical Subcommittee. For additional information on steam system efficiency measures, contact the OIT Clearinghouse at (800) 862-2086.



Consider Steam Turbine Drives for Rotating Equipment

Steam turbines are well suited as prime movers for driving boiler feedwater pumps, forced or induced-draft fans, blowers, air compressors, and other rotating equipment. This service generally calls for a backpressure non-condensing steam turbine. The low-pressure steam turbine exhaust is available for feedwater heating, preheating of deaerator makeup water, and/or process requirements.

Steam turbine drives are equipped with throttling valves or nozzle governors to modulate steam flow and achieve variable speed operation. The steam turbine drive is thus capable of serving the same function as an induction motor coupled to an inverter or adjustable speed drive. Steam turbine drives can operate over a broad speed range and do not fail when overloaded. They also exhibit the high starting torque required for constant torque loads such as positive displacement pumps.

Steam turbines are inherently rugged and reliable low-maintenance devices. They are easy to control and offer enclosed, non-sparking operation suitable for use in explosive atmospheres or highly corrosive environments. Steam turbines provide fast, reliable starting capability and are particularly adaptable for direct connection to equipment that rotates at high speeds. Steam turbine drives may be installed for continuous duty under severe operating conditions, or used for load shaping (e.g. demand limiting), standby, or emergency service.

Steam turbine performance is expressed in terms of isentropic efficiency or steam rate (the steam requirement of the turbine per unit of shaft power produced). Steam rates are given in terms of pounds per horsepower-hour (lb/hp-hour) or lb/kWh.

Example

A 300-hp steam turbine has an isentropic efficiency of 43% and a steam rate of 26 lb/hp-hour given the introduction of 600 psig/750°F steam with a 40 psig/486°F exhaust. What steam flow is necessary to replace a fully-loaded 300-hp feedwater pump drive motor?

$$\text{Steam flow} = 26 \text{ lb/hp-hr} \times 300 \text{ hp} = 7,800 \text{ lb/hr}$$

An examination of the ASME steam tables reveals that this steam turbine would utilize 103 Btu/lb of steam or 0.80 MMBtu of thermal energy per hour. Given a natural gas cost of \$5.00/MMBtu and a boiler efficiency of 80%, the fuel-related cost of steam turbine operation is $(0.80 \text{ MMBtu/hr} / 0.80 \times \$5.00/\text{MMBtu}) = \$5.00/\text{hr}$.

In comparison, a 300-hp motor with a full-load efficiency of 95% would require:

$$\frac{300 \text{ hp} \times (0.746 \text{ kW/hp})}{0.95} = 235.6 \text{ kWh/hr}$$

In this example, the steam turbine drive would provide energy cost savings when the price of electricity exceeds:

$$\frac{\$5.00/\text{hr} \times 100 \text{ cents}/\$}{235.6 \text{ kWh/hr}} = 2.12 \text{ cents/kWh}$$

The total annual energy savings are strongly dependent upon the facility energy cost and the hours per year of feedwater pump operation. Annual energy savings are given in Table 1 for various electrical rates and pump operating schedules. In addition to operating cost savings, steam turbine maintenance costs should be compared with electric motor maintenance expenses.

OFFICE OF INDUSTRIAL TECHNOLOGIES
ENERGY EFFICIENCY AND RENEWABLE ENERGY • U.S. DEPARTMENT OF ENERGY

Table 1. Annual Energy Savings when Using a Steam Turbine Feedwater Pump Drive¹

Electricity Costs, \$/kWh	Feedwater Pump Annual Operating Hours				
	2,000	4,000	6,000	7,000	8,760
0.03	\$4,105	\$8,210	\$12,310	\$14,365	\$17,975
0.05	13,525	27,050	40,570	47,330	59,230
0.075	25,305	50,605	75,910	88,560	110,830

¹ Savings are based upon operation of a 300-hp steam turbine drive with a steam rate of 26 lbs/hp-hr. A natural gas cost of \$5.00/MMBtu is assumed.



BestPractices is part of the Office of Industrial Technologies' (OIT's) Industries of the Future strategy, which helps the country's most energy-intensive industries improve their competitiveness. BestPractices brings together the best-available and emerging technologies and practices to help companies begin improving energy efficiency, environmental performance, and productivity right now.

BestPractices emphasizes plant systems, where significant efficiency improvements and savings can be achieved. Industry gains easy access to near-term and long-term solutions for improving the performance of motor, steam, compressed air, and process heating systems. In addition, the Industrial Assessment Centers provide comprehensive industrial energy evaluations to small and medium-size manufacturers.

FOR ADDITIONAL INFORMATION, PLEASE CONTACT:

Peter Salmon-Cox
Office of Industrial Technologies
Phone: (202) 586-2380
Fax: (202) 586-6507
Peter.Salmon-Cox@hq.doe.gov
www.oit.doe.gov/bestpractices

OIT Clearinghouse
Phone: (800) 862-2086
Fax: (360) 586-8303
clearinghouse@ee.doe.gov

Please send any comments, questions, or suggestions to webmaster.oit@ee.doe.gov

Visit our home page at www.oit.doe.gov

Office of Industrial Technologies
Energy Efficiency and Renewable Energy
U.S. Department of Energy
Washington, DC 20585-0121



DOE/GO-102002-1475
January 2002
Steam Tip Sheet #21

About DOE's Office of Industrial Technologies

The Office of Industrial Technologies (OIT), through partnerships with industry, government, and non-governmental organizations, develops and delivers advanced energy efficiency, renewable energy, and pollution prevention technologies for industrial applications. OIT is part of the U.S. Department of Energy's Office of Energy Efficiency and Renewable Energy.

OIT encourages industry-wide efforts to boost resource productivity through a strategy called Industries of the Future (IOF). IOF focuses on the following nine energy- and resource-intensive industries:

- Agriculture
- Aluminum
- Chemicals
- Forest Products
- Glass
- Metal Casting
- Mining
- Petroleum
- Steel

OIT and its BestPractices program offer a wide variety of resources to industrial partners that cover motor, steam, compressed air, and process heating systems. For example, BestPractices software can help you decide whether to replace or rewind motors (MotorMaster+), assess the efficiency of pumping systems (PSAT), compressed air systems (AirMaster+), steam systems (Steam Scoping Tool), or determine optimal insulation thickness for pipes and pressure vessels (3E Plus). Training is available to help you or your staff learn how to use these software programs and learn more about industrial systems. Workshops are held around the country on topics such as "Capturing the Value of Steam Efficiency," "Fundamentals and Advanced Management of Compressed Air Systems," and "Motor System Management." Available technical publications range from case studies and tip sheets to sourcebooks and market assessments. The *Energy Matters* newsletter, for example, provides timely articles and information on comprehensive energy systems for industry. You can access these resources and more by visiting the BestPractices Web site at www.oit.doe.gov/bestpractices or by contacting the OIT Clearinghouse at 800-862-2086 or via email at clearinghouse@ee.doe.gov.

Appendix C: Guidelines for Comment

Comments that can correct and improve this Sourcebook are appreciated. Please photocopy this page and provide suggestions to the address listed below.

Improving Steam System Performance, A Sourcebook for Industry Comment Form

Page Number(s)

Comments

From:

Mail or fax to: Anthony Radspieler, Jr.
Lawrence Berkeley National Laboratory
901 D Street., SW, Suite 950
Washington, DC 20024
Direct Phone: 202-646-7956
Main Phone: 202-646-7950
Fax: 202-646-7800
E-mail: aradspieler@lbl.gov



To order additional copies of
this sourcebook, please call:

Office of Industrial Technologies
Information Clearinghouse
800-862-2086

Co-sponsored by:



Council of Industrial Boiler Owners

Council of Industrial Boiler Operators
6035 Burke Centre Parkway, Suite 360
Burke, VA 22015



National Insulation Association
99 Canal Center Plaza, Suite 222
Alexandria, VA 22314



**North American Insulation Manufacturers
Association**
44 Canal Center Plaza, Suite 310
Alexandria, VA 22314

Office of Industrial Technologies
Energy Efficiency and Renewable Energy
U.S. Department of Energy
Washington, D.C. 20585



DOE/GO-102002-1557
June 2002