

Summary of Findings and Condition to Date

Outline Condition Survey of Melin Daron, Aberdaron

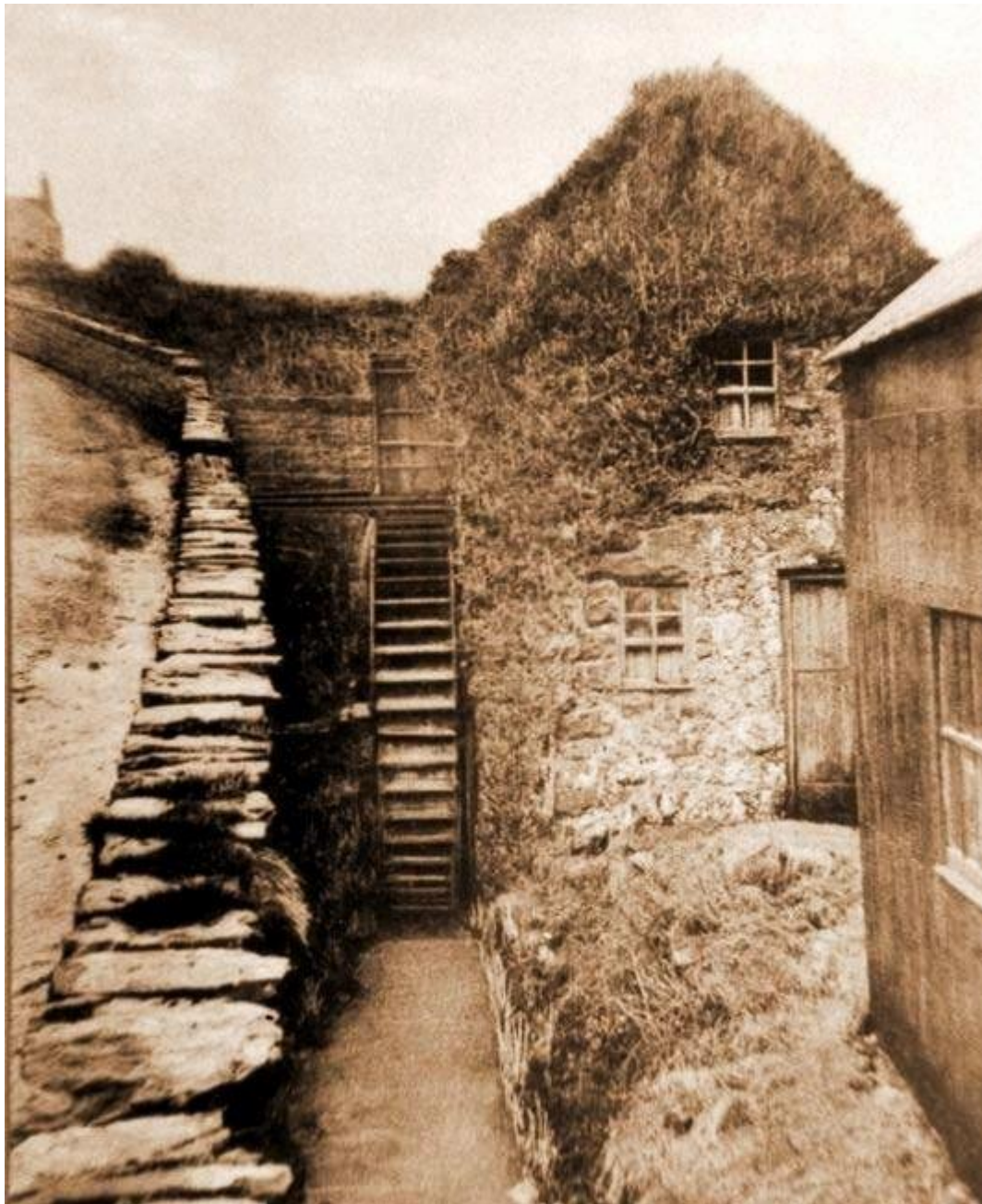

Copyright of Melin Daron Cyf

Date of Inspection: 12 August 2020
Weather Conditions: Sunny, clear, dry 20°C

Contents

1.	Introduction.....	3
2.	Scope of Survey and Exclusions	3
3.	Executive Summary.....	3
4.	Condition Survey	4
5.	Brief Description	5
6.	Overview Photographs	6
7.	Plan	7
8.	External Condition Survey	9
9.	Internal Condition Summary	22
10.	Appendices.....	32
	- <i>Cost Plan – Cavendish Bloor</i>	
	- <i>Roof Inspection Report – Slate & Stone Consultants</i>	
	- <i>Outline Roof Proposals – Cymdeithion Donald Insall Associates</i>	
	- <i>Staff WC and Brew up area – Cymdeithion Donald Insall Associates</i>	
	- <i>Structural Condition Report - Chris Pike Associates</i>	
	- <i>Visual Condition Survey Report - Dorothea Restorations</i>	

Issue date: September 2020

Prepared by: Gethin Roberts & Matt Osmont

Checked by: Matt Osmont

Contact information

Matt Osmont

matt.osmont@insall-architects.co.uk

Tel: 01492 592378

Conwy Office

Donald Insall Associates

Y Becws, Pool Lane, Conwy, LL32 8PZ

www.insall-architects.co.uk

This report and all intellectual property rights in it and arising from it are the property of or are under licence to Donald Insall Associates or the client. Neither the whole nor any part of this report, nor any drawing, plan, other document or any information contained within it may be reproduced in any form without the prior written consent of Donald Insall Associates or the client as appropriate. All material in which the intellectual property rights have been licensed to Donald Insall Associates or the client and such rights belong to third parties may not be published or reproduced at all in any form, and any request for consent to the use of such material for publication or reproduction should be made directly to the owner of the intellectual property rights therein.

1. Introduction

This report was commissioned by Melin Daron Cyf to obtain an overview of the condition of Melin Daron. The report will identify critical vulnerabilities within the existing fabric and will also be used to inform where we can target our interventions to most beneficially and cost-effectively repair the existing fabric.

2. Scope of Survey and Exclusions

The inspection was carried out through a non-invasive visual inspection from ground level and scaffolding.

The report is restricted to the general condition of the building and its defects. It is not a specification for the execution of the work and must not be used as such.

The following items are outside the scope of the inspection;

- Mechanical and electrical installation including legionella, alarm system, data/telecommunications, heating and water systems, renewable energy installations etc.
- Portable and fixed appliances.
- Loose furniture, artefacts and furnishings (other than decoration).
- Asbestos.
- Ecology.
- Archaeology below ground or concealed.

We have not had access to any previous inspection reports, maintenance records or specialist reports, therefore, it has not been possible to assess what action has been carried out or which items observed and highlighted in this report have been subject to previous reports or investigations.

The purpose of this report is to outline the necessary work to repair the building over the short term with a general indication of more long term issues. The report is intended to be clear, concise but not lacking in detail where necessary and to be understood by the lay person.

Nothing in this report is to be taken as criticism of or evidence against any person or organisation.

3. Executive Summary

In general, Melin Daron is in a fair and reasonable condition, considering the limited level of repairs and intervention over its recent history, however, there are issues that need to be addressed urgently.

Other than the lean-to Store at the rear of the building, the external masonry is generally in sound condition with vertical cracks evident in places and localised areas of bowing stonework, all of which will need to be consolidated and stitched. The mortar pointing is generally satisfactory to most facades. The north and west facing elevations are mostly buttered lime pointing, however, there are localised areas of past repairs where at least three different types of cementitious mortar have been used – these mortars discourages breathability and will eventually perish with penetrating damp then becoming an issue. The pointing to the south and east elevations are sparser and have mostly perished, failed or completely washed away.

The levels of the ground externally are higher than the internal ground floor level towards the south and east of the building, mainly in the area outside the external double doors into the Mill Range, and without provisions for a French drain to take water away from the building. There is poor drainage to most adjacent land surrounding the building perimeter, and this further compounds the effect of the high external ground levels and lack of effective surface water drainage. The intervention of a French drain (or similar) would help prevent further decay of structural timber members (Hurst Frame in particular) and the unsettlement of the floors, and in time, the structural walls too.

Generally, the roofs are in poor condition with several openings visible in the cover with many slipped and damaged slates. The random diminished courses are largely intact but the vast majority of those have been bedded together with very hard mortar, however, it is hoped that circa 30% of the slates can be salvaged and re-used to re-roof. The valleys are a mixture of traditional Welsh valleys and more modern metal flashing with a lead lined tapered gutter between the two eastern pitched roofs of the Dresser Range and the Grain Dryer. The Welsh valleys are damaged and have slipped in places with the metal flashings also not preventing water ingress into the roof space where damage to the structural roof members are obvious in localised areas.

Internally, the stone facing of the structural wall between the Mill Range and the Grain Dryer has partially collapsed whilst the entire floor area above the heated chamber in the Grain Dryer has been removed in its entirety with only the supporting iron rods remaining.

The timber joists and floors are rotting in areas adjacent to the saturated walls. At first floor level, the effect of both wet and dry rot are apparent in timbers and coverings adjacent to saturated masonry.

In the short and medium term (5 years), efforts are required to arrest the decay of the structural timber members, especially those supporting the roofs, stop water ingress into the building through openings in the roofs and walls. All of this could be achieved by:

- Installation of a French drain, or similar type of land drain, around the perimeter of the building.
- External masonry walls will need to be repointed now in order to prevent any further degradation of the mortar bedding and ultimately the structural integrity of the stonework.
- Close up all openings to all roofs, patch repair valleys and replace all slipped slates in-situ.
- Secure all window and door openings to the entire building.
- Defrass all friar areas and rot to structural timber members and promote drying to reduce its moisture content. Secondary measures may be required, particularly where infestation is extensive, through chemical treatment with suitable preservatives. Major damage could necessitate conservative timber repairs but avoid automatic wholesale replacement. A timber analyst should be commissioned to comment on insect presence generally.

In the long term (10 years plus) it would be beneficial to re-roof the entire building like-for-like with traditional techniques as demonstrated in the 'Outline Roof Proposals' diagram in the appendices. As there are historically no rainwater goods to the building, it is therefore essential to ensure that an effective dripping eaves detail is achieved – this, along with a robust French drain (or similar), would discharge water run-off from the roofs away from the building effectively as well as surface water drainage.

Additionally, structural repairs to all floors and the localised rebuild of the structural wall between the Mill Range and the Grain Dryer, along with careful repairs to the historical machinery are essential to avoid further decay and structural instability. The reinstatement of the floor above the heated chamber will also need to be carried out as far as practically possible to a like-for-like basis.

Finally, desired (and sensitive) interventions to the building can be achieved once all of the above essential works have been successfully achieved in order to get this wonderful historic mill back to its former glories.

4. Condition Survey

In summary, the immediate works required at Melin Daron relate to carrying out emergency repairs such as closing openings in the roof covering and external structural walls to prevent water ingress that is currently causing damage to the building's structure and fabric. Additionally, intrusive investigations into large structural cracks identified around in localised areas of the building is also required along with the clearing of vegetation, builder's materials and rubble both within the building and its perimeter.

Other works identified are less urgent and relates to repairs to improve the buildings condition and performance, which includes repointing stonework, installing temporary rainwater goods and managing the roof covering.

Where applicable, commentary has also been provided on the potential replacement of unsympathetic repairs to restore the building's character and breathability of the traditionally constructed building.

5. Brief Description

Melin Daron is a Grade II listed early 19th century two storey multi-phased rural corn-mill building situated in Aberdaron. The mill complex is located on the northern bank of Afon Daron, a little way above its confluence with Afon Cillfelyn, upstream from the point where it flows into the bay.

The listing describes it as “a substantial village corn-mill of vernacular type, and, despite the loss of the wheel, still retaining character as a rural industrial building”. The mill building survives in good condition, including much of its machinery, and has clearly developed over time with the original building possibly being 18th century or earlier in date. The survival of the corn-drying increases the significance of Melin Daron.

The complex comprises a number of elements. The mille range appears to be the earliest surviving building on site and is likely to be the original mill building. The building lies at the centre of the complex and contains most of the machinery, which are also listed grade II. Other buildings within the range include a corn dryer (The Grain Dryer), a range to house the flour dressing machines (The Dresser Range), a stable and a store (Service Range). A stone-built wheel pit, which contains parts of the water wheel in-situ, is situated between the longitudinal retaining wall of the public road (B1143) and the north-west end of the building. The mill pond and its associated leat is located to the rear of the building, which had likely been the main water supply to the mill building. The water was extracted from Afon Daron into the millpond some 850 meters to the east of the mill. A coal yard and a well and pump are also visible in the vicinity.

There is graffiti in various places throughout the mill complex, which includes depictions of both ships and cats and also a number of dates.

Name	Grade	Listing Reference Number:
Y Felin	II	19992

6. Overview Photographs



Front elevation with the gable walls of the Grain Dryer (right) and Dresser Range (left).



Intersection of the roofs of the Mill Range (right) and the Stable (left).



Gable wall of the south eastern end of the Mill Range with the Grain Dryer (left) and Stable (right).



Welsh valley with random diminishing slate roofs of the Dresser Range and north gable of the Mill Range.



Close up of a classic traditional Welsh valley between the Main Range and Dresser Range.



Recording and assessment of the traditional Welsh valley taking place.

7. Plan

7.1 Ground Floor Plan Referencing

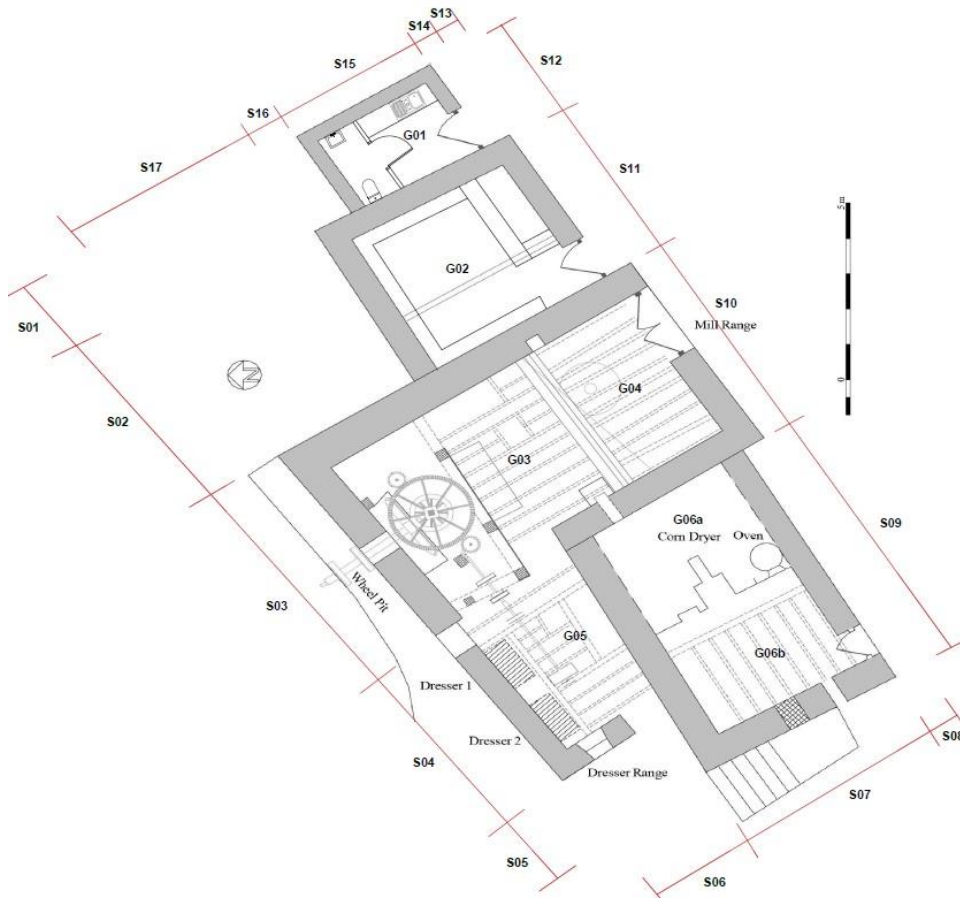

7.2 First Floor Plan Referencing

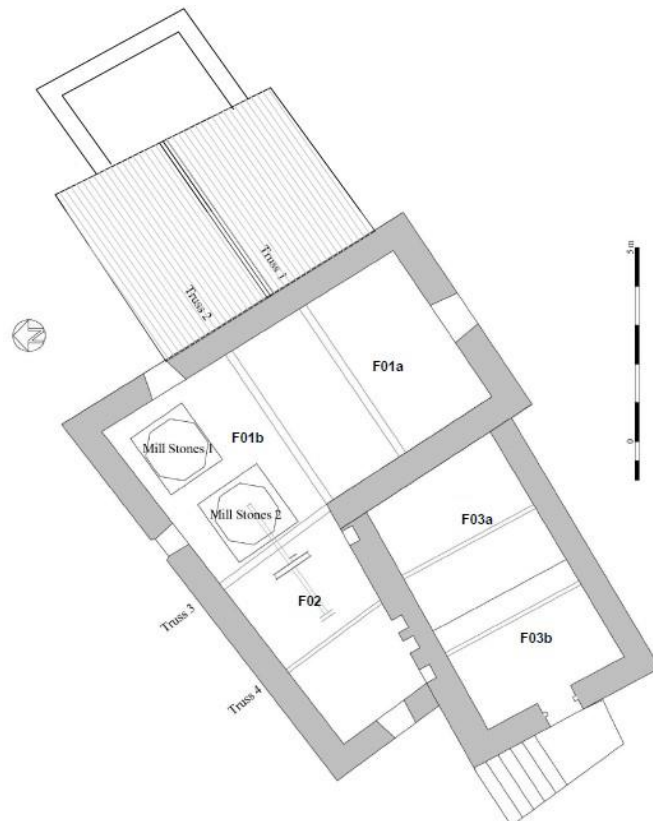

7.3 Elevations Referencing

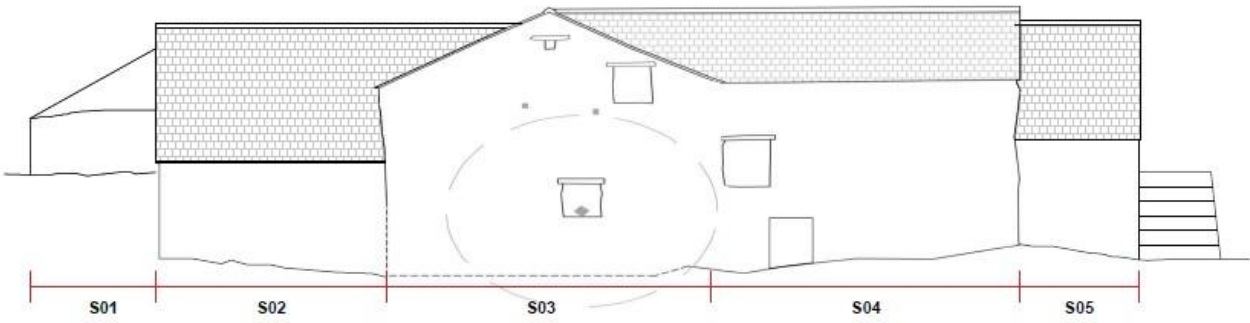
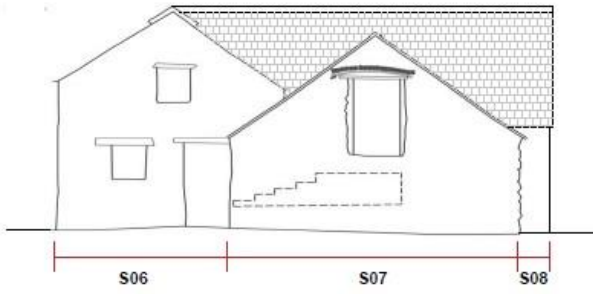

8. External Condition Survey

8.1 Elevations

8.1.1 General Notes

Allow to clear all vegetation from within 1m of building.

Allow to clear all builders' materials from within 1m of building.

Allow to clear wheel pit of vegetation, or at least treat with weed killer (avoiding contamination of building).

Allow palletising all reasonable stones on ground to perimeter of building.

Allow to cut all main stems to ivy to perimeter of building.

French drain to perimeter of building discharging into mill wheel pit(?).

Stone paving apron to south east and south west elevations. To full width of lane to south east elevation and to extend 10m in front of south west elevation.

New mains water connection. Stop cock to be located in Store.

Allow for supply and installation of fire alarm, security alarm, CCTV and WiFi.

Allow for supply and installation of interpretation boards, story boards and marketing information material.

Design development contingency at 10%.

Project Contingency at 15%.

8.1.2 Section 01 (North Elevation)

Configuration:

North wall of Store. Roughly coursed stonework with minimal mortar.

Condition:

Unable to adequately assess condition of walls as they were obscured by vegetation.

Recommendations:

1. Architectural Repairs

- Allow to clear all vegetation and brambles.
- Allow to rake out salvaging all pinnings as raking out undertaken.
- Deep repointing required in hot mix.

2. Architectural Proposals

- None.

3. Structural Repairs

- Allow to consolidate masonry to wall tops.

4. Engineering Repairs/Proposals

- None.

Overview photos:



8.1.3 Section 02 (North Elevation)

Configuration:

North wall of Stable. Roughly coursed stonework with buttered pointing.

Condition:

Unable to adequately assess condition of walls as they were obscured by vegetation.

Recommendations:

1. Architectural Repairs

- Allow to clear all vegetation.
- Allow to rake out salvaging all pinnings as raking out undertaken.
- Deep repointing required in hot mix.

2. Architectural Proposals

- Erect weatherproof lean-to structure with slate cover, clad in timber along with vented timber access doors. To be erected by the Client.

3. Structural Repairs

- None.

4. Engineering Repairs/Proposals

- Supply and install recirculation pump against rear wall of Stable. Pump will require a 3 phase 415V supply to the mill.
- Provide direct electrical drive for machinery rotation only – to be powered by 3-phase 415V supply. The motor to be partnered with a soft start inverter.

Overview photos:



8.1.4 Section 03 (North Elevation)

Configuration:

North gable wall of Mill Range. Stonework with buttered pointing to c.40%. 1 no window opening. Section contains the forged wrought iron shaft of the water wheel. Parts of the overshot water wheel, including the axle, hubs, cover

plates and some of the eight wooden spokes, are still in-situ, as are two wrought iron "I" beams supports for the launder and an iron rod hanging out of a small opening at the top of the gable for the launder flap. Part of the control mechanism, which raised a trap in the launder to let water onto the wheel is also intact.

Condition:

Missing stone to section of outer skin of wall at low level next to opening for water wheel shaft. The majority of the iron elements of the water wheel have rusted but potentially salvageable, however, the surviving spokes and the iron beams are heavily wasted and bowed. Lower section of gable obscured by vegetation and rubble with standing area quite spongy. Minimal mortar present to c.60%. Buttered pointing present to c.40%, generally in satisfactory condition. Evidence of past repair to 3no cracks with buttered pointing with cementitious mortar.

Recommendations:

1. Architectural Repairs

- Allow to clear all vegetation.
- Deep repointing required to 60% in hot mix.

2. Architectural Proposals

- 2no new window required. Details TBC.

3. Structural Repairs

- Allow to rebuild outer skin locally to area of wall next to water wheel shaft with salvaged stone – approximately 2 sqm.
- Localised stitching required to at least 3no locations – approximately 4 lin. meters.

4. Engineering Repairs/Proposals

- Renew 3no Launder support "I" beams to match existing (6" x 3").
- All ironwork associated with machinery to be de-greased, de-rusted, cleaned and stabilised. Work to include renewal of the hub fixings.
- Design and install new oak launder and operating hatch connected to existing lever arm to a traditional design. New bearings to lever arm.
- Install slate to base of launder.
- The peg board requires re-attaching to the wall in the correct place and the iron rod passing through the wall requires 2 new plain bearings to support it. Fixing of the control rod to the end of the timber control arm should be re-wedged.
- Allow to rebuild cill to water wheel shaft opening.
- Level the cast iron waterwheel shaft. Supply new external bearing and reset shaft level.
- Supply new internal plain bronzes bearing to main shaft. Whole assembly to be re-bedded on new timbers fixed down to the wall. All 16no spokes (4.5" sq) to be renewed.
- De rust shaft and hub ironwork, paint.
- Design and build new 16ft water wheel with cast iron shrouds and timber buckets.

Overview photos:



8.1.5 Section 04 (North Elevation)

Configuration:

North wall to Dresser Range. Roughly coursed stonework with buttered pointing.

Condition:

Buttered pointing generally satisfactory.

Recommendations:

1. Architectural Repairs

- Allow to clear all vegetation, including main stems of ivy from walls.
- Clear away build-up of debris and rubbish between building and boundary wall.
- Allow to rake out salvaging all pinnings as raking out undertaken.
- Deep repointing required in hot mix.

2. Architectural Proposals

- 1no new window required. Details TBC.

3. Structural Repairs

- Allow to rebuild outer skin locally at high level at intersection of gable – approximately 0.5 sqm.

4. Engineering Repairs/Proposals

- None.

Overview photos:



8.1.6 Section 05 (North Elevation)

Configuration:

North wall to Corn Dryer. Roughly coursed stonework with buttered pointing.

Condition:

Buttered pointing generally satisfactory.

Recommendations:

1. Architectural Repairs

- Allow to clear all vegetation, including main stems of ivy from walls.
- Clear away build-up of debris and rubbish between building and boundary wall.
- Allow to rake out salvaging all pinnings as raking out undertaken.
- Deep repointing required in hot mix.

2. Architectural Proposals

- None.

3. Structural Repairs

- None.

4. Engineering Repairs/Proposals

- None.

Overview photos:



8.1.7 Section 06 (West Elevation)

Configuration:

Gable wall of Dresser Range. Roughly coursed stonework with minimal mortar present.

Condition:

Generally mortar present to most joints, at least three different types. Unlikely that any are original.

Recommendations:

1. Architectural Repairs

- Allow to clear all vegetation.
- Allow to rake out salvaging all pinnings as raking out undertaken.
- Deep repointing required in hot mix.

2. Architectural Proposals

- 2no. new windows and 1no. new door required. Details TBC.

3. Structural Repairs

Localised stitching potentially required in 3no. locations.

4. Engineering Repairs/Proposals

- None.

Overview photos:



8.1.8 Section 07 (West Elevation)

Configuration:

Gable wall of Grain Dryer. Roughly coursed stonework with minimal mortar present. Lower section of gable obscured by vegetation, rubble, remnants of original store steps. Remnants of external masonry staircase leading up to first floor.

Condition:

Localised areas to outer skin of stonework and apex of gable wall in poor condition with majority of mortar perished. Unable to assess condition of walls that were obscured by vegetation. External staircase has largely deteriorated and collapsed in areas with the majority under a pile of rubble and masked by vegetation.

Recommendations:

1. Architectural Repairs

- Allow to clear all vegetation.
- Allow to rake out salvaging all pinnings as raking out undertaken.
- Deep repointing required in hot mix.
- Allow to fill 1 no. hole with salvaged stone 0.25sqm.

2. Architectural Proposals

- Rebuild external staircase with salvaged stone on site in a roughly coursed method, pointed with hot mix lime mortar. Allow for 25% matching stonework for any shortfall.
- Provide new balustrade to rebuilt stone steps. Allow for 40mm stainless steel handrails and stainless steel spindles welded into stone treads and landing.
- Provide new boarded and ledged timber stable door with new hook and pin strap hinges and locks.

3. Structural Repairs

- Provisional allowance to rebuild outer skin locally - approximately 6 sqm.
- Allow temporary propping of roof to allow rebuilding of apex of gable.

4. Engineering Repairs/Proposals

- Allow to replace all ferrous metal work to lintel with new.

Overview photos:



8.1.9 Section 08 (West Elevation)

Configuration:

West wall/return of Mill Range. See Section 10 for details.

Condition:

See Section 10 for details.

Recommendations:

See Section 10 for details.

Overview photos:



8.1.10 Section 09 (South Elevation)

Configuration:

South wall to Grain Dryer. Roughly coursed stonework with minimal mortar present. 2no. areas obscured by ivy.

Condition:

Localised areas to outer skin of stonework in poor condition with majority of mortar perished. Unable to assess condition of walls that were obscured by ivy.

Recommendations:

1. Architectural Repairs

- Allow to clear all vegetation.
- Allow to rake out salvaging all pinnings as raking out undertaken.
- Deep repointing required in hot mix.

2. Architectural Proposals

- None.

3. Structural Repairs

- Provisional allowance to rebuild outer skin locally - approximately 2sqm.
- Allow temporary propping to allow reincorporation of lintel into line of elevation.

4. Engineering Repairs/Proposals

- None.

Overview photos:



8.1.11 Section 10 (South Elevation)

Configuration:

South gable wall of Mill Range. Roughly coursed stonework with minimal mortar present.

Condition:

Localised areas to outer skin of stonework in poor condition with majority of mortar perished.

Recommendations:

1. Architectural Repairs

- Allow to clear all vegetation.
- Allow to rake out salvaging all pinnings as raking out undertaken.
- Deep repointing required in hot mix.
- Allow for splice repairs to external double doors. Make good and redecorate.

2. Architectural Proposals

- None.

3. Structural Repairs

- Check structural integrity of lintel.
- Allow to rebuild masonry outer skin in 3no. locations using salvaged masonry.

4. Engineering Repairs/Proposals

- None.

Overview photos:



8.1.12 Section 11 (South Elevation)

Configuration:

South wall of Stable. Roughly coursed stonework with minimal mortar present.

Condition:

Localised areas to outer skin of stonework in poor condition with majority of mortar perished.

Recommendations:

1. Architectural Repairs

- Allow to clear all vegetation.
- Allow to rake out salvaging all pinnings as raking out undertaken.
- Deep repointing required in hot mix.

2. Architectural Proposals

- None.

3. Structural Repairs

- Allow to rebuild masonry outer skin in 3no. locations using salvaged masonry.

4. Engineering Repairs/Proposals

- None.

Overview photos:



8.1.13 Section 12 (South Elevation)

Configuration:

South wall of Store. Roughly coursed stonework with minimal mortar present.

Condition:

Note that thick vegetation and brambles made it difficult to adequately assess the section. Majority of mortar has perished and washed out with wall mostly damp. Loose stones to wall tops. One end bearing to timber lintel above entrance door completely rotted away. Refer to item 9.1.1 for further details on condition of entrance door.

Recommendations:

1. Architectural Repairs

- Allow to clear all vegetation and brambles.
- Allow to rake out salvaging all pinnings as raking out undertaken.
- Deep repointing required in hot mix.

2. Architectural Proposals

- None.

3. Structural Repairs

- Allow to consolidate masonry to wall tops.
- Allow for replacement oak timber lintel above entrance door.

4. Engineering Repairs/Proposals

- None.

Overview photos:





8.1.14 Sections 13, 14, 15 & 16 (East Elevation)

Configuration:

East facing walls of Stable and Store. Roughly coursed stonework with minimal mortar present.

Condition:

Condition of walls unknown due to areas completely obscured by vegetation. It is assumed that sections 13, 14, 15, and 16 have a similar configuration to section 11.

Recommendations:

1. Architectural Repairs

- Allow to clear all vegetation, brambles and debris.
- Allow to rake out salvaging all pinnings as raking out undertaken.
- Deep repointing required with hot mix.

2. Architectural Proposals

- None.

3. Structural Repairs

- Allow to consolidate wall tops.

4. Engineering Repairs/Proposals

- None.

Overview photos:

Unable to take suitable photographs due to area covered by thick bramble and vegetation.

8.1.15 Section 17 (East Elevation)

Configuration:

East wall of Mill Range. Stonework with buttered pointing. 1no window opening boarded up.

Condition:

Buttered pointing generally satisfactory. 3no open cracks visible.

Recommendations:

1. Architectural Repairs

- Allow to clear all vegetation.
- Allow to rake out salvaging all pinnings as raking out undertaken.
- Deep repointing required in hot mix.

2. Architectural Proposals

- 1no new window. Details TBC.

3. Structural Repairs

- Localised stitching required to at least 3no locations – approximately 3 lin. meters.

4. Engineering Repairs/Proposals

- None.

Overview photos:



8.1.16 Mill Pond

Configuration:

Dry mill pond completely filled with thick vegetation and brambles. Buttressed stone retaining walls with buttered pointing and reinforced by concrete forming footpath (Coastal Path) directly above the mill building. Galvanised steel railings erected along outer edge of west and south wall to safeguard pedestrians. West wall c.5m length by c.4m height with 3no buttresses visible. South wall c.12m length and assumed 2.5m height. A 12-inch wrought iron tube pipe evident in the stonework to west wall.

Condition:

Buttered pointing generally satisfactory. 1no buttress to west wall damaged with missing stone at mid-point. 3no cracks visible to west wall. Wrought iron outlet pipe has entirely rusted and wasted. Steel railings in good condition.

Recommendations:

1. Architectural Repairs

- Allow to clear all vegetation from pond. Pond dimensions c.4m x 11m.
- Allow to rake out salvaging all pinnings as raking out undertaken.
- Deep pointing required to entire wall on both sides.
- Consolidate wall tops and infill gaps with stone gallets.

2. Architectural Proposals

- None.

3. Structural Repairs

- Localised stitching required to at least 3no locations – approximately 3 lin. meters.
- Re-puddling pond through the application of clay to the entire inner face of the side walls, including the boundary wall, and base to make water resistant structure.
- Allow to infill damaged section of buttress with salvaged matching stone.

4. Engineering Repairs/Proposals

- Carefully remove rusted wrought iron pipe and replace with new or sleeved 12" pipe through the dam wall.
- Install a gate valve on pond side of pipe to provide control of water flow.
- Provide timber sluice gate at the head of the pond where river feeds into pond to act as an easily maintainable closing valve.

Overview photos:



9. Internal Condition Summary

9.1 Ground Floor

9.1.1 G01 – Store

Configuration:

Lean-to structure with wiggly tin roof and central purlin. Floor unknown, assume stone cobbles. Timber boarded and ledged stable door.

Condition:

South wall and roof in poor condition. Majority of mortar has perished and washed out with walls mostly damp.

Recommendations:

1. Architectural Repairs

- Allow rake out remainder of existing mortar repoint all other walls.
- Allow to deep point South wall in hot mix.
- Allow to lift and relay 50% of stone cobbles with allowance for 20% new to match existing.

2. Architectural Proposals

- Provide new corrugated lean-to roof with hot mix lime abutment detail.
- Allow to provide new timber boarded and ledged stable door with metal hook and pin strap hinges and timber latches.
- Allow for new concrete floor slab with DPM.
- Allow to tank all walls using a Type C drained tanking system with perimeter drain to room and connection into French Drain.
- Supply and install new Staff WC. To include partition, door and sanitary ware (1no close coupled toilet and 1no WHB) along with associated pipework, waste pipes and connections to public sewer.
- Foul drainage from Store to mains drains located in car park adjacent to Spar shop.
- Brew-up area and kitchen units etc (as per Option 1 on attached drawing).
- 2no green enamelled lapshaded with LED lamp suspended on galvanised chain (1no in WC and other in brew-up area).
- Electrical installation to include heavy grade surface mounted conduits and fittings.

3. Structural Repairs

- Allow to rebuild north wall and triangular sections of east and west walls.

4. Engineering Repairs/Proposals

- New 3-phase electrical supply with distribution board at high level.

Overview photos:

Unable to take suitable photographs due to area covered by thick bramble and vegetation.

9.1.2 G02 – Stable

Configuration:

Evidence of plaster above door head height to South wall, elsewhere buttered pointing to stone walls. External single ledged and brace timber entrance door.

Condition:

Majority of mortar washed out of west wall c.1500mm and under. Cracking present to South wall with localised bowing to west wall. Ledge and brace timber door in very poor condition. Majority of mortar has perished and washed out to north and east walls with these walls mostly damp.

Recommendations:

1. Architectural Repairs

- Allow to clear all vegetation.
- Allow to clear all debris from floor and clear back to existing stone cobbles.
- Allow to lift and relay 50% of cobbles with allowance for 20% new to match existing.
- Allow to rake out salvaging all pinnings as raking out undertaken.
- Deep repointing required in hot mix.

- Allow for buttered pointing in hot mix to all elevations.
- Allow for tanking up to roof level to north wall. All other walls to be tanked up to 1.5m above finished floor level.
- Allow to tank all walls using a Type C drained tanking system with perimeter drain to room and connection into French Drain.

2. Architectural Proposals

- Allow to provide new timber boarded and ledged stable door with metal hook and pin strap hinges and timber latches.
- Shop fit out – counter and shelving/racking (Provisional Allowance).
- 2no green enamelled lapshaded with LED lamp suspended on galvanised chain.
- Electrical installation to include heavy grade surface mounted conduits and fittings.

3. Structural Repairs

- Allow to rebuild 2no. sections of east wall c.2 sqm.
- Allow to consolidate recess to east wall and not infill.
- Allow to consolidate area of localised bowing to east wall.
- Allow to stitch cracking in South wall in 2 locations for total length of 4m.

4. Engineering Repairs/Proposals

- None.

Overview photos:



9.1.3 G03 – The Mill Range (Wheel Pit)

Configuration:

This end of the range contains the mill mechanism, which is contained within, and supported by, the Hurst Frame. Attached to the Hurst Frame is a wooden trough which served as the receptacle for collecting flour from the eastern stone via a wooden spout. Also sitting within this trough is a second trough. Ceiling exposed floor over GSC. Stone walls with buttered pointing. Stone flags to floor.

Condition:

Buttered pointing generally satisfactory. Localised bowing visible to east wall. Cill to wheel shaft in poor condition. Debris covering majority of floor surface, therefore, unable to fully assess condition of flags.

Recommendations:

1. Architectural Repairs

- Allow to clear all debris from floor and clean back to existing stone flags.
- Allow to brush down pointing to walls and consolidate with new to 25%.
- Allow to lift and relay 50% of stone flags with allowance for 20% new to match existing.
- Allow to repoint entire floor with suitable lime based mortar.

2. Architectural Proposals

- 1no green enamelled lapshaded with LED lamp suspended on galvanised chain.
- Electrical installation to include heavy grade surface mounted conduits and fittings.

3. Structural Repairs

- Allow to consolidate area of localised bowing to east wall.

4. Engineering Repairs/Proposals

- Allow to locally rebuild cill to wheel shaft.
- Renew teeth to pit wheel complete.
- Renew wallower complete.
- Repair two hurst frame uprights and missing side boarding.
- New timbers under upright shaft.
- New bearing bronzes to upright shaft.
- Replace damaged or missing pins from west stone nut.
- Clean and conserve, but not repair, East stone nut.
- Remove worn west pair of millstones, place in secure area of mill.
- Supply and install 1no new reconditioned set of millstones (type to be agreed).
- Set up millstones.

Overview photos:

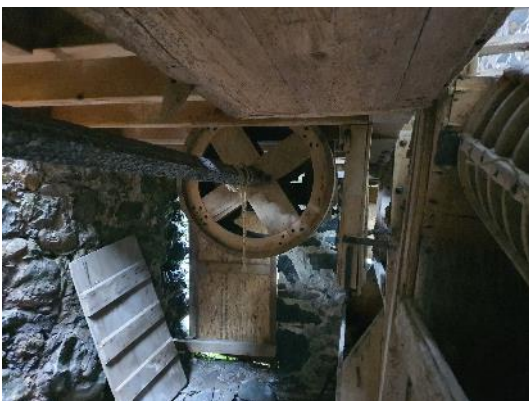

9.1.4 G04 – The Mill Range

Configuration:

Ceiling exposed floor over GSC. Stone walls with buttered pointing. Stone flags to floor. Chute for the kiln also visible from G06a. External ledged and brace timber entrance double doors.

Condition:

Buttered pointing generally satisfactory. Debris covering majority of floor surface, therefore, unable to fully assess condition of flags. Localised bowing and dishing to west wall. Chute currently unstable. Ledged and brace doors in fair condition.

Recommendations:

1. Architectural Repairs

- Allow to clear all debris from floor and clean back to existing stone flags.
- Allow to brush down pointing to walls and consolidate with new to 25%.
- Allow to lift and relay 50% of stone flags with allowance for 20% new to match existing.
- Allow to repoint entire floor with suitable lime based mortar.

2. Architectural Proposals

- 1no green enamelled lapshaded with LED lamp suspended on galvanised chain.
- Electrical installation to include heavy grade surface mounted conduits and fittings.

3. Structural Repairs

- Allow to consolidate area of localised bowing and dishing to west wall and to consolidate chute from G06a. It may be that total rebuild is required.
- Allow to locally rebuild outer skin to area of wall beneath valley to east wall.
- Allow to rebuild outer skin and strip back to perpendicular wall to SW corner.

4. Engineering Repairs/Proposals

- Repair the hopper, horse and shoe. Varnish with an environmentally friendly varnish.

Overview photos:



9.1.5 G05 – The Dresser Range

Configuration:

Ceiling exposed floor over GSC. Stone walls with buttered pointing. Stone flags to floor. Door and window openings boarded up at ground floor level.

Condition:

Buttered pointing generally satisfactory. Debris covering majority of floor surface, therefore, unable to fully assess condition of flags. Boardings to openings in very poor condition.

Recommendations:

1. Architectural Repairs

- Allow to brush down pointing and consolidate with new to 25%.
- Allow to clear all debris from floor and clean back to existing stone flags.
- Allow to lift and relay 50% of stone flags with allowance for 20% new to match existing.
- Allow to repoint entire floor with suitable lime based mortar.

2. Architectural Proposals

- Allow to provide new timber boarded and ledged stable door with metal hook and pin strap hinges and timber latches.
- 1no green enamelled lapshaded with LED lamp suspended on galvanised chain.
- Electrical installation to include heavy grade surface mounted conduits and fittings.

3. Structural Repairs

- None.

4. Engineering Repairs/Proposals

- Design, manufacture and install new take off gear to ground floor lay shaft.
- Repair sack hoist drive.
- Overhaul sack hoist, provide new chain, pin and get operational.
- Carry out minor works to west corner dresser to stabilise and conserve.
- Repair, so visually correct, other dressing machine to enable it to rotate but not be functional.
- Renew flour chutes.
- Overhaul ground floor flour bin. Overhaul tentering mechanism to make it operational.
- Conserve and stabilise hurst frame line shaft driving possible fan (not to make operational).

Overview photos:



9.1.6 G06a – The Grain Dryer (Heated Chamber)

Configuration:

Unable to fully access area. Assumed solid infill. 2no ferrous metal rods crossing the space, which formerly supported the framework supporting the floor tiles that once stood above. Highly perforated brick tube surmounted by a re-used millstone, which allowed heat from the firebox to be evenly distributed around the heat chamber.

Condition:

Metal rods have bowed and are largely rusted. Heat distributing brick tube generally in satisfactory condition.

Recommendations:

1. Architectural Repairs

- Allow to clear out all debris and soot from entire space.
- Allow to reinstate salvaged perforated clay tiles to drying floor and allow for 50% new.
- Allow to rake out salvaging all pinnings as raking out undertaken.
- Deep repointing required in hot mix.

2. Architectural Proposals

- 1no green enamelled lapshaded with LED lamp suspended on galvanised chain.

- Electrical installation to include heavy grade surface mounted conduits and fittings.

3. Structural Repairs

- None.

4. Engineering Repairs/Proposals

- Allow to replace both in-situ ferrous metal rods with new non-ferrous rods and provide 4no new steel bearers to match to support sub-frame for the perforated clay tile drying floor.
- Allow to provide new non-ferrous sub-frame.
- Allow to renew and consolidate heat distributing brick tube.

Overview photos:



9.1.7 G06b – The Grain Dryer (Stoke House)

Configuration:

Ceiling exposed floor over GSC. Stone walls with buttered pointing. Assumed brick cobbled floor. External single ledged and brace timber entrance door. Corn drying oven with arched brick wall and opening to firebox visible. The eastern end of this space has a dividing wall constructed of brick on a stone base with three openings. The northern opening gives access to the heat chamber, the central arched vault contains a firebox for the corn dryer, whilst the southern opening contains an oven.

Condition:

Buttered pointing generally satisfactory. Arched brick wall to corn drying oven in poor condition. Lintel to north wall in very poor condition. Ledge and brace timber door in very poor condition.

Recommendations:

1. Architectural Repairs

- Allow to clear all debris from floor and expose assumed brick cobbled floor.
- Allow to brush down pointing and consolidate with new to 25% of 2no. walls and repoint 1no. entirely.
- Allow to replace 25% brick cobbles and repoint entire floor.

2. Architectural Proposals

- Provide new boarded and ledged timber stable door with new hook and pin strap hinges and locks.

- 1no green enamelled lapshaded with LED lamp suspended on galvanised chain.
- Electrical installation to include heavy grade surface mounted conduits and fittings.

3. Structural Repairs

- Allow for full archaeological recording of arched wall to corn drying oven and rebuild in its entirety using any recovered bricks. Allow for 75% replacement salvaged bricks. 'Specials' required for pointed arch and significant rebuilding to northern half of wall.
- Allow for new lintel to north opening.

4. Engineering Repairs/Proposals

- None.

Overview photos:



9.2 First Floor

9.2.1 F01a – The Mill Range

Configuration:

South eastern end of the range. Room in the roof configuration. Stone walls with buttered pointing. Timber floor consisting of joists and boards. Underside of roof slates has been torched with lime mortar in places, in particular the north eastern end. Truss with raking struts crosses the range at this point. This area includes a hatch for a sack hoist.

Condition:

Buttered pointing generally satisfactory. Timber floor (both boards and structure) perished to approx. half the floor. Some of rafters have signs of rot. Majority of torching has failed.

Recommendations:

1. Architectural Repairs

- Allow to brush down pointing and consolidate with new to 25%.
- Allow for 5no. splice repairs to rafters to 50% of length.

2. Architectural Proposals

- Allow to provide 1no. new timber casement window, details TBC.
- 1no green enamelled lapshaded with LED lamp suspended on galvanised chain.
- Electrical installation to include heavy grade surface mounted conduits and fittings.

3. Structural Repairs

- Allow to replace boards and joists in their entirety to this area on a like-for-like basis (joists 65 x 125mm and floorboards 170 x 25mm).
- Allow to locally rebuild outer skin of stonework immediately below valley to east wall.
- Allow to shim under rafters to reinstate connection to 4no. purlins.

4. Engineering Repairs/Proposals

- None.

Overview photos:



9.2.2 F01b – The Mill Range

Configuration:

North western end of the range. Room in the roof configuration. Stone walls with buttered pointing. Timber floor consisting of joists and boards. Underside of roof slates has been torched with lime mortar in places. 2no sets of stones within octagonal tuns. "A" frame truss crosses the range at this point.

Condition:

Buttered pointing generally satisfactory. Timber floor (both boards and structure) perished to approx. half the floor. Some of rafters have signs of rot. Majority of torching has failed.

Recommendations:

1. Architectural Repairs

- Allow to brush down pointing and consolidate with new to 25%.
- Allow to replace valley board to west wall.
- Allow for 5no. splice repairs to rafters to 50% of length.

2. Architectural Proposals

- Allow to provide 1no. new timber casement window, details TBC.
- 1no green enamelled lapshaded with LED lamp suspended on galvanised chain.
- Electrical installation to include heavy grade surface mounted conduits and fittings.

3. Structural Repairs

- Allow to replace boards and joists in their entirety to this area on a like-for-like basis (joists 65 x 125mm and floorboards 170 x 25mm).
- Allow to locally rebuild outer skin of stonework immediately below valley to west wall and adjacent to F03.
- Allow to shim under rafters to reinstate connection to 3no. purlins.

4. Engineering Repairs/Proposals

- Renew the octagonal Tuns complete.
- Install operating ropes.

Overview photos:



9.2.3 F02 – The Dresser Range

Configuration:

Room in the roof configuration. Stone walls with buttered pointing. Timber floor consisting of joists and boards.

Condition:

Buttered pointing generally satisfactory. Timber floor (both boards and structure) perished to approx. half the floor. Some of rafters have signs of rot.

Recommendations:

1. Architectural Repairs

- Allow to brush down pointing and consolidate with new to 40%.
- Allow to replace valley board to west wall.
- Allow for 5no. splice repairs to rafters to 50% of length.
- Allow to reinstate slate lining to east recess to South wall.

2. Architectural Proposals

- Allow to provide 1no. new timber casement window, details TBC.
- 2no green enamelled lapshaded with LED lamp suspended on galvanised chain.
- Electrical installation to include heavy grade surface mounted conduits and fittings.

3. Structural Repairs

- Allow to replace boards and joists in their entirety to this area on a like-for-like basis (joists 65 x 125mm and floorboards 170 x 25mm).
- Allow to locally rebuild outer skin of stonework in 2no. locations.
- Allow to shim under rafters to reinstate connection to 3no. purlins.

4. Engineering Repairs/Proposals

- None.

Overview photos:



9.2.4 F03a – The Grain Dryer (Drying Chamber)

Configuration:

Originally the drying chamber. Stone walls with buttered pointing. Floor has been removed with the square clay floor tiles stacked within F03b.

Condition:

Buttered pointing generally satisfactory. 3 no. iron ties loose on floor of F03b, 2no. remain in-situ. The eastern wall has partly collapsed in the north eastern corner.

Recommendations:

1. Architectural Repairs

- Allow to brush down pointing and consolidate with new to 25%.
- Allow to remove 0.5 sqm of cementitious pointing and repoint with hot mix.
- Allow for splice repair to P1.

2. Architectural Proposals

- 1no green enamelled lapshaded with LED lamp suspended on galvanised chain.
- Electrical installation to include heavy grade surface mounted conduits and fittings.

3. Structural Repairs

- Allow to rebuild collapsed section (c.9sqm) - take down and rebuild both outer skins and core.

4. Engineering Repairs/Proposals

- Provisional allowance to consolidate corn drying oven.

Overview photos:



9.2.5 F03b – The Grain Dryer (Storage)

Configuration:

Room in the roof configuration. Stone walls with buttered pointing. Timber floor consisting of joists and boards.

Condition:

Trimmer to floor missing for half its length. Rot prevalent to bearing ends of floor beans, trimmers and joists. Section of floor missing adjacent to stair opening. Buttered pointing generally satisfactory.

Recommendations:

1. Architectural Repairs

- Allow for splice repairs to beam c.220 x 200mm. Allow to defrass beam entirely and redo connections to 8no joists.
- Salvaged clay tiles stored to first floor need to be carefully relocated to ground floor.
- Allow to brush down pointing and consolidate with new to 25%.
- Allow to replace 50% of floor boards.

2. Architectural Proposals

- 1no green enamelled lapshaded with LED lamp suspended on galvanised chain.
- Electrical installation to include heavy grade surface mounted conduits and fittings.

3. Structural Repairs

- Allow to replace trimmer to eastern edge of floor – detail TBC.

4. Engineering Repairs/Proposals

- None.

Overview photos:



Donald Insall Associates

Appendix Contents

Contact

Harvey Bloor PGDipCHE DipQS MRICS
Director

Client

Melin Daron cyf

Project Title

Melin Daron

Report Date

September 2020

Report Revision

01

Cavendish Bloor Ltd

Brook House
12 Manor Avenue
Wistaston
Cheshire CW2 8BD

T : 01270 663507

M : 07971 628543

E : harvey.bloor@cavendishbloor.co.uk

www.cavendishbloor.co.uk

Budget Cost Plan

CONTENTS

Document Details

Assumptions & Exclusions

Basis of Costs

Summary

Section 1 Summary

Section 2 Internal Works

Section 3 Envelope

Section 4 Milling Machinery

Section 5 External Works

DOCUMENT DETAILS

Distribution List:

Name	Date	Company	Copy
File	10-Sep-20	Cavendish Bloor	1
G. Roberts	10-Sep-20	Donald Insall Associates	1
M. Osmont	10-Sep-20	Donald Insall Associates	1

Document Status:

Revision	01
Status	LIVE
Document Ref	P0373/Cost Planning/Feasibility
Prepared	H. Bloor
Checked	A. Jones

Project Details:

Client	Melin Daron cyf
Project	Melin Daron
Location	Aberdaron
CBL Project No	P0373

ASUMPTIONS & EXCLUSIONS

Ref.	Assumptions & Exclusions
1	No allowance included for the removal of asbestos or other contaminated material.
2	Excludes provision of loose furniture and fittings.
3	External waterproof housing (provided by Melin Daron cyf)
4	All costs are budgets, and a range of +/- 15% should be allowed.

BASIS OF COSTS

Consultant	Document Ref.	Rev.	Document Title
Donald Insall Associates		Aug-20	Summary of Findings and Condition to Date
Donald Insall Associates	MDCF.01	0	WC & Brew-up Options 1 & 2
Wallis Conservation Ltd		1	Visual Condition Survey
Chris Pike Associates	2020/1192/01	1.0	Preliminary Notes for Structural Repairs & Development (26/08/2020)
Terry Hughes Slate & Stone Consultant		Aug-20	The Slating of Melin Daron
Terry Hughes Slate & Stone Consultant	Email: 27 August 2020		Roofing materials supply costs

Ref	1: General Summary	Cost £	%	Comments
1	Internal Works	104,000	14	
2	Envelope	155,000	21	
3	Milling Machinery	106,000	14	
4	External Works	131,000	18	
5	Preliminaries	69,000	9	14% Allowance
Total: Building Works		565,000	76	
6	Project Design Team Fees	0	0	Excluded
Total: Base Cost Estimate		565,000	76	
7	Contingencies; Design Development	57,000	8	10% allowance
8	Contingencies; Project	85,000	11	15% allowance
Total: Cost Limit (Excluding Inflation)		707,000	95	
9	Inflation (General Building Cost Index)	35,000	5	Mid point 4Q21
Total: Option Cost Limits (Including Inflation)		742,000	100	

Note: *All costs exclude VAT*
Budget costs only, a range of +/- 15% should be allowed.

Ref	2: Internal Works	Qty	Unit	Rate	Value	Comments
1.0	General					
1	Remove debris from within building; sort and set aside salvageable materials		item		750.00	
2.0	Walls					
1	Rake out and repoint walls; lime mortar	137	m ²	75.00	10,275.00	
2	Extra over; remove cementitious pointing	1	m ²	20.00	20.00	
3	Tanking to walls	49	m ²	40.00	1,960.00	
4	Perimeter drain to base of tanking	12	m	30.00	360.00	
5	Extra over; connections to French drain	2	nr	500.00	1,000.00	
6	Reinstate slate lining to recess		item		300.00	F02
3.0	Floors					
1	Concrete slab, 150mm thick; laid on hardcore and dpm; including excavation and earthworks	8	m ²	110.00	880.00	
2	Replace floor beam; oak; 4.50m		item		400.00	FB08
3	Lift and relay stone cobbles / slabs	48	m ²	90.00	4,320.00	G01 - G05
4	Extra over; new cobbles / slabs to match existing	21	m ²	80.00	1,680.00	
Carried Forward £					21,945.00	

Ref	2: Internal Works	Qty	Unit	Rate	Value	Comments
Brought Forward £					21,945.00	
3.0	Floors (contd)					
5	Point cobbled / stone floor; lime mortar	74	m ²	75.00	5,550.00	
6	Reinstate salvaged perforated clay tiles, stored at first floor	16	m ²	70.00	1,120.00	G06a
4.0	Upper Floors					
1	Replace defective / broken joists	31	m	18.00	558.00	
2	Rebed beam in wall sockets; 110 x 300mm		item		100.00	FB1
3	Allow for face fixed battens at wall support where decayed joist ends		item		500.00	Extent unknown
4	Replace floor boards	107	m ²	32.00	3,424.00	
5.0	Staff Kitchen & WC					
1	Stud partition	5	m ²	80.00	400.00	
2	Internal door and frame; single	1	nr	600.00	600.00	
3	WC & wash hand basin		item		800.00	
4	Kitchenette		item		2,000.00	
Carried Forward £					36,997.00	

Ref	2: Internal Works	Qty	Unit	Rate	Value	Comments
Brought Forward £					36,997.00	
6.0	Fittings, Furnishings & Equipment					
1	Archaeological recording and reconstruct brick oven, to suit future use		item		15,000.00	
2	Shop fit out, including counter, shelving / racking		item		7,500.00	
7.0	M&E services installations					
1	Plumbing installation to Staff Kitchen & WC		item		2,500.00	Includes electrical at-source water heater
2	Electrical installation, including heavy grade surface mounted conduits and fittings	223	m ²	90.00	20,070.00	Small power and lighting
3	Lamp shades; green enamelled	14	nr	100.00	1,400.00	
4	Fire alarm / security alarm / CCTV / Wi-fi		item		10,000.00	
5	BWIC with services	223	m ²	5.00	1,115.00	
6	Extract to kitchen and WC		item		1,750.00	
8.0	Interpretation					
1	Interpretation boards / storey boards / information etc.		item		7,500.00	
Carried Forward to Summary £					103,832.00	

Ref	3: Envelope	Qty	Unit	Rate	Value	Comments
1.0	Roof					
1	Allow for potential repairs to purlins and trusses		item		2,500.00	
2	Replace missing cross tie brace; to truss 2		item		250.00	
3	Replace bolted tenon joints; trusses T3 - T8		item		500.00	
4	Splice repairs to defective rafter tails	90	nr	45.00	4,050.00	
5	Refix wall plate; resin fixed	34	m	40.00	1,360.00	
6	Provide collar-tie ceiling at high level to restrict spread		item		1,500.00	
7	Lateral restraint strapping at gable ends	14	nr	10.00	140.00	
8	Provide positive nail fixings between rafters and purlins and at wallplate		item		400.00	
9	Strip existing roofing; sort and set aside re-usable materials; dispose arisings	301	m ²	20.00	6,020.00	
10	Supply only; slate, Penrhyn quarry		item		33,230.40	Quote: Richard Jordan
11	Supply only; slate valleys		item		2,116.00	Quote: Richard Jordan
12	Haulage		item		500.00	
13	Lay slates, including battens	301	m ²	68.75	20,693.75	
Carried Forward £					73,260.15	

Ref	3: Envelope	Qty	Unit	Rate	Value	Comments
Brought Forward £					73,260.15	
1.0	Roof (contd)					
14	Lay slate valleys	20	m	125.00	2,500.00	
15	Supply and lay lead valleys	11	m	85.00	935.00	
16	Supply and lay lead valley gutters	6	m	350.00	2,100.00	
17	Supply and lay clay ridge tiles	48	m	40.00	1,920.00	
18	Corrugated metal lean-to roof	14	m ²	75.00	1,050.00	
19	Hot mix lime abutment flashings	10	m	30.00	300.00	
20	Torching to underside of slates	301	m ²	50.00	15,050.00	
2.0	External Walls					
1	Clear vegetation	190	m ²	7.50	1,425.00	
2	Block underpinning to walls; large bedding stones	24	m	350.00	8,400.00	Includes internal walls
3	Take down and rebuild bowed walls	40	m ²	250.00	10,000.00	Includes internal walls
4	Strengthen / widen wall foundations in areas of collapse	20	m	150.00	3,000.00	Includes internal walls
5	Rebuild outer skin of wall	15	m ²	150.00	2,250.00	
6	Rebuild cill to water wheel opening		item		250.00	
Carried Forward £					122,440.15	

Ref	3: Envelope	Qty	Unit	Rate	Value	Comments
Brought Forward £					122,440.15	
2.0	External Walls (contd)					
7	Consolidate recess in stable wall		item		150.00	
8	Repair vertical cracks	10	m	125.00	1,250.00	
9	Replace defective lintels; pcc lintels / oak face	4	nr	600.00	2,400.00	W1 - W4
10	Stainless steel fitch plate strengthening to door lintels	4	nr	300.00	1,200.00	D1 - D4
11	Rake out and repoint walls; lime mortar	176	m ²	80.00	14,080.00	
12	Fill hole with salvaged stone; 0.25m ²		item		300.00	S04
3.0	Windows and External Walls					
1	New window; 0.80 x 0.80m	5	nr	650.00	3,250.00	S01 / S03 /S13
2	New window; 1.10 x 1.10m	1	nr	1,000.00	1,000.00	S02
3	New window; 1.20 x 1.00m	1	nr	1,000.00	1,000.00	F01a
4	Make good existing double door		item		750.00	
5	Ledged and braced door and frame; single	6	nr	1,200.00	7,200.00	G01, 02, 05, 06b, S03, F03b
Carried Forward to Summary £					155,020.15	

Ref	4: Milling Machinery	Qty	Unit	Rate	Value	Comments
1	General clean and degrease of machinery		item		1,500.00	Note: All costs provided by Wallis Conservation Ltd
2	Valve and pipe		item		1,800.00	
3	Lauder and supports		item		5,500.00	
4	Waterwheel works		item		20,000.00	
5	Pit wheel and wallower works		item		15,000.00	
6	Hurst frame repairs		item		4,500.00	
7	Upright shaft and stone nut		item		3,500.00	
8	Millstones		item		18,000.00	
9	Millstone furniture		item		4,000.00	
10	Lay shaft and sack hoist		item		4,000.00	
11	Dresser works		item		2,500.00	
12	Ancillary items		item		2,000.00	
13	Fan and line shaft		item		1,500.00	
14	Training and manual		item		1,500.00	
15	Recirculating pump		item		6,000.00	
16	Direct electrical drive		item		15,000.00	
17	Contingencies		item		0.00	
Carried Forward to Summary £					106,300.00	

Ref	5: External Works	Qty	Unit	Rate	Value	Comments
1.0	Site clearance					
1	Clear vegetation from within 1m of building		item		500.00	
2	Clear builder's material adjacent to building		item		250.00	
3	Clear wheel pit of vegetation		item		250.00	
4	Palletize salvageable stones to perimeter of building		item		250.00	
5	Cut main stems to ivy		item		100.00	
2.0	Steps					
1	Clear rubble and carefully dismantle as necessary stone steps; re-construct		item		7,500.00	Leading to first floor.
2	Extra over; provide new stone to make up short fall		item		1,500.00	
3	Balustrading		item		2,000.00	
3.0	Surfacing					
1	Stone paving apron; on hardcore	300	m ²	150.00	45,000.00	South east & south west elevations
4.0	Mill Pond					
1	Clear vegetation / debris	44	m ²	40.00	1,760.00	
2	Rake out and repoint walls	50	m ²	75.00	3,750.00	
Carried Forward £					62,860.00	

Ref	5: External Works	Qty	Unit	Rate	Value	Comments
Brought Forward £					62,860.00	
4.0	Mill Pond (contd)					
3	Consolidate heads of walls	15	m	125.00	1,875.00	
4	Stitch repairs; 1.00m	3	nr	150.00	450.00	
5	Re-puddle pond		item		7,500.00	
6	Repair damaged buttress wall, using salvaged stone		item		1,000.00	
7	Replace 12" iron pipe in dam wall		item		500.00	
8	Gate valve	1	nr	850.00	850.00	
9	Timber sluice gate	1	nr	1,250.00	1,250.00	
5.0	Drainage					
1	French drain to perimeter of building	57	m	95.00	5,415.00	
2	Foul drainage installation from Staff Kitchen & WC		item		7,500.00	Connected to mains drain in car park
6.0	Mains services installation					
1	Water		item		1,500.00	
2	3-phase electrical supply		item		40,000.00	Provisional allowance
3	Erect weatherproof lean-to structure; slate roofing; timber clad walls with vented timber access		item		0.00	Erected by Client post completion
Carried Forward to Summary £					130,700.00	

The slating of

MELIN DARON ABERDARON



Slate & Stone Consultants
August 2020

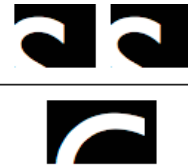

THE SLATING OF MELIN DARON

INSPECTION

The roof was inspected on the 12th August 2020 from the ground and at roof level on slopes 1- 5A, 8, 9A and 10 shown in Figure 1. Other areas were not accessible closely and area 7 was not inspected. The valleys at areas 4-5A and 8-10 were heavily covered in plants and deep compost. The former was cleared and inspected but it was not possible to clear the latter.

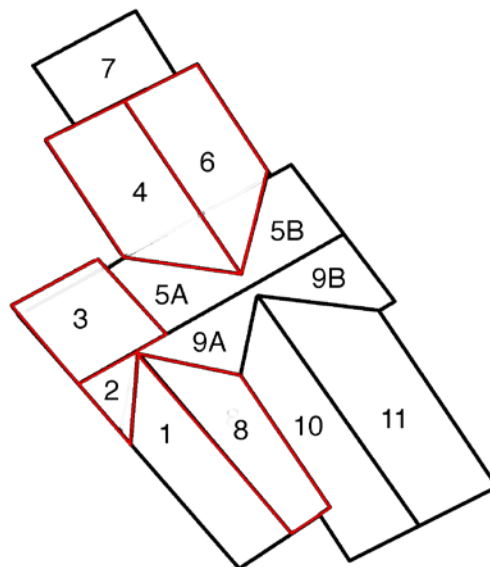

Figure 1. The roof was inspected at roof level at slopes 1- 5A, 8, 9A and 10. The areas in red are covered with random sized slates. The remainder are single sized.

THE SLATES

The roofs are formed with a variety of slates predominantly from the Cambrian age slate belt which extends from the Bethesda to Nantlle but also from the Ordovician slates produced from Blaenau Ffestiniog to Portmadoc and Cricieth. Some areas include slates from more than one geological source indicating repairs or possibly that they were reclaimed from more than one roof when installed.

There are two types of slates evident. On areas 2, 3, 4, 6 the slates are random sized, (Figs 2 and 3). On the remainder they are single sized (tally) slates¹ (Fig 4) except on 8 where they appear to be mixed random and tally. Random slates are the historically earlier form and are thicker than the tally slates. They would still have been available in the 20th century from smaller quarries.



Figure 2. Area 2. The earliest Ordovician age slating from the Blaenau Ffestiniog to Cricieth area. Small random sized slates and the Welsh valley showing the mortar in-fill which is partially removed in the lower section

¹ Single sized slates were called tally slates because they were sold by count in contrast to random slates sold by weight.



Figure 3. Area 3. Larger random slates from the Cambrian age, Bethesda to Nantlle slate belt.



Figure 4. Area 1. Talley slating and mortar bedding of the eaves slates.

The oldest slates are on area 2 and in the valley 1-2 (Fig 2). They are mainly 11 inches long by random widths². These are typical of slates found on old older roofs in the Llyn region which were often sold in a very limited range of lengths; perhaps two or three courses of 12 and/or 14 inches long and the remainder all one, smaller size. On the other random areas the slates are larger with lengths reducing from 20 and 22 inch down.

² The slate lengths given are the overall length. Where the slates are top hung the effective length is about one inch less.**

The tally slates are variously 20x10 (area 1), 20x12 (areas 10) and 22x12 (area 5) inches.

THE SLATING

There is variation in the slating which expresses the complex history of the roof. The table summarises the features of the various areas.

Area	Pitch°	Slate size	Laths	Courses	Fixing	Lap"	Mortar bed*
1	40	20 x 10	Riven	19	Top hung	1.5	Tail
2	32	Random	Riven	38	Top hung	Thirds**	Tail
3	32	Random	Sawn	29	Top hung	3	Tail
4	35	Random	Riven	26	Top hung	2	Tail
5	43	22 x 12	Sawn	18	Centre nail	2	No
6	35	-	-	27	Top hung	-	No
8	43	Mixed	Riven	20	Top hung	2	No
9	43	22 x 12	Sawn	14	Centre nail	3	No
10	40	20 x 12	Sawn	11 + 17	Top hung	-	No
11	40	20 x 12	Sawn	16	Top hung	-	No

* There are also mortar repairs on most areas. ** Slating in thirds is where the slate length is divided by three using a divider or copas to determine the lath gauge, margin and head lap which are all the same (see <https://vimeo.com/channels/1611662/441544639>).

The majority of the slates are peg hung on riven (areas 1, 2, 4 and 8 see figure 5) or sawn laths (areas 3, 5 and 9 s 3 and-11 see figure 6) but on areas 5 and 9 they are centre nailed to sawn laths. All the mill areas are torched although much of it has fallen off. Torching, besides draft-proofing the roofs would be important for a mill to prevent drips from condensation on the underside of the slates which could hamper the milling and cake the flour. Besides moisture generated by the corn drying, sea mists could also be a source of moisture and condensation.

Externally the slating has been tail bedded in mortar (Figs 3 and 4) in areas 1 - 4 and/or grouted as a repair (Fig 7).

VALLEYS

There are two valley types. The oldest between areas 1 and 2 is a Welsh valley (Fig 2). The remainder on areas 5 and 9 are metal lined (Fig 8) and appear to be associated with later extensions to the buildings or reslating episodes.



Figure 5. Area 3 Top hung slating on riven laths and torching.



Figure 6. Area 5 Centre-nailed slating on sawn laths and torching. The slate nails are visible in the laths



Figure 7. Area 4. Mortar grouting applied to secure failing slating.



Figure 8. The (split) metal lined valley between areas 4 and 5.

In essence, a Welsh valley is three slate roofs: one forming the lining, approximately 8 inches wide, and overlain by the areas on either side by about 7 inches (Fig 9). The valley slating carries the most rainwater so the slates are longer than the overlying areas giving a larger head lap to prevent leaks. The overlying slates have been bedded onto the valley. The whole valley has been mortar filled presumably to try to deal with a leak.

The Welsh valley is historically important. It is a type unique to Wales and known over most of country and the Marches. It was probably the most frequent type before the availability of lead which has now replaced it on many roofs in spite of the conservation protection accorded it. This process continues.



Figure 9. The Welsh valley showing the slating from areas 1 and 2 overlying the valley slates.

PERIMETERS

The eaves slates are bedded onto the wall head and the first course bedded on to the under-eave slates (Fig 4). There is generally an eaves overhang of 2 to 3 inches. At the eave of the Welsh valley there appears to have been little overhang and consequently the masonry mortar below has been washed out (Fig 10). All the ridges are closed with plain clay tiles coloured either blue-brindle or red (Figs 3 and 11). The half bond to the slating at the verges is closed with alternate narrow and wide slates. The tally slate verges are closed with various width rather than exactly half slates or slate-and-a-half width slates (Fig 12).



Figure 10, The eave of the Welsh valley appears to have had little overhang. Consequently, the masonry mortar below has been washed out.



Figure 11. Area 5. Blue brindle and red plain ridge tiles.



Figure 12. The half bond at the tally slate verges has been closed with various width rather than exactly half slates or slate-and-a-half width slates

EVOLUTION OF THE ROOF

The Govannon archaeological report³ indicates that the north-west / south-east range (areas 2, 3, 5, and 9) were in existence in 1841 but that two north-east / south west ranges (areas 1, 8, 10 and 11) are later and existed by 1889 as shown on the OS 25 inch map of that date.

Clearly the oldest part of the building's roof is area 1 and the Welsh valley would have been inserted when the areas 1 and 8 were added (or another roof in the same position). This implies that previously the whole of areas 1 and 9 would have been continuous and would all have been slated in the small random slate still present on area 2. The further reasonable assumption would be that areas 3 and 5 would be similarly slated. When the present area 1 was added the inclusion of a Welsh valley rather than the metal lined valleys to area 9 suggests at least the area 1 was also at that time slated with the same small random slates as area 2. That also implies that area 8 have been similarly slated.

Since the initial construction of the areas 1 and 8 (and making no comment on areas 10 and 11) it appears the currently tally slated areas have been slated (or reslated) in the way that is familiar since at least the 19th century by changing to tally slating. Initially this appears to have been by top hanging on riven laths (areas 1, 10 and 11) and subsequently centre nailed to sawn laths (areas 5 and 9).

I suggest these factors should be considered when deciding how to repair the roofs.

T G Hughes BSC (Hons) FloR Dp Man

24 August 2020



³ Govannon Report GC378a, 2015 Melin Aberdaron Archaeological Assessment

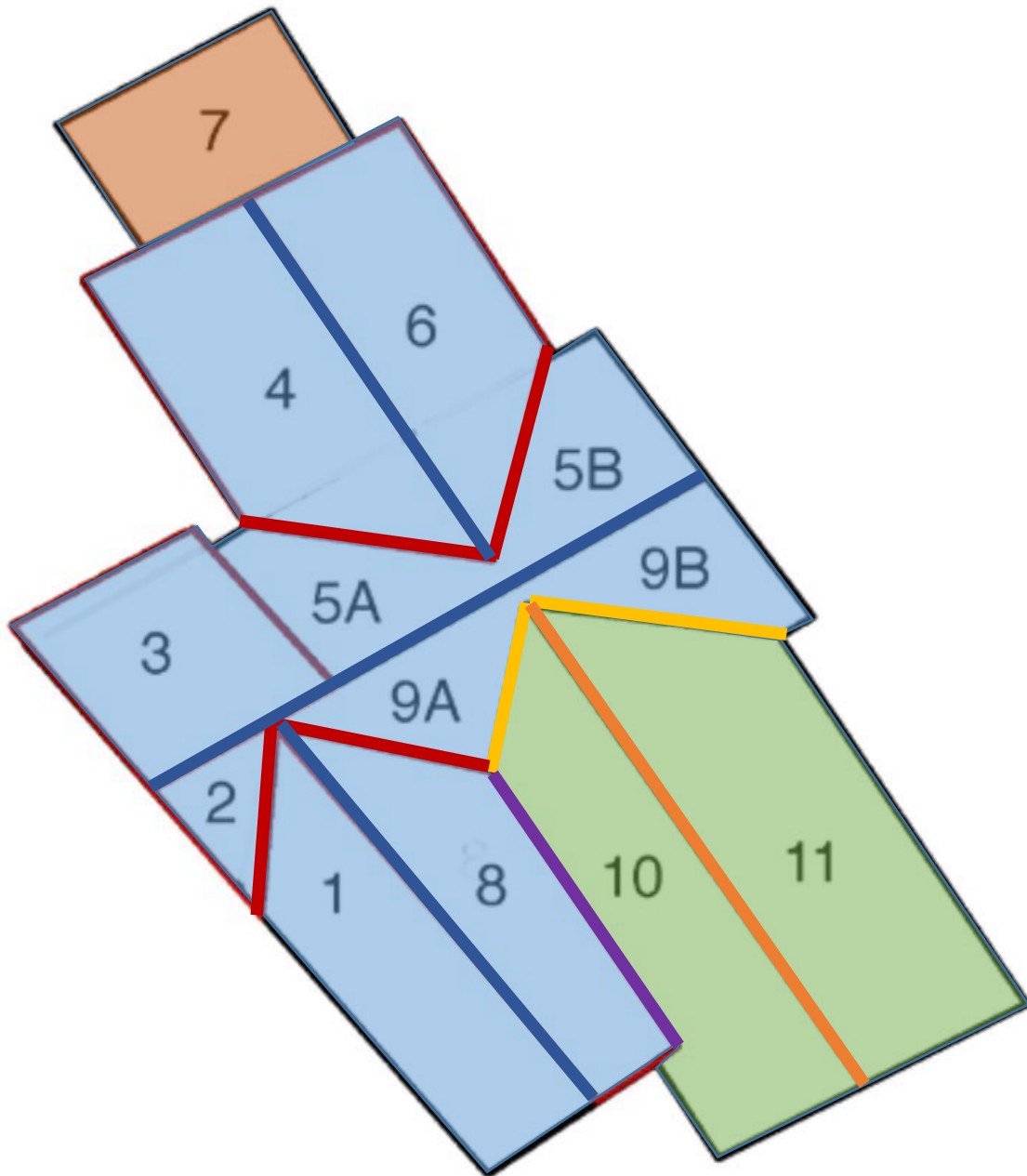

-  Corrugated Iron lean-to roof with hot mix lime abutment detail.

 Random sized, diminished coursed roofs with hot-mix lime torching on riven laths

 Tally slate centre nailed to sawn laths with hot-mix lime torching

Dripping eaves (75-100mm), so no rainwater goods provided to eaves.

Allowance for French drain to perimeter of building.

 Welsh Valley

 Lead Lined Valley

 Lead lined tapered gutter

 Red Clay ridge tiles

 Blue-brindle Clay ridge tiles

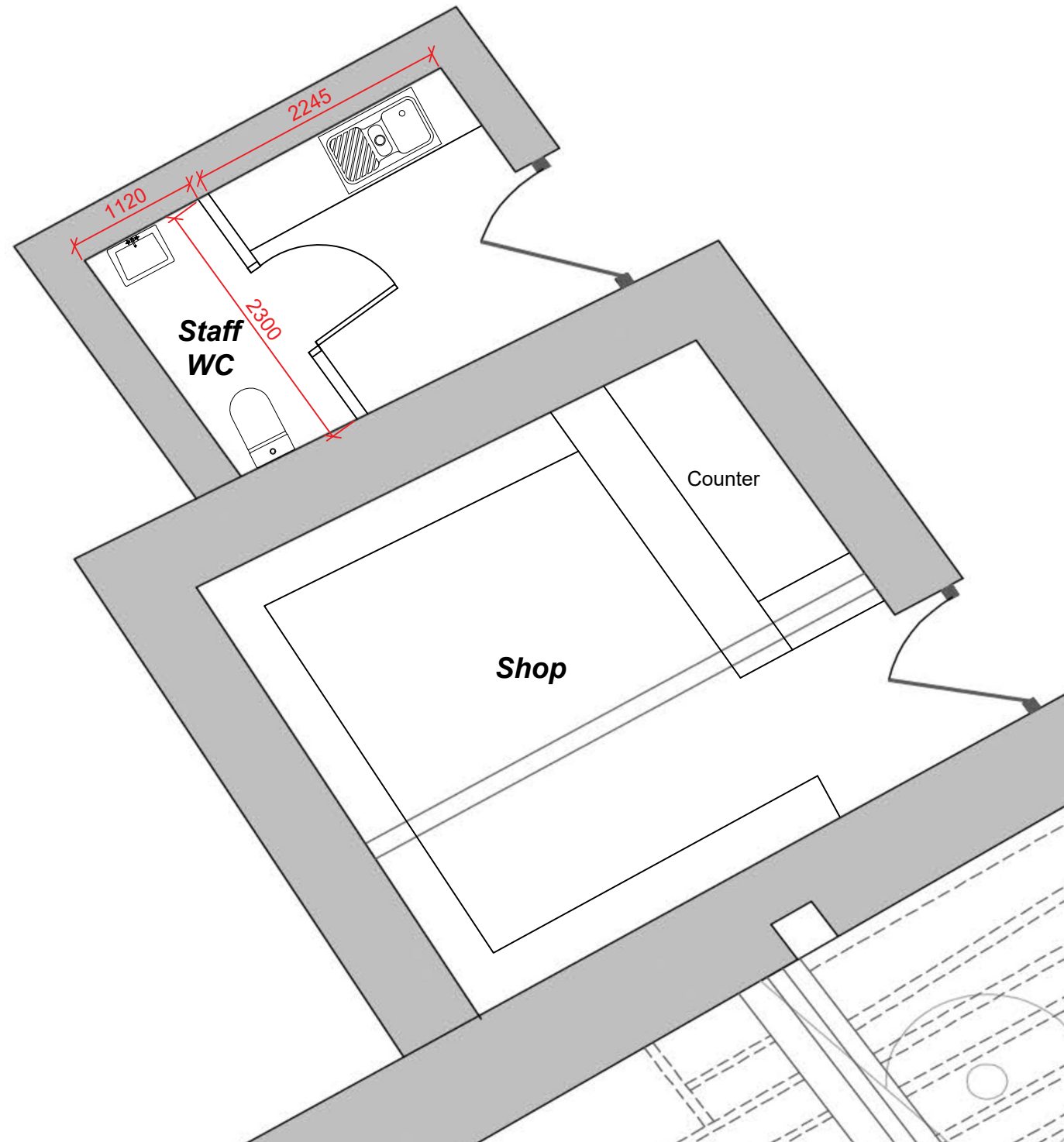

Option 1
As Proposed
 Scale 1:50 @ A3

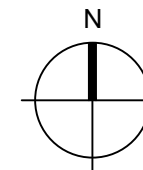
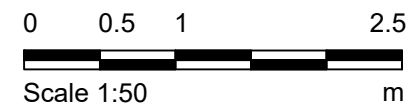

Notes

- Any dwg format drawing is to be read in conjunction with and at the scale of the accompanying pdf.
- Where colours other than black or grey are used, the drawing must be plotted in colour.
- For status 'C' (Construction) drawings all dimensions are to be checked on site by the contractor, scaling is for Local Authority purposes only.
- Unless otherwise indicated, all dimensions are in millimeters.
- All information on this drawing is to be read in conjunction with the relevant Donald Insall Associates specification and trade contractors' drawings and information by specialists.
- In the event of any discrepancy, please contact us immediately.
- This drawing may contain survey information by others and is to be used solely for the purposes for which it was issued.
- These are uncontrolled documents issued for information purposes only. If you have any queries regarding the drawings, please contact DIA immediately.
- Please note DIA cannot be held responsible for any errors arising from changes made to an uncontrolled dwg file.

© 2019 DONALD INSALL ASSOCIATES LTD

Drawing Status					Revision				
F	Feasibility				0	24-08-2020	GRR	MTO	Initial issue.
S	Sketch Design								
P	Planning								
B	Building Control								
D	Design Development								
M	Measurement								
T	Tender								
C	Construction								
R	Record								

Donald Insall Associates
 Chartered Architects and Historic Building Consultants

Y Becws, Pool Lane
 Conwy LL32 8PZ
 (+44) 01492 592 378
 conwy@insall-architects.co.uk

Melin Daron, Aberdaron

Project	MDCF.01	No	-
Scale (A3)	1:50	Status	1F
		Revision	0

WC & Brewup
Options 1 & 2

CHRIS PIKE ASSOCIATES

HISTORIC ENVIRONMENT ENGINEERS

www.cpaconservation.co.uk



Property Address:
Melin Daron, Aberdaron, Pwllheli. LL53 8BP

Title:
Structural Condition Report

Prepared for:
Donald Insall Associates

Date: September 2020

Job No: 1192.101

Issue: 1.0

CHRIS PIKE ASSOCIATES

HISTORIC ENVIRONMENT ENGINEERS

www.cpaconservation.co.uk

Contents

01	Introduction	Page 1
02	Background & Description	Page 2
03	Observations	Page 3
04	Conclusions & Recommendations	Page 5

Appendices

- Appendix A – G A Plans & Survey Annotation
- Appendix B - Structural Condition Record Sheets
- Appendix C - Photograph Keyplan and Photographs
- Appendix D - Outline Scheme for Structure Repairs



.....
Eur Ing **CHRISTOPHER I PIKE** MA BSc(Hons) CEng MStructE
CHARTERED STRUCTURAL ENGINEER
CONSERVATION ACCREDITED ENGINEER

Revision	Amendments	Prepared By	Date

STRUCTURAL CONDITION REPORT ON MELIN DARON

1. INTRODUCTION

- 1.1 Chris Pike Associates are instructed by Lead Architect and Project Managers, Donald Insall Associates, to carry out a close structural inspection of the semi derelict vernacular Mill – Melin Daron, with the purpose of identifying elements / areas in need of sympathetic repair, further special investigation or strengthening.
- 1.2 This structural condition report highlights existing structural defects and weaknesses that in our opinion may have a material effect on the future stability of the building, and makes summary note of the general condition of the external historic fabric and other salient features found at the time of inspection.
- 1.3 This report should be read in conjunction with the building survey drawing and proposals for the building repair and general refurbishment to make the flour mill productive and operational again.
- 1.4 This report gives recommendations for temporary urgent work to support and protect the main loadbearing elements, where there is a need to make safe or maintain the general weather-tightness and security of a building.
- 1.5 The findings and recommendations of the detailed structural appraisal report may influence the economic choices for alternative future end use.
- 1.6 The significance of the noted defects and opinions thereon are based solely on the findings of a single visual inspection from ground level and is accordingly limited in scope. The inspection has not included any part of the structure that was covered, unexposed or not accessible at the time of our visit, and so we cannot confirm or verify that any such parts are free from defect and have not suffered from significant deterioration.
- 1.7 The external drainage system has not been inspected. General comment is made on such installations only if it is clear and apparent that they are in a dangerous or suspect condition.
- 1.8 No separate environmental / geotechnical study of ground conditions has been undertaken, and therefore no qualified judgement can be made on the possibility or likelihood of soil contaminants present within the site.
- 1.9 The report should not be considered as a schedule of dilapidations or used for valuation purposes.
- 1.10 This report is for the sole use of the named Client, and is limited to the commission and agreed brief.

STRUCTURAL CONDITION REPORT ON MELIN DARON

2. BACKGROUND & GENERAL DESCRIPTION

- 2.1 The detached vernacular Grade II listed industrial old watermill complex is built on level ground but set on a sloping site close to the centre of the small seaside village of Aberdaron at the western end of the Llyn peninsula.
- 2.2 A detailed description of the property and history is provided in the EAS Archaeological Survey report (EAS Reference 2015/13)
- 2.3 The front (low end) of the building faces approximately SW towards the village centre. The rear part sits behind a high retaining wall structure that separates the building from the surrounding hillside and road.
- 2.4 The existing building floor layout is shown planning drawings prepared by Donald Insall Associates.
- 2.5 The existing rectangular shaped building has two distinct parts. The oldest working milling part (areas B1- B5 are arranged on an L footprint) houses the machinery beneath the upper stone grinding floor level in the central part with the flour (Dresser) despatch area set towards the front end and the raw grain imported at the back RH area by the large cart access door.
- 2.6 The oldest part of the building possibly dates back to the early 18th century, although the Dresser wing is likely to be a slightly later addition, and is constructed in substantial 710mm thick random rubble walling in angular grey slate stone and with a trussed Oak roof frame slate covered.
- 2.7 There are three attached outbuildings that appear to be later additions and served different purposes. The largest outbuilding infilling the SW corner side is the 'Corn Dryer' originally having a brick oven. This is thought to date from the period 1812 – 1840. This building is constructed with rounded mixed coloured boulders and marine gravel solid stone walls set under a double pitched timber purlin and truss roof.
- 2.8 Attached to the back RH part are two smaller single storey outbuildings, comprising a stable with a cobble / pebble floor and a small storeroom beyond. Both these buildings are constructed in a grey angular rubble slate (non-coursed) under a timber purlin and rafter roof frame.
- 2.9 The external water wheel is no longer in place and the wheelpit at the time of our visit was overgrown. The internal cog cast iron machinery and grinding gritstone bins remain in place and possibly date from the latter half of the 19th century.
- 2.10 It is thought Mill remained in use until the middle of the 20th century but has since that time been abandoned and has fallen into disrepair due to neglect.
- 2.11 There are no large trees set near the building. Although several parts in recent years have been enveloped by Ivy and other climbing plants that have infiltrated the roof.

**STRUCTURAL CONDITION REPORT ON
MELIN DARON**

3. OBSERVATIONS

- 3.1 The survey and inspection of the existing structural frame and external fabric condition was carried out on Friday 7th August.
- 3.2 The weather was warm with sunny periods.
- 3.3 External inspection of the outer roof slopes and upper wall elevations was carried out from ground level by optical sighting means using a camera zoom lens where appropriate.
- 3.4 Internal inspection of the open roof frame and upper wall sections was carried out from floor level by visual sighting using a camera zoom lens as best appropriate.
- 3.5 The general plan layout of walls, trusses and beam positions are shown illustratively on the sketch plan in Appendix A.
- 3.6 The main points of observation and notes are provided on the annotated plans in Appendix A and on the Condition Record Sheets in Appendix B referenced to the example photographs in Appendix C.
- 3.7 The condition record sheets describe in simplified terms the significant defects and likely cause, also noting where material has naturally degraded or become damaged and weakened through instability and natural decay processes or by creep, wear and tear, impact and vibrations, etc.
- 3.8 Reference photographs are provided in Appendix C together with Key plans showing the location.
- 3.9 It was not possible to gain access into the Corn Dryer (Area A), Stables and separate Store (Area C) due to sealed and well secured doors. These areas were subsequently accessed by the Architect and an overview assessment of condition in the internal space has been made from available photographs taken on the 12th August 2020.
- 3.10 As far as can be seen the property has no drainage or mains water supply.
- 3.11 The external ground is built up on several sides with waste material. This has breached higher than the inner floor level in several locations and was in the process of being removed on the day of our visit.
- 3.12 No close inspection of the rear lower back wall and outside Wheelpit was attempted on the day due to dense encroaching vegetation that first needs to be cleared.

STRUCTURAL CONDITION REPORT ON MELIN DARON

3.13 The classification of structural defects to masonry walls is as follows:

CATEGORY OF DAMAGE	APPROXIMATE CRACK WIDTH (mm)	CONSEQUENCE OR ACTION IN BUILDINGS	APPROXIMATE LEAN / OUT OF PLUMB / BULGES/ BOWING	CONSEQUENCE OR ACTION IN FREE STANDING STRUCTURES
0 Negligible	Hairline up to 0.1mm	Not structurally significant		
1 Fine / Superficial	Isolated or combined up to 1.0mm	Superficial – General serviceability and fabric issues only	Some weathering back of mortar pointing up to 20mm depth.	Micro vegetation such as moss and lichen may remain except for Ivy.
2a Slight	Isolated or combined between 1.0mm and 3.0mm	Aesthetic disturbance of fabric and finishes. Some general loss of weather-tightness possible. Local infilling or repointing repairs may be required.	Local loss, erosion or spalling of small number of face units only	Local repointing only required if mortar loss exceeds 20mm depth or joint width (height) whichever is greater
2b Minor	Isolated or combined between 3.0mm and 5.0mm	Can be structurally significant with implications for the general stability structural integrity and serviceability. Minor repairs possibly required, possibly involving some breaking out and/or local rebuilding	Lean / deflection of up to 1/150 height and centre of gravity within middle third of base width. Single loss and gaps in large masonry units up to 300mm length.	Minor local repairs required, possibly involving some breaking out and/or local rebuilding. Remove invasive vegetation, saplings, etc. Repoint in higher strength mortar on both faces. Sacrificial protection coat may be temporary solution
3 Moderate	Isolated crack between 5.0mm and 15.0mm or combination of several cracks over 3.0mm in width	Structurally significant. Probably requiring some breaking out, stitching and/or local rebuilding.	Leans / deflection of more than 1/100 height. Bulges up to 50% of base wall thickness	Structurally significant probably requiring some local strengthening. May also require some breaking out, stitching and/or local rebuilding.
4 Major	Isolated crack between 15.0mm and 25.0mm or combination of several cracks over 5.0mm in width	Partial demolition and rebuild of unstable sections. Replacement of the defective and failed elements / structural frame.	Leans/ deflections greater than 1/ 75. Bulges up to 70% of wall thickness. Centre of gravity still within middle half of base width.	Some reinforcement stitching, or tie restraint required. Additional buttressing restraint likely. Possible underpinning.
5 Severe	Isolated crack over 25.0mm in width or combination of several cracks each over 10.0mm in width	Urgent propping, shoring or demolition likely to be required to make safe the structure, prior to partial or complete rebuilding	Leans / deflections greater than 1/ 50. Bulges up to 85% of base wall thickness. Some oscillation under lateral loads.	Urgent propping, shoring or demolition likely to be required to safeguard the structure, prior to partial demolition and before major rebuilding.

STRUCTURAL CONDITION REPORT ON MELIN DARON

4.0 CONCLUSIONS & RECOMMENDATIONS

- 4.1 The recommended urgent and non-urgent work affecting the superstructure is provided in outline on the Condition Record Sheets in Appendix B and shown in schematic form and description in summary outline in Appendix D.

The Major defect items are considered most urgent and of higher priority. These should ideally be addressed within the next 6 to 12 months.

The Moderate defect items for repair are not considered as urgent but are likely to deteriorate and worsen Progressively. Ideally, these items should be addressed within 18 to 24 months timescale.

The Minor defect items are considered of low priority and can be left for up to 3 years without any significant additional issues arising.

- 4.2 In the immediate short term all holes in the roofing and slate need to be covered by temporary boarding or tarpaulin sheet to stop further rain ingress.
The central valley gutter also needs to be sheeted to allow rainwater to be discharged away from the building on the front low side.

Finally the inner Purlin P9 in the Corn Dryer area A2b should be supported by temporary Acrow propping as it is at risk of falling.

All first floor areas have extensive rotten floor boarding and should not be accessed for the time being.

- 4.3 There is evidence of some localised differential movement causing cracks to develop through solid rubble wall panels. The most significant of these are
- i) Middle of the NW wall on the wheel pit side
 - ii) On the NE wall (Area B3 and adjacent area B2)

- 4.4 There are local bulges leading to partial collapse of short sections of wall. This may have been caused by shock and vibrations, or by water penetration causing looser smaller material to gravitate down the core of the solid rubble walls. The most significant areas are
- i) NE corner of Area A2 (Corn Dryer Oven) which has resulted in partial collapse and failure of Purlin P8
 - ii) Inner face of NE wall area B3 (possibly caused by root undermining)
 - iii) Dividing wall between Areas A2 & B4 beneath defective valley gutter.
 - iv) Panel across Doorway D1 on SE wall to area B1

- 4.5 There is evidence of significant weathering and open joints between many exposed masonry rubble pieces on many external walls.

- 4.6 The condition of the lower walls and foundation to the Corn Dryer old oven part is uncertain but is suspect due to the extensive damage in this part. Several of the substructure walls splay out at the base which reflect a loss of mortar binder in the core. Such conditions can arise in locations where the mortar and masonry units suffer heat damage and thermal expansion.

STRUCTURAL CONDITION REPORT ON MELIN DARON

- 4.7 The condition of the loadbearing walls around the old corn oven should be further exposed and investigated to determine whether the integrity of the structure has been unduly compromised.
- 4.8 If the Corn Dryer oven is not to be reconstructed and used as a representation of the original industrial heritage way of working, then consideration will need to be given as to a new practical use of this space. As a minimum it will be necessary to infill and consolidate any ground that lies below external ground level. An engineered well compacted inert granular fill material could be used for this purpose.
- 4.9 There is observed small racking across Bays B1 to B3. This slight sway and lean movement across the open roof frame structure appears historic and may reflect a deficiency in the longitudinal tie and restraint.
- 4.10 In general, the principal roof frame elements, trusses, purlins and common rafters appear in satisfactory condition although some minor localised damage and decay has resulted from water ingress where holes have appeared in the roof from storm damage.
- 4.11 There is evidence of minor sag deflection across roofs and along the ridge line. This is not too alarming and possibly a reflection of some progressive roof spread over many years. Such conditions can be best stabilised by enhancing the fixings between rafters at the ridge board. Purlin stays at the truss supports may also be provided to stop any rotation.
- 4.12 The pitched roof slate covering, and battening does require a complete overhaul and refurbishment due to the slate breakage, slippage, and loss. This will undoubtedly involve stripping off and replacement of the battening and may involve the piecemeal renewal of sections of the wall plates and rafters where loss of section due to historic decay exceeds 25%. A new fully breathable underlay membrane should be specified when the battens and through nails need wholesale replacement rather than reliance on lime mortar torching.
- 4.13 The stiffness and robustness of the cut-roof can be enhanced through regular strapping across and steadfastly bolt fixing through each common rafter to purlins set on slope. A collar tie joisted ceiling can be introduced above upper purlin level to stiffen the frame.
- 4.14 In summary, the aged roof frame may be conserved and upgraded by adopting the following strategy:
- i) Introduction of a raised collar tie between opposing rafters placed beneath the ridgeline or at the purlin level.
 - ii) Repair of wallplate / rafter heel or tail fixings as necessary with the addition of holding down and restraint strapping at eaves
 - iii) Repair/ replace common rafters suffering from significant loss of section (where >25%) due to rot and deterioration, including tail sections where fixing to the wallplate has been compromised and around the inserted rooflight where water ingress has occurred.
 - iv) Fresh re-pegging of all traditional mortise and tenon joints on original trusses where these have degraded and become loose or to provide a face splice across purlin scarf joints that have rotated.

STRUCTURAL CONDITION REPORT ON MELIN DARON

- v) Recover and re use quality slate tiles for refurbishment of the roof, allowing for new counter battening, a new breathable membrane and open cell insulation where considered necessary.
- 4.15 The preliminary recommendations for structural repairs and for the redevelopment are provided in outline form in Appendix D. Before the recommendations and scheme of necessary work can be developed and finalised it is necessary to carry out further targeted investigations to show the actual condition of other suspect areas. The investigation items / areas are listed on the condition record sheets, but are summarised below as follows:
- i) Check the soundness and condition of all truss end bearings set into walls.
 - ii) Check the condition of first floor joist ends embedded into walls to be retained.
 - iii) Check the condition of all first floor timber beam ends embedded into walls to be retained
 - iv) Check the condition of all lower rubble walling and floor currently hidden by vegetation and waste debris mounds where indicated on the drawing. (Areas B3 , C2 and Corn Oven)
 - v) Check the condition of the wheel pit and boundary retaining wall where currently hidden by vegetation and waste debris mounds.
 - vi) Check on the source of the water penetration through walls on the North and East side
- 4.16 The following checks and enhancements to be incorporated into a comprehensive refurbishment scheme, general plans, or maintenance schedules:
- i) Addition of below ground storm and foul drainage systems to service the building.
 - ii) Raking out and repointing the external face masonry using a suitable soft lime mortar
 - iii) Local rebuilding of sections of the masonry across window and door openings where these have been disturbed by repair or replacement of defective timber lintels
 - iv) Repair and strapping down of the eaves wallplate where this has moved outwards due to lateral thrust and creep from the pitched roof.
- 4.17 The detached small store building (Area C3) is in a poor state of repair internally and at the rear. It is recommended that this part is taken down and rebuild from a new or improved spread foundation.
- 4.18 Ideally, all building repairs, reconditioning and fitting out should be carried out in accordance with a pre-prepared detailed specification to ensure that all work is appropriate and compatible with the existing historic features, material, and fabric.

**STRUCTURAL CONDITION REPORT ON
MELIN DARON**

Appendix A

General Arrangement Plans
with Annotated Survey Notes

STRUCTURAL CONDITION REPORT ON
MELIN DARON

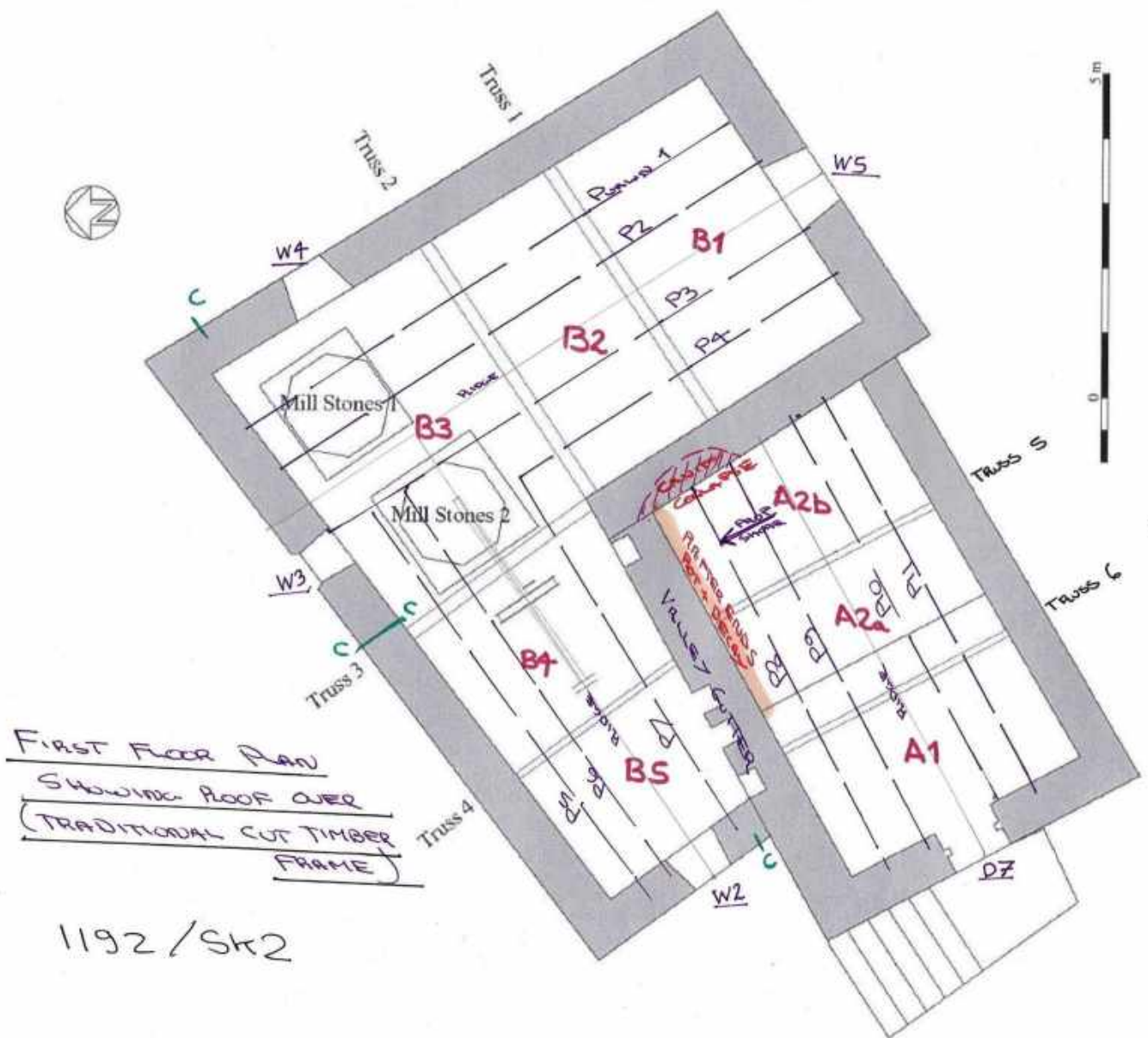

**STRUCTURAL CONDITION REPORT ON
MELIN DARON**

Appendix B

Structure Condition Record Sheets

Site Address: Melin Daron, Aberdaron, Pwllheli. LL53 8BP			Date of Inspection:	07/08/2020		
			Job Ref:	1192		
STRUCTURE CONDITION RECORD - EXTERNAL			Engineer / Surveyor Initials: CP			
DEFECTS & OBSERVATIONS			Sheet 1 of 3			
<u>PHOTO No.</u>	<u>PART / AREA</u>	<u>ELEMENT DESCRIPTION</u>	<u>DEFECT</u>	<u>SEVERITY</u>	<u>LIKELY CAUSE</u>	<u>RECOMMENDATION</u>
1	B3 NW Corner	External Rubble Wall	Stepped Vertical Crack	Major	Subsidence - Differential movement	Scour or undermining of corner to be investigated / exposed by trial hole
2	North side Wheel Pit	Road Retaining Wall	Corroded & Buckled Metal Stays (Missing wheel axle)	Major	Historic damage to Wheel	Condition of wall to be investigated and exposed by removing vegetation
3	B3 NW Roof	Slate covering	Broken, missing and displaced original Slates	Moderate	Weather / Neglect	Refurbishment of roof and fabric
4	B2 NW Roof	Slate covering	Broken, missing and displaced replacement thin Slates	Major	Weather / Neglect	Refurbishment of roof and fabric
5	B3 North	Rubble Wall	Old Crack repair and sockets with loose masonry	Moderate	Uncertain. Loss of wheel shoot?	Expose and local patch repair
6	B3 North	Rubble Gable Wall	Old crack repairs	Minor	Historic event	Monitor weak masonry bonds
7	B3 North	Rubble Gable Wall	Old crack repairs	Minor	Historic event	Monitor weak masonry bonds
8	B3 North	Rubble Gable Wall	Stepped Diagonal Crack. Tapers to base	Major	Subsidence - Differential movement	Scour or undermining of corner to be investigated / exposed by trial hole
9	B3 North	Rubble Gable Wall	Stepped Diagonal Crack. Widens at top	Severe	Subsidence - Differential movement	Scour or undermining of corner to be investigated. Crack Stitch Repair
10	B3 / B4 North	External Rubble Wall	Stepped Diagonal Crack. Loose Masonry	Severe	Differential Movement. Water Penetration	Local repair. Provide Gutter / or overshoot for rain discharge from valley.
11	B5 NE Corner Roof	Slate covering	Broken, missing and displaced original Slates	Minor	Storm Weather / Neglect	Refurbishment of roof and fabric
12	A1 NE Corner	External Rubble Wall	Rounded boulders loss of mortar	Moderate	Weather / Neglect	Repointing required + local repair
13	A1 NE Corner	External Wall - Large Quoins	Loose mound - old access steps collapsed	Major	Uncertain.	Repointing required + local repair
14	B1 SE Gable	External Rubble Wall	Bow and Bulge across Garage door. Upper gable leans in	Moderate	Sway across roof frame.	Provide Lateral Restraint Straps at first floor and roof level
15	A1. SE Wall	External Rubble Wall	Rounded boulders loss of mortar	Moderate	Weathering / Neglect	Repointing required + local repair
16	A1 South Corner. Door D4	External Wall - Large Quoins. Timber Lintel	Desiccated and rot to lintel. Loss of Bearing	Major	Decay. Weathering	Replace with concrete or natural stone equivalent
17	A2 SE Wall	External Rubble Wall	Rounded boulders loss of mortar	Moderate	Weather / Neglect	Repointing required + local repair
18	B1 SW Corner	External Rubble Wall	Loose masonry at valley and eaves	Minor	Weathering / Water Penetration	Local pack repair and repointing
19	B1 South Gable	External Rubble Wall. Timber Lintel	Loose Masonry. Loss of bearing to lintel on Door D1	Moderate	Weathering/Decay	Local Repair. Repoint and replace outer door lintel.
20	B1 South Gable	External Rubble Wall. Timber Lintel	Loose Masonry. Loss of bearing to lintel on Door D1	Moderate	Weathering/Decay	Local Repair. Repoint and replace outer door lintel.
21	B1 SE Corner Roof	Slate Covering	Broken missing and displaced replacement thin Slates	Minor	Weather / Neglect	Refurbishment of roof and fabric
22	C1/ C2 SE Roof	Slate Covering	Broken, displaced original Slates	Moderate	Weather / Neglect.	Refurbishment of roof and fabric
23	B1 South Gable Window W5	External rubble wall. Timber Lintel	Loose open masonry. Desiccated timbers	Moderate	Weather / Neglect	Local Repair. Repoint and replace lintels with concrete equivalent.
24	B1 South Gable. Door D1	Timber Lintel	Loose Masonry. Loss of bearing to lintel on Door D1	Moderate	Weathering / Decay	Local Repair. Repoint and replace lintel with concrete equivalent

Site Address: Melin Daron, Aberdaron, Pwllheli. LL53 8BP				Date of Inspection: 7/8/2020 + (Areas A & C Photographs taken 12/8/20)		
STRUCTURE CONDITION RECORD - INTERNAL				Job Ref: 1192		
DEFECTS & OBSERVATIONS				Engineer / Surveyor Initials: CP (No Access into Areas A & C)		
				Sheet 2 of 3		
PHOTO No.	PART / ELEMENT	DESCRIPTION	DEFECT	SEVERITY	LIKELY CAUSE	RECOMMENDATION
25	B2. NE Side	First Floor Joist	Timber rot and decay	Major	Water Ingress	Replace Joist
26	B4	Purlins P3 carrying Purlins P6 & P7	Invasive Vegetation thro Roof	Minor	Roof Fabric compromised	Refurbishment of roof fabric including battens and slates
27	B3 NE wall	Truss 2 Bearing.	Previous shoe bearer repair	Minor	Historic Rot / water Penetration	Pack with lime mortar
28	B4 South Inner Wall	Trusses 2 & 3 Bearing	Embedded end suspect under Valley	Unknown	Water Penetration	Investigate and repair
29	B4/ B5 NW Side	First Floor Joist and Board	Boards rotten. Suspect joist ends	Unknown	Water Penetration	Investigate and repair
30	B4	Truss 4 Bearings	Embedded ends	Unknown	Water Penetration	Investigate and repair as necessary
31	B3 NW Gable wall	Purlins P1 and P2	Embedded ends suspect Invasive Vegetation	Unknown	Roof Fabric compromised	Refurbishment of roof fabric
32	B3	Truss 3 Collar	Water marks	Minor	Penetration through roof	Refurbishment of roof fabric
33	B2 SW side	First Floor Joists	Timber rot and decay	Moderate	Water Ingress	Replace Joists
34	B3	Truss 2 Apex Joist & Ridge Rafter Joist	Timber rot and decay	Minor	Roof fabric compromised	Refurbishment of roof fabric
35	B2	Purlins P1 & P2 at Truss 1	Water Marks	Minor	Penetration through roof	Refurbishment of roof fabric
36	B2	Purlins P3 & P4 at Truss 1	Water Marks. Joint Pegs decayed	Moderate	Penetration through roof	Refurbishment of roof fabric. Re-peg compromised frame joints
37	B2	First Floor Joists	Overlay floor has been removed	N/A	Past Alteration	Do Nothing
38	B3 and Window Hatch W3	Rubble Wall below Truss 3 Bearing	Structural Crack	Major	Differential movement	Local crack stitch repair
39	B3 Window W4 NE side	Timber Lintel	Rot and decay	Moderate	Historic Rot / water Penetration	Replace with concrete or stone equivalent
40	B3	Timber First Floor + Hardwood Deck for stone bins	Floorboards rotten	Moderate	Decay and rot	Replace all boards and defective joists.
41	B3 NE side	Beam FB3 bearing	Embedded end	Unknown	Potential rot	Investigate and repair as necessary
42	B3	Grinding Floor Frame Post PT4	Decay and rot at base	Major	Unknown. May have been cut	Investigate and repair splice in.
43	B3 NE corner	Grinding Floor Frame	Original support post removed	N/A	Unknown past alteration.	Investigate support to embedded beam
44	B3	Grinding Floor Frame Post PT5 Base	Temporary pin up with equivalent timber	Major	Unknown. Floor may have dropped	Investigate and provide permanent repair - piece in
45	B3	Axel Cog Drive wheel	Corrosion and rust	Moderate	Neglect. Poor maintenance	Remove, clean and oil.
46	B3	Grinding Floor Frame Post PT5. Top cleat	Corrosion and rust	Minor	Neglect. Poor maintenance	Renew in Stainless steel with coach bolts
47	B5 Door D2	Outer lintel	Timber rot and decay	Minor	Historic Rot / water Penetration	Replace with concrete or stone equivalent
48	B4 Door D3	Outer lintel + First Floor Joist	Timber rot and decay	Major	Historic Rot and Decay	Replace with concrete or stone equivalent
49	B5 Window W1	Outer Lintel	Timber rot and decay	Moderate	Historic Rot and Decay	Replace with concrete or stone equivalent
50	B5 South Side	Bearing for FB5	Reduced Bearing	Moderate	Bowing / Bulging wall - Subsidence	Investigate - Possible Underpin to strengthen
51	B4 South Side	Inner rubble wall to Corn Dryer	Salt efflorescence residue	Minor	Water Ingress saturation of masonry	Local repair. Clean and apply lime repointing
52	B4 South Side	Inner rubble wall to Corn Dryer	Splay bow at base	Moderate	Differential movement / Subsidence	Investigate - Possible Underpin to strengthen wall
53	B2 SW side	First Floor Joists	Timber rot and decay	Moderate	Water Ingress	Replace Joists
54	B2 NE Side	First Floor Joists	Timber rot and decay	Major	Water Ingress	Replace Joists
55	B2 SW side	Inner dividing wall to Corn Dryer	Splay Bow deflection + Crack	Moderate	Unknown. Possible Subsidence	Investigate. Possible underpin or rebuild.
56	B1 NE side	First Floor Joists and FB1 / FB2	Several Joists replaced in past	Minor	Unknown past damage.	Replace defective side joists and over floorboards
57	B2 NE side	Rubble wall below FB3	Local Bulge at base	Moderate	Undermine by root ball mass	Remove root mass. Underpin and local repair
58	B2 SW side	First Floor Joists and FB1 / FB2	Several Joists replaced in past	Minor	Unknown past damage.	Replace defective side joists and over floorboards
59	B2 SW side	Inner dividing wall to Corn Dryer	Splay Bow deflection + Crack	Moderate	Unknown. Possible Subsidence	Investigate. Possible underpin or rebuild.
60	B1 SW Side	External rubble wall	Damp Ingress	Minor	Overspill valley gutter	Provide rainwater goods at roof level and storm drains
61	B1 SW side	First Floor Joists and FB1 / FB2	Several Joists replaced in past	Minor	Unknown past damage.	Replace defective side joists and over floorboards
62	B1 SE side	Garage Door D1 Curved timber lintel	Damp mould in corner . Reduced bearing	Minor	Water Ingress	Treat rot and provide bearing shoe bracket on inner Lintel.
63	A2b NE Corner	Rubble wall upper section. Temp timber shore to P8	Local collapse of inner skin	Major	Unknown. Possible initiated by Purlin failure	Local rebuilding and repair. Possible underpin
64	A2b NE wall South Corner	Rubble wall intact with Purlins P10 & P11	Mixed rounded boulders and stone well bound	Slight	Potential lack of tie to inner loose core	Investigate and if necessary provide through ties
65	A2b Roof	Purlins P8 - P11, and common rafters	Roof Spread + Rafter tails rotten valley side	Moderate	Rain ingress causing rot and decay	Refurbishment of roof fabric. Plus purlins and rafters on valley side
66	A2b South side	External Rubble sub wall with render and ash	Masonry Lower walling not bound	Moderate	Heat and chemical degrade of mortar	Patch repair wall. Possible Underpin
67	A2a SE Side	Truss 5 wall bearing	Embedded End	Unknown	Potential rot	Investigate and repair. Provide Purlin stays
68	A2b	Purlin F8 and common rafters	Decay and rot. Partial collapse carried on prop	Major	Water ingress initiate timber decay and rot	Carry out roof frame repair to lower valley part
69	A2a SE Side	Inner back face to Core Oven stoke holes	Ash and broken material waste	Moderate	Collapse or removal of drying deck to oven	Investigate and repair floor of Oven. Possible underpin walls

Site Address: Melin Daron, Aberdaron, Pwllheli. LL53 8BP			Date of Inspection: 7/8/2020 + (Areas A & C Photographs taken 12/8/20)			
			Job Ref: 1192			
STRUCTURE CONDITION RECORD - INTERNAL			Engineer / Surveyor Initials: CP (No Access into Areas A & C)			
DEFECTS & OBSERVATIONS			Sheet 3 of 3			
<u>PHOTO No.</u>	<u>PART / ELEMENT</u>	<u>DESCRIPTION</u>	<u>DEFECT</u>	<u>SEVERITY</u>	<u>LIKELY CAUSE</u>	<u>RECOMMENDATION</u>
70	A1. SW Gable	Purlins P8_ P11 and Door D7	Some holes in roof	Minor	Storm damage. Lack of maintenance	General refurbishment of roof fabric, Replace outer timber door lintel
71	A1 SE side	Truss 6 wall bearing	Embedded end	Unknown	Potential rot	Investigate and repair as necessary. Provide Purlin stays .
72	A1	Truss 6 collar	Split at south end collar	Minor	Roof Spread walls moved out	Provide collar tie along length of roof with 2 bolts each end to purlin cleats
73	A1	Truss 5 collar	Single coach pinned joint	Minor	Design/ Construction	Provide fixed joint multi bolt to stop articulation
74	A2a	Roof Ridge	Some holes in roof	Minor	Storm damage. Lack of maintenance	General refurbishment of roof fabric
75	A2a NW side	Truss 6 wall bearing	Embedded end	Unknown	Potential rot	Investigate and repair as necessary. Provide Purlin stays .
76	A2 N side	Top of oven stoke hole curved brick	Deteriorated joints with ash and salts	Minor	Heat and chemical attack residue	Clean of debris and repoint. Local patch repair
77	A2	Top of Oven stoke hole lintel	Decayed charred Timber. Splintered brick	Moderate	Heat and chemical attack residue	Patch repair. Replace defective lintel
78	A2 SE side	Ironwork stays / slats	Drying Oven floor missing	Slight	Timber decay and rot (or fire)	Service floor may be omitted to increase ventilations
79	A2 NW side	Ironwork stays / slats. Subwalling has cement / ash render	Open joints. Splayed wall base	Moderate	Heat damage.	Patch repair. Repoint. Possible underpin
80	A1 N Side	Small oven door - brick curved crosswall	Splinted spalled broken brickwork	Moderate	Degradation caused by heat and impact	Patch repair and rebuild
81	A1 S Side	Small oven door - brick curved crosswall	Rendered face become detached	Minor	Heat damage.	Patch repair and rebuild
82	A1	Central charging door - Pointed brick arch	Splinted spalled broken brickwork	Major	Degradation by heat stress and loading	Patch repair and rebuild
83	A1 N side	Timber Beam FB8	Rot and decay	Major	Water ingress and fungal attack	Flitch plate strengthening or replace beam
84	A2	Middle smoke flue chamber	cracked rendered cap	Moderate	Heat and impact	Stich repair or rebuild chimney if oven is reconditioned for use
85	A1 Lower SW Wall	Random rubble wall	Localised gaps and holes	Minor	Detached stones	Patch repair and repoint
86	A1 Lower SW wall	Random rubble wall	Localised gaps and holes	Minor	Detached stones	Patch repair and repoint
87	A1 NW side wall	Random rubble wall	Moisture ingress. Erosion of joints	Minor	Perched trapped water infiltration	Prepare outside ground with falls away from building
88	A1 N Side	Small oven door - brick curved crosswall	Timber lintel rot and decay	Major	Degradation / beetle and fungal attack	Replace lintel with concrete of stone equivalent
89	A1 S side	Small oven door gauged brick flat arch	Broken and splinted	Minor	Differential movement	Tie jamb to external wall. Repoint
90	C1 West	Internal dividing gable wall south corner	Localised gaps and holes	Minor	Detached stone and mortar	Patch repair and repoint
91	C1 West	Internal dividing gable wall north corner	Localised gaps and holes	Minor	Detached stone and mortar	Patch repair and repoint
92	C1 West	Upper gable wall - lime rendered face	Vertical crack	Minor	Differential movement. Focussed NW corner	Patch repair and repoint
93	C1 NW	Random rubble wall	Moisture ingress. Erosion of joints	Minor	Perched trapped water infiltration	Prepare outside ground with falls and new storm / French drain
94	C1 NW	Truss 7	Embedded end	Unknown	Potential rot	Investigate and repair timber as necessary
95	C2	Random rubble wall East	Moisture Ingress. Crack	Minor	Differential movement (subsidence)	Clear vegetation. Investigate foundation. Possible Underpin
96	C2	Random rubble gable east wall. Open cut timber roof	Vegetation penetration in roof fabric	Minor	Lack of maintenance / neglect	General refurbishment of roof fabric
97	C2 SE wall	Doorway D5 Frame and lintel	Lintel is decayed and rotten. Reduced bearing	Moderate	Differential movement in SE wall	Clear vegetation. Investigate foundation. Possible Underpin. Replace lintel
98	C2 SE wall	Random angular rubble wall	Distortion and sagging	Moderate	Differential movement	Clear vegetation. Investigate. Possible underpin. Check Truss 7 embedded end
99	A2	Truss 7 Collar. Purlins P12 - P15	Some holes in roof	Minor	Storm damage. Lack of maintenance	General refurbishment of roof fabric
100	A1 Floor	Cobble floor on lime bed	Ash and broken material waste	Unknown	Storm damage. Lack of maintenance	Clean and assess

APPENDIX C
REFERENCE PHOTOGRAPHS
With Keyplans

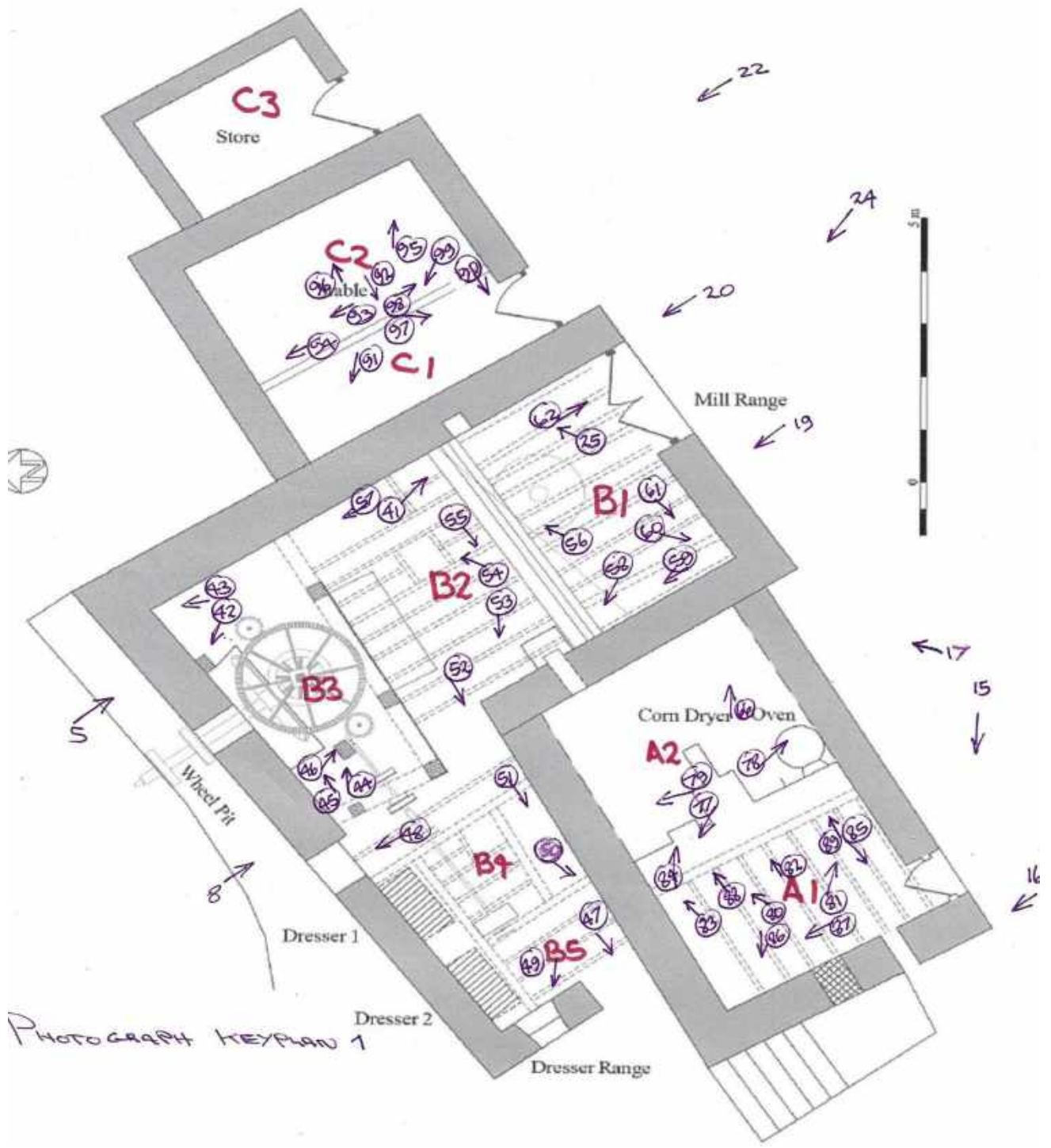



MELIN DARON - PHOTOGRAPHS



1.



2.

MELIN DARON - PHOTOGRAPHS



3.



4.

MELIN DARON - PHOTOGRAPHS



5.



6.

MELIN DARON - PHOTOGRAPHS



7.



8.

MELIN DARON - PHOTOGRAPHS



9.



10.



11.

MELIN DARON - PHOTOGRAPHS



12.



13.

MELIN DARON - PHOTOGRAPHS



14.



15.

MELIN DARON - PHOTOGRAPHS



16.



17.

MELIN DARON - PHOTOGRAPHS



18.



19.

MELIN DARON - PHOTOGRAPHS



20.



21.

MELIN DARON - PHOTOGRAPHS



22.



23.

MELIN DARON - PHOTOGRAPHS



24.



25.

MELIN DARON - PHOTOGRAPHS



26.



27.

MELIN DARON - PHOTOGRAPHS



28.



29.

MELIN DARON - PHOTOGRAPHS



30.



31.

MELIN DARON - PHOTOGRAPHS



32.



33.

MELIN DARON - PHOTOGRAPHS



34.



35.

MELIN DARON - PHOTOGRAPHS



36.



37.



38.



39.

MELIN DARON - PHOTOGRAPHS



40.



41.

MELIN DARON - PHOTOGRAPHS



42.



43.

MELIN DARON - PHOTOGRAPHS



44.



45.



46.



47.

MELIN DARON - PHOTOGRAPHS



48.



49.

MELIN DARON - PHOTOGRAPHS



50.



51.

MELIN DARON - PHOTOGRAPHS



52. .



53.

MELIN DARON - PHOTOGRAPHS



54.



55.

MELIN DARON - PHOTOGRAPHS



56.



57.

MELIN DARON - PHOTOGRAPHS



58.



59.

MELIN DARON - PHOTOGRAPHS



60.



61.

MELIN DARON - PHOTOGRAPHS



62.

MELIN DARON - PHOTOGRAPHS



63.



64.

MELIN DARON - PHOTOGRAPHS



65.



66.

MELIN DARON - PHOTOGRAPHS



67.



68.

MELIN DARON - PHOTOGRAPHS



69.



70.

MELIN DARON - PHOTOGRAPHS



71.



72.

MELIN DARON - PHOTOGRAPHS



73.



74.

MELIN DARON - PHOTOGRAPHS



75.



76.

MELIN DARON - PHOTOGRAPHS



77.



78.

MELIN DARON - PHOTOGRAPHS



79.



80.

MELIN DARON - PHOTOGRAPHS



81.



82.



83.



84.

MELIN DARON - PHOTOGRAPHS



85.



86.

MELIN DARON - PHOTOGRAPHS



87.



88.

MELIN DARON - PHOTOGRAPHS



89.



90.

MELIN DARON - PHOTOGRAPHS



91.



92.

MELIN DARON - PHOTOGRAPHS



93.



94.

MELIN DARON - PHOTOGRAPHS



95.



96.

MELIN DARON - PHOTOGRAPHS



97.



98.

MELIN DARON - PHOTOGRAPHS



99.



100.

APPENDIX D
OUTLINE SCHEME FOR STRUCTURE REPAIRS

CHRIS PIKE ASSOCIATES

BUILDING CONSERVATION & ENVIRONMENTAL SERVICES

13 Claremont Hill, Shrewsbury. Shropshire. SY1 1RD
Tel. 01952 581751 Email. admin@cpaconservation.co.uk



Project:	Melin Daron, Aberdaron (Grade II Listed)	Date:	26/08/2020
Client:	Donald Insall Associates	Job No:	2020/1192/01
Drawing Title:	Preliminary Notes for Structure Repairs & Development	Engineer:	CP
		Issue:	1.0



WEST ELEVATION VIEW – 6th August 2020

Work assumes like for like repair to return to original condition and loading.

No additional protection or safeguarding measures except for consideration of rainwater goods and storm drainage solutions. No insulations to be added.

Intention is to recondition the building shell so that the Mill can become operational again.

CHRIS PIKE ASSOCIATES

BUILDING CONSERVATION & ENVIRONMENTAL SERVICES

13 Claremont Hill, Shrewsbury. Shropshire. SY1 1RD
Tel. 01952 581751 Email. admin@cpaconservation.co.uk



Project:	Melin Daron, Aberdaron (Grade II Listed)	Date:	26/08/2020
Client:	Donald Insall Associates	Job No:	2020/1192/01
Drawing Title:	Preliminary Notes for Structure Repairs & Development	Engineer:	CP
		Issue:	1.0

GENERAL DESCRIPTION & BACKGROUND:

Vernacular stone and timber framed Flour Mill (water driven) dating from mid C19th period on coastal site. External Wheel missing but inner gear mechanism remains mainly intact.

Adjacent Corn Dryer Brick Oven & Dryer dates from late C19th. Stables and Store building extensions on East front corner later additions

Substantial external solid stone random angular rubble# masonry walls of approximate 710mm o/a thickness – loose core fill.

Larger squared corner quoins.

Double pitched traditional cut timber roof with trusses and twin purlins on each pitch supporting common rafters, softwood battens and lime torching beneath welsh slate.

Main Trusses 1 & 2 in South Wing (area B) are diagonal braced Queen style trusses. Other trusses are simple raised collar tied.

Stone flag ground bearing floor with concrete screed overlay Dresser area.

Machinery wheels and upper grinding stones set on substantial Oak frame and concrete base.

First floor sections carried on cross beams with joists half joint with remote ends embedded into wall sockets.

Windows and door openings are trimmed in slate but have timber cross lintels at the head. Series set side by side.

Complex local geology is mix of fine grained siliceous Schists and Phyllite rocks – containing sheared limestone, red phyllite and metamorphosed basaltic lavas.

CHRIS PIKE ASSOCIATES

BUILDING CONSERVATION & ENVIRONMENTAL SERVICES

13 Claremont Hill, Shrewsbury. Shropshire. SY1 1RD
Tel. 01952 581751 Email. admin@cpaconservation.co.uk



Project:	Melin Daron, Aberdaron (Grade II Listed)	Date:	26/08/2020
Client:	Donald Insall Associates	Job No:	2020/1192/01
Drawing Title:	Preliminary Notes for Structure Repairs & Development	Engineer:	CP
		Issue:	1.0

PROVISIONAL REPAIRS– DEFECTS (Refer attached annotated sketch plans SK1 & SK2)

ROOFS:

Allow for complete refurbishment of outer slate covering , softwood battens and lime torching.
Purlins and Trusses through main areas A & B remain generally structurally sound, but allow for exposure and potential local repair of concealed decayed timber ends and purlins as required.
Allow for repair of internal cross tie brace to Truss 2 only (currently missing).
Allow for replacement of bolted tenon joints cross member on all other trusses T3 to T8.
Purlin 1 has been repaired in past 145 x 145 in Oak.
Common rafters (60 x 80 @ 305 c/c) appear generally satisfactory, but allow for splice in repair to defective rafters tail ends (100%) and re- fixing at wallplate, especially on inner wall line between areas A & B where gutter and valley to be reconstructed.
Provide collar tie ceiling at high level along length to restrict spread deflection. Provide lateral restraint strapping at gable ends. Provide positive nail fixing between common rafters and purlins, also at each rafter heel seat on Wallplate. Wallplate to be strapped or vertical fix down with stainless resin bolts.

GROUND FLOOR:

Existing cobble / stone flag on compacted earth floor in Process area with lime (or concrete?) screed to remain and be sympathetically patched.
Remove existing waste detritus, broken rubble and sort through archaeology in Corn Dryer Area (A1 & A2).
Reconstruct new solid ground bearing floor using stone paving or brick on concrete slab or limecrete (150mm thick) with well graded subbase compacted in layers.
Brick oven to be reconstructed to suit proposed future use and milling activity.
Otherwise inner brick arch to oven face to be repaired.
Defective floor beam FB8 to be replaced like for like in Oak.

FIRST FLOOR:

Main central timber Oak beams & Joists.
Replace defective broken and missing joists shown with **X**
FB1 = 110 x 300 Satisfactory but correct orientation canted forward rotation.
Re bed tight in wall sockets. Lime mortar pack.
FB2 = 250 x 500. Satisfactory
Allow for introduction of face fixed batten at wall support if embedded joist ends are found decayed and compromised. Joist size vary between 60 x 160mm in west wing & 90 x 180 in south wing
Replace all rotten floorboards (100%) not considered fit for purpose except for raised platform to main milling stones (100mm deep planks)

CHRIS PIKE ASSOCIATES

BUILDING CONSERVATION & ENVIRONMENTAL SERVICES

13 Claremont Hill, Shrewsbury. Shropshire. SY1 1RD
Tel. 01952 581751 Email. admin@cpaconservation.co.uk



Project:	Melin Daron, Aberdaron (Grade II Listed)	Date:	26/08/2020
Client:	Donald Insall Associates	Job No:	2020/1192/01
Drawing Title:	Preliminary Notes for Structure Repairs & Development	Engineer:	CP
		Issue:	1.0

EXTERNAL WALL:	<p>Allow for patch repair of all elevations. 100% repointing on outer and 50% repointing on inner.</p> <p>All local bulges to be corrected – take down and rebuilt. Allow for strengthening widening the existing wall foundations to sections suffering local collapse due to undermining from roots or scour – shown dark shaded on sketch plans</p> <p>Vertical cracks shown C to be stitch repaired or chased out and rebuilt with pinning stones.</p> <p>Allow for block underpinning (use large bedding stone or concrete) in Corn Dryer – Areas A1 & A2 since lower stonework affected by previous collapse of oven and also by heat damage – {Provisional Item}</p>
LINTELS:	<p>Allow for removal of all defective timber lintels across window openings W1 – W4 and replace with series of precast concrete or cut stone placed in series side by side</p> <p>Allow for fitch plate (stainless steel) strengthening and bolt through of existing weakened timber door lintels insitu on openings D1 – D4.</p>
OTHER WORKS:	<p>A) Allow for complete rebuilding of collapsed Store building</p> <p>B) Allow for appropriate storm drainage outfall and discharge to stream nearby</p> <p>C) Allow for removal of encroaching vegetation and lower ground clearance on outside of Stable North side to reduce damp penetration</p>
NOTES:	<p>External wheel pit and internal basement area below cog machinery in abeyance (Requires further close inspection)</p>

CHRIS PIKE ASSOCIATES

BUILDING CONSERVATION & ENVIRONMENTAL SERVICES

13 Claremont Hill, Shrewsbury, Shropshire, SY1 1RD
 Tel. 01952 581751 Email. admin@cpaconservation.co.uk



Project:	Melin Daron, Aberdaron (Grade II Listed)	Date:	26/08/2020
Client:	Donald Insall Associates	Job No:	2020/1192/01
Drawing Title:	Preliminary Notes for Structure Repairs & Development	Engineer:	CP
		Issue:	1.0

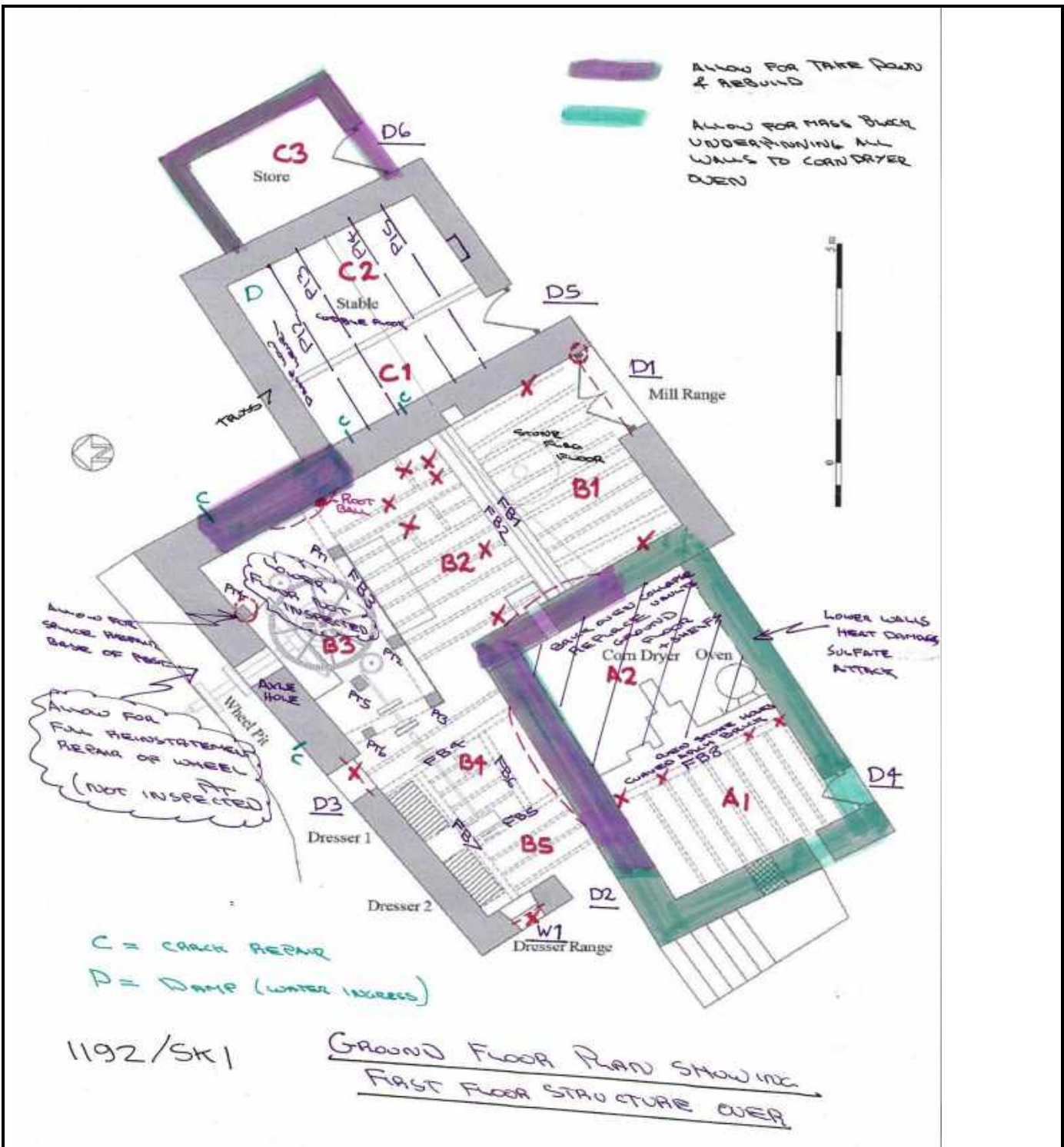

CHRIS PIKE ASSOCIATES

BUILDING CONSERVATION & ENVIRONMENTAL SERVICES

13 Claremont Hill, Shrewsbury, Shropshire, SY1 1RD
Tel. 01952 581751 Email. admin@cpaconservation.co.uk



Project:	Melin Daron, Aberdaron (Grade II Listed)	Date:	26/08/2020
Client:	Donald Insall Associates	Job No:	2020/1192/01
Drawing Title:	Preliminary Notes for Structure Repairs & Development	Engineer:	CP
		Issue:	1.0

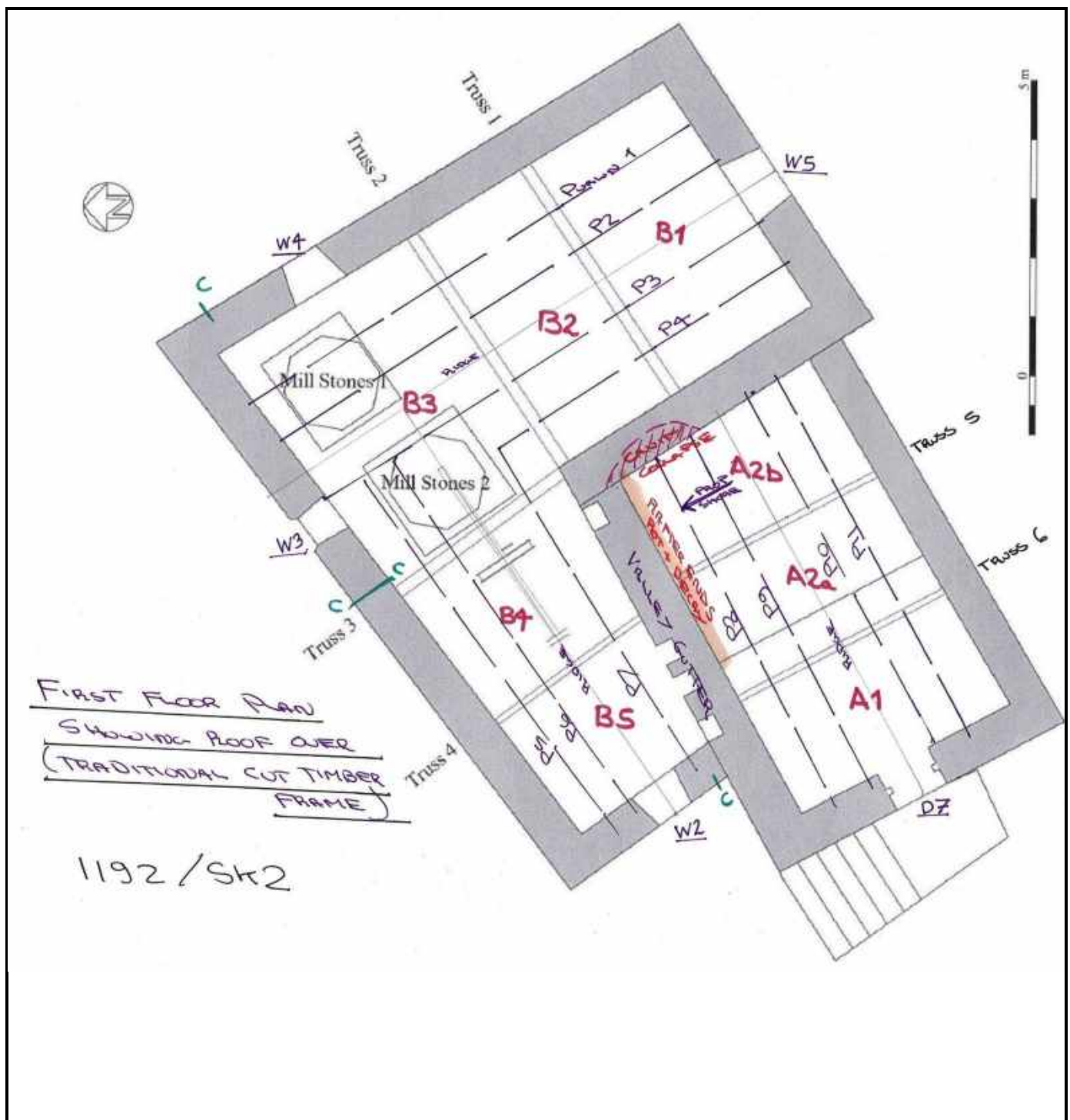

Melin Daron Mill

Aberdaron, August 2020

Visual condition survey, rev1



Wallis Conservation Ltd T/A Dorothea Restorations

Unit 15 Bristol Vale Trading Estate, Hartcliffe Way, Bristol, BS3 5RJ

www.dorothearestorations.com

CONTENTS

- 1.0 – Introduction and Scope**
- 2.0 – Condition of mechanical parts**
- 3.0 – Recommendations and budget costs**

1.0 INTRODUCTION & SCOPE

Dorothea Restorations were approached by the Directors of Melin Daron watermill to provide a survey of the machinery condition. The survey was carried out on 13th August 2020 in dry warm weather.

The mill is Grade 2 listed (CADW – building ID: 19992) and is described as “a substantial village corn mill of vernacular type, and despite the loss of the wheel, still retains character as a rural industrial building”

From discussions with Mr R.Milnes (Director) it is understood that there is a wish to put the mill back into operating condition such that it can produce flour for human consumption. It is understood that there is the option to source grain locally and there is a bakery opposite the mill to help process the flour. We would suggest that only 1 set of stones be re commissioned.

Elements that have been inspected (as far as access allowed):

- Penstock and outlet pipe
- Flow control valve
- Launder
- Waterwheel
- Pit wheel
- Hurst frame
- Driving machinery to millstones and associated controls
- Mill stones and furniture
- Dressing machines
- Layshafts, pulleys and associated bearings

As millwrights and metalwork conservators Wallis Conservation Ltd does not offer any opinion on the structural adequacy. In case of doubt the Directors should engage the services of a Structural Engineer.

The Mill was constructed in Imperial measure, so this has been used during the inspection. For conversion:

- 1 inch = 25.4 mm.
- 1 foot = 305 mm.

2.0 CONDITION

PENSTOCK (mill pond)

The pond behind the mill is completely overgrown, but the side walls are in evidence showing where the boundary to the pond was.



It is understood that there is no current water supply to the mill and the plan is to either pump water from another location or to obtain it from a bore hole. Calculations will need to be carried out to understand the amount of water required to start the mill, and then the amount required to keep it running whilst producing flour. It should be possible to install a recirculating system which will require an area below the waterwheel to collect water and recirculate it back into the mill pond. It is likely that the pond will require re pointing or possible re puddling (application of clay to the side walls and base to make a water resistant structure).

Whichever route is taken, minimising the loss of water in the system will be crucial. If, following further investigations it is found that there is only enough water to rotate the mill but not mill for flour, it may be possible to install an electric drive to operate the millstones when milling is required.

OUTLET PIPE & WATER CONTROL VALVE

Water from the mill pond is transferred through the end wall via a 12" diameter iron pipe. This is significantly rusted and wasted.



This pipe will either require replacement or conserving where it is and a new sleeve place inside. At present there is no way of controlling the water flow from the mill pond through the pipe and ultimately into the launder. It is suggested that a modern butterfly or gate valve be installed on the pond side of the pipe to provide control. The only real way to control the speed and operation of the mill is by regulating the water supply. In an emergency it is vital that the water can be turned off quickly, so a substantial and easily maintainable closing valve is essential. Historically this would have been a timber sluice gate at the head of the mill pond where the river fed into it.

LAUNDER

The Launder is a timber construction that would carry the water from the mill pond and outlet pipe to the waterwheel. Within the launder there would be a flap that could be opened / closed from inside the mill controlling the amount of water over the wheel and therefore the speed. All of this is missing and will need to be designed and recreated. The launder sat on 3 wrought iron "I" beams 6" x 3" (only 2 remain) and these are heavily wasted and bowed. There is evidence in the side wall of the location of the now missing 3rd support beam which has been pointed in. All beams will need to be renewed in the nearest available size to match what is currently there. A new launder manufacture in oak should be designed and manufactured to a traditional design and installed. A new opening hatch will be required and can be connected to the remaining original internal operating mechanism. As a side note – the base of the launder may have been from slate based on the location and proximity to local slate quarries. If archive photographs can be found it should be possible to see this.



Internal peg board and control arm for the external launder water flap. All ironwork requires de rusting and treating with a suitable oil or paint system for protection. The peg board requires re attaching to the wall in the correct place and the iron rod passing through the wall requires 2 new plain bearings to support it. Fixing of the control rod to the end of the timber control arm should be re wedged.

WATERWHEEL – assumed overshot type

Remains of the waterwheel exist giving evidence of what might have been there. In the "Engineers design brief" there is reference to a 4.8m diameter wheel. It is likely the wheel would have been to the nearest imperial equivalent which would have been 15 ½ ft, although most are to whole imperial measurement so either 15 or 16 ft. A forged wrought iron shaft remains (7" sq) with two cast iron hubs and cover plates.



These can all be reclaimed. They require removal of the rust, painting and renewal of the hub fixings. External shaft bearing was just visible through the undergrowth, its cast iron plumber block can be refurbished but will require a new internal plain bronze bearing. The whole assembly will need re bedding on new timbers fixed down to the wall. There are 16 spokes (8 per side) 4.5" sq all need renewing. The wheel is completely missing and no evidence remains as to what the shrouds or buckets were made from. Based on the amount of other iron components i.e shaft and hub it is reasonable to assume that the shroud was manufactured from cast iron in sections with either timber or iron buckets. For pricing purposes, we will assume cast iron shroud with timber buckets.

Internal shaft bearing journal is smooth and the cast iron plumber block remains. It will require a new plain bronze bearing to match the ware on the shaft journal.



PIT WHEEL

The Pit wheel is cast as a single grey iron casting with separate castings for the teeth. These appear to be split into segments meaning they can be replaced when worn. The pit wheel is wedged onto the shaft and appears secure. It is heavily rusted but there is minimal section loss on the main spokes so is serviceable. The wheel measures 88" diameter and comprises 112 teeth with a pitch between them of 2".



The teeth are heavily worn, if the mill was just going to rotate without having a load put on it (i.e. by milling) then the teeth would operate. As the plan is to mill these teeth will need to be replaced to prevent the risk of failure in the future.



HURST FRAME

The hurst frame provides support for the millstones, upright shaft, some ancillary drives and stone nuts. It is manufactured in general from 12" x 7 1/2" timbers and is generally sound apart from where two vertical sections meet the floor and are significantly rotten. West upright (to the Left of the pit wheel when looking from the inside out) requires a replacement section to be scarfed in 12"x 9.5" x 1ft long. East upright (to the right of the pit wheel) requires a new section scarfed in 12" x 7.5" x 22" long



Panelling to the outside of the hurst frame is missing in one area and should be replaced using 16" x1" boards of the same timber



All grain chutes passing from the 1st floor through to the ground floor will require renewal, to match the current design

DRIVING MACHINERY TO MILLSTONES and CONTROLS

- 1- Upright shaft is driven from the pitwheel through the wallower. At the base is a cast iron adjustable block with a plain bronze bearing (foot bearing) Both appear serviceable although the thickness of the foot bearing was not checked. Top bearing cast iron block is reusable, requires cleaning and will need new bronzes as these are visibly worn. There is significant old grease and debris build up around the bottom of the shaft that will need removing. Foot bearing support timbers have significantly rotted and will require replacement. These are 7.5"x8.5" 34" long 2nr required.



- 2- Wallower – driven by the pit wheel. This is 40" diameter with a 2" pitch between teeth (to match the pit wheel). The teeth are worn to match the pitwheel. The teeth are serviceable but if the pitwheel teeth are being renewed then the wallower should also be renewed to match.



- 3 – Great Spur wheel. This sits on top the wallower and drives the stone nuts and ancillary drives. It is 80" diameter, cast iron and is in good condition

- 4 – West stone nut (nearest carpark) This is a cast iron hub with timber teeth set into it. 20" diameter wedged onto a wrought iron 2.5" sq shaft. This sits in a plain bronze foot bearing. There is excessive grease around the bearing and this will need cleaning. Teeth are held into the gear by iron pins, 6 of these require replacement. The teeth are worn but serviceable.



5 – East stone nut. Same construction as the west stone nut except this is missing 10 teeth. The foot bearing looks significantly worn.

6 – Controls. The stone nuts sit on the hurst frame and this section can be raised or lowered by handles to provide adjustment to the millstones (known as tentering). Both handles are in existence and once freed would operate again.



All ironwork to the above items require de rusting, cleaning and either painting or oiling.

7 – Control cables from ground floor level through to millstone furniture is all missing and should be reinstated using a natural fibre rope.

MILLSTONE & FURNITURE

On the first floor there are 2 sets of millstones. Both are monolithic type stones which have been hewn from a single stone source. They appear to have elements of quarts in them so are probably fairly hard wearing. Both sets are 5ft in diameter. The bed stones are 6.5" thick whilst the running stone tapers from 2" at the perimeter to 6" at the eye (centre). There are metal bands around the outside which help hold the stones together whilst in operation. Both bands are at the limit at which they can be adjusted and therefore if milling is required a replacement set of stones will be required.

West stone set

Millstone furniture, hopper, horse and shoe are in serviceable condition, all will require sanding and resealing with minor repairs required to the shoe. The tun is rotten on two sides with 3 top covers missing. It is suggested this is completely renewed. The centre tin eye will require replacement as this is rotten but the damsel and mace appear intact and serviceable. Neck box in the bedstone is still

wedged in place but it was not possible to see the condition of the bronze wear blocks.

East stone set

Millstone furniture, hopper and horse are complete and serviceable. Shoe, damsel and eye are missing. The tun is beyond repair and would require complete replacement. Neck box in the bedstone is still wedged in place but it was not possible to see the condition of the bronze wear blocks.

This set of stones was lifted to view the stone faces



One set of new stones will be required if milling is required. These can either be another set of monolithic stones, French Burr or a composite set (man-made). French burr are known as the best type for good quality flour production so it would be preferable to try and source this type if possible.

DRESSING MACHINES

To the west corner of the mill (carpark side) there are two dressing machines. Both appear to be of similar design so were either both used to sift flour or one may have been adapted to enable it to sift the incoming grain and remove any debris before milling. The far left machine only has its outer casing and Central armature remaining.



The central armature is missing its drive gear teeth, all wiping brushes, external timber surround and sifting mesh grill.

The second dressing machine is more complete. There is evidence of the internal wiping brushes, mesh surround (although top half is missing) and the external case is largely complete.



The main structure is missing the two rear legs which should be replaced.

Both machines are missing their first floor hoppers and feed chutes.

Consideration should be given as to whether it is worth getting these into operational condition. We would suggest that the west machine is conserved as it is, whilst the other machine is repaired so it can rotate and run off a line shaft but not sift grain or flour. A new drive belt will be required if this is the case.

LAYSHAFTS, PULLEY'S & BEARINGS

Ground floor

Line shaft running to the left of the mill. This drives the dressing machines and provides a drive to the first-floor sack hoist. The shaft itself is complete but rusty. It is missing its drive gear off the spur wheel which would need to be reinstated if it is to operate. Timber pulley that would send the drive to the sack hoist requires repair where broken on the rear flange. Leather drive belt is intact and serviceable. Without dismantling the bearings all look to be serviceable.

Line shaft running under the hurst frame. This appears to drive what may have been a dust extractor or a fan to circulate air around the mill. The drive shaft is complete and the gears although heavily rusted could be serviced and used. There is no evidence of a case or box around this element so more research may be required if this is to become operational. Wooden drive drum requires a new rear flange where broken and a drive belt. We would suggest that this element is conserved and stabilised but remains as a static object.



Second floor line shaft. This is for the sack hoist and is driven from the line shaft on the ground floor. The main timber drive wheel is complete apart from some of the internal running surface which should be replaced. The shaft is complete and rotates. Bearing over the west millstones should be replaced as it is significantly worn. The pivot pin to enable the sack hoist to be engaged and disengaged is missing and would require replacement. To enable this to operate a new chain would be need, guide pulley in the roof which is missing and the trap doors reinstated.



3.0 RECCOMENDATIONS & COSTS

Based on our survey we would suggest the following on the assumption that the mill is to produce flour and that there is enough water to do this (electrical drive option not costed at the moment). We would suggest that the west (nearest the carpark) set of stones is made operational with the other set stabilised and conserved but not operational:

3.1

- Generally de grease and clean / stabilise ironwork throughout (associated with the machinery)

3.2

- New gate valve to pond
- New or sleeved 12" pipe through the wall

3.3

- Renew 3 Launder support beams to match existing
- Design and install new launder with operating hatch connected to existing lever arm. New bearings to lever arm.

3.4

- Level the waterwheel shaft
- Supply new external bearing and reset shaft level

- Supply new internal bronzes to main shaft
- De rust shaft and hub ironwork, paint
- Design and build new waterwheel with cast iron shroud and timber buckets
- 3.5
 - Renew teeth to pit wheel complete
 - Renew wallower complete
- 3.6
 - Repair two hurst frame uprights and missing side boarding
 - New timbers under upright shaft
- 3.7
 - New bearing bronzes to upright shaft
 - Replace damaged or missing pins from west stone nut
 - Clean and conserve, but not repair East stone nut
- 3.8
 - Remove worn west pair of millstones, place in mill somewhere
 - Supply and install 1 new reconditioned set of millstones (type to be agreed)
 - Set up millstones
- 3.9
 - Repair the hopper, horse and shoe. Varnish with an environmentally friendly varnish
 - Renew the Tun complete
 - Install operating ropes
- 3.10
 - Design, manufacture and install new take off gear to ground floor lay shaft
 - Repair sack hoist drive
 - Overhaul sack hoist, provide new chain, pin and get operational
- 3.11
 - Carry out minor works to west corner dresser to stabilise and conserve.
 - Repair, so visually correct, other dressing machine to enable it to rotate but not be functional
- 3.12
 - Renew flour chutes
 - Overhaul ground floor flour bin
 - Overhaul tentering mechanism so it works
- 3.13
 - Conserve and stabilise hurst frame line shaft driving possible fan. Do not get operational.
- 3.14
 - Provision or 1 days training to a small group of selected volunteers who will operate the mill
 - Provision of an Operating and Maintenance manual on completion of the works

Excluded:

- Inflation beyond the end of 2020.
- VAT.
- Statutory or professional fees, other than those of a mill-wright.
- Main contractor's on-costs, or discounts from contractors.
- Delays due to inclement weather or other unforeseen circumstances.
- Attendance on other contractors or delays arising from their works.
- The cost of complying with onerous contract conditions or H & S requirements imposed by others.
- Any works to the main pond
- Any recirculating pump system
- Guarding of the machinery for public protection
- Digging out of the pond, wheel pit or pit wheel areas
- Environmental or Hygiene inspections or submissions to enable milling to commence for human consumption

Assumptions:

- Outdoor works will be carried out during the spring/ summer months.
- Access will be available from 8.00am to 6.30pm daily Monday-Friday,
- Welfare facilities, tool-storage and 240V power to be available f.o.c.
- Mill will be stabilised and made watertight by others

Costings, Budget, subject to review	£ + VAT
3.1 Generally clean and degrease machinery	1,500
3.2 Valve and pipe	1,800
3.3 Launder and supports	5,500
3.4 Waterwheel works	20,000
3.5 Pitwheel and wallower works	15,000
3.6 Hurst frame repairs	4,500
3.7 Upright shaft and stone nut	3,500
3.8 Millstones	18,000
3.9 Millstone furniture	4,000
3.10 Lay shaft and sack hoist	4,000
3.11 Dresser works	2,500
3.12 Ancillary items	2,000
3.13 Fan and line shaft	1,500
3.14 Training and manual	1,500

3.15 Contingencies

**£ + VAT
10,000**

Additional options, budget figures:

Recirculating pump.

This would probably need to be 3 phase 415V with the bore size of the pipe calculated once torque test can be carried out on the restored machinery. A suitable sump below the wheel would be required. The following price does not allow for electrical connections or laying of a 3 phase supply to the mill.

Budget - £6,000 + VAT

Direct electrical drive – not milling, machinery rotation only

This would probably need to be 3 phase 415V. You would need to carry out torque tests on the machinery once restored and decide the best place to drive from. The motor would need to be partnered with a soft start inverter.

Budget - £ 10,000 – 15,000 + VAT

88

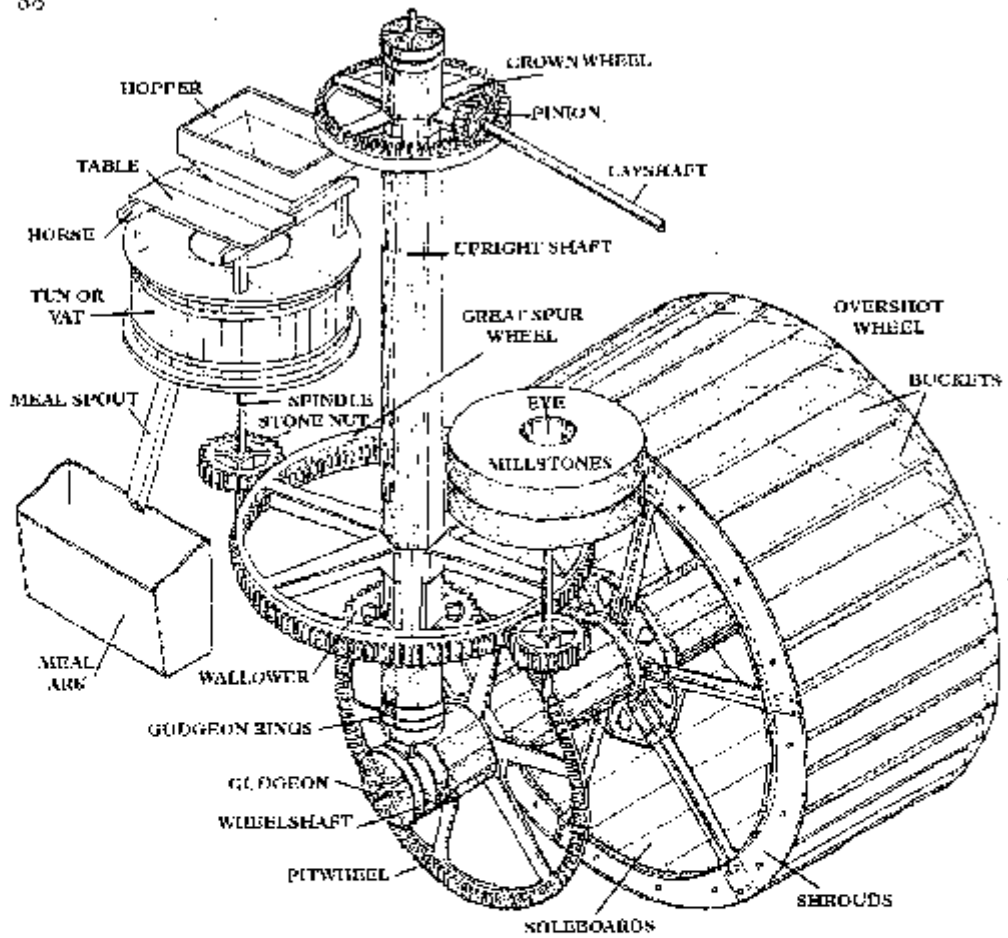

End of Report