



eas

Engineering Archaeological Services Ltd.

MELIN ABERDARON

Archaeological Survey

I.P. Brooks

Engineering Archaeological Services Ltd

EAS Client Report 2015/13

Melin Aberdaron, Archaeological Survey

Commissioned by

**Mark Roberts
for
Geraint Jones**

Fieldwork and Analysis by:

I.P. Brooks

Engineering Archaeological Services Ltd

Engineering Archaeological Services Ltd is

Registered in England No 286978

MELIN ABERDARON

Archaeological Survey

I.P. Brooks

Engineering Archaeological Services Ltd

EAS Client Report 2015/13

CONTENTS

Introduction

Summary

Location

Archaeological Background

Methodology

Results

The Setting

The Buildings

The Mill Range

The Grain Dryer

The Dresser Range

Service Range

The Mill Works

Graffiti

Conclusions

Acknowledgements

References

Glossary

List of Illustrations

Figure 1: Location

Figure 2: Extracts from the 1888 and 1901 1:10560 Ordnance Survey Maps, Caernarvonshire XLIII. SE Not to Scale.

Figure 3: Topographic survey of the site

Figure 4: Contour Survey

Figure 5: Ground floor plan

Figure 6: First floor plan

Figure 7: Elevations

Figure 8: Profile through the mill

Figure 9: Water wheel, axle and pit wheel

Figure 10: Isometric drawing of the water wheel hub

Figure 11: Main shaft, wallower and great spur wheel

Figure 12: Stone nuts

Figure 13: The lower lay shaft

Figure 14: The upper lay shaft

Figure 15: Reconstruction of the works

Figure 16: Tracing of the scratched ship

Figure 17: Possible development of the buildings

Figure 18: Extract from the Aberdaron Tithe Map

Figure 19: Location of the Photographs in the Archive: Ground Floor

Figure 20: Location of the Photographs in the Archive: First Floor

Plate 1: View of the mill, looking north east

Plate 2: The mill pond

Plate 3: The outfall pipe and position of the launder

Plate 4: The wheel pit, looking north west

Plate 5: The wheel pit looking south east

Plate 6: Shallow buttress on the pond retaining wall

Plate 7: The south eastern gable of the mill range

Plate 8: The roof of the mill range

Plate 9: Opening for the control of the penstock

Plate 10: Water wheel inspection window

Plate 11: The opening for the water wheel axle

Plate 12: Millstone in the floor of the mill range

Plate 13: Door handle to the mill range.

Plate 14: Inside of the doors to the mill range

Plate 15: Niche in the mill range

Plate 16: The casing for one of the dressers in the mill range

Plate 17: Ceiling joist in the mill range

Plate 18: The spout between the corn dryer and the mill range

Plate 19: Slipper

Plate 20: The Hurst frame and trough in the mill range

Plate 21: The spout from the eastern stones

Plate 22: The stone floor of the mill range looking south east

Plate 23: Remains of the hatch in the mill range

Plate 24: The stone floor of the mill range, looking north west

Plate 25: The windlass attached to Truss 1

Plate 26: Iron ring above the hatch in the mill range.

Plate 27: Worn slots on Truss 2 and its associated purlin

Plate 28: Worn slot in the purlin

Plate 29: The adjuster for the penstock

Plate 30: Iron banded millstone

Plate 31: Ground floor entrance to the corn dryer

Plate 32: The south western gable of the corn dryer

Plate 33: Detail of the first floor door to the corn dryer

Plate 34: Northern elevation of the corn dryer

Plate 35: The dividing wall in the corn dryer

Plate 36: The northern and central opening in the dividing wall of the corn dryer

Plate 37: The firebox

Plate 38: The oven

Plate 39: Blocked window

Plate 40: Fitting on the upper door of the corn dryer

Plate 41: Shafts from a cart

Plate 42: Perforated stack behind the firebox

Plate 43: Lower chamber of the corn dryer

Plate 44: First floor of the corn dryer looking north east.

Plate 45: Top surface of the perforated tile
Plate 46: Lower surface of the perforated tile
Plate 47: Sawn off principle rafter
Plate 48: Tool from the corn dryer
Plate 49: Head of the tool from the corn dryer
Plate 50: Wooden stair case
Plate 51: Gable end of the “Dresser Range”
Plate 52: Ground floor window in the “Dresser Range”
Plate 53: Window in the northern wall of the “Dresser Range”
Plate 54: Ground floor of the “Dresser Range”, looking south west
Plate 55: Ground floor of the “Dresser Range” looking north east
Plate 56: First floor of the “Dresser Range” looking north east, showing the hatch
Plate 57: Opening in the floor of the “Dresser Range” above the dressers
Plate 58: The niches in the “Dresser Range”
Plate 59: Detail of the slate lined niche
Plate 60: The stables
Plate 61: The floor of the stables
Plate 62: The wooden bench in the stables
Plate 63: The horse collar
Plate 64: Horse harness
Plate 65: The hub of the waterwheel
Plate 66: Detail of the structure of the waterwheel hub
Plate 67: Detail of the structure of the waterwheel hub
Plate 68: Historic photograph of the mill (Source
http://www.rhiw.com/hanes_02/melinau_llyn/melin_aberdaron.jpg)
Plate 69: The pit wheel
Plate 70: The main shaft
Plate 71: The wallower
Plate 72: One of the stone nuts and the great spur wheel
Plate 73: Modification to the Hurst Frame to accommodate the great spur wheel
Plate 74: The western stone nut
Plate 75: The eastern stone nut
Plate 76: The latch securing one of the stone nuts and part of the tentering gear
Plate 77: The cam for fine adjustment of the tentering mechanism
Plate 78: One of the adjuster handles for the tentering mechanism
Plate 79: Hopper and slipper for the western stones
Plate 80: The damsel at the eastern end of the Hurst Frame
Plate 81: The chute from the eastern stones
Plate 82: The remains of the chute from the western stones
Plate 83: The bearing at the eastern end of the lower lay shaft
Plate 84: The pulley wheel on the lower lay shaft within the Hurst Frame
Plate 85: The second pulley wheel and third bearing block for the lower lay shaft
Plate 86: The western pulley wheel on the lower lay shaft
Plate 87: Shaft at the foot of the Hurst Frame
Plate 88: The tensioner in its closed position
Plate 89: The tensioner in its extended position
Plate 90: The gears driving the fan
Plate 91: The fan
Plate 92: The western dresser
Plate 93: The eastern dresser

- Plate 94: The works of the eastern dresser*
Plate 95: The brushes within the eastern dresser
Plate 96: The wooden guide for the drive belt
Plate 97: The upper pulley wheel.
Plate 98: The worn section of the upper lay shaft above the hatch
Plate 99: The reinforced section of the upper lay shaft
Plate 100: Pulley wheel, part of the sack hoist mechanism
Plate 101: Graffiti on the southern face of the ceiling beam in the mill
Plate 102: Graffiti on the northern face of the ceiling beam in the mill
Plate 103: Area of graffiti at the eastern end of the Hurst Frame
Plate 104: Date at the eastern end of the Hurst Frame
Plate 105: Date on the eastern end of the Hurst Frame
Plate 106: 1901 Factory and Works Act record
Plate 107: The pokerwork schooner
Plate 108: The pokerwork steam ship
Plate 109: The scratched ship
Plate 110: Graffiti in the area of the scratched ship

Introduction

Summary

Melin Aberdaron is a multi-phased building with an initial phase consisting of a building set at right angles to the mill leat. This developed with the addition of an attached corn drying kiln, a new range to house two flour dressers, a stable and a store. Although the waterwheel has collapsed, the mill range contains most of the works, although a few of the parts are missing. The gear train is somewhat compressed with the whole of the gear train being housed in a Hurst frame on the ground floor. This required for a somewhat unusual pattern with a crown ring on the Great Spur Wheel driving a lay shaft on the ground floor. The upper lay shaft was driven by a leather belt from the lower lay shaft. There is also an unusual fan set in the edge of the Hurst Frame which is assumed to aid in the cooling of the all metal gear train

There is also several incidents of graffiti throughout the building. Of particular note are the representations of three ships on the trusses and a series of dates on several of the timbers.

Location (Figure 1)

Melin Aberdaron is located to the south of the B1143 in the area between this road and the Afon Daron at SH 17368 26481 (Plate 1). Whilst the road has a considerable slope down to the level of the Pont Fawr, which crosses the Afon Daron, the mill buildings are on a near level site at about 9 m OD.

Archaeological Background

It is intended to restore Melin Aberdaron to a working mill after many years of neglect. The mill is Grade II listed (Listed Building reference 1992). It was included in the list as “a substantial village corn-mill of vernacular type, and, despite the loss of the wheel, still retaining character as a rural industrial building.” A desktop study has already been commissioned from Govannon Consultancy (Gwyn 2015) which has outlined the historical documentation of the mill and also recommended the documentation of the surviving remains together with a watching brief on any development.

Methodology

A topographical survey of the mill and its associated mill pond was undertaken using a Leica TS06 total station. The same instrument was also used to record the three of the elevations of the building. At the time of the survey (July 2015) the millpond and the store house at the north eastern end of the mill range were heavily overgrown, restricting the level of recording that was possible.

The building and the works were recorded by direct measurement. Photographs were taken with a Nikon D80 DSLR camera with photographs taken in RAW (Nikon NEF) format at a resolution of 10.2 MP. Where possible the photographs included a metric scale of a suitable size. Further photographs were also taken with a Panasonic Lumix DCM-TZ60 camera with a resolution of 18.1 MP.

Results

The mill complex at Aberdaron is composed of a number of elements. (Figures 3-6) At the centre of the complex is the earliest of the surviving buildings which holds most of the machinery and is probably the original mill building. This building is most likely associated with the mill pond and its associated leat, although there is some modern modification to accommodate the footpath running along the southern side of the mill pond. Other buildings in the range include a corn dryer, a range to house the flour dressing machines, a stable and a store. These elements will be discussed separately together with a discussion of the mill machinery and the graffiti found in the building.

The Setting

The mill was fed with water from the millpond immediately to the north east of the building range (Plate 2). This is at least 29 m long and up to 7 m wide. In its silted form the base of the mill pond is 3.8 m above the level of the floor of the mill. The south eastern and south western sides of the mill pond are now marked by a modern stone and concrete path, however this sits on top of the retaining wall for the mill pond. At the south western end of this retaining wall, it becomes at least 2.6 m high and has three shallow buttresses supporting the wall (Plate 6). Between two of these a metal pipe allows for drainage from the pond (Plate 3). This sits within a blocking in the wall suggesting there was originally a launder supplying water to the top of the water wheel.

The leat which fed the mill pond is now largely occupied by a footpath, however the 1888 Six Inch Ordnance Survey Map (Figure 2) shows the leat to extend approximately 650 m to the north east where it takes water from the Afon Daron. This map also shows a second pond approximately 375 m NE of the mill which presumably acted as a reserve pond. This pond does not appear on the 1901 map and was therefore probably a short lived feature.

The wheel pit is (Plates 4 and 5) 0.91 m (3 feet) wide with a platform to the north west which supports the bearing for the waterwheel. Unfortunately the retaining cap for this bearing is now missing. Above the wheel pit two iron bars cross between the gable end of the mill building and the retaining wall for the B1143 which are assumed to be the supports for the launder. These are approximately 2.56 m (8.4 feet) above the axle for the waterwheel suggesting the waterwheel may have had a diameter of 4.80 m (15' 9"). The wheel pit itself is partly filled as is the tail race. Indeed beyond the extent of the mill buildings the tail race has been completely filled.

The Buildings

The plans of the buildings are shown on Figures 5 and 6, and the elevations on Figure 7.

The Mill Range

The mill range appears to be the earliest surviving building on the site. It is aligned NW – SE at right angles to the wheel pit and the tail race. The building is slightly trapezoidal in shape being 0.46 m wider on its north western gable end. It is constructed of roughly coursed stone blocks (Plate 7) under a slate covered roof (Plate 8). The quality of the slates used for this roof, particularly when compared to those used on the stables, would suggest that it has been replaced. Even so the underside has been torched with lime mortar in places. This occurs particularly at the north eastern end of the range.

The range is entered at the south eastern gable end (Plate 7, Figure 7.3) through double doors, the western leaf of which is divided into two half door. There is wooden lintel over this opening which has a distinct curve to its profile, possibly suggesting it was a re-used timber. On the first floor level there is a centrally placed opening with a stone lintel, although no fittings survive, the size of this opening would suggest that it was a window and not an external access point to the first floor.

The north western end of this range overlooks the wheel pit. There is a clear division between this range and the “Dresser range” with a vertical joint in the stonework (Figure 7.1). There are three openings in this gable end. There is a small opening at the top of the building with a stone lintel (Plate 9). This houses the metal fitting which was used to control the penstock and therefore the flow of water over the waterwheel. At the first floor level, the second opening (Plate 10) also has a stone lintel. This is a window for monitoring the water wheel. The third opening is at ground floor level and allowed the axle of the waterwheel to pass into the building (Plate 11). It also has a stone lintel.

The ground floor can be divided into three zones, the south eastern end, the central area and the north western end occupied by the Hurst Frame and the mill machinery. Set in the floor of the south eastern end of the range, is most of, a worn out runner stone, 1.5 m 4’ 11”) in diameter (Plate 12). It would appear to be of Anglesey grit having been made of a single slab of rock. The doors to the mill range have a series of blacksmith-made fittings. On the outside of the doors, to the mill range, there is a ring door handle on the upper leaf of the spilt door (Plate 13) with a diamond shaped plate behind. This lifts a simple latch on the inner surface of the door. The rest of the door furniture (Plate 14) also appears to be blacksmith made. The upper door hinges have simple triangular finials whilst the main doors have spade shaped finials. The lintel over the door is wooden with a similar twist to that used on the outside of the building. The series of peg holes on the underside of this timber would suggest it is a re-used timber. There is a small niche in the eastern wall which is of unknown function (Plate 15). Resting against the wall at this end of the building are the outer frames of a dresser (Plate 16)

The division between the south eastern end and the middle section of the range is defined by a slight step in the floor and the two ceiling beams crossing the range (Plate 17). Both of these beams appear to be of re-used timbers with the smaller, southern ceiling beam having a quarter round moulding. The larger, northern, beam has a series of mortice holes on its underside also demonstrating that the beam is re-used. On the western wall there is the remains of a wooden spout (Plate 18) which would have allowed grain from the corn dryer to be transferred to the mill range. The wall of the mill range around this feature appears to have been re-built suggesting the link between the corn dryer and the mill is a secondary feature. Resting on the opposite wall is a wooden slipper (Plate 19) which is probably from the eastern stones on the first floor.

The north western end of the range contains the mill mechanism which is contained within, and supported by, the Hurst Frame (Plate 20). The southern side, of which, is completely boarded hiding the machinery behind. At the eastern end is the remains of the wooden ladder to the first floor and the access point to the machinery. Also attached to the Hurst Frame is a wooden trough which served as the receptacle for collecting flour from the eastern stone via a wooden spout (Plate 21). Also sitting within this trough is a second trough which originally sat below the spout from the western stones on the western side of the Hurst Frame.

The tripartite division of the mill range is also reflected on the first (stone) floor (Figure 6). The south eastern end of the range is slightly raised (Plate 22) whilst the middle section is less well preserved than the rest of the floors in this range. It does, however, include the hatch for a sack hoist (Plate 23). The north western end, above the Hurst Frame, has the two sets of stones within their octagonal tuns (Plate 24). There are two trusses crossing the range. Truss 1 defines the division between the south eastern end and the middle section of the range. It is a relative simple truss with raking struts, however there is a windlass attached to the southern side of the truss (Plate 25) and a high collar attached to the northern side supports a longitudinal beam between the two trusses. There is an iron ring on the underside of this beam which is above the hatch (Plate 26). Truss 2 is a simple "A" frame, the western principle rafter, however has been replaced with a softwood round sectioned timber. The replacement of this timber is probably related to the worn slots in the associated timbers to this truss (Plates 27 and 28). These slots would suggest that there was a link between the upper lay shaft and the iron ring above the hatch, suggesting the sack hoist was powered by the upper lay shaft. The iron shackle and chain attached to the upper northern purlin (Plate 29) is probably related to lifting the western runner stone for dressing. The high opening in the north western gable end of the mill range contains the lever to control the penstock and a pegged board which defined the level to which the penstock was opened. There is a runner stone loose in the northern corner of the mill range, although it is somewhat hidden by vegetation growing through the roof. This has an iron band and appears to be of Anglesey gritstone (Plate 30).

The Grain Dryer

The grain dryer is aligned at right angles to the mill range running to the south and west (Figures 5 and 6). The straight joint in the stone works of the walls suggests this is of a later build than the mill range. It is constructed of roughly coursed stonework (Plates 31, 32 and 34) under a slate roof. This is clearly a relatively modern roof, lacking any of the vents normally associated with this type of structure.

There are two doors into the corn dryer, one on the ground floor (Plate 31) and one on the gable end giving access to the first floor (Plates 32 and 33). The door in the southern elevation is a half door below a wooden lintel (Plate 31). This lintel is clearly a re-used timber with a mortice cut towards its eastern end. The door in the gable end (Plate 32) is approached by a short flight of stone steps. These were constructed from a level approximately 0.7 m above the current ground level and have soil beneath them. This would suggest that they are a later adaptation to gain access to the first floor of the building after soil had accumulated along the gable end. The door, itself, has a wooden lintel, however there is also a low arch of half bricks supported by a car's leaf spring above the lintel. Whilst the bricks are of a size to be late eighteenth or early twentieth century in date the car spring is clearly late twentieth century in date. It is therefore assumed that the spring was inserted at a later period. The roof to this range has been replaced, although there is some evidence that re-used slates were used. There is also ceramic ridge tiles on this roof (Plates 31 and 34)

On the ground floor the building is divided into two spaces. Though the eastern door is the stoke house for the corn dryer. The eastern end of this space has the brick dividing wall with three openings. This wall has a stone base and a brick vault with its top supported by the ceiling beam so that it is 0.60 m overhung. There are three openings in the wall (Plate 35), two of which relate to the use of the building as a corn dryer and the third is an inserted oven. The northern opening probably gave access to the heat chamber for cleaning, it has a rectilinear form and a wooden lintel (Plate 36). The central opening (Plate 36) is formed with

a brick, pointed arch and contains the firebox for the corn dryer (Plate 37). The firebox is a metal box with an iron door supported on brick piers. There is an oven (Plate 38) in the southern end of the dividing wall. This is clearly an inserted (later) feature constructed of slightly larger brick than the rest of the dividing wall. The oven itself is approximately 0.78 m in diameter. There is a block window in the western gable wall (Plate 39). It is likely that this was blocked when the external flight of stairs was added to the building. The door to the ground floor (Plate 40) has blacksmith made fittings with iron pintels and strap hinges. The latch was in wood. This end of the building also contains the shafts from a horse drawn cart (Plate 41).

Behind the firebox the heat was transferred to the heated chamber by means of a highly perforated brick tube (Plate 42) surmounted by a re-used millstone. This allowed the heat from the firebox to be distributed evenly through the heated chamber below the drying floor. The walls of this chamber slope inwards (Plate 43) which is also assumed to be a feature to allow the even distribution of heat to the drying floor.

On the first floor the first 2.9 m of the space is a standard wooden floor which was probably used for storage before the grain was spread over the drying floor. The floor of the drying chamber itself, has been removed (Plate 44), although the majority of the tiles which once covered the floor are stacked in the south western corner of the building. The tiles are 12" square (304.8 mm) and 1 7/8" thick (47.6 mm) with a pattern of small hole in a series of groups of nine forming lozenge's on its upper surface. (Plate 45). The underside shows each of the lozenge to be linked to a rectangular cell which tapers (Plate 46). The mixed colours of the inclusions within the clay used for the tiles would suggest they were made in Buckley. Their form would conform to the 9D/8+7Ax15=113 classification of Crew (2003, 2004) which is typical of the Buckley kilns. The tiles were supported a framework which in turn was supported by metal rods crossing the space, some of which survive. The two trusses supporting the roof are of simple forms with a high collar, however this roof is clearly a late modification as there are the remains of a removed principle rafter in the northern wall (Plate 44). The eastern wall of the corn dryer has partly collapsed in the north eastern corner. This would be where the chute to the mill itself was located and it is probably the failure of this feature which has caused the collapse.

Tucked behind one of the principle rafters in the roof was one of the tools which was used to spread the grain over the heated floor (Plates 48 and 49). This was a relatively simply made "pusher" consisting of a simple handle with a head nailed on the end. This head has a felt strip along its longest edge which presumably was designed to reduce scratching whilst moving the grain on the heated floor. Also on the first floor of the corn dryer is a set of wooden steps (Plate 50), these are not from the corn dryer itself, however, it is likely that they were originally from the "Dresser Range".

The Dresser Range

The "Dresser Range" extends the line of the wheel pit infilling the space between the mill range and the corn dryer. It is clearly of a later construction with a vertical joint between the gable end of the mill range and the northern elevation of the "Dresser Range". The range is constructed of coursed, sub-rectangular stone blocks which are distinctive from the stonework used for the mill range. There are three opening in the western gable end (Plate 51), two windows and the doorway, all with stone lintels. The first floor window and the door no longer have their fittings, however the ground floor window retains its wooden frame. Whilst the outer face is boarded, inside there is a metal transom dividing this window (Plate

52). The only opening in the northern elevation is adjacent to the division between this range and the mill range (Plate 53). It also has a stone lintel and its position would suggest it was designed to monitor the outfall from the waterwheel.

On the ground floor the range runs south and west from the Hurst frame (Plates 54 and 55), containing the two dresser machines and the lower lay shaft.

Access to the upper floor was by means of a short flight of wooden steps which are no longer in position. It is likely, however, that the flight of steps in the corn dryer (Plate 50) were originally from this range. Below the upper lay shaft, and adjacent to the access point for the stairs is a hatchway for the sack hoist (Plate 56). There is another opening in this floor, directly over the dresser machines on the ground floor (Plate 57). It is assumed that there were originally two hoppers above this opening which fed the dressers below.

There are a series of four, slate lined, niches in the southern wall of the range at eaves level (Plates 58 and 59), these are in two groups with three niches at the western end and a single niche at the eastern end. The functions of these niches is unknown.

Service Range

Two service buildings were attached to the eastern side of the mill range consisting of a stables directly attached to the mill range and a possible store on the eastern gable end of the stables. The stables (Plate 60) is constructed of coursed, sub-rectangular blocks similar to the dresser range suggesting it may have been built at a similar time. The range is covered by a slate roof, however, unlike the Corn Dryer this was not replaced and therefore has somewhat uneven slates and a ceramic ridge piece.

This single storied range has a cobbled floor (Plate 61) with a central drain running along the length of the building. There are a few fittings surviving within the stables, these consist of a wooden bench in the north western corner (Plate 62) and two wooden pegs on the western wall. One of these pegs holds a horse collar (Plate 63) whilst the other hold part of the harness from a cart (Plate 64).

The possible store was covered in vegetation at the time of the survey to such an extent that it was impossible to record anything other than the general size of the building.

The Mill Works

The water for the mill was extracted from the Afon Daron some 850 m to the east of the mill, running along a leat cut into the hillside. The 1888 Ordnance Survey Map (Figure 2) suggest that at one point there was a second pond, presumably for extra storage of water, approximately halfway towards the mill pond. Water was extracted from the millpond by means of a launder, however only the metal supports now survive (Plate 5). At the end of this launder was a penstock for controlling the flow of water to the waterwheel. The arm which controlled the penstock survives passing through the gable wall of the mill building (Plates 9 and 29) and had curved pegged board on the inside of the building to allow the penstock to open to a series of different positions.

Only the hub of the waterwheel survives (Plates 65 -67, Figures 9 and 10) consisting of the cast iron hub for an eight spoke wheel. Each of the spokes was 0.14 m square and was of wood. One of these survives to a length of 1.35 m, however it is likely that the waterwheel was originally up to 4.8 m (15' 9") in diameter. It is likely that other fittings from the

waterwheel survive in the silted up wheel pit. Whilst the remains would suggest an overshot wheel an historic photograph (Plate 68) shows it to have been a pitch-back wheel. The wheel is held in place on the main axle by means of a series of metal wedges.

The axle has a bearing supported by a stone wall at its northern end, unfortunately the top cap of this bearing block is now missing. The axle is of cast iron with a square profile 0.19 m (7 ½”) square. It is 2.93 m (9’ 7”) long, passing through the wall of the mill building. Inside the mill, is the pit wheel which is 2.02 m (6’ 7½”) in diameter with eight spokes. It is of cast iron construction with 100 teeth set at an angle (Plate 69). Once again the pit wheel is held in place by a series of iron wedges. The axle is then supported by a second bearing block which is mounted in a wooden support. This also holds the toe pot for the main shaft (Plate 70).

The pit wheel engages with the wallower (Plate 71, Figure 11) which is 1.07 m (3’ 6”) in diameter with eight spokes and 56 teeth. The interaction between the pit wheel and the wallower transfers the drive from the vertical action of the waterwheel to the horizontal plane of the gearwheels attached to the main shaft. Mounted immediately above the wallower is the great spur wheel (Plate 72, Figure 11). A cast iron wheel, 2.12 m (7’) in diameter with eight spokes and 109 teeth mounted on the edge of the wheel. The wheel is so large that the Hurst Frame had to be modified to allow it to fit at one point (Plate 73). The great spur wheel is unusual as it also has teeth mounted on its upper surface to form a crown ring, also with 109 teeth. A more usual arrangement would be for a crown wheel to be mounted further up the main shaft on the stone floor where it could drive the lay shaft. At Aberdaron, however, all of the main drive train is housed below the stone floor with a lower lay shaft running from the crown ring on the great spur wheel into the dresser range.

Two stone nuts (Plates 74 and 75, Figure 12) engage with the edge ring of the great spur wheel to transfer the power to the stone on the stone floor above by means of the quants. Each of the stone-nuts are 0.38 m (1’ 3”) in diameter with protruding teeth which are inserted into the cast iron hub. There are a series of eyes on the upper surface of each of the stone nuts which interact with a retaining latch (Plate 76) stopping the stone nuts and therefore the runner stone from moving when not in use. The stone nuts are mounted on large timber bulks by means of toe pots. The timbers form part of the tenting mechanism for the stone to allow the adjustment of the distance between the stones and to disengage the stone nuts. Slots in the uprights of the Hurst Frame allow the beam holding the stone nuts to be moved up and down with fine adjustment being by the use of the screw fitting on one end of the beam (Plate 76) and the cam (Plate 77) worked by one of the long wooden handles on the Hurst Frame (Plate 78).

The quants pass through bed stones and drive the upper (runner stones). The stones are held within octagonal tuns on which are mounted the horses (Plate 24). The horses support both the hopper and the slipper (Plate 79). The slipper only survives *in situ* on the western stones, however the slipper to the eastern stones is likely to be that on the ground floor of the mill range (Plate 19). The end of the slipper was moved by the damsel which is attached to the top of the quant. Once again that in the eastern stones is missing, but is probably resting on the ground floor at the eastern end of the Hurst Frame (Plate 80). The flour from the stones was retained by the tuns and then ran through spouts into troughs on the ground floor. Whilst the wooden spout (Plate 81) and the trough for the eastern stones survive, the spout for the western stones has been replaced by a crude metal tube which has been reinforced with tin cans (Plate 82) and the trough has been moved to sit within the other trough

The ancillary machinery for the mill was powered from one of the lay shafts. The lower lay shaft (Figure 13) had a gear wheel which engaged with the crown ring on the top of the great spur wheel, this is now missing. The shaft is supported at its eastern end by a phosphor bronze bearing mounted on one of the supports for the Hurst Frame (Plate 83). There is one wooden pulley inside the Hurst Frame and two other wheels within the Dresser Range. The wheel within the Hurst Frame is 0.51 m (1' 8") in diameter and 102 mm (4") thick (Plate 84). This was linked to a fan below the Hurst Frame. The lay shaft passes through the wall of the Hurst Frame and a second bearing before it has a second wheel attached (Plate 85). This is of a similar size to that within the Hurst Frame and has a leather belt around the wheel which links it to the upper lay shaft. There is then a third bearing support for the lay shaft. At the western end of the lay shaft is a larger wheel which is 0.71 m (2' 4") in diameter and 0.3 m (1') thick with crossed spokes (Plate 86). This wheel drove the dresser machines by means of a leather drive belt.

The pulley wheel within the Hurst Frame was used to drive a shaft at ground level within the Hurst Frame (Plate 87) by means of a belt to a wooden wheel. Tensioning on the belt was carried out with a wooden slide attached to the Hurst Frame (Plates 88 and 89). The shaft drove a fan below the Hurst Frame by means of two iron gear wheels (Plate 90). The fan (Plate 91) is 1.83 m (6') long and consists of four wooden paddles each with a felt strip attached to edge. This is an unusual feature and presumably was used to increase ventilation through the gear train and to cool the works.

Two dresser machines occupy the northern wall of the "Dresser Range". Whilst similar in design there are differences between these two machines. The western machine (Plate 92) has a trough below the whole length of the sloping tube whilst the eastern machine has a funnel like structure (Plate 93). It is likely that the western machine may be a grain dresser designed to remove any dirt and stones from the grain before milling, whilst the eastern machine is a flour dresser for separating the meal into flour and bran. The eastern dresser is better preserved retaining its inclined wire sieve tube (Plate 94) and internal brushes (Plate 95) whilst only two of the brushes survive in the western dresser and the wire tube is missing. It is also likely that the wooden frames recorded in the mill building (Plate 16) are also from this machine.

The upper lay shaft (Figure 14) is driven by means of a leather belt from the lower lay shaft. This belt runs in a wooden protective channel (Plate 96) and then over a pulley wheel with clapsed spokes. This wheel is 1.06 m (3' 6") in diameter and 0.15 m (6") thick (Plate 97). This axle for this wheel runs along the line of the "Dresser Range" and to a point where it is supported by one of the purlins to the mill range. It acted as a sack hoist in two places. Within the "Dresser Range" the shaft is worn above the hatch in this range (Plate 98) and at the eastern end it is reinforced with iron sheeting (Plate 99) which is likely to be the position of the drive for the sack hoist in the mill building. This position is not above the hatch in the mill, however worn slots in the western principle rafter (Plate 27) would suggest a rope or wire ran from the shaft to an iron ring above the hatch (Plate 26) via a pulley wheel (Plate 100) attached to one of the purlins.

Graffiti

There is graffiti in various places thorough out the mill complex, these include a number of dates and the depictions of both ships and cats. The ceiling beam crossing the mill range has graffiti on both its northern and southern surfaces. To the south (Plate 101) the beam has the initials "RR" stamped into the beam together with the date 1903 written in pencil. On the

northern face the figure “38” is stamped into the wood upside down. This presumably relates to the previous use of the timber or is a lot number for its sale.

The eastern end of the Hurst frame would appear to be a concentration of the graffiti presumably representing a convenient surface for taking notes (Plate 103). Amongst the somewhat worn graffiti two dates can be determined 1851 (Plate 104) and 1881 (Plate 105), both in pencil. There is also a clear “E” and a signature adjacent to the 1881 date (Plate 105). This area also the remains of an official record sheet for the 1901 Factories and Works Act recording the hours worked by the employees (Plate 106).

A notable feature of the mill is the three ships representations on the trusses of the mill range. On Truss 1 there is the poker work representation of a two masted schooner with a single square rigged topsail (Kilgour, 2008, 109) (Plate 107). On the western leaf of the Truss 2 there is the simplistic representation of a single funnelled steam ship (Plate 108) also in pokerwork. On the eastern leg of the truss, however is the scratched representation of a two masted brig (Kilgour 2008, 128-131) (Plate 109, Figure 16). This is a square rigged vessel and the apparent representation of guns would suggest a naval vessel. This vessel was scratched on a timber which already had the date “1851” stamped into its structure (Plate 110) suggesting it is from the second half of the nineteenth century. Also within this area are two pokerwork representations of cats (Plate 110).

Conclusions

The mill complex at Aberdaron has clearly developed overtime (Figure 17) the initial building ran at right angles to the wheel pit suggesting that it is contemporary with, or later than, the mill pond and leat system. This building is unlike the typical 18th and 19th century mill building being only two storeys high. It is possible that it was originally designed for a shaft drive mechanism which would allow the driving of a single set of stones. It is therefore possible that the original building may be 18th century or earlier in date. Throughout the medieval period and up to the early 18th century a corn mill consisted of a water wheel driving a single pair of stones. The gearing necessary to allow several pairs of stones to be powered from the one wheel was not developed until the late seventeenth century, and is unlikely to have reached or the Lleyn much before 1725 - 1750 (Davidson 2001).

Phase 2 saw the addition of the corn dryer range to the complex, although it is probable that the corn dryer itself relates to the major reorganisation in Phase 3. The Aberdaron Tithe map (Figure 18) would suggest there was a range on the western side of the mill prior to 1841, however the Cefn Amwlch estate map of 1812 only shows the mill range, thereby suggesting a possible date range for the construction of the building which was later converted into the corn dryer..

The major reorganisation of the complex includes the construction of the “Dresser Range”, the stables and store, the conversion of the western range to the corn dryer and the insertion of the current gear train. The date of this phase is uncertain, however, the report of a legal case in the Carnarvon and Denbigh Herald and North and South Wales Independent on 30th January 1864 may relate to this phase of works. The case concerns an action for non-payment for work associated with the erecting a mill at Aberdaron. This included trips to Caernarfon for castings, to Pwllheli to select timber and to Anglesey for millstones. The defendant was a Mr Williams. The 1861 Census (http://www.rhiw.com/census_1861/aberdaron_census_1861_01.htm) records the occupier of Cefn Nona (the plot containing the mill on the tithe map) as Griffith Williams and records his occupation as farmer and miller. There are also

three other people recorded as millers in the house, Hugh Williams, William Griffiths and John Griffiths. It would therefore seem highly likely that Phase 3 dates from the early 1860's.

The use of a pre-existing building meant that the drive train had to be fitted into the existing space, compressing the works into the ground floor space. This meant that the typical spur wheel drive would not fit and the crown drive which would typically be on the second floor on top of the main shaft could not be accommodated. Thus the great spur wheel has a crown ring on its upper surface which drove the lower lay shaft which in turn drove the upper lay shaft. Also unusual is the fan below the Hurst Frame which was possibly used to cool the works as they used all metal gear wheels.

The introduction of waterwheels made wholly or partly of cast iron often did not take place until the second half of the 19th century. The same applied to the use of iron gears and shaft as they relied on local foundries having the capacity to make a wheel of sufficient quality (Brown 2011, 132) and bevelled gears became standard in the second half of 19th century (Brown 2011, 133). Indeed the spur wheel drive itself did not become common until the late 18th century (Brown 2011, 89-90). These factors would also tend to conform to the 1860's date for the conversion of the mill to the current works.

The end of the use of the building as a mill is unknown, a newspaper article in the North Wales Chronicle and Advertiser for the Principality for 28th September 1917 suggests that "the old fashioned village mill had disappeared", however the use of tin cans as a repair to the chute from the western millstone would suggest that at least some work was being done, possibly into the post Second World War Period. If so this was likely to be only the grinding of animal feed.

The millstones within the complex all appear to be of Anglesey Gritstone. This is a conglomerate of sandstone and pebbles with outcrops to the west of Benllech and near Penmon on Anglesey (Guise and Lees 1992, 21 - 22). There were three main millstone quarries at Pen'rallt near Brynteg, Cors Goch near Llyn Cadarn and Blwch approximately 1 mile south of Bellech. (Guise and Lees 1992, 22), with the largest quarry being at Pen'rallt. Quarrying on Anglesey started before 1302 (Guise and Lees 1992, 21) and continued until just before the First World War although the decline took place over the previous 50 years (Guise and Lees 1992, 23)

Boulton and Watt at the end of the 18th century reckoned that a pair of millstones could grind 8 bushels of wheat an hour and would require 8hp to drive the stones and associated machinery. They later revised their estimates down to 6 bushels/hour (Brown 2011, 32). From insurance assessments of the period 1816 – 1820 the average power of water corn mills in England and Wales was 14.5hp. Over 70% of the mills within England and Wales had no more than 2 or 3 pairs of stone generating less than 12hp. In the second half of the 18th century Smeaton demonstrated the efficiency of overshot wheels was about 66% working more efficiently at low speeds of 3 ½ feet/second at the circumference, however, typically water wheel operated at 6 feet/second (Brown 2011, 89-90)

Rotary cleaner, similar to the flour dressers also did not become common in mills until the 19th century (Watts 2008, 25). They occurred in three main type (Watts 2008, 39-42), the "Bolter" where ground meal was fed into cylindrical cloth sleeve which was rotated and knocked against fixed bars, the "Wire Machine" "which was patented in 1765 by John Milne) had meal fed into the top of the inclined cylinder which was brushed against wire cloth and the "Reel" which was not adopted in English mills until the mid 19th century. It was generally

polygonal in form and up to 28 feet in length. Those at Melin Aberdaron, therefore are best described as wire machines.

Grain drying kilns are known to be associated with corn mills from the 17th century (Watts 2008, 26). They were once commonly found beside mills in upland Britain where the climate tends to be damper. Their function was to reduce the moisture content of the grain to between 12 and 16% and also to lower the moisture content of oats so that the husks became brittle and could be shelled (Watts 2008, 27). Tiles used in the Melin Aberdaron corn dryer are typical of those made at Buckley (Crew 2003, 2004) in the 19th century although the insertion of an oven into the corn dryer is somewhat unusual. The corn dryer in Wales were typically heated with wood, as fuel, which was sometimes the responsibility of the customer who carried the grain to the mill. (Watts 2008, 28). Another unusual feature is the spout linking the corn dryer to the mill range.

It is possible to follow the course of the grain through the building as it was processed. The wet grain was loaded into the western end of the upper floor of the corn dryer through the gable end door. It was then spread over the heated floor for drying. The dry grain was fed through the spout into ground floor of the mill building, probably into sacks. It is likely that the dried grain was then hoisted, through the hatch in the “Dresser Range” and poured into a hopper above the western dresser machine. This separated the grain from any stones or dirt with the grain collecting in a sack at the western end of the machine. The cleaned grain was then hoisted through the hatch in the mill building and fed into the hoppers above the stones. The ground meal collected around the inner side of the tuns and was transported to the troughs on the ground floor by wooden chutes. The meal was then hoisted through the hatch in the “Dresser Range”, again, and fed into the eastern dresser which separated the flour from the bran.

Whilst the recording of the mill has record the majority of the feature of the mill it was not possible to record the store in any detail and it is likely that parts of the waterwheel are buried in the silted wheel pit. It is therefore recommended that these feature are recorded when they become available. The tail race has also been lost and it is therefore recommended that an archaeological watching brief takes place on any ground works undertaken to record this or any other features which may exist.

Acknowledgements

This report was commissioned by Mark Roberts for the owner Geraint Jones. Their support for this project is gratefully acknowledged. Dr. D. Gwyn carried out the desktop study and was freely available to discuss some of the features of the mill.

References

- Anon. 1864 County Courts, Before J. E. Davis. esq, Deputy Judge. Pwllheli. *Carnarvon and Denbigh Herald and North and South Wales Independent* 30th January 1864
- Anon 1917. North Wales Traders’ Grievance. Hard Hit by Food Control Regulations. Large Retail Shops Closed. *North Wales Chronicle and Advertiser for the Principality* 28th September 1917
- Brown, J. 2011. *Water Power and Watermills*. The Crowood Press Ltd. Marlborough, Wiltshire.

- Crew, P. 2003. *A catalogue of perforated tiles from grain drying kilns and malting kilns (version 6, 2003)*. Plas Tan y Bwlch
- Crew, P. 2004. Perforated tiles from corn dryers and malting kilns. *British Brick Information* 95, 4 – 12.
- Davidson, A. 2001. *The Medieval Mills of Anglesey. Archaeological Threat Related Assessment (G1591)*. Gwynedd Archaeological Trust Report No. 405
- Ellis, M. (ed.) 1978. *Water and Wind Mills in Hampshire and the Isle of Wight*. Southampton University Industrial Archaeology Group.
- Guise, B. and Lees, G. 1992. *Windmills of Anglesey*. Attic Books
- Gwyn, D. 2015. Melin Aberdaron Archaeological Assessment. *Govannon Report GC378a*
- Kilgour, O.F.G. 2008. *Caernarfonshire Sail*. Gwasg Carreg Gwalch, Llanrwst.
- Vince, J. 1993. *Watermills and how they work*. Sorbus,
- Watts, M. 2008. *Corn Milling*. Shire Library
- <http://cynefin.archiveswales.org.uk>
- <http://www.oldmapsonline.org>
- <http://www.rhiw.com>

Glossary

Bed Stone: The lower (fixed) of the grind stones

Crown Wheel: A gear wheel on the main shaft with teeth on its upper surface to transfer the drive to the horizontal plane to work any ancillary machinery

Damsel: A device set in the top of the Runner Stone to agitate the Slipper ensuring a constant flow of grain into the eye of the stones.

Flour Dresser: A machine which cleans the flour to give higher grade of flour

Great Spur Wheel: A large diameter wheel set on the main shaft which allows for one, or more, drives to be taken off to drive the mill stones

Horse: A wooden framework supporting the hopper above the stones.

Hurst Frame: A heavy wooden frame supporting both the mill stones and the gear train.

Lay Shaft: A horizontally mounted drive shaft. Gearing from the shaft takes the drive to individual machines

Launder: An artificial channel that brings water overhead to an overshot waterwheel.

Main Shaft: A vertical shaft linking the Wallower and Great Spur Wheel

Meal Spout: Wooden tube from the stones to a point where the meal can be collected.

Overshot Wheel: A vertically mounted waterwheel fed from above, the water falling into a bucket, to turn the wheel by gravity. The wheel is driven in a clockwise direction.

Penstock: A sluice gate to release the water from the launder onto the wheel and control the rate of water release

Pitch-back Wheel: A waterwheel with the water entering at the top, but driving the wheel in an anti-clockwise direction.

Pit Wheel: A large, vertically set, gear wheel set on the same axle as the waterwheel. Half of the wheel is within a pit below the floor, hence the name.

Runner Stone: The upper (moving) of the grind stones

Quant: A “T” shaped bar transferring the drive from the Stone Nut to the Runner Stone

Slipper: A wooden shoot guiding the grain from the hopper into the eye of the stones

Stone Nut: A gear wheel engaging with the Great Spur Wheel transferring the drive to the mill stones

Tail Race: An artificial channel taking the water from the wheel back to the river

Tentering: A method of adjusting the separation between the Bed Stone and the Runner Stone

Toe Pot: A bearing for a vertical shaft such as that at the base of the Main shaft

Tun: The removable wooden casing round the stones

Wallower: A smaller gear on the main shaft, engaging with the pit wheel transferring the power from the horizontal plane to the vertical

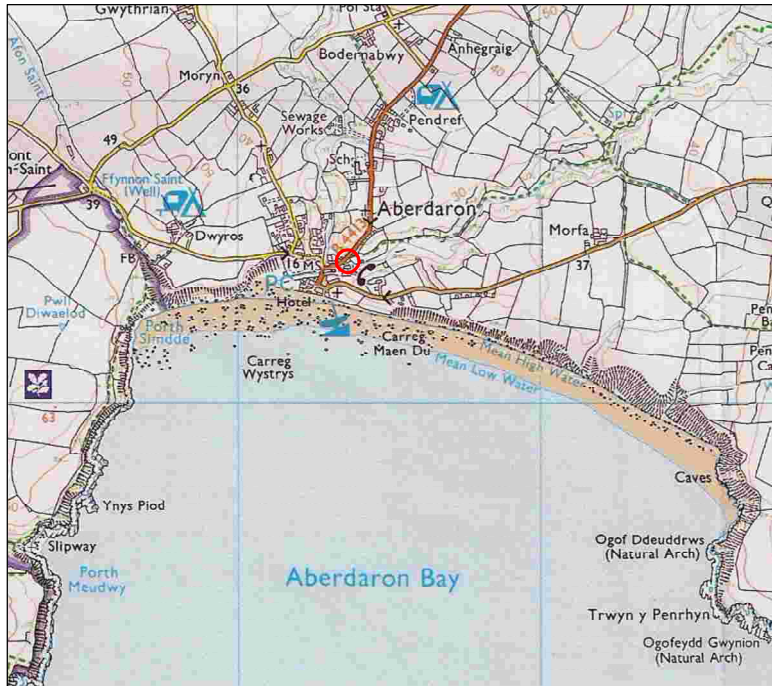

Figure 1: Location
Scale 1:25,000

Reproduced from the Explorer 253, 1:25,000 scale map
by permission of the Ordnance Survey ® on behalf of
The Controller of Her Majesty's Stationary Office
© Crown Copyright 2002
All Rights Reserved Licence Number AL 100014722



1888



1901

Figure 2: Extracts from the 1888 and 1901 1:10560 Ordnance Survey Maps, Caernarvonshire XLIII. SE
Not to Scale

Sources: <http://www.oldmapsonline.org>

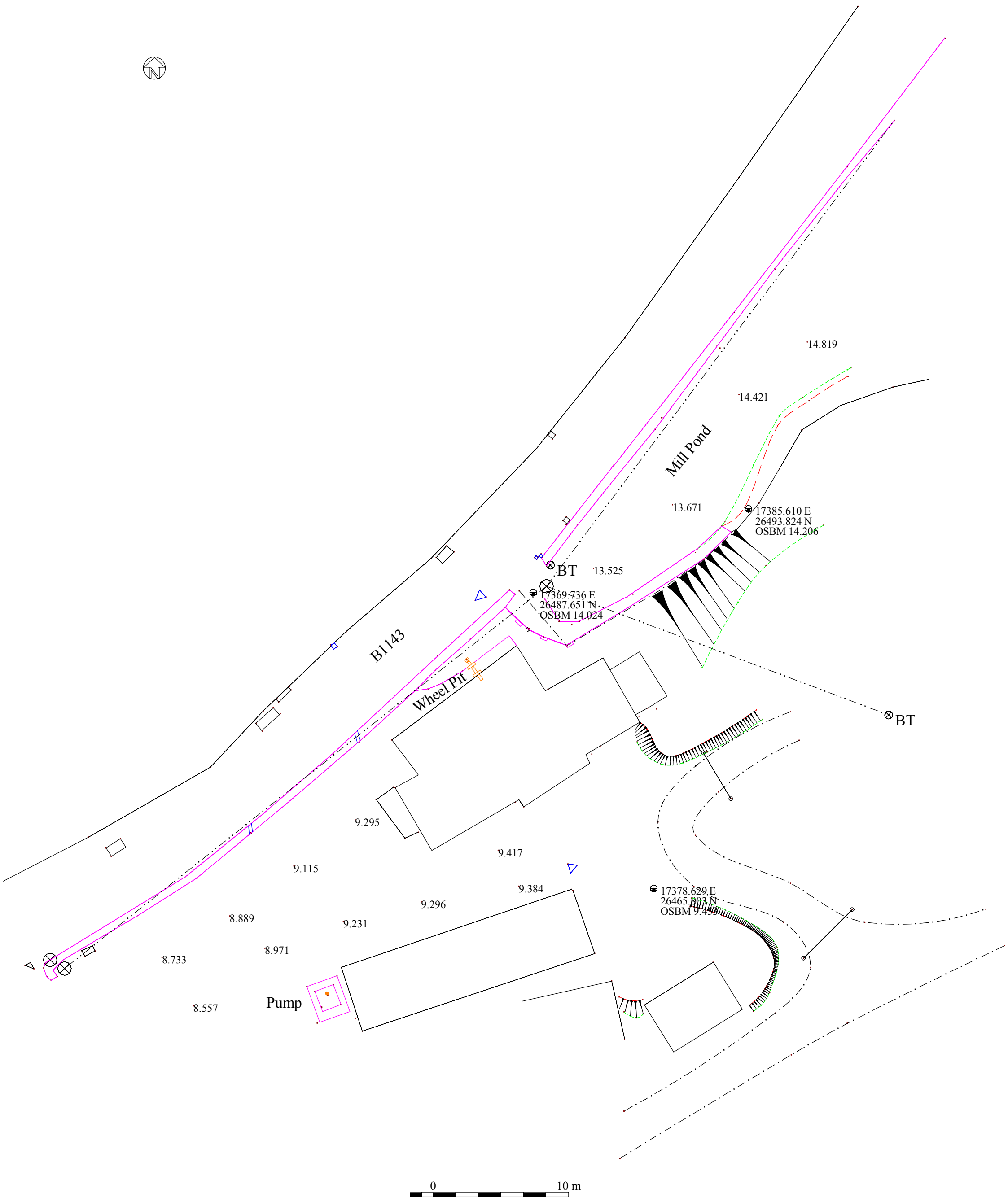

Figure 3: Topographic Survey
Scale 1:250

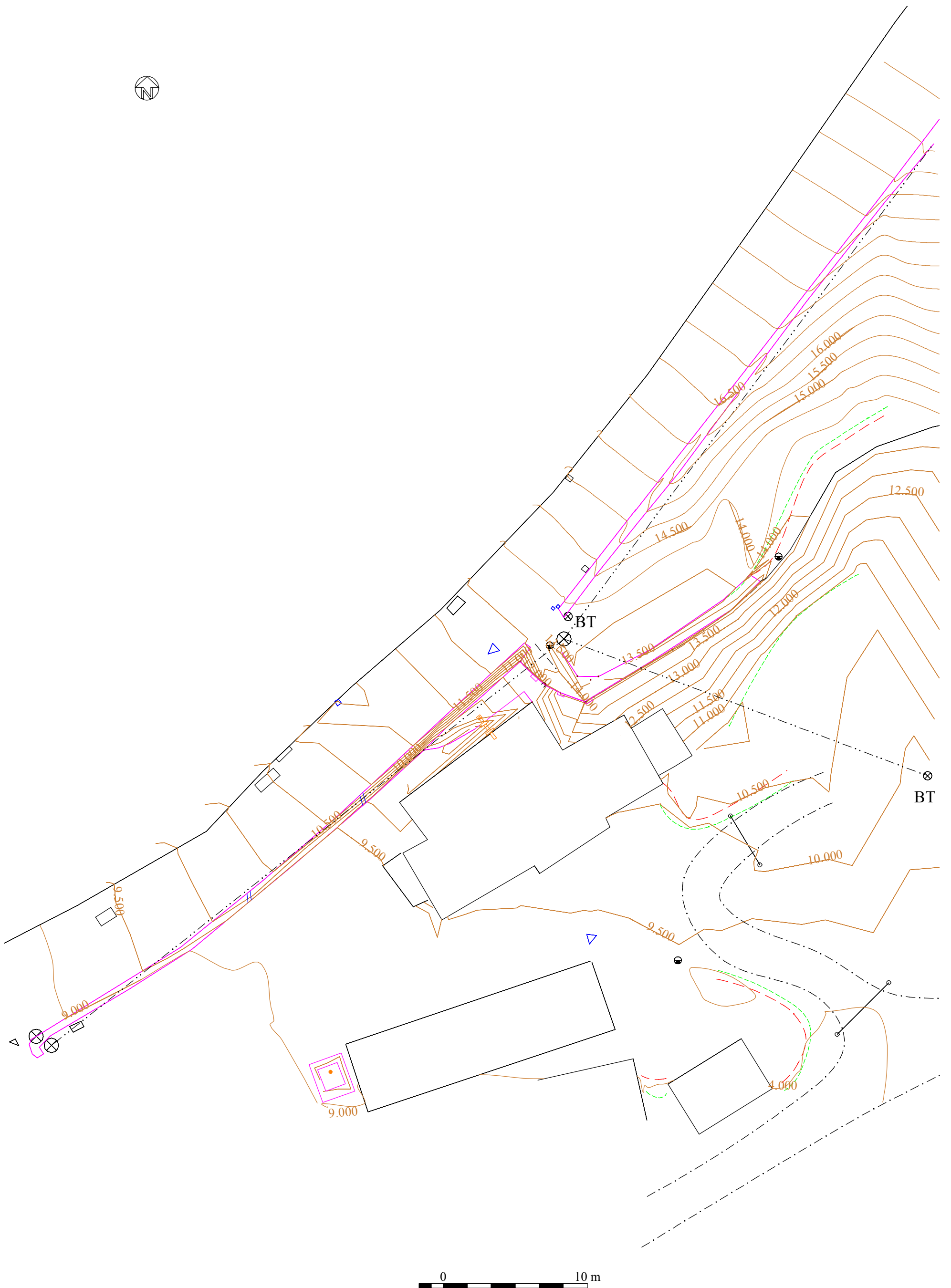

Figure 4: Contour Survey
Scale 1:250

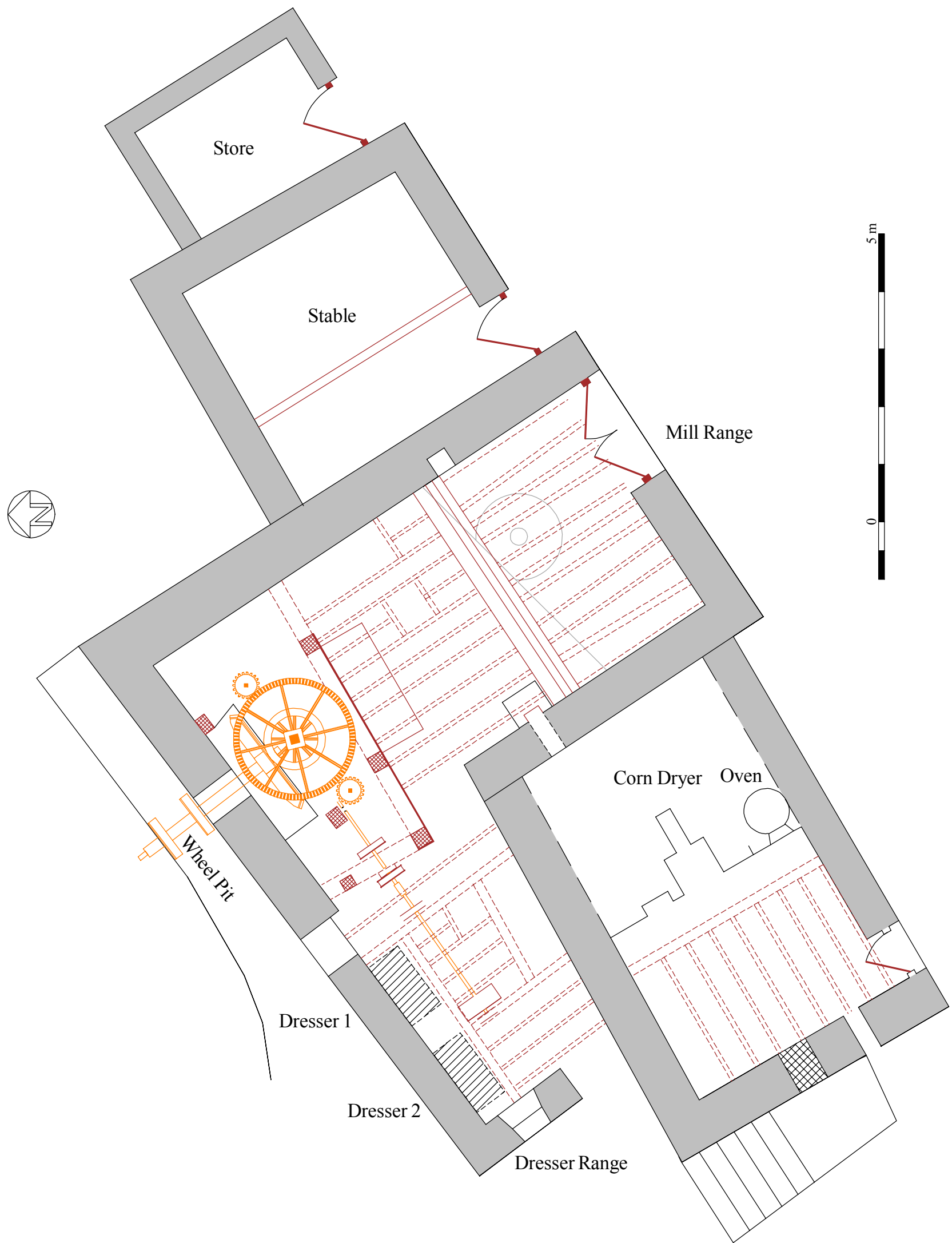

Figure 5: Ground Floor Plan
Scale 1:75



Figure 6: First Floor Plan
Scale 1:75

NE

SW

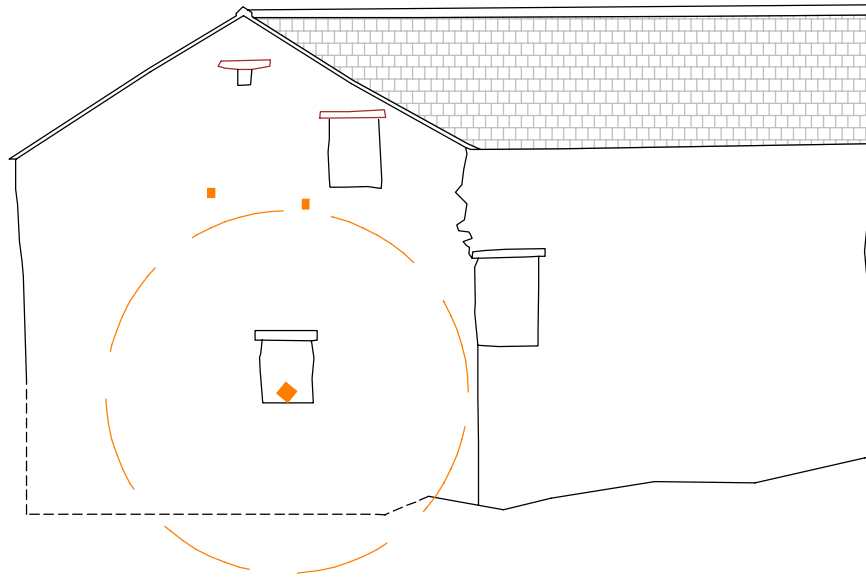

NW

SE

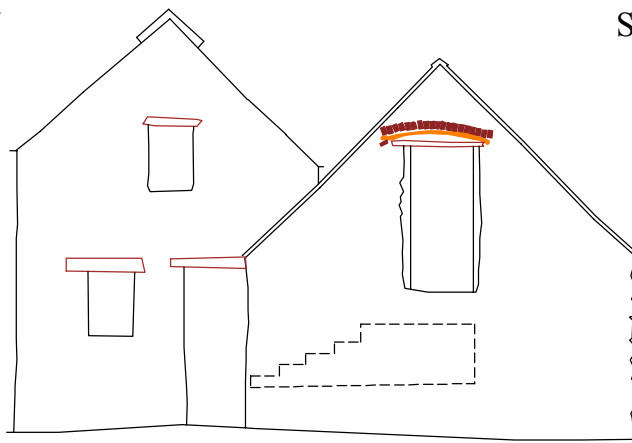

SW

NE

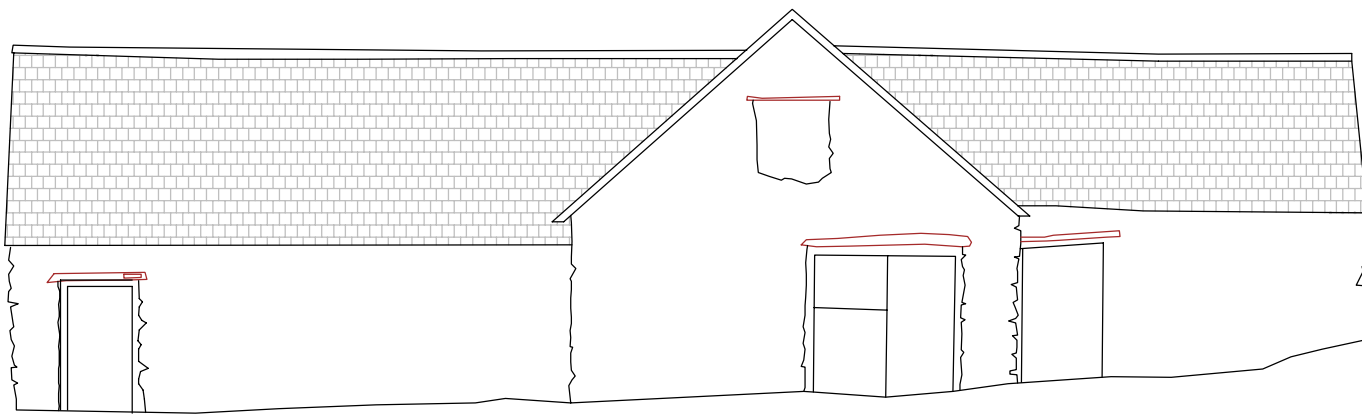

Figure 7: Elevations
Scale 1:100

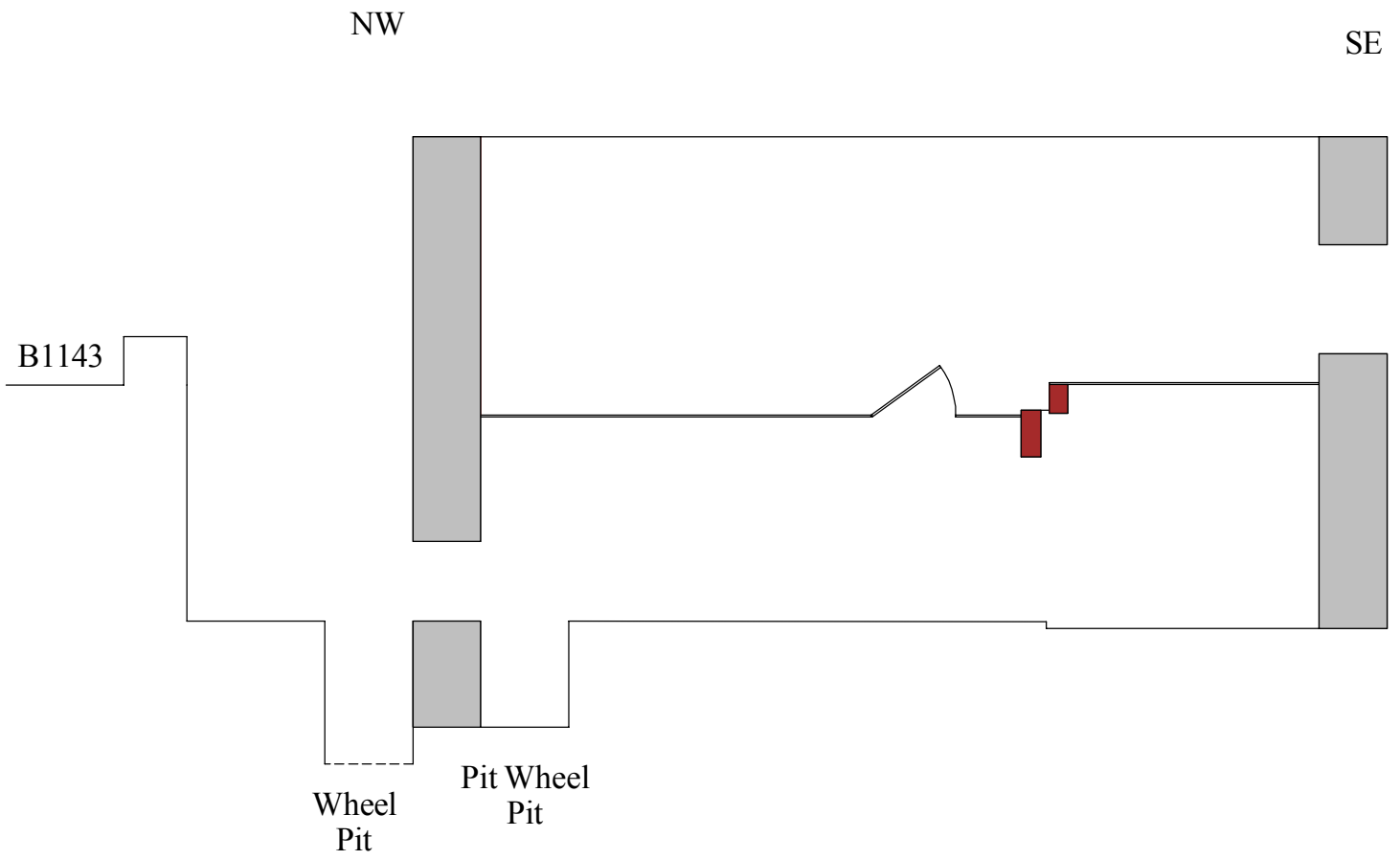

Figure 8: Profile Through the Mill
Scale 1:75

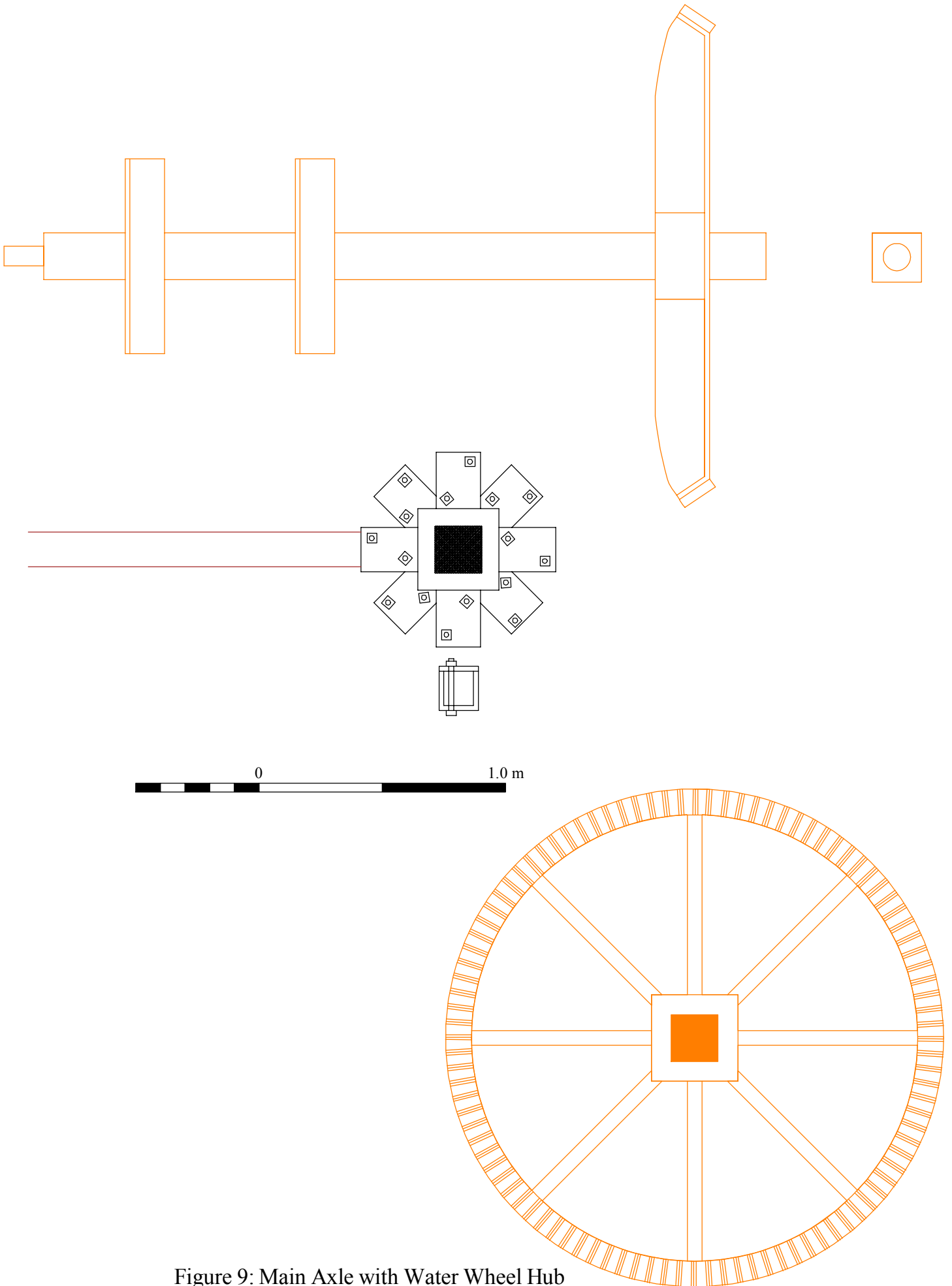

Figure 9: Main Axle with Water Wheel Hub
and Pit Wheel
Scale 1:20

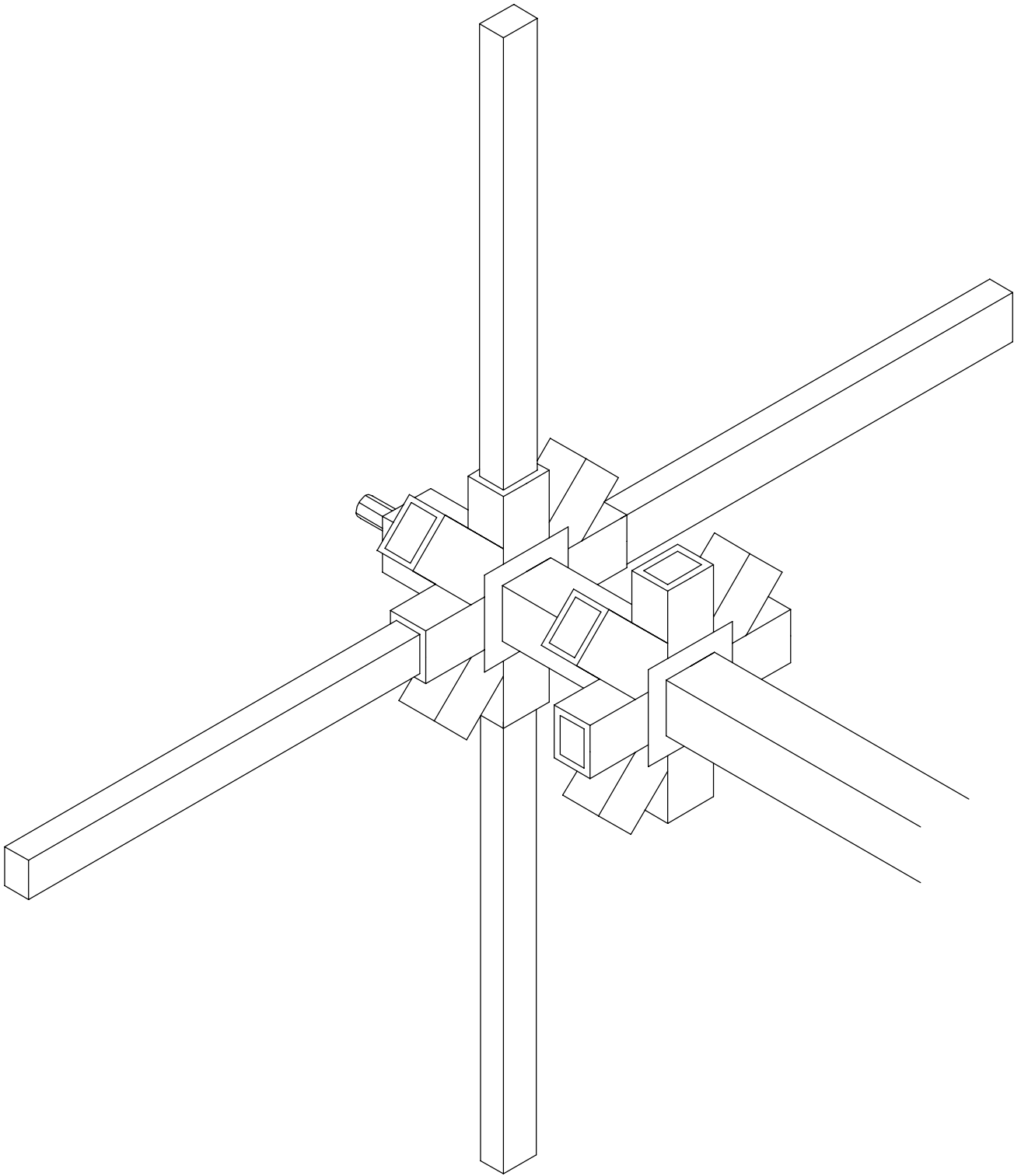
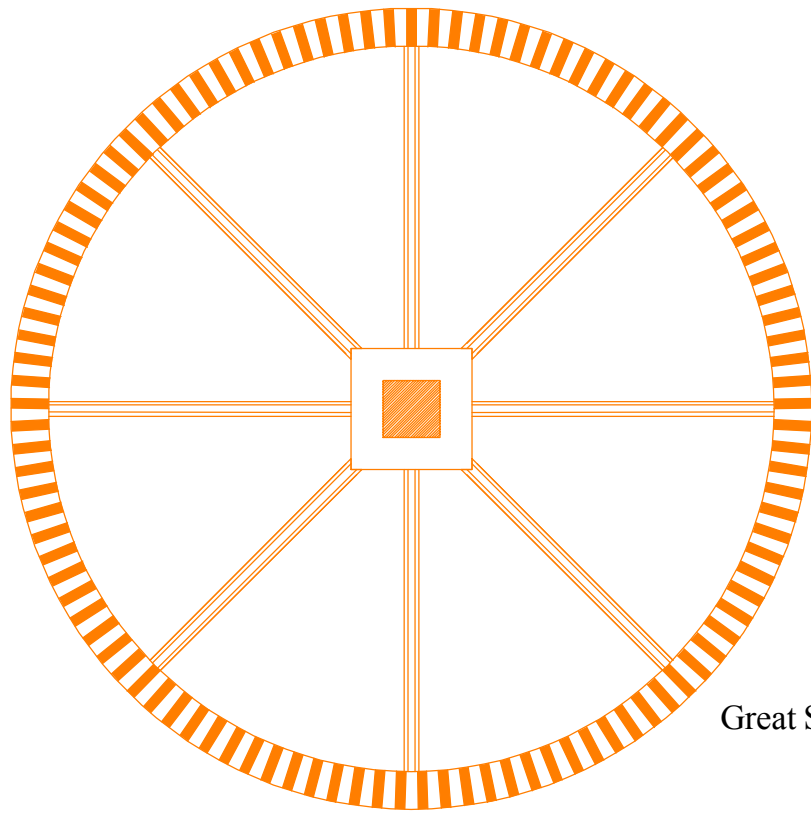
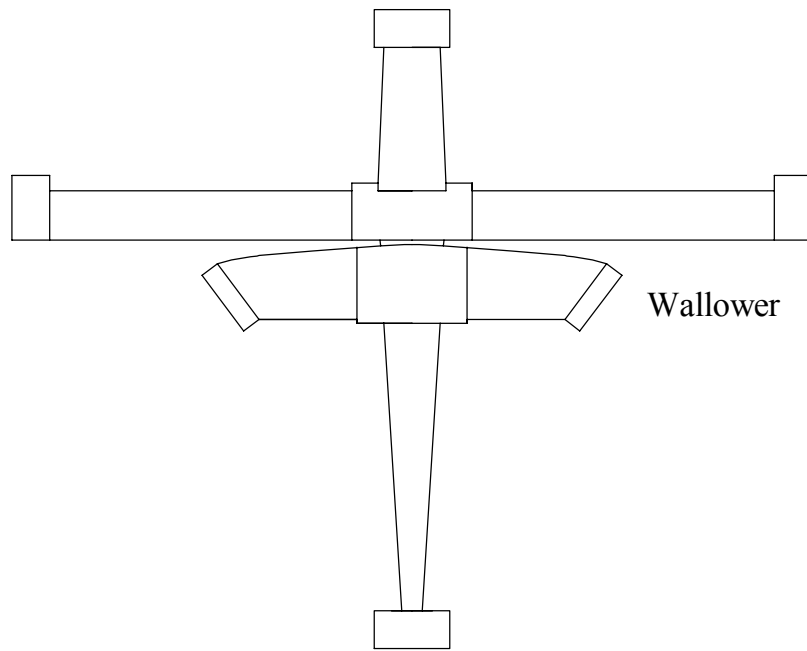

Figure 10: Isometric projection of the
Water Wheel Hub
Scale 1:20



Great Spur Wheel



Great Spur Wheel

Wallower

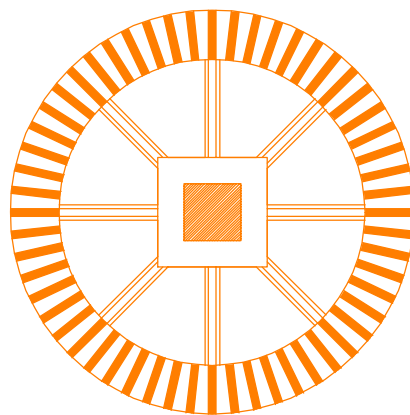

Wallower



Figure 11: Drive Shaft, Wallower and Great Spur Wheel
Scale 1:20

Western Stone Nut

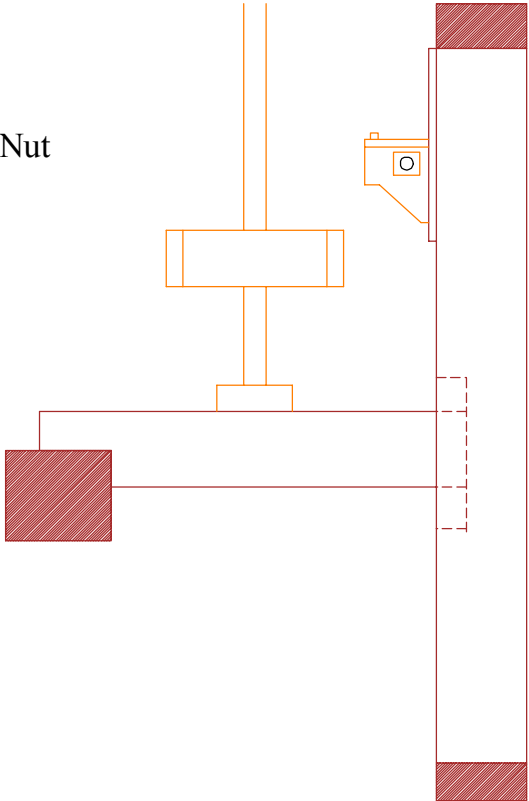
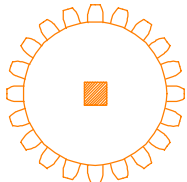

Eastern Stone Nut

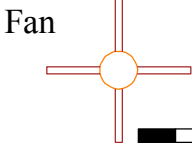
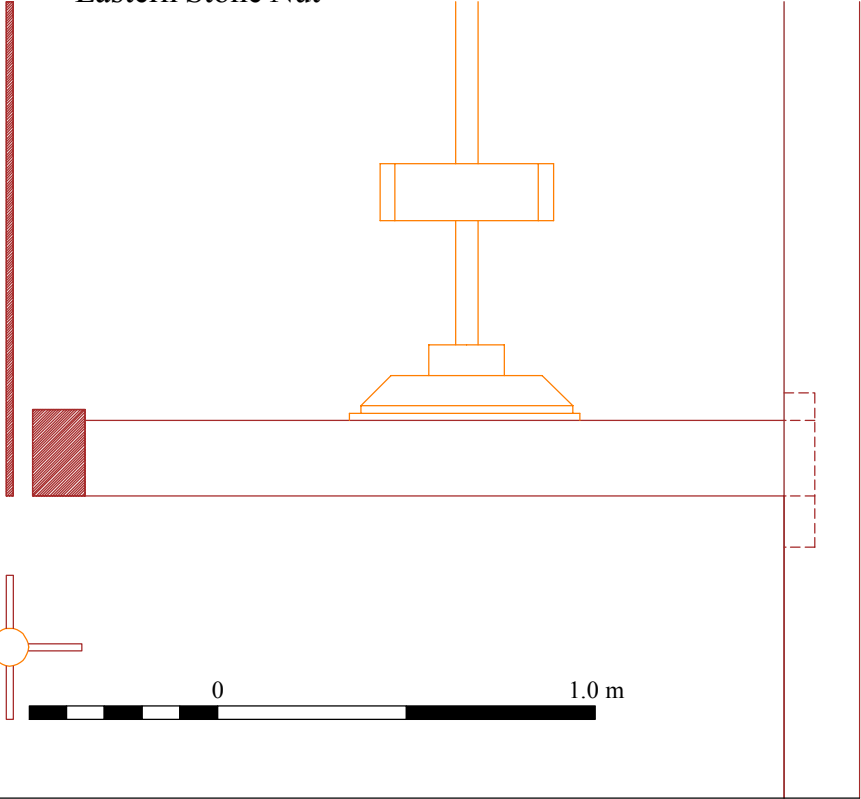
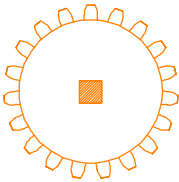

Figure 12: Stone Nuts
Scale 1:20

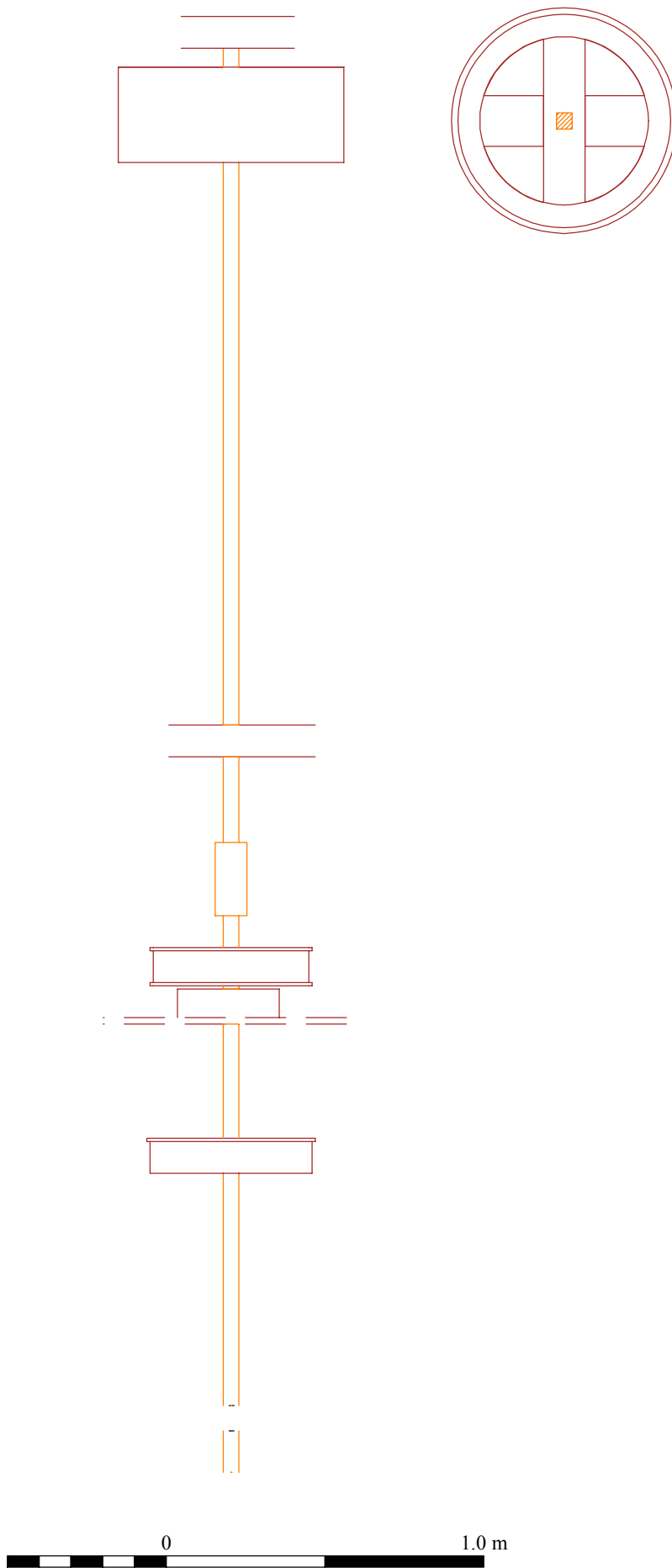

Figure 13: Lower Lay Shaft
Scale 1:20

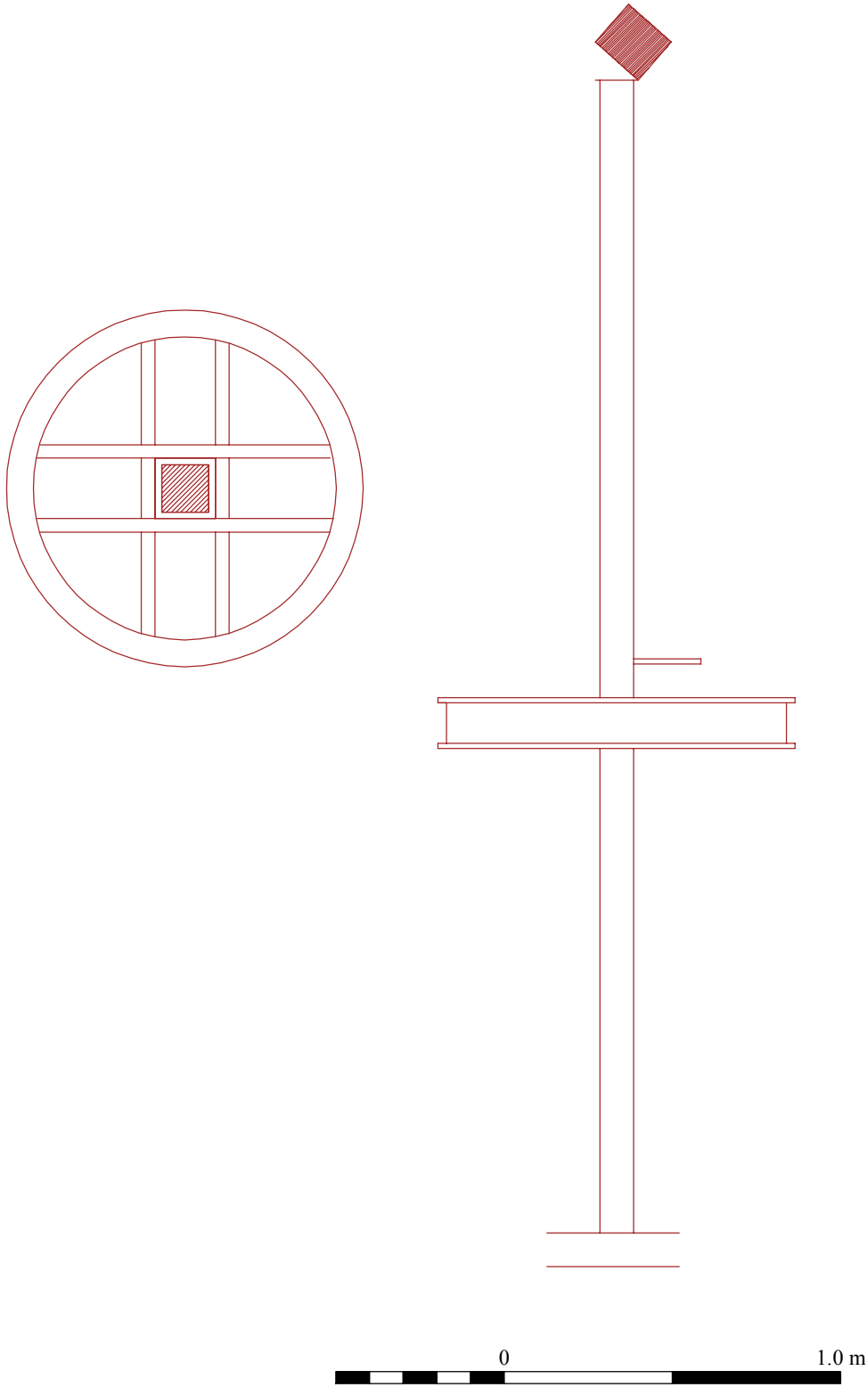

Figure 14: Upper Lay Shaft
Scale 1:20

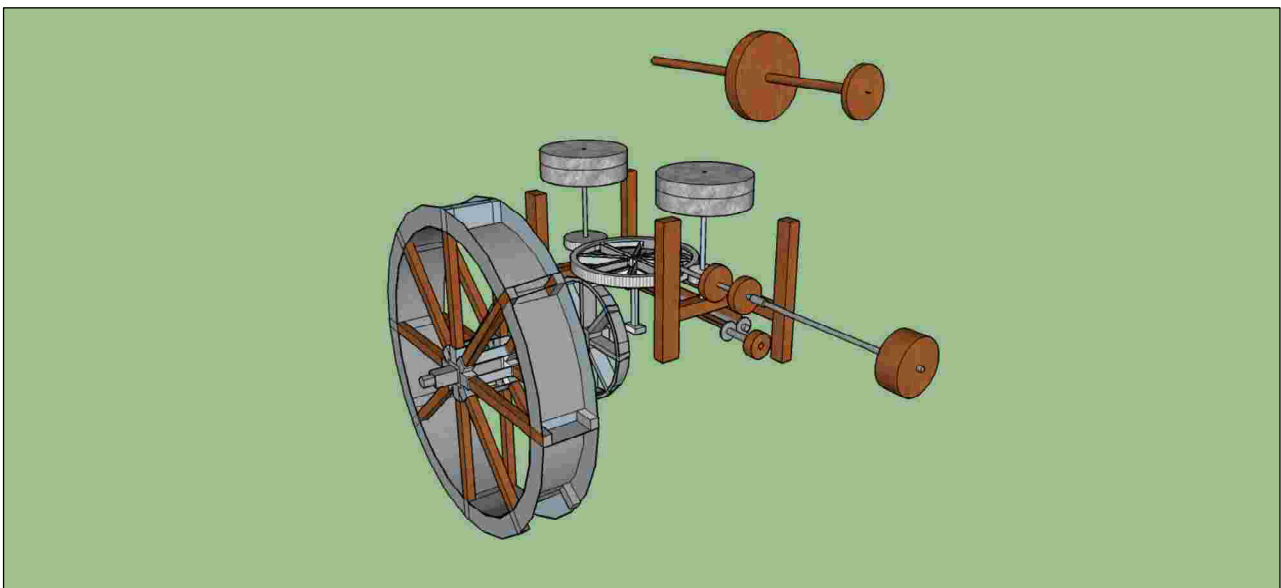
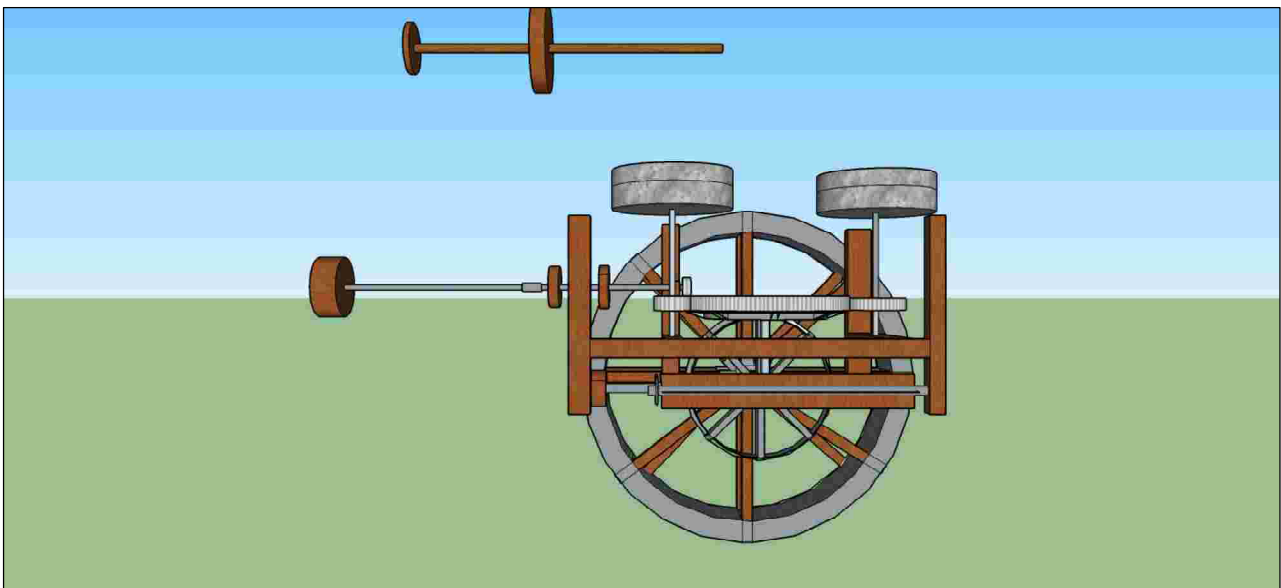
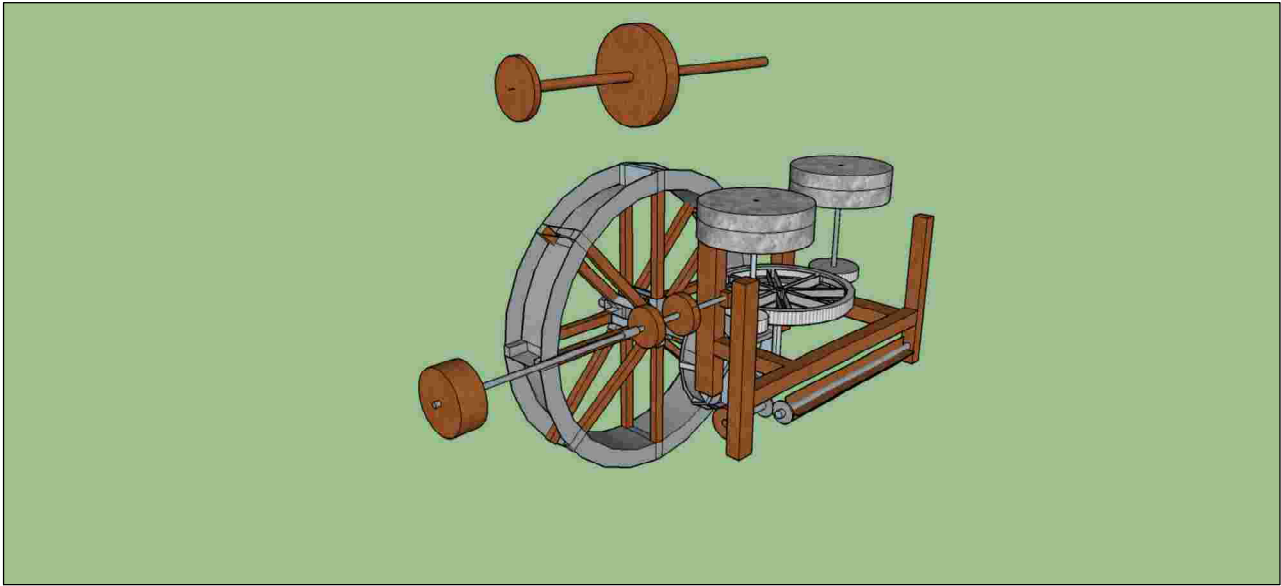

Figure 15: Reconstruction of the Works
Not to scale

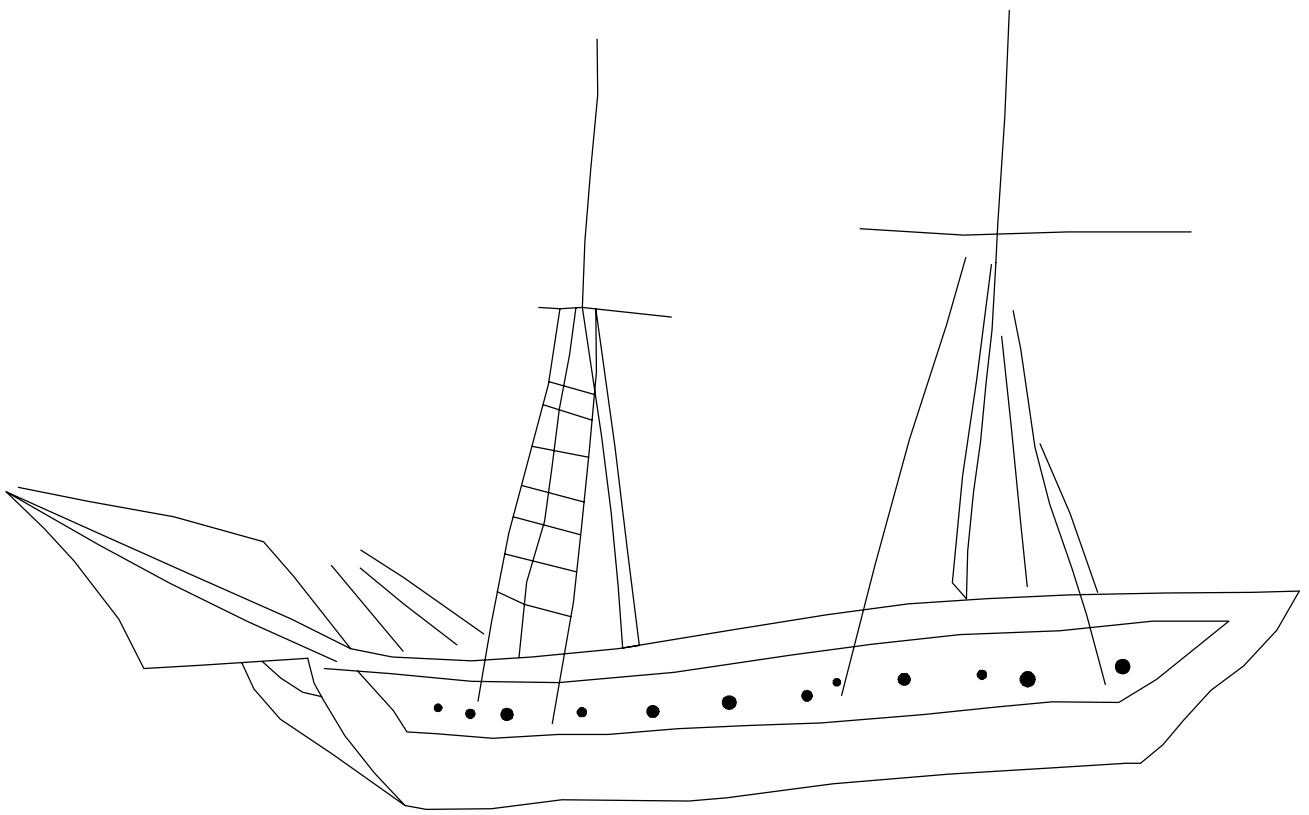
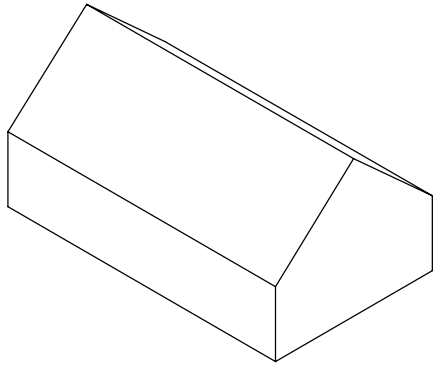
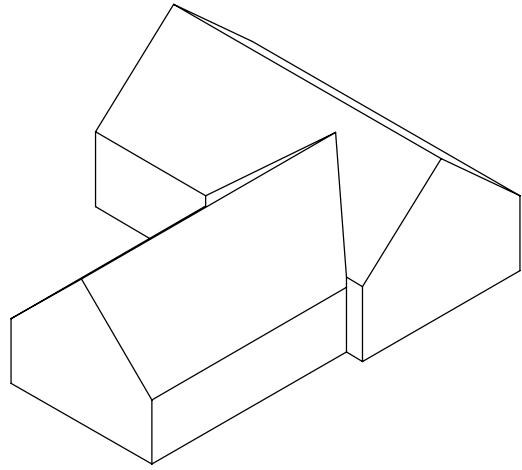

Figure 16: Tracing of the Scratched Ship
Scale 1:1



Phase 1



Phase 2

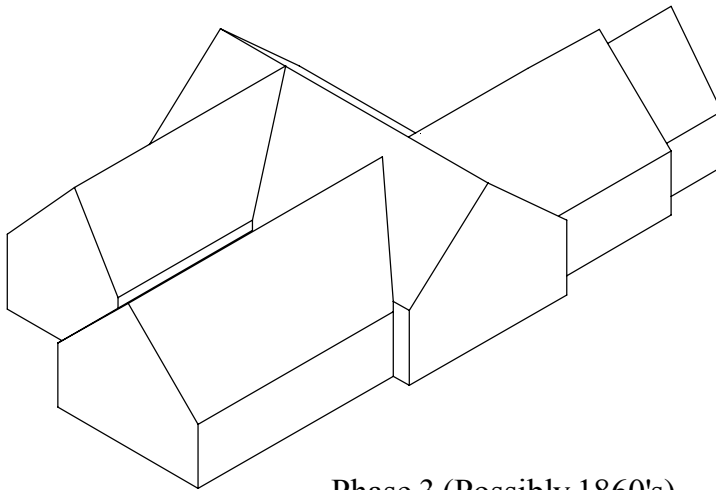

Phase 3 (Possibly 1860's)

Figure 17: Possible Development of the Buildings



Figure 18: Extract from the Aberdaron Tithe Map
Not to Scale

Source: <http://cynefin.archiveswales.org.uk/en/tithe-maps/visualize/#Aberdaron&/transcribe/926030863703/&/georeference/900987144074/&/visualize/900987144074&&/map/686389087271/>



Figure 18: Location of the Photographs in the Archive
 Ground Floor
 Scale 1:100

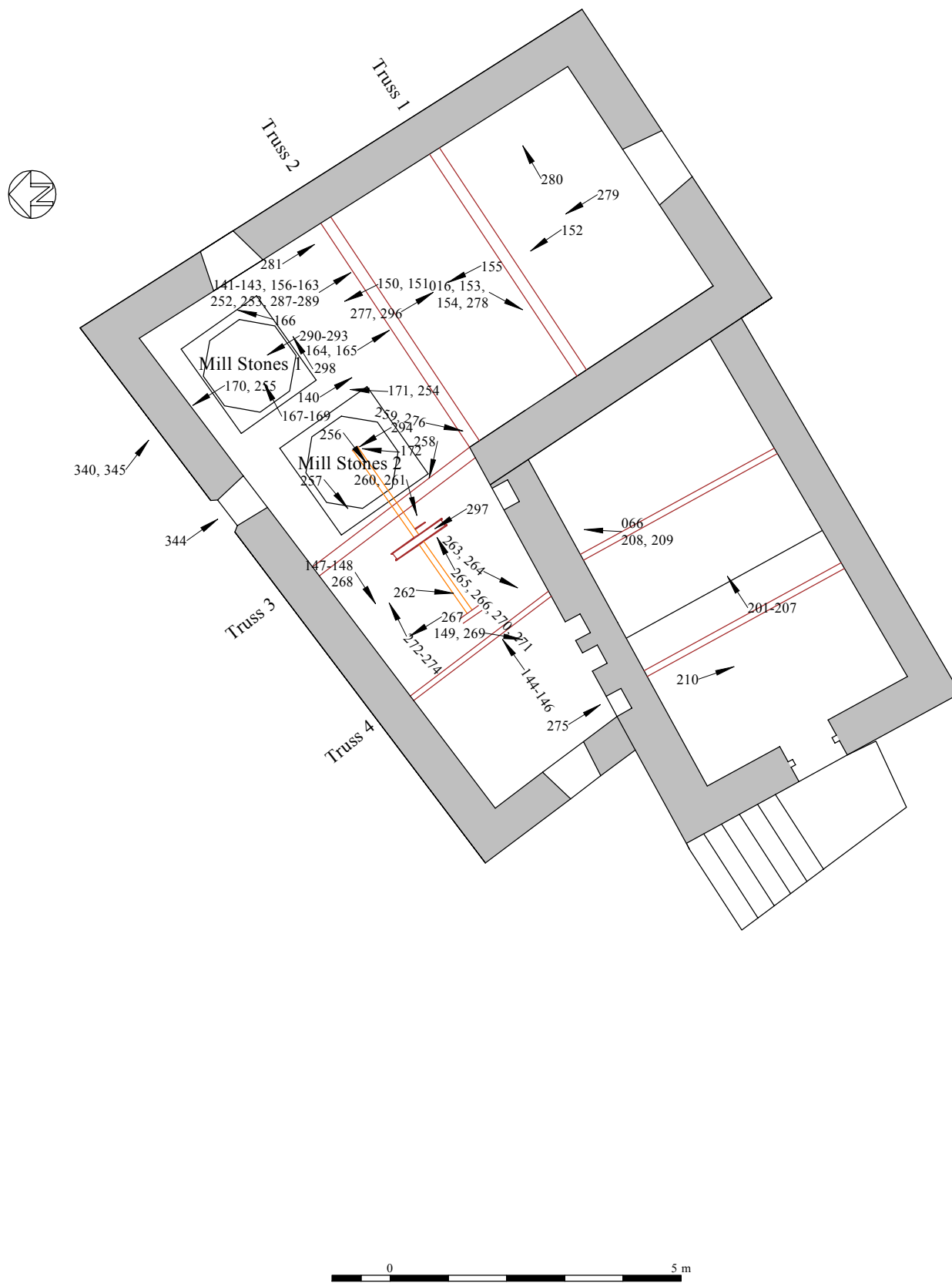

Figure 20: Location of the Photographs in the Archive
 First Floor
 Scale 1:100



Plate 1: View of the mill, looking north east



Plate 2: The mill pond



Plate 3: The outfall pipe and position of the launder

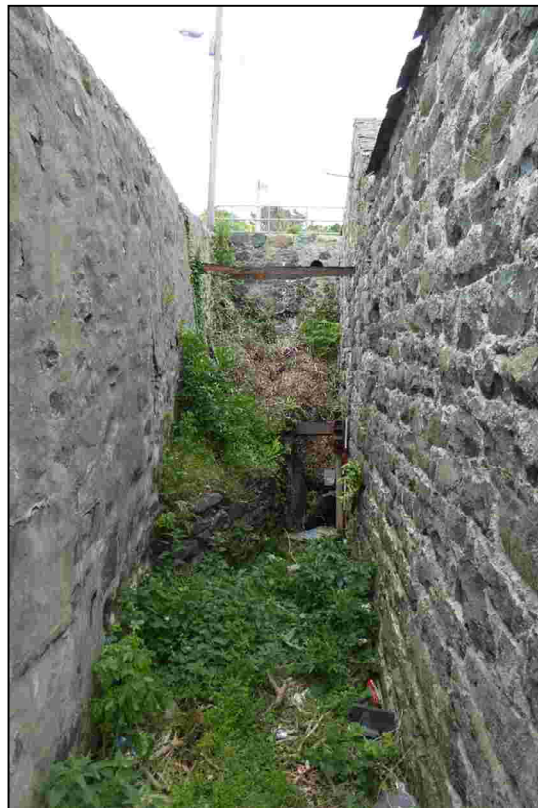

Plate 4: The wheel pit, looking north west



Plate 5: The wheel pit looking south east



Plate 6: Shallow buttress on the pond retaining wall



Plate 7: The south eastern gable of the mill range



Plate 8: The roof of the mill range



Plate 9: Opening for the control of the penstock

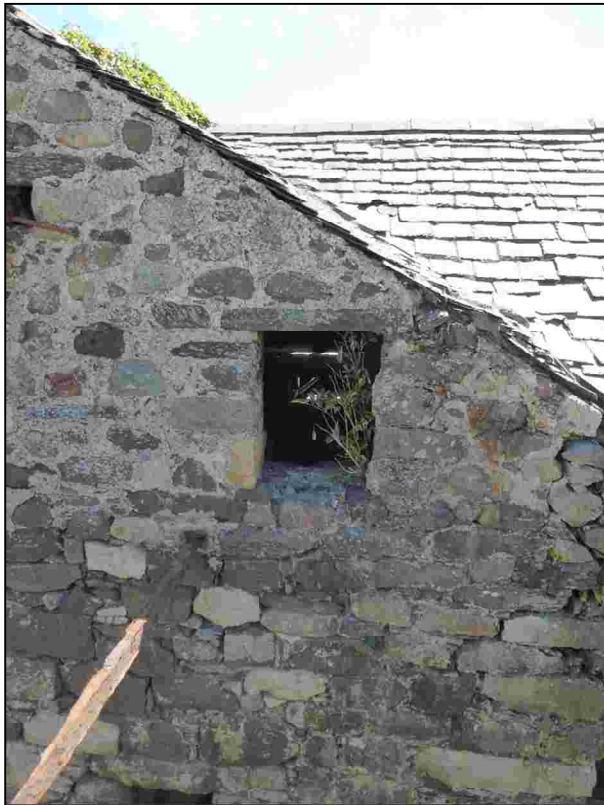

Plate 10: Water wheel inspection window



Plate 11: The opening for the water wheel axle



Plate 12: Millstone in the floor of the mill range



Plate 13: Door handle to the mill range.



Plate 14: Inside of the doors to the mill range



Plate 15: Niche in the mill range



Plate 16: The casing for one of the dressers in the mill range



Plate 17: Ceiling joist in the mill range



Plate 18: The spout between the corn dryer and the mill range

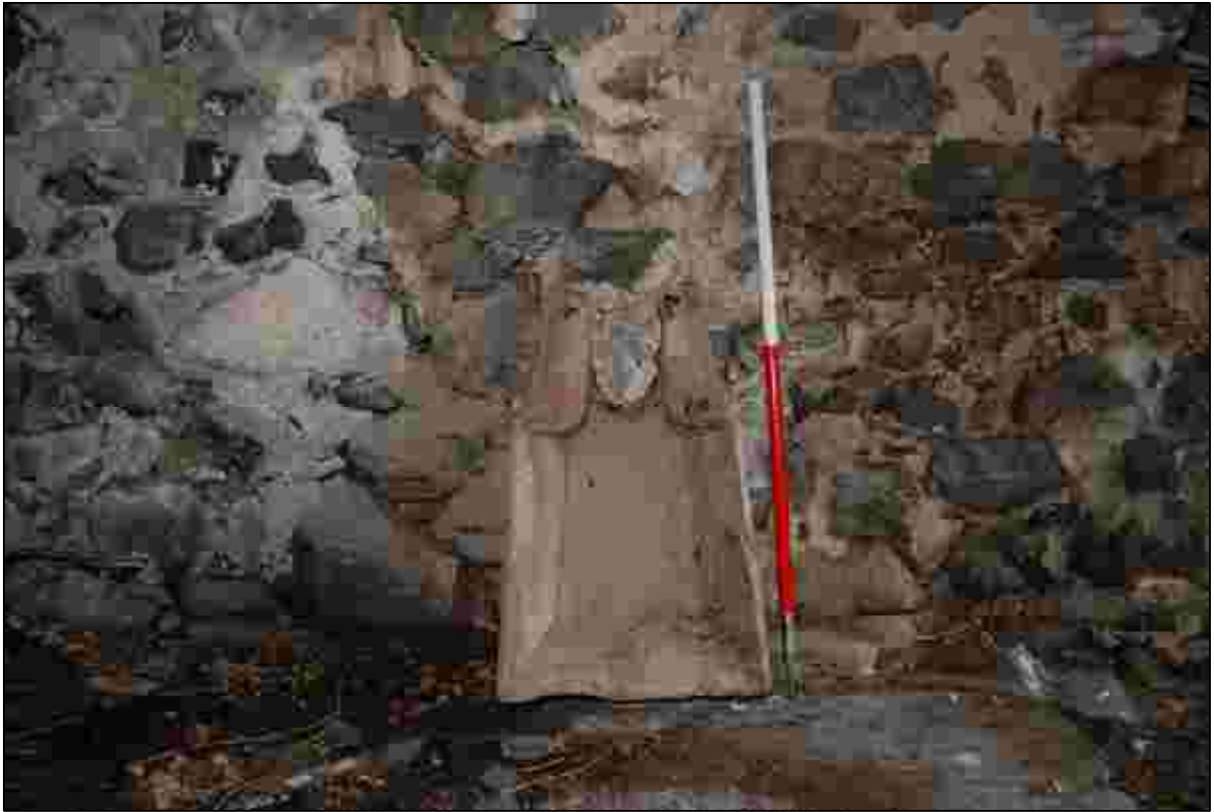

Plate 19: Slipper



Plate 20: The Hurst Frame and trough in the mill range



Plate 21: The spout from the eastern stones



Plate 22: The stone floor of the mill range looking south east



Plate 23: Remains of the hatch in the mill range



Plate 24: The stone floor of the mill range, looking north west



Plate 25: The windlass attached to Truss 1



Plate 26: Iron ring above the hatch in the mill range.



Plate 27: Worn slots on Truss 2 and its associated purlin



Plate 28: Worn slot in the purlin



Plate 29: The adjuster for the penstock



Plate 30: Iron banded millstone



Plate 31: Ground floor entrance to the corn dryer

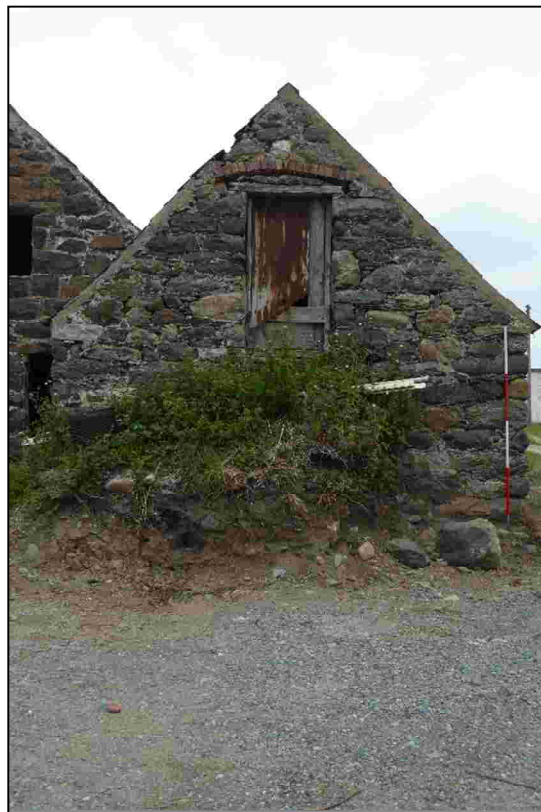

Plate 32: The south western gable of the corn dryer

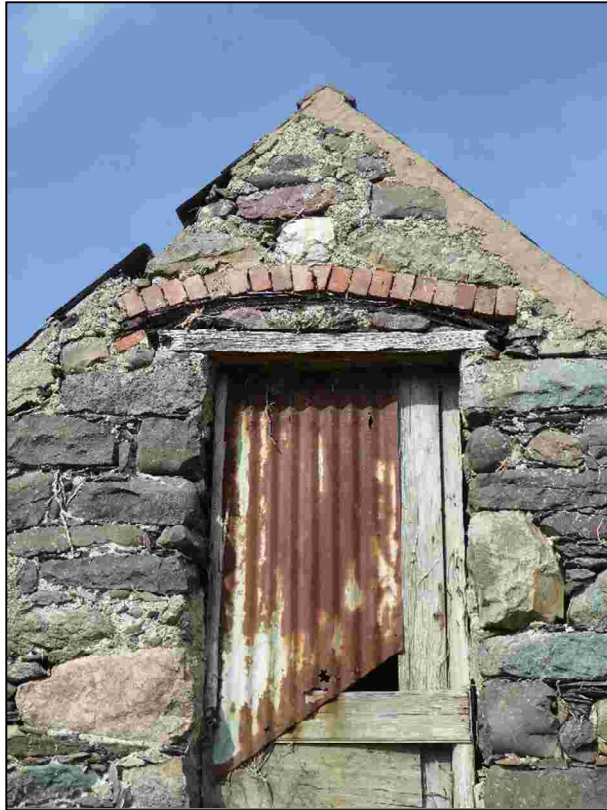

Plate 33: Detail of the first floor door to the corn dryer



Plate 34: Northern elevation of the corn dryer



Plate 35: The dividing wall in the corn dryer



Plate 36: The northern and central opening in the dividing wall of the corn dryer



Plate 37: The firebox



Plate 38: The oven



Plate 39: Blocked window



Plate 40: Fittings on the upper door of the corn dryer



Plate 41: Shafts from a cart



Plate 42: Perforated stack behind the firebox



Plate 43: Lower chamber of the corn dryer



Plate 44: First floor of the corn dryer looking north east.

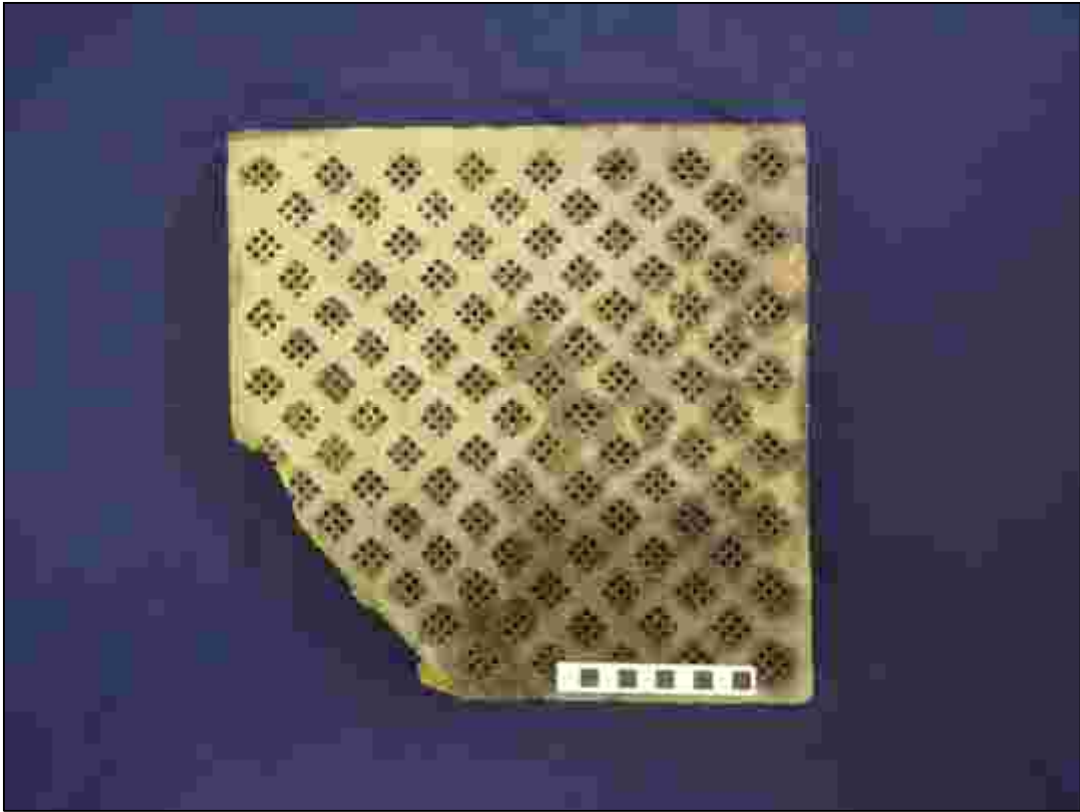

Plate 45: Top surface of the perforated tile



Plate 46: Lower surface of the perforated tile



Plate 47: Sawn off principle rafter



Plate 48: Tool from the corn dyer



Plate 49: Head of the tool from the corn dryer



Plate 50: Wooden stair case



Plate 51: Gable end of the “Dresser Range”



Plate 52: Ground floor window in the “Dresser Range”



Plate 53: Window in the northern wall of the “Dresser Range”



Plate 54: Ground floor of the “Dresser Range”, looking south west



Plate 55: Ground floor of the “Dresser Range” looking north east



Plate 56: First floor of the “Dresser Range” looking north east, showing the hatch



Plate 57: Opening in the floor of the “Dresser Range” above the dressers



Plate 58: The niches in the “Dresser Range”



Plate 59: Detail of the slate lined niche



Plate 60: The stables



Plate 61: The floor of the stables



Plate 62: The wooden bench in the stables



Plate 63: The horse collar

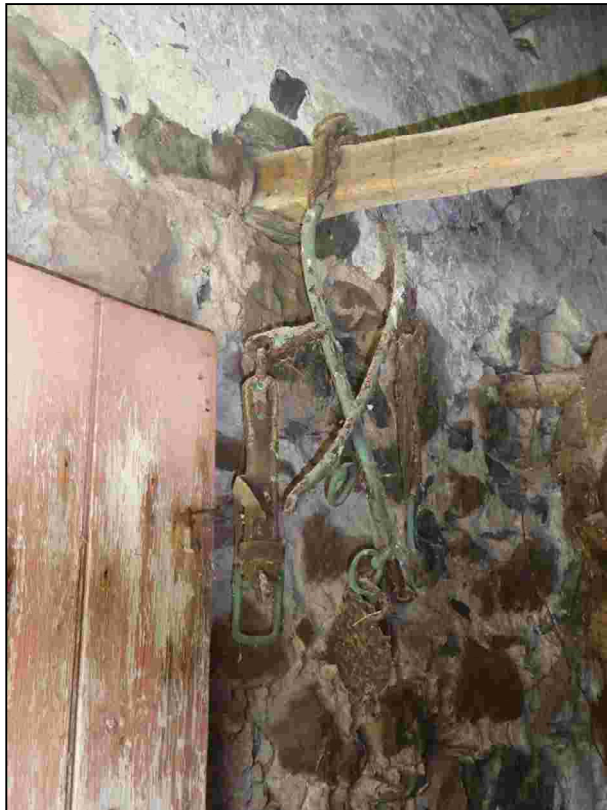

Plate 64: Horse harness



Plate 65: The hub of the waterwheel



Plate 66: Detail of the structure of the waterwheel hub



Plate 67: Detail of the structure of the waterwheel hub



Plate 68: Historic photograph of the mill (Source http://www.rhiw.com/hanes_02/melinau_llyn/melin_aberdaron.jpg)



Plate 69: The pit wheel



Plate 70: The main shaft



Plate 71: The wallower



Plate 72: One of the stone nuts and the great spur wheel



Plate 73: Modification to the Hurst Frame to accommodate the great spur wheel



Plate 74: The western stone nut



Plate 75: The eastern stone nut



Plate 76: The latch securing one of the stone nuts and part of the tenting gear



Plate 77: The cam for fine adjustment of the tenting mechanism



Plate 78: One of the adjuster handles for the tenting mechanism



Plate 79: Hopper and slipper for the western stones



Plate 80: The damsel at the eastern end of the Hurst Frame



Plate 81: The chute from the eastern stones



Plate 82: The remains of the chute from the western stones



Plate 83: The bearing at the eastern end of the lower lay shaft



Plate 84: The pulley wheel on the lower lay shaft within the Hurst Frame



Plate 85: The second pulley wheel and third bearing block for the lower lay shaft



Plate 86: The western pulley wheel on the lower lay shaft



Plate 87: Shaft at the foot of the Hurst Frame



Plate 88: The tensioner in its closed position



Plate 89: The tensioner in its extended position



Plate 90: The gears driving the fan



Plate 91: The fan



Plate 92: The western dresser



Plate 93: The eastern dresser



Plate 94: The works of the eastern dresser



Plate 95: The brushes within the eastern dresser



Plate 96: The wooden guide for the drive belt



Plate 97: The upper pulley wheel.



Plate 98: The worn section of the upper lay shaft above the hatch



Plate 99: The reinforced section of the upper lay shaft



Plate 100: Pulley wheel, part of the sack hoist mechanism



Plate 101: Graffiti on the southern face of the ceiling beam in the mill



Plate 102: Graffiti on the northern face of the ceiling beam in the mill



Plate 103: Area of graffiti at the eastern end of the Hurst Frame



Plate 104: Date at the eastern end of the Hurst Frame



Plate 105: Date on the eastern end of the Hurst Frame



Plate 106: 1901 Factory and Works Act record



Plate 107: The pokerwork schooner



Plate 108: The pokerwork steam ship



Plate 109: The scratched ship



Plate 110: Graffiti in the area of the scratched ship