

PASCO[®]

Celebrating 60 Years of Innovation

SCIENCE & TECHNOLOGY

Biology • Chemistry • Environmental • Physics

Featuring!

- Wireless Sensors
- STEM Solutions
- Lab Bundles
- Curriculum
- And More

TRANSFORMING SCIENCE & STEM EDUCATION

NEW!

Wireless Dissolved
Oxygen Sensor &
Photosynthesis
Chamber
(page 45)

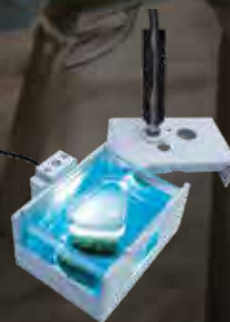

FREE! SPARKvue Software
Award-Winning Software Free for All Devices
(pages 4-5)

60 YEARS OF

INNOVATION

PASCO is Celebrating 60 Years of Innovation in Science Education

60 years ago, PASCO scientific introduced its first product, the Millikan Oil Drop Experiment, that had its origins as a high school science project. Amazingly, schools ordered this apparatus from a company they had never heard of – displaying a great amount of trust in a new company.

And for the past 60 years, high schools and colleges have continued to place their trust in the apparatus we design, manufacture, sell and support. For that trust over the years, we simply say, **“Thank You!”** With your continued support and suggestions, we will strive to maintain that trust into the future.

What have we been doing for the past 60 years? I invite you to peruse our catalog and see the hundreds of products that bear the name PASCO.





NEW! Standard Compound
Optical Microscope.
(Page 51)



NEW! Melting Point Apparatus
(Page 70)

Table of Contents

PASCO Solution Overview	2
Elementary.....	8
Middle School	10
MindLabs.....	15
STEM/Coding	16
Engineering.....	30
Biology	36
Chemistry	52
Environmental.....	72
Physics.....	84
Sensors	114
Equipment Storage	126
Index.....	128
Order Form.....	134
Support & Consulting.....	136



NEW! Motorized Structures Systems
(Pages 31-35)



Sensor Technology

Our innovative, award-winning wireless sensors are rugged, low-cost, and easy to use. Explore our growing line of more than 30 wireless sensors!



Data Collection & Analysis Software

Intuitive SPARKvue[®] works on iOS, Android[™], and Chrome[™] devices, as well as Mac[®] and Windows[®] computers. It even includes Blockly block-based coding, which allows students to code with any PASCO sensor.



Complete Lab Stations

PASCO Lab Stations make it easy to use sensor-based technology in your science classroom. Discover Lab Stations for Biology, Chemistry, Agricultural Science, Physics, Middle School Science, and K-5 Science.



Curriculum Solutions

The Essential curriculums are the only curricular solutions that include a Student Textbook, an e-Book, Teacher e-Resources, Lab Manuals, and award-winning equipment kits.



STEM & Coding Solutions

STEM Sense solutions promote early excellence in science and STEM education with cross-curricular investigations that help young learners build strong foundations in science, programming and data literacy.



Storage & Classroom Management

Use these rolling carts and storage trays to decrease your classroom management time and increase teaching and learning time.



Sensor Technology

PASCO's award-winning line of wireless sensors are durably designed, easy to use, and affordably priced to help educators bring real-world technology into the hands of students everywhere. Our wireless sensors feature student-friendly designs, manual and automated data collection, interactive displays and other modern features that enhance science learning. Plus, they connect directly to computers, Chromebooks, tablets, and mobile devices, allowing students to quickly collect data, so they can spend more time analyzing and interpreting their results.

- Original PASCO innovations, such as the //code.Node, Smart Cart, Modular Circuits and Wireless Weather Sensor with GPS
- Award-winning software supports Blockly coding for every sensor
- Onboard sensor memory with Logging Mode for long-term experiments
- Hundreds of free labs available for download from our online Experiment Library
- PASCO-ensured quality and backed by our five-year warranty



Wireless Weather Sensor with GPS

Capable of making 19 measurements and logging GPS data, this all-in-one instrument is ideal for investigating complex environmental conditions.



Wireless Motion Sensor

This sensor measures the position, velocity, and acceleration of objects, and it even includes a 180° rotatable head for creative applications.



Wireless Smart Cart Patent Number 10,481,173

Upgrade to the revolutionary Wireless Smart Cart and start collecting live data for position, velocity, acceleration, force, and rotation directly on your device.



Wireless CO₂ Sensor

Use this sensor to explore respiration and photosynthesis, chemical reactions, and so much more with real-time CO₂ data on your device.



Wireless Colorimeter and Turbidity Sensor

This dynamic sensor simultaneously measures a sample's absorbance and transmittance at six different wavelengths, and it doubles as a turbidity sensor for water quality investigations.



Wireless Temperature Sensor

A staple of every science class, this sensor drastically simplifies temperature measurements with its small footprint, long-lasting battery, and live datalogging.

Our growing line now includes over 30 wireless sensors!



Data Collection and Coding

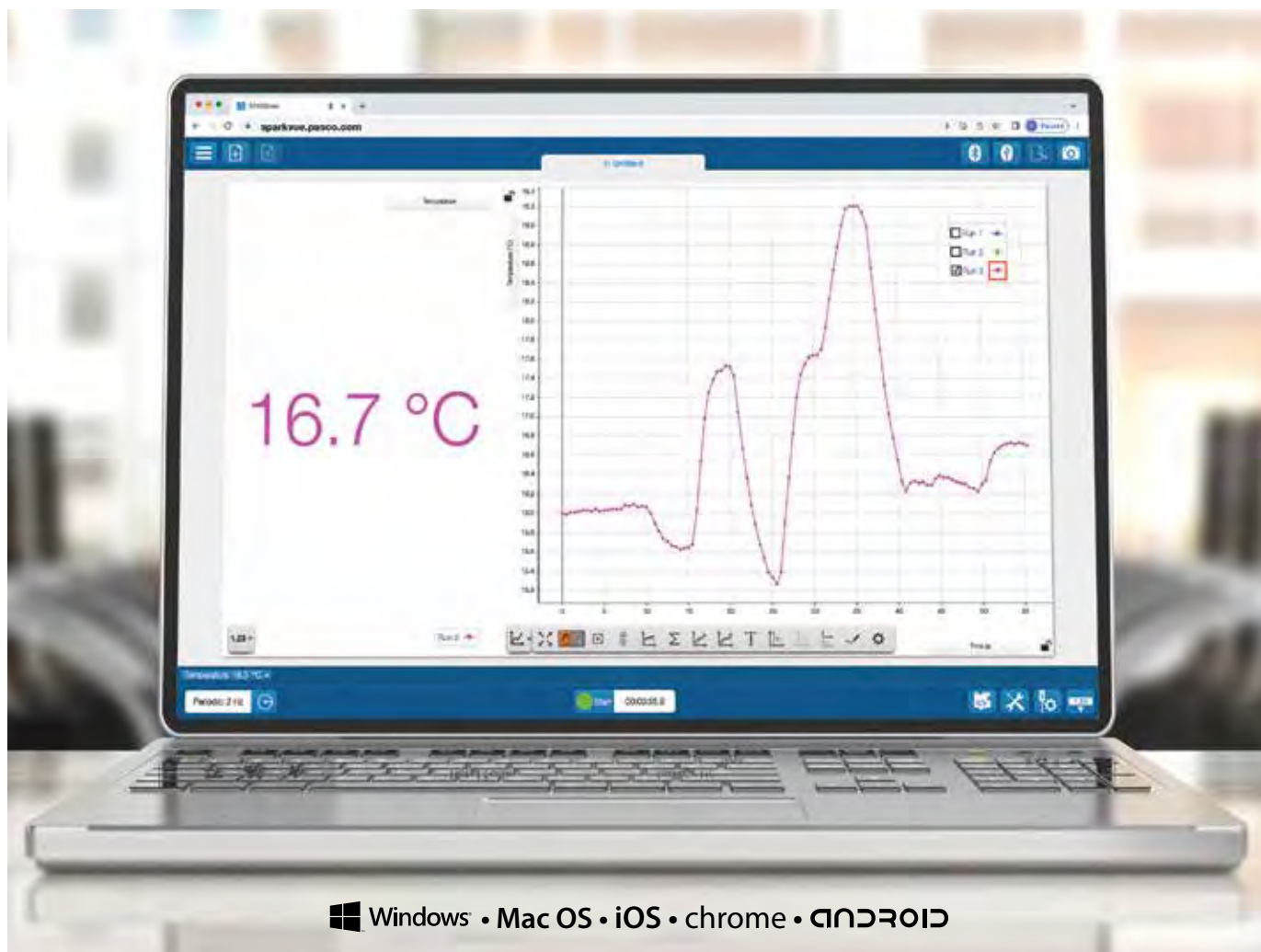

Windows • Mac OS • iOS • chrome • ANDROID



This FREE award-winning data collection and analysis software works on any platform!

SPARKvue's intuitive design has made it an award-winning tool for collecting and analyzing experimental data. The user-friendly platform optimizes data collection and provides tools for in-depth analysis within a compact, yet powerful workspace.

SPARKvue features Blockly coding, allowing students to use block-based code for sense and control of PASCO devices, including any of our sensors.

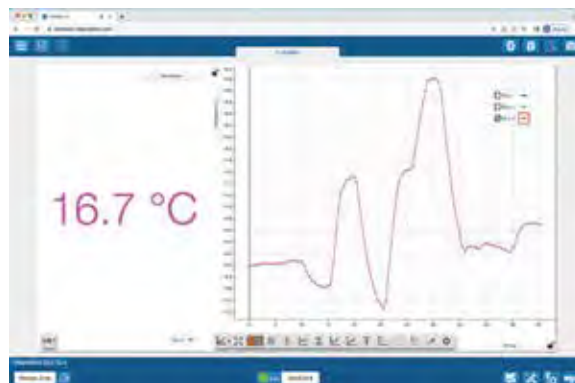

Student Data Collection...**MADE EASY!**

Student-Entered Data & Graphing

MADE EASY!

Choose manual data collection to record live values with the click of a button.

Make a mistake? No problem! Simply select a data point to replace it.

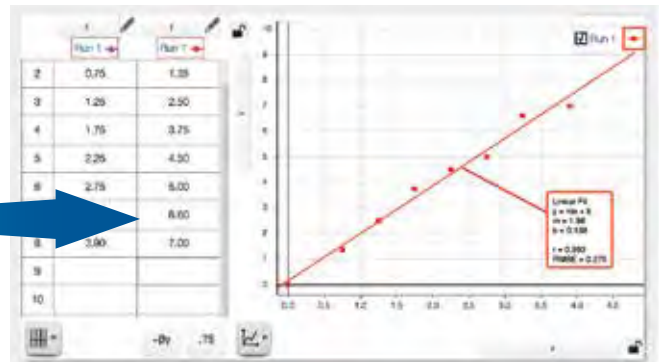
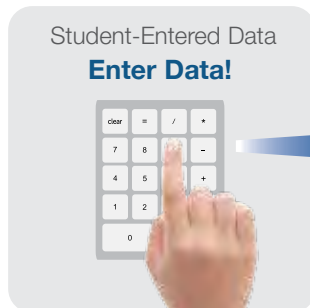

Graph & Analyze Student-Entered Data

Collecting & Graphing Sensor Data

MADE EASY!

Automate sensor data collection to monitor measurements in real-time.

Save time with pre-made experiment files or easily build your own displays. You and your students will be up and running in minutes.

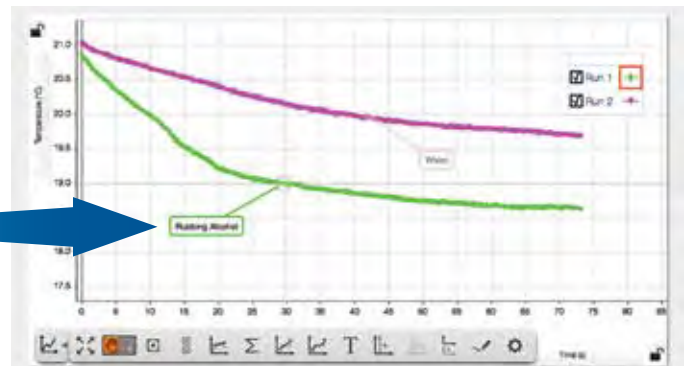
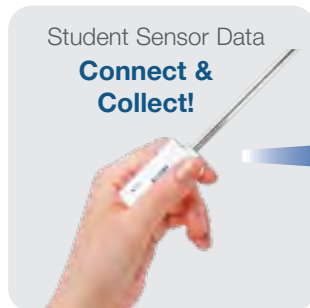

Rapid, Real-Time Data Collection & Analysis



Digits Display



Bar Graph Display



Meter Display



GIS Map Display

Free award winning data collection and analysis software now runs in your browser!

We're excited to announce SPARKvue is now available **FREE** of charge on all your devices as a browser-based application. This new version of our software as a Progressive Web Application (PWA) means you have free access to all the features of SPARKvue from Google Chrome and Microsoft Edge browsers. That's right: No download fees, subscription fees, or update fees, even for Windows® and Mac®. Plus, the app is always updated to the latest version automatically, so you never have to worry about it.

Go to sparkvue.pasco.com to access the PWA. SPARKvue is also available as a **FREE** app for Chromebook™, iPad®, Android™ tablets, and Apple® and Android™ smartphones.



Looking for additional options? See pasco.com/sparkvue for more details.

Science Lab Stations & Bundles

PASCO's Lab Stations make it easy and affordable to begin using sensor-based technology in your K-8, Biology, Chemistry and Environmental classrooms. Convenient Physics equipment bundles include equipment and sensor technology and are complemented by a collection of ready-made experiments.

Elementary Science Starter Lab Station

PS-3314

Inspire a lifelong love of science, while nurturing the development of foundational STEM skills with our new Elementary Science Lab Stations (page 9).



Middle School Science Starter Lab Station

PS-3312

Help prepare your middle school students for high school science with our ready-to-use Middle School Science Lab Stations (page 10).



Biology Starter Lab Station

EB-6334

Make the integration of phenomena-based investigations into your Biology course seamless with our complete Biology Lab Stations. Includes sensors, labs, and more (page 37).



Chemistry Starter Lab Station

EC-6362

Empower students to investigate chemical phenomena like never before with sensors, labs, and apparatus that make chemical concepts more meaningful (page 53).

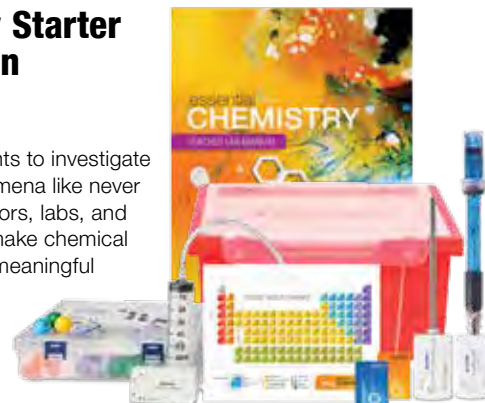

Agricultural Science Starter Lab Station

EB-6336

Transform your classroom into an outdoor field site with our new Agricultural Science Lab Stations. Includes sensors, labs, and more (page 75).



Physics Lab Bundles

Support hands-on physics learning all year long with our new Physics bundles, complete with sensors, labs, and more (page 86-91).



Curriculum Solutions

Essential Physics & Essential Chemistry

(See pages 54 and 92)

PASCO offers two complete curriculum solutions: *Essential Physics* and *Essential Chemistry*. Each program includes a Student Textbook, Student e-Book, Lab Manual, and Equipment Kits, all at a very affordable price. Other program features include:

- Animations and videos
- Flexible assessment options
- Interactive simulations
- Investigations and design challenges



STEM Solutions

Hands-On Coding, Sense and Control Kits

(See pages 16-29)

STEM Sense Kits engage students in the exploration of coding applications with real-world investigations into sensor technologies. Each complete kit includes hands-on, phenomena-based investigations; award-winning data collection and analysis software with block-based coding capability; our unique //code.Node device with programmable sensors, lights and sounds; and all the accessories you need to do the activities. Take student designs to the next level with the all new //control.Node and Sense and Control Kits.



Storage & Classroom Management

Gratnells Rolling Carts, Storage Trays and Charging Stations

(See page 126)

Gratnells storage solutions are the best way to store PASCO sensors and equipment. These movable storage rack carts include large castors with brakes for added stability, and make transporting materials to and from the classroom a breeze.

These carts can be used to store the equipment kits from the *Essential Physics* or *Essential Chemistry* curriculum, the storage trays we offer for wireless sensors, or any of the four sizes of empty trays that we offer for everything else you'd like to store.





PASCO's Hands-On Solutions for K-8 Science

At PASCO, we develop STEM solutions so simple and accessible that even the youngest scientists can use them. Our wireless sensors and engaging activities are the perfect way to introduce K-8 students to inquiry-based discovery learning without overwhelming them. With our NGSS-based solutions, students of all ages can engage in the active learning process as they navigate their way through hands-on exercises that form lasting STEM foundations.

K-8 Index

Elementary Stations	9
Middle School Stations..	10
Sensors for K-8	11
Ecozones	16
Renewable Energy	16
Microscopes.....	16
MindLabs.....	17

Elementary Science Starter Lab Station

PS-3314

The Elementary Science Starter Lab Station makes it easy and affordable to begin using sensor-based technology in your elementary science class. Inside the Starter Lab Station are the wireless sensors used to perform seven activities from the Essential Elementary Science Lab Manual. Available separately is the Elementary Science Extension Lab Station (PS-3315) which, when combined with the Elementary Science Starter Lab Station, comprises all the wireless sensors used to perform the ten labs inside the Essential Elementary Science Lab Manual. Once comfortable, you can explore our growing set of over 40 elementary labs in our online experiment library!



Elementary Science Lab Station with extension sensors



Starter Station Lab Titles (1-7)

1. Temperature and Change
2. Evidence of Chemical Reactions
3. Thermal Insulators and Conductors
4. Can Plants Survive Without Light?
5. How a Greenhouse Works: Heat
6. How a Greenhouse Works: Light
7. MatchGraph

Extension Station Lab Titles (8-10)

8. Determining Sound Levels
9. Weather and Climate: Microclimates
10. Weather and Climate: Monitoring Weather

The Elementary Science Starter Lab Station is a complete solution that includes these wireless sensors and materials:

- Temperature
- Light
- Motion
- Storage Case
- Lab Manual

The Elementary Science Extension Lab Station has the additional wireless sensors (Sound PS-3227 and Weather PS-3209) needed to perform all 10 labs inside the Essential Elementary Science Lab Manual.

Order Information

Elementary Science Starter Lab Station	PS-3314
Elementary Science Extension Lab Station	PS-3315



NEW! STEM GREENHOUSE KIT

Explore modern greenhouse technologies with sense and control capabilities. This solution includes all of the sensors, data collection, coding tools, and equipment you need to get started. (See pages 28-29)

Middle School Science Starter Lab Station

PS-3312

The Middle School Science Starter Lab Station makes it easy and affordable to begin using sensor-based technology with your middle school students. Inside the Starter Lab Station are the wireless sensors used to perform six activities from the Essential Middle School Science Lab Manual. Available separately is the Middle School Science Extension Lab Station (PS-3313) which, when combined with the Middle School Science Starter Lab Station, comprises all the wireless sensors used to perform all 10 labs included inside the Essential Middle School Science Lab Manual, as well as many of the Middle School labs in PASCO's online experiment library.



Middle School Science Lab Titles

The Middle School Science Starter Lab Station supports 6 of the 10 labs. Add the Extension Lab Station* to do all 10 lab titles.

1. Describing Motion

2. Humidity and Dew Point*

3. Night and Day

4. Seasons and Temperatures

5. Thermoregulation

6. Introduction to Acids

7. Photosynthesis*

8. Acid Rain and Weathering

9. Forces and Interactions*

10. Waves and Energy*



Middle School Science Lab Station with extension sensors

The Middle/Secondary School Science Starter Lab Station includes these wireless sensors and materials:

- Temp
- Light
- pH
- Motion
- Storage Case
- Lab Manual

The Middle School Science Extension Lab Station has the additional wireless sensors (CO₂ PS-3208 and Weather PS-3209) needed to perform all 10 labs inside the Essential Middle School Science Lab Manual.

Order Information

Middle School Science Starter Lab StationPS-3312

Middle School Science Extension Lab Station.....PS-3313

Wireless Temperature Sensor



PS-3201

Welcome to the modern thermometer. Now, students can access real-time data that continuously monitors, logs, and plots temperature measurements on nearly any device. When lab time ends but the experiment continues, students can set the sensor to log data autonomously for days, then download it for analysis later. This durable, wireless sensor features a stainless steel probe for the most demanding of applications, as well as a battery that lasts up to a year. It can be used in a wide array of experiments and activities because it measures small but significant temperature changes produced by chemical reactions, convection currents, and even skin temperatures.



Order Information

Wireless Temperature Sensor.....PS-3201
 Wireless Temperature Sensor PackPS-3330

Note: Price for multi-sensor packs includes 8 sensors and custom storage case.

Wireless pH Sensor



PS-3204

The Wireless pH Sensor is a must-have for any science course. Equally capable in the lab or field, the sensor eliminates the hassle of cables, reducing spills and improving safety. Plus, it rarely requires charging; the sensor's coin cell battery lasts for 2-3 years in most labs and costs about one dollar to replace. It can transmit data in real time, or store data for days when continuous monitoring is required. The Wireless pH Sensor enhances countless activities, including acid-base titrations, investigations into household chemicals, analyses of chemical reactions, water quality studies, and much more.



Order Information

Wireless pH Sensor.....PS-3204
 Wireless pH Sensor PackPS-3331

Note: Price for multi-sensor packs includes 8 sensors and custom storage case.

Wireless CO₂ Sensor



PS-3208

Measure changes in carbon dioxide (CO₂) gas levels quickly and easily with the Wireless CO₂ Sensor. This temperature-compensated sensor can operate in high humidity environments, such as the included 250-mL sample bottle, and employs live data to make core labs, such as photosynthesis, cellular respiration, and metabolism experiments engaging and impactful. With the ability to store more than 55,000 data points, the sensor also supports long-term studies of carbon cycling that span the course of a single night or an entire weekend.



Order Information

Wireless CO₂ Sensor (Carbon Dioxide).....PS-3208
 Wireless CO₂ Sensor PackPS-3341

Note: Price for multi-sensor packs includes 8 sensors and custom storage case.

Wireless Weather Sensor with GPS



PS-3209

The Wireless Weather Sensor is an all-in-one instrument for monitoring complex environmental conditions. It houses several sensing elements within a single unit to provide 19 different measurements. Use the sensor in logging mode with the Weather Vane Accessory for long-term monitoring, or use it as a handheld instrument to study microclimates and local, environmental phenomena.



Order Information

Wireless Weather Sensor with GPSPS-3209
 Weather Vane AccessoryPS-3553

Wireless Motion Sensor

PS-3219

The Wireless Motion Sensor connects to your device via Bluetooth® or USB, and uses ultrasound to measure the position, velocity, and acceleration of objects. This enables students to take turns measuring their own distance from the sensor, while the class observes their motion materializing as a graph in real time. The sensor can detect objects ranging from 15 cm to 4.0 m away, and with no cables to get in the way, students can explore handheld and ceiling-mounted applications.

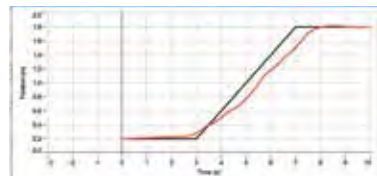
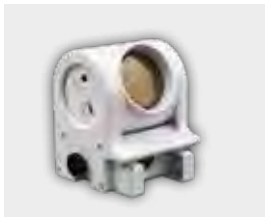

FREE MatchGraph! Software

Download Mac®, Windows® and Android™ versions at pasco.com. iOS version available on Apple App Store.



Order Information

Wireless Motion SensorPS-3219

Wireless Motion Sensor PackPS-3337

Note: Price for multi-sensor packs includes 8 sensors and custom storage case.

Wireless Force Acceleration Sensor

PS-3202

Capable of simultaneously measuring force, acceleration, and rotational velocity, this sensor is ideal for experiments involving rotating platforms, moving carts, spring oscillations, collisions, or impulse. The wireless design offers improved measurement accuracy by eliminating cords that affect data collection. Students can use the finger-holes for handheld applications, or mount it onto a cart or rod for more complex experiments.

The Wireless Force Acceleration Sensor is perfect for explorations of Newton's 3rd Law.

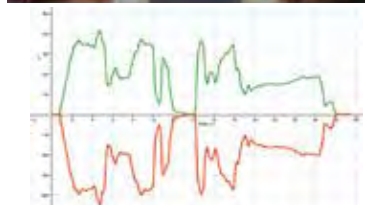

Order Information

Wireless Force Acceleration SensorPS-3202

Wireless Force Acceleration Sensor PackPS-3339



Smart Cart (Red & Blue)

ME-1240/ME-1241

The patented Smart Cart is the ultimate tool for studying kinematics, dynamics, Newton's Laws, and more. It is based on a durable ABS body with nearly frictionless wheels, just like our high quality PAScars. Now, we've added built-in sensors that measure force, position, velocity, and acceleration. The versatile Smart Cart can collect measurements on or off a track and transmit the data wirelessly over Bluetooth®. In essence, it is a wireless dynamics cart that combines all the necessary sensors, without requiring any additional hardware.

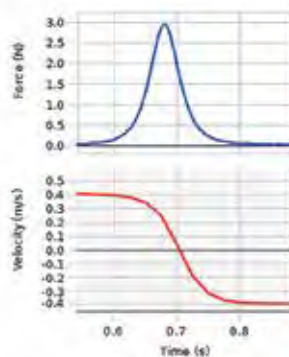

Order Information

Smart Cart (Red)ME-1240

Smart Cart (Blue)ME-1241

Constant Velocity Car

SE-8028A

Turn on the Constant Speed Buggy and watch it go. When it reaches a wall, it flips over and changes directions. This low-cost solution features flashing lights and a sporty appearance. Requires two "C" batteries that are not included. Actual product may vary from picture.



Order Information

Constant Velocity Car (Constant Speed Buggy)SE-8028A

Wireless Sound Sensor

PS-3227

The Wireless Sound Sensor is two sensors in one wireless package: a sound wave sensor capable of measuring changes in frequency as pitch changes, and a sound level sensor to determine and compare loudness.

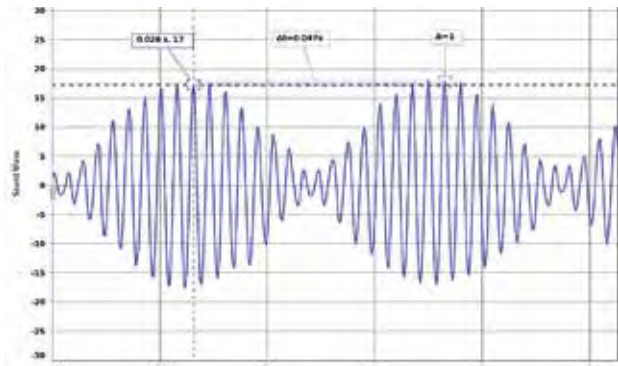

Easily observe and measure beat frequencies

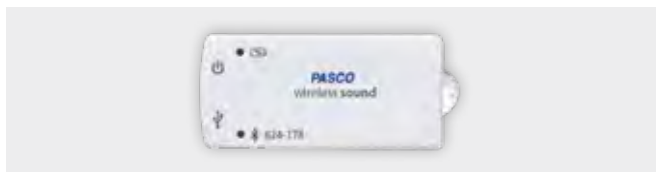

Order Information

Wireless Sound SensorPS-3227
 Wireless Sound Sensor Pack.....PS-3342

Note: Price for multi-sensor packs includes 8 sensors and custom storage case.

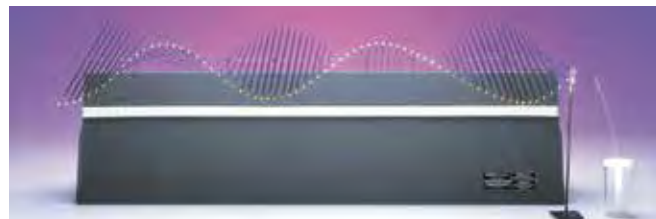

Single Section Wave Motion Demonstrator

SE-9601

The Single Section Wave Motion Demonstrator produces mechanical waves to illustrate many of the properties and behaviors associated with different wave types. Students can explore how the velocity, frequency, and wavelength interact, visualize the superposition of waves, and easily study resonance conditions that cause standing waves.

Order Information

Single Section Wave Motion DemonstratorSE-9601

Wireless Light and Color Sensor

PS-3248

The Wireless Light and Color Sensor features two separate apertures: One measures ambient light from the side of the box, and the other measures percent color of directional light at the end of the box.



Order Information

Wireless Light and Color Sensor.....PS-3248
 Wireless Light Sensor Pack.....PS-3338

Note: Price for multi-sensor packs includes 8 sensors and custom storage case.

Color Mixer

OS-8496

With three independently controllable LEDs, the Color Mixer offers a simple way to explore light and color with your students. It functions as both a demonstration tool and an expansion piece to the Basic Optics System.

The intensity of the red, green, and blue LEDs can easily be varied, either individually or all together. Demonstrating additive color mixing is as simple as using any flat surface to project the light upon.



Use it as a projector in classroom demonstrations. Individually adjust the intensity of the super bright red, green, and blue LEDs.



Order Information

Color MixerOS-8496

Standard Compound Optical Microscope

SE-6213

Standard optical microscope great for general viewing of cell structures at 40x, 100x, 400x viewing. Gives insights to topics from Biology, Life Science, Anatomy and Physiology, Cellular and Field Biology. High quality optical lenses allow for fine details in high contrast can be studied in appropriate detail for starter to experienced microscope users. Perfect for establishing labs with sets of durable equipment classes can use for years. Compatible with student or professionally prepared slide set like the Microscope Slide Kingdom survey (SE-6214) gives students a solid start to explore cellular features and concepts across all living kingdoms.



Features:

- Observe small specimens like plant, animal, and bacterial cells, translucent objects such as insect larvae, or fine particles like powder
- 10 x eye piece
- 10x eyepiece and 4x, 10x, and 40x (oil) objective lenses provide magnification options of 40x, 100x, and 400x
- Adjustable focus between coarse and fine settings
- Dual light source (upper and lower LED) provides adjustable brightness
- Cord or cordless power options (External AC/DC Adaptor or 3xAA Batteries)
- Equipped with a plain stage with clip and single lens condenser with disc diaphragm

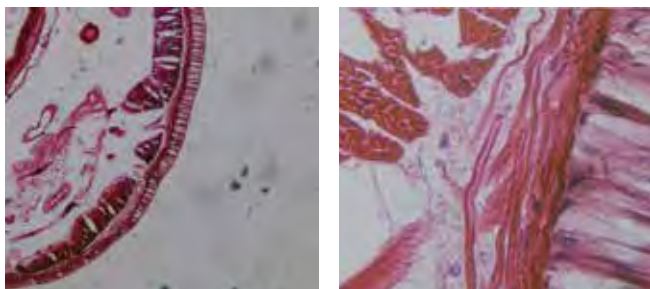

Sample imagery above captured with standard eyepiece USB camera. Slides from the *Kingdoms Survey, Prepared Slide Set* (sold separately)

Order Information

- Standard Compound Optical Microscope.....SE-6213
- Prepared Slide Set, Kingdoms SurveySE-6214



EcoZone System

ME-6668

PASCO's EcoZone System is designed to help students model and understand the complex interactions within and among different ecosystems. The three clear acrylic EcoChambers are specially designed to accommodate PASCO sensors, making qualitative and quantitative measurements very easy to observe.

With three interconnected chambers, students can model the interaction between three different ecosystems. Choose the traditional terrestrial, aquatic, and decomposition environments or create unique biomes to model and measure. Decouple the system for isolated investigations. How does the availability of light affect the ecosystem? Students can create two identical ecosystems for precise control of variable impact.

Order Information

- EcoZone SystemME-6668



Renewable Energy Kit

ST-7611

Using PASCO's renewable energy kit, students will be challenged to create a designs for solar and/or wind power that maximize energy output under explored sets of conditions. Students have full control of blade number, blade angles, electric loads, solar incidence, affect of dust on solar cells in order to find the optimal orientation for power generation. This is a great way to leverage the knowledge they've acquired for an engineering design challenge and bring STEM into your classroom.

Order Information

- Renewable Energy KitST-7611



MindLabs ENERGY and CIRCUITS



Combine the fun of tabletop games with the excitement of Augmented Reality!

- Student-centered, inquiry-based learning
- Aligns with STEM standards
- Includes FREE app and circuit cards
- Each set accommodates up to 4 players
- Classroom Set accommodates up to 6 teams of 4 players

Explore energy and circuits through augmented reality with these interactive playing cards and free app. Includes six sets of twenty cards.

Gooseneck tablet stand frees up students' hands for interacting with cards and app.



Ages 8+

FEATURED IN



The MindLabs Energy and Circuits Kit is a magical STEM learning tool for children ages 8 and older. It combines 20 game cards, a free digital app, and augmented reality to provide students with a fun and immersive learning experience. Play alone or collaborate with friends as you add and remove cards, draw wires, and create circuits that come to life in 3D! Students interact with characters to save the day with STEM. The ideal learning tool for solo or team play, MindLabs enables students to explore energy sources, circuits, and more.

- Create, play, and collaborate from any location!
- Assemble cards picturing batteries, light bulbs, fans, and more into working circuits
- Draw and connect wires on a mobile device to bring circuits to life
- Investigate energy resources with animated idea cards
- Step-by-step lessons guide students through basic circuit concepts
- Apply concepts to solve challenges and repair circuits

Features:

- Work independently or collaborate with students in any location
- Includes 20 cards and more than 20 interactive challenges with step-by-step guidance
- Extra thick cards will withstand years of use in your classroom
- Free application is intuitive and engaging for young learners
- Five full lesson plans with YouTube™ video supplements



MindLabs' app is available FREE for Apple® and Android™ tablets and smartphones.



Minimum iOS Requirements: iPhone SE 2016, iPad Mini Gen 5, or iPad 2017 running iOS 11 or later

Minimum Android Requirements: Google Pixel, Samsung S8, Moto Z2, HTC U11, or comparable devices running Android 9 or later



MindLabs Energy and Circuits kits can be purchased individually or in class sets of 6. Gooseneck Tablet Stands are included with the **Complete Class Set** only (Qty. 6).

Order Information

MindLabs: Energy & Circuits Single Set.....	SE-7170
MindLabs: Energy & Circuits Class Set.....	SE-7171
MindLabs: Energy & Circuits Complete Class Set .	SE-7172
Gooseneck Tablet Stand.....	SE-7173

STEM SENSE SOLUTIONS



STEM Sense solutions help foster early success in science and STEM education with cross-curricular investigations that help learners build strong foundations in science, programming, and data literacy. Each complete kit includes an easy-to-use coding device, award-winning software with Blockly coding, hands-on and phenomena-based investigations, and the equipment and supplies students need to complete each activity.



Coding With Sensor
Technologies Kit



Coding With Vehicle Sensor
Technologies Kit



Coding With Sound & Light
Sensor Technologies Kit



Student Activities and Teacher Resources

Whether they're new programmers or hobby hackers, STEM Sense Kits make it easy to support students of all learning levels with a variety of scaffolded activities and open-ended challenges. Each lesson is based upon the latest science standards and incorporates cross-curricular connections to reinforce key concepts in computer science, mathematics, and language arts.

SPARKvue + Block-Based Programming



SPARKvue offers all the benefits of a visual coding environment with additional features for data collection, visualization, and analysis. When students execute a program in SPARKvue, they can monitor sensor data collection in real time, displaying it in digits, graphs, and/or text. Students can also combine PASCO sensors and coding devices, such as the //code.Node, to create programs that interact with the physical world. With PASCO and Blockly, students can learn how to create, modify, and execute block-based coding programs while developing the skills they'll need to progress on to traditional text programming languages like Java, Python, and C++.



Coding & Control Devices + Equipment

The //code.Node and //control.Node bridge the gap between science and computer science to provide students with hands-on learning opportunities that promote literacy in science, programming, and data collection. All PASCO coding devices integrate with our sensors and data collection and coding software, enabling students to perform basic coding with technology activities as well as more advanced sense and control investigations. STEM Sense Kits come ready-to-use with all the additional equipment and supplies required to do the activities, including magnets, tuning forks, the //code.Node Cart, the PASCObot, and much more.



PASCObot Sense &
Control Kit



Greenhouse Sense &
Control Kit



//control.Node Sense &
Control Kit

SPARKvue & Blockly Coding: Computational Thinking Meets Data Literacy

The Integration of Blockly into SPARKvue software provides science and STEM teachers with an intuitive coding platform that fits their needs. Rather than introducing students to coding independently, Blockly integrates computational thinking into the exploration of phenomena to provide learners with a new world of STEM opportunity.

With Blockly, students can create custom data collection parameters, feedback loops, data displays, and so much more.

Use Blockly in SPARKvue to:

- Introduce students to computational thinking
- Investigate phenomena while learning to code
- Create data-driven feedback loops
- Program data collection parameters for any PASCO sensor or interface



Create code that collects, displays, and responds to sensor data! Interact with the physical world using the PASCO `//code.Node` or `//control.Node`.

Support computational thinking in science with ready-to-use Blockly extension activities.

Free award winning data collection and analysis software now runs in your browser!

We're excited to announce SPARKvue is now available **FREE** of charge on all your devices as a browser-based application. This new version of our software as a Progressive Web Application (PWA) means you have free access to all the features of SPARKvue from Google Chrome and Microsoft Edge browsers.

Go to sparkvue.pasco.com to access the PWA. SPARKvue is also available as a **FREE** app for Chromebook™, iPad®, Android™ tablets, and Apple® and Android™ smartphones.



Looking for additional options? See pasco.com/sparkvue for more details.

PASCO's award-winning data collection and analysis software includes Blockly coding with data displays!

Getting started with //code.Node is quick and easy. Simply connect the //code.Node to SPARKvue and begin coding instructions for its sensor inputs and device outputs. As the code is executed, SPARKvue displays real-time data from the //code.Node's active sensors, which triggers a response from the //code.Node's lights and sounds. Other PASCO sensors may also be used in Blockly programs, enabling students to explore a new world of opportunity.



Explore more advanced coding applications with the //control.Node.

Use Blockly with any PASCO Wireless Sensor!

INPUT

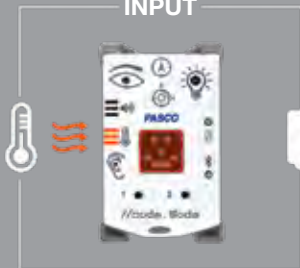

Select one or more //code.Node sensor inputs and a device output.

Pair //code.Node to your device, or use it in standalone mode.

CODING IN SPARKVUE



Drag and drop coding blocks to create a functioning program. Then execute it!

OUTPUT



Sensor data triggers a response in the device's sound & light outputs.

OUTPUT

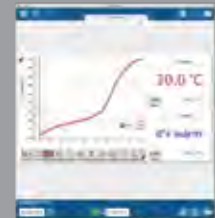

SPARKvue displays data collected by the sensor input in real time.

HELLO

Meet //code.Node!

The //code.Node is a hands-on coding device with interactive sensors, lights, and sounds that make learning to code a real-life STEM adventure. Designed for ages eight to fourteen, the //code.Node helps kids harness their natural curiosity to create block-based programs that bring their ideas to life.

Whether they're interested in cars, robots, sports, or science, //code.Node allows students to explore the things they love through coding. Together, the //code.Node, interactive activities, and step-by-step video lessons enable new coders to master the basics at their own pace while the accessories and wrist-strap ensure confident coders never run out of possibilities.

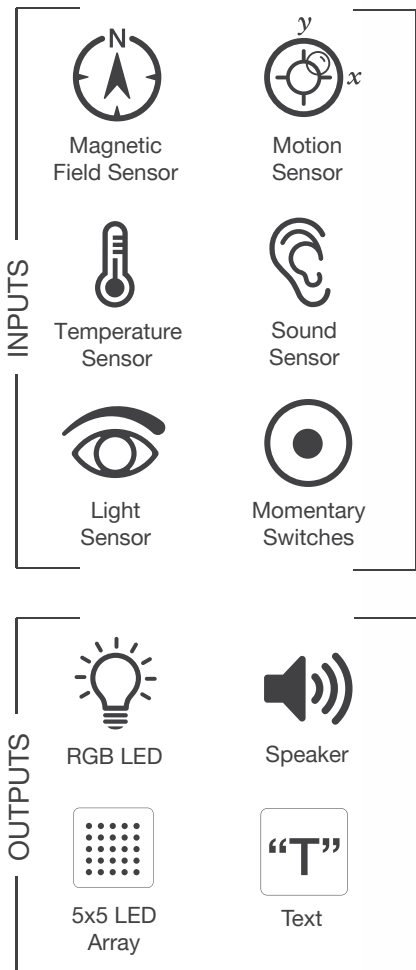

Order Information	
//code.Node.	PS-3231
//code.Node Holder.....	PS-3233
//code.Node (Set of 8)	PS-3311



Coding with Sensor Technologies Kit

ST-7800

The Coding with Sensor Technologies Kit introduces students to coding and includes ten hands-on investigations that explore science phenomena using the //code.Node's programmable sensors, lights, and sounds.

Student Activities and Video Lessons

The Coding with Sensor Technologies Kit includes ten investigations with video lessons, printed student worksheets, and an interactive digital flipbook that presents the resources in an engaging, student-friendly format. Each lesson is based upon the latest science standards and incorporates cross-curricular connections to reinforce key concepts in computer science, mathematics, and language arts.



Activities and Video Lessons

- Magnetic Polarity
- Random Number Cube
- Automatic Nightlight
- Light Bulb Efficiency
- Clap On
- What's the Origin?
- Investigating Sound Levels
- Step Counter
- Intruder Alarm
- Digital Thermometer

Build career awareness with activities that make real-world connections to:

- Engineering with real-life sensors
- Designing "smart" home technology
- Programming and developing sensor-based safety features

Help students develop competency in:

- Problem-solving, logical reasoning, and critical thinking
- Computational thinking
- Data collection and analysis
- Mathematics
- Technology and programming



Block-Based Coding

Blockly simplifies the programming process for new coders. Visual coding blocks connect like puzzle pieces to help students master the basics of programming without having to worry about their syntax.

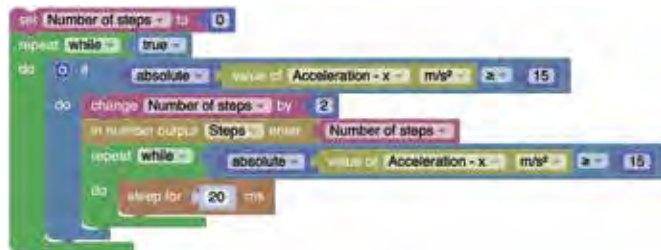

Coding with Sensor Technologies Equipment

The Coding with Sensor Technologies Kit includes a //code.Node, two painted bar magnets, and a //code.Node Holder with wrist-strap. Wireless and easy-to-use, the //code.Node includes six sensor inputs, a speaker, RGB light, and an LED Array, all of which enable students to explore exciting phenomena using block-based programs that collect, display, and respond to data.



Includes:

- //code.Node PS-3231
- //code.Node Holder PS-3233
- Painted Bar Magnet (Pair) SE-7593
- Color-Printed Booklet of Student Activities

Order Information

Coding with Sensor Technologies Kit.....	ST-7800
Coding with Sensor Technologies Kit (without //code.Node)	ST-7801



Coding with Vehicle Sensor Technologies Kit

ST-7820

Explore the science and sensors behind today's modern vehicles while teaching students about physical science as they design, test, measure and code with sensors that mimic real-world vehicle technology.

Student Activities and Video Lessons

This complete kit includes five investigations with video lessons, printed student worksheets, and an interactive, browser-based flipbook that presents the resources in an engaging, student-friendly format. Each lesson is based upon the latest science standards and incorporates cross-curricular connections to reinforce key concepts in computer science, mathematics, and language arts.



Activities and Video Lessons

- Crash Test - Impact Alert System
- Investigating Odometers
- Engineering Turn Signals
- 3-2-1 Launch!
- The Need for Speed - Radar Detectors



Build career awareness with activities that make real-world connections to:

- Automotive engineering
- Real-life vehicle sensors
- Crash test engineering

Help students develop competency in:

- Problem-solving, logic, and critical thinking
- Computational thinking
- Data collection and analysis
- Mathematics
- Technology and programming



Block-Based Coding

Blockly simplifies the programming process for new coders. Visual coding blocks connect like puzzle pieces to help students master the basics of programming without having to worry about their syntax.



Coding with Vehicle Sensor Technologies Equipment

The Coding with Vehicle Sensor Technologies Kit comes classroom-ready with all the equipment, accessories, and software needed to complete the included activities. The complete kit includes a //code.Node, a //code.Node Cart, a color-printed booklet of student activities, two light spring bumpers, six 50-g masses; a 1.5-m roll of measuring tape, a spool of thread, and two block person figurines.



Includes:

- //code.Node PS-3231
- //code.Node Cart PS-3235
- Color-Printed Booklet of Student Activities
- Light Spring Bumpers (Qty. 2)
- 50 g Masses (Qty. 6)
- Soft Measuring Tape, 1.5 m
- Spool of Thread
- Block Person Figurines (Qty. 2)

Order Information

Coding with Vehicle Sensor Technologies KitST-7820
 Coding with Vehicle Sensor Technologies Kit
 (without //code.Node)ST-7821



Coding with Sound and Light Sensor Technologies Kit

ST-7830

The Coding with Sound and Light Sensor Technologies Kit engages students in the exploration of light and sound with five hands-on coding investigations that use familiar phenomena and real-world sensors to bring concepts to life.

Student Activities and Video Lessons

This complete kit includes five investigations with video lessons, printed student worksheets, and an interactive, browser-based flipbook that presents the resources in an engaging, student-friendly format. Each lesson is based upon the latest science standards and incorporates cross-curricular connections to reinforce key concepts in computer science, mathematics, and language arts.

Block-Based Coding

Blockly simplifies the programming process for new coders. Visual coding blocks connect like puzzle pieces to help students master the basics of programming without having to worry about their syntax.

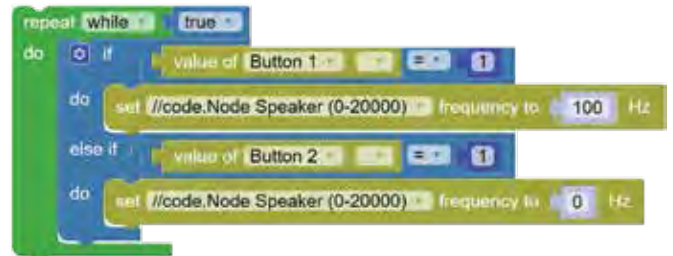

Activities and Video Lessons

- What is a Color Sensor?
- RGB LED - How to Program Color
- Engineering Sound Level Meters
- Detect an Intruder - Home Alarm Systems
- Investigating Electronic Tuners



Coding with Sound and Light Sensor Technologies Equipment

The Coding with Sound and Light Sensor Technologies Kit includes everything students need to explore concepts in light and sound through STEM. The complete kit includes: a //code.Node; a //code.Node Holder with wrist-strap; two tuning forks of different frequencies; a small flashlight; a color-printed booklet of student activities; a set of colored paper; and five sheets of aluminum foil.



Includes:

- //code.Node PS-3231
- //code.Node Holder PS-3233
- Color-Printed Booklet of Student Activities
- Small Flashlight
- Tuning Fork, Various Frequency (Qty. 2)
- Colored Paper, Various 4"x 4" Sheets (Qty. 35)
- Aluminum Foil Sheet, 4"x 4" Sheets (Qty. 5)

Build career awareness with activities that make real-world connections to:

- Audio engineering and light technicians
- Programming and developing sensor-based security features
- Real-world innovations in sound and light technology

Help students develop competency in:

- Problem-solving, logic, and critical thinking
- Computational thinking
- Data collection and analysis
- Mathematics
- Technology and programming

Order Information

Coding with Sound and Light Sensor Technologies Kit ST-7830
 Coding with Sound and Light Sensor Technologies Kit
 (without //code.Node) ST-7831

PASCObot

SENSE & CONTROL KIT

When nestled inside the PASCObot, the //control.Node serves as a brain, providing both power to the bot and memory storage for students' code.



Build your bot in minutes with simple components and connector pieces that bring power to its wheels.

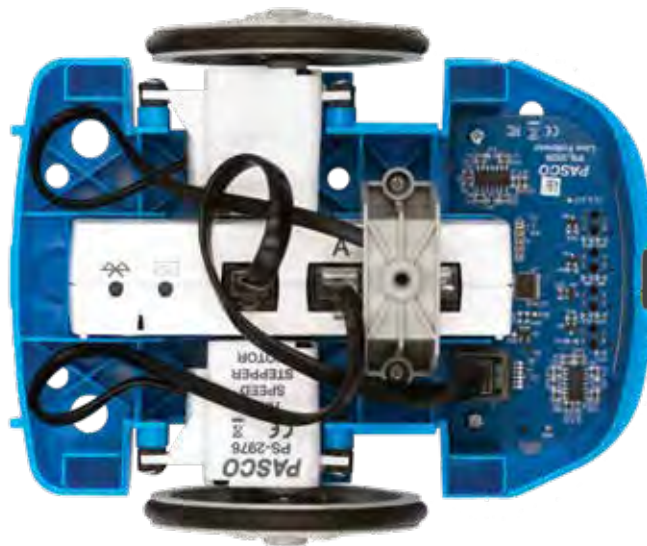

Navigate custom paths, obstacles, and more with code blocks that drive the bot forwards, backwards, or around corners and curves.



Create programs that control how the PASCObot identifies and responds to objects! Pick up a can, stack cups, or avoid objects entirely with the included Range Finder.

Stream code to the bot in real time or use the rechargeable //control.Node to run programs autonomously!

Designed for ages 11+, the PASCObot Sense & Control Kit includes everything students need to explore STEM through coding and robotics. Whether they're new programmers or hobby hackers, the PASCObot makes it easy to support students of all levels with a variety of scaffolded and open-ended activities.

This complete kit includes a PASCObot and //control.Node, as well as all the accessories needed to program how the bot interacts with its environment. From simple movements and spins to object avoidance to complex obstacle courses, there's no limit to what students can create with PASCObot.

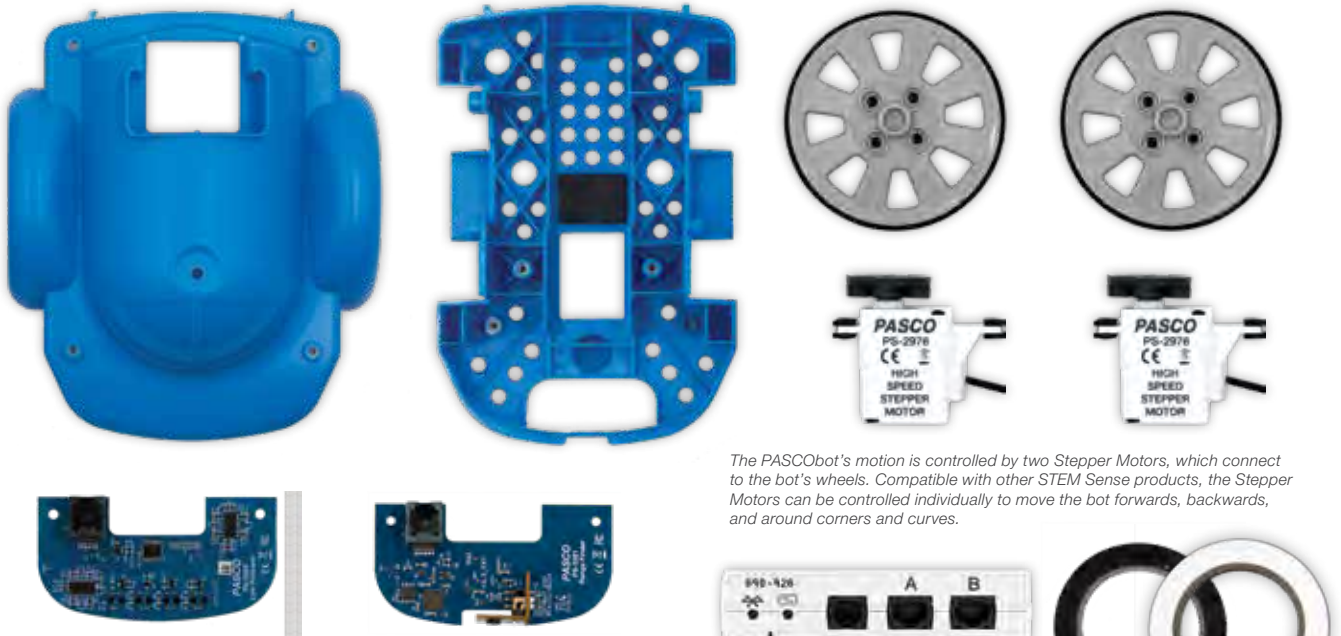

The Line Follower Module lets the PASCObot detect and respond to custom line paths that students create using the included tape.

The Range Finder Module gives the PASCObot sight, allowing it to locate, avoid, and respond to objects based on code.

The PASCObot's motion is controlled by two Stepper Motors, which connect to the bot's wheels. Compatible with other STEM Sense products, the Stepper Motors can be controlled individually to move the bot forwards, backwards, and around corners and curves.



Wireless and rechargeable, the //control.Node has two ports for stepper motors, two ports for servo motors, and one port for digital sensors.



Design custom obstacle courses using the included cups and tape. Then create code to navigate the bot through the course!

The PASCObot Gripper Accessory opens a new world of opportunity by enabling students to program the bot to move, pick up, or even stack a variety of objects. When used with the included Range Finder, the PASCObot Gripper Accessory allows students to control how the bot identifies and interacts with objects.

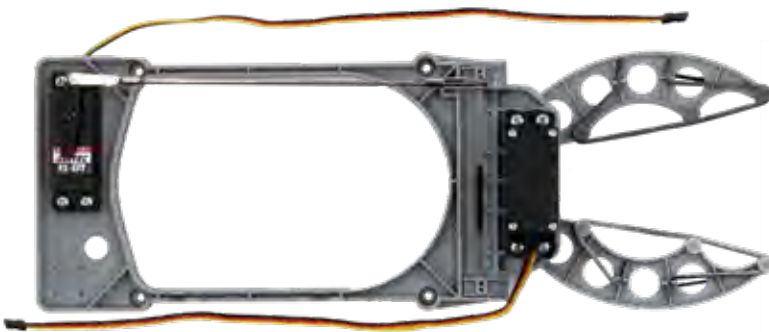

Order Information

- PASCObotPS-2994
- PASCObot Sense & Control KitST-7840
- The PASCObot Sense & Control Kit (shown above) comes with the PASCObot (body, wheels, stepper motors and //control.Node) and all of the modules and accessories shown above. See below and right for individual ordering.*
- PASCObot Line Follower ModulePS-3320

Order Information

- PASCObot Range Finder Module.....PS-3321
- PASCObot Gripper AccessoryPS-3325
- PASCObot Servo MotorSE-2975
- Black and White Tape (rolls)SE-2953
- Colored Plastic Cup Set (5).....SE-2952



Greenhouse Sense & Control Kit

ST-2997

Designed for the exploration of biological and ecological concepts, the Greenhouse Sense & Control Kit includes everything students need to design, build, program, and study their very own greenhouse.

Student Activities

The Greenhouse Sense & Control Kit includes five student activities that can be edited to fit your course needs. Each activity focuses on a key concept in biology or environmental science and includes extensions to engineering and design practices.



Student Activities

- Program a Sunny Day for Plants
- Code a Cooling Breeze
- Program Perfectly Timed Rain
- Optimize Water Movement
- Program a Greenhouse Sense and Control System

Build career awareness with activities that make real-world connections to:

- Agricultural monitoring
- Ecological management
- Plant physiology

Help students develop competency in:

- Coding
- Problem solving
- Data collection and analysis
- Ecological concepts
- Science and Engineering practices



Block-Based Coding

The Blockly integration within SPARKvue software makes it easy for students to master the basics of programming, without having to worry about their syntax. Rather than overwhelming students with options, Blockly focuses on building coding literacy through a library of customizable, drag-and-drop coding blocks.

As they combine coding blocks, students are provided with visual feedback that lets them know whether two coding blocks are compatible. After mastering the basics, students can go on to create their own programs, complete with custom conditions, commands, data displays, and more. With Blockly and STEM Sense, students can pursue all types of investigations—from single-day experiments to semester-long studies.

Greenhouse Sense & Control Kit Equipment

This complete kit includes an EcoChamber and //control.Node, Soil Moisture Probe, Power Output Module, USB Fan, and Water Pump, PASCO Grow Light, tubing with drip-watering ends, and a Greenhouse Sensor that measures light, temperature, humidity, and soil moisture.



Order Information

Greenhouse Sense and Control Kit.....ST-2997

Create your own ecosystem, optimize growth, and more!

Support authentic science practices while conserving time with automated sensor measurements that make daily observations quick and easy.

Use data from the Soil Moisture Probe to optimize watering schedules for specific species and microhabitats.

Plug your own devices into the included Power Output Module to extend your investigations.

Make data-based decisions with measurements for humidity, temperature, light, and soil moisture.

Ideal for studies in biology, environmental science, and STEM, the Greenhouse Sense & Control Kit comes fully customizable, enabling students to explore countless interactions between plants and environmental factors.

Program the PASCO Grow Light to automate light cycles, alter the LED color, or compare the effects of different lighting conditions.

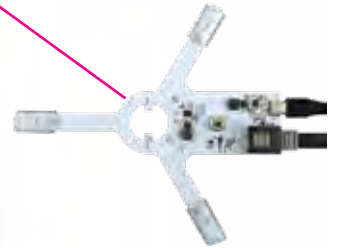

Investigate the effects of temperature, humidity, and wind disturbance.

Design a water source, complete with pump, and control it using code!



The //control.Node serves as the Greenhouse's brain, providing power to the light, fan, water pump, and sensors!

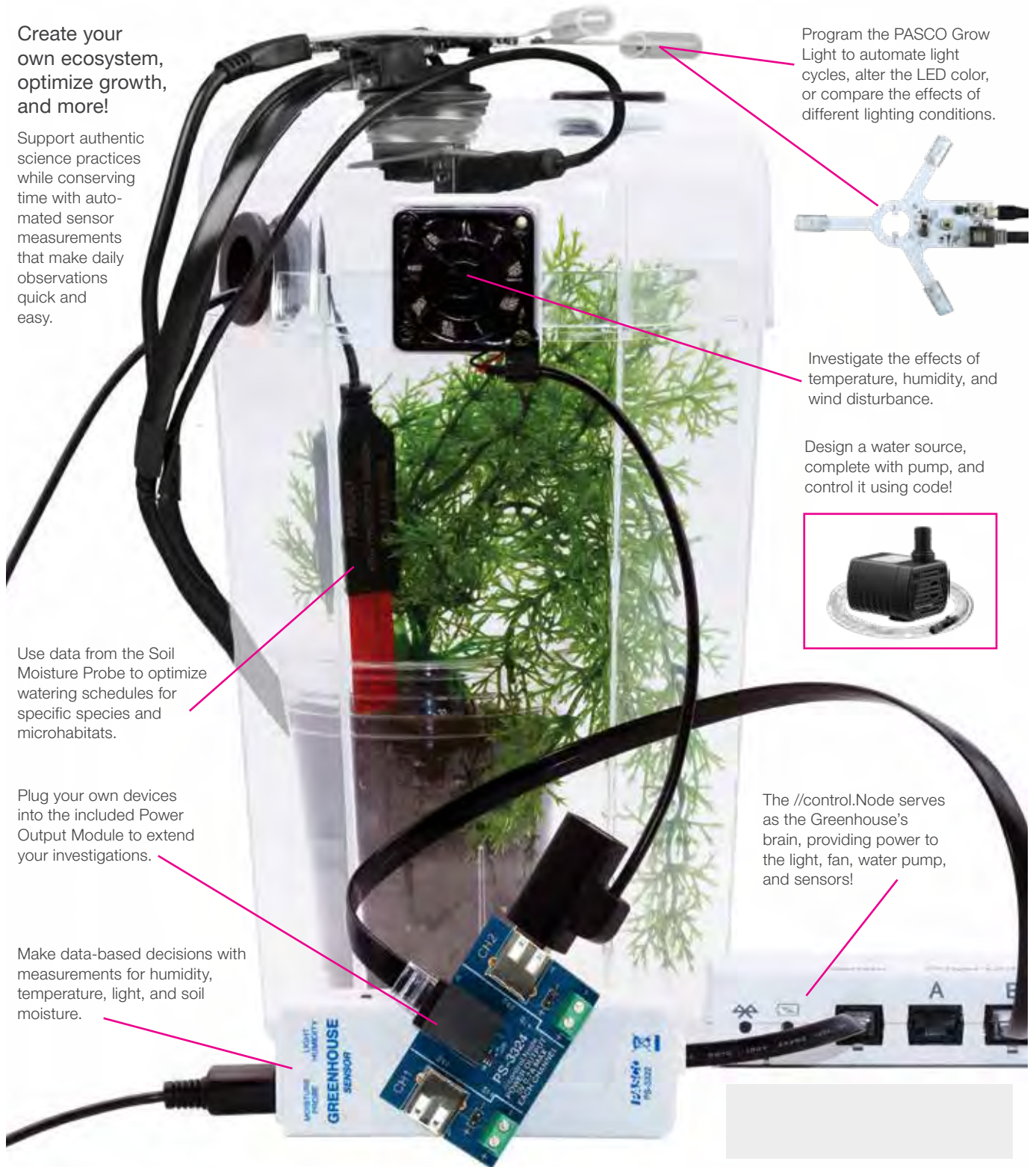

Potential topics of study include soil moisture, humidity, temperature fluctuations, light availability, inter- and intraspecies competition, wind disturbance, and so much more.

//control.Node

SENSE & CONTROL KIT

The //control.Node Sense & Control Kit helps students discover the engineering and design process through a series of exploratory STEM challenges. It includes a wide variety of programmable components—ranging from smart coding devices and accessories to servo motors and supplies. A collection of six scaffolded, starter projects is also included to help students practice applying elements of the engineering and design process to various real-world scenarios.



//control.Node Sense & Control Kit

PS-5050

The //control.Node Sense and Control Kit empowers students to create and explore through code. This kit includes a //control.Node and accessories that students can use to turn on lights, run a cooling fan, open doors, launch rubber bands, and much more. The kit also includes materials and instructions for six projects:

- Night Light
- Game with Meter
- Automatic Door Opener
- Thermostat-Controlled Fan
- Light-Activated Winch
- Remote Control Rubber Band Launcher

These projects use elements of the engineering design process:

- Define the problem
- Research solutions
- Design a prototype
- Test solution
- Iterative design and improvement



GET STARTED

Learn about the components of PASCO's //control.Node Sense & Control Kit (PS-5050) and how to program them with Blockly code, included with SPARKvue software.

//control.Node Sense & Control Kit



Motor Bracket and Stand



USB Fan
PS-6206



Power Output Module
PS-3324



//control.Node PS-3232
(ships in separate box)



Servo Motor
SE-2975

//code.Node
PS-3231



Lightbulb & Stand
with Cable



Pulley



Stepper Motor
PS-2976



Small Magnet



Jumbo Paper Clips
Qty. 10



Rubber Bands
Qty. 10

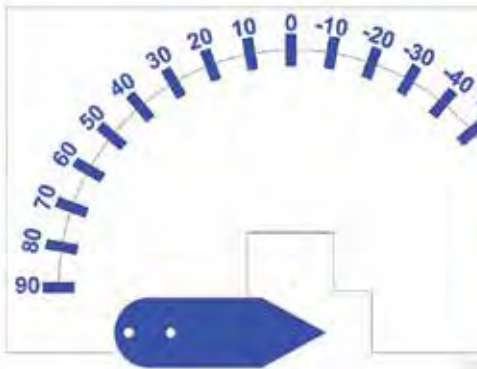

House and Meter Paper Templates

Note: Not pictured are 4 bolts and 4 nuts.



Includes:

- //control.Node
- //code.Node
- Servo Motor
- High Speed Stepper Motor
- Fan (USB)
- Lightbulb and Stand
- Motor Bracket and Stand
- Power Output Module
- Physics String (not pictured)
- Small Magnet
- Pulley
- Electrical Wires (2)
- Rubber Bands (10)
- Paper Clips for Servo Pushrods (10)
- Mounting Bolts and Nuts for Motors
- House and Meter Paper Templates
- Phillips Screwdriver (not pictured)

Order Information

//control.Node Sense and Control Kit..... PS-5050

Sense and Control Kit (without //control.Node)PS-5051

This kit is intended for courses that already have a //control.Node. The kit is identical to PS-5050 except it does not include a //control.Node (PS-3232).

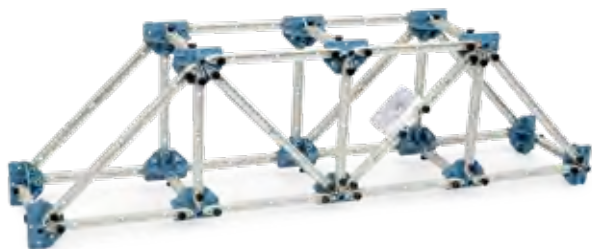

Building Better Bridges Kit

ME-3581

Now is the perfect time for your students to learn about bridge-building and how bridges really work. This complete STEM kit allows students to learn and apply engineering design concepts. They can use the included I-Beams to build bridges and structures that behave like the real thing! And, with the included Wireless Load Cell, students can measure forces under tension or compression anywhere in their structures.

Concepts:

- Forces in Equilibrium
- Internal Forces
- Moments in Equilibrium
- Strength of Members
- Truss Analysis

Includes:

- Lab Activities (Qty. 1)
- Wireless Load Cell and Accelerometer (Qty. 1)
- Truss Connector (Qty. 16)
- Truss Screw (Qty. 80)
- Sliding Connector (Qty. 1)
- Mass Hanger (Qty. 1)
- Weight Set (Qty. 1)
- #1 Flexible I-Beam Member (Qty. 6)
- #2 Flexible I-Beam Member (Qty. 2)
- #3 Flexible I-Beam Member (Qty. 10)
- #4 Flexible I-Beam Member (Qty. 18)
- #5 Flexible I-Beam Member (Qty. 8)
- Gratnells® Storage Tray and Foam Liner (Qty. 1)

Building Better Bridges includes everything students need to build, measure, and test a truss bridge—plus a Gratnells® Storage Tray to keep it all organized.



Order Information

Building Better Bridges KitME-3581



With the PASCO Structures System, students can quickly build, test, and redesign their structures while learning about the engineering process. Construction is easy: Simply fit an I-beam into a Connector, and secure it with thumbscrews.



Wireless Load Cells can be placed anywhere in your structure to make real-time measurements of tension and compression.

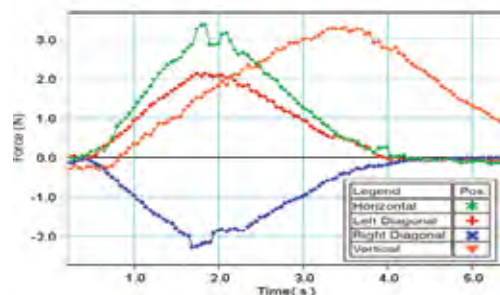

PASCO software lets students create live graphs of forces over time, compare measurements from different points, and analyze their results.

Motorized Crane

NEW

ME-7030

The Motorized Crane is made using PASCO Structures and is controlled and powered by the //control.Node. Students program the controller to run the stepper motor and servo motors using Blockly coding embedded in PASCO Capstone or SPARKvue software.

The crane picks up objects with an electromagnet which is also controlled and powered by the //control.Node. Students can vary the duty cycle to vary the power of the electromagnet to explore the minimum power required to pick up different objects.

Steel washers are included with stickers to non-ferrous objects such as paper cups so the electromagnet can pick up a variety of objects.

The crane includes three sets of gears to explore the effect of gear ratios (1:1, 2:1, 4:1) on speed and lifting capability.

Activities:

- Build the Motorized Crane
- Introduction to Stepper and Servo Motors
- Position Boom Angle and Electromagnet height to reach a position
- Pick up a ball and drop it into a cup on a different level
- Effect of Gear Ratios on Speed
- Effect of Duty Cycle on the Load the Electromagnet Can Lift
- Effect of Spool Diameter

Features:

- The controller can execute its code via Bluetooth® or USB connection to a computer or autonomously via uploaded code.
- The motors and electromagnet on the crane are powered by the rechargeable battery in the //control.Node.
- The position and speed of the stepper motor and electromagnet can be displayed in the software while the code is executed.
- The cable spool has two diameters to learn about mechanical advantage.
- The //code.Node accelerometer is used as a joystick to move the crane so the crane can learn the locations of certain positions.
- Students build the crane and can change the design using additional Structures parts.
- Any PASCO sensor can be used with the crane to expand its capabilities.

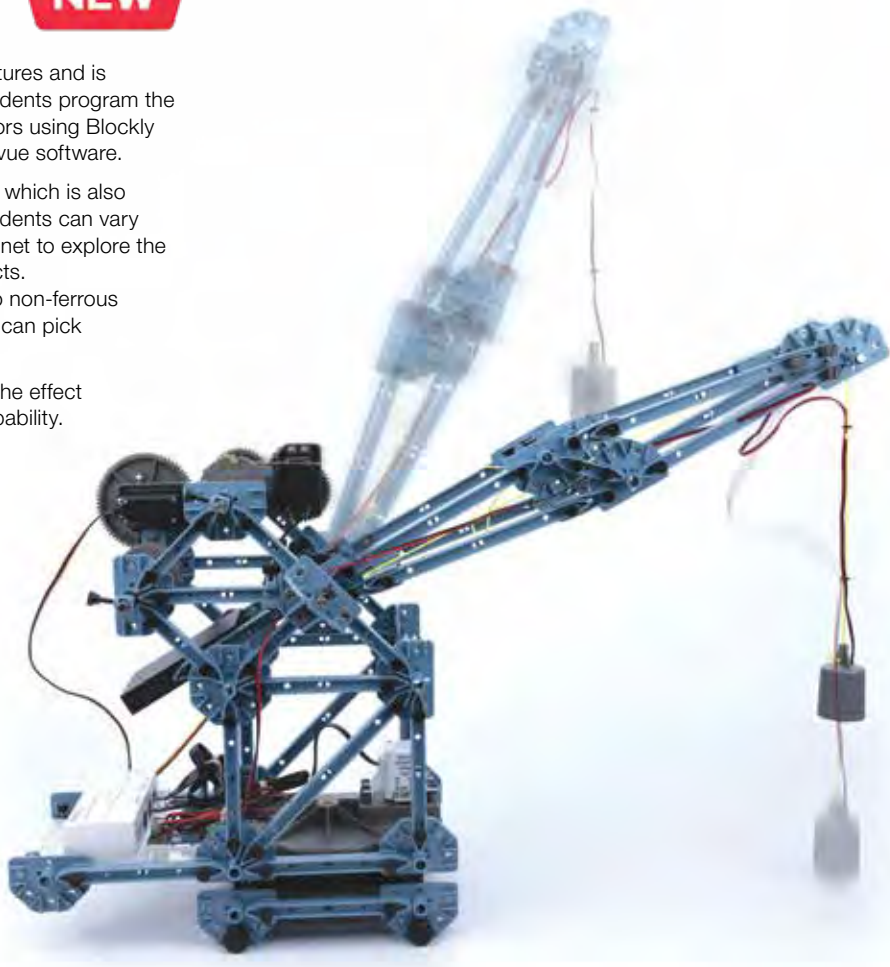

Includes:

- //control.Node (PS-3232)
- //code.Node (PS-3231)
- Low Speed Stepper Motor (PS-2978)
- Power Output Module (PS-3324)
- Servo Motor (2) (SE-2975)
- Gear Set (ME-7021)
- Turntable (ME-7024)
- Electromagnet (ME-7027)
- Structures I-Beams (45)
- Structures Connectors (26)
- Structures Counterweight (ME-7037)
- Truss Set Screws (2 sets of 75) (ME-6994)
- Axles (4)
- Small Pulley (2)
- Motor Mount (set of 2) (ME-7020)
- Spool and Bearings (2) (ME-7022)
- //control.Node Platform (ME-7042)
- 0.625-inch Steel Ball (2)
- Storage Box



Order Information

Motorized CraneME-7030

Motorized Drawbridge

NEW

ME-7028

Build this drawbridge from PASCO Structures, add a stepper motor and gears, and raise and lower it using code you write. This bridge kit also includes a Wireless Load Cell/Accelerometer that can be used to measure forces within the bridge while it moves.

Activities:

- Build the drawbridge.
- Raise and lower the drawbridge.
- Measure forces in top and bottom beams.
- Measure support forces.
- Explore the effect of the counterweight on motor acceleration.
- Explore the effects of different gear ratios.
- Use the load cell as a limit switch.
- Operate the drawbridge in response to a signal.

```

set stepper using units rev/s
for //control.Node :
  configure port A
  rotate stepper through
    angle (rev) 0.9
    to max ±speed (rev/s) -0.33
    with acceleration (rev/s²) 0.02
  Wait for completion
  sleep for 3000 ms
    
```



Students write Blockly code to control the drawbridge motion.

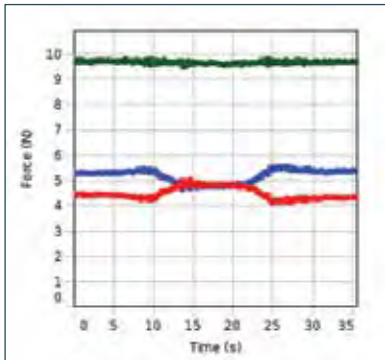

The load on the front bridge support (blue), the load on the back bridge support (red), and the total of the two loads (green) are plotted in real time as the bridge is raised and lowered.



Includes:

- //control.Node (PS-3232)
- Wireless Load Cell and Accelerometer (PS-3216)
- Low Speed Stepper Motor (PS-2978)
- Gear Set (ME-7021)
- Structures Counterweight (ME-7037)
- Structures I-Beams (40)
- Structures Connectors (18)
- Structures 6-32 Screws (100)
- Structures Long Axle (1)
- Motor Mount (1)
- Storage Box

Order Information

Motorized DrawbridgeME-7028

StructureBOT Kit

ME-7029

NEW

The StructureBOT is built by students using PASCO Structures. The stepper motors and servo motors that make it move are controlled using a //control.Node connected to a computer through Bluetooth®. Students program the bot using Blockly coding embedded in PASCO Capstone or SPARKvue software.

Activities:

- Build the StructureBOT.
- Move the Bot forward and backward.
- Turn the Bot.
- Power steer the front wheel.
- Move objects with the Gripper.
- Build a two-wheel Bot.

Further Exploration:

- Add a Wireless Motion Sensor to avoid obstacles.
- Add two Light Sensors to follow a line.
- Add a //code.Node to steer the Bot.
- Add a //code.Node for turn signals.
- Add a Wireless Light Sensor to sort colored objects.

Features:

- Multiple configurations: With and without the gripper, two wheels or three wheels, front-wheel steering or dual back-wheel steering
- Expandability: Add other PASCO Structures components to change the StructureBOT's design
- Expandability: Add other PASCO sensors to expand the bot's capabilities



Includes:

- //control.Node (PS-3232)
- High Speed Stepper Motor (2) (PS-2976)
- Servo Motor (2) (SE-2975)
- Structures Gripper (ME-7025)
- Gear Set (ME-7021)
- Caster Wheel (ME-7023)
- Structures Hinge (ME-7026)
- Truss Set Screws (set of 75)
- Structures I-Beams (14)
- Structures Connectors (7)
- Structures Full-Round Connector (2)
- Structures Wheels with Tires (2)
- Structures Medium Axle
- Motor Mount (3)
- //control.Node Platform

Order Information

StructureBOTME-7029

Motor Mount (Set of 2)

NEW

ME-7020

Mount motors to PASCO Structures using the Motor Mount. The Motor Mount fits either a PASCO Stepper Motor or regular size servo motor.

The included spline shaft adapter fits onto the spline of the motor to create a shaft that fits through a hole in the Motor Mount. The motor attaches to the motor mount with four screws. The Motor Mount has the same connection features (pin and screw hole) that the Structures I-beams have so it can be attached to any Structures connector.

The Motor Mount is also used to mount the gripper arms on the Structures Gripper.



Order Information	
Motor Mount (Set of 2).....	ME-7020

Spool and Bearings

NEW

ME-7022

This two-step spool is used to make a powered winch with PASCO Structures. The spool is secured onto a Structures axle with the included anti-backlash screw. The axle passes through the two included plastic bearings that are screwed to the Structures connectors. These bearings ensure smooth rotation of the axle.

String can be wrapped around either step of the spool to explore the difference in speed and torque made by the spool's diameter.



Order Information	
Spool and Bearings.....	ME-7022

Gear Set

NEW

ME-7021

These three pairs of gears are driven by stepper motors or servo motors to make PASCO Structures move. These three pairs enable three different gear ratios (1:1, 2:1, 4:1) with the same shaft separation, making it easy to change gear ratios.

The gears are secured on the motor shaft or PASCO Structures axles using the included anti-backlash screws.

The 60T and 72T gears have the hole and threaded hole features that allow a Structures I-beam to be attached directly to the gear.



Order Information	
Gear Set	ME-7021

Caster Wheel

NEW

ME-7023

The Caster Wheel is part of the Motorized StructureBot but can also be purchased separately to add to your own PASCO Structures designs.



Turntable

NEW

ME-7024

The Turntable is designed to rotate cranes made from PASCO Structures. Add a stepper motor to drive the gear mechanism. Connect any structure built with a square composed of #3 I-beams and connectors.



Order Information	
Caster Wheel	ME-7023
Turntable	ME-7024

Structures Gripper

NEW

ME-7025

Add the Gripper to PASCO Structures to grab objects. Attach a stepper motor or servo motor to the Gripper to drive the gear that opens and closes the Gripper arms. The Gripper has the same pin and screw features used to connect a Structures I-beam to a connector, making it easy to attach the Gripper to any existing PASCO Structure.

Features:

- Gripper mounts to PASCO Structures using the same pin and screw features that are used to connect an I-beam
- Elastic bands add gripping friction
- The //control.Node can detect the increase in servo current so you can tell when the Gripper has closed on an object.



Order Information	
Structures Gripper	ME-7025

Structures Hinge

NEW

ME-7026

Use the Hinge with the Structures to make movable joints. The Hinge is designed to be used with the PASCO Structures axles and the Hinge can be locked into place on the axle with two screws. The Hinge has attachment features for up to three Structures I-beams.



Structures Counterweight

NEW

ME-7037

The Counterweight is used to offset the weight of drawbridges and cranes, making them more balanced and requiring less torque to move. Each side has a 6-32 threaded hole and two non-threaded holes that match the same form factor as the Structures I-beam connectors. This allows the Counterweight to be held onto the Structures using I-beams and 6-32 screws.



Order Information	
Structures Hinge.....	ME-7026
Structures Counterweight	ME-7037

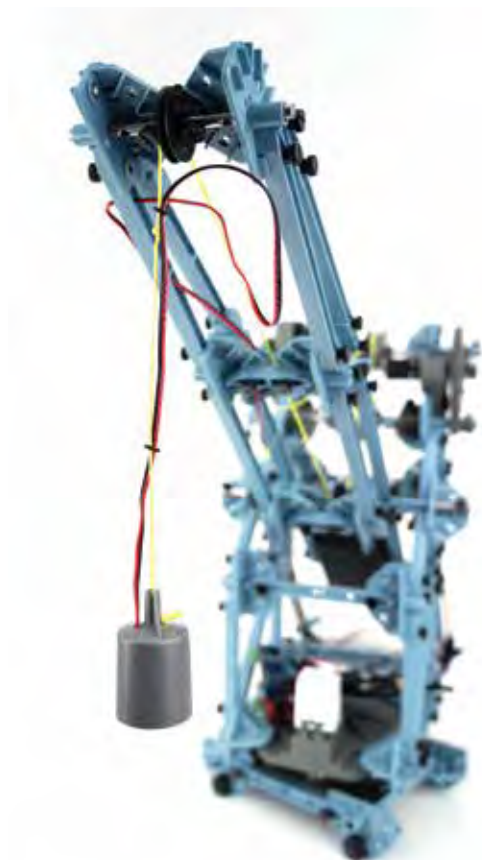

Electromagnet

NEW

ME-7027

This Electromagnet can be attached to a winch on a Structures crane to pick up objects. The Electromagnet is powered using a Power Output Module plugged into a //control.Node.

The Electromagnet includes steel washers and stickers to attach to an object so the Electromagnet will be able to pick up a non-ferrous object such as a paper cup.

Vary the power to the Electromagnet by varying the duty cycle of the applied 5 volts.



Order Information	
Electromagnet	ME-7027



Biology Educational solutions for General, AP®, IB®, and Honors Biology courses

Hands-On Solutions for Your Biology Lab

Engage your biology students in the thrill of discovery with world-class solutions from PASCO. Our reliable sensors, labs, and software empower students to think like real-life biologists as they form hypotheses, investigate phenomena, and analyze data to make sense of the world around them. With flexible solutions for General, AP®, IB®, and Honors Biology courses, you're sure to find a PASCO solution that's right for you.

Biology Index

Biology Starter Lab Station 37
 Advanced, AP® & IB® Biology 38
 Weather with GPS and Soil Moisture..... 40
 Temperature and pH..... 41
 Conductivity and Pressure..... 42
 Light, Diffusion/Osmosis 43
 CO₂ and O₂ 44
 Optical Dissolved Oxygen and Photosynthesis Tank.. 45
 EcoZone System and Colorimeter/Turbidity..... 46
 Wireless Spectrometer and UV-Vis Spectrometer 47
 Hand-Grip & Exercise Heart Rate, Blood Pressure 48
 Spirometer and EKG 49
 AirLink Interface and Human Eye Model 50
 Digital Microscopes & Microscope Cameras..... 51

World Class Support and Professional Development - Committed to Your Success!

We want you to have all the support, guidance, and training you need. Just let us know how we can help.

Biology Starter Lab Station

EB-6334

The Biology Starter Lab Station makes it easy and affordable to begin using sensor-based technology in your biology lab or classroom. Designed for convenience, the Biology Lab Stations contain the wireless sensors used to perform 10 Biology labs, plus many of the labs in our Essential Biology Lab Manual. The ten explorations range from the cellular to organismal level and investigate processes such as respiration, photosynthesis, enzymatic activity, membrane permeability and osmosis. Students can also investigate cell size, body regulation, and the impacts of environmental factors on reaction rates and organism responses.



Biology Station Lab Titles

The Biology Starter Lab Station supports 7 of the 10 labs. Add the Extension Lab Station* to do all 10 lab titles.

1. Enzyme Action

2. Membrane Permeability

3. Osmosis

4. Plant Respiration & Photosynthesis*

5. Respiration of Germinating Seeds

6. Acid Rain

7. Regulation of Body Heat

8. Plant Pigments*

9. Cell Size*

10. Cellular Respiration in Yeast

The Biology Starter Lab Station includes these wireless sensors and materials:

- Temperature
- Pressure
- pH
- CO₂
- Storage Case
- Lab Manual

**To do the remaining 3 labs listed above and another 4 labs from the Essential Biology Lab Manual, add the Extension Lab Station (see page 35) and the Essential Biology Through Inquiry Lab Manual.*



The Biology Starter Lab Station

Order Information

Biology Starter Lab Station.....EB-6334

Essential Biology Teacher Lab Manual.....EB-6331



Essential Biology Teacher Lab Manual

EB-6331

This printed lab manual includes 23 lab activities that can be edited to suit the needs of your students or to better coordinate with your classroom lectures. Each complete investigation includes a teacher guide and student handout. Student handouts include procedural instructions, blank graphs and tables for data entry, as well as analysis questions with space for students to record their answers. Each investigation is tightly integrated with our innovative software, sensors, and equipment.

- Enzyme Action (Pressure Sensor)
- Enzyme Action (Oxygen Sensor)
- Membrane Permeability
- Organisms and pH
- Osmosis
- Plant Respiration and Photosynthesis
- Respiration of Germinating Seeds
- Buffers in Biological Systems
- Acid Rain
- Cellular Respiration in Yeast
- Energy Content of Food
- Metabolism of Yeast
- Photosynthesis of Aquatic Plants
- Soil pH
- Transpiration
- Water and pH
- Water Purification
- Weather in a Terrarium
- EKG: Factors that Affect the Heart
- Exercise and Heart Rate
- Exercise and Blood Pressure
- Muscle Strength
- Regulation of Body Heat
- Volume of Breath

Advanced Biology Through Inquiry Labs for AP[®] & IB[®]

PASCO's award-winning Advanced Biology through Inquiry Teacher Guide is newly revised and contains 18 labs that have been specifically designed to support student inquiry, as well as AP[®] and IB[®] curriculum*. This manual is available in a print version and an all-digital version.

- Most labs can be completed in one lab session with readily available materials, including the Biology Lab Stations on the opposite page.
- Easy and meaningful data collection leads to increased time for data analysis and discussion.
- Labs integrate high-order analysis and synthesis questions.
- Includes sample data for investigations and inquiry, answers to analysis and synthesis questions, an assessment rubric, teacher tips, lab preparation information, and more.

Advanced Biology Lab Experiments	Starter Lab Station (EB-6334)	Starter and Extension Lab Stations (EB-6334, EB-6335)	IB [®] Standards*	Targeted AP [®] Learning Objectives*
1A. Enzyme Activity (Oxygen)	●	●	2.5	1-2.B; 2-1.F; 2-1.G; 4-3.A
1B. Enzyme Activity (Pressure)		●	2.5	1-2.B; 2-1.F; 2-1.G; 4-3.A
1C. Enzyme Activity (Spectrometer)**		●	2.5	1-2.B, 2-1.F, 2-1.G, 4-3.A
2. Diffusion	●	●	1.4; 10.3	2-1.C; 2-2.C; 2-2.F; 2-2.I
3. Osmosis		●	1.4	2-1.C; 2-2.C; 2-2.F; 2-2.H; 2-2.I; 2-3.A; 2-3.B; 2-3.D; 3-3.A; 3-3.B
4. Plasmolysis		●	1.4	2-2.D; 2-2.F; 2-2.H; 2-2.I
5. Cell Size		●	1.1	1-2.B; 2-1.A; 2-1.B; 2-2.I
6. Homeostasis	●	●	N/A	2-1.M; 2-3.A; 2-3.B, 2-3.D; 3-3.A; 4-3.D
7. Cellular Respiration	●	●	2.8	1-2.B; 2-1.H; 2-1.K; 2-2.K; 4-1.E; 4-1.F
8. Photosynthesis	●	●	2.9	2-1.A; 2-1.I; 2-1.J; 2-1.O; 4-3.A
9. Plant Pigments		●	2.9	2-1.A; 2-1.J; 2-1.J; 2-2.A; 2-2.K; 2-4.C; 4-1.F; 4-3.A
10. Transpiration	●	●	9.1	2-1.A; 2-2.H; 2-2.I; 2-3.A; 2-3.D; 4-3.D
11. Mitosis	No sensors required		1.6	3-1.B; 3-1.C; 3-1.D; 3-1.K
12. Meiosis			3.3; 10.1	3-1.F; 3-1.G; 3-1.H; 3-1.I; 3.1K; 3-4.A; 4-3.C
13. Energy Dynamics	●	●	4.2	2-1.A; 2-1.H; 2-1.I; 2-4.B; 4-1.G
14. Artificial Selection	No sensors required		N/A	1-1.C; 1-1.D; 1-1.E; 1-1.F; 1-3.A
15. BLAST Bioinformatics			3.1; B.5	1-1.H; 1-1.M; 1-1.N; 1-2.B; 1-2.C; 1-3.A; 1-3.B; 1-3.C
16. Population Genetics			10.3	1-1.C; 1-1.H; 1-1.I; 1-1.K; 1-1.M
17. Mathematical Modeling of Evolution			10.3	1-1.C; 1-1.E; 1-1.H; 1-1.K; 1-1.L; 1-3.A
18. Animal Behavior			A.4	2-3.D; 2-4.B; 3-5.A; 4-1.G

* AP is a registered trademark of the College Board, which was not involved in the production of, and does not endorse, this product. IB is a registered trademark of the International Baccalaureate Organization, which was not involved in the production of, and does not endorse, this product.

** Requires Spectrometer (PS-2600), sold separately.

Order Information

Advanced Biology Through Inquiry Teacher Guide PS-2852A

Includes lab prep instructions, expected answers/results, and editable student files. Manual is available in eco-friendly digital format or in print.



Biology Lab Stations Support Advanced Biology

The Biology Starter and Extension Lab Stations, together with PASCO's *Advanced Biology Through Inquiry Lab Manual*, offer a truly complete Biology solution. With over 25 sensor-based labs that cover a range of Biology and Advanced Biology topics, plus all of the equipment and apparatus required to conduct the labs hands-on, inquiry with data collection and analysis has never been easier or more affordable. For investigations in Physiology, add the Physiology Bundle and extend your studies even further.



Biology Station Lab Titles

Together, the Biology Starter and Extension Lab Stations support over 20 Advanced Biology labs. Conduct the 10 labs below right out of the box.

1. Enzyme Action

2. Membrane Permeability

3. Osmosis

4. Plant Respiration & Photosynthesis

5. Respiration of Germinating Seeds

6. Acid Rain

7. Regulation of Body Heat

8. Plant Pigments

9. Cell Size

10. Cellular Respiration in Yeast



Biology Starter (left) and Extension Lab Stations (right)

The Biology Starter & Extension Lab Stations include these wireless sensors and materials:

- Temperature
- Pressure
- pH
- CO₂
- Storage Case
- Lab Manual*
- Optical Dissolved Oxygen
- Colorimeter & Turbidity
- Conductivity Sensor
- EcoChamber



Physiology Extension Bundle

PS-2935D

The Physiology Extension Bundle enables students to study the heart cycle, lung function, human respiration, stimulus and response, homeostasis, and more! This bundle includes a Wireless EKG Sensor, a Wireless Spirometer, Spirometer Mouth Pieces, a Wireless Blood Pressure Sensor with Standard Cuff, and a Wireless Hand-Grip Heart Rate Sensor.

1. Wireless EKG Sensor PS-3236
2. Hand-Grip Heart Rate PS-3206
3. Wireless Blood Pressure PS-3218
4. Wireless Spirometer PS-3234
5. Spirometer Mouth Pieces PS-2522



Order Information

- Biology Starter Lab Station.....EB-6334
 Biology Extension Lab StationEB-6335
 Wireless Physiology Extension Bundle.....PS-2935D

Biology Starter and Extension Lab Stations come standard with 10 Essential Biology Through Inquiry Labs. The Advanced Biology Through Inquiry Lab Manual is sold separately (see page 38 for order information).



Wireless Weather Sensor with GPS

PS-3209

The Wireless Weather Sensor is an all-in-one instrument for monitoring complex environmental conditions. It houses several sensing elements within a single unit to provide 19 different measurements. Use the sensor in logging mode with the Weather Vane Accessory for long-term monitoring, or use it as a handheld instrument to study microclimates and local phenomena. The collected data can be wirelessly exported to most devices, including classroom device dashboards, making it easier to support group activities that are constrained by time. Plus, with the built-in GPS, students can collect and analyze location data using the SPARKvue map display, powered by ESRI ArcGIS.



Student-friendly weather dashboard to visualize its multiple sensors.

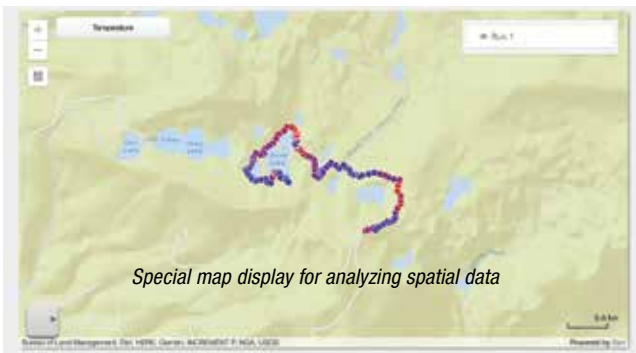

Special map display for analyzing spatial data



With ESRI's ArcGIS online you can visualize data in seconds with a FREE account!



Weather Vane Accessory sold separately.

Order Information

Wireless Weather Sensor with GPSPS-3209

Wireless Weather Sensor with GPS PackPS-3340

Note: Price for multi-sensor packs includes 8 sensors and custom storage case.

Weather Vane AccessoryPS-3553

Wireless Soil Moisture Sensor

PS-3228

The Wireless Soil Moisture Sensor measures the volumetric water content (%VWC) of soil, reporting data in real time or storing it onboard the sensor's memory for long-term experiments. Durable and easy to use, the Wireless Soil Moisture Sensor is the perfect tool for monitoring controlled experiments in the classroom and long-term experiments outdoors. From experiments in evaporation and soil composition to water consumption and plant competition, the Wireless Soil Moisture Sensor makes it easy for students to investigate a wide array of topics over the course of minutes, hours, or days!

Features:

- Collect and display data in real time within PASCO Capstone or SPARKvue software
- Automate data collection for hours, days, or weeks with remote Logging Mode
- Bluetooth connectivity enables use in the classroom, lab, or field
- Supports use of GPS data from a mobile device for GIS mapping activities
- Selectable calibrations for predominantly sandy soils, clay soils, and loamy soils



Order Information

Wireless Soil Moisture SensorPS-3228



Wireless Temperature Sensor

Wireless pH Sensor

PS-3201

PS-3204

Welcome to the modern thermometer. The Wireless Temperature Sensor transmits live data and allows students to continuously monitor, log, and plot temperature measurements on nearly any device. When lab-time ends but the experiment continues, students can set the sensor to log data autonomously for days, weeks, or months, then download it for analysis later. This durable, wireless sensor features a stainless steel probe for the most demanding of applications, as well as a battery that lasts over a year*. It can be used in a wide array of experiments and activities because it measures small, but significant temperature changes produced by chemical reactions, convection currents, and even skin temperatures.

The Wireless pH Sensor is a must-have for any chemistry, biology, or environmental science course. Equally capable in the lab or field, the sensor eliminates the hassle of cables, reducing spills and improving safety. Plus, it rarely requires charging; the sensor's coin cell battery lasts for 2-3 years in most labs and costs about one dollar to replace. It can transmit data in real time, or store data for days when continuous monitoring is required. The Wireless pH Sensor enhances countless activities, including acid-base titrations, investigations into household chemicals, analyses of chemical reactions, water quality studies, and much more.

Features:

Features:

- Simply pair and go, no cables or adapters to manage
- Variable sampling rate for capturing small, fast changes or experiments that run for hours, days, or weeks
- Bluetooth® connectivity and long-lasting coin cell battery
- Logs temperature data directly onto the sensor for long-term experiments
- Dust, dirt, and sand-proof and water resistant (IP-X7 certified)

- Simply pair and go, no cables or interfaces to manage
- Compatible with ion-selective electrodes (ISE) and the oxidation reduction probe (ORP)
- Bluetooth® connectivity and a long-lasting coin cell battery
- Logs pH data directly onto the sensor for long-term experiments
- Wirelessly connects to SPARKvue and PASCO Capstone for convenient analysis and lab reports

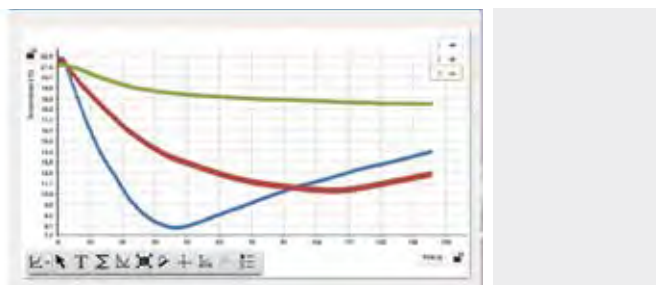

SPARKvue lets students get the most out of their measurements, displaying them as digits, graphs, tables, or bar charts.



Order Information

Wireless Temperature Sensor.....PS-3201
 Wireless Temperature Sensor Pack.....PS-3330

Note: Price for multi-sensor packs includes 8 sensors and custom storage case.

Order Information

Wireless pH Sensor.....PS-3204
 Wireless pH Sensor Pack.....PS-3331

Note: Price for multi-sensor packs includes 8 sensors and custom storage case.



Wireless Conductivity Sensor

PS-3210A

The Wireless Conductivity Sensor measures the electrical conductivity of an aqueous solution. It is ideal for investigating the properties of solutions, including total dissolved solids (TDS) for water quality inquiry. Because it is temperature compensated, calibrations are less frequent and can be applied across a range of temperatures. With an improved range of 0 to 40,000 $\mu\text{S}/\text{cm}$, this sensor can be utilized for chemical, biological, and environmental studies.

Teacher tip: To measure brackish or marine samples, perform a dilution until the measurement falls within the range, then multiply to determine sample conductivity.

Features:

- Measure conductivity and total dissolved solids
- Automatic temperature compensation
- Battery life >1 year
- Remote logging with built-in memory
- Dust-proof, sand-proof, and water-resistant (1 meter for 30 minutes)



Order Information

Wireless Conductivity SensorPS-3210A

Wireless Conductivity Sensor Pack.....PS-3332

Note: Price for multi-sensor packs includes 8 sensors and custom storage case.



Wireless Pressure Sensor

PS-3203

The Wireless Pressure Sensor allows students to easily collect accurate gas pressure data for a wide range of applications. Included is a 60cc syringe, tubing, and connectors that facilitate experiments such as Boyle's Law or measuring pinch-grip strength. Within PASCO's software, students can easily select their desired units from a list containing kPa, mmHg, inHg, mbar, psi, atm, and torr.

Features:

- Measures pressure even when the pressure within the system drops below ambient pressure
- Supports common units (kPa, atm, psi, mmHg, or N/m^2) for many applications
- Bluetooth® connectivity and long-lasting rechargeable battery

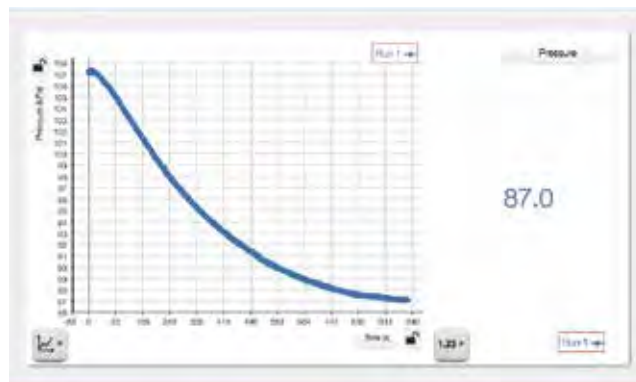

Order Information

Wireless Pressure SensorPS-3203

Wireless Pressure Sensor PackPS-3333

Note: Price for multi-sensor packs includes 8 sensors and custom storage case.



Wireless Light and Color Sensor

PS-3248

The Wireless Light and Color Sensor features two separate apertures: One measures ambient light from the side of the box, and the other measures percent color of directional light at the end of the box.

Features:

- Wirelessly connects to computers, Chromebooks, tablets, and smartphones
- Simply pair and go, no cables or adapters to manage
- On-board memory enables the sensor to function as an independent datalogger
- Variable sampling rate for short, precise experiments or lengthy, multi-day data collection
- Bluetooth® connectivity and long-lasting coin cell battery
- Indirect PAR measurements for biological studies



Order Information

Wireless Light and Color Sensor.....PS-3248
 Wireless Light Sensor Pack.....PS-3338

Note: Price for multi-sensor packs includes 8 sensors and custom storage case.



Diffusion/Osmosis Kit

ME-6942

It is an image that appears in practically every biology text to help students with conceptual understanding: a U-shaped tube with a permeable membrane separating a hypotonic and hypertonic solution. And yet few classroom methods of studying osmosis take advantage of this simple and elegant design for lab work.

Features:

- Plastic rather than glass columns for durability and student safety
- Free standing unit requires no additional lab equipment to hold it in place
- Air tight joints prevent pressure leaks
- Membranes are quick and easy to replace when compromised
- Graduated transparent columns allow changes in volume to be seen and quantified
- The U-shaped design provides familiarity for students and the straight columns keep the volume of gas above the fluid constant
- Great for determining colligative effects on osmotic pressure

Wireless Temperature Sensor Link

PS-3222

The Wireless Temperature Sensor Link enables wireless connection for any PASCO temperature probe with a 3.5 mm connection. The link comes with a Fast Response Temperature Probe, but it can also connect to the Stainless Steel Temperature Probe, Skin/Surface Temperature Probe, the Absolute Zero Sphere, and the Ideal Gas Law Apparatus.



Order Information

Diffusion/Osmosis Kit.....ME-6942
 Wireless Temperature Sensor Link.....PS-3222



Wireless CO₂ Sensor

PS-3208

Measure changes in carbon dioxide (CO₂) gas levels quickly and easily with the Wireless CO₂ Sensor. This temperature-compensated sensor can operate in high humidity environments and employs live data to make core labs, such as photosynthesis, cellular respiration, and metabolism experiments engaging and impactful. With the ability to store more than 55,000 data points, the Wireless CO₂ Sensor also supports long-term studies of carbon cycling that span the course of a single night or an entire weekend. Includes 250-mL sample bottle that allows gases to be analyzed with multiple sensors.

Features:

- Logging ability for long-term experiments, store up to 55,000 data points
- Integrated stopper for use with included sample bottle and common glassware
- Temperature compensated for increased accuracy



Order Information

Wireless CO₂ Sensor (Carbon Dioxide)PS-3208

Wireless CO₂ Sensor PackPS-3341

Note: Price for multi-sensor packs includes 8 sensors and custom storage case.

Wireless Oxygen Gas Sensor

PS-3217

The Wireless Oxygen Gas Sensor measures gaseous O₂ concentrations as well as humidity and air temperature for a range of biology, environmental science, and physiology activities.

The Wireless Oxygen Gas Sensor is accurate and easy to use, making it the perfect sensor for studying photosynthesis, respiration, and oxygen cycling in a closed or open system. With remote logging, experiments can go beyond the lab period and easily give students hours or days of data for analysis. In addition to measuring oxygen gas levels, the Wireless Oxygen Gas Sensor also contains sensors to measure ambient temperature and humidity.

Features:

- Bluetooth® and USB connectivity
- 0-100% Oxygen Gas Concentration
- ±1% Oxygen at constant temperature and pressure
- Also reports ambient temperature and humidity
- 2-3 year operating life with replaceable sensing element

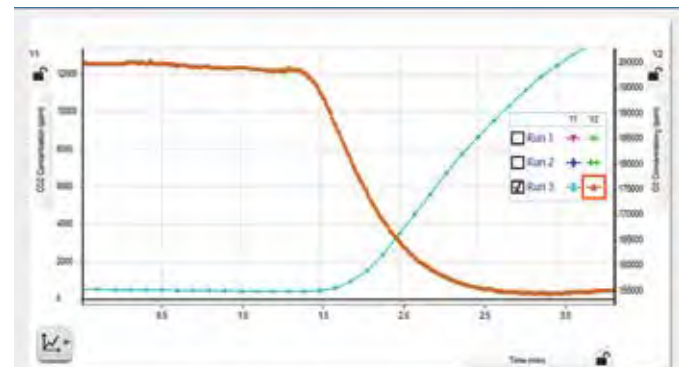

Metabolism Chamber

ME-6936

The Metabolism Chamber is a 250 mL sample bottle with 2 holes cut specifically for PASCO gas sensors to allow simultaneous measurements of carbon dioxide gas and oxygen gas.



Order Information

Wireless Oxygen Gas SensorPS-3217

Metabolism ChamberME-6936



Photosynthesis Chamber

PS-3251

PASCO's Wireless Optical Dissolved Oxygen Sensor (PS-3246) allows students to monitor most common photosynthesis experiments. Typical experiments require students to infer photosynthetic rate changes by using chloroplasts and dye. Help your students better understand photosynthesis via direct measure of oxygen while controlling light, temperature or nutrients. Ideal for exploring aquatic plants, algal beads, and even the consumption of oxygen by respiration.

The lid features three convenient ports for sensors; stoppers are included to maintain a closed system. The ports will accommodate Wireless Temperature Sensor (PS-3201), Wireless Conductivity (PS-3210A), Wireless pH Sensor (PS-3204) or other ion selective electrodes for additional measurements. A clear inner chamber allows full sunlight exposure, or set into an outer cover chamber to block out light.



Dual chambers allow sample to set in temperature controlling water bath.

Nine separate LED lights (white, red, green or blue) allow students to test these variables and others such as plant nutrient uptake and elimination

Order Information

Photosynthesis ChamberPS-3251

Wireless Optical Dissolved Oxygen Sensor

PS-3246

The Wireless Optical Dissolved Oxygen (ODO) Sensor is ideal for monitoring DO₂ in the lab or field. The Wireless Optical DO Sensor contains three different probes. In addition to the dissolved oxygen sensor, it also includes probes for measuring atmospheric pressure and water temperature. The optical technology is accurate, fast, and does not require stirring, filling solutions, warm-up, or frequent calibration.

NOTE: The included waterproof probe is submersible to a depth of 2.5m. The (white) wireless sensor box is not waterproof.



Order Information

Wireless Optical Dissolved Oxygen Sensor (NEW!)PS-3246

EcoZone System

ME-6668

PASCO's EcoZone System is designed to help students model and understand complex interactions within, and among, different ecosystems. The three clear, acrylic EcoChambers are specially designed to accommodate PASCO sensors, making qualitative and quantitative measurements easily accessible. The three chambers connect to allow students to study up to three different ecosystems.

Features:

- Total volume of each chamber is 4534 cubic centimeters
- Sturdy construction designed for easy setup and cleanup
- Quantitatively study the interaction of different ecosystems
- Custom molded for use with PASCO sensors
- Clear acrylic allows for observations from all sides

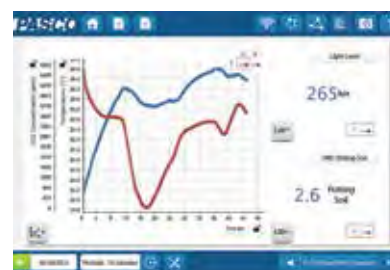

Order Information

EcoZone SystemME-6668
EcoChamberME-6667



Wireless Polarimeter

PS-3237

The Wireless Polarimeter has both Bluetooth® and USB connectivity, making it possible to analyze chiral compounds with your iPad®, Chromebook™, Android tablet, or computer. It is ideal for introductory experiments in Organic Chemistry and Biochemistry, where chiral compounds are of special interest.

PASCO's Wireless Polarimeter passes plane polarized light through a vertical sample, which contains a chiral compound, followed by an analyzer and detector. The optical rotation is determined by finding the angle between the starting position and the location where the optimum light level transmits through the cross polarizer. Students can use the rotation data to calculate the concentration of a chiral sample, while the specific rotation (amount turned per g/ml dissolved) is an intrinsic property that can be used to differentiate molecules or determine racemic mixtures.

Specifications:

- **Connectivity:** Bluetooth and USB
- **LED light source:** 589 nm
- **Optical Rotation Accuracy:** $\pm 0.09^\circ$
- **Cell Length:** 101.3mm \pm 0.8mm

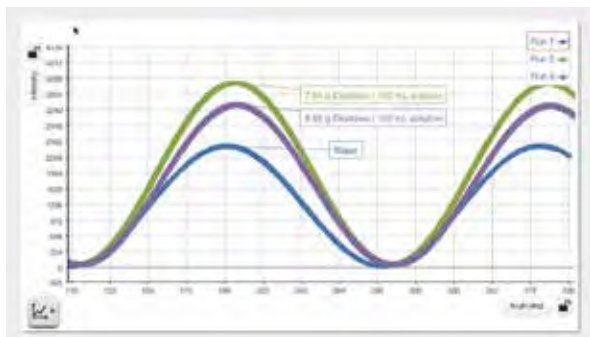

Order Information

Wireless PolarimeterPS-3237



Wireless Colorimeter & Turbidity Sensor

PS-3215

The Wireless Colorimeter & Turbidity Sensor simultaneously measures the absorbance and transmittance of six different wavelengths. The sensor can be used to study Beer's Law (absorbance vs. concentration), enzyme activity, photosynthesis, and the rates of chemical reactions (absorbance vs. time). After a simple calibration, students can quickly begin viewing live measurements as they materialize across the visible spectrum at 650 nm (red), 600 nm (orange), 570 nm (yellow), 550 nm (green), 500 nm (blue), and 450 nm (violet).

This sensor also functions as a high-quality turbidimeter for water quality analysis. Rather than simply measuring transmitted light, the Wireless Colorimeter and Turbidity Sensor measures light scattered at a 90° angle from the sample, resulting in accurate and repeatable measurements. When used with our ezSample water test kits, chemical concentrations can be determined using the calibration curves included in PASCO software.

Features:

- Stabilized light source for consistent readings
- PASCO software displays the absorbance & transmittance at each wavelength in the appropriate color
- Quick and easy calibration
- Functions as both a colorimeter and turbidimeter
- Built-in calibrations report concentrations of Ammonia, Nitrate, Phosphate, and Iron in parts per million using ezSample Kits.



Measure the absorbance and transmittance of a solution at six different wavelengths... simultaneously!

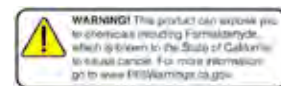

Order Information

Wireless Colorimeter & Turbidity SensorPS-3215

Includes USB charging cable, 9 cuvettes, 2 cuvette racks, and one 100 NTU calibration cuvette.

Wireless Colorimeter & Turbidity Sensor PackPS-3334

Note: Price for multi-sensor packs includes 8 sensors and custom storage case.



UV-Vis Spectrometer

SE-3607

The SE-3607 is an easy-to-use, wide range UV-Vis spectrometer that delivers fast, accurate and reliable performance for routine analyses in chemistry and biochemistry teaching labs. With USB connectivity and cross-platform Spectrometry Software, the PASCO UV-Vis Spectrometer improves collaboration between lab members, enabling data collected on a computer or laptop to be analyzed on tablets, iPads, and Chromebooks*. Additional accessories, such as the Quartz Fiber Optic Cable Set, can be used to extend the spectrometer's capabilities for the analysis of emission spectra, light sources, and the classification of lasers.

Highlights:

- Spectral scans from 180 to 1050 nm
- Award-winning Spectrometry software
- One-click light and dark calibrations
- Adjustable scan averaging, signal integration time, and smoothing
- Displays entire spectra with each scan
- Graphs Absorbance vs. Wavelength
- Graphs Intensity vs. Wavelength (emission spectra)
- Graphs Absorbance vs. Concentration (Beer's Law)
- Graphs Absorbance vs. Time (kinetics)

Wireless Spectrometer (VIS)

PS-2600A

The award-winning PASCO Wireless Spectrometer is specifically designed for modern chemistry, biology, and physics labs. It connects to student devices via USB or Bluetooth Low Energy and includes free Spectrometry software with built-in tools for spectral analysis. Scan times are fast, enabling students to collect a full spectrum of data in less than a second. Three plots are provided for common applications, including Absorbance vs. Wavelength (or Intensity vs. Wavelength), Absorbance vs. Concentration (Beer's law), and Absorbance vs. Time (kinetics).

Perform these labs with the PASCO Spectrometer:

- Photosynthesis with DPIP
- Absorption spectra of plant pigments
- Concentration of proteins in solution
- Rate of an enzyme-catalyzed reaction
- Growth of a cell culture



Includes USB charging cable, 10 cuvettes, and Spectrometry Software.



Semi-Micro Volume Cuvettes (Qty. 10), Cuvette Rack (EC-3590), USB-A to USB-B Cable, External AC Adapter, 24 V Power Supply, Foam Lined Carrying Case (ABS).

UV Quartz Cuvettes (Qty. 2)



Sold Separately

UV-Vis Fiber Optic Cable Set



Sold Separately

Order Information

Wireless Spectrometer (Vis)PS-2600A

Order Information

UV-Vis SpectrometerSE-3607
 UV Quartz Cuvettes (Qty. 2)SE-3611
 UV-Vis Fiber Optic KitSE-7182



Wireless Hand-Grip Heart Rate Sensor

PS-3206

With these wireless hand grips, conducting physiology labs on the cardiovascular system or homeostasis is easier than ever before. Continuously monitor heart rate during exercise, or use the sensor to take initial and final measurements with fast and reliable heart rate detection.



Order Information

Wireless Hand-Grip Heart Rate SensorPS-3206

Wireless Exercise Heart Rate Sensor

PS-3207

The Wireless Exercise Heart Rate Sensor has a chest strap and will transmit data wirelessly up to 10 m away! The electrode belt fits around the ribcage (worn against the skin for best results, but can be worn over a shirt if a drop of saline solution is applied under the electrodes). Live and recorded data can be analyzed using any device with PASCO software installed.



Order Information

Wireless Exercise Heart Rate SensorPS-3207



Wireless Blood Pressure Sensor with Standard Cuff

PS-3218

PASCO's Wireless Blood Pressure Sensor allows students to quickly and easily measure both systolic and diastolic arterial blood pressure (mmHg) as well as heart rate (pulse in bpm). Comparing the digits display for systolic and diastolic pressure with the display of blood pressure from the real-time graph helps students gain a contextual understanding of the physiology of blood pressure.



Observe heart rate plus systolic and diastolic blood pressure



Order Information

Wireless Blood Pressure Sensor with Standard Cuff.....PS-3218



Wireless Spirometer

PS-3234

The Wireless Spirometer Sensor makes it safe and easy for students to collect respiratory measurements, including flow rate, pressure, and lung volume. Ideal for studies in health and human physiology, the Wireless Spirometer Sensor streamlines experiments by providing students with real-time data, interactive graphs, and intuitive analysis tools right on their devices. The disposable mouthpieces are designed for use with a single student and feature exchangeable filters that protect the sensor from particulates for maximum safety. Additional mouthpieces are available in convenient packs of ten.

Features:

- Bi-directional air flow (inspiration and expiration)
- Minimal resistance to air flow
- Displays volume in liters
- Exchangeable filter and disposable, hygienic mouthpieces

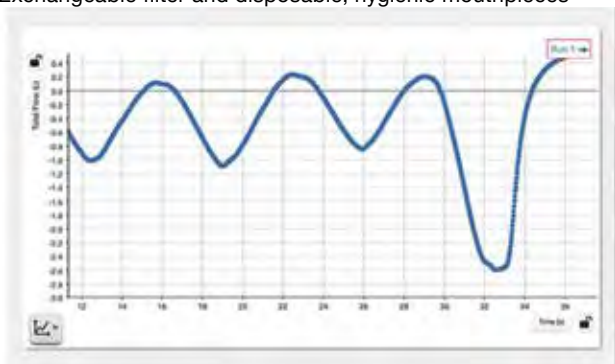

Wireless EKG Sensor

PS-3236

The Wireless EKG Sensor measures electrical signals produced by contractions of the heart or muscles, and reports them in real-time on virtually any student device. The perfect sensor for fast-paced physiology courses, the EKG Sensor provides students with real-time feedback as they explore the effects of various stimuli on cardiac or muscular activity. Heart Rate data is reported in beats per minute (BPM), while the voltage (mV) detected from cardiac contractions is intuitively displayed in an EKG trace.

Features:

- Standard three-electrode design
- Easy-to-use, disposable stick-on electrodes
- No messy gel required
- Great for stimulus response reflex studies

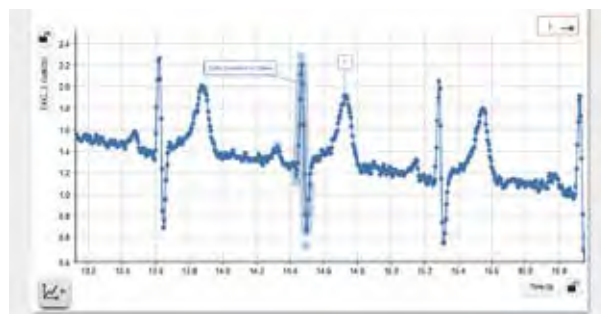

Order Information

Wireless Spirometer.....	PS-3234
Spirometer Mouthpiece Replacements (10).....	PS-2522
Spirometer Mouthpieces & Pre-Filters.....	PS-3245

Order Information

Wireless EKG Sensor.....	PS-3236
--------------------------	---------

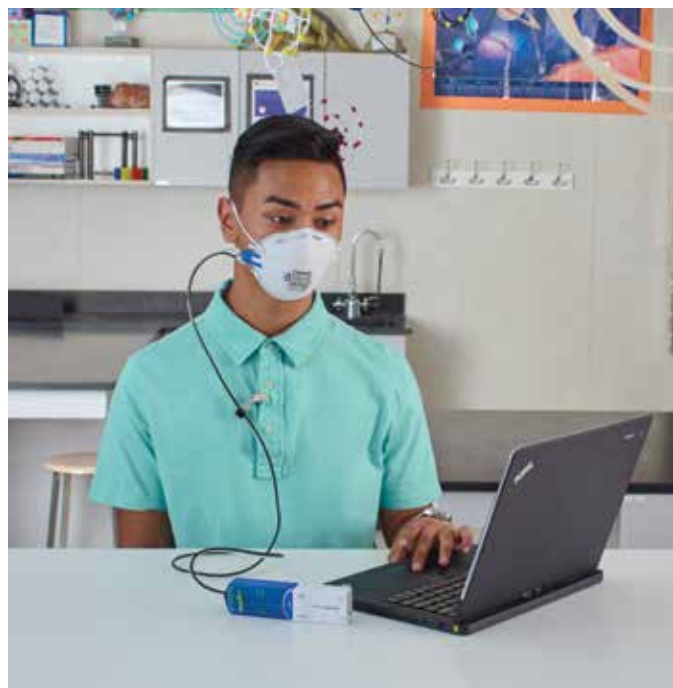

Go Wireless with PASPORT Sensors

PASCO's AirLink Interface connects PASPORT (blue) sensors to your computer using Bluetooth or USB technology.



AirLink Interface

PS-3200

The AirLink connects PASPORT sensors to a Mac or Windows computer, Chromebook, iPad, tablet, or smartphone via Bluetooth or USB connection. The USB cable is included.



Order Information	
AirLink Interface	PS-3200



Human Eye Model

OS-8477A

The Human Eye Model makes it easy for students to explore the physiology behind human sight through hands-on manipulation. Investigate normal vision, far-sightedness, and more!

Features:

- **Working Model of the Human Eye:** Two lenses are used to form images on the retina. Sealed tank holds water to simulate the vitreous humor. Size and orientation of the illuminated object can be easily measured.
- **Study the Optics of Normal Vision and Vision Correction:** Use the included plastic lenses to create images for normal vision, far-sightedness, near-sightedness, and astigmatism. Additional lenses are placed in front of the eye to correct for vision problems.
- **Fixed Corneal Lens and Interchangeable Crystalline Lens:** The crystalline lens is surrounded by water (vitreous humor). By changing the crystalline lens, the eye can focus on both near and far objects.
- **Movable Retina:** Three positions demonstrate near-sightedness, far-sightedness, and normal vision.
- **Variable Pupil Size:** Students can observe changes in image brightness and clarity as the pupil size is reduced.



Includes molded plastic eyeball, plastic lenses (two sets of 6), pupil aperture, adjustable focal lens, retina screen, optics caliper (1), syringe, and experiment manual.

Order Information	
Human Eye Model.....	OS-8477A

Standard Compound Optical Microscope

SE-6213

Standard optical microscope great for general viewing of cell structures at 40x, 100x, 400x viewing. Gives insights to topics from Biology, Life Science, Anatomy and Physiology, Cellular and Field Biology. High quality optical lenses allow for fine details in high contrast can be studied in appropriate detail for starter to experienced microscope users. Perfect for establishing labs with sets of durable equipment classes can use for years. Compatible with student or professionally prepared slide set like the Microscope Slide Kingdom survey (SE-6214) gives students a solid start to explore cellular features and concepts across all living kingdoms.



Features:

- Observe small specimens like plant, animal, and bacterial cells, translucent objects such as insect larvae, or fine particles like powder
- 10 x eye piece
- 10x eyepiece and 4x, 10x, and 40x (oil) objective lenses provide magnification options of 40x, 100x, and 400x
- Adjustable focus between coarse and fine settings
- Dual light source (upper and lower LED) provides adjustable brightness
- Cord or cordless power options (External AC/DC Adaptor or 3xAA Batteries)
- Equipped with a plain stage with clip and single lens condenser with disc diaphragm

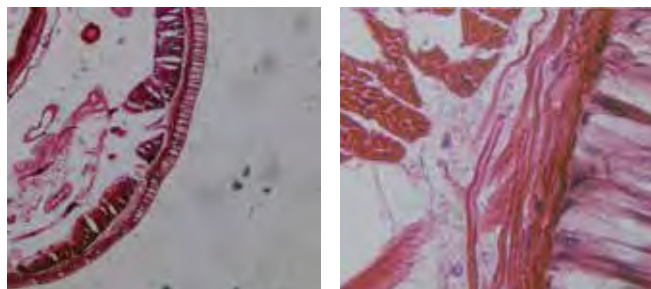

Sample imagery above captured with standard eyepiece USB camera. Slides from the Kingdoms Survey, Prepared Slide Set (sold separately)

Order Information

Standard Compound Optical Microscope.....SE-6213
 Prepared Slide Set, Kingdoms SurveySE-6214

Monocular Digital Microscope (40-1000x)

SE-6201

This compound microscope and digital camera combination includes a 100x oil immersion lens, 1.25 N.A. Abbe condenser, and a rechargeable LED illumination system. Motic Images software included. Use with Windows 7 and above. Mac OSX Compatible.



Note: See online for other microscope options including a Tri-Power Stereo Microscope (10X/20X/40X) and a monocular Microscope (40-1000x) with a detachable 8" LCD tablet that can transmit live images to devices.

Order Information

Monocular Digital Microscope (40-1000x).....SE-6201

USB 3.0 Microscope Camera

SE-6204

This high-resolution camera permits you to use your own microscope to create still or moving microscope images on your PC. With the included Motic Images Plus software, you can view, enhance, label, measure, print, and store the images all with one program. This lightweight digital camera mounts over almost any microscope eyepiece (stereo or compound) with the supplied C-ring adapter and microscope eyepiece adapters. Provides 3.0 megapixels at 2048x1536 framed resolution, everything included for easy plug-and-play, for use with Windows 7 and above and OSX.



Moticam X3 (SE-6205) streaming high resolution WiFi camera also available. See the PASCO website for more details.

Order Information

USB 3.0 Microscope CameraSE-6204
 WiFi Microscope CameraSE-6205

USB Camera Microscope

PS-2343

The versatile USB Camera Microscope is ideal for a variety of applications in the science classroom. Its dual functionality means it can take pictures just like a digital camera, but it can also magnify like a microscope when it's up close to a specimen.

Features:

- Built-in LED lights
- Optical zoom from 1x to 60x
- Can be used as a webcam



Order Information

USB Camera MicroscopePS-2343



Chemistry Educational solutions for General, AP®, IB®, and Honors Chemistry courses

Award-Winning Solutions for Your Chemistry Lab

PASCO provides chemistry educators with the most complete and innovative classroom solutions on the market. Our goal is to provide teachers with affordable, turnkey STEM solutions that combine versatile sensor technology with interactive, NGSS-based curriculum. Using SPARKvue® software and our wireless sensors, students can see data collection in real time and perform analyses on their own devices. Plus, our *Essential Chemistry* textbook and interactive e-book make it easy to reinforce student engagement at home and in the classroom.

Chemistry Index

Chemistry Lab Stations	53, 57
Essential Chemistry Curriculum	54-55
Advanced Chemistry Solutions.....	56-57
pH & Wireless Drop Counter	60-61
Temperature & Heat Stirrer	62
Ideal Gas Law & Absolute Zero Sphere	63
Pressure & Conductivity	64
Electrochemistry with Voltage & Current	65
Molecular Model and Geiger Counter	66
Polarimeter, Polarizer Demonstrator	67
Wireless Colorimeter & Turbidity	68
Wireless Spectrometer	69
UV-Vis Spectrometer & Comparison Guide	70-71
Melt Point Apparatus and Lab Supplies.....	72-73

World Class Support and Professional Development - Committed to Your Success!

Chemistry Starter Lab Station

EC-6362

The Chemistry Starter Lab Station makes it easy and affordable to begin using sensor-based technology in your chemistry lab or classroom. Inside the Starter Lab Station are the wireless sensors used to perform lab activities from the Essential Chemistry Student Lab Manual. Available separately is the Chemistry Extension Lab Station (EC-6363) which, when combined with the Starter Lab Station, comprises all the wireless sensors students need to perform most of the labs inside the Essential Chemistry Student Lab Manual, plus many of the lab activities found in our Advanced Chemistry Through Inquiry Teacher Guide.



Chemistry Station Lab Titles

The Chemistry Starter Lab Station supports 7 of the 10 included labs. Add the Extension Lab Station* to do all 10 lab titles + over 50 more investigations from the Essential Chemistry Lab Manual.

1. Physical or Chemical Change

2. Specific Heat

3. Chemical Reactions

4. Determining Limiting Reactions

5. Types of Bonding*

6. Evaporative Cooling

7. Solution Concentration*

8. What is pH

9. Investigation of Acid-Base Titration

10. Lemon Battery*

The Chemistry Starter & Extension Lab Stations include these wireless sensors and materials:

Starter

- Temperature
- Pressure
- pH
- Molecular Models
- Periodic Table
- Periodic Trend Cards
- Spectrum Cards
- Storage Case

Extension

- Drop Counter
- Colorimeter & Turbidity
- Conductivity
- Voltage
- Condenser
- Electrode Support



Chemistry Starter (left) & Extension Lab Stations (right)

Order Information

Chemistry Starter Lab StationEC-6362
 Essential Chemistry Extension Lab Kit.....EC-6363
 Essential Chemistry Teacher Lab ManualEC-6330



Essential Chemistry Teacher Lab Manual

EC-6330

The Essential Chemistry Teacher Lab Manual is a complete set of teacher answer keys for the 73 labs inside the Essential Chemistry Student Lab Manual (the printed student lab manual is sold separately). Each teacher key provides sample data, graphs, tables, and correct or sample responses to the analysis questions within each of the 73 student lab investigations. Below is a partial list of labs from the Essential Chemistry Lab Manual:

- Experimental Variables
- Density of a Liquid
- Physical or Chemical Change
- Specific Heat
- Naming Ionic Compounds
- Molar Mass
- Percent Composition of a Hydrate
- Empirical Formula of Magnesium Oxide
- Chemical Reactions
- Solubility Rules
- Determining Limiting Reactants
- Flame Tests
- Lewis Structures and VSEPR
- Evaporative Cooling
- Hess's Law
- Boyle's Law
- Charles' Law
- Solution Concentration
- Catalysts
- Le Châtelier's Principle
- Titration of an Unknown Acid
- Electrochemical Cells
- Electroplating
- Bonding and Organic Chemistry
- + 49 more labs available.

Your Complete Chemistry Solution

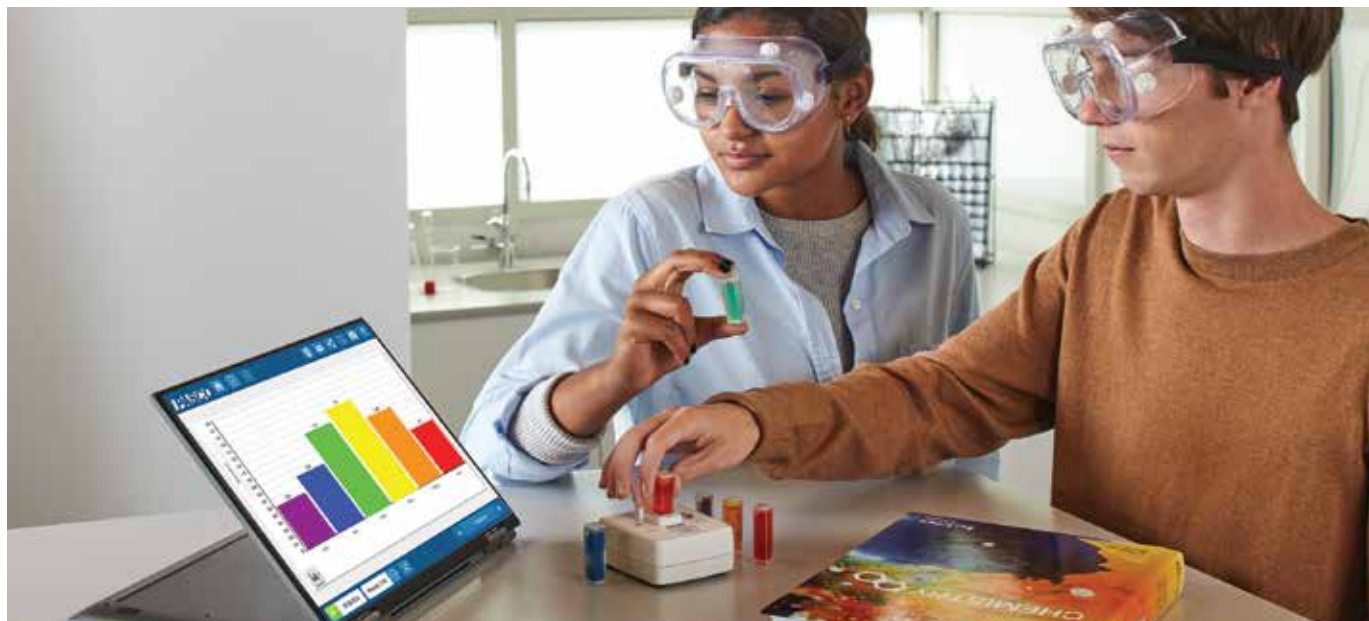

PASCO's Essential Chemistry curriculum is the only curriculum solution that includes a Student Textbook, Student e-Book, Teacher e-Resources, Student Lab Manual, Teacher Lab e-Resources, and Equipment Kits, all at a very affordable price. This 3-D STEM program includes a full year of instruction for both General and

Honors Chemistry classes. Use our complete solution or integrate Essential Chemistry into your existing curriculum. Essential Chemistry is multiplatform and works on iOS, Android™, Chrome™, Windows®, and Mac®. What's more, it includes 24/7 online access, as well as correlations to NGSS and your state standards.

Student Textbook & Lab Manual

- 24 chapters cover a full year of instruction for General and Honors Chemistry
- One main idea per page
- Quality illustrations
- Section and Chapter Reviews
- 73 complete investigations
- 4 Design Projects

Student e-Book

- Browser-based version of the textbook
- Same layout with convenient 24/7 online access
- Embedded videos and animations bring content to life
- Interactive equations and simulations enrich key concepts
- Formative and summative assessment questions

Teacher e-Resources for Lab Manual

- Editable documents
- SPARKvue Software
- PowerPoint presentations
- Answer keys
- Video lab assistance

Teacher e-Resources for Textbook

- Infinite Test Bank
- Teacher User Guide
- Teacher e-Book (1-year or multi-year license)
- Alignment details for NGSS and state standards

PASCO Academy Chemistry Resources

- Available through your PASCO Educator account
- 25 engaging video labs with detailed instruction and data collection
- 25 datasets for student analysis and discussion
- 25 editable lab handouts with teacher answer keys
- Digital access to more than 70 labs for General and Honors Chemistry

Equipment

- Standard Equipment Kit supports 47 labs
- Extend your investigations with additional sensors and apparatus

Essential Chemistry correlates with NGSS and is constructed around the three dimensions:

- Science and Engineering Practices
- Crosscutting Concepts
- Disciplinary Core Ideas



Textbook + e-Book + Equipment

Essential Chemistry Student Textbook

EC-6350

This rigorous yet accessible textbook includes core Chemistry topics that cover a complete year of instruction. The lessons follow the 5E model and include tools for ELL students, as well as tools for students with different learning styles. Fully aligned with both general and advanced coursework, this accessible textbook features one main idea per page, quality illustrations, 73 complete investigations, four Engineering Design Projects, and Section and Chapter Reviews. The 24 chapters cover these topics:

- The Science of Chemistry
- Measurement and Analysis
- Classifying Matter
- Temperature and Heat
- Chemical Compounds
- Moles
- Chemical Reactions
- Stoichiometry
- Atomic Structure
- Bonding and Valence
- Energy and Change
- Gases
- Solutions
- Reaction Rates
- Equilibrium
- Acids and Bases
- Oxidation and Reduction
- Electrochemistry
- Nuclear Chemistry
- Organic Chemistry
- Molecular Biology
- Biochemistry
- The Earth
- The Universe

Essential Chemistry Student e-Book

EC-6350-EB5 (5-yr lic) or EC-6350-EB1 (1-yr lic)

The e-Book is an electronic version of the full textbook plus interactive elements. Throughout the electronic text, content and theory are supported with optional audio reading, as well as interactive elements such as interactive equations, videos, animations, and simulations. Students may also expand content using the 'more' button to go deeper into concepts.

Essential Chemistry Student Lab Manual

EC-6352

The *Essential Chemistry* Student Lab Manual is a student-consumable print book. In the manual there are 73 labs that cover a full year of instruction. Best of all, the labs are completely integrated with PASCO equipment and software.

Essential Chemistry Lab Station Equipment Kits

EC-6362 & EC-6363

These equipment kits will outfit a single chemistry lab station of 2-5 students. When used in conjunction with the *Essential Chemistry* program, including the e-Book and lab manual, they create a complete solution for teaching high school chemistry. The equipment kits can also be used to supplement your existing textbook, serving as the lab components of your curriculum. This use is supported by the more than 70 standards-based *Essential Chemistry* labs that are available for free download in the PASCO Experiment Library.



Essential Chemistry Lab Station Equipment

42 labs are designed to use this equipment set.

- Includes 1 of each of the following:
- Wireless Temperature Sensor PS-3201
 - Wireless pH Sensor PS-3204
 - Wireless Conductivity Sensor PS-3210
 - Wireless Pressure Sensor PS-3203
 - Wireless Voltage Sensor PS-3211
 - Wireless Colorimeter and Turbidity PS-3215
 - Molecular Model Kit PS-3400
 - Electrode Support PS-3505
 - Periodic Trend Cards EC-3405
 - Periodic Table EC-3404
 - Spectrum Cards EC-3403
 - Condenser PS-3402
 - Wireless Drop Counter PS-3214
 - Gratnells® Storage Trays (2)

*The equipment list (above) includes everything in the *Chemistry Starter and Extension Lab Stations* (EC-6362 + EC-6363).

Order Information

Essential Chemistry 1st Edition: Student Textbook..... EC-6350A
Essential Chemistry 1st Edition: Student e-Book (1 yr license).. EC-6350-EB1
Essential Chemistry Student Lab Manual EC-6352
Essential Chemistry Teacher Lab Manual EC-6330

Essential Chemistry Lab Investigations - Teacher Res EC-6353-DIG
Essential Chemistry Starter Lab Station..... EC-6362
Essential Chemistry Extension Lab Kit EC-6363

Advanced Chemistry Through Inquiry Labs for AP[®] & IB[®]

PASCO's Advanced Chemistry through Inquiry Teacher Guide is newly revised and contains 16 labs that have been specifically designed to support student inquiry, as well as AP[®] and IB[®] curriculum*. This manual is available in both a print version and an all-digital version.

- Most labs can be completed in one lab session with readily available materials, including the sensor bundles on the opposite page.
- The flexible format provides guided inquiry opportunities and scaffolding, so students can create their own experiments.
- Easy and meaningful data collection leads to increased time for data analysis and open inquiry.
- Labs integrate high-order analysis and synthesis questions.
- Includes sample data for investigations and inquiry, answers to analysis and synthesis questions, an assessment rubric, teacher tips, lab preparation information, and more.

Initial Investigation includes step-by-step procedure, questions, and analysis.

Advanced Investigation presents a higher level experiment that expands on concepts from the Initial Investigation.

Extended Inquiry includes student inquiry and experimental design questions with sample answers.

Advanced Chemistry Lab Experiments	Starter Bundle (PS-3302)	Starter and Extension Bundles (PS-3302, PS-3303C)	IB [®] Standards*	Targeted AP [®] Learning Objectives*
1. Analysis of Food Dyes in Sports Drinks		●	1.5; A.8	SAP-8.A; SAP-8.C
2. Investigating the Copper Content of Brass		●	1.2; 1.5; A.8	SAP-8.C; SPQ-4.A
3. How Hard is Your Tap Water?	●	●	1.4	SPQ-1.A; SPQ-2.A; TRA-1.C; SPQ-3.C; SPQ-4.A
4. How Much Acid is in Your Fruit Juice?	●	●	18.1; 18.4	SPQ-4.B; SPQ-4.A
5. Separating Food Dyes Using Chromatography		●	4.3	SPQ-3.B; SPQ-3.C; SPQ-5.A
6. A Chemistry Mystery: Name That Unknown	●	●	4.3; 4.5	SAP-3.A; SAP-5.B; SAP-3.D
7. Stoichiometry in Solutions	●	●	1.5	SPQ-3.A; SPQ-4.A; SPQ-4.B; SPQ-2.A; SAP-5.B
8. Percentage of H ₂ O ₂ in Your Drugstore Hydrogen Peroxide		●	9.1; 9.2; 19.1	TRA-1.B; SPQ-4.A; SPQ-4.B
9. Investigating Physical and Chemical Changes of Matter	●	●	4.5	TRA-1.D; TRA-1.C; SAP-5.B
10. What Does Acid Rain Do To Coral Reefs?	●	●	6.1; A.8	TRA-3.A; TRA-3.C
11. Kinetics of Crystal Violet Fading		●	6.1; 16.1; 16.3	TRA-3.B; TRA-3.C; TRA-3.A
12. Building a Better Hand Warmer	●	●	5.1; 5.2; 5.3; 15.1	ENE-2.D; ENE-2.E; ENE-2.F
13. Applications of Le Châtelier's Principle	●	●	7.1; 7.2; 17.2; A.8	TRA-8.A; TRA-8.B
14. Investigation of Acid-Base Titrations	●	●	18.1; 18.4	SAP-9.E; TRA-1.B; SPQ-4.B; TRA-8.A
15. Introduction to Buffers	●	●**	18.2	SAP-10.B; TRA-1.C; SPQ-4.B; SAP-5.B
16. Evaluation of Lemonade as a Buffer	●	●**	18.2	SAP-10.D; SPQ-1.A

* AP is a registered trademark of the College Board, which was not involved in the production of, and does not endorse, this product. IB is a registered trademark of the International Baccalaureate Organization, which was not involved in the production of, and does not endorse, this product.

** The ORP Probe requires a pH sensor.

Order Information

Advanced Chemistry Through Inquiry.....PS-2828A

Includes lab prep instructions, expected answers/results, and editable student files. Manual is available in eco-friendly digital format or in print.

Lab Stations Support Advanced Chemistry

The Chemistry Starter Lab Station and Extension Station, together with PASCO's *Advanced Chemistry Through Inquiry Lab Manual*, offer a truly complete solution. With over 15 sensor-based labs covering a range of advanced chemistry topics, and all of the equipment and apparatus required to conduct the labs, hands-on inquiry with data collection and analysis has never been easier or more affordable. Add the Wireless Spectrometer and Oxidation Reduction Potential Probe to your Lab Stations to explore more IB® and AP® investigations.



The Chemistry Starter & Extension Lab Stations include these wireless sensors and materials:

Starter

- Temperature
- Pressure
- pH
- Molecular Model Kit
- Periodic Table
- Periodic Trend cards
- Spectrum Cards
- Storage Case

Extension

- Drop Counter
- Colorimeter & Turbidity
- Conductivity
- Voltage
- Condenser
- Electrode Support



PASPORT Ethanol Sensor

PS-2194

The PASPORT Ethanol Sensor measures the concentration of gaseous ethanol up to 3%. In biology and environmental science labs, students can learn about anaerobic respiration by measuring the production of ethanol by bacterial or yeast fermentation. Physics and chemistry students can begin to explore combustion and thermodynamics. Connect your students to the study of respiration and alternative energy sources with the PASPORT Ethanol Sensor.



Note: This sensor requires an interface for use. Compatible interfaces include the 550 Universal Interface, 850 Universal Interface, AirLink, and SPARKlink Air. See website for full details.

Oxidation Reduction Potential Probe

PS-3515

This probe connects to the Wireless pH Sensor and allows students to determine the capacity of a chemical species to act as an oxidizing or reducing agent during redox reactions.

Use this probe to monitor solutions during oxidation-reduction titrations, perform water quality studies, and study the effects of water chlorination. This probe is not a standalone sensor. It connects to and requires an amplifier.



Order Information

Essential Chemistry Starter Lab KitEC-6362
Essential Chemistry Extension Lab Kit.....EC-6363

PASPORT Ethanol SensorPS-2194
Oxidation Reduction Potential Probe.....PS-3515



Wireless pH Sensor

PS-3204

The Wireless pH Sensor is a must-have for any chemistry, biology, or environmental science course. Equally capable in the lab or field, the sensor eliminates the hassle of cables, reducing spills and improving safety. Plus, it rarely requires charging; the sensor's coin cell battery lasts for 2-3 years in most labs and costs about one dollar to replace. It can transmit data in real time, or store data for days when continuous monitoring is required. The Wireless pH Sensor enhances countless activities, including acid-base titrations, investigations into household chemicals, analyses of chemical reactions, water quality studies, and much more.

Features:

- Simply pair and go, no cables or interfaces to manage
- Compatible with ion-selective electrodes (ISE) and the oxidation reduction probe (ORP)
- Features Bluetooth® wireless connectivity and a long-lasting coin cell battery
- Logs pH data directly onto the sensor for long-term experiments
- Streams live data to SPARKvue and PASCO Capstone for instant visualization and analysis.



Collect measurements, compare pH levels of various solutions, and display data as a graph, digits display, table, and/or histogram.



Order Information

Wireless pH Sensor.....PS-3204

Wireless pH Sensor PackPS-3331

Note: Price for multi-sensor packs includes 8 sensors and custom storage case.



Wireless Drop Counter

PS-3214

The Wireless Drop Counter has a wide (18 x 13 mm) drop window for better drop detection and easier alignment with burettes. It works equally well with large or small, fast or slow drops.

Measures up to 40 drops per second with drops as small as 0.5 mm.

Teaching Advantage:

- IR filter assures accurate counts because room lighting cannot affect results
- Sensor unit can suspend two other probes in solution, simplifying many experiments
- Wide drop window (18x13 mm) means better drop detection and easier alignment with burettes



Includes: Wireless Drop Counter, Stopcock Valves (2), 60 cc Drop Dispenser Syringe with Tip, and Syringe Holder. Included but not shown: Micro Stir Bar and Micro USB Cable (1 m).

Order Information

Wireless Drop CounterPS-3214



Wireless Temperature Sensor

PS-3201

Welcome to the modern thermometer. The Wireless Temperature Sensor transmits live data and allows students to continuously monitor, log, and plot temperature measurements on nearly any device. When lab-time ends but the experiment continues, students can set the sensor to log data autonomously for days, weeks, or months, then download it for analysis later. This durable, wireless sensor features a stainless steel probe for the most demanding of applications, as well as a battery that lasts over a year*. It can be used in a wide array of experiments and activities because it measures small, but significant temperature changes produced by chemical reactions, convection currents, and even skin temperatures.

Features:

- Simply pair and go, no cables or adapters to manage
- Variable sampling rate for capturing small, fast changes or experiments that run for hours, days, or weeks
- Bluetooth® connectivity and long-lasting coin cell battery
- Logs temperature data directly onto the sensor for long-term experiments
- Dust, dirt, and sand-proof and water resistant (IP-X7 certified)

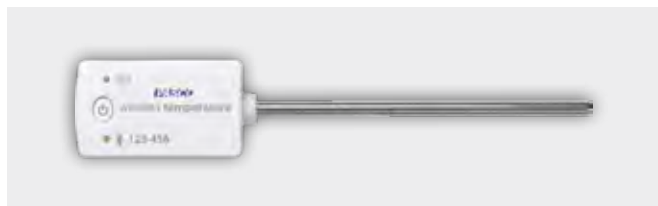

Order Information

Wireless Temperature Sensor.....PS-3201

Wireless Temperature Sensor Pack.....PS-3330

Note: Price for multi-sensor packs includes 8 sensors and custom storage case.

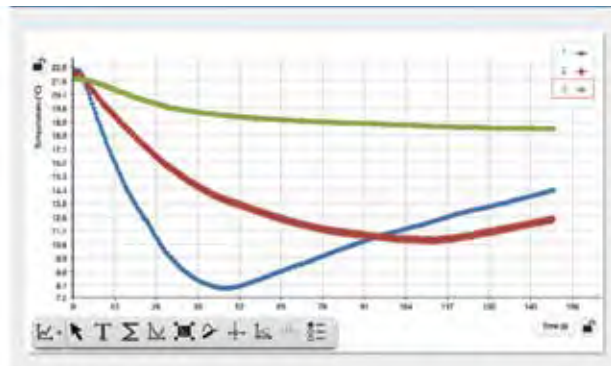

Heats of evaporation indicate strength of intermolecular motion.

Heater Stirrer

PS-3401

This compact hot plate and stirrer has a white ceramic top that is ideal for heating and for seeing color changes when mixing solutions. It has been designed to withstand spills. Its safety features include warning labels and indicator LEDs. And the included rod makes it easy to support sensors.



Order Information

Heater Stirrer.....PS-3401

OHAUS Scout SKX Balance 220g

SE-8823A

The Ohaus Scout SKX digital electronic balances combine range, resolution, and low cost, making them ideal for use in teaching labs.

Simple two-button operation and visual menu prompts allow students to begin weighing with minimal instruction. The large, crisp display is easily viewed from any angle, so teachers can quickly check student results. A sealed front panel, molded spill ring, and removable stainless steel platforms provide protection from spills and make these balances easy to keep clean.

Use Ohaus SKX series electronic balances in conjunction with SPARKvue or PASCO Capstone software. Connect any SKX balance to a computer via USB.



Order Information

OHAUS Scout SKX Balance 220g.....SE-8823A

Ohaus USB Adapter.....SE-8821

Wireless Temperature Sensor Link



PS-3222

The Wireless Temperature Sensor Link enables wireless connection for any PASCO temperature probe with a 3.5 mm connection. The link comes with a Fast Response Temperature Probe, but it can also connect to the Stainless Steel Temperature Probe, Skin/Surface Temperature Probe, the Absolute Zero Sphere, and the Ideal Gas Law Apparatus.



Order Information

Wireless Temperature Sensor Link.....PS-3222



Absolute Zero Sphere

TD-8595

The Absolute Zero Sphere is an effective tool for determining absolute zero temperature. Students connect Pressure and Temperature Sensors before immersing the sphere in water baths of varying temperatures. As the pressure and temperature change, a live graph is generated in PASCO Capstone™. Once the data is collected, students can use a linear fit to extrapolate the value of absolute zero.



Ideal Gas Law Apparatus

TD-8596A

Investigating the Ideal Gas Law is simple using PASCO's Ideal Gas Law Apparatus. By connecting a Pressure Sensor and a Temperature Sensor to the syringe, students can quantitatively look at the relationships between pressure, temperature, and volume.

Includes Ideal Gas Law Syringe, built-in fast response thermistor, with male leuc connector. A Wireless Pressure Sensor (PS-3203) and Wireless Temperature Link (PS-3222) are required for data collection.



Absolute Zero Sphere Connector

Includes built-in fast response thermistor, with male leuc connector. For data collection a Wireless Pressure Sensor (PS-3203) and Wireless Temperature Link (PS-3222) are required.

Order Information

Ideal Gas Law ApparatusTD-8596A

Order Information

Absolute Zero Sphere.....TD-8595



Wireless Pressure Sensor

PS-3203

The Wireless Pressure Sensor allows students to easily collect accurate gas pressure data for a wide range of applications. Included is a 60cc syringe, tubing, and connectors that facilitate experiments such as Boyle's Law and measuring pinch-grip strength. Within PASCO's software, students can easily select their desired units from a list containing kPa, mmHg, inHg, mbar, psi, atm, and torr.

Features:

- Measures pressure even when the pressure within the system drops below ambient pressure
- Supports common units (kPa, atm, psi, mmHg, or N/m²) for many applications
- Bluetooth® wireless connectivity and long-lasting rechargeable battery

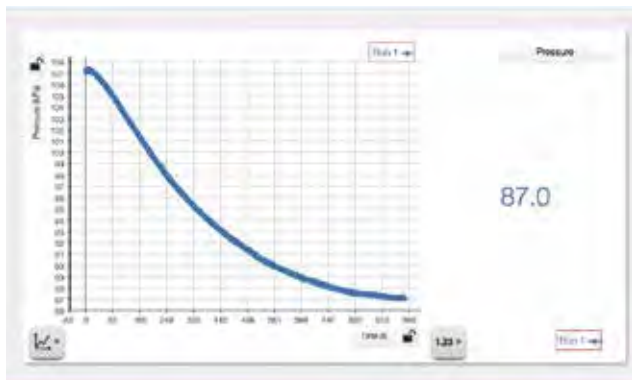

Order Information

Wireless Pressure SensorPS-3203
 Wireless Pressure Sensor Pack.....PS-3333

Note: Price for multi-sensor packs includes 8 sensors and custom storage case.



Wireless Conductivity Sensor

PS-3210A

The Wireless Conductivity Sensor measures the electrical conductivity of an aqueous solution. It is ideal for investigating the properties of solutions, including total dissolved solids (TDS) for water quality inquiry. Because it is temperature compensated, calibrations are less frequent and can be applied across a range of temperatures. With an improved range of 0 to 40,000 $\mu\text{S}/\text{cm}$, this sensor can be utilized for chemical, biological, and environmental studies.

Teacher tip: To measure brackish or marine samples, perform a dilution until the measurement falls within the range, then multiply to determine sample conductivity.

Features:

- Measure conductivity and total dissolved solids
- Automatic temperature compensation
- Battery life >1 year
- Remote logging with built-in memory
- Dust-proof, sand-proof, and water-resistant (1 meter for 30 minutes)

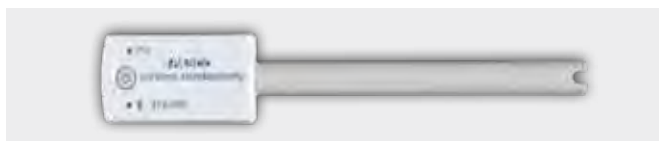

Order Information

Wireless Conductivity SensorPS-3210A
 Wireless Conductivity Sensor Pack.....PS-3332

Note: Price for multi-sensor packs includes 8 sensors and custom storage case.



Wireless Voltage Sensor

PS-3211

The Wireless Voltage Sensor helps chemistry students investigate redox reactions, electrolytic cell potentials, and the impact solution strength on these generated potentials. By testing potential differences between two half reactions, separated by a salt bridge, students can begin to understand the driving forces behind modern batteries.

Features:

- **Two Ranges:** ± 15 V, ± 5 V
- **Resolution:** 7 mV (± 15 V range); 2 mV (± 5 V range)
- Bluetooth® sampling rate of 1 kHz
- Higher speed sampling via USB
- Remote logging



Order Information

Wireless Voltage SensorPS-3211

Wireless Voltage Sensor PackPS-3335

Note: Price for multi-sensor packs includes 8 sensors and custom storage case.

Wireless Current Sensor

PS-3212

Current sensors enable chemistry students to count the electrons involved in driving reactions, much like how a scale accounts for mass in reactions. Amperage determines how many atoms are involved in a chemical reaction. Since the two are related, current can be used to find out how much reactant is available in a solution. Integrating currents keeps track of how much metal might electroplate onto an electrode.

Features:

- **Two Ranges:** ± 1.0 A and ± 0.1 A
- **Resolution:** 0.2 mA at ± 1 A range and 0.02 mA at ± 0.1 A range
- Bluetooth® sampling rate of 1.0 kHz
- Higher speed sampling via USB
- Remote logging
- Variable sampling rate for recording small, fast changes or experiments that run for hours, days, or weeks

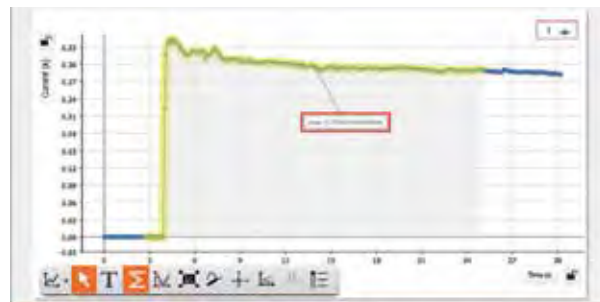

Order Information

Wireless Current SensorPS-3212

Wireless Current Sensor PackPS-3336

Note: Price for multi-sensor packs includes 8 sensors and custom storage case.



Molecular Model Set

PS-3400

The Molecular Model Set is the perfect tool to help students understand core science concepts such as chemical formulas, equation balancing and the conservation of mass. They are critical to making more advanced concepts easier to visualize and allow students to predict polarity and study reaction mechanisms. Students can explore intermolecular attractions, steric hindrances, nomenclature and complex structure. Anything is possible for students, from creating simple water or carbon dioxide molecules to complex biochemicals such as amino acids and lipids. The set is ideal for studying Chemistry and Biochemistry.



Order Information

Molecular Model Set.....PS-3400



Wireless Geiger Counter

PS-3238

The PASCO Wireless Geiger Counter counts beta, gamma and alpha radiation particles as they enter the Geiger-Müller detector tube inside the counter. Designed for easy mounting, the Geiger Counter provides superior position control in inverse square law labs, as well as an audible beep to indicate the detection of ionizing radiation. The front plastic snout fits conveniently inside the NU-3344 Sample Holder stand (available separately), which stabilizes the front of the counter's detector tube exactly 1 cm from the first slot in the holder.

With the Wireless Geiger Counter, students can wirelessly control the high voltage supplied to the Geiger-Müller tube inside the counter, enabling them to make measurements of counts/interval for different tube voltages. They can also plot counts/interval versus tube voltages to experimentally observe the Geiger plateau characteristics of the tube.

Features:

- Built-in metal mesh screen to protect the delicate mica window in the front of the Geiger-Müller detector tube
- Audible beep count indication that is easily switched on or off
- **Versatile positioning options:** either in the NU-3344 Sample Holder, hand-held, or mounted on a rod stand
- Convenient design to natively fit the PASCO NU-3344 Sample Holder
- Provides wireless control over the high voltage supplied to the Geiger-Müller tube inside the counter for Geiger plateau experiments

Includes:

- Wireless Geiger Counter
- Micro USB Cable: PS-3584
- Threaded handle for mounting the sensor to a ring stand



Order Information

Wireless Geiger Counter.....PS-3238

Geiger Counter Sample Holder.....NU-3344



Wireless Polarimeter

PS-3237

The Wireless Polarimeter has both Bluetooth® and USB connectivity, making it possible to analyze chiral compounds with your iPad®, Chromebook™, Android tablet, or computer. It is ideal for introductory experiments in organic chemistry and biochemistry, where chiral compounds are of special interest.

PASCO's Wireless Polarimeter passes plane polarized light through a vertical sample, which contains a chiral compound, followed by an analyzer and detector. The optical rotation is determined by finding the angle between the starting position and the location where the optimum light level transmits through the cross polarizer. Students can use the rotation data to calculate the concentration of a chiral sample, while the specific rotation (amount turned per g/ml dissolved) is an intrinsic property that can be used to differentiate molecules or determine racemic mixtures.

Specifications:

- **Connectivity:** Bluetooth and USB
- **LED light source:** 589 nm
- **Optical Rotation Accuracy:** $\pm 0.09^\circ$
- **Cell Length:** 101.3mm \pm 0.8mm

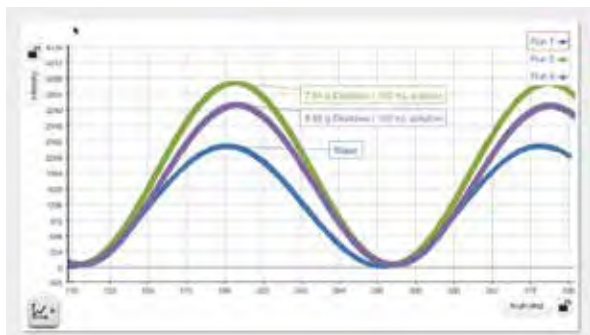

Order Information

Wireless PolarimeterPS-3237

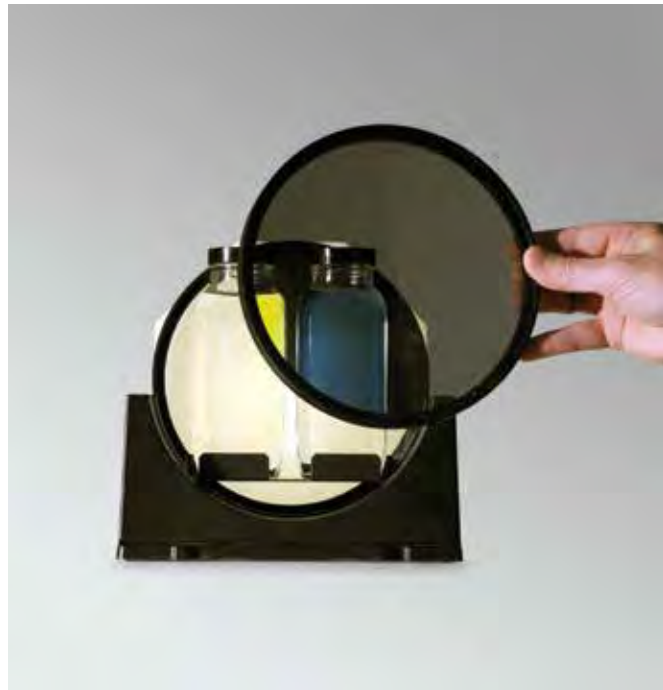

Polarizer Demonstrator

OS-9477A

Confirm Malus' Law using the Polarizer Demonstrator and a Light Sensor. The angle is read directly from the polarizer, which is marked in 5° increments. Any light source can be used, but the experiment works especially well with the PASCO Color Mixer (OS-8496). See pasco.com for more information.

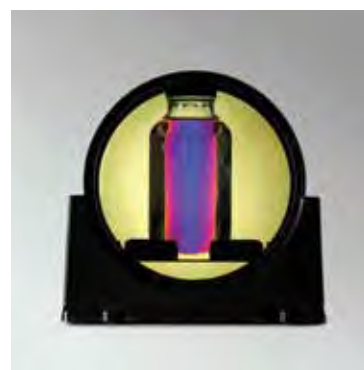

Introduce the concept of polarization with this colorful and meaningful demonstration.



Order Information

Polarizer DemonstratorOS-9477A



Wireless Colorimeter & Turbidity Sensor

PS-3215

The Wireless Colorimeter & Turbidity Sensor simultaneously measures the absorbance and transmittance of six different wavelengths. The sensor can be used to study Beer's Law (absorbance vs. concentration), enzyme activity, photosynthesis, and the rates of chemical reactions (absorbance vs. time). After a simple calibration, students can quickly begin viewing live measurements as they materialize across the visible spectrum at 650 nm (red), 600 nm (orange), 570 nm (yellow), 550 nm (green), 500 nm (blue), and 450 nm (violet).

This sensor also functions as a high-quality turbidimeter for water quality analysis. Rather than simply measuring transmitted light, the Wireless Colorimeter and Turbidity Sensor measures light scattered at a 90 degree angle from the sample, resulting in accurate and repeatable measurements. Additionally, the internal housing for the cuvette is opaque, which limits ambient light interference to preserve accuracy.

Features:

- Stabilized light source for consistent readings
- Measures six different wavelengths simultaneously
- PASCO software displays the absorbance & transmittance at each wavelength in the appropriate color
- Directly calibrated to read ezSample concentrations of Ammonia, Nitrate, Phosphate, Iron and Chlorine in ppm.
- Functions as both a colorimeter and turbidimeter



Includes: USB charging cable, 9 cuvettes, 2 cuvette racks, and one 100 NTU calibration cuvette.

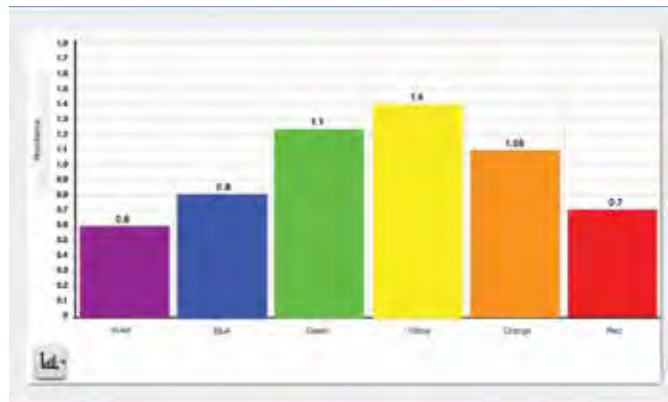
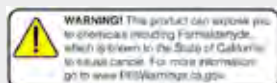

Measure the absorbance and transmittance of a solution at six different wavelengths simultaneously!

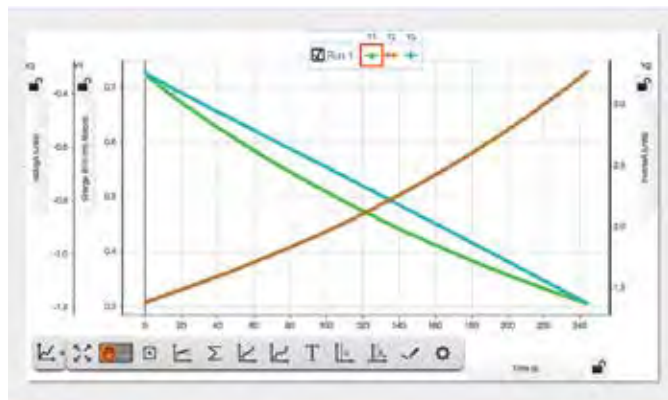

Graphically visualize how a reaction changes over time. Use SPARKvue to visualize multiple measurements on the same graph.

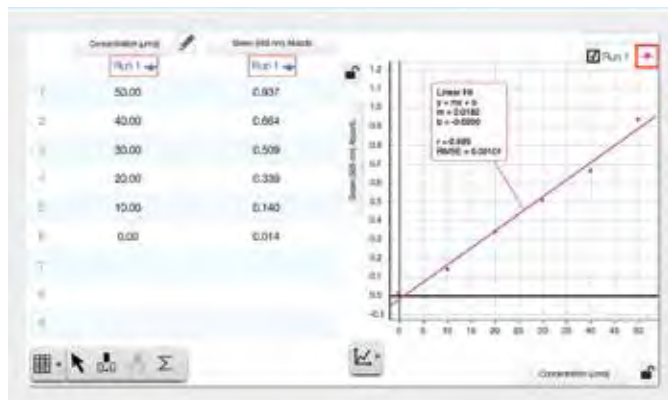

Cuvettes and Caps

SE-8739

Set of 100 identical 3.5-mL polystyrene cuvettes and caps. Transparent to visible light.



Order Information

Cuvettes and Caps.....SE-8739

Order Information

Wireless Colorimeter & Turbidity Sensor.....PS-3215

Wireless Colorimeter & Turbidity Sensor PackPS-3334

Note: Price for multi-sensor packs includes 8 sensors and custom storage case.



Wireless Spectrometer (VIS)

PS-2600A

The award-winning PASCO Wireless Spectrometer is specifically designed for modern chemistry, biology, and physics labs. It connects to student devices via USB or Bluetooth Low Energy and includes free Spectrometry software with built-in tools for spectral analysis. Scan times are fast, enabling students to collect a full spectrum of data in less than a second. Plots are provided for common applications, including Absorbance vs. Wavelength (or Intensity vs. Wavelength), Absorbance vs. Concentration (Beer's law), and Absorbance vs. Time.

Perform these labs with the PASCO Wireless Spectrometer:

- Emission Spectra of Light
- Absorbance Spectra
- Beer's Law
- Kinetics
- Fluorescence

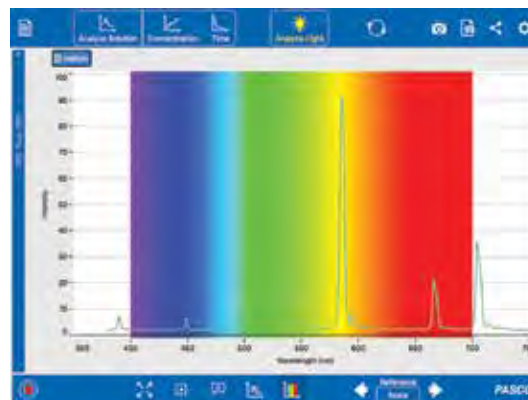

Analyze light sources with the optional Fiber Optic Cable. Easily compare the spectrum to known reference lines in the software.

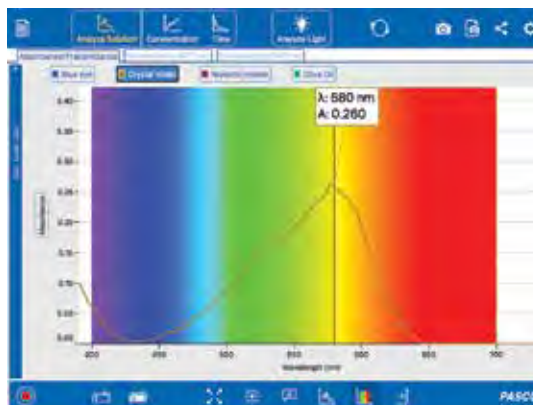

Full visible spectrum includes a large digits display that helps students select wavelengths and determine absorbance values.



Order Information

Wireless Spectrometer (Vis)PS-2600A
Includes USB charging cable, 10 cuvettes, and Spectrometry Software.

Instrument Comparison Guide

Compare features and capabilities to find the right instrument for your lab.



Colorimeter & Turbidity
PS-3215



Wireless Spectrometer
PS-2600A



PASCO UV-Vis Spectrometer
SE-3607

Feature	Colorimeter & Turbidity	Wireless Spectrometer	UV-Vis Spectrometer
Light Source	White LED	RGB LED-Boosted Tungsten	Deuterium (UV) Tungsten (Vis)
Optical Resolution	±25 nm	2 nm	1 nm
Wavelength Range	450, 500, 550, 570, 600, 650 nm	390 – 950 nm	180 – 1050 nm
Wavelength Accuracy	NA	≤6 nm	1 nm
Photometric Range (for best accuracy)	0.05 to 1.5	0.1 to 1.4	0.1 to 1.0
Photometric Accuracy	±5%	±10%	±5%
Full Spectrum Scans	No	Yes	Yes
Scan Time	N/A	1 ms – 25 s	4 ms – 10 s
Connects via USB	Yes	Yes	Yes
Connects via Bluetooth	Yes	Yes	No
Rechargeable battery (for cordless operation only)	Yes	Yes	No
Fluorescent Excitation	No	405, 500 nm	No
Works with SPARKvue & Capstone Software	Yes	No	No
Works with PASCO Spectrometry Software	No	Yes	Yes
Data Storage/Onboard Memory	Yes	No	No
Good for Field Use	Yes	Yes	N/A
Turbidimeter	Yes	No	No



UV-Vis Spectrometer

SE-3607

The SE-3607 is an easy-to-use, wide range UV-Vis spectrometer that delivers fast, accurate and reliable performance for routine analyses in chemistry and biochemistry teaching labs. With USB connectivity and cross-platform Spectrometry Software, the PASCO UV-Vis Spectrometer improves collaboration between lab members, enabling data collected on a computer or laptop to be analyzed on tablets, iPads, and Chromebooks. Additional accessories, such as the UV-Vis Fiber Optic Kit, can be used to extend the spectrometer's capabilities for the analysis of emission spectra, light sources, and the classification of lasers.

Highlights:

- Spectral scans from 180 to 1050 nm
- Award-winning Spectrometry software
- One-click light and dark calibrations
- Fast warm-up time (<10 minutes)
- Adjustable scan averaging, signal integration time and smoothing
- Graphs Absorbance vs. Wavelength
- Graphs Intensity vs. Wavelength (emission spectra)
- Graphs Absorbance vs. Concentration (Beer's Law)
- Graphs Absorption vs. Time (kinetics)

Applications:

- Determination of solution concentrations
- Identification of unknown substances
- Measurement of reaction rates or rate of decay
- Colorimetric assays (e.g., BCA, Bradford, Lowry)
- Purity testing of synthesized compounds
- Determination of the equilibrium constant
- Determination of molar absorption coefficients
- Quality testing (e.g., fermentation mediums, food adulteration, QA levels)

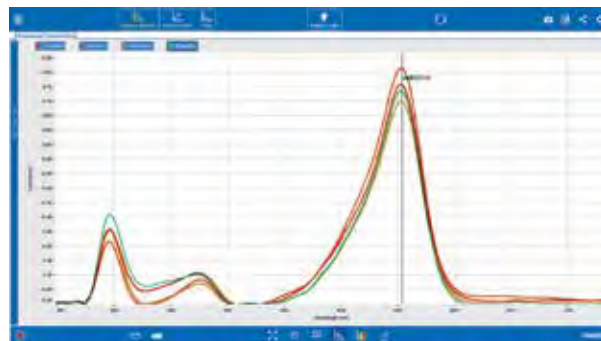

Absorbance of solutions containing various amounts of NaOH.

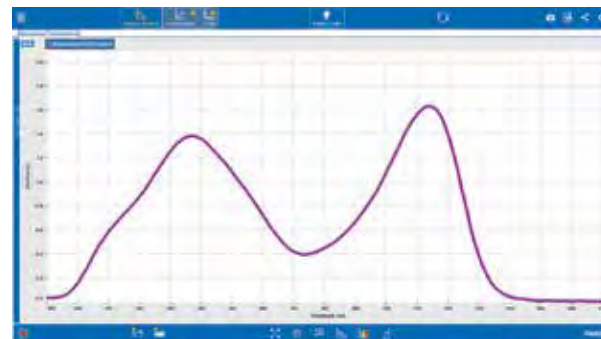

Absorbance of Aspirin.

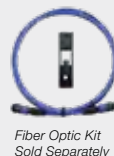

For Mac® and Windows® Computers go to pasco.com/downloads

Order Information

UV-Vis Spectrometer.....SE-3607
 UV-Vis Fiber Optic Kit.....SE-7182

UV Quartz Cuvettes (Qty. 2) SE-3611
 Disposable UV Semi-Micro Volume Cuvettes (Qty. 10)SE-3610



Melting Point Apparatus

NEW

PS-3239

Melt point range is an important factor for determining the identity and purity of compounds, which is primary focus of many college chemistry labs. The built-in magnifying eyepiece allows students to observe the melting process individually, or a USB camera can be mounted to record the process to view in real time on a screen for larger groups.

The variable ramp rates allow you to quickly raise the sample temperature near melting (to preserve lab time) before slowing the rate down again, and the hold temp command ensures all substances reach a uniform temperature. Check the current temperature easily with the built-in temperature sensor, and use the cooling fan between measurements to restore the heating block to room temperature fast.

Melting Point Apparatus Eyepiece Camera

SE-6215

Short focal length digital eyepiece camera to capture the melting process. Image stacks will be time coded to compare to temperature data from the Melting Point Apparatus. Images can be scheduled to be captured every 5 seconds during the heating curve for more accurate determination of substances melting points.

Order Information

Melting Point Apparatus	PS-3239
Melting Point Apparatus Eyepiece Camera	SE-6215



pH Buffer Capsule Kit

SC-2321

This set of capsules can be used to create a quick and reliable preparation of fresh solutions of known pH values for calibrating the PASPORT pH Sensor (such as PS-2102 and other pH sensors)

Contains one vial each, with 10 capsules per vial of pH 4.0, pH 7.0, and pH 10.0. Each capsule is sufficient to make 100 mL buffer solution. Includes preservative solution which contains a pH indicator and colors each buffer solution for easy identification.

Using distilled water, the user can formulate clear solutions accurate to ± 0.02 pH unit. The dry powder remains stable.



Standard buffer capsule kit. pH of 4, 7 and 10.

Order Information

pH Buffer Capsule Kit.....SC-2321

Round Base with Rod and Clamps



Round Base with Rod



Right Angle Clamp

Test Tube Clamp

Three-Finger Clamp

Order Information

Round Base with Rod.....ME-8270
 Three-Finger Clamp.....SE-9445
 Right Angle Clamp.....SE-9444
 Test Tube-Utility Clamp.....SE-9446

Flat pH Probe

PS-3514

The Flat pH Probe gives you the freedom to measure what you want, where you want. Study pH levels in different kinds of foods, investigate the pH of common skin and hair care products, and easily collect pH data when doing soil analysis. Can be used on semi-solids by pressing the probe against a moist surface. This product is intended for use with the Wireless pH Sensor.



Oxidation Reduction Potential Probe

PS-3515

This probe connects to the Wireless pH Sensor and measures the potential of a solution to be oxidized or reduced in comparison to a silver/silver chloride reference cell. This allows students to determine the ability of a species in a solution to act as an oxidizing agent or reducing agent during redox reactions.

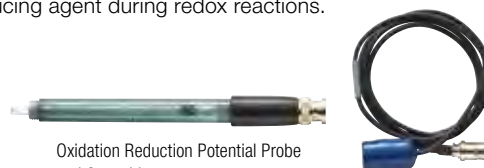

Oxidation Reduction Potential Probe and 2m cable

Ion Selective Electrodes

PASCO's collection of ISEs all connect to the Wireless pH Sensor and allows students to measure the concentration of various ions in an aqueous solutions. All of the electrodes include a (BNC) extension cable.



Ammonium Ion

Carbon Dioxide Ion

Calcium Ion

Chloride Ion

Potassium Ion

Nitrate Ion

Order Information

Flat pH Probe.....PS-3514
 Oxidation Reduction Potential Probe.....PS-3515
Ion Selective Electrodes
 Ammonium Ion Selective Electrode.....PS-3516
 Carbon Dioxide Ion Selective Electrode.....PS-3517
 Calcium Ion Selective Electrode.....PS-3518
 Chloride Ion Selective Electrode.....PS-3519
 Potassium Ion Selective Electrode.....PS-3520
 Nitrate Ion Selective Electrode.....PS-3521

NOTE: All probes and electrodes (listed above) are designed for use with the Wireless pH Sensor (PS-3204)



Environmental Science Solutions for General, Advanced, and AG courses

Integrated Solutions for Environmental Science

Facilitate student investigations of environmental topics anytime, anywhere with PASCO. We offer cutting-edge solutions for both general and advanced environmental science courses, as well as agricultural science courses. Using our award-winning Wireless Sensors and cross-platform software, students can collect and visualize live data, analyze lab results, and log measurements for long-term studies. Pair them with our standards-aligned labs to investigate countless environmental concepts, both inside and outside the classroom.

Environmental Science Index

AG Science Starter Lab Station.....73
 Advanced Environmental Science.....74
 Lab Stations75
 CO₂, Soil Moisture.....76
 Weather with GPS, Weather Vane Accessory77
 Temperature, pH.....78
 Conductivity, Light79
 Density Model and Dissolved Oxygen Sensor.....80
 EcoZone System, Greenhouse Kit.....81
 Water Quality Testing, ezSample Kits..... 82
 Water Quality and Flow Rate Sensors83

World Class Support and Professional Development - Committed to Your Success!

We want you to have all the support, guidance, and training you need. Just let us know how we can help.

AG Science Starter Lab Station

EB-6336

The Agricultural Science Starter Lab Station makes it both easy and affordable to begin using sensor-based technology with your environmental or agricultural science students. Complete with wireless sensors, ten student labs, and a storage case, the Starter Lab Station lets students investigate environmental concepts such as soil quality, water treatment, and the energy content of food. Add the Agricultural Science Extension Lab Station to perform all ten of the included student labs, plus dozens of hands-on activities from the PASCO Experiment Library.



AG Science Lab Manual

Available online, PASCO's Agricultural Science Lab Manual includes twelve student investigations that cover a variety of environmental topics. Each investigation comes classroom-ready with an editable student lab handout, sample data, and teacher answer key. To download labs and view standards-alignment details, visit the PASCO Experiment Library online.

- Determining Soil Quality
- Water Treatment
- Freshwater Quality Monitoring
- Water and pH
- Respiration of Germinating Seeds
- Plant Pigments and Photosynthesis
- Plant Respiration and Photosynthesis
- Modeling an Ecosystem
- Greenhouse Gases
- Energy Content of Food
- Diffusion
- Soil and pH

AG Science Station Lab Titles

The AG Science Starter Lab Station supports 7 of the 10 labs. Add the Extension Lab Station* to do all 10 lab titles.

- Determining Soil Quality**
- Water Treatment**
- Freshwater Quality Monitoring***
- Respiration of Germinating Seeds**

- Plant Pigments & Photosynthesis**
- Plant Respiration & Photosynthesis**
- Modeling an Ecosystem***
- Greenhouse Gases***
- Energy Content of Food**
- Diffusion**



Shown here: AG Science Starter Lab Station

The AG Science Starter Lab Station includes a lab manual and these wireless sensors and apparatus:

- Temperature
- pH
- CO₂
- Conductivity
- Colorimeter & Turbidity
- Storage Case

**To do the remaining 3 labs from the AG Science Lab Manual (listed above), add the Extension Lab Station (see page 73). Add the AG Science Teacher Lab Manual to perform an additional 4 AG science labs.*

Order Information

Agricultural Science Starter Lab StationEB-6336



Advanced Environmental Science Through Inquiry Labs for AP[®] & IB[®]

PASCO's Advanced Environmental Science Through Inquiry Teacher Lab Manual contains 22 labs that have been specifically designed to support student inquiry, as well as AP[®] and IB[®] curriculum*. This manual is available in both a print version and an all-digital version.

- Most labs can be completed in one lab session with readily available materials, including the sensor bundles on the opposite page.
- Easy and meaningful data collection leads to increased time for data analysis and open inquiry.
- Includes sample data for investigations and inquiry, answers to analysis and synthesis questions, an assessment rubric, teacher tips, lab preparation information, and more.
- Labs integrate high-order analysis and synthesis questions.
- The flexible format provides guided inquiry opportunities and scaffolding, so students can create their own experiments.

Note: The included labs offer a variety of structured, guided and open inquiry approaches, allowing students to explore both traditional and self-selected environmental concepts.

Advanced Environmental Science Lab Experiments	Starter Bundle (PS-7616B)	Starter and Extension Bundles (PS-7616B, PS-7617C)	IB [®] Standards*	Targeted AP [®] Learning Objectives*
1. Determining Soil Quality		●	5.1; 5.2; 5.3	ERT-4.B; 4.C
2. Insolation and the Seasons	●	●	1.2	ENG-2.A
3. Investigating Specific Heat	●	●	1.2; 2.3	ENG-2.A
4. Monitoring Microclimates	●	●	7.1; 7.2; 7.3	ENG-2.B; ERT-4.E
5. Sunlight Intensity and Reflectivity	●	●	2.3; 7.1-7.3	ENG-2.A
6. Tracking Weather	●	●	7.2; 7.3	ERT-4.E; ENG-2.B
7. Earth's Magnetic Field	●	●	1.2	ERT-4.A
8. Radiation Energy Transfer	●	●	1.2; 2.3	ENG-3.J
9. Seafloor Spreading & Plate Tectonics**	●	●	1.2	ERT-4.A
10. Modeling an Ecosystem		●	1.2; 2.4; 2.5; 3.1	ENT-1.B-1.G; ENG-1.C
11. Photosynthesis and Primary Productivity		●	1.1; 1.2; 2.3; 5.2	ENG-1.A; ERT-1.C; 1.D
12. Photosynthesis and Cell Respiration		●	1.1; 1.2; 2.3; 5.2	ENG-1.B
13. Cellular Respiration and Carbon Cycle		●	1.1; 1.2; 6.1; 6.2	ENG-1.B
14. Energy Content of Food	●	●	1.3; 2.3	ENG-1.B
15. Weather in a Terrarium	●	●	1.1; 1.2; 7.2; 7.3	ERT-4.E
16. Yeast Respiration		●	1.1; 1.2	ENG-3.I
17. Properties of Water	●	●	4.1; 4.2	STB-3.N
18. Air Pollution and Acid Rain	●	●	6.1; 6.2; 6.3; 6.4	STB-2.H
19. Monitoring Water Quality		●	4.1; 4.2; 4.4	STB-3.E
20. Toxicology Using Yeast	●	●	1.1; 1.2	EIN-3.A
21. Water Treatment		●	4.1; 4.2; 4.4	STB-3.N
22. Greenhouse Gases	●	●	6.1; 6.2; 6.3; 6.4	STB-4.E

* IB is a registered trademark of the International Baccalaureate Organization, which was not involved in the production of, and does not endorse, this product. AP is a trademark registered and/or owned by the College Board, which was not involved in the production of, and does not endorse, this product.

**Requires Wireless 3-Axis Magnetic Field Sensor; see opposite page.

AG Science Lab Stations Support Advanced Environmental Science Investigations

Together, the Agricultural Starter and Extension Lab Stations offer a lab-ready solution for exploring essential topics in agricultural and environmental science. When paired with PASCO's Advanced Environmental Science Through Inquiry Lab Manual, students can perform more than 20 sensor-based experiments, complete with hands-on data collection, visualization, and analysis. Add the Water Quality Field Guide to extend your investigations even further.



Water Quality Field Guide

PS-2829A

The Water Quality Field Guide is a combination 'how-to' and 'why?' reference. It covers how to successfully measure water quality in the field, why these measurements are important, and what they mean.

AG Science Station Lab Titles

Together, the AG Science Starter and Extension Lab Stations support over 20 Advanced Environmental labs. Conduct the 10 labs below right out of the box.

1. Determining Soil Quality

2. Water Treatment

3. Freshwater Quality Monitoring

4. Respiration of Germinating Seeds

5. Plant Pigments & Photosynthesis

6. Plant Respiration & Photosynthesis

7. Modeling an Ecosystem

8. Greenhouse Gases

9. Energy Content of Food

10. Diffusion



Wireless Magnetic Field Sensor

PS-3221

This 3-Axis Magnetic Field Sensor can sense the Earth's magnetic field, as well as fields from coils and bar magnets. There are two ranges: ± 50 gauss and ± 1300 gauss. This sensor is primarily for static fields.



Shown here: AG Science Starter and Extension Lab Stations

The AG Science Starter & Extension Lab Stations include these wireless sensors and materials:

- Temperature
- Conductivity
- pH
- CO₂
- Colorimeter
- Turbidity
- Optical Dissolved Oxygen
- Weather with GPS
- EcoZone System
- Lab Manual
- Storage Case

Order Information

Advanced Environmental and Earth Sciences Teacher GuidePS-2979
 Agricultural Science Starter Lab StationEB-6336
 Agricultural Science Extension Lab Station.....EB-6337

Water Quality Field Guide.....PS-2829A
 Wireless Magnetic Field SensorPS-3221



CO₂ Sensor shown in use with Dissolved CO₂ Waterproof Sleeve.

Wireless CO₂ Sensor

PS-3208

Measure changes in carbon dioxide (CO₂) gas levels quickly and easily with the Wireless CO₂ Sensor. This temperature-compensated sensor can operate in high humidity environments, such as the included 250-mL sample bottle, and employs live data to make core labs such as photosynthesis, cellular respiration, and metabolism experiments engaging and impactful. With the ability to store more than 55,000 data points, the sensor also supports long-term studies of carbon cycling that span the course of a single night or an entire weekend.

Features:

- Logging ability for long-term experiments, store up to 55,000 data points
- Integrated stopper for use with sample bottle and common glassware
- Temperature compensated for accurate results



The sleeves are waterproof but allow CO₂ gas to pass through the membrane, creating a headspace around the sensor.

Order Information

Wireless CO ₂ Sensor (Carbon Dioxide)	PS-3208
Wireless CO ₂ Sensor Pack	PS-3341
Note: Price for multi-sensor packs includes 8 sensors and custom storage case.	
Dissolved CO ₂ Waterproof Sleeve.....	PS-3545

Wireless Soil Moisture Sensor

PS-3228

The Wireless Soil Moisture Sensor measures the volumetric water content (%VWC) of soil, reporting data in real time or storing it onboard the sensor's memory for long-term experiments. Durable and easy to use, the Wireless Soil Moisture Sensor is the perfect tool for monitoring controlled experiments in the classroom and long-term experiments outdoors. From experiments in evaporation and soil composition to water consumption and plant competition, the Wireless Soil Moisture Sensor makes it easy for students to investigate a wide array of topics through real-time or long-term data collection.

Features:

- Collect and display data in real time within PASCO Capstone or SPARKvue software
- Automate data collection for hours, days, or weeks with Logging Mode
- Bluetooth connectivity enables use in the classroom, lab, or field
- Supports use of GPS data from a mobile device for GIS mapping activities
- Selectable calibrations for predominantly sandy soils, clay soils, and loamy soils



Order Information

Wireless Soil Moisture Sensor.....	PS-3228
------------------------------------	---------



Wireless Weather Sensor with GPS

PS-3209

The Wireless Weather Sensor is an all-in-one instrument for monitoring complex environmental conditions. It houses several sensing elements within a single unit to provide 19 different measurements. Use the sensor in logging mode with the Weather Vane Accessory for long-term monitoring, or use it as a handheld instrument to study microclimates and local weather patterns. The collected data can be wirelessly exported to most devices, including classroom device dashboards, making it easier to support group activities that are constrained by time. Plus, with the built-in GPS, students can collect and analyze location data using the SPARKvue map display, powered by ESRI ArcGIS.

Features:

- Logging mode for long-term experiments
- Water resistant for extended environmental monitoring
- Built-in light sensor measures light level and UV index
- SPARKvue map display supports spatial analysis (GIS)
- 19 different measurements can be collected and analyzed individually or simultaneously
- GPS enables data from any PASCO probe to be viewed on a map, when connected



Visualize your data in seconds with a FREE ESRI's ArcGIS account!

Measurements

Weather

1. Ambient Temperature
2. Barometric Pressure
3. Wind Speed
4. Wind Direction (true)
5. Relative Humidity
6. Absolute Humidity
7. Dew Point
8. Wind Chill
9. Heat Stress Index

Light

10. Ambient Light (lux)
11. UV Index
12. PAR
13. Irradiance

GPS

14. Latitude
15. Longitude
16. Altitude
17. Speed
18. Magnetic Direction
19. True Direction



The weather dashboard displays data from the multiple sensors.



Weather Vane Accessory sold separately.



Order Information

Wireless Weather Sensor with GPSPS-3209

Wireless Weather Sensor with GPS Pack.....PS-3340

Note: Price for multi-sensor packs includes 8 sensors and custom storage case.

Weather Vane AccessoryPS-3553



Wireless Temperature Sensor



PS-3201

Welcome to the modern thermometer. The Wireless Temperature Sensor transmits live data and allows students to continuously monitor, log, and plot temperature measurements on nearly any device. When lab-time ends but the experiment continues, students can set the sensor to log data autonomously for days, weeks, or months, then download it for analysis later. This durable, wireless sensor features a stainless steel probe for the most demanding of applications, as well as a battery that lasts over a year*. It can be used in a wide array of experiments and activities because it measures small, but significant temperature changes produced by chemical reactions, convection currents, and even skin temperatures.

Features:

- Simply pair and go, no cables or adapters to manage
- Variable sampling rate for capturing small, fast changes or experiments that run for hours, days, or weeks
- Bluetooth® connectivity and long-lasting coin cell battery
- Logs temperature data directly onto the sensor for long-term experiments
- Dust, dirt, and sand-proof and water resistant (IP-X7 certified)

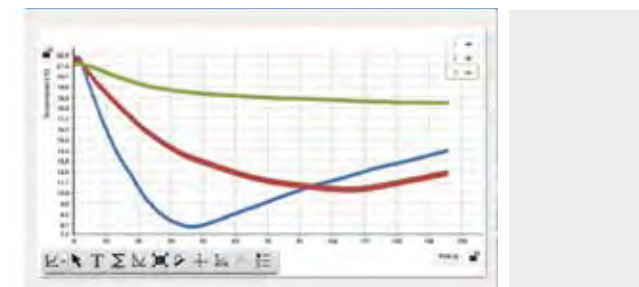

Order Information

Wireless Temperature Sensor.....PS-3201

Wireless Temperature Sensor PackPS-3330

Note: Price for multi-sensor packs includes 8 sensors and custom storage case.



Wireless pH Sensor



PS-3204

The Wireless pH Sensor is a must-have for any chemistry, biology, or environmental science course. Equally capable in the lab or field, the sensor eliminates the hassle of cables, reducing spills and improving safety. Plus, it rarely requires charging; the sensor's coin cell battery lasts for 2-3 years in most labs and costs about one dollar to replace. It can transmit data in real time, or store data for days when continuous monitoring is required. The Wireless pH Sensor enhances countless activities, including acid-base titrations, investigations into household chemicals, analyses of chemical reactions, water quality studies, and much more.

Features:

- Simply pair and go, no cables or interfaces to manage
- Compatible with ion-selective electrodes (ISE) and the oxidation reduction probe (ORP)
- Bluetooth® connectivity and a long-lasting coin cell battery
- Logs pH data directly onto the sensor for long-term experiments
- Wirelessly connects to SPARKvue and Capstone for intuitive analysis and lab reports



Measure the pH of water in different locations and annotate with text and pictures.



Order Information

Wireless pH Sensor.....PS-3204

Wireless pH Sensor PackPS-3331

Note: Price for multi-sensor packs includes 8 sensors and custom storage case.



Wireless Conductivity Sensor

PS-3210A

The Wireless Conductivity Sensor measures the electrical conductivity of an aqueous solution. It is ideal for investigating the properties of solutions, including total dissolved solids (TDS) for water quality inquiry. Because it is temperature compensated, calibrations are less frequent and can be applied across a range of temperatures. With an improved range of 0 to 40,000 $\mu\text{S}/\text{cm}$, this sensor can be utilized for chemical, biological, and environmental studies.

Teacher tip: To measure brackish or marine samples, perform a dilution until the measurement falls within the range, then multiply by that factor to determine sample conductivity.

Features:

- Measure conductivity and total dissolved solids
- Automatic temperature compensation
- Battery life >1 year
- Remote logging with built-in memory
- Dust-proof, sand-proof, and water-resistant (1 meter for 30 minutes)

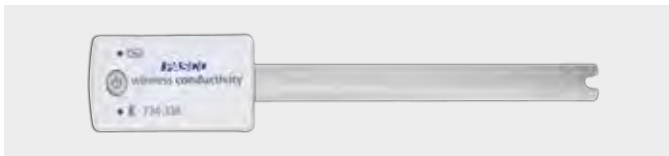
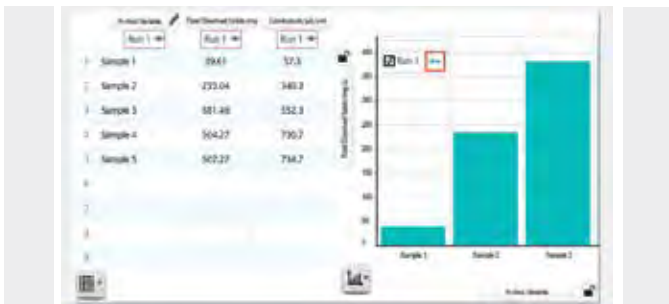

Order Information

Wireless Conductivity SensorPS-3210A

Wireless Conductivity Sensor Pack.....PS-3332

Note: Price for multi-sensor packs includes 8 sensors and custom storage case.



Wireless Light and Color Sensor

PS-3248

The Wireless Light and Color Sensor features two separate apertures: One measures ambient light from the side of the box, and the other measures percent color of directional light at the end of the box.

Features:

- Wirelessly connects to computers, Chromebooks, tablets, and smartphones
- Simply pair and go, no cables or adapters to manage
- On-board memory enables the sensor to function as an independent datalogger
- Variable sampling rate for short, precise experiments or lengthy, multi-day data collection.
- Bluetooth connectivity and long-lasting coin cell battery
- Indirect PAR measurements for biological studies

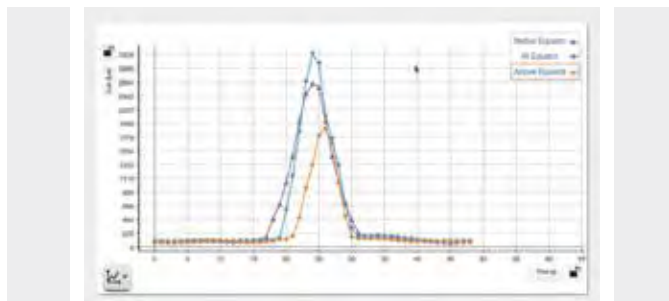

Order Information

Wireless Light and Color SensorPS-3248

Wireless Light Sensor Pack.....PS-3338

Note: Price for multi-sensor packs includes 8 sensors and custom storage case.



Density Circulation Model

ME-6816

The PASCO Density Circulation Model allows students to model, measure and understand the complex density-driven circulation associated with heat transfer through convection. Students can recreate vertical ocean currents driven by water bodies with density differences. They can extend this learning by using sensors to collect data and create graphs showing the thermocline, halocline and pycnocline using a Salinity Sensor PS-2195 (page 81).

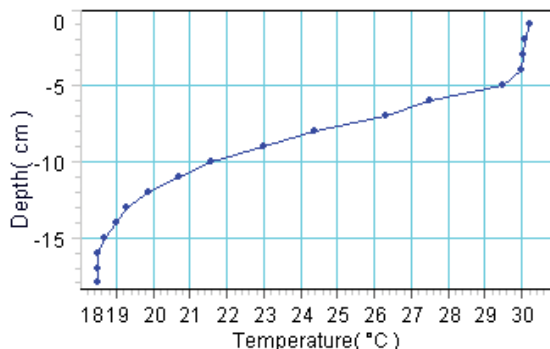

Order Information

Density Circulation ModelME-6816



Wireless Optical Dissolved Oxygen Sensor

PS-3246

The Wireless Optical Dissolved Oxygen (ODO) Sensor is ideal for monitoring DO₂ in the lab or field. The Wireless Optical DO Sensor contains three different probes. In addition to the dissolved oxygen sensor, it also includes probes for measuring atmospheric pressure and water temperature. The optical technology is fast, accurate, and does not require stirring, filling solutions, warm-up, or frequent calibration. The included waterproof probe is submersible to a depth of 2.5 m. The sensor box is not waterproof.

A PASCO exclusive feature allows you to log data using the sensor's built-in memory. After collecting data for hours or even days, simply connect the sensor to your device and you're ready to download your data. With this powerful sensor, educators can explore day and night nutrient cycles, changes in metabolic processes, seasonal changes in water quality, and more.



Order Information

Wireless Optical Dissolved Oxygen SensorPS-3246



EcoZone System

ME-6668

PASCO's EcoZone System is designed to help students model and understand complex interactions within, and among, different ecosystems. The three clear, acrylic EcoChambers are specially designed to accommodate PASCO sensors, making qualitative and quantitative measurements easily accessible.

Students can use the interconnected chambers to model interactions between three different ecosystems. Choose the traditional terrestrial, aquatic, and decomposition environments, or create unique biomes to model and measure. With the EcoZone System, students can create two identical ecosystems for precise control of variable impact, decouple the system for isolated investigations, or connect all three chambers to study interactions.

Features:

- Total volume of each chamber is 4,534 cm³
- Sturdy construction designed for easy setup and cleanup
- Quantitatively study the interaction of different ecosystems
- Custom molded for use with PASCO sensors
- Clear acrylic allows for observations from all sides

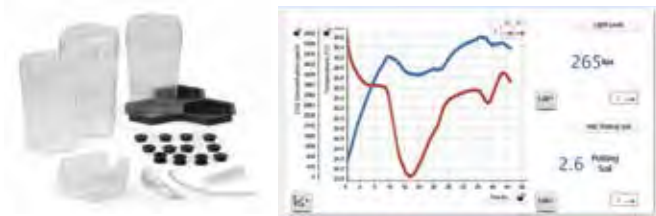

Order Information

EcoZone SystemME-6668



Greenhouse Sense & Control Kit

ST-2997

Designed for the exploration of biological and ecological concepts, the Greenhouse Sense & Control Kit includes everything students need to design, build, program, and study their very own greenhouse.

Build career awareness with activities that make real-world connections to:

- Agricultural monitoring
- Ecological management
- Plant physiology

Help students develop competency in:

- Coding
- Problem solving
- Data collection and analysis
- Ecological concepts
- Science & Engineering practices

This kit includes an EcoChamber, //control.Node, Power Output Module, Soil Moisture Probe, USB Fan and Water Pump, PASCO Grow Light, Greenhouse Accessory Kit, and a Greenhouse Sensor that measures light, temperature, humidity, and soil moisture.



Order Information

Greenhouse Sense and Control KitST-2997



Wireless Colorimeter & Turbidity Sensor

PS-3215

The Wireless Colorimeter & Turbidity Sensor simultaneously measures the absorbance and transmittance of six different wavelengths. The sensor can be used to study Beer's Law (absorbance vs. concentration), enzyme activity, photosynthesis, and the rates of chemical reactions (absorbance vs. time). After a simple calibration, students can quickly begin viewing live measurements as they materialize across the visible spectrum at 650 nm (red), 600 nm (orange), 570 nm (yellow), 550 nm (green), 500 nm (blue), and 450 nm (violet).

This sensor also functions as a high-quality turbidimeter for water quality analysis. Rather than simply measuring transmitted light, the Wireless Colorimeter and Turbidity Sensor measures light scattered at a 90 degree angle from the sample, resulting in accurate and repeatable measurements. Additionally, the internal housing for the cuvette is opaque, which limits ambient light interference to preserve accuracy.

Features:

- Stabilized light source for consistent readings
- Measures six different wavelengths simultaneously
- PASCO software displays the absorbance & transmittance at each wavelength in the appropriate color
- Quick and easy calibration
- Wireless design enables data collection in the field
- Pre-calibrated for ezSample Snap Vial Kits



Measure the absorbance and transmittance of a solution at six different wavelengths... simultaneously!



Chemical Water Quality Testing in the Field

PASCO's ezSample water quality test kits simplify the chemical testing of water sources. Avoid the mess and difficulty of handling chemicals directly and get great results, even in the field.

Colorimetric Analysis

Conduct colorimetric tests in the field and avoid the mess and tedium of mixing chemicals. These ezSample Snap Vials contain a pre-formulated reagent to test a variety of water quality parameters. No more guessing at color variations—drop the vial into the Water Quality Colorimeter and read the concentration.



Order Information

ezSample Snap Vial - Iron	EZ-2331
ezSample Snap Vial - Nitrate*	EZ-2333B
ezSample Snap Vial - Ammonia	EZ-2334A
ezSample Snap Vial - Phosphate.....	EZ-2337
ezSample Snap Vial - Chlorine	EZ-2339A
ezSample Field Titrator - Total Hardness	EZ-2338
ezSample Field Titrator - Carbon Dioxide**.....	EZ-2341
ezSample Field Titrator - Alkalinity	EZ-2340

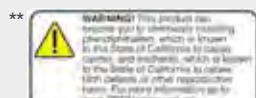
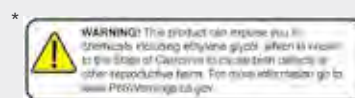

Order Information

Wireless Colorimeter & Turbidity Sensor.....PS-3215
 Includes USB charging cable, 9 cuvettes, 2 cuvette racks, and one 100 NTU calibration cuvette.
 Wireless Colorimeter & Turbidity Sensor PackPS-3334
Note: Price for multi-sensor packs includes 8 sensors and custom storage case.

PASPORT Salinity Sensor

PS-2195

The PASPORT Salinity Sensor works with the 10X Salinity Sensor Probe to measure the salinity, conductivity, and temperature of fresh to brackish water sources. The sensor determines salinity based on electrical conductivity. It also features a built-in calculation, based on the Practical Salinity Scale (PSS), that compensates for changes in conductivity caused by temperature changes.



Order Information

PASPORT Salinity SensorPS-2195

PASPORT Non-Contact Temperature Sensor

PS-2197

The Non-Contact Temperature Sensor measures surface temperature by detecting the emitted infrared light. Record the temperature of objects without touching them!



Order Information

PASPORT Non-Contact Temperature SensorPS-2197

Go Wireless with PASPORT Sensors

PASCO's AirLink Interface connects PASPORT (blue) sensors to your computer using Bluetooth or USB technology.



PASPORT Flow Rate/Temperature Sensor

PS-2130

PASCO's Flow Rate Sensor allows students to measure the temperature and rate of movement of streams, rivers, and other flowing systems. The propeller is a rugged, single-piece unit encased by protective material — no more losing pieces at the bottom of the stream.

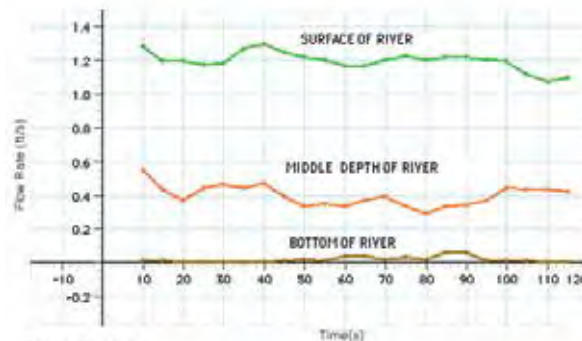

Stream Flow Rate

Graph shows the flow rates at the top (green), middle (orange), and bottom (brown) of a stream.



Order Information

PASPORT Flow Rate/Temperature SensorPS-2130

AirLink Interface

PS-3200

The AirLink connects PASPORT sensors to a Mac or Windows computer, Chromebook, iPad, tablet, or smartphone via Bluetooth or USB connection. The USB cable is included.



Order Information

AirLink InterfacePS-3200

PASCO's Integrated Solutions for Physics

At PASCO, we aim to provide high school physics educators with the most groundbreaking solutions on the market. Our physics solutions pair wireless, cross-platform technology with engaging, hands-on labs to help foster active science learning.

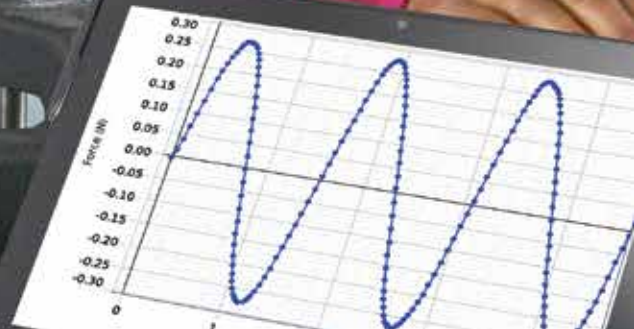
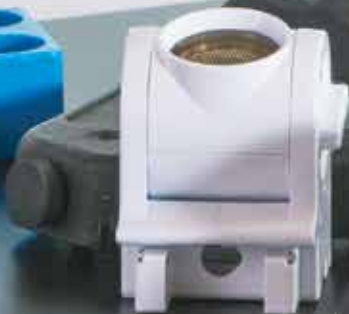



Physics Solutions for General, Honors, IB®, and AP® Physics

Perform more hands-on physics labs with PASCO. Our award-winning sensors, Essential curriculum, and data-collection software let students discover physics through hands-on experimentation. Whether you teach Honors, IB®, AP® Physics 1 or 2, or General Physics, you're sure to find a PASCO solution that's right for you and your students.

Are you receiving our Physics Catalog?
It includes our full line of physics equipment!
pasco.com/catalogs



Physics Index

Mechanics, Physics Lab Stations	86
Fluids, Physics Lab Station.....	88
Electricity & Magnetism, Physics Lab Station	89
Optics, Physics Lab Station.....	90
Waves and Sound, Physics Lab Station	91
Essential Physics Curriculum & Equipment.....	92
Modular Circuits	94
MatchGraph Free Motion Graphing Software	96
Wireless Smart Cart	97
Smart Cart Demo Kit and Accessories	98
Wireless Rotary Motion Sensor.....	100
Wireless Smart Gate and Launchers	101
Wireless Spectrometer & Sound Sensor.....	102
Wireless Geiger Counter.....	105
Wireless Force Platforms.....	107
SPARK LXi2 & the 550 Universal Interface.....	108
Interface Comparison	109
PASCO Capstone.....	110

Physics Lab Station: Mechanics Starter

The Physics Lab Station: Mechanics Starter bundle is a lab-ready solution for performing several key experiments in mechanics. It includes a sensor-loaded Smart Cart, a durable PAstrack, and a variety of accessories that support student studies of core topics such as velocity, conservation of energy, and Newton's second law.

Real-Time Sensor Measurements—Students can use the Smart Cart's built-in sensors to make real-time measurements of position, velocity, acceleration, force, and rotation, displaying them as the lab unfolds for more meaningful learning. They can also collect and compare data from multiple trials, easily apply lines of fit, and perform statistical analysis using PASCO software.

Ready-Made Mechanics Labs—This kit is complemented by a collection of ready-made experiments that can be downloaded for free from the Experiment Library. Each lab comes ready-to-use with editable student handouts, teacher answer keys, and helpful teaching tips.

Perform These Experiments:

- Average Speed and Velocity
- Graphing Motion
- Speed and Velocity Graphs
- Conservation of Energy
- Work and Kinetic Energy
- Newton's Second Law
- Coefficients of Friction
- Momentum and Impulse
- Periodic Motion: Mass and Spring



Mechanics Starter Equipment List

Equipment	Part #	Qty.
Smart Cart (red)	ME-1240	1
Smart Cart Rod Stand Adapter	ME-1244	1
Cart Mass (set of 2)	ME-6757A	2
PAstrack	ME-6960	1
Aluminum Meter Stick		1
Dynamics Track End Stop (2 pack)	ME-8971	1
Small "A" Base	ME-8976	1
Stainless Steel Rod, 60 cm Threaded	ME-8977	1
Mass & Hanger Set	ME-8979	1
Dynamics Track Spring Set	ME-8999	1
Super Pulley Kit	ME-9433	1
Angle Indicator	ME-9495A	1
Multi-Clamp	ME-9507	1
Friction Block	ME-9807	1
Track Rod Clamp	ME-9836	1
Bumper Accessory Set	ME-9884	1



Order Information

Physics Lab Station: Mechanics Starter.....ME-5300

Physics Lab Station: Mechanics Extension

The Physics Lab Station: Mechanics Extension bundle expands your physics toolbox, allowing students to explore topics such as statics, rotation, projectile motion, and periodic motion. It includes an additional Smart Cart for studying collisions, a Mini Launcher for firing projectiles, and a Wireless Smart Gate for timing events accurately. A variety of accessories are also included.

Real-Time Sensor Measurements—Students can use the Wireless Smart Gate and patented Smart Cart to monitor key measurements in real time, displaying them as the lab unfolds for more meaningful learning. Use the Smart Cart’s built-in sensors to measure motion on or off the track, or time events with precision using the dual-beam Wireless Smart Gate. Students can also collect and compare data from multiple trials, easily apply lines of fit, and perform statistical analysis using PASCO software.

Ready-Made Mechanics Labs—This kit is complemented by a collection of ready-made experiments that can be downloaded for free from the Experiment Library. Each lab comes ready-to-use with editable student handouts, teacher answer keys, and helpful teaching tips.

Perform These Experiments:

- Conservation of Momentum
- Momentum and Explosions
- Simple Pendulum
- Atwood’s Machine
- Two Dimensional Motion: Projectiles
- Exploring Torque
- Exploring a Rotating System
- Momentum and Impulse
- Exploring Physical Pendulums



Mechanics Extension Equipment List

Equipment	Part #	Qty.
Smart Cart (Blue)	ME-1241	1
Photogate Mounting Bracket	ME-6821A	1
Mini Launcher	ME-6825B	1
Pivot	ME-7034	1
Meter Stick Torque Mass Hanger Set	ME-7035	1
Photogate Pendulum Set	ME-8752	1
Pendulum Clamp	ME-9506	1
Photogate Wireless Smart Gate	PS-3225	1



Order Information

Physics Lab Station: Mechanics ExtensionME-5301

Required:

Physics Lab Station: Mechanics Starter.....ME-5300

Physics Lab Station: Fluids

The Physics Lab Station: Fluids bundle enables students to perform several essential experiments in fluids. It includes a Wireless Pressure Sensor for making measurements of pressure in liquids and gases. A Density Set and Overflow Can are included for measuring buoyant forces in fluids.

Real-Time Sensor Measurements—Students can use the Wireless Pressure Sensor to make real-time measurements of pressure in liquids or gases, displaying them as the lab unfolds for more meaningful learning. They can also collect and compare data from multiple trials, easily apply statistics, and export their data using PASCO software.

Ready-Made Fluids Labs—This kit is complemented by a collection of ready-made experiments that can be downloaded for free from the Experiment Library. Each lab comes ready-to-use with editable student handouts, teacher answer keys, and helpful teaching tips.

Perform These Experiments:

- Boyle’s Law
- Hydrostatic Pressure
- Buoyant Force



Fluids Equipment List

Equipment	Part #	Qty.
Wireless Pressure Sensor	PS-3203	1
Density Set	ME-8569A	1
Overflow Can	SE-8568A	1



Order Information

Physics Lab Station: Fluids.....ME-2040
 Required:
 Physics Lab Station: Mechanics Starter.....ME-5300

Physics Lab Station: Electricity and Magnetism

This lab-ready equipment set supports experiments in electricity and magnetism across all levels of physics. It includes Wireless Voltage, Current, and Magnetic Field Sensors, an Essential Physics Modular Circuits Kit, and an Electronic Components Kit.

Textbook Circuits for the Real World-The Essential Physics Modular Circuits Kit brings 2D circuitry to the real world, allowing students to study and measure circuits using components that look like textbook models. Each square piece displays both the physical component (resistor, capacitor, etc.) and the schematic to help bridge the gap between circuit diagrams and functioning circuits.

Real-Time Measurements-Students can use the Wireless Voltage and Current Sensors to make measurements anywhere in their circuit. Voltage and current readings are displayed in real time, allowing students to quickly compare and contrast different circuit configurations. They can also use PASCO software to collect and compare data, apply lines of fit, and perform statistical analysis.

Ready-Made Electricity & Magnetism Labs-This kit is complemented by a collection of ready-made experiments that can be downloaded for free from the Experiment Library. Each lab comes ready-to-use with editable student handouts, teacher answer keys, and helpful teaching tips.

Perform These Experiments:

- Ohm's Law
- DC Circuits
- Capacitors and RC Circuits
- Magnetic Field of a Permanent Magnet
- Electromagnetic Induction
- Magnetic Field in a Coil
- Planck's Constant



Electricity & Magnetism Equipment List

Equipment	Part #	Qty.
Essential Physics Modular Circuits Kit	EM-3536	1
Wireless Current Sensor Module*	EM-3534	1
Wireless Voltage Sensor*	PS-3211	1
Wireless Magnetic Field Sensor	PS-3221	1
Electronic Components Kit	EM-8818	1

* Included with EM-3536



Order Information

Physics Lab Station: Electricity and Magnetism.....EM-3557

Physics Lab Station: Optics

The Physics Lab Station: Optics bundle is a lab-ready solution for performing a wide range of optics experiments – from introductory investigations of lenses to advanced experiments in Snell’s Law. It includes a Basic Optics Ray Table, a Light Source, Concave and Convex Mirrors, and various lenses and accessories. The included equipment mounts easily to a PASCO Dynamics Track or a 1.2m Optics Track (sold separately) for hassle-free alignment.

Ready-Made Optics Labs—This kit is complemented by a collection of ready-made experiments that can be downloaded for free from the Experiment Library. Each lab comes ready-to-use with editable student handouts, teacher answer keys, and helpful teaching tips.

Perform These Experiments:

- Spherical Mirror Reflection
- Snell’s Law
- Focal Length of a Converging Lens
- Virtual Images
- Telescope and Microscope
- Shadows



Optics Equipment List

Equipment	Part #	Qty.
Concave/Convex Mirror	OS-8457	1
Basic Optics Viewing Screen	OS-8460	1
Basic Optics Ray Table	OS-8465	1
Basic Optics Light Source	OS-8470	1
Dynamics Track Optics Carriages (Set of 4)	OS-8472A	1
Basic Optics Geometric Lens Set	OS-8456	1
Accessory Lens Set	OS-8519	1



Order Information

Physics Lab Station: OpticsOS-8910

Required:

Physics Lab Station: Mechanics Starter.....ME-5300

Or:

Optics Track, 1.2 m.....OS-8508

Physics Lab Station: Waves and Sound

The Physics Lab Station: Waves & Sound bundle is a lab-ready solution for performing a variety of experiments in waves and sound. It includes a 2-in-1 Wireless Sound Sensor, a complete Tuning Fork Technical Set, a high-quality Resonance Air Column, and a Double-Length Slinky.

Real-Time Sensor Measurements—The Wireless Sound Sensor gives students unparalleled insight into the physics of sound and waves. Students can use the sensor to measure the frequency of a sound wave, and then visualize the waveform using PASCO software. Students can use the Double-Length Slinky to create a waveform with a partner, then use PASCO software to easily measure sound waves for further analysis.

Ready-Made Sound and Wave Labs—This kit is complemented by a collection of ready-made experiments that can be downloaded for free from the Experiment Library. Each lab comes ready-to-use with editable student handouts, teacher answer keys, and helpful teaching tips.

Perform These Experiments:

- Resonance and Standing Waves
- Properties of Sound Waves
- Measuring the Speed of Sound
- Decoding DTMF Tones



Waves and Sound Equipment List

Equipment	Part #	Qty.
Wireless Sound Sensor	PS-3227	1
Tuning Fork Technical Set	SE-7728	1
Resonance Air Column	WA-9606	1
Double-Length Slinky	SE-8760	1



Order Information

Physics Lab Station: Waves and SoundWA-9515

Essential Physics - Your COMPLETE Physics Solution



PASCO's Essential Physics is the only curriculum solution that includes a Student Textbook, Student e-Book, Teacher e-Resources, Student Lab Manual, and Equipment Kits, all at a very affordable price. This 3-D STEM program includes a full year of instruction for both General and Honors Physics classes. Use our complete solution or integrate Essential Physics into your existing curriculum.

Student Textbook & Lab Investigations

- 27 chapters cover a full year of instruction for High School General and Honors Physics programs
- One main idea per page
- Quality illustrations
- Section and Chapter reviews
- 82 complete investigations
- 8 Engineering Design Projects

Student e-Book

- Browser-based version of the textbook
- Same layout with convenient 24/7 online access
- Embedded videos and animations bring content to life
- Interactive equations and simulations enrich key concepts
- Formative and summative assessment questions

Teacher e-Resources for Lab Manual

- SPARKvue software
- Editable documents
- PowerPoint presentations
- Answer keys
- Video lab assistance

Essential Physics is multiplatform and works on iOS, Android™, Chrome™, Windows®, and Mac®. What's more, it includes 24/7 online access, as well as correlations to NGSS and your state standards.

Teacher e-Resources for Textbook

- Infinite Test Bank
- Teacher User Guide
- Teacher e-Book (1-year or multi-year license)
- Alignment details for NGSS and state standards

PASCO Academy Physics Resources

- Available through your PASCO Educator account
- 25 engaging video labs with detailed instruction and data collection
- 25 datasets for student analysis and discussion
- 25 editable lab handouts with teacher answer keys
- Digital access to more than 80 labs for General and Honors Physics

Essential Physics correlates with NGSS and is constructed around the three dimensions:

- Science and Engineering Practices
- Crosscutting Concepts
- Disciplinary Core Ideas



Textbook + e-Book + Equipment

Essential Physics (3rd Edition) Student Textbook EP-6323

This rigorous yet accessible textbook includes core physics topics that cover a complete year of instruction for both High School General and Honors Physics classes. The lessons follow the 5E model and include tools for ELL students, as well as tools for students with different learning styles. The curriculum aligns to NGSS and your state standards for both regular and advanced coursework. The accessible textbook includes one main idea per page, quality illustrations, 89 complete investigations, eight Design Projects, and Section and Chapter Reviews. The 27 chapters cover these topics:

- Science of Physics
- Physical Quantities and Measurement
- Position and Velocity
- Acceleration
- Forces and Newton's Laws
- Motion in Two and Three Dimensions
- Circular Motion
- Static Equilibrium and Torque
- Work and Energy
- Conservation of Energy
- Momentum and Collisions
- Machines
- Angular Momentum
- Harmonic Motion
- Sound Waves
- Electricity and Circuits
- Electric and Magnetic Fields
- Electromagnetism
- Light and Reflection
- Refraction and Lenses
- Electromagnetic Radiation
- Properties of Matter
- Heat Transfer
- Thermodynamics
- Quantum Physics and the Atom
- Nuclear Physics

Essential Physics Student e-Book

The Student e-Book is an electronic version of the full textbook with interactive elements. Throughout the electronic text, content and theory are supported with optional audio reading, as well as interactive elements, such as digital equations, videos, animations, and simulations. Students also have the option of expanding the content using the 'more' button to go deeper into concepts.

Essential Physics Labs & PASCO Equipment Bundles

Use PASCO's Physics Lab Stations to perform the following hands-on investigations from *Essential Physics*.

ME-5300 Physics Lab Station: Mechanics Starter

- **1A:** Graphs of motion
- **3B:** Motion graphs
- **4A:** Acceleration
- **4B:** A model for accelerated motion
- **5A:** Newton's second law
- **5B:** Hooke's law
- **5C:** Static and kinetic friction
- **6C:** Acceleration on an inclined plane
- **9A:** Work and the force versus distance graph
- **10A:** Inclined plane and the conservation of energy
- **10B:** Work and energy
- **10C:** Springs and the conservation of energy
- **10D:** Work done by friction
- **11C:** Elastic collisions
- **12C:** Ramps and inclined planes

ME-5301 Physics Lab Station: Mechanics Extension

- **6B:** Projectile motion
- **11A:** Conservation of momentum
- **11B:** Inelastic collisions
- **14A:** Oscillators
- **14C:** Resonance

EM-3557 Physics Lab Station: Electricity and Magnetism

- **17A:** Electricity and circuits
- **17B:** Voltage and batteries
- **17C:** Resistors and Ohm's law
- **17D:** Series and parallel circuits
- **17E:** Electrical power
- **17F:** Compound circuits
- **18A:** Magnetic force between magnets

OS-8910 Physics Lab Station: Optics

- **20A:** Magnification of mirrors and lenses
- **20B:** Reflection in a plane mirror
- **20C:** Image formation for curved mirrors
- **21A:** Refraction of light
- **21B:** Creating real and virtual images with lenses
- **21C:** Image formation for a convex lens
- **21D:** Build a microscope and a telescope

WA-9515 Physics Lab Station: Waves and Sound

- **15A:** Waves
- **15C:** Interference
- **16D:** Resonance and Sound

Additionally, the following labs can be performed with the Simple Machines Kit (EP-3577):

- **8A:** Static equilibrium
- **12A:** Levers
- **12B:** Pulleys





Learn more at pasco.com/circuits

Basic Modular Circuits Kit

EM-3535

These circuit modules are designed specifically for introductory circuit investigations. For students who have never wired a circuit, this modular system makes it easy for them to see their circuit physically laid-out exactly as it appears in their circuit diagram.

Each module connects mechanically to another by sliding the tabs into each other. It works on any tabletop. No special surface is required. To electrically connect two modules, students insert a jumper clip, which emphasizes that an electrical connection has been made. The large size of the modules (8 cm x 8 cm) enables all the students around the table to see and understand the completed circuit.

Each module connects mechanically to another by sliding the tabs into each other. To make them visible, many of the components are mounted on top of the module or in a well for protection.



The Basic Modular Circuits Kit is a lower cost, introductory set with fewer components than the Essential Physics Modular Circuits Kit. The Wireless Voltage Sensor and Wireless Current Module are not included.



Order Information

Basic Modular Circuits Kit.....EM-3535

Essential Physics Modular Circuits Kit

EM-3536

The Essential Physics Modular Circuits Kit includes more modules, such as the Wireless Current Sensor Module and Wireless Voltage Sensor. The Essential Physics Modular Circuits Kit will also support applications like RC and RLC circuit analysis, electric motors, Kirchhoff's Laws, and much more!



The Essential Physics Modular Circuits Kit seamlessly integrates sensors, like the Wireless Current Sensor Module & Wireless Voltage Sensor.



Order Information

Essential Physics Modular Circuits Kit.....EM-3536
 Modular Circuits Expansion Kit.....EM-3540

Compare Modular Circuit Kits

Kits include these modules and apparatus:

	Basic EM-3535	Essential EM-3536	Expansion EM-3540		Basic EM-3535	Essential EM-3536	Expansion EM-3540
Corner Wire	4	4	2	Battery, AA	2	2	
Straight Wire	4	5	2	Jumper Clips	30	45	15
Tee	2	2	2	Diode	1	1	
Spring	1	1	1	330 ohm Resistor	1	2	
Switch, SPDT	1	1		1000 ohm Resistor	1	2	
Switch, SPST	1	1		100 microfarad Capacitor	1	1	
Resistor	2	3		330 microfarad Capacitor	1	1	
Capacitor	1	1		Magnets, 0.45" x 0.25"	0	8	
Light Bulb	2	3	1	Plotting Compass	0	1	
Potentiometer	0	1		Alligator Clip Jumper Wire	0	1	
Motor	0	1		EM-3534 Wireless Current Sensor	0	1	
LED	0	1		PS-3211 Wireless Voltage Sensor	0	1	
1000 Turn Coil	0	1		Gratnells® Storage Tray	1	1	1
Battery Holder	2	2	1	Banana Jack Terminal			1

Wireless AC/DC Module

EM-3533

The Wireless AC/DC Module is a Bluetooth® wireless signal generator designed for use with PASCO's Modular Circuits. The AC/DC Module can act as a DC power supply, as well as generate Sine, Triangle, and Square AC signals. A built-in battery provides long lasting power for your basic circuits, and it can be recharged using the included USB cable. An internal voltage sensor monitors the output voltage at all times. The Wireless AC/DC Module is controllable in either PASCO Capstone or SPARKvue software. This latest circuit module expands the number and type of experiments you can perform with Modular Circuits including Ohm's Law, RC Circuit Time Constant, and LRC labs.

Programmable using Blockly programming in PASCO Capstone 2 and SPARKvue software.

Features:

- Compatible with Modular Circuits
- ±3 V Output; 0.3 A Max
- DC, Sine, Triangle, Square
- Bluetooth® Low Energy
- Rechargeable Battery
- Controllable with PASCO Capstone or SPARKvue Software



Perform Circuits Emulations with Modular Circuits and PASCO Capstone 2

Reinforce circuit concepts and tackle student misconceptions using circuit visualization.

When you use Modular Circuits with PASCO Capstone 2 and its Circuits Emulation tool, you can:

- Construct and modify circuits
- Show conventional current or electron flow animation
- Animate circuits with live sensor data

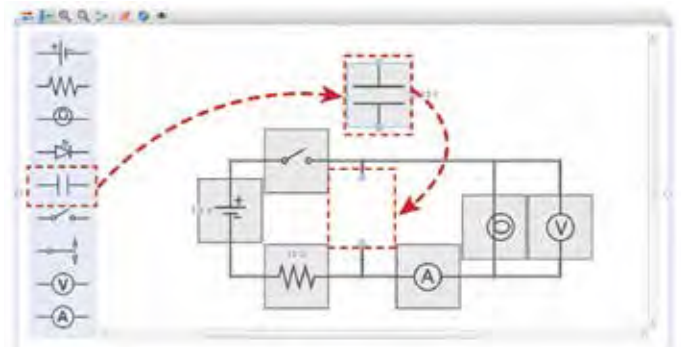

Order Information

Wireless AC/DC ModuleEM-3533

Learn more about Capstone 2 on pages 110-113.



Wireless Motion Sensor

PS-3219

The Wireless Motion Sensor connects via Bluetooth® or USB to your device, and uses ultrasound to measure the position, velocity, and acceleration of objects. This enables students to take turns measuring themselves, while the class observes their motion materializing as a graph in real time. The sensor can detect objects ranging from 15 cm to 4.0 m away, and without cables to get in the way, students can explore handheld and ceiling-mounted applications.

Features:

- Measures position, velocity, and acceleration
- False Target Rejection Technology produces clean data
- Clips directly to PASCO Dynamics Tracks
- Rod clamp for mounting
- 180° pivoting head
- Rechargeable lithium-ion battery
- Bluetooth® and USB connectivity



Order Information

Wireless Motion SensorPS-3219

Wireless Motion Sensor Pack.....PS-3337

Note: Price for multi-sensor packs includes 8 sensors and custom storage case.

Free MatchGraph! Software

MatchGraph software is the most intuitive way to teach motion graphing. Engage your students with a kinesthetic experience that teaches graphing centered on motion. In MatchGraph, students attempt to match one of the nine provided graphs and are given a score showing how accurately they match the chosen curve. This activity gives them a deeper understanding of interpreting graphs as they see their own position and velocity graphed in real time.

Using a PASCO Motion Sensor, students create graphs of their own motion that they can then analyze. When using a Smart Cart, a real-time motion graph is displayed as students move the cart.

MatchGraph is great for teaching:

- Fundamental graphing skills
- Basic concepts of position and velocity
- The concept of slope
- What it means when the slope is zero
- How position and velocity graphs relate to each other

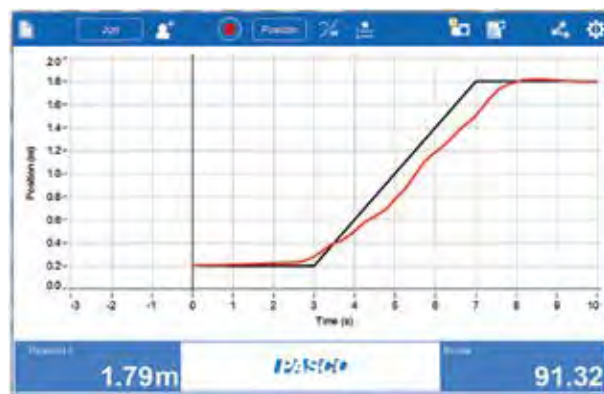

Download the Free MatchGraph! App



For Mac® and Windows® computers, visit pasco.com/downloads. Download the free iPad® or Android™ app from the App Store or Google Play.





Smart Cart (Red/Blue)

ME-1240/ME-1241

The patented Smart Cart is the ultimate tool for studying kinematics, dynamics, Newton's laws, and more. It is based on a durable ABS body with nearly frictionless wheels, just like our high quality PAScars. Now, we've added built-in sensors that measure force, position, velocity, and acceleration. The versatile Smart Cart can collect measurements on or off a track and transmit the data wirelessly over Bluetooth®. In essence, it is a wireless dynamics cart that combines all the necessary sensors, without requiring any additional hardware.

Smart Carts are ideal for studying mechanics topics, such as kinematics and dynamics. The built-in load cells enable two Smart Carts to visually demonstrate Newton's third law with ease. Additionally, built-in sensors for force and acceleration enable students to investigate Newton's second law in minutes. Smart Carts truly are a physics lab on wheels, and now you can own the most advanced physics cart ever created, all without the restrictions of cables.

Features:

- Built-in ± 100 N force sensor
- 3-axis accelerometer
- Bluetooth® connectivity
- Rechargeable battery
- Motion encoder measures position and velocity on or off the track
- Magnetic bumper for force sensor
- 3-position plunger
- Mass tray
- Velcro® tabs
- Force sensor hook and rubber bumper

Smart Cart Charging Garage

ME-1243

Charge up to five Smart Carts at once. Provides storage for the carts and accessory bumpers. Includes power adapter.

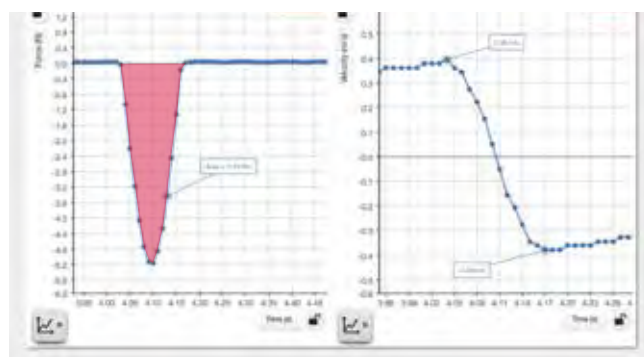

Patent No.
10,481,173

The graphs show the impulse experienced and the change in velocity created by a collision between a Wireless Smart Cart and a cardboard bumper.



Measure the force exerted directly on the cart when the hook is pulled by a string attached to a mass hanging over a pulley.

Order Information

Smart Cart (Red)	ME-1240
Smart Cart (Blue)	ME-1241
Smart Cart Charging Garage	ME-1243



Smart Cart Demonstration Kits

ME-1272 (RED)/ME-1273 (BLUE)

The Red & Blue Smart Cart Demonstration Kits come with a Smart Cart and all the accessories you need to perform amazing physics demonstrations in kinematics and dynamics.

Features:

- Smart Cart (red or blue)
- Smart Fan Accessory
- Two 250-g Cart Masses
- Smart Cart Rod Stand Adapter
- Ballistic Cart Accessory
- Smart Cart Vector Display
- Sail
- Grattells Case
- Demonstration Manual



Order Information

Red Smart Cart Demonstration KitME-1272
 Blue Smart Cart Demonstration Kit.....ME-1273



Smart Cart Vector Display

ME-1246

The Smart Cart Vector Display adds visual vectors to your Smart Cart for Force, Acceleration, or Velocity. Connect it to the Smart Cart's accessory port to visualize vectors in real time! The arrows light up proportional to the sensor reading and indicate both magnitude and positive or negative direction.

Features:

- Choose from Force, Acceleration, or Velocity vectors, and watch them in real time
- Students can visualize constant acceleration as a cart rolls up and then down an incline
- Great for the student lab station or for a physics lecture demonstration!
- Selectable ranges



Order Information

Smart Cart Vector DisplayME-1246



Smart Ballistic Cart Accessory

ME-1245

The Smart Ballistic Cart Accessory mounts to any PASCO dynamics cart for a classic demonstration on the independence of X and Y motion. A projectile fired from the accessory while a cart is in motion will be caught farther down the track. When mounted to a PASCO aluminum cart or PAScar, the projectile is launched using a push button timer delay. When connected to a PASCO Smart Cart, the Smart Ballistic Accessory can launch the projectile based on measurements made by the Smart Cart in either SPARKvue or PASCO Capstone software.

Features:

- Compatible with all PASCO dynamics carts
- Push button timer to delay the launch of the projectile until after the cart is pushed
- Release mechanism does not affect cart motion or ball flight path
- The barrel has X and Y adjustments, so perfect vertical projections can be produced every time
- Fires a colored nylon ball 0.5 meters or higher for impressive demonstrations
- Connects to the Smart Cart for measurement-based launching conditions
- USB rechargeable Li-ion battery



Order Information

Smart Ballistic Cart AccessoryME-1245



Smart Fan Accessory

ME-1242

What makes this fan so smart? If you use this fan on a regular cart, you can turn it on and select one of three speeds by pushing the button on the side. But plugging it into a Smart Cart gives this Smart Fan Accessory added capabilities:

- **Hands-off Operation:** Turn the Smart Fan on and off wirelessly from your computing device.
- **Adjust the Thrust:** Move the slider in the software and watch the fan respond.
- **Reverse the Spin of the Fan:** Input a negative thrust to make the fan blow in the opposite direction.
- **Set Start and Stop Conditions:** Choose to start the fan when a measurement (such as position) reaches a certain value. Make the fan stop after a certain time, so the cart coasts during part of the experiment.
- **Sense and Control:** Program the Smart Fan thrust to respond to a calculation based on sensor measurements.

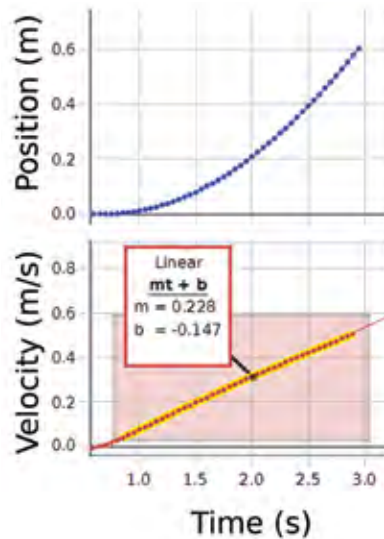

Sample position and velocity data.



Order Information

Smart Fan AccessoryME-1242



Smart Cart Motor 

ME-1247

The Smart Cart Motor is a motor-driven wheel that attaches to the Smart Cart to make it go at a constant velocity, forwards or backwards. The motor's power can be wirelessly adjusted from 0 to 100% using either SPARKvue or PASCO Capstone software.



Order Information	
Smart Cart Motor	ME-1247



Wireless Rotary Motion Sensor 

PS-3220

The Wireless Rotary Motion Sensor measures angle, angular velocity, and angular acceleration, as well as their linear equivalents. The included three-step pulley can be rotated at different rates of acceleration to apply various torques. Use the rod-mounting holes to easily position the sensor for different experiments. This sensor connects directly to your devices via Bluetooth® or USB.

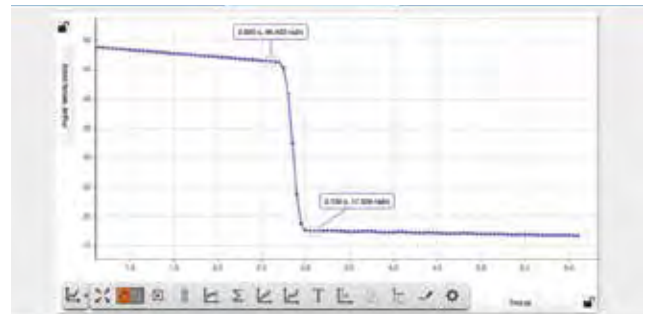

Order Information	
Wireless Rotary Motion Sensor	PS-3220

Wireless Smart Gate

PS-3225

The Wireless Smart Gate is more than just a photogate. It has dual photogate beams spaced 1.5 cm apart to accurately measure speed. When used with a laser, students can use the built-in laser switch to time objects that are too large to fit through the photogate beams. It also includes a photogate tape slot for measuring the movement of objects and an auxiliary port for adding another photogate head or the Time-of-Flight Accessory.

Highlights:

- Dual photogate beams
- Laser switch
- Auxiliary photogate/ Time-of-Flight port
- Photogate tape slot
- USB and Bluetooth®
- Rechargeable



Projectile Launcher Wireless Smart Gate System

ME-6796

Choose this wireless option to eliminate cables between the computer and Projectile Launcher. The Wireless Smart Gate has all the features of the Smart Gate (PS-2180), but it connects to your computing device via Bluetooth® or USB; it does not require an interface.

Includes:

- Wireless Smart Gate with Mounting Bracket
- Launcher with Mounting Stand
- Steel Balls with Loading Rod
- 2-D Collision Accessory
- Aluminum Table Clamp
- 45 cm Stainless Steel Rod

Mini Launcher

ME-6825B

PASCO's Mini Launcher provides a low-cost method for every student to thoroughly investigate projectile motion. The Mini Launcher has the same level of precision and accuracy as our larger Projectile Launcher (ME-6800), but is easier to assemble, simple to adjust, and provides built-in storage for the plunger and metal balls.



Projectile Launcher

ME-6800

The Projectile Launcher demonstrates the concept that motion in different dimensions is absolutely independent. A good launcher not only illustrates this non-intuitive idea, but it also describes the exact motion of the projectile. PASCO has precision-engineered the Projectile Launcher to be durable, accurate, and consistent for highly repeatable results.

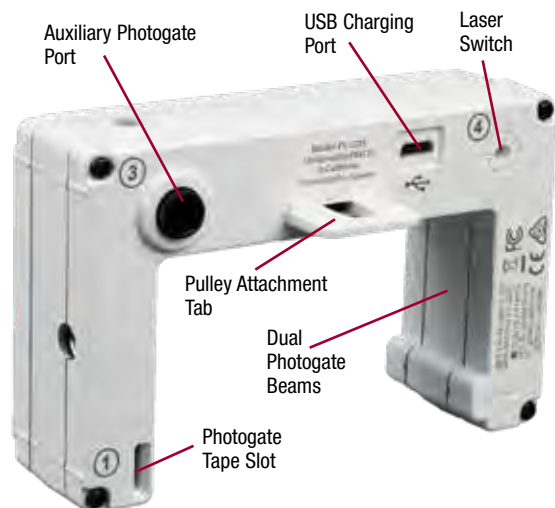

Order Information

Wireless Smart Gate	PS-3225
Mini Launcher.....	ME-6825B
Projectile Launcher Wireless Smart Gate System	ME-6796
Projectile Launcher	ME-6800

Wireless Spectrometer (Vis)

PS-2600

The award-winning PASCO Wireless Spectrometer is specifically designed for modern chemistry, biology, and physics labs. It connects to student devices via USB or Bluetooth® Low Energy and includes free Spectrometry software with built-in tools for spectral analysis. Scan times are fast, enabling students to collect a full spectrum of data in less than a second. Three plots are provided for common applications, including Absorbance vs. Wavelength (or Intensity vs. Wavelength), Absorbance vs. Concentration (Beer's law), and Absorbance vs. Time (kinetics).

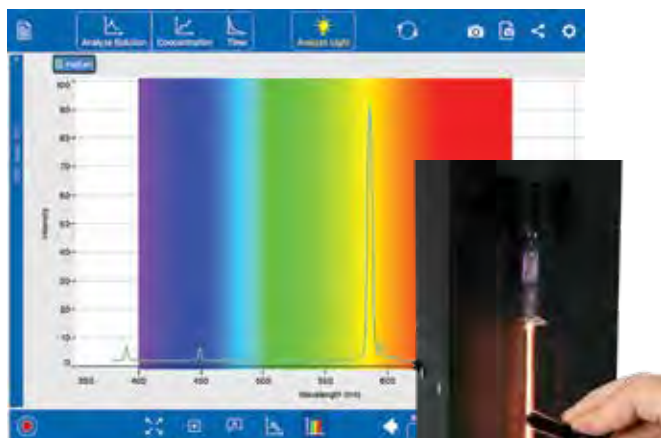

Analyze light sources with the optional Fiber Optic Cable. Easily compare the spectrum to known reference lines in the software.



Order Information

- Wireless Spectrometer (Vis)PS-2600A
- Fiber Optic CablePS-2601



Wireless Sound Sensor

PS-3227

The Wireless Sound Sensor is two sensors in one wireless package: A sound wave sensor capable of measuring changes in relative pressure level as a function of time, and a sound level sensor with both dBA and dBC-weighted scales.

Features:

- Wirelessly collects sound wave data at high sample rates (100 kHz)
- Two sound sensors in one (sound wave and sound level)
- High quality sensing element intended specifically for laboratory experiments
- Connects seamlessly to Scope and FFT displays in both SPARKvue and PASCO Capstone software
- Threaded 1/4-20 socket for easy mounting and alignment/positioning

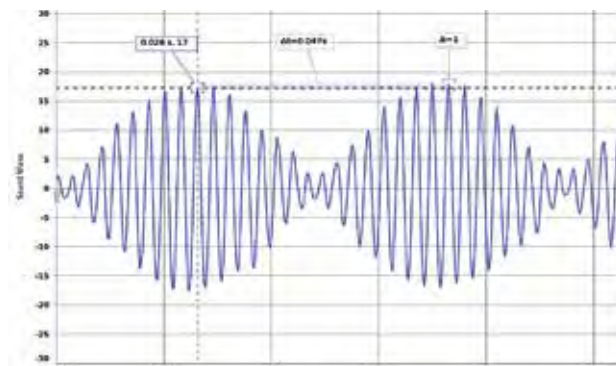

Easily observe and measure beat frequencies

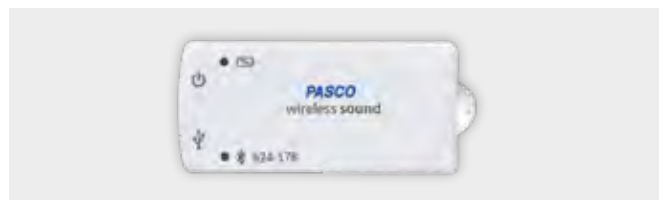

Order Information

- Wireless Sound SensorPS-3227
- Wireless Sound Sensor Pack.....PS-3342

Note: Price for multi-sensor packs includes 8 sensors and custom storage case.

Wireless Magnetic Field Sensor

PS-3221

This 3-Axis Magnetic Field Sensor can sense the Earth's magnetic field and fields from coils and bar magnets. There are two ranges: ± 50 gauss and ± 1300 gauss. This sensor is primarily for static fields.

Highlights:

- Simultaneous measurements on three axes
- **Dual range:** ± 50 G and ± 1300 G
- Sensitive enough to measure the Earth's magnetic field
- Measure fields from bar magnets and coils

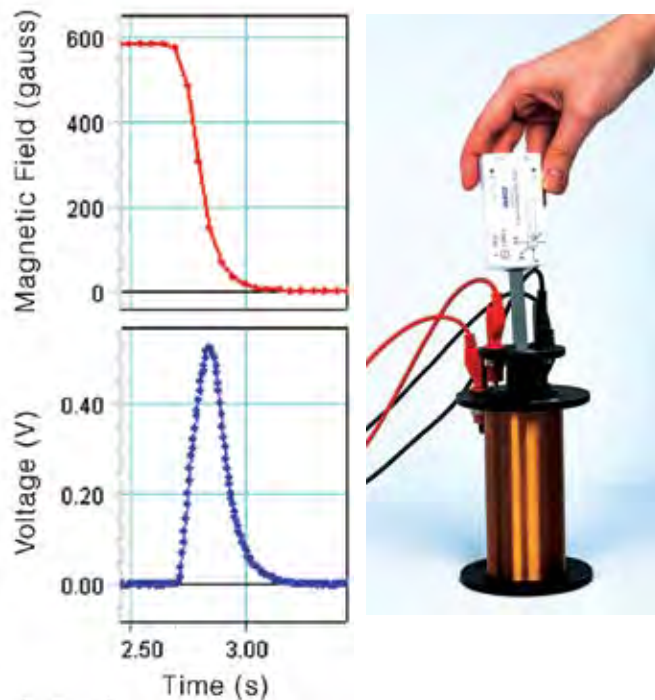

Order Information

Wireless Magnetic Field SensorPS-3221



Wireless Acceleration/Altimeter

PS-3223

The Wireless 3-Axis Acceleration/Altimeter can remotely log acceleration in three dimensions and altitude, making it ideal for recording data during roller coaster rides.

Specifications:

Accelerometer Ranges: ± 16 g, ± 100 g, ± 200 g, ± 400 g

Measurements: Acceleration (3 axes and resultant); Altitude; Angular Velocity (3 axes)

Logging: Yes

Battery: Coin Cell

Connectivity: Bluetooth® 5.2

Dimensions: 3.02" x 1.6"

Highlights:

- 3-axis accelerometer
- 3-axis gyroscope
- Altimeter
- Rubberized case
- Includes mounting strap

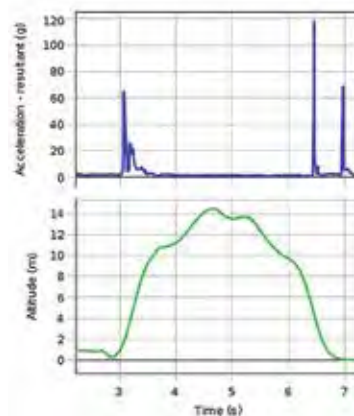

Order Information

Wireless Acceleration/Altimeter.....PS-3223



Wireless Pressure Sensor

PS-3203

The Wireless Pressure Sensor allows students to easily collect accurate gas pressure data for a wide range of applications. Included is a 60 cc syringe, tubing, and connectors that facilitate experiments such as Boyle’s law and measuring pinch-grip strength. Within PASCO’s software, students can easily select their desired units from a list containing kPa, mmHg, inHg, mbar, psi, atm, and torr.

Features:

- Measures pressure even when the pressure within the system drops below ambient pressure
- Supports common units (kPa, atm, psi, mmHg, or N/m²) for many applications
- Bluetooth® wireless connectivity and long-lasting rechargeable battery

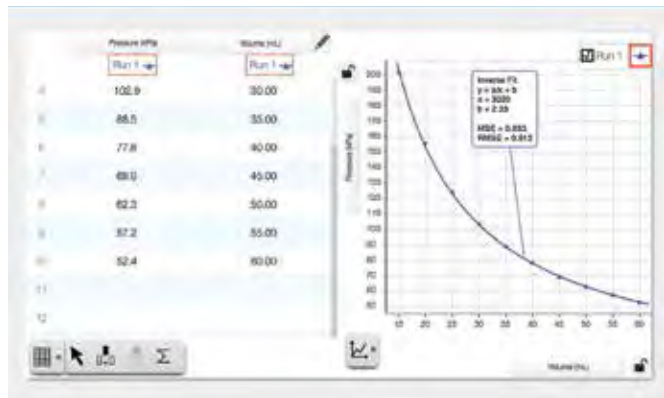

With the included syringe, your students can easily quantify the relationship between pressure and volume.



Order Information

- Wireless Pressure SensorPS-3203
- Wireless Pressure Sensor Pack.....PS-3333

Note: Price for multi-sensor packs includes 8 sensors and custom storage case.

Wireless Light and Color Sensor

PS-3248

The Wireless Light and Color Sensor features two separate apertures: One on the side of the box for ambient light measurements and one at the end of the box for directional light measurements for percent color.

The ambient sensor measures:

Lux: Light energy from a point in a direction (per steradian, a solid angle) per second.

Illuminance: Light intensity per area, or brightness in the range our eyes perceive.

Irradiance: Power of the light per area. (Depends on wavelength as UV light has more energy than infra red).

PAR (Photosynthetically Active Radiation): Amount of light in the visible range 400 -700 nm available to stimulate plant growth.

UV Index: 1 to 12 scale for the time light takes to cause skin damage. Larger numbers cause burns faster.

The spot sensor measures:

RGB: Light levels as a percent of the total of all colors measured

White: Total ‘white’ light intensity as a function of the sensor (on a scale of 65,536)



Order Information

- Wireless Light and Color Sensor.....PS-3248
- Wireless Light Sensor Pack.....PS-3338

Note: Price for multi-sensor packs includes 8 sensors and custom storage case.

Wireless Geiger Counter

PS-3238

The PASCO Wireless Geiger Counter counts beta, gamma and alpha radiation particles as they enter the Geiger-Müller detector tube inside the counter. Designed for easy mounting, the Geiger Counter provides superior position control in inverse square law labs, as well as an audible beep to indicate the detection of ionizing radiation. The front plastic snout fits conveniently inside the NU-3344 Sample Holder stand (available separately), which stabilizes the front of the counter's detector tube exactly 1 cm from the first slot in the holder.

With the Wireless Geiger Counter, students can wirelessly control the high voltage supplied to the Geiger-Müller tube inside the counter, enabling them to make measurements of counts per interval for different tube voltages. They can also create a plot of counts/interval versus tube voltages to experimentally observe the Geiger plateau characteristics of the tube.

Features:

- Built-in metal mesh screen to protect the delicate mica window in the front of the Geiger-Müller detector tube
- Audible beep to indicate counts can be easily switched on or off
- **Versatile positioning options:** Use it with the NU-3344 Sample Holder, hand-held, or mount it to a rod stand
- Convenient design natively fits the PASCO NU-3344 Sample Holder
- Provides wireless control over the high voltage supplied to the Geiger-Müller tube inside the counter for Geiger plateau experiments

Specifications:

Sensitivity: Alpha, Beta, Gamma

Count Detection: Switchable audio signal

Gas Filling: Ne +Halogen

Effective Tube Diameter: 9.1 mm

Window Thickness: 1.5 to 2.0 mg/cm²

High Voltage Control Range: 150 VDC to 650 VDC

Standard Operating Voltage: 500 VDC

Includes:

- Wireless Geiger Counter
- Micro USB Cable: PS-3584
- Threaded handle for mounting the sensor to a ring stand

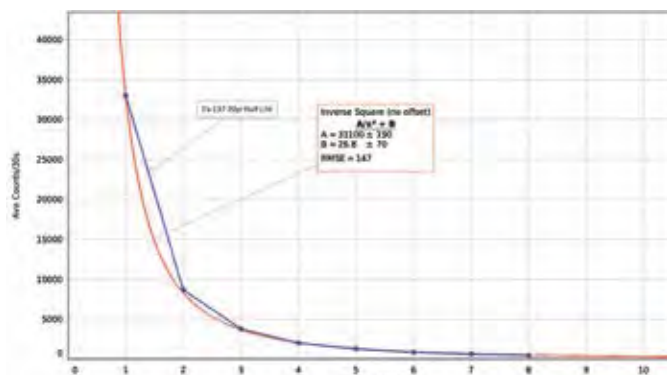

Measure counts/interval from a radioactive source at various distances to explore the inverse square law.

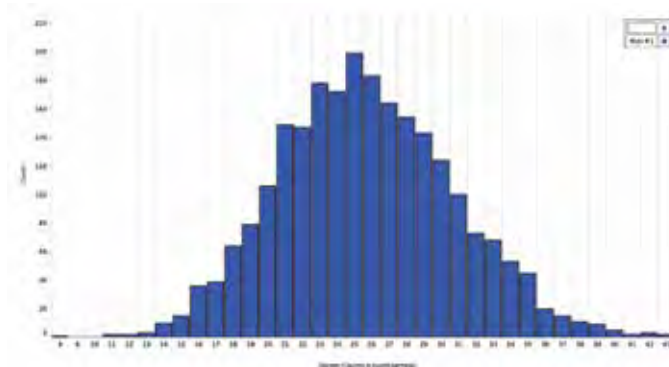

Demonstrate the statistical (gaussian or poisson) nature of counts/interval measured from a radioactive source with a long half-life.

Stabilize samples with the optional PASCO Geiger Counter Sample Holder.



Order Information

Wireless Geiger Counter.....PS-3238
 Geiger Counter Sample HolderNU-3344

Wireless Temperature Sensor

PS-3201

Welcome to the modern thermometer. The Wireless Temperature Sensor transmits live data and allows students to continuously monitor, log, and plot temperature measurements on nearly any device. When lab-time ends but the experiment continues, students can set the sensor to log data autonomously for days, weeks, or months, then download it for analysis later. This durable, wireless sensor features a stainless steel probe for the most demanding of applications, as well as a battery that lasts over a year*. It can be used in a wide array of experiments and activities because it measures small, but significant temperature changes produced by chemical reactions, convection currents, and even skin temperatures.



Order Information

Wireless Temperature Sensor.....PS-3201

Wireless Temperature Sensor Pack.....PS-3330

Note: Price for multi-sensor packs includes 8 sensors and custom storage case.

Wireless Current Sensor

PS-3212

The Wireless Current Sensor's broad current range supports a wide variety of experiments, ranging from basic circuit studies to advanced electricity labs. Designed with user safety in mind, the sensor can be used to measure currents up to 1 A and includes built-in overload protection. The collected data can be wirelessly transmitted to computers, Chromebooks, tablets, and smartphones. When paired with the Wireless Voltage Sensor, students can explore Ohm's Law, circuits in series and parallel, and much more.

Wireless Voltage Sensor

PS-3211

The Wireless Voltage Sensor is ideal for exploring the fundamental concepts of electricity, voltage, and basic circuits. Complete with built-in overload protection, this sensor measures voltages up to ± 15 V and features high-speed sampling rates when connected via USB. When used with the Wireless Current Sensor, students can use it to explore Ohm's law, circuits in series and parallel, and much more.



Order Information

Wireless Current SensorPS-3212

Wireless Voltage Sensor.....PS-3211

Note: Multi-sensor packs with 8 sensors and custom storage case available on web.



Wireless Force Acceleration Sensor

PS-3202

Capable of simultaneously measuring force, acceleration, and rotational velocity, this sensor is ideal for experiments involving rotating platforms, moving carts, spring oscillations, collisions, and impulse. The wireless design offers improved measurement accuracy by eliminating cords that affect data collection. Students can use the finger-holes for handheld applications, or mount it onto a cart or rod for more complex experiments.

Teaching Advantage:

- Bluetooth® 5.2 simple, one touch in-app pairing
- Long-lasting rechargeable battery
- Zeroing is completed within the software for accurate taring
- Logging mode stores data for force, acceleration, and rotation directly on the sensor for long-term experiments
- Simultaneously measures force and acceleration
- Built-in 3-axis acceleration sensor measures acceleration in x, y, and z axes, and calculates resultant acceleration
- Built-in gyroscope measures rotation about x, y, and z axes

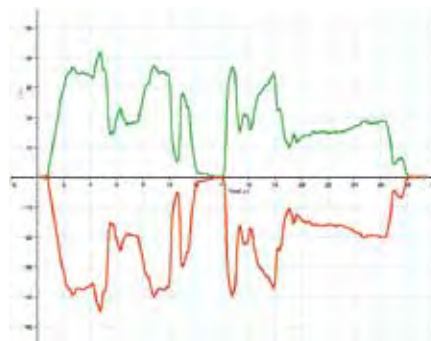

The Wireless Force Acceleration Sensor is perfect for explorations of Newton's third Law.



Order Information

Wireless Force Acceleration Sensor.....PS-3202

Wireless Force Acceleration Sensor Pack.....PS-3339

Note: Price for multi-sensor packs includes 8 sensors and custom storage case.



Wireless 1 & 2-Axis Force Platforms

PS-3229 & PS-3230

The Wireless Force Platforms build on the success of our PASPORT Force Platforms, offering users the same reliable performance with enhanced durability and a convenient, wireless connection.

The new design features a sturdy, glass-filled nylon platform and four supporting force beams that measure the forces acting normal to the platform's surface. The Wireless 2-Axis Force Platform also includes a fifth beam for measuring forces parallel to the platform. Along the bottom of each platform are four adjustable feet that make leveling quick and easy, while also ensuring stability between the force beams and the surface below. Students can measure the force applied to each beam independently or the overall resultant force acting on the surface of the platform (up to 5200 N). With their new wireless design, the Wireless Force Platforms are easier to use than ever, providing both spacial flexibility and custom sample rates for high speed sampling over Bluetooth® (up to 10 kHz).

Features:

- Improved ruggedized design with increased maximum force range
- Mechanical force over-limit protection
- Wide top surface for jumping and standing
- Burst sampling option for high speed wireless data collection

Specifications:

1-Axis Range: -1320 N to 5280 N (resultant)

2-Axis Range: -1320 N to 5280 N (resultant); ± 1300 N parallel force

Surface Dimensions: 35 cm x 35 cm

Maximum Sample Rate: 10 kHz

Resolution: 0.2 N

1-Axis Force Over-Limit Protection: -500 N to 2000 N per beam

2-Axis Force Over-Limit Protection: -500 N to 2000 N per vertical beam; ± 2000 N parallel beam

The 2-Axis platform measures the normal and parallel forces acting on the platform simultaneously. Determine the static weight of a structure or person, measure forces associated with the impacts of falling objects, and determine the dynamic vertical and parallel forces that arise when moving or jumping.



Order Information

Wireless Force Platform	PS-3229
Wireless 2-Axis Force Platform	PS-3230
Handle Set, Force Platform.....	PS-2548

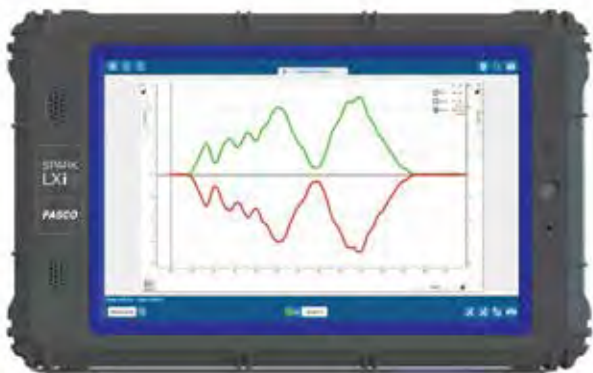

SPARK LXi2 Datalogger

PS-3600B

The SPARK LXi2 Datalogger is a Bluetooth®, handheld datalogger that enables students to connect wired and wireless sensors, collect data, generate graphs, and analyze results. It is durable, splash-proof, and works seamlessly with PASCO sensors. The SPARK LXi2 can simultaneously accommodate up to five wireless sensors, includes two ports for PASPORT sensors, as well as two ports for the included Fast Response Temperature Probe and Voltage Probe. It can be used with PASCO Wireless sensors, PASPORT sensors and an AirLink, SPARKlink® Air, and the 550 Universal Interface.

Built for Student Use:

- Portable
- Shock-absorbing case
- 8" Color Capacitive Touchscreen (1280 x 800 pixels)
- 2 GHz Quad Core Processor, 2.0 GB RAM, 32 GB Memory
- Voltage and temperature sensor ports with included probes
- Wi-Fi enabled
- Wireless sensors and Smart Carts connect via Bluetooth®
- Two PASPORT sensor ports
- **Loaded with PASCO software:** SPARKvue for data collection and analysis, MatchGraph!, and Spectrometry software



The SPARK LXi2 features two PASPORT ports as well as ports for the included temperature and voltage probes.



Scan to learn more about the SPARK LXi2



550 Universal Interface

UI-5001

The 550 Universal Interface is fast, powerful, and incredibly affordable. The cost-effective 550 offers half the ports and many of the same features as our 850 Universal Interface, including both Bluetooth® and USB connectivity. The 550 Universal Interface includes two PASPORT sensor ports, two digital sensor ports, two analog sensor ports, and a built-in signal generator.

The 550's two digital inputs are compatible with all ScienceWorkshop digital sensors, as well as timing devices, and photogates. The two analog ports connect with our analog ScienceWorkshop sensors and can support a 2.0 MHz max sampling rate and 1.22 mV resolution for voltage sensing.

The 550's built-in signal generator powers motors, speakers, circuits, and many other devices. With PASCO Capstone software and the 550, you can control various DC and AC waveforms, without requiring any other technology. The 550 provides 8 V at 400 mA, selectable voltage limits, built-in voltage and current measurements, and DC offset. Capstone software turns the 550 into a live oscilloscope that can display simultaneous traces.

Beyond having USB 2.0 connectivity, the 550 can also send data wirelessly to any Bluetooth® enabled computer, iPad, or Android tablet using PASCO Capstone or SPARKvue software.

Features:

- USB and Bluetooth® connectivity
- 3.2 W power amplifier
- 2.0 MHz max sampling rate
- 100 kHz signal generator with built-in Voltage and Current sensors
- Compatible with PASPORT, ScienceWorkshop, and Wireless Sensors
- 2 high-speed analog inputs
- 2 digital inputs for photogates and other timing sensors
- 2 PASPORT sensor inputs
- Can be used simultaneously with other PASPORT interfaces
- Uses PASCO Capstone or SPARKvue Software



The 550 Universal Interface allows you to connect Science Workshop (analog), PASPORT (USB), and Wireless (Bluetooth®) sensors. It also includes a power amplifier and signal generator (not shown).

Order Information

SPARK LXi2 Datalogger.....PS-3600B

Order Information

550 Universal Interface.....UI-5001

Interface Comparison

Compare the features and capabilities to see which interface is best for your lab.

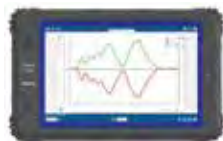

	SPARK LXi2 PS-3600B	AirLink PS-3200	SPARKlink Air PS-2011	550 Universal Interface UI-5001
PASPORT Ports	2	1	2	2
Analog Inputs	0	0	0	2 (± 10 V, optional gain voltage 10x, 100x)
Digital Inputs	5	0	0	2
Connects via USB	Yes	Yes	Yes	Yes
Connects via Bluetooth®	Yes	Yes	Yes	Yes
Rechargeable Battery (for cordless operation only)	Yes	Yes	Yes	No (AC adapter)
Works with PASCO Capstone Software	No	Yes	Yes	Yes
Works with SPARKvue Software	Yes	Yes	Yes	Yes
Accepts PASPORT Sensors	Yes	Yes	Yes	Yes
Accepts ScienceWorkshop Sensors	No*	No*	No*	Yes
Maximum Sampling Rate	Sensor dependent <100 kHz	Sensor dependent <1000 Hz	Sensor dependent <1000 Hz	Up to 2 MHz on one channel
Signal Generator	N/A	N/A	N/A	± 8 V, at 400 mA, DC to 100 kHz
Included Items	Ruggedized case, hands-free stand, SPARKvue, MatchGraph!, Spectrometry	USB Cable	AC adapter, USB cable, fast response temperature and voltage probe	USB cable, Power supply

* The AirLink and SPARKlink Air can accept most ScienceWorkshop sensors with the proper adapter, although they won't have the same high maximum sample rates. One exception is the Sound Sensor (UI-5101), which is not recommended for use with an adapter.

AirLink Interface

PS-3200

The AirLink connects PASPORT sensors to a Mac® or Windows® computer, Chromebook, iPad, tablet, or smartphone via Bluetooth® or USB connection. The USB cable is included.



SPARKlink Air Interface

PS-2011

The SPARKlink® Air allows students and teachers to connect any of our 70+ PASPORT sensors to their device via USB or Bluetooth®.



Order Information

AirLink InterfacePS-3200

Order Information

SPARKlink Air InterfacePS-2011

Make the switch to **PASCO** capstone™ 2

The Most Advanced Data Collection Software in Science Education

PASCO is pushing the limits of technology, so you can push your students to their potential. Working closely with educators, we continuously develop Capstone, making improvements and enhancing the teaching features. Capstone is designed to handle large data sets, high-speed sampling, and customized preferences to fit the needs of your lab. The straightforward user interface is approachable for beginners, yet Capstone offers all the capabilities needed for even the most advanced users.

Features in PASCO Capstone 2

Visit pasco.com/capstone for more information.

Circuits Emulation

Reinforce circuit concepts and tackle student misconceptions using circuit visualization.

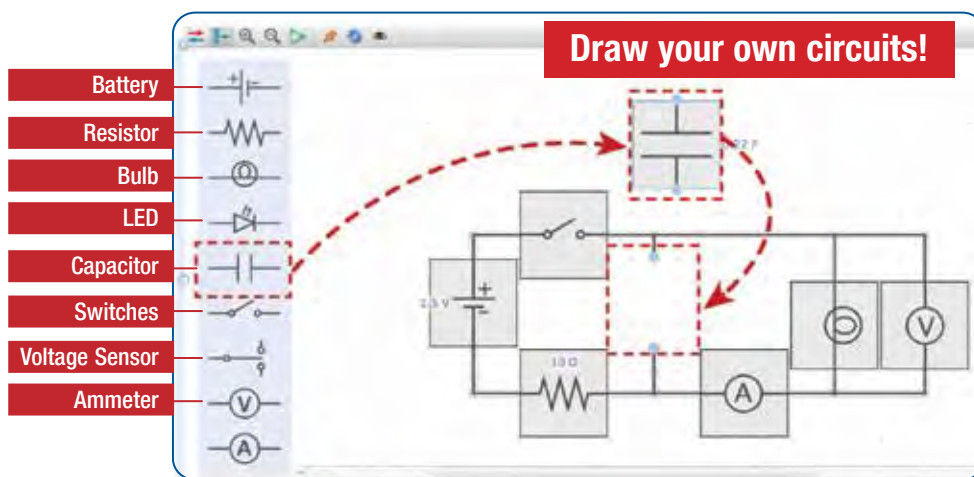

Combine real-world circuits with simulations, animations, and live measurements.

With this tool you can:

- Construct and modify circuits
- Show conventional current and electron flow animations
- Animate circuits with live sensor data
- Build your own circuits in Capstone, drag and drop components, and draw wires to connect them
- Demonstrate series and parallel
- Charge and discharge capacitors

Examples of other circuit emulations

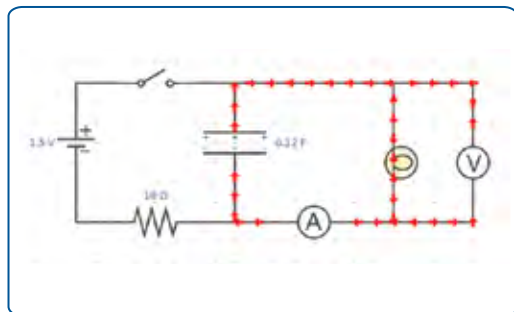

- Animate conventional current flow
- Animate a capacitor—charge or discharge
- Edit capacitor values

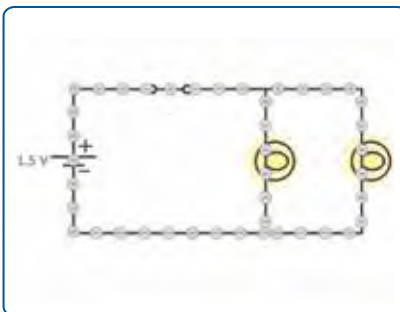

- Animate electron flow
- Connect components in parallel or series

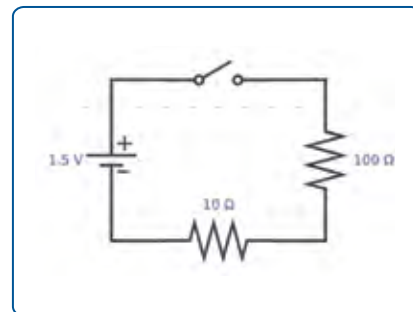

- Operate switches
- Edit voltage and resistor values

Blockly Block-based Coding

- Control all PASCO sensors and interfaces
- Create sense and control programs
- Control outputs from sensor inputs

Bring computational thinking into your science lab!

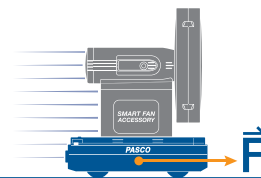

```

Write output voltage Smart Fan Accessory = 0
Sleep in ms 100
set k to -110
set b to 160
set Xo to 0.3
set N to 0
repeat 10000 times
do
change N by 1
set x to Read Measurement Position, Blue m
set v to Read Measurement Velocity, Blue m/s
set P to k * x - Xo - b * v
Write output voltage Smart Fan Accessory = P
Write numeric to UED power = P
Sleep in ms 20
if absolute v 0.1 > and N 100 <
do
set Xo to -1 * x - Xo
set N to 0
Write output voltage Smart Fan Accessory = 0
    
```

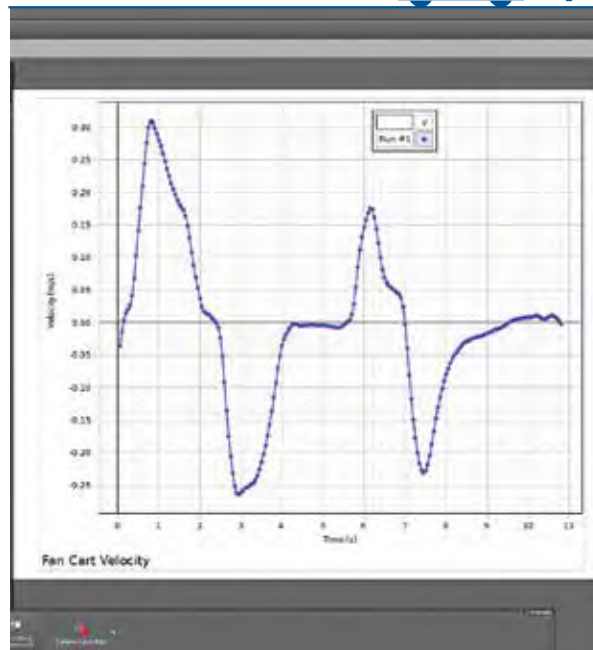

Graph Pop-up Tools

Quick access to commonly used analysis tools

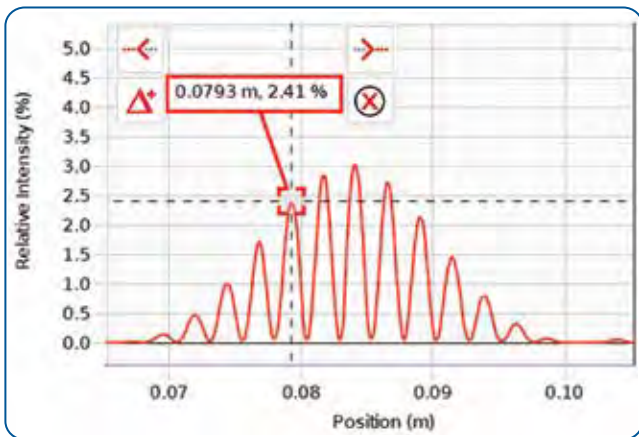

Visit pasco.com/capstone for more information.

Capstone has all the software tools you need for data collection and analysis. And we continue to add more features, based on input from physics educators just like you!

- Exclude or delete selected data points from analysis
- Create models using the calculator
- Calculated columns in tables
- Error bars
- Weighted linear fit that takes error bars into account
- More complex curve fits such as damped sine, Gaussian, sine series, and user-entered fits
- Smooth data directly on a graph with slider tool
- Global preferences settings

Order Information

PASCO Capstone
 Site License UI-5400 or UI-5400-DIG

Download the Free Trial
www.pasco.com/Capstone

Available for Mac®
 and Windows®



TOOLS



Configure PASCO Hardware

Works with PASPORT, ScienceWorkshop, and Wireless Sensors



Photogate Timer Wizard

Easily configure photogates and timing measurements



Data Summary

- Equations/calculations
- Fundamental constants
- Experimental constants
- Trials and runs



Sensor Calibration Wizard

- Step by step calibration
- Many calibration types



Signal Generator

- Scan through a range of frequencies
- Control signal output with a calculation



Calculator

- Graph modeling
- Create data sets using sensor data

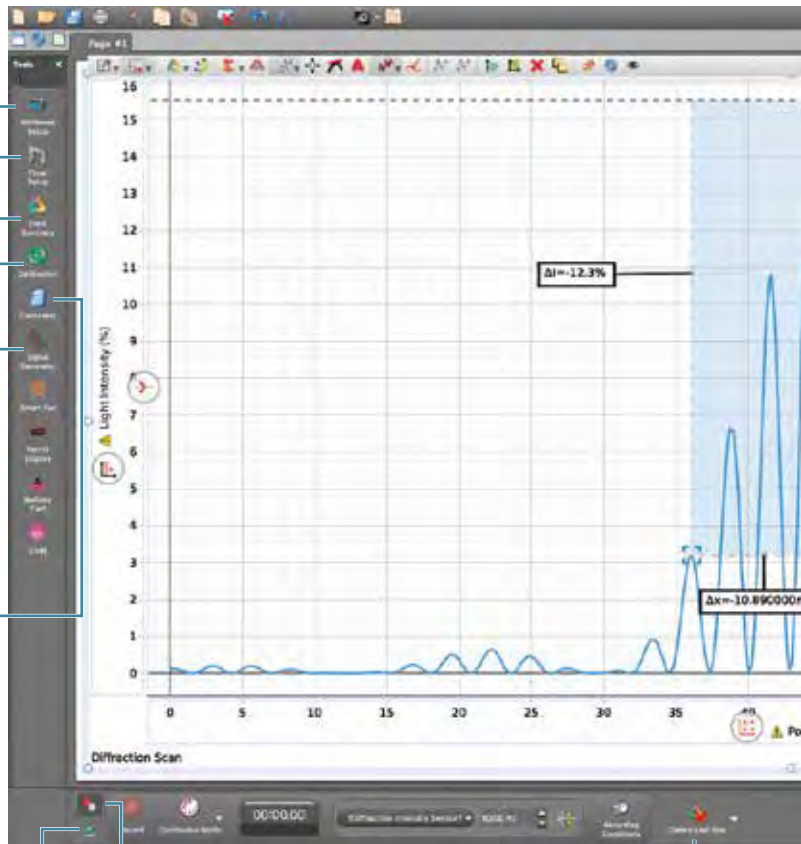

Replay Your Data

- Change replay rate
- Increment by frame
- Loop playback



Sampling Options

- Continuous manual sampling
- Fast monitor mode
- Independent sensor sampling rates
- Start/stop conditions
- Zero sensor

Capstone 2 Includes Video Analysis

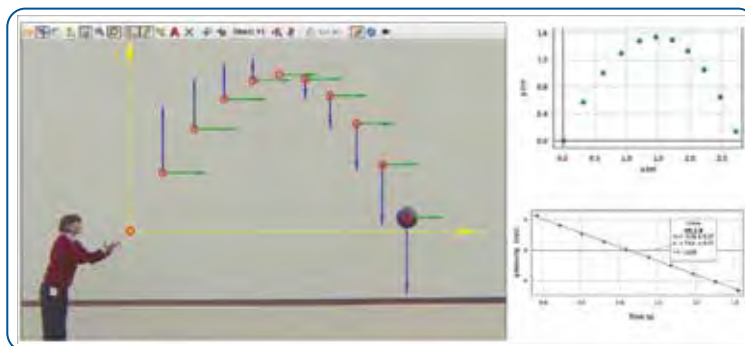

Sophisticated scientific calculator has statistics, calculus, filters, logic functions, and special operations such as amplitude and period.

Import video and analyze the motion of objects to measure position, velocity, and acceleration. With this tool you can also:

- Show velocity and acceleration vectors
- Use magnifier to identify exact center of an object
- Use calibration ruler at any time
- And so much more!

PASCO's proximity in-app sensor pairing:
U.S. Patent Number 10,356,594

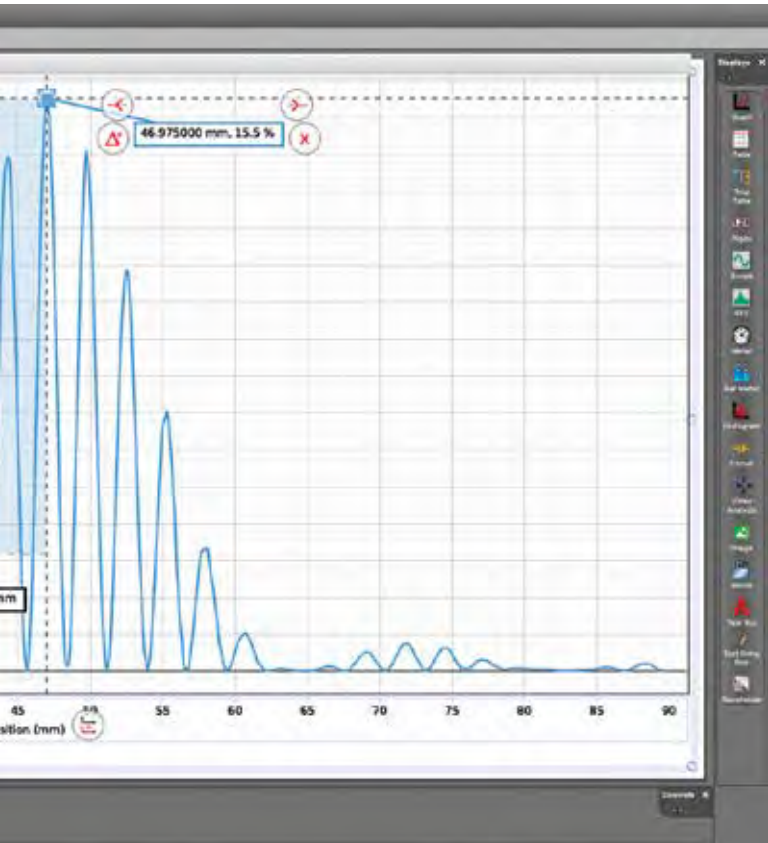

DISPLAYS

Display Your Data Your Way

- Graph
- Table
- Digits
- Scope
- FFT
- Meters

Graph Tools Include

- Draw predictions on graphs before taking data
- Multiple y-axes and/or multiple plot areas
- Perform Quick-Calcs on the graph axis to linearize data
- Curve-fits report the uncertainties in the parameters
- Multi-coordinate tool gives y-values wherever it intersects data

Error Bars and Weighted Linear Fits

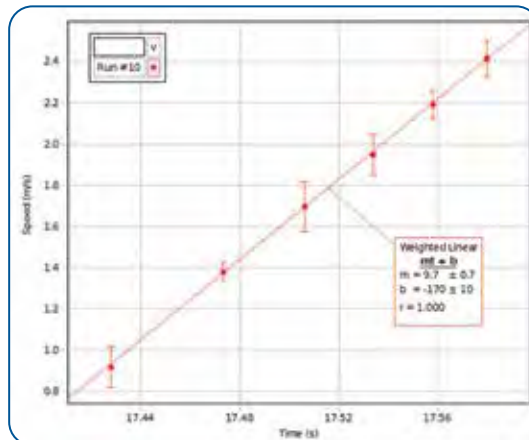

Graph uncertainties using user-entered error bars, absolute error, or percent error. The weighted linear fit incorporates the error bars.

Visit pasco.com/capstone for more information.



Delete Runs

- Last run only
- Select from list
- All runs

Made a mistake?



Just hit
UNDO

Oscilloscope Display

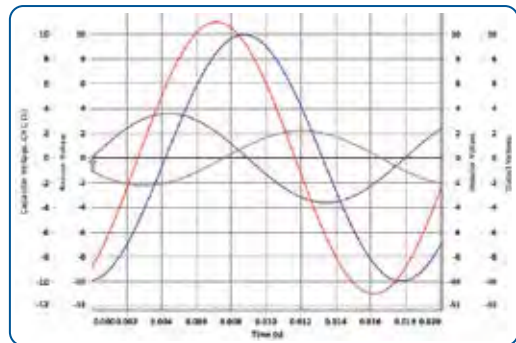

This display behaves like an authentic digital oscilloscope.

- Trigger
- Single trace collection
- Sample rate tied to time axis scale
- Set trace offset

FFT

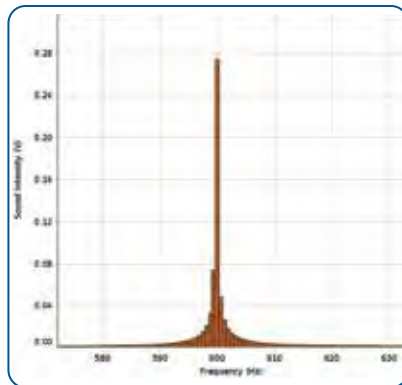

Display data in the frequency domain to find peak frequency and harmonics.

- Sample rate tied to axis scale
- Normalize data
- Adjust BIN width

Multi-Coordinate Tool

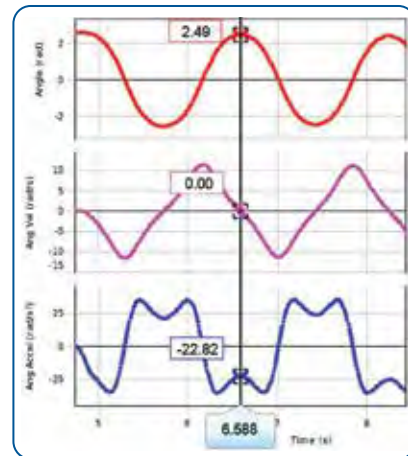

Easily show the relationship between multiple data plots by comparing data values across the time axis.

Sensor Index

WIRELESS SENSORS	Part Number	Page Number
Acceleration/Altimeter	PS-3223	114
Blood Pressure	PS-3218	114
CO ₂	PS-3208	115
//code.Node	PS-3231	115
Colorimeter & Turbidity	PS-3215	115
Conductivity	PS-3210	115
//control.Node	PS-3232	116
Current	PS-3212	116
Drop Counter	PS-3214	116
EKG	PS-3236	116
Exercise Heart Rate	PS-3207	116
Force Platforms 2D	PS-3229	116
Force Platform 1D	PS-3230	117
Force Acceleration	PS-3202	117
Geiger Counter	PS-3238	117
Greenhouse	PS-3322	117
Hand-Grip Heart Rate	PS-3206	118
Light & Color	PS-3213	118
Load Cell Accelerometer	PS-3216	118
Melting Point Apparatus	PS-3246	118
Magnetic Field 3-Axis	PS-3221	118
Motion	PS-3219	118
Optical Dissolved O ₂	PS-3224	119
O ₂ Gas	PS-3217	119
pH	PS-3204	119
Polarimeter	PS-3237	119
Pressure	PS-3203	119
Rotary Motion	PS-3220	120
Smart Gate	PS-3225	120
Smart Cart (red)	ME-1240	120
Smart Cart (blue)	ME-1241	120
Soil Moisture	PS-3228	121
Sound	PS-3227	121
Spectrometer	PS-2600	121
Spirometer	PS-2600	121
Temperature	PS-3222	121
Temperature Link	PS-3201	121
Voltage	PS-3211	122
Weather with GPS	PS-3209	122

Classroom Sensor Multi-Packs

The Wireless Sensor Packs contain 8 Wireless Sensors inside a Grattells storage tray. Also inside the tray is a custom insert designed to securely fit each sensor. The trays provide a convenient and well-ordered storage solution for any classroom, while also making transportation between classrooms effortless.



Look for this symbol on sensors available in multi-packs

Wireless Acceleration/Altimeter

PS-3223

Specifications:

Low-g Accelerometer:

Range: ±16 g

Resolution: 0.002 g at 20 Hz

Accuracy: ±0.04 g

Maximum Sample Rate: 5 kHz

High-g Accelerometer:

Ranges: ±100 g, ±200 g, ±400 g

Resolution: 0.04 g (@ ±100 g) at 20 Hz

Accuracy: ±1 g (@ ±100 g)

Maximum Sample Rate: 5 kHz

Altimeter:

Range: -1.8 km to 9.5 km

Resolution: 10 cm

Maximum Sample Rate: 200 Hz

Gyroscope:

Range: ±34.9 rad/s

Accuracy: ±0.02 rad/s

Maximum Sample Rate: 1 kHz

Connectivity: Bluetooth 5.2

Logging: Yes

Battery Type: Coin Cell



Order Information

Wireless Acceleration/Altimeter.....PS-3223

Wireless Blood Pressure Sensor - Standard Cuff

PS-3218

Specifications:

Heart Rate

Range: 36 to 200 bpm

Resolution: 1 bpm

Accuracy: ±1 bpm

Blood Pressure

Range: 0 to 260 mmHg

Resolution: 0.05 mmHg

Accuracy: ±3 mmHg

Gauge Pressure

Range: 0 to 260 mmHg

Resolution: 0.05 mmHg

Accuracy: ±3 mmHg

Connectivity: USB and Bluetooth 5.2

Logging: No

Battery Type: Rechargeable LiPo



Order Information

Wireless Blood Pressure Sensor with Standard Cuff..... PS-3218

Wireless CO₂ Sensor (Carbon Dioxide)

PS-3208

Specifications:

Range: 0 to 100,000 ppm

Resolution: 2 ppm

Accuracy: 1,000 – 10,000 ppm Range: ±5% of reading + 100ppm, 10,000 – 50,000 ppm Range: ±10% of reading, 50,000 – 100,000 ppm Range: ±15% of reading

Warm-up Time: 3 min

Response Time: 90% in 30 sec

Operating Temperature Range: -10°C–50°C (5°C to 30°C ideal for LiPo charging)

Metabolism Bottle Volume: 250 mL

Metabolism Bottle Care: Warm soapy water (not boiling)

Connectivity: USB and Bluetooth 5.2

Logging: Yes

Battery Type: Rechargeable LiPo



Wireless Colorimeter & Turbidity Sensor

PS-3215

Specifications:

Color Detection/Peak Wavelengths: 650 nm (red), 600 nm (orange), 570 nm (yellow), 550 nm (green), 500 nm (blue), 450 nm (violet)

Detection Wavelength Range: ±25 nm from peak

Absorbance: 0–3 Abs units; useful range (0.05–1.5 Abs)

Transmittance: 0-100%

Turbidity Illumination Wavelength: 850 nm

Turbidity Range: 0-400 NTU

Accuracy: ±5% NTU

Connectivity: USB and Bluetooth 5.2

Logging: Yes

Battery Type: Rechargeable LiPo

Order Information

Wireless Colorimeter & Turbidity SensorPS-3215

//code.Node

PS-3231

Specifications:

Light Level Sensor Range: 600 lx to 50,000 lx (not calibrated)

Sound Level Sensor Range: 70 to 100 dB (not calibrated)

Magnetic Field Sensor Range: ±50 gauss

Acceleration Sensor Range: ±8 g

Ambient Temperature

Range: -25°C to 40°C

Resolution: 0.05°C

Accuracy: ±1°C

Speaker Frequency Range:

10 Hz to 10,000 Hz

Maximum Sample Rate: 100 Hz

Connectivity: USB and Bluetooth 5.2

Logging: No

Battery Type: Rechargeable LiPo



Wireless Conductivity Sensor

PS-3210A

Specifications:

Range: 0 to 40,000 µS/cm (0 to 28,000 mg/L TDS)

Resolution: 0.1 µS/cm

Accuracy (200 - 40,000): ±5% of value

Accuracy (below 200): ±25 %

Total Dissolved Solids:

Range: 0 to 30,000 ppm

Resolution: 0.1 ppm

Accuracy: 10% between 100–30,000 ppm

Response Time: 95% of in 5 seconds

Environmental Tolerance: 0 to 80°C

Temperature Compensation: 0 to 35°C

Temperature Accuracy: ±0.5°C

Waterproof: IPX7 rated (1 meter for 30 min)

Connectivity: Bluetooth 5.2

Logging: Yes

Battery Type: Coin Cell



Order Information

Wireless Conductivity SensorPS-3210A

Order Information

//code.NodePS-3231

//control.Node

PS-3232

Specifications:

Power Output Ports:

±5 VDC, 0.7 A

Auto-ID stepper motors and Power Output Module

8-pin modular jack

Product Servo Ports: Accepts standard servos and continuous rotation servos, 3-pin connector, Built-in servo current sensor for detecting load, and I2C

Sensor Port: 6-pin modular jack

Acceleration Sensor: ±16g, 3-axis

Speaker Frequency Range: 10 Hz to 10,000 Hz

Connectivity: USB and Bluetooth 5.2

Logging: No

Battery Type: Rechargeable LiPo

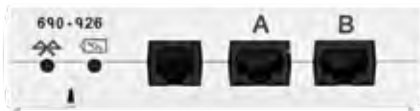

Wireless EKG Sensor

PS-3236

Specifications:

Voltage Range: 0 to 4.5 mV

Voltage Resolution: 5 μ V

Default Sample Rate: 250 Hz

Maximum Sample Rate: 1000 Hz

Heart Rate Range: 40 to 250 bpm

Accuracy: ±1 bpm

Connectivity: USB and Bluetooth 5.2

Battery Type: Rechargeable LiPo

Logging: Yes



Order Information

Wireless EKG Sensor.....PS-3236

Wireless Exercise Heart Rate Sensor

PS-3207

Specifications:

Approximate mass, strap and connector: 40 grams

Sensor Range: 0 to 240 beats per minute

Accuracy: ±1 beat per minute

Resolution: 1 bpm

Maximum Sample Rate: Every two seconds

Default Sample Rate: Every five seconds

Connectivity: USB and Bluetooth 5.2

Logging: No

Battery: Coin Cell



Order Information

Wireless Exercise Heart Rate Sensor.....PS-3207

Wireless Current Sensor

PS-3212

Specifications:

High Current:

Range: ±1 A

Resolution: 0.2 mA

Low Current:

Range: ±0.1 A

Resolution: 0.02mA

Input Resistance: 0.1 Ω

Maximum Sample Rate: 100 kHz

Connectivity: USB or Bluetooth 5.2

Logging: Yes

Battery Type: Rechargeable LiPo



Wireless 2-Axis Force Platform

PS-3230

Specifications:

Force Range: -1320 N to 5280 N (resultant)

Parallel Force Range: ±1,300 N

Resolution: 0.2 N

Maximum Sample Rate: 10 kHz

Force Over-Limit Protection: -500 N to 2000 N per vertical beam; ±2,000 N parallel beam

Dimensions: 35 x 35 x 7.1 cm

Connectivity: USB and Bluetooth 5.2

Logging: No

Battery Type:
Rechargeable LiPo



Wireless Drop Counter

PS-3214

Specifications:

Range: 0 to 40 drops/second

Accuracy: ±1 drop

Resolution: 1 drop

Optical Window: Acrylic

Connectivity: USB and Bluetooth 5.2

Logging: No

Battery Type: Rechargeable LiPo



Order Information

Wireless 2-Axis Force Platform.....PS-3230

Order Information

Wireless Drop Counter.....PS-3214

Wireless Force Platform

PS-3229

Specifications:

- Range:** -1320 to 5280 N (resultant)
- Resolution:** 0.2 N
- Maximum Sample Rate:** 10 kHz
- Surface Dimensions:** 35 x 35 cm
- Force Over-Limit Protection:** -500 to 2000 N per beam
- Connectivity:** USB and Bluetooth 5.2
- Logging:** No
- Battery Type:** Rechargeable LiPo



Order Information

Wireless Force PlatformPS-3229

Wireless Force Acceleration Sensor

PS-3202

Specifications:

- Force Sensor:**
- Range:** ± 50 N
- Resolution:** 0.03 N
- Accuracy:** 0.1 N
- Maximum Sample Rate:** 1000 Hz
- Accelerometer:**
- Range:** ± 16 g
- Accuracy:** ± 0.2 m/s² (at 9.8 m/s²)
- Maximum Sample Rate:** 500 Hz
- Gyro Sensor:**
- Range:** ± 2000 °/s
- Maximum Sample Rate:** 500 Hz
- Connectivity:** USB and Bluetooth 5.2
- Logging:** Yes
- Battery Type:** Rechargeable LiPo



Order Information

Wireless Force Acceleration Sensor PS-3202

Wireless Geiger Counter

PS-3238

Specifications:

- Sensitivity:** Alpha, Beta, Gamma
- Count Detection:** Switchable audio signal
- Gas Filling:** Ne +Halogen
- Effective Tube Diameter:** 9.1 mm
- Window Thickness:** 1.5 to 2.0 mg/cm²
- High Voltage Control Range:** 150 VDC to 650 VDC
- Standard Operating Voltage:** 500 VDC
- Connectivity:** USB and Bluetooth 5.2
- Logging:** Yes
- Battery:** Rechargeable LiPo



Order Information

Wireless Geiger Counter.....PS-3238

Greenhouse Sensor

PS-3322

Specifications:

- Operating Temperature:** -40°C to 80°C
- Light Level Sensor:**
- Wavelength Range:** Visible Spectrum (400 nm to 700 nm)
- Sensitivity Range:** Approximately 600 lx to 50,000 lx (not calibrated)
- Resolution:** 0.1%
- Accuracy:** 5%
- Report out:** 0 to 100% of max reading
- Ambient Temperature:**
- Range:** -40°C to 80°C
- Resolution:** 0.01°C
- Accuracy:** ± 0.5 °C
- Humidity Sensor:**
- Range:** 0 to 95% non condensing
- Resolution:** ± 0.02 %
- Accuracy:** ± 3 %
- Temp, Light, Humidity Sensors:**
- Power Use:** 0.98 mA at 3.3 V DC
- Soil Moisture Sensor:**
- Range:** 0 to 45%
- Resolution:** 0.1%
- Accuracy:** ± 5 %
- Probe Cable Length:** 2 m
- Connectivity:** USB and Bluetooth 5.2
- Logging:** No
- Battery Type:** Coin Cell



Order Information

Greenhouse Sensor.....PS-3322

Wireless Hand-Grip Heart Rate Sensor

PS-3206

Specifications:

Range: 0 to 240 bpm

Resolution: 1 beat

Accuracy: ± 1 bpm

Maximum Sample Rate: Every two seconds

Default Sample Rate: Every five seconds

Connectivity: Bluetooth 5.2

Logging: No

Battery: Coin Cell



Order Information

Wireless Hand-Grip Heart Rate SensorPS-3206

Wireless Light & Color Sensor

PS-3248



Specifications:

Spectral Response: 340 nm to 1150 nm

Illuminance Range: 0 to 131,000 lux

Irradiance Range: 0 to 1362 W/m²

PAR Range: 0 to 2400 $\mu\text{mol}/\text{m}^2/\text{s}$

UV Index Range: 0 to 12 (typical in daylight)

RGB Range: 0 to 100% of clear LED response

Maximum Sample Rate: 2 Hz (ambient); 20 Hz (spot)

Connectivity: USB and Bluetooth 5.2

Logging: Yes

Battery Type: Coin Cell



Order Information

Wireless Light and Color SensorPS-3248

Wireless Load Cell and Accelerometer

PS-3216

Specifications:

Force Sensor:

Range: ± 50 N

Resolution: 0.03 N

Accuracy: ± 0.1 N

Maximum Sample Rate: 2 kHz

Accelerometer:

Range: ± 16 g (three-axis)

Maximum Sample Rate: 500 Hz

Connectivity: USB and Bluetooth 5.2

Logging: Yes

Battery Type: Rechargeable LiPo



Order Information

Wireless Load Cell and AccelerometerPS-3216

Wireless Magnetic Field Sensor

PS-3221

Specifications:

High Magnetic Field:

Range: ± 1300 G

Resolution: ± 1 G

Low Magnetic Field:

Range: ± 50 G

Resolution: ± 0.01 G

Maximum Sample Rate: 100 Hz

Connectivity: USB and Bluetooth 5.2

Logging: Yes

Battery Type: Rechargeable LiPo



Order Information

Wireless Magnetic Field SensorPS-3221

Melting Point Apparatus

PS-3239



Specifications:

Temperature:

Range: 0 to 380 °C

Accuracy: 1.0 °C out of box, 0.1 °C if calibrated

Maximum Sample Rate: 1 Hz

Viewing Lens: 3x

Connectivity: Bluetooth 5.2 (for temperature data)

Camera (sold separately) Connectivity: USB

Logging: No

Battery: No



Order Information

Melting Point ApparatusPS-3239

Wireless Motion Sensor

PS-3219

Specifications:

Range: 0.15 to 4 m

Resolution: 1 mm

Maximum Sample Rate: 250 Hz

Transducer Rotation Range: 180°

Connectivity: USB and Bluetooth 5.2

Logging: No

Battery Type: Rechargeable LiPo



Order Information

Wireless Motion SensorPS-3219

Wireless Optical Dissolved Oxygen Sensor

PS-3246

Specifications:

Range: 0 to 20 mg/L, 0 to 300% saturation

Resolution: 0.01 mg/L

Accuracy (with calibration): ±0.2 mg/L or 1% (whichever is greater)

Accuracy (out of the box): ±0.5 mg/L or 3% (whichever is greater)

Response Time: 90% in 20 sec

Measurements: Concentration (mg/L), Saturation (%), O₂ Gas (in air, qualitative) (%), Temperature (°C)

Waterproof Depth (probe): 2.5 m

Cable Length: 3.0 m

Connectivity: USB and Bluetooth 5.2

Logging: Yes

Battery Type: Rechargeable LiPo

NEW



Order Information

Wireless Optical Dissolved Oxygen Sensor (NEW!)PS-3246

Wireless Oxygen Gas Sensor

PS-3217

Specifications:

Range: 0–100% O₂ concentration; 0–1,000,000 ppm

Resolution: 0.01% oxygen

Accuracy: ±1% O₂ at constant temperature and pressure; ±5% O₂ outside operating range

Operating Temperature Range: 0–40°C

Relative Humidity Range: 0–100% (non-condensing)

Sensing Element Lifespan: 2+ years

Pressure Range: 0.7 - 1.3 atm

Connectivity: USB and Bluetooth 5.2

Logging: Yes

Battery Type: Rechargeable LiPo



Order Information

Wireless Oxygen Gas Sensor.....PS-3217

Wireless pH Sensor

PS-3204

Specifications:

Range: 0-14 pH

Resolution: 0.02 pH

Accuracy: ±0.1 pH with calibration

Temperature Range: 5°C to 60°C

Connectivity: USB and Bluetooth 5.2

Logging: Yes

Battery Type: Coin Cell



Order Information

Wireless pH Sensor.....PS-3204

Wireless Polarimeter

PS-3237

Specifications:

Optical Rotation Accuracy: ±0.09°

Cell Length (horizontal): 101 mm ± 0.6 mm

Connectivity: USB and Bluetooth 5.2

Logging: No

Battery Type: Rechargeable LiPo



Order Information

Wireless PolarimeterPS-3237

Wireless Pressure Sensor

PS-3203

Specifications:

Range: 0-400 kPa

Resolution: 0.1 kPa

Accuracy: ±2 kPa

Max Sample Rate: 1000 Hz

Connectivity: USB and Bluetooth 5.2

Logging: Yes

Battery Type: Rechargeable LiPo

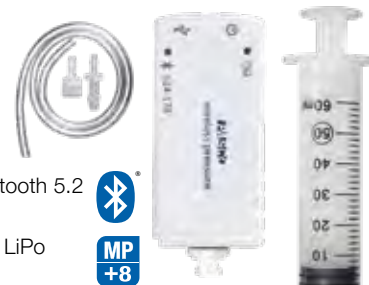

Order Information

Wireless Pressure SensorPS-3203

Wireless Rotary Motion Sensor

PS-3220

Specifications:

- Angular Resolution:** 0.18° (0.00314 radian)
- Linear Resolution:** 0.0157 mm (with 10 nm pulley radius)
- Three-Step Pulley:** 10, 29, and 48 mm diameter
- Shaft Diameter:** 6.35 mm
- Maximum Rotation Rate:** 30 revolutions per second
- Optical Encoder:** 2000 divisions/rev, bidirectional
- Connectivity:** USB or Bluetooth 5.2
- Logging:** Yes
- Battery Type:** Rechargeable LiPo



Order Information

Wireless Rotary Motion SensorPS-3220

Wireless Smart Gate

PS-3225

Specifications:

- Gate Separation:** 1.5 cm
- Timing Resolution:** 3 ms
- Minimum Block Time:** 1.5 ms
- Beam Wavelength:** 940 nm
- Gate Inside Width:** 7.2 cm
- Connectivity:** USB and Bluetooth 5.2
- Logging:** No
- Battery Type:** Rechargeable LiPo



Order Information

Wireless Smart GatePS-3225

Smart Cart Charging Garage

ME-1243

Charge up to five Smart Carts at once. Provides storage for the carts and accessory bumpers. Includes power adapter.



Order Information

Smart Cart Charging GarageME-1243

Smart Cart (Red)

ME-1240

Specifications:

- Optical Encoder:**
- Range:** ±3.0 m/s
- Resolution:** ±0.2 mm
- Maximum Sample Rate:** 500 Hz
- Accelerometer:** Range: ±16 g
- Accuracy:** ± 0.2 m/s² at 9.8 m/s²
- Maximum Sample Rate:** 500 Hz
- Force Sensor:**
- Range:** ±100 N
- Resolution:** 0.1 N
- Accuracy:** ±1.0%
- Maximum Sample Rate:** 2 kHz
- Gyro Sensor:**
- Range:** ±245 %/s
- Maximum Sample Rate:** 500 Hz
- Patent No.:** 10481173
- Connectivity:** USB and Bluetooth 5.2
- Logging:** No
- Battery Type:** Rechargeable LiPo



Order Information

Smart Cart (Red)ME-1240

Smart Cart (Blue)

ME-1241

Specifications:

- Optical Encoder:**
- Range:** ±3.0 m/s
- Resolution:** ±0.2 mm
- Maximum Sample Rate:** 500 Hz
- Accelerometer:** Range: ±16 g
- Accuracy:** ± 0.2 m/s² at 9.8 m/s²
- Maximum Sample Rate:** 500 Hz
- Force Sensor:**
- Range:** ±100 N
- Resolution:** 0.1 N
- Accuracy:** ±1.0%
- Maximum Sample Rate:** 2 kHz
- Gyro Sensor:**
- Range:** ±245 %/s
- Maximum Sample Rate:** 500 Hz
- Patent No.:** 10481173
- Connectivity:** USB and Bluetooth 5.2
- Logging:** No
- Battery Type:** Rechargeable LiPo



Order Information

Smart Cart (Blue)ME-1241

Wireless Soil Moisture Sensor

PS-3228

Specifications:

- Range:** 0 to 45% water by volume
- Accuracy:** ±5% water by volume
- Resolution:** 0.1%
- Power:** 3 mA at 5 VDC
- Operating Temperatures:** -40 to 60°C
- Probe Cable Length:** 2 m
- Connectivity:** USB and Bluetooth 5.2
- Logging:** Yes
- Battery Type:** Rechargeable LiPo



Order Information

Wireless Soil Moisture SensorPS-3228

Wireless Sound Sensor

PS-3227

Specifications:

- Microphone Frequency Range:** 100 to 20,000 Hz
- Sound Wave Maximum Sample Rate:** 100 kHz
- Sound Level Range:** 50 to 110 dB
- Accuracy:** ±2 dB
- Response:** A or C weighted
- Connectivity:** USB and Bluetooth 5.2
- Logging:** Yes
- Battery Type:** Rechargeable LiPo



Order Information

Wireless Sound SensorPS-3227

Wireless Spectrometer (VIS)

PS-2600

Specifications:

- Resolution:** 2nm to 3nm FWHM
- Detection Range:** 380–950 nm
- Fluorescence Excitation Wavelengths:** 405 nm and 500 nm
- Light Source:** LED-boosted tungsten
- Connectivity:** USB and Bluetooth 5.2
- Logging:** No
- Battery Type:** Rechargeable LiPo



Order Information

Wireless Spectrometer (Vis)PS-2600A

Wireless Spirometer

PS-3234

Specifications:

- Maximum Sample Rate:** 1 kHz
- Maximum Flow Rate:** ±14 L/s
- Flow Resolution:** 0.01 L/s
- Per Breath Volume:** 10 L
- Volume Resolution:** 0.04 L
- Prefilter Material:** Low flow resistance microbial filter
- Standard of cross contamination:** Exceeds all ATS/ERS
- Cross contamination efficiency:** 99.999%
- Prefilter meets ATS standards for air resistance:** 0.845 mbar/L/Sec at 14/L/Sec
- Mouth piece resistance:** 0.2 mbar /L/Sec at 12 l/s
- Prefilter dead space:** 69 ml
- Mouth piece dead space:** 31 ml
- Connectivity:** USB and Bluetooth 5.2
- Logging:** Yes
- Battery Type:** Rechargeable LiPo



Order Information

Wireless SpirometerPS-3234

Wireless Temperature Sensor

PS-3201

Specifications:

- Range:** -40 to 125°C
- Resolution:** 0.01°C
- Accuracy:** 0.5°C
- Maximum Sample Rate:** 10 Hz
- Connectivity:** Bluetooth 5.2
- Logging:** Yes
- Battery:** Coin Cell



Order Information

Wireless Temperature SensorPS-3201

Wireless Temperature Sensor Link

PS-3222

Specifications:

- Battery life:** >1 year
- Compatible Temperature Probes:** Skin/Surface (PS-2131); Fast Response (PS-2135); Stainless Steel (PS-2153)
- Range with included probe:** -35 to 135°C
- Resolution:** ±0.05°C
- Maximum Sample Rate:** 20 Hz
- Connectivity:** Bluetooth 5.2
- Jack:** 3.5 mm stereo
- Accuracy:** ±0.5°C
- Logging:** Yes
- Battery Type:** Coin Cell



Order Information

Wireless Temperature Sensor LinkPS-3222

Wireless Voltage Sensor

PS-3211

Specifications:

Low Voltage:

Range: ± 5 V
Resolution: 2 mV

High Voltage:

Range: ± 15 V
Resolution: 7 mV

Accuracy: $\pm 1.0\%$

Maximum Sample Rate: 100 kHz

Input Resistance: 1 M Ω

Connectivity: USB and Bluetooth 5.2

Logging: Yes

Battery Type: Rechargeable LiPo



Altitude (via GPS):

Range: 0 to 18,000 m
Resolution: 0.5 m
Accuracy: ~ 5 m (50% CEP)

Speed (via GPS):

Range: 0 to 515 m/s
Resolution: 0.05 m/s
Accuracy: 0.05 m/s

Operating Environment (Temperature): -20 to 150°C

Operating Environment (Max Wind Speed): 65 mph

GPS Channels: 66

GPS Warm Up Time: 35 seconds or less

Connectivity: USB and Bluetooth 5.2

Logging: Yes

Battery Type: Rechargeable LiPo

Order Information

Wireless Voltage SensorPS-3211

Wireless Weather Sensor with GPS

PS-3209

Specifications:

Water-resistant: Splash proof and designed to withstand the elements

Barometric Pressure:

Range: 225 to 825 mmHg
Resolution: 0.02 mmHg
Accuracy: ± 0.1 mmHg

Ambient Temperature:

Range: -40 to 125°C
Resolution: 0.1°C
Accuracy: $\pm 0.2^{\circ}\text{C}$

Wind Speed:

Range: 0.5 to 15 m/s (winds up to ~ 33 mph)
Resolution: 0.1 m/s
Accuracy: 3% of reading

Relative Humidity:

Range: 0 - 100%
Resolution: 0.1%

Illuminance Range (Light Level): 0 to 130,000 lux

PAR Range (Based on Solar Radiance): 0 to 2400 $\mu\text{mol}/\text{m}^2/\text{s}$

Irradiance Range (Based on Solar Radiance): 0 to 1362 W/m^2

UV Index:

Range: 1 to 12
Resolution: 1
Accuracy: ± 1

Position (via GPS):

Range: ± 90 Lat, ± 180 Lon
Resolution: 0.00001°
Accuracy: $\pm 0.00005^{\circ}$ $\sim 3\text{m}$ (50% CEP)



Tripod and weather vane sold separately

Order Information

Wireless Weather Sensor with GPSPS-3209

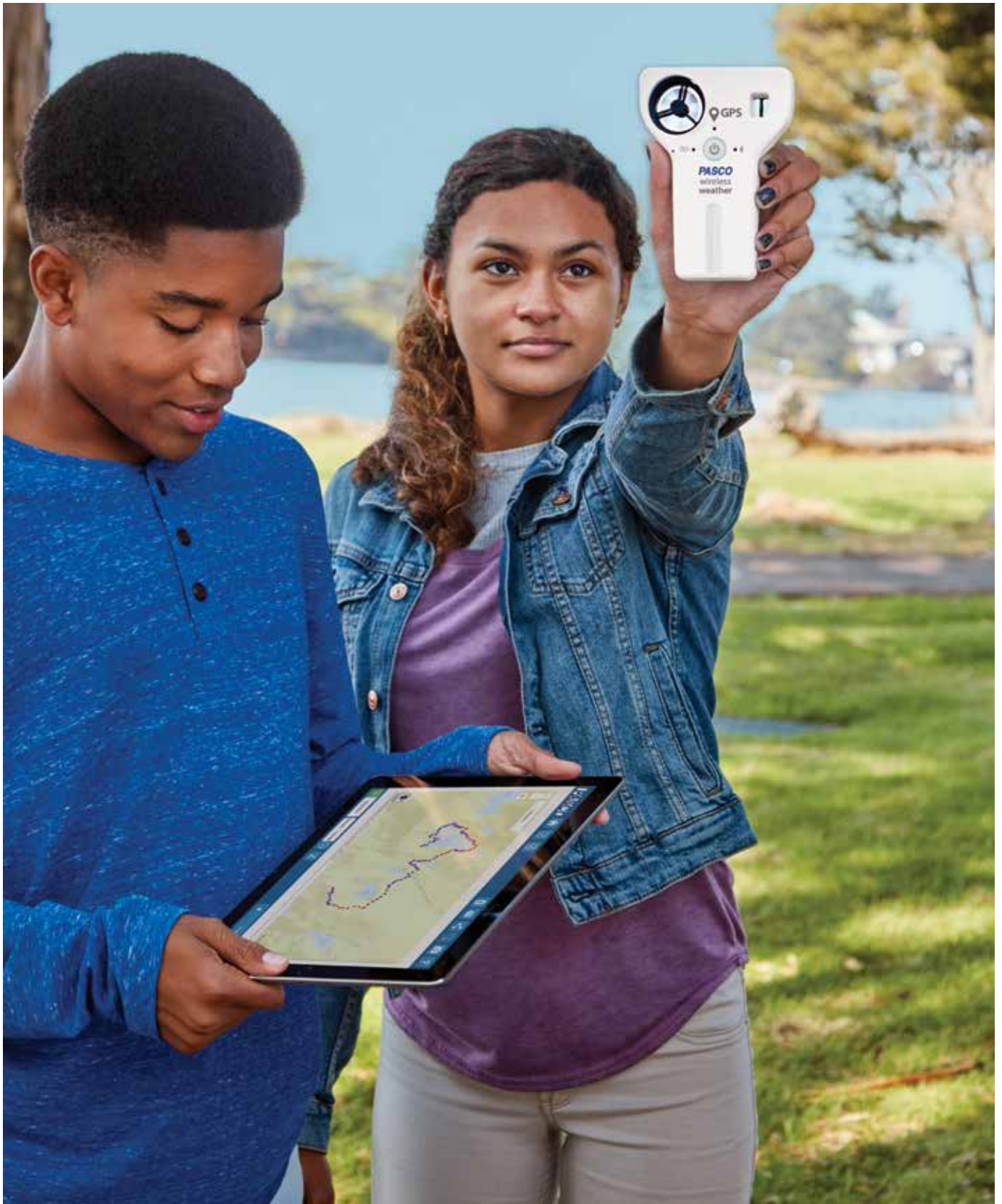

PASPORT Sensor Guide

For product details, including availability and compatibility with other PASCO products, please visit pasco.com/products/sensors/pasport



PASPORT Breath Rate Sensor
PS-2187



PASPORT Charge Sensor
PS-2132



PASPORT Displacement Sensor
PS-2204



PASPORT EKG Sensor
PS-2111



PASPORT Ethanol Sensor
PS-2194



**PASPORT Flow Rate/
Temperature Sensor**
PS-2130



PASPORT Force Sensor
PS-2104



**PASPORT High Resolution
Force Sensor**
PS-2189



PASPORT Force Platform
PS-2141



PASPORT 2-Axis Force Platform
PS-2142



PASPORT Galvanometer
PS-2160

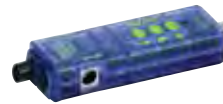

**PASPORT General Science
Sensor**
PS-2168



PASPORT Goniometer Sensor
PS-2137



**PASPORT Broad Spectrum Light
Sensor**
PS-2150



**PASPORT High Sensitivity Light
Sensor**
PS-2176



PASPORT Infrared Light Sensor
PS-2148



**PASPORT Load Cell and Dual
Amplifier Set**
PS-2206



**PASPORT 2-Axis Magnetic
Field Sensor**
PS-2162



PASPORT Motion Sensor

PS-2103A



PASPORT Rotary Motion Sensor

PS-2120A



Smart Gate

PS-2180



PASPORT Salinity Sensor

PS-2195



PASPORT Soil Moisture Sensor

PS-2163



PASPORT Spirometer

PS-2152



PASPORT Fast Response Temperature Probe (3 Pack)

PS-2135



PASPORT Skin/Surface Temperature Probe

PS-2131

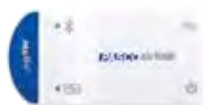

AirLink Interface 

PS-3200

The AirLink Interface connects PASPORT sensors to a computer, tablet or smartphone via Bluetooth or USB connection.



PASPORT Stainless Steel Temperature Probe

PS-2153



PASPORT Non-Contact Temperature Sensor

PS-2197



PASPORT Thermocline Sensor

PS-2151



PASPORT Dual Pressure Sensor

PS-2181



PASPORT Water Quality Colorimeter

PS-2179



PASPORT Analog Adapter

PS-2158



PASPORT Digital Adapter

PS-2159



Gratnells® Rolling Carts - Convenient Mobile Storage

EP-3574 (2-column) EP-3575 (3-column)



Gratnells® Rolling Cart (2- or 3-column)

EP-3574 / EP-3575

Gratnells Rolling Carts are the best way to store and transport PASCO sensors and equipment. They can be configured for trays of any size and include large castors with brakes for added stability.

Designed for Gratnells trays, these movable storage rack carts can store up to 8 (2-column) or 12 (3-column) Gratnells F2 trays (sold separately). Each cart comes with either 16 or 24 pairs of runners.

They can be used to store the equipment kits from the Essential Physics or Essential Chemistry curriculum, the storage trays we offer for wireless sensors, or any of the four sizes of empty trays that we offer for everything else you'd like to store.

Assembly is required. Trays not included.



Stores up to
12 Gratnells
F2 trays

Dimensions:
107 cm high,
102 cm wide,
43.5 cm deep



Stores up to
8 Gratnells
F2 trays

Dimensions:
107 cm high,
70 cm wide,
43.5 cm deep



Order Information

Gratnells Rolling Cart (2-column)EP-3574
Gratnells Rolling Cart (3-column)EP-3575

Wireless Sensor Storage Trays with Lids

Each F1 storage tray (below) holds up to ten sensors; sensors sold separately.



**Temperature/pH/
Conductivity Sensors**
PS-3585



Pressure Sensors
PS-3586



**Colorimeter & Turbidity
Sensors**
PS-3587



**Voltage & Current
Sensors**
PS-3588



Motion Sensors
PS-3589



**AirLink & Light
Sensors**
PS-3594



**Force
Acceleration
Sensors**
PS-3595



**Weather Sensor
with GPS**
PS-3596



CO₂ Sensor
PS-3598

Order Information

Storage for Wireless Temp, pH and Conductivity Sensors...PS-3585
Storage Tray for Wireless Pressure Sensors.....PS-3586
Wireless Colorimeter and Turbidity SensorPS-3587
Storage Tray for Wireless Voltage & Current Sensor.....PS-3588
Storage Tray for Wireless Motion SensorPS-3589

Order Information

Storage Tray for Wireless Light Sensor and AirLink.....PS-3594
Storage Tray for Wireless Force SensorPS-3595
Wireless Weather Sensor Storage TrayPS-3596
Wireless CO₂ Sensor Storage Tray.....PS-3598

Gratnells® Storage Trays with Lids

These empty Gratnells storage trays with lids have a length of 427 mm and width of 312 mm. The depth of each follows:

F1: 75 mm **F25:** 225 mm

F2: 150 mm **F3:** 300 mm

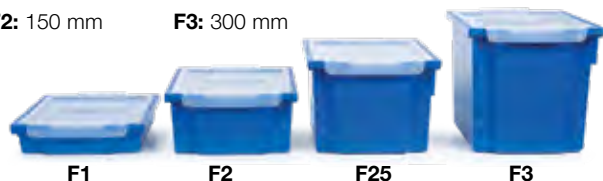

Order Information

Storage Tray (F1) ShallowPS-3326
Storage Tray (F2) DeepPS-3327
Storage Tray (F25) X-DeepPS-3328
Storage Tray (F3) JumboPS-3329

Storage Bins

SE-7560

These stackable plastic bins with lids can be useful for storing equipment and accessories in your lab.

14" L x 9.5" W x 6.9" D



Order Information

Storage Bins (Set of 5)SE-7560

Wireless Sensor Charging Station

This versatile charging station can be configured to fit any size sensor by adding or removing partitions.



Order Information

Wireless Sensor Charging StationPS-3599

2-Axis Magnetic Field Sensor	125
2-Axis Wireless Force Platform	107, 116
3-Axis Acceleration/Altimeter, Wireless	103, 114
3-Axis Magnetic Field Sensor, Wireless	75, 103, 118
5-Year Warranty	138
550 Universal Interface	108-109

— A —

AC/DC Module, Modular Circuits	95
Absolute Zero Sphere	61
Acceleration/Altimeter, 3-Axis Wireless	103, 114
Adapters, Digital & Analog	125
Advanced Biology Through Inquiry Lab Manual	38
Advanced Chemistry Through Inquiry Lab Manual	56
Advanced Enviro Through Inquiry Lab Manual	74
Agricultural Science – Lab Stations	73, 75
Labs and Manuals	74-75
AirLink Interface	50, 83, 109, 125
Alpha Beta Gamma Radiation Sensor – Wireless	64, 105, 117
Augmented Reality	15

— B —

Balance	60
Ballistic Cart Accessory, Smart	99
Biology – Biology Advanced	38
Biology Labs	37-38
Biology Lab Stations	37-39
Biology Through Inquiry Teacher Guide	38
Blockly Coding	18-19, 111
Blood Pressure Sensor, Wireless	48, 114
Breath Rate Sensor	124
Broad Spectrum Light Sensor	124

— C —

Capstone Software	111
Chamber – Metabolism	44
Photosynthesis	45
Charge Sensor, PASPORT	124
Charging Station – Smart Cart	97, 120
Wireless Sensors	127
Chemical Water Quality Testing	75
Chemistry –	

Chemistry, Advanced	56
Chemistry Labs	53, 55-57
Chemistry Lab Stations	53, 55, 57
Chemistry Through Inquiry Teacher Resources	56

//code.Node – Device	19-22, 115
Kits	21-23, 29, 31

Coding – Coding with Sensor Technologies Kit	21
Coding with Sound & Light Sensor Technologies Kit	23
Coding with Vehicle Sensor Technologies Kit	22
//control.Node Sense & Control Kit	28-29
Greenhouse Sense & Control Kit	26-27, 81
PASCObot Sense & Control Kit	24-25

CO2 Sensor, Wireless – Sensor	11, 44, 76, 115
Waterproof Sleeve	76

Colorimeter – PASPORT	125
Wireless	46, 66, 82, 115

Color Mixer	13
Compound Optical Microscope	14, 51
Conductivity Sensor, Wireless	42, 62, 79, 115
Constant Speed Buggy	12

//control.Node – Device	116
Sense & Control Kit	28-29

Current Sensor, Wireless	63, 106, 116
--------------------------------	--------------

Curriculum & Equipment Kits – Essential Chemistry	53-55
Essential Physics	92-93

Cuvettes – Cuvettes and Caps	66
Disposable Cuvettes	69
Quartz Cuvettes	47, 69
UV Semi-Micro Volume Cuvettes	69

— D —

Demonstration Kit, Smart Cart	98
Density Circulation Model	80
Diffusion/Osmosis Kit	43
Displacement Sensor	124
Disposable Cuvettes	69
Dissolved CO2 Waterproof Sleeve	76
Dissolved Oxygen Sensor	45, 80, 119
Drop Counter, Wireless	59, 116
Dual Pressure Sensor	125

— E —

Eclipse Data104
EcoChamber 14, 45, 81
EcoZone System 14, 45, 81
EKG Sensor and Electrode Patches –
 PASPORT124
 Wireless49, 116
Electricity and Magnetism, Physics Lab Station89
Elementary (K-8) Science 8-14
 Elementary Science Lab Stations..... 9-10
Environmental Science –
 Advanced Enviro Science Through Inquiry
 Teacher Lab Manual..... 74-75
 Enviro Labs..... 74-75
 Enviro Lab Stations 73, 75
 Enviro Teacher Resources 75
 Water Quality Field Guide..... 75
 Water Quality Sensors 82-83, 125
Essential Biology Teacher Lab Manual.....37
Essential Chemistry –
 Curriculum and Equipment..... 55-56
 Lab Manual55
 Teacher Resources55
Essential Physics –
 Curriculum 92-93
 Student Textbook93
Ethanol Sensor 57, 124
Exercise Heart Rate Sensor, Wireless48, 116
Eye Model, Human 50
ezSample Snap Vial Water Quality Kits.....82

— F —

Fast Response Temperature Probe.....125
Fiber Optic Cable –
 UV-Vis47, 69
 Vis102
Flow Rate Temperature Sensor83, 124
Fluids, Physics Lab Station88
Force Acceleration Sensor, Wireless12, 106, 117
Force Platforms, 1- & 2-Axis –
 PASPORT124
 Wireless107, 116
Force Sensor –
 PASPORT124
 Wireless 12, 106, 117

— G —

Galvanometer124
Geiger Counter, Sensor64, 105, 117

General Science Sensor124
Goniometer Sensor + Probe..... 124
GPS Sensor..... (see Wireless Weather Sensor)
Greenhouse Sense & Control Kit..... 26-27, 81
Greenhouse Sensor..... 117

— H —

Hand-Grip Heart Rate Sensor, Wireless48, 118
Heater-Stirrer60
High Sensitivity Light Sensor 124
Human Eye Model 50

— I —

Ideal Gas Law Apparatus61
Infrared Light Sensor 124
Interface –
 550 Universal Interface 108-109
 AirLink.....50, 83, 109, 125
 Comparison Guide 109
 SPARK LXi 2 108-109
 SPARKlink Air 109

— J-K-L —

Lab Stations –
 Agricultural Science.....73, 75
 Biology.....37, 39
 Chemistry 53, 55, 57
 Elementary.....9
 Middle School.....10
 Physics 86-91
Light Sensor –
 Broad Spectrum 124
 High Sensitivity 124
 Infrared 124
 Wireless 13, 43, 79, 104
Eclipse Data 104
Load Cell & Dual Amplifier Set 124
Load Cell Accelerometer, Wireless..... 118

— M-N —

Magnetic Field Sensor –
 PASPORT 2-Axis 124
 Wireless 3-Axis75, 103, 118
MatchGraph – Motion-Graphing Software 96
Mechanics, Physics Lab Stations 86-87
Melt Point Apparatus, Wireless70, 118
Metabolism Chamber44
Microscopes14, 51
MindLabs Energy & Circuits 15

Mini Launcher	101
Middle School Science	10-14
Middle School Science Lab Stations	10
Middle School STEM.....	16-29
Model –	
Density Circulation.....	80
Diffusion/Osmosis	43
Ecosystem	14, 45, 81
Human Eye	50
Molecular	64
Wave Motion.....	13
Modular Circuits & Kits	94-95
Molecular Model Set	64
Motion Sensors –	
PASPORT	125
Wireless	12, 96, 118
Motor –	
Servo	25
Smart Cart	97
Motorized Structures.....	31-35
Non-Contact Temperature Sensor	83, 125

– O –

O2 Gas Sensor, Wireless.....	44, 119
Ohaus Scout SKX Balance.....	60
Optical Dissolved O2 Sensor, Wireless	45, 80, 119
Optics, Physics Lab Station	90
Oxidation Reduction Potential Probe.....	57

– P –

PASCO Academy	(see Essential Curriculum)
PASCObot –	
Basic Kit	25
Gripper Accessory.....	25
Line Follower Module	25
Range Finder Module	25
Sense & Control Kit	24-25
Servo Motor.....	25
pH Sensor, Wireless	11, 41, 58, 78, 119
Photogate –	
Projectile Launcher System.....	101
Smart Gate	125
Wireless Smart Gate.....	101, 120
Photosynthesis Chamber	45
Physics	84-113
Physics Lab Stations –	
Electricity and Magnetism	89
Fluids	88
Mechanics Extension	87
Mechanics Starter	86

Optics	90
Waves and Sound	91
Physiology Extension Bundle	39
Polarimeter, Wireless	46, 65, 119
Polarizer Demonstrator.....	65
Pressure Sensor –	
PASPORT	125
Wireless	42, 62, 104, 119
Professional Development.....	136
Projectile Launchers.....	101

– Q-R –

Robotics	(see PASCObot)
Rolling Storage Carts	126
Rotary Motion Sensor –	
PASPORT	125
Wireless	100, 120

– S –

Salinity Sensor.....	83, 125
Sense & Control Kits –	
//control.Node Sense & Control Kit	28-29
Greenhouse Sense & Control Kit.....	26-27, 81
PASCObot Sense & Control Kit.....	24-25
Sensor Charging Station	127
Sensor Index, Wireless.....	114
Servo Motor, PASCObot.....	25
Skin Surface/Temperature Probe	125
Smart Ballistic Cart Accessory.....	99
Smart Cart –	
Cart.....	12, 97, 120
Charging Garage	97, 120
Demo Kit	98
Motor	100
Vector Display.....	98
Smart Fan Accessory	99
Smart Gate –	
Original	125
Wireless	101, 120
Projectile Launcher System.....	101
Soil Moisture Sensor –	
PASPORT	125
Wireless	40, 76, 121
Sound Sensor, Wireless.....	13, 102, 121
SPARK LXi 2	108-109
SPARKlink Air	109
SPARKvue	4-5, 18-19
Spectrometer –	
Comparison Chart	68
UV-Vis.....	47, 69
Wireless Vis	47, 67, 102, 121

Spectrometry Software69

Spirometer –

PASPORT 125
Wireless49, 121

Stainless Steel Temp Probe..... 125

Standard Compound Optical Microscope14, 51

STEM Sense –

Coding with Sensor Technologies Kit.....21
Coding with Sound & Light Sensor Technologies Kit.....23
Coding with Vehicle Sensor Technologies Kit22
Greenhouse Sense & Control Kit..... 26-27, 81
PASCObot Sense & Control Kit..... 24-25

Storage –

Carts & Trays 126-127
Sensors.....127

- T -

Temperature Link, Wireless43, 61, 121

Temperature Sensor –

Non-Contact.....83, 125
PASPORT 125
Wireless 11, 41, 60, 78, 104, 121

Thermocline Sensor 125

- U -

Universal Interface, 550..... 108-109

USB Microscope Cameras.....51

UV Quarts Cuvettes.....47, 69

UV-Vis –

Fiber Optic Kit.....47, 69
Spectrometer.....47, 69

- V -

Velocity Cart, Constant.....12

Voltage Sensor, Wireless63, 106, 122

Visible Spectrometer 47, 67-68, 102, 121

- W-X-Y-Z -

Water Quality –

Colorimeter, PASPORT 125
Colorimeter, Wireless.....46, 66, 68, 82, 115
ezSample Snap Vial Kits.....82
Field Guide75

Wave Motion Demonstrator13

Waves and Sound, Physics Lab Station91

Weather Sensor with GPS –

Wireless 11, 40, 77, 122
Weather Vane Accessory.....40, 77

Wireless AC/DC Module.....95

Wireless Sensor Charging Station..... 127

Wireless Sensor Index..... 114

Wireless Sensors –

3-Axis Acceleration/Altimeter 103, 114

3-Axis Magnetic Field.....75, 103, 118

AirLink.....50, 83, 109, 125

Blood Pressure48, 114

CO2 Sensor 11, 44, 76, 115

//code.Node..... 19-22, 115

Colorimeter & Turbidity46, 66, 82, 115

Conductivity.....42, 62, 79, 115

//control.Node 116

Current.....63, 106, 116

Drop Counter.....59, 116

EKG49, 116

Exercise Heart Rate.....48, 116

Force Acceleration..... 12, 106, 117

Force Platforms 107, 116-117

Geiger Counter64, 105, 117

Greenhouse 117

Hand-Grip Heart Rate.....48, 118

Light.....13, 43, 79, 104

Load Cell Accelerometer 118

Magnetic Field, 3-Axis.....73, 103, 118

Motion.....12, 96, 118

O2 Gas.....44, 119

Optical Dissolved O2.....45, 80, 119

pH..... 11, 41, 58, 78, 119

Polarimeter46, 65, 119

Pressure.....42, 62, 104, 119

Projectile Launcher and
Wireless Smart Gate System 101

Rotary Motion 100, 120

Smart Cart12, 97, 120

Smart Gate 101, 120

Soil Moisture.....40, 76, 121

Sound 13, 102, 121

SPARK LXi 2 108-109

SPARKlink Air 109

Spectrometer.....47, 67, 102, 121

Spirometer49, 121

Temperature..... 11, 41, 60, 78, 104, 121

Temperature Link43, 61, 121

Voltage.....63, 106, 122

Weather w/GPS11, 40, 77, 122

PART NUMBER INDEX

EB-6331	37	OS-8910	90
EB-6334	37-39	OS-8508	90
EB-6335	39	OS-9477A	65
EB-6336	73, 75	PS-2011	109
EB-6337	75	PS-2103A	125
EC-6330	53, 55	PS-2104	124
EC-6350A, EC-6350-EB1	55	PS-2111	124
EC-6352	55	PS-2120A	125
EC-6353-DIG	55	PS-2130	83, 124
EC-6362	53, 55, 57	PS-2131	125
EC-6363	53, 55, 57	PS-2132	124
EM-3533	95	PS-2135	125
EM-3535	94	PS-2137	124
EM-3536	94	PS-2141	124
EM-3540	94	PS-2142	124
EM-3557	89	PS-2148	124
EP-3574	126	PS-2150	124
EP-3575	126	PS-2151	125
EP-6323, EP-6323-EB1	93	PS-2152	125
EZ-2331	82	PS-2153	125
EZ-2333B	82	PS-2158	125
EZ-2334A	82	PS-2159	125
EZ-2337	82	PS-2160	124
EZ-2338	82	PS-2162	124
EZ-2339A	82	PS-2163	125
EZ-2340	82	PS-2168	124
ME-1240	12, 97, 120	PS-2176	124
ME-1241	12, 97, 120	PS-2179	125
ME-1242	99	PS-2180	125
ME-1243	97, 120	PS-2181	125
ME-1245	99	PS-2187	124
ME-1246	98	PS-2189	124
ME-1247	100	PS-2194	57, 124
ME-1272	98	PS-2195	83, 125
ME-1273	98	PS-2197	83, 125
ME-2040	88	PS-2204	124
ME-3581	30	PS-2206	124
ME-5300	86-88	PS-2343	51
ME-5301	87	PS-2400, PS-2400-DIG	4-5, 18-19
ME-6667	45	PS-2401, PS-2401-DIG	4-5, 18-19
ME-6668	14, 45, 81	PS-2522	49
ME-6796	101	PS-2548	107
ME-6800	101	PS-2600A	47, 67, 102, 121
ME-6816	80	PS-2601	102
ME-6825B	101	PS-2828A	56
ME-6936	44	PS-2829A	75
ME-6942	43	PS-2852A	38
ME-7020	34	PS-2935D	39
ME-7021	34	PS-2979	75
ME-7022	34	PS-2994	24-25
ME-7023	34	PS-3200	50, 83, 109, 125
ME-7024	34	PS-3201	11, 41, 60, 78, 121
ME-7025	35	PS-3202	12, 106, 117
ME-7026	35	PS-3203	42, 62, 104, 119
ME-7027	35	PS-3204	11, 41, 58, 78, 119
ME-7028	32	PS-3206	48, 118
ME-7029	33	PS-3207	48, 116
ME-7030	31	PS-3208	11, 44, 76, 115
ME-7037	35	PS-3209	11, 40, 77, 122-123
ME-8270	71	PS-3210A	42, 79, 115
NU-3344	64	PS-3211	63, 106, 122
OS-8477A	50	PS-3212	63, 106, 116
OS-8496	13		

PS-3214	59, 116	PS-3545	76
PS-3215	46, 66, 82, 115	PS-3553	11, 40, 77
PS-3216	118	PS-3585	127
PS-3217	44, 119	PS-3586	127
PS-3218	48, 114	PS-3587	127
PS-3219	12, 96, 118	PS-3588	127
PS-3220	100, 120	PS-3589	127
PS-3221	75, 103, 118	PS-3594	127
PS-3222	43, 61, 121	PS-3595	127
PS-3223	103, 114	PS-3596	127
PS-3225	101, 120	PS-3598	127
PS-3227	13, 102, 121	PS-3599	127
PS-3228	40, 76, 121	PS-3600B	108-109
PS-3229	107, 117	PS-5050	28-29
PS-3230	107, 116	PS-5051	28-29
PS-3231	20, 115	SC-2321	71
PS-3232	116	SE-2952	25
PS-3233	20	SE-2953	25
PS-3234	49, 121	SE-2975	25
PS-3236	49, 116	SE-3607	47, 69
PS-3237	46, 65, 119	SE-3610	69
PS-3238	64, 105, 117	SE-3611	47, 69
PS-3239	70, 118	SE-6201	51
PS-3245	49	SE-6204	51
PS-3246	45, 80, 119	SE-6205	51
PS-3248	13, 43, 79, 104, 118	SE-6213	14, 51
PS-3251	45	SE-6215	70
PS-3311	20	SE-7170	15
PS-3312	10	SE-7171	15
PS-3313	10	SE-7172	15
PS-3314	9	SE-7173	15
PS-3315	9	SE-7182	47, 69
PS-3320	25	SE-7560	127
PS-3321	25	SE-8028A	12
PS-3322	117	SE-8739	66
PS-3325	25	SE-8821	60
PS-3326	127	SE-8823A	60
PS-3327	127	SE-9444	71
PS-3328	127	SE-9445	71
PS-3329	127	SE-9446	71
PS-3330	11, 41, 60, 78	SE-9601	13
PS-3331	11, 41, 58, 78	ST-2997	26-27, 81
PS-3332	42, 62, 79	ST-7611	14
PS-3333	42, 62, 104	ST-7800	21
PS-3334	66, 46, 82	ST-7801	21
PS-3335	63	ST-7820	22
PS-3336	63	ST-7821	22
PS-3337	12, 96	ST-7830	23
PS-3338	13, 43, 79, 104	ST-7831	23
PS-3339	12, 106	ST-7840	24-25
PS-3340	40, 77	TD-8595	61
PS-3341	11, 44, 76	TD-8596A	61
PS-3342	13, 102	UI-5001	108-109
PS-3400	64	UI-5400	110-111
PS-3401	60	UI-5401	110-111
PS-3514	71	UI-5405	110-111
PS-3515	57, 71	UI-5406, UI-5406-DIG	110-111
PS-3516	71	WA-9515	91
PS-3517	71		
PS-3518	71		
PS-3519	71		
PS-3520	71		
PS-3521	71		

The PASCO Promise of Learning (90-day Satisfaction Guarantee)

We are confident that PASCO solutions will help your students achieve more in science. Within the first 90 days, if you are not satisfied that your students are more engaged and learning more effectively, return your purchase for a refund. We don't want you spending precious budget dollars on something you don't use. (We are sorry but we must exclude non-PASCO software that has been opened, radioactive products, and products that contain perishables.) See instructions for Returns below.

PASCO 5-Year Limited Warranty for Education

PASCO products are built to survive. PASCO-manufactured products are covered by a limited warranty for a period of 5 years from delivery date against defects in material and workmanship. This warranty is valid for educational institution customers and only for educational use of these products. The PASCO warranty does not extend to any product, including touch screens, which have been subject to abuse, neglect, accident, improper installation or application, or products that have been repaired or altered outside of our factory. Consumables and limited-life products (such as pH probes, membranes, fast response temperature probes, batteries, chemical solutions, some light sources, printed materials, etc.) are excluded.

Other Warranty Terms

The SPARK LXI2 datalogger carries a limited warranty for a period of 3 years from delivery date against defects in material and workmanship. This limited warranty applies only to hardware components of the SPARK LXI2 that are not subject to accident, misuse, neglect, fire, or other external damage. This warranty can also be voided by unauthorized use, alterations, or repair. This warranty is valid for education institution customers and only for educational use of these products.

Products manufactured by anyone other than PASCO are subject to the conditions of the warranty supplied by the manufacturer (generally 1 year). Additional warranty information on our products is available upon request.

Free Teacher and Technical Support

We want teachers to be successful with PASCO solutions. Please contact our support team with any questions via phone or email: +1 916-786-3800 or support@pasco.com. We are here to help.

Software License Agreement:

(Includes: SPARKvue, Capstone, Chemvue, Match Graph, Spectrometry, PASCO Portal)

This End-User License Agreement ("EULA") is a legal agreement between you (the "Licensee") and PASCO scientific, Inc. ("PASCO"). This EULA covers PASCO's Education Software products and any accompanying documentation. The PASCO's Education Software is licensed, not sold.

- Single User License:** If you have purchased a Single User License, you are granted a non-exclusive, non-transferable license to use the PASCO's Education Software on a single device for personal or educational purposes.
- Site License:** If you have purchased a Site License, you are granted a non-exclusive, non-transferable license to install and use the PASCO's Education Software on multiple devices owned by the Licensee within a single educational institution, such as a school or college. Users at remote institutional locations, such as satellite campuses, are not covered by the Site license.
- Subscription:** If you have purchased a Subscription, you are granted a non-exclusive, non-transferable license to use the PASCO's Education Software for the duration of the subscription period.

For online access to the complete EULA agreement refer to pasco.com/p/licenses-and-agreements

ebook License Agreement

(Includes: Essential Chemistry and Essential Physics)
PASCO hereby grants Subscriber a non-transferable, revocable, limited license to access online the ebook(s) via teacher.pasco.com & student.pasco.com. The ebook(s) consists of Essential Physics and/or Essential Chemistry with licensed Content on select topics. Subscriber is licensed to use content made available to Subscriber in the ebook(s) ("Content") solely in the regular course of student education and district/school business. If PASCO loses the right to offer any ebook

Content, discontinues the Software, or is otherwise unable to offer ebook Content, PASCO may terminate Subscriber's access to the ebook(s). At PASCO's sole discretion and using commercially reasonable practices, PASCO may provide the Content in another media format. PASCO, at its sole discretion may update Subscriber to a more recent version of the ebook(s) if necessary to maintain access. PASCO hereby grants school and/or district, a non-exclusive and non-transferable license to view, use and display the Licensed Material on the following terms and conditions only:

- School and/or District acknowledges that the Licensed Material is being licensed to the school and/or district and use is subject to the terms and conditions of this Agreement.
- The Licensed Material is for educational use only.
- School and/or District may use the Licensed Material only on the number of devices permitted by the license terms set forth in the purchase agreement.
- School and/or District agrees that all terms of this Agreement also apply to any materials in print format (bound textbooks) that may be included with this license.

For online access to the complete EULA agreement refer to pasco.com/p/licenses-and-agreements

Shipping

Items in stock will normally be shipped in less than five working days from receipt of the order. Specific requests for air shipments or special carriers will be honored at an additional cost.

Returns

Please contact the authorized PASCO representative in your country for assistance in returning equipment for repair. PASCO's International Customer Service team can be reached at +1-916-786-3800 or at intlcustserv@pasco.com. Out-of-Warranty products must be shipped prepaid, door-to-door. Returns for credit or exchange must be in new condition and packaged in original shipping cartons or packaging sufficient to prevent damage during international transport.

Trademarks

PASCO, PASCO scientific, PASCO Capstone, PASCO Chemvue, EcoZone, ezSample, MatchGraph, MultiMeasure Sensors, ScienceWorkshop, SPARKscience, SPARK Element, SPARKvue, SPARKvue HD, SPARKlab, SPARKlink, PASPORT, STEM Sense, AirLink, //code. Node and Tension Protractor are trademarks or registered trademarks of PASCO scientific in the United States and/or in other countries. All other brands, products or service names are or may be trademarks or service marks of, and are used to identify products or services of, their respective owners. For more complete information visit pasco.com/legal.

More Product Information

Designed for education. PASCO products are designed for education; they are not intended for use in graduate research or industry, and should not be used in any apparatus involved with life support, patient diagnosis, or industrial control. PASCO reserves the right to change the specifications of any product without prior notice. If a product is no longer available, PASCO reserves the right to substitute a product of equal, or higher, value and functionality.

FCC

Where appropriate, electrical products are marked to indicate that they conform to Federal Communications Commission (FCC) standards. Most commonly, FCC Part 15, Class A.

CE MARK

Where appropriate, products carry the CE marking, which indicates that they conform to the applicable European standards. This almost exclusively applies to products that are designed to meet the following applicable directives:

2014/30/EU	EMC Directive
2014/35/EU	Low Voltage Directive
2015/863	RoHS3
2014/53/EU	Radio Equipment Directive

Other Regulations May Apply

Local, national, and international regulations may restrict the purchase, storage, transport, use or disposal of certain products such as chemicals, radioactive sources, and specialty products and wireless transmission devices. Please consult your local regulations to ensure compliance.

Unless Otherwise Specified:

- Operating Temperature Range: 0°C to 40°C (32°F to 104°F)
- Maximum Altitude (Operational): 10,000 feet
- Recommended Storage Temperature: 10°C to 27°C (50°F to 80°F)

Quality

PASCO scientific meets the highest quality standards, and our quality management system is registered to ISO 9001.

PASCO and the Environment

PASCO is committed to being in compliance with all laws and requirements in the countries in which our products are sold. PASCO is a responsible steward of the environment and as such, continually seeks to minimize the impact that our manufacturing, distribution, and consumption practices make on the planet's natural resources.

Miscellaneous



RoHS

European Union Restriction of Hazardous Substances. EU Directive 2015/863:

- All applicable electrical products supplied by PASCO to the EU meet the requirements as specified in the RoHS directive either by substance limits or by product exemptions.

EU WEEE

Waste Electrical and Electronic Equipment. EU Directive 2012/19/EC:

- All applicable products supplied by PASCO to the EU meet the requirements as specified in the WEEE directive and are marked with the WEEE symbol.

WEEE-Product End of Life Disposal Instructions (Reference):

Electronic products are subject to disposal and recycling regulations that vary by country and region. It is a user's responsibility to recycle electronic equipment per local environmental laws and regulations to ensure that equipment is recycled in a manner that protects human health and the environment. To find equipment recycling drop-off locations, please contact your local waste recycle/disposal service or the product representative.



The European Union (EU) WEEE (Waste Electrical and Electronic Equipment) symbol on our products and packaging indicates that this product must not be disposed of in a standard waste container.

EU REACH

Registration, Evaluation and Authorization of Chemicals:

- PASCO has reviewed the REACH SVHC list and, according to our current knowledge, cables supplied with some products may contain certain phthalate plasticizers at greater than 0.1% by weight
- Regarding the other SVHC's, to the best of our knowledge, none are present in PASCO products (articles) at concentrations of greater than 0.1% by weight

Battery Replacement and Disposal Instructions (Reference):

Batteries contain chemicals that, if released, may affect the environment and human health. Batteries should be collected separately for recycling, and recycled at a local hazardous material disposal location adhering to your country and local government regulations. To find a battery recycling drop-off location, please contact local waste disposal service or the product representative.



The battery or batteries used in PASCO products are marked with the European Union symbol for waste batteries that indicate the need for separate collection and recycling. For small batteries, the symbol is printed on the packaging.

EU Battery Directive

EU Directive 2006/66/EC on Waste Batteries:

- The European Union (EU) battery directive aims to reduce the environmental impact of waste batteries and accumulators.
- According to our specifications, all products supplied by PASCO scientific into the EU that contain batteries meet the battery directive requirements, and are marked with the battery symbol.

PASCO

Since 1964

The Global Leader in 21st Century
Science Education

Supporting educators in over
100 countries around the world

When you have questions or need service, we want someone who understands your local needs. We carefully select, train, and support local Science Education Partners to serve our customers in each country.

When you work with a PASCO Science Education Partner, have confidence that the entire company here in California is ready to assist our Partner – and you, our Customer.

*Designed in California.
Guaranteed by PASCO.
Supported locally.
Serving science educators.*



+1 916-786-3800

ISO 9001 Certified





2024 Summer Institutes

Join us in sunny California for a 2024 PASCO Summer Institute! These events offer a unique opportunity to extend your professional skills, connect with like-minded educators, and explore new approaches for engaging students in STEM learning.

You'll also enjoy exclusive access to the PASCO facility, including a behind the scenes tour of how our solutions are made. Meet the passionate people behind our products, share your thoughts and ideas, and get a sneak peek at what's to come.

Interested in attending?

Save your seat at a 2024 PASCO Summer Institute! For registration and event details, visit us online at:

pasco.com/institutes



SPARKvue Institute

See online for dates and availability

Intended for teachers of all science disciplines.



PASCO Capstone™ Institute

See online for dates and availability

Intended for physics teachers.

Global Coverage & World-Class Support

PASCO

PASCO's global network of factory-trained partners are science specialists who are knowledgeable about PASCO solutions. Contact our team today to see how PASCO can update your labs and provide value for years to come.

Find Your Local Representative
pasco.com/support

Follow PASCO:



Live Contact Hours:

M–Th: 7:00 am–4:30 pm
F: 7:00 am–2:00 pm
Pacific Time



Phone:

+1 916.786.3800 (outside US)
800.772.8700 ext. 1004
(inside US)
Fax: 916.786.7565



Mail:

PASCO Scientific
10101 Foothills Blvd.
Roseville, California
95747-7100 USA
ISO 9001:2015 Certified



Email:

support@pasco.com



Web:

Get quotes and
order online
pasco.com



Chat on pasco.com

Providing educators worldwide with innovative solutions for teaching science.



Physics Lab Stations (See Pages 86-91)

PASCO's **Physics Lab Stations** support hands-on physics learning all year long and come complete with sensors, labs, apparatus, and more. Lab stations support hands on labs in electricity & magnetism, fluids, mechanics, optics, and waves & sound.



*(Physics Lab Station: Mechanics
Extension set shown here)*



CT-IHS