

LED NARROW LIGHT SYSTEM

THE HIGH PERFORMANCE

LED Luminaire Series for Office, School, and General Locations



KEY FEATURES INCLUDE:



Multiple Color Options

Ensure that the new lighting will match your current aesthetics, and allows for custom color options.

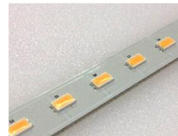

Long Lasting LED Chips

L₉₀ in excess of 101kHrs



10 Year Warranty

Industry Leading 10 Year Warranty on all LED and external drivers.



High Color Rendering

Colors are enhanced due to the use of LEDs selected directly on the black body curve.



Manufactured in America

With domestic and imported components. Factory: Southeastern PA. Higher quality control, faster delivery times, and new domestic job creation.

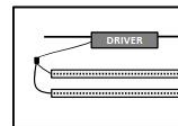

Independent Class II Driver

Safety, improved thermal management, and extended lifetime are gained by locating the driver remote from the LEDs.





LED NARROW LIGHT SYSTEM

LENGTH OPTIONS:

4' – standard, 2', 6' & 8' - special order

OUTPUT WATTAGE (See table below)

COLOR OPTIONS:

2700K, 3000K, 3500K, 4000K, 5000K standard⁵

CRI – 85

DIMMING – standard (except - 0)

LENS - Frosted

Specification Table	
Environmental	Suitable for Damp Locations up to IP21 per EN60529
Ambient Operation	-25°F to 104°F/(-31°C to 40°C) ^{6,7}
Storage	-25°F to >185°F/(-31°C to >85°C)
Wattage	See table below ¹²
Input Voltage (nominal)	100-277VAC 50/60Hz .8-.3A [120-300VDC] ⁹ +24VDC
Power Factor (PF)	>0.9
Total Harmonic Distortion (ATHD)	<20%
Life Time	>100khrs
Rated Life- LEDs per TM-21 -	Calculated L ₇₀ (10k) = 378kHrs ¹⁶
LED Driver ⁷	Calculated L ₉₀ (10k) = 101kHrs ¹⁶
Lifetime - MBTF ² -	Reported L ₇₀ (10k) >60kHrs
LM80 Data	NVLap Accreditation
LED Type	SMD 5630
Efficiency (some models)	>130lm/W (See table below) ¹²
	>DC numbers
Certifications	cUL, UL, FCC
Warranty ¹⁷	LED Driver - 10 years
	LED - 10 years
	Fixture - 10 years
Dimming	<20%-100% (See below)
	0-10V (accept – ND)
Off State Power Consumption	0 Watts
On State	Instantaneous

Package Information	
Standard Package	Case
Quantity	1
Sales Units	1
Package Items	1 Unit Complete
Weight lbs(kg)	4' - 18 (9) // 2' – 9 (5)

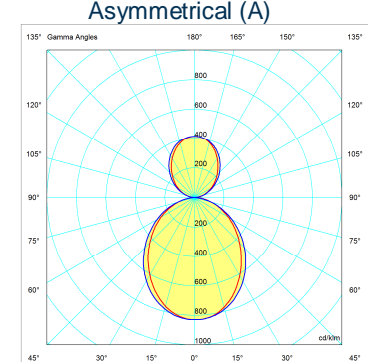
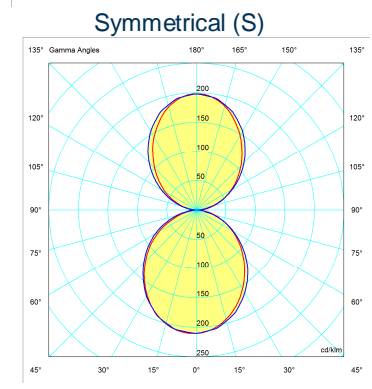
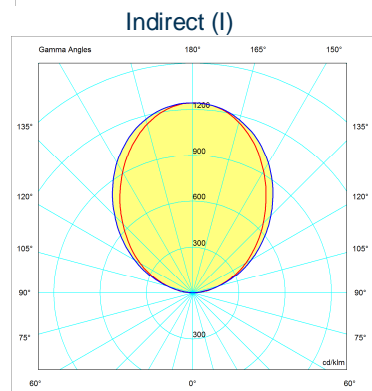
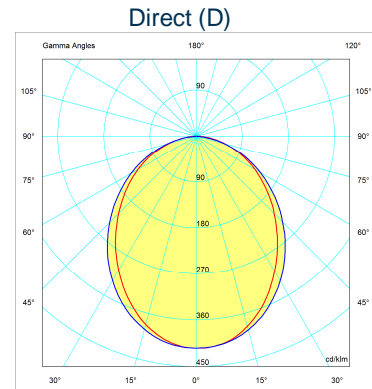

LED NARROW LIGHT SYSTEM

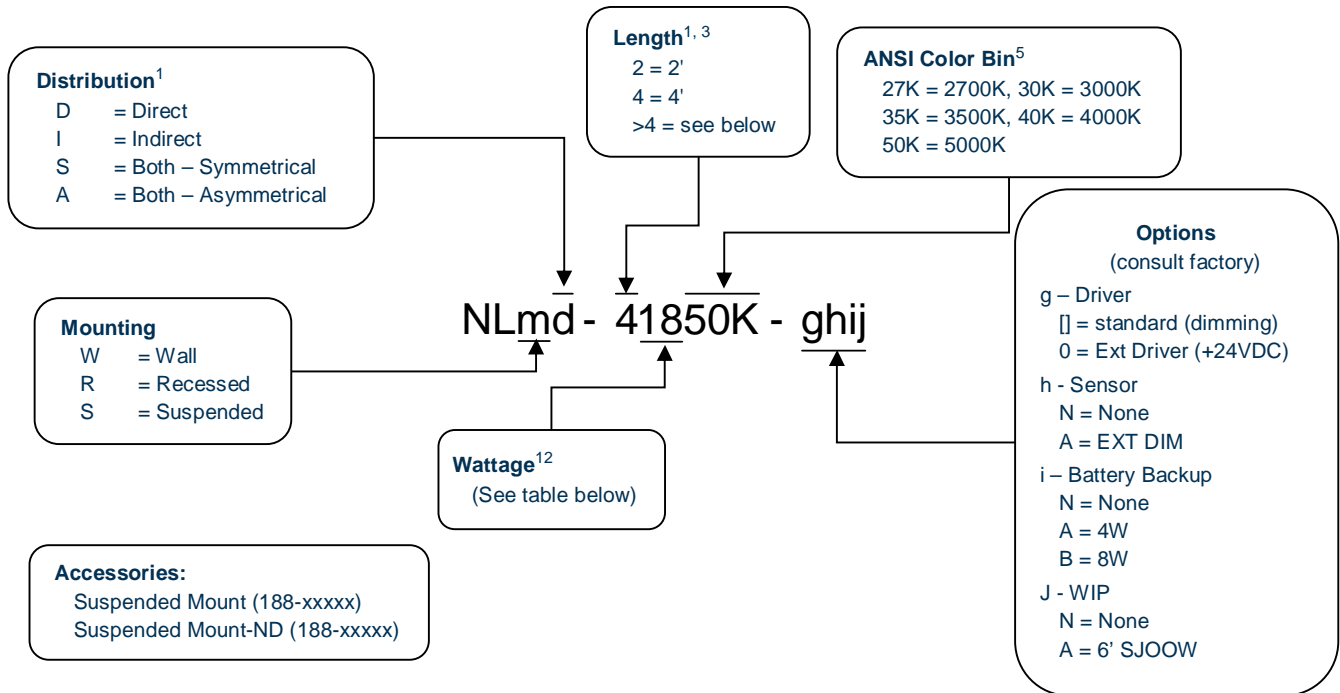

Length (ft)	Nominal Wattage ¹² (W)	Lumens ^{1,12} @5000K (-12%/ to 2700K)		
2	Consult Factory			
4	18	2500	-	D
		-	2500	I
	28	2500	1250	A
	36	2500	2500	S
	24*	3100	-	D
		-	3100	I
	36*	3100	1550	A
	48*	3100	3100	S
	28	3550	-	D
		-	3550	I
36	3300	1650	A	
58	3550	3550	S	
>4	Consult Factory – will be assembled from multiple segments, length and wattage of product description will reflect total run length			

* – 0 (Ext Driver)



Notes

1. Not all model combinations are available
2. MBTF per MIL-HDBK-217F
3. Extended lead times and minimums maybe required for some models
4. N/A
5. Other ANSI Color bins available
6. Operation to -40°F/-40°C is available
7. Some low wattage models -4°F to +140°F/(-20°C to 60°C), consult factory.
8. Extended warranties are available
9. Non-UL applications (Some Models)
10. N/A
11. Specifications and availability subject to change without notice
12. Varies depending on color temperature, CRI, LED driver and lens ($\pm 10\%$)
13. N/A
14. EPC Act -179d tax incentive ready product given dimming bi-level switching requirements
15. Certain chemicals that may exist in end-user locations release airborne contaminants that can impact the integrity and safety of key fixture components that contain acrylic or polycarbonate material.
16. Worst case temperature for NLSS-428 @25°C ambient.
17. Consult website for further details.

Compliance Standards

- UL 1993 - Self-Ballasted Lamps and Lamp Adapters, Ed. 4: 2012
- UL 1598 - Luminaires
- UL 1598C - Light-Emitting Diode (LED) Retrofit Luminaire Conversion Kits
- UL 8750 - Standard for Light Emitting Diode (LED) Equipment for Use in Lighting Products, Ed. 1: 2009
- CSA C22.2 No. 250.13 - Light emitting diode (LED) equipment for lighting applications, Ed. 1222012
- EN 62471:2008 - Photo Biological Safety of Lamps and Lamp Systems
- EN 62031:2008 - LED modules for general lighting. Safety specifications
- EN 61347-1:2008 - Lamp controlgear. General and safety requirements
- EN 55015:2006 - Limits and methods of measurement of radio disturbance characteristics of electrical lighting and similar equipment
- EN 61347-2-13:2006 - Lamp controlgear. Particular requirements for d.c. or a.c. supplied electronic control gear for LED modules
- EN 61000-3-2:2006 - Electromagnetic compatibility (EMC). Limits. Limits for harmonic current emissions
- EN 61000-3-3:2008 - Electromagnetic compatibility (EMC). Limits. Limitation of voltage changes, voltage fluctuations and flicker in public low-voltage supply systems
- EN 60598-1:2008 - Luminaires. General requirements and tests
- EN 61547:2009 - Equipment for general lighting purposes. EMC immunity requirements
- FCC Part 15, Subpart B, Class B -
- ANSI/ANSI G C78.81-2010 - Electric Lamps-Double-Capped Fluorescent Lamps-Dimensional and Electrical Characteristics
- ANSI/NEMA/ANSI G C78.377-2008 - American National Standard for Specifications for the Chromaticity of Solid State Lighting (SSL) Products
- IEC 60529-2004 - Degrees of Protection Provided by Enclosures (IP Code)
- DOH Article 81.19 (b) - Lighting and ventilation
- FDA Article 6-202.11 - Light Bulbs, Protective Shielding



Mechanical

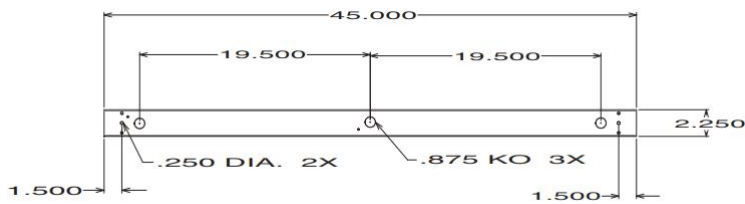
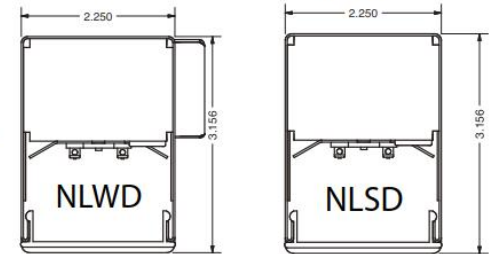
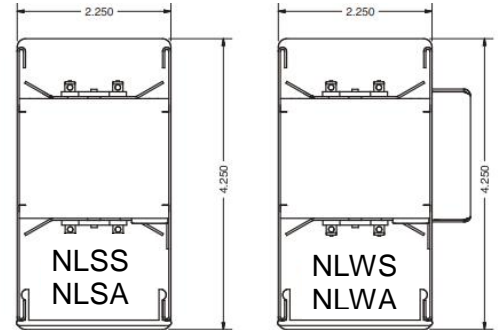
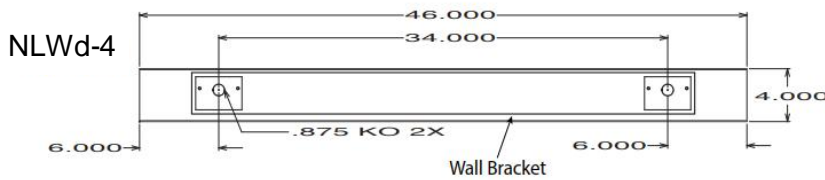
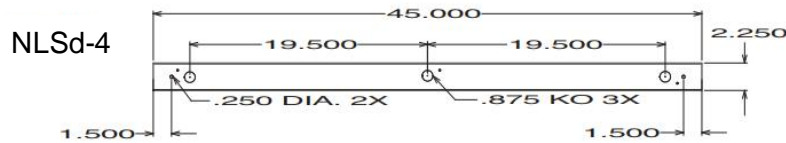
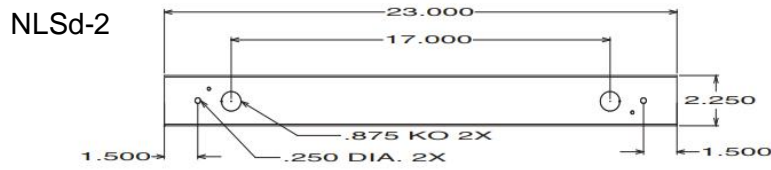

Dimensions being updated

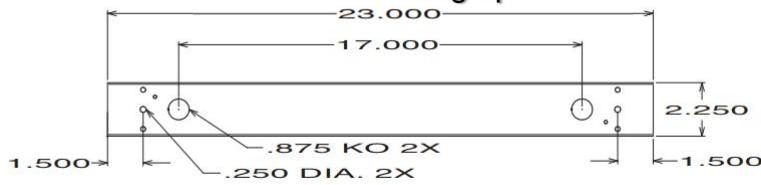

Consult factory for additional options not shown or listed

