

# Loadrite L5000

## User Manual

Software 151215  
Version 1.4.0  
Revision C  
May 2024  
ENGLISH

**151039-95-ENG**

**LOADRITE®**

# Loadrite L5000

## User Manual

Software Number: 151215  
Version Number: 1.4.0

Document Number: 151039-95-ENG  
Revision: C

Issued Date: May 2024

E: [info@goloadrite.com](mailto:info@goloadrite.com)  
W: [www.goloadrite.com](http://www.goloadrite.com)

© 2024 Loadrite (Auckland) Ltd. All Rights Reserved. Loadrite is a trademark and/or registered trademark of Loadrite (Auckland) Ltd. All other trademarks and registrations are the property of their respective owners.



The software contains proprietary information of Loadrite (Auckland) Ltd; it is provided under a license agreement containing restrictions on use and disclosure and is also protected by copyright law. Reverse engineering of the software is prohibited.

This document is copyrighted with all rights reserved. Under copyright laws, this document may not be copied in whole or in part, reproduced in any other media, stored in a retrieval system, or transmitted in any form or by any means, electronic, mechanical, photocopying, recording or otherwise, without the express written permission of Loadrite (Auckland) Ltd. Permitted copies must carry the same proprietary and copyright notices as were affixed to the original. Under the law, copying includes translation into another language.

Published in New Zealand.

# Important safety information

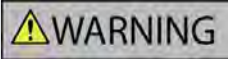
PLEASE READ CAREFULLY BEFORE USING THE LOADRITE™ WEIGHING SYSTEM

	This is the safety alert symbol. It is used to alert you to potential personal injury hazards. Obey all safety messages that follow this symbol to avoid possible injury or death.
	<b>WARNING</b> indicates a potentially hazardous situation which, if not avoided, could result in death or serious injury.
	<b>CAUTION</b> indicates a potentially hazardous situation which, if not avoided, may result in minor or moderate injury.
	<b>CAUTION</b> used without the safety alert symbol indicates a potentially hazardous situation which, if not avoided, may result in property damage.

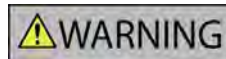

It is your sole responsibility to place, secure and use the Loadrite Weighing System in a manner that will not cause accidents, personal injury or property damage. Always observe safe operating practices.

Do not install the Loadrite Weighing System in a way that may interfere with the safe operation of the vehicle, or deployment of safety equipment.

Before you use the Loadrite Weighing System for the first time, familiarize yourself with the system and its operation.



Do not handle any part of the Loadrite Weighing System if it is hot. Let the product cool, out of direct sunlight.

Ensure that the Loadrite Weighing System is connected to a power source with the correct fitting and voltage requirements.

Do not attempt to service the Loadrite Weighing System as this could result in personal injury.



Removing Loadrite Weighing System equipment or adding accessories could affect the accuracy of weighing data and your warranty.

Do not install cables over horizontal surfaces where they may be stood on or hit by falling objects.

**Failure to adhere to these warnings and cautions may lead to death, serious injury or property damage. Loadrite (Auckland) Ltd disclaims all liability for installation or use of the Loadrite Weighing System that causes or contributes to death, injury or property damage, or that violates any law.**

# Table of contents

<b>1.0 Welcome</b>	<b>6</b>
<b>2.0 Introduction</b>	<b>7</b>
2.1 Loadrite-equipped loader	8
2.2 Indicator features	9
2.3 Total screen	10
2.4 Accurate weighing	14
2.4.1 Obtaining the best weighing results	14
2.4.2 Legal for Trade systems	14
<b>3.0 The day-to-day weighing process</b>	<b>15</b>
3.1 How do I turn on the Indicator?	15
3.2 How do I perform a warm-up?	15
3.3 How do I select a scale?	16
3.4 How do I zero the empty bucket?	17
3.5 How do I select a product to weigh?	18
3.6 How do I select a customer?	19
3.7 How do I select a truck to load?	20
3.8 How do I weigh and add a bucketload?	21
3.8.1 Remote Buttons	22
3.8.2 What is Auto-Add?	22
3.8.3 Subtract a bucketload	23
3.8.4 Undo/Redo	23
3.9 How do I complete the load?	24
3.10 How do I turn off the Indicator?	25
<b>4.0 Customizable data lists</b>	<b>26</b>
4.1 Select a data list value	26
4.2 Add a new data list value	27
4.3 Delete a data list value	28
<b>5.0 Target Weighing mode</b>	<b>29</b>
5.1 How do I enter Target Weighing mode and input a target?	29
5.2 How do I return to Total mode?	30
<b>6.0 Split Weighing mode</b>	<b>31</b>
6.1 Using Split Weighing mode within Total mode	31
6.2 Using Split Weighing mode within Target Weighing mode	32
<b>7.0 Loadrite 360 Job Management</b>	<b>34</b>
7.1 How do I turn on the Indicator?	35
7.2 How do I perform a warm-up?	35

7.3	How do I select a scale?	36
7.4	How do I zero the empty bucket?	37
7.5	How do I select a job?	38
7.5.1	How do I cancel a job?	39
7.5.2	How do I add a customer or other data list to the job?	39
7.6	How do I weigh and add a bucketload?	40
7.6.1	Remote Buttons	41
7.6.2	What is Auto-Add?	41
7.6.3	Subtract a bucketload	42
7.6.4	Undo/Redo	42
7.7	How do I turn off the Indicator?	43
<b>8.0</b>	<b>More Options menu</b>	<b>44</b>
8.1	Add a Target	44
8.2	Select Scale	45
8.3	Transaction History	45
8.3.1	Search for a ticket	46
8.3.2	Print a ticket	47
8.3.3	Print a range of tickets	47
8.4	Metrics	48
8.4.1	Operator Metrics	48
8.4.2	Data Totals	49
8.4.3	Target Metrics	50
8.4.4	Weighbridge Metrics	51
8.4.5	Time Metrics	51
8.4.6	Lifetime Totals	52
8.4.7	How do I reset metrics?	52
8.5	Take Snapshot	52
8.6	About	53
8.7	Settings Menu	53
8.7.1	Preferences	53
8.7.2	Diagnostics	57
8.7.3	Set up	61
<b>9.0</b>	<b>Appendix A: System specifications</b>	<b>62</b>
9.1	Weighing accuracy	62
9.2	Minimal weighing delay	62
9.3	Power requirements	62
9.4	Physical specifications	62
9.5	Environmental specifications	63
9.6	Connector Specifications	63
9.7	Wireless Specifications	63
<b>10.0</b>	<b>Appendix B: Legal information</b>	<b>64</b>

# 1.0 Welcome

Thank-you for purchasing this Loadrite Weighing System. Please read this manual carefully before using the for the first time. Keep this manual in a safe place and use as your first point of reference.

## Formatting

The following formatting in this manual identifies specific types of information:

Convention	Type of Information
<b>Bold</b>	<ul style="list-style-type: none"> <li>▪ Indicates a button on the Indicator, or</li> <li>▪ Indicates an area displayed on-screen, including buttons, headings, field names and options.</li> </ul>
<i>Italics</i>	<ul style="list-style-type: none"> <li>▪ Indicates the name of a screen or window, or</li> <li>▪ Indicates a software function, or</li> <li>▪ Indicates an operation mode that the Indicator can be set to.</li> </ul>
Monospace	<ul style="list-style-type: none"> <li>▪ The exact error message displayed on-screen, or</li> <li>▪ The exact text to be entered.</li> </ul>

## Action Terms

The following terms are used throughout this manual to describe actions:

Term	Description
<b>Tap</b>	Press and release a button, menu option or other item on the touchscreen.
<b>Press</b>	Push and release a button.
<b>Swipe</b>	Tap an item on the touchscreen and quickly move to the left or right before releasing.

## 2.0 Introduction

The L5000 Loadrite weighing system measures the weight of loads lifted by wheel loaders and similar machines that use hydraulic rams to lift the load. The main parts of the weighing system are:

- the Indicator installed in the cab of the loader, and
- the connected sensors installed on the lifting arms.

As a load is lifted, the angle sensors and hydraulic pressure transducers send information to the Indicator. This information is converted into a digital weight reading that is displayed on the Indicator screen.

The Indicator is the main user interface with the Loadrite weighing system. It has an internal memory that stores settings and production data even when it is turned off.



## 2.1 Loadrite-equipped loader

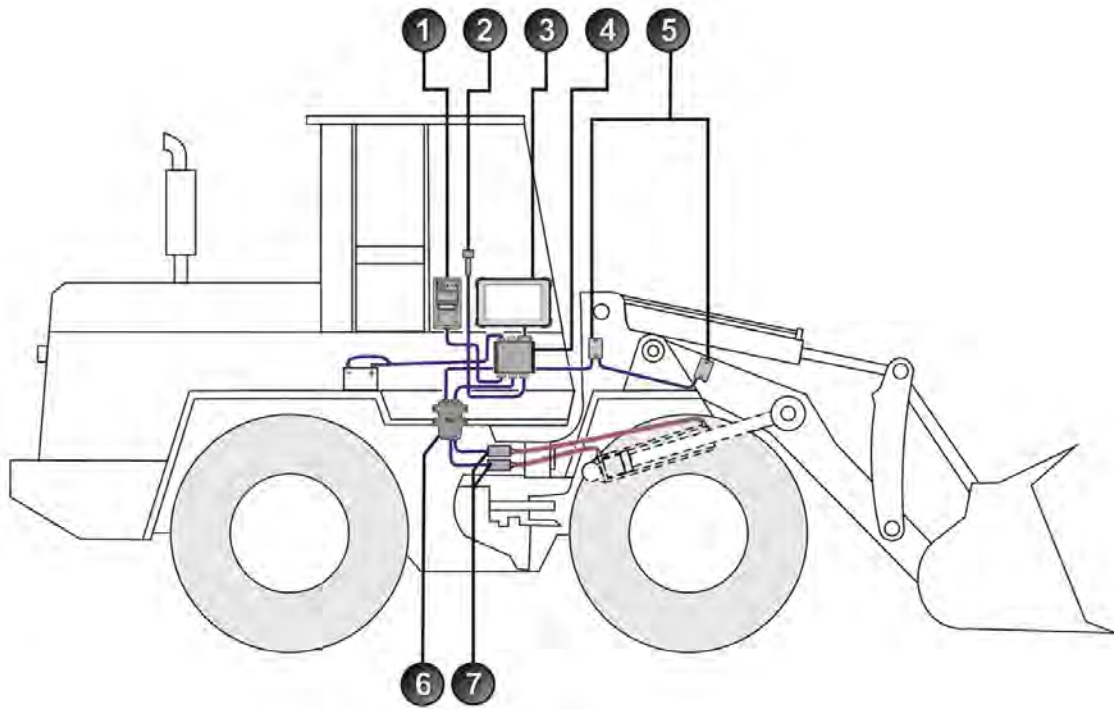

Item	Description
1	Printer (optional)
2	Remote Add Button (optional)
3	Loadrite L5000 Indicator (LT70)
4	Power Module (LM10)
5	2x Angle Sensors
6	Pressure Transducer Interface (PTI2)
7	2x Pressure Transducers



## 2.2 Indicator features

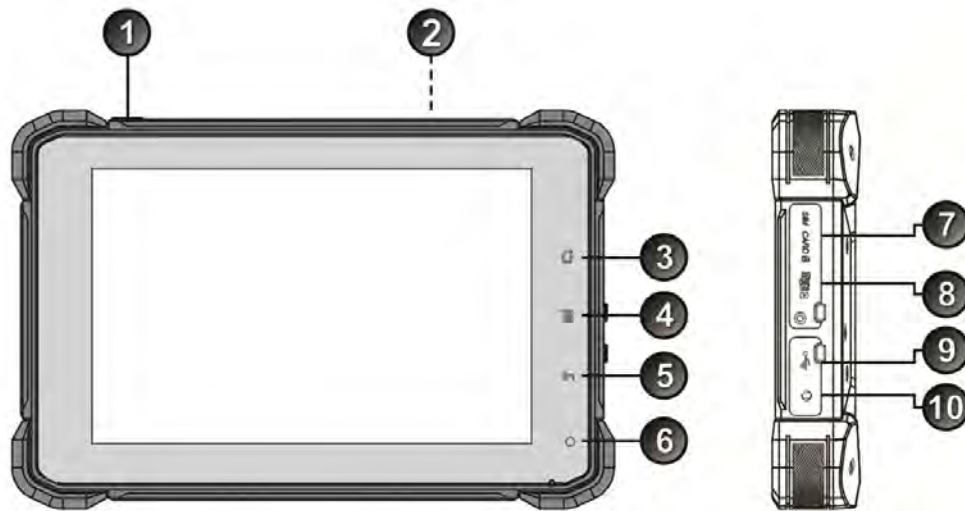





Item	Name	Description
1	Standby	Press to enter or exit <i>Standby</i> mode.
2	Speaker	Broadcasts buzzer and other sounds.
3	Home	Press to return to the <i>Total</i> screen.
4	Settings	Press to display the <i>Settings</i> screen.
5	Back	Press to return to the previous screen.
6	Green light	When lit, indicates that power is on.
7	SIM card slot	Slot for a SIM card, for connecting to a cellular network, if required.
8	Micro SD card slot	This slot is not used.
9	USB socket	This socket is not used.
10	Headphone socket	This socket is not used.

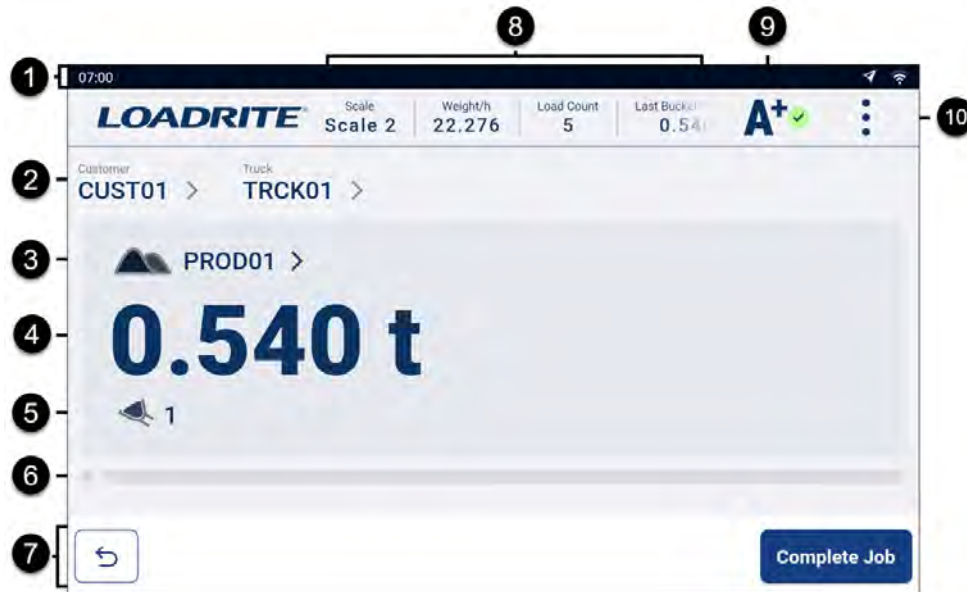

## 2.3 Total screen

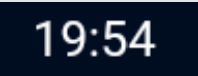

The *Total* screen is the first screen that you will see when you turn on the Indicator.



From this screen, you can weigh a bucketload, undo a bucketload, change data list values (product, customer, truck, etc), access the *More Options* menu, and switch to *Target Weighing* mode or *Split Weighing* mode.



Item	Name	Description
1	Notification bar	<p>The following icons may display in the <b>Notification bar</b>:</p> <div style="display: flex; flex-direction: column; gap: 10px;"> <div style="display: flex; align-items: center;">  <div style="margin-left: 10px;"> <p><b>Current time</b></p> </div> </div> <div style="display: flex; align-items: center;">  <div style="margin-left: 10px;"> <p><b>GPS status</b></p> <ul style="list-style-type: none"> <li>▪ White: A GPS fix has been obtained.</li> <li>▪ Gray: No GPS fix.</li> </ul> </div> </div> <div style="display: flex; align-items: center;">  <div style="margin-left: 10px;"> <p><b>InsightHQ connection status</b></p> <ul style="list-style-type: none"> <li>▪ White: Connected to InsightHQ.</li> <li>▪ Gray: Not connected to InsightHQ.</li> <li>▪ No icon: The connection to InsightHQ is turned off.</li> </ul> </div> </div> <div style="display: flex; align-items: center;">  <div style="margin-left: 10px;"> <p><b>LG500 status</b></p> <ul style="list-style-type: none"> <li>▪ White: Connected to LG500.</li> <li>▪ Gray: Not connected to LG500.</li> <li>▪ No icon: The connection to LG500 is turned off.</li> </ul> </div> </div> </div>

Item	Name	Description
		 <p><b>WiFi connection status</b></p> <ul style="list-style-type: none"> <li>White: Connected to a network via WiFi. The strength of the connection is indicated by the number of curved white bars.</li> <li>Gray with white X: Not connected to a network via WiFi.</li> <li>No icon: WiFi is turned off.</li> </ul> <p><b>Cellular connection status</b></p>  <ul style="list-style-type: none"> <li>White: Connected to a cellular network via a SIM card. The strength of the connection is indicated by the number of white bars.</li> <li>Gray with white X: Not connected to a cellular network as out of range.</li> <li>No icon: Cellular is turned off.</li> </ul>
2	<b>Data lists</b>	<p>Displays the currently selected value of each data list (data lists 2 to 9), such as customer or truck. The number of data list values displayed will depend on your configuration.</p> <ul style="list-style-type: none"> <li>Swipe left or right to display more data list values, if they don't all appear on-screen.</li> <li>To change a data list value (such as the customer), tap the value to display the corresponding selection screen. For more information, see "Select a data list value" on page 26.</li> </ul>
3	<b>Product</b>	<p>Displays the currently selected product (data list 1).</p> <ul style="list-style-type: none"> <li>To change the product, tap the value to display the <i>Select Product</i> screen. For more information, see "Customizable data lists" on page 26.</li> </ul> <div style="border: 1px solid blue; padding: 5px; margin-top: 10px;"> <p><b>NOTE</b> – If data list 1 is not enabled, the next enabled data list will display, for example, customer, truck, etc.</p> </div>
4	<b>Total</b>	<p>The current total amount of product that has been loaded.</p>
5	<b>Bucketloads</b>	<p>The number of bucketloads that have been added to the total.</p>
6	<b>Weighing progress bar</b>	<p>Indicates the position of the boom while weighing a bucketload.</p>
7	<b>Action bar</b>	<p>The <b>Action bar</b> displays buttons for you to choose from to perform weighing actions. The following are some of the buttons that may display here:</p> <div style="border: 1px solid blue; padding: 5px; display: inline-block; margin-right: 10px;">  </div> <p><b>Undo</b> Tap to undo the previous bucketload and remove it from the total.</p> <ul style="list-style-type: none"> <li>For more information, see "Undo/Redo" on page 42.</li> </ul>

Item	Name	Description
		<div data-bbox="571 344 659 421" style="border: 1px solid black; padding: 5px; margin-bottom: 10px;"></div> <div data-bbox="571 517 716 593" style="border: 1px solid black; padding: 5px; margin-bottom: 10px;"><b>0</b></div> <div data-bbox="571 689 716 766" style="border: 1px solid black; padding: 5px; margin-bottom: 10px;"></div> <div data-bbox="571 913 748 990" style="background-color: #0056b3; color: white; padding: 5px; margin-bottom: 10px;"><b>Add bucket</b></div> <div data-bbox="571 1115 716 1191" style="border: 1px solid black; padding: 5px; margin-bottom: 10px;"><b>Subtract</b></div> <div data-bbox="571 1317 772 1393" style="background-color: #0056b3; color: white; padding: 5px; margin-bottom: 10px;"><b>Complete job</b></div> <div data-bbox="571 1518 697 1594" style="border: 1px solid black; padding: 5px;"><b>Cancel</b></div> <p><b>Split</b> Tap to split the load between a truck and trailer.</p> <ul style="list-style-type: none"> <li>For more information, see "<i>Split Weighing mode</i>" on page 31.</li> </ul> <p><b>Zero</b> Tap to zero the empty bucket.</p> <ul style="list-style-type: none"> <li>For more information, see "<i>How do I zero the empty bucket?</i>" on page 37.</li> </ul> <p><b>Loadrite 360 Jobs</b> Indicates the number of trucks waiting to be loaded. Tap to display the <i>Jobs</i> screen.</p> <ul style="list-style-type: none"> <li>For more information, see "<i>Loadrite 360 Job Management</i>" on page 34.</li> </ul> <p><b>Add Bucket</b> Tap to add the weighed bucketload to the total.</p> <ul style="list-style-type: none"> <li>For more information, see "<i>How do I weigh and add a bucketload?</i>" on page 21.</li> </ul> <p><b>Subtract</b> Tap to subtract the current bucketload from the total.</p> <ul style="list-style-type: none"> <li>For more information, see "<i>Subtract a bucketload</i>" on page 42.</li> </ul> <p><b>Complete Job</b> Tap to complete the job (also known as <i>clearing the total</i>).</p> <ul style="list-style-type: none"> <li>For more information, see "<i>How do I complete the load?</i>" on page 24.</li> </ul> <p><b>Cancel</b> Tap to cancel the current action.</p>
<b>8</b>	<b>Display Metrics</b>	<p>Displays up to four (4) metrics that are customized using the <i>Display Metrics</i> screen. If more than one scale is configured, then one of the <b>Display Metrics</b> fields may display the current scale.</p> <ul style="list-style-type: none"> <li>If all metrics are not displaying, swipe the metrics to scroll through the fields.</li> <li>To view full details of a metric, tap the value to display the corresponding <i>Metrics</i> screen.</li> <li>To change the scale being used, tap the current scale to display the <i>Scale</i> screen.</li> <li>To configure the <b>Display Metrics</b>, see "<i>Display Metrics</i>" on page 55.</li> </ul>

Item	Name	Description
9	Auto-Add	<p>Displays the status of Auto-Add functionality. Depending on your configuration, you may be able to toggle Auto-Add between active and inactive by tapping the icon.</p> <ul style="list-style-type: none"> <li>For more information, see "<i>What is Auto-Add?</i>" on page 41.</li> </ul> <div style="display: flex; justify-content: space-between;"> <div style="text-align: center;">  </div> <div> <p><b>Auto-Add active</b> Indicates that Auto-Add is active.</p> </div> </div> <div style="display: flex; justify-content: space-between;"> <div style="text-align: center;">  </div> <div> <p><b>Auto-Add inactive</b> Indicates that Auto-Add is off.</p> </div> </div> <div style="display: flex; justify-content: space-between;"> <div style="text-align: center;"> <p>[No icon]</p> </div> <div> <p><b>Auto-Add disabled</b> Indicates that Auto-Add is disabled.</p> </div> </div>
10	More Options	<p>Displays the <i>More Options</i> menu.</p> <ul style="list-style-type: none"> <li>For more information, see "<i>More Options menu</i>" on page 44.</li> </ul>

## 2.4 Accurate weighing

For maximum accuracy, ensure that:

- Check Zero is performed regularly.
- The load-lifting motion is steady and smooth, with no acceleration or bounce.
- The bucket is fully rolled-back during the lift.
- The loader is on level ground.

### 2.4.1 Obtaining the best weighing results

#### Lifting speed

For best results, operate the lift lever before accelerating the engine so that the machine does not rock as it lifts, i.e. use normal revs.

#### Trigger Point

Start the lift well below the Trigger Point. This ensures that all acceleration and load bounce has been eliminated well before the weighing sequence begins.

**NOTE** – We recommend that there are at least two seconds of lift before the Trigger Point.

#### Bounce

Most loaders have pneumatic tires which can cause the machine to bounce when lifting.

To minimize the effect of bounce, always operate the lift lever before accelerating the engine and start the lift well below the Trigger Point.

#### Center of gravity

The hydraulic pressure in the lifting cylinders depends on where the center of gravity of the load is. It is important that the bucket is always in the same position: fully rolled back.

### 2.4.2 Legal for Trade systems

Loadrite systems meet Legal for Trade requirements in certain countries. This enables material to be weighed and sold directly from the loader.

For more information or to enquire if Legal for Trade is available in your country, contact your Loadrite distributor.



**TIP** – Operating requirements for Legal for Trade systems are detailed in this manual where they differ from standard operating requirements.

# 3.0 The day-to-day weighing process

The following is the basic process for day-to-day weighing with the Loadrite Weighing System:

1. Turn on the Indicator .
2. Perform the required warm-up lifts.
3. Zero the empty bucket.
4. Select a product to weigh (optional).
5. Select the customer associated with the product (optional).
6. Weigh and add each bucketload.
7. When you have finished loading the truck, tap **Complete Job**.  
If a printer is connected, the loader's totals will be printed and payload data will be sent to InsightHQ.

## 3.1 How do I turn on the Indicator?

The Loadrite Indicator will turn on automatically when you start the loader.

## 3.2 How do I perform a warm-up?

For best weighing accuracy, the hydraulic fluid in the lift cylinders should be at normal operating temperature. This is achieved by raising and lowering the empty bucket.

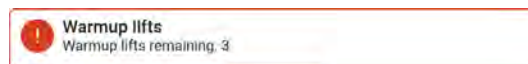

The above message will display if the Indicator has been turned off for more than one hour. If you see the above message, you need to raise and then lower the empty bucket past the Trigger Point three (3) times (the default number of warm-up lifts is three, but it may be set between 1 - 99 lifts at your site):

1. Raise the bucket past the Trigger Point.  
Progress will be shown by a green bar.
2. Lower the bucket past the Trigger Point.  
A tick will display to indicate that the warm-up lift was successful.
3. Repeat two (2) more times until the message disappears.  
When the warm-up has completed, the *Total* screen will display.

### 3.3 How do I select a scale?

**NOTE** – This step does not need to be completed if there is only one scale available. A scale only needs to be selected if more than one scale are configured.

- 1. Ensure that the *Total* screen is displayed.
- 2. Complete one of the following:

Option 1 - More Options Menu	Option 2 - Display Metrics
<p><b>NOTE</b> – The <b>Scale</b> option is only available on the <i>More Options</i> menu if multiple scales have been configured at installation.</p> <ul style="list-style-type: none"><li>a. Tap . The <i>More Options Menu</i> will display.</li><li>b. Tap <b>Scale</b>. The <i>Select Scale</i> screen will display.</li></ul>	<p><b>NOTE</b> – Only available if <b>Scale</b> has been selected to display in the <b>Display Metrics</b> area.</p> <ul style="list-style-type: none"><li>a. In the <b>Display Metrics</b> area, tap the scale. The <i>Select Scale</i> screen will display.</li></ul>

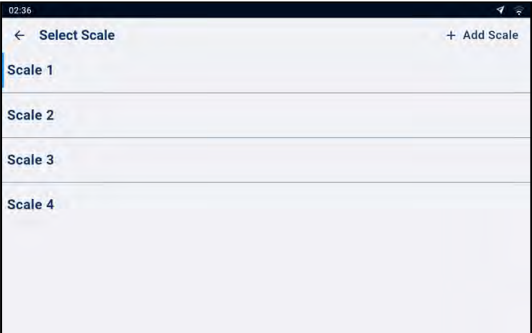

- 3. Tap the required scale. The *Total* screen will display. All bucketloads will now be recorded as having been lifted using the selected scale until a different scale is selected.



## 3.4 How do I zero the empty bucket?

The **Check Zero** functionality is only active if configured at installation.

It is necessary to periodically "zero" the bucket because small errors can occur due to a build-up of material in the bucket.



If you see the above message, you need to zero the empty bucket.

**IMPORTANT – Legal For Trade systems:** You must zero the bucket before beginning each new load.

**IMPORTANT –** When zeroing the Indicator, the bucket must be empty and kept fully-rolled back.

Complete the following to zero the bucket:

1. Ensure that the loader is level and the bucket is empty.
2. Roll the bucket backwards.
3. Lower the bucket to the lowest position.
4. Raise the empty bucket.
5. Tap .

The **Zero Updated** message will display, before the *Total* screen is displayed.

**NOTE –** If  is not displayed, the bucket is not empty enough. Empty the bucket, then return to step 1.

## 3.5 How do I select a product to weigh?

It is important to ensure that the correct product is chosen before you begin to weigh it. Complete the following to select the product:

1. Ensure that the *Total* screen is displayed.
2. Tap the **Product** data list value.  
The *Select Product* screen will display.

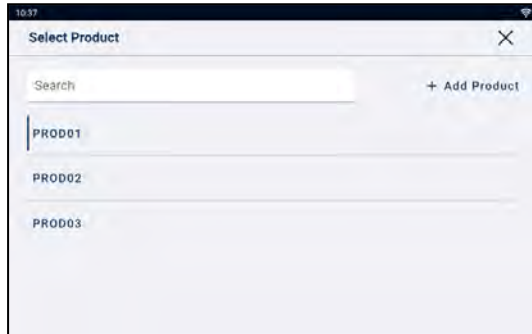

3. Tap the product that you are weighing.
  - To reduce the number of listed products, tap the **Search** box, then enter characters from the product name. The list will reduce to only show those that match your search.

The *Total* screen will redisplay with the new product shown. All bucketloads will be recorded against the selected product until a different product is selected.

**TIP** – Depending on the workflow that has been selected at installation, each product may have its own short total, and changing the product will also change the short total that is displayed on the *Total* screen.

### How do I add a new product?

**You can only add a new product if enabled at installation.**

If the product you are weighing is not listed on the *Select Product* screen, complete the following to add it to the list:

1. Tap **+ Add Product**.  
The *Add Product* screen will display.
2. Tap the **Enter new Data Item** box, then use the on-screen keyboard to enter the name of the product.
3. Tap .  
The *Select Product* screen will re-display with the new product at the bottom of the list. The new product will be automatically assigned to the next load.

## 3.6 How do I select a customer?

**You can only select a customer if the *Customer* data list has been configured and enabled at installation.**

**NOTE** – If your Indicator is configured to use *Data Prompt* functionality, then after selecting an item, you will be prompted to also select from all other Data Lists that follow.

From the *Total* screen, complete the following:

1. Tap the **Customer** data list value.  
The *Select Customer* screen will display.



2. Tap the customer that you are weighing product for.
  - To reduce the number of listed customers, tap the **Search** box, then enter characters from the customer name. The list will reduce to only show those that match your search.

The *Total* screen will redisplay with the new customer shown. All bucketloads will be recorded against the selected customer until a different customer is selected.

### How do I add a new customer?

**You can only add a new customer if enabled at installation.**

If the customer you are weighing is not listed on the *Select Customer* screen, complete the following to add it to the list:

1. Tap **+ Add Customer**.  
The *Add Customer* screen will display.
2. Tap the **Enter new Data Item** box, then use the on-screen keyboard to enter the name of the customer.
3. Tap .  
The *Select Customer* screen will re-display with the new customer at the bottom of the list. The new customer will be automatically assigned to the next load.

## 3.7 How do I select a truck to load?

**You can only select a truck if the *Truck* data list has been configured and enabled at installation.**

1. Ensure that the *Total* screen is displayed.
2. Tap the **Truck** data list value.  
The *Select Truck* screen will display.



3. Tap the truck that you are loading.
  - To reduce the number of listed trucks, tap the **Search** box, then enter characters from the truck title. The list will reduce to only show those that match your search.

The *Total* screen will re-display with the new truck shown. All bucketloads will be recorded against the selected truck until a different truck is selected.

### How do I add a new truck?

**You can only add a new truck if enabled at installation.**

If the truck you are weighing is not listed on the *Select Truck* screen, complete the following to add it to the list:

1. Tap **+ Add Truck**.  
The *Add Truck* screen will display.
2. Tap the **Enter new Data Item** box, then use the on-screen keyboard to enter the name of the truck.
3. Tap .  
The *Select Truck* screen will re-display with the new truck at the bottom of the list. The new truck will be automatically assigned to the next load.

## 3.8 How do I weigh and add a bucketload?

When the *Total* screen is displayed, bucketloads can be weighed.

1. While keeping the bucket fully-rolled back, raise a bucketload of product smoothly through the Trigger Point using constant engine revs.

**IMPORTANT – Legal For Trade systems:** You must keep the bucket fully-rolled back while lifting a bucketload, or a **Bucket not emptied** message will be displayed, and the bucketload will not be recorded.

If *Weight Preview* functionality is enabled, a preview of the weight will display during the lift:

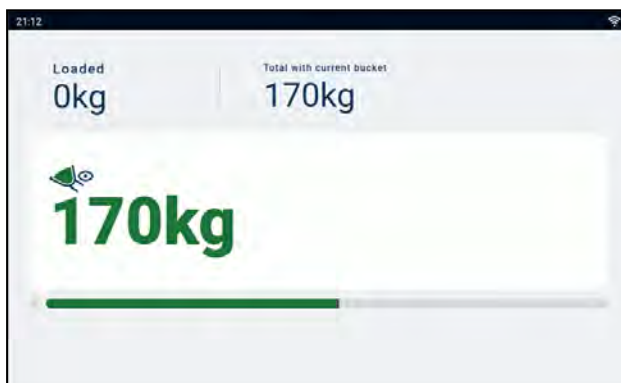

2. When the bucketload has been weighed, the Indicator will beep and the *Live Weight* screen will display the following:
  - the weight of the current bucketload,
  - the total amount of product that has been loaded,
  - the new total if the bucketload is added.

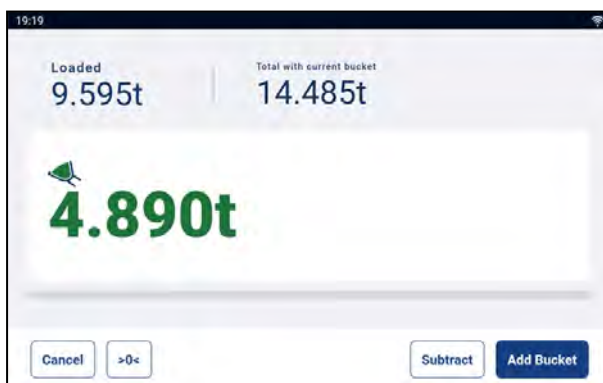

3. Tap **Add Bucket** to add the bucketload to the total.

**NOTE –** If **Add Bucket** is not tapped within 8 (eight) seconds of the load being lifted past the Trigger Point, the Indicator will beep and the **Weight Discarded** message will display. The weight will then be discarded and the *Total* screen will display.

When the bucketload has been added, the *Total* screen will display with the new total and the number of added bucketloads.

4. Empty the bucketload in to the truck.

**IMPORTANT – Legal For Trade systems:** Depending on your region, you may need to keep the bucket fully-rolled forward when emptying, or the bucketload will not be recorded.

## 3.8.1 Remote Buttons

The Loadrite weighing system supports optional remote buttons. Remote buttons are positioned for your convenience, such as on or near the lift lever, or wired into the horn.

Depending on configuration, pressing a remote button may add a bucketload, complete the load, zero the bucket, or split the load.

Remote buttons can be used interchangeably with the standard buttons on the Indicator.



## 3.8.2 What is Auto-Add?

The *Auto-Add* functionality is only available if enabled at installation.

The *Loadrite* weighing system can be set to automatically add a bucketload when lifted past the Trigger Point for a specified number of seconds. This means that you don't need to tap **Add Bucket** after lifting each load.

If Auto-Add is enabled, an icon will display on the *Total* screen.

The following may apply depending on how *Auto-Add* functionality was configured at installation:

- Bucket loads may not be added if under a specified amount, or is considered to be a *poor lift* or *bad lift*.
- *Auto-Add* may be turned on or off (toggled) by tapping **A<sup>+</sup>** on the *Total* screen.

### 3.8.2.1 Auto-Add toggle

The *Auto-Add toggle* functionality is only available if enabled at installation.

You can toggle between using *Auto-Add* or manually adding lifted weights by tapping **A<sup>+</sup>** on the *Total* screen.

### 3.8.3 Subtract a bucketload

This *Subtract* function can be useful when only part of a final load of loose material is required. To subtract a bucketload complete the following:

1. Weigh and add a full bucketload as per normal, *but only tip the required amount of material into the truck.*
2. Re-weigh the bucket containing the remaining material, *but do not add the bucketload.*
3. Tap **Subtract**.  
The **Bucket Subtract** message will display. The re-weighed amount will be subtracted from the total, meaning that only the amount tipped in step 1 was added. The *Total* screen will re-display.

### 3.8.4 Undo/Redo

The *Undo* function allows you to correct mistakes by “undoing” the previous bucketload and removing it from the total. You can then “redo” the bucketload if you need to, in effect toggling between “undo” and “redo”.

You can also “undo” a discarded weight. For example, if you lift a bucketload but take more than 8 seconds to

tap **Add Bucket**, the weight will be discarded; but if you then tap , the *Live Weight* screen will reappear and you will have the option to add the weight again.

#### 3.8.4.1 Undoing a bucketload

To *undo* the previous bucketload, complete the following:

- Tap .  
The message **Undoing previous action** will display, then the *Total* screen will display a new total that doesn't include the previous bucketload.

#### Redoing a bucketload

To *redo* the undone bucketload, complete the following:

- Tap  again.  
The message **Undoing previous action** will display, then the *Total* screen will display a new total that includes the previous bucketload.

You can continue to tap  to toggle between undoing and redoing the bucketload.

#### 3.8.4.2 Undoing a discarded weight

After the **Discarded Weight** message has displayed, the *Total* screen will display. To *undo* the discarded weight, complete the following:

1. Tap .  
The discarded weight is canceled and the *Live Weight* screen will display the following:
  - the weight of the current bucketload,
  - the total amount of product that has been loaded,
  - the new total if the bucketload is added.

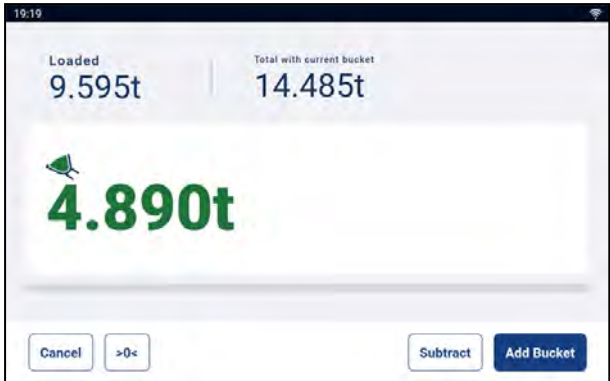

- 2. Tap **Add Bucket** to add the bucketload to the total.

### 3.9 How do I complete the load?

When you have finished adding bucketloads to the truck, you must clear the total.

To clear the total, complete the following:

- 1. Tap **Complete Job**.
  - If the *Review* screen displays, review the values set against each data list, then complete the following:

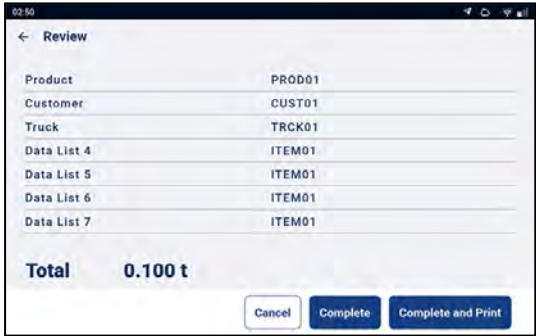

If...	Then...
a data list value is incorrect	<ul style="list-style-type: none"> <li>▪ Tap the data list value. The <i>Select n</i> screen will display, for example, <i>Select Customer</i> or <i>Select Product</i>.</li> <li>▪ Tap the correct value for the data list. The <i>Review</i> screen will redisplay with the correct data list value displayed.</li> <li>▪ Repeat for each incorrect data list.</li> </ul>
all data list values are all correct	Tap <b>Complete</b> .
all data list values are all correct and you would like to print ticket	Tap <b>Confirm and Print</b> .



If...	Then...
	<p><b>NOTE</b> – The <b>Complete and Print</b> button will only display if a printer has been configured.</p>

The *Total* screen will show the total reset to **0**.

Depending on the configuration at installation, the following may happen:

- weighing data is sent to InsightHQ,
- one or more tickets are printed.
- you are prompted to select a value for each data list.

**IMPORTANT – Legal For Trade systems:** You must zero the bucket before beginning a new load.

### 3.10 How do I turn off the Indicator?

If you are not going to use the Loadrite Indicator for a while, you can put it into *Standby* mode by pressing the red power button. Press it again to exit *Standby* mode.

The Indicator will completely turn off when you turn off the loader.

# 4.0 Customizable data lists

**The *Customizable Data Lists* functionality is only available if selected at installation.**

Your Indicator has nine customizable data lists that are used to record information against each weight to help track and monitor weighing data. For example, data lists may be configured to record a customer, truck typetruck ID, against the weight data. The data can then be transferred to InsightHQ via a Wi-Fi network and/or printed along with the weight data.

## 4.1 Select a data list value

Data field values, such as Product, Truck, Customer, etc., can be changed before starting a new load. The following example shows how to select a *Product* to record against the weighing data. Other data list values can be selected in the same way.

1. Ensure that the *Total* screen is displayed.
2. Tap the **Product** data list value.  
The *Select Product* screen will display.

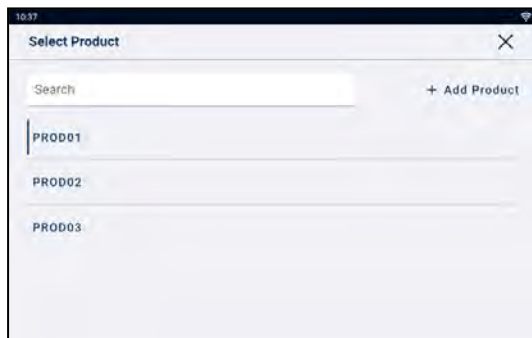

3. Tap the product that you are weighing.
  - To reduce the number of listed products, tap the **Search** box, then enter characters from the product name. The list will reduce to only show those that match your search.

The *Total* screen will redisplay with the new product shown. All bucketloads will be recorded against the selected product until a different product is selected.

## 4.2 Add a new data list value

**New values can only be added to a Data List if it has been configured to allow them.**

If the data list value that you need is not in the data list, then you can add the value using the keypad.

**TIP** – Multiple data list values can be added in .CSV or .TXT format using the *L5000 Web Interface*

**NOTE** – Data field values can only be entered using specific *Western Latin* characters, such as in English.

The following example shows how to add a new *product* to the data list. Other data list values are added in the same way.

1. Ensure the *Total* screen is displayed.
2. Tap the **Product** data list value.  
The *Select Product* screen will display.
3. Tap **+ Add Product**.  
The *Add Product* screen will display.

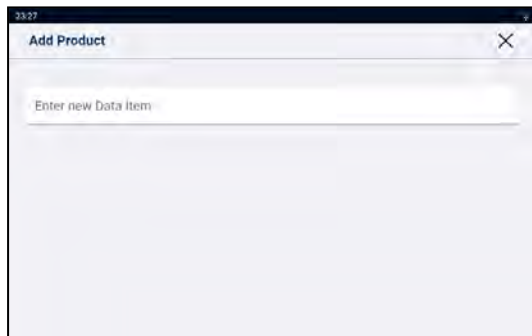

4. Tap the **Enter new Data Item** box, then use the on-screen keyboard to enter the name of the product.
5. Tap .  
The *Select Product* screen will re-display with the new product at the bottom of the list. The new product will be automatically assigned to the next load.

**IMPORTANT** – For sites that synchronize data using InsightHQ, the new data field value may be deleted from the Indicator if it is not assigned to a load before the next synchronization. Therefore it is best practice to create a new data field value just prior to it being used for a load, rather than creating multiple data field values in advance.

## 4.3 Delete a data list value

**Data List values can only be deleted if the Data List that has been configured to allow it.**

You can delete data list value that is no longer required. The following example shows how to delete a *product* from the data list. Other data list values are deleted in the same way.

**IMPORTANT** – For sites that synchronize data using InsightHQ, a deleted data field may reappear on the Indicator during the next synchronization. Therefore it is best practice to delete data field values from InsightHQ, rather than from the Indicator.

1. Ensure the *Total* screen is displayed.
2. Tap the **Product** data list value.  
The *Select Product* screen will display.

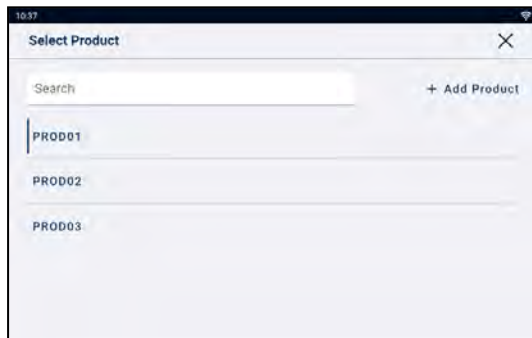

3. Swipe the data list value to the left, then tap .  
The *Product* screen will re-display with the deleted value removed from the list.

# 5.0 Target Weighing mode

**Target Weighing mode is only available if enabled at installation.**

*Target Weighing* mode provides a simple way to load a truck to a predefined target weight using a series of bucketloads. It is typically used when loading a truck to its optimum payload.

Before loading, enter a target weight value. Each time a bucketload is added, the target value is reduced by that amount.

- For using *Target Weighing* with multiple vehicle units (such as a truck and trailer), see "*Using Split Weighing mode within Target Weighing mode*" on page 32.

## 5.1 How do I enter *Target Weighing* mode and input a target?

**IMPORTANT – Legal For Trade systems:** You must zero the bucket before beginning a new load.

- Tap  to open the **More Options** menu.
- Tap **Add a target**.  
The *Add target* screen will display.

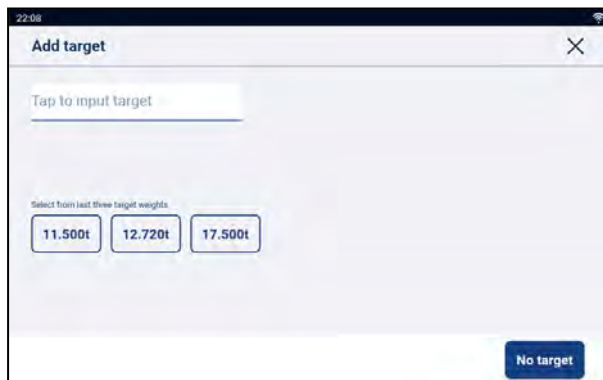

- Tap the **Tap to input target** box, then use the on-screen keyboard to enter the target weight value, then tap , or tap a previous target weight, if displayed.  
The *Total* screen will re-display in *Target Weighing* mode.

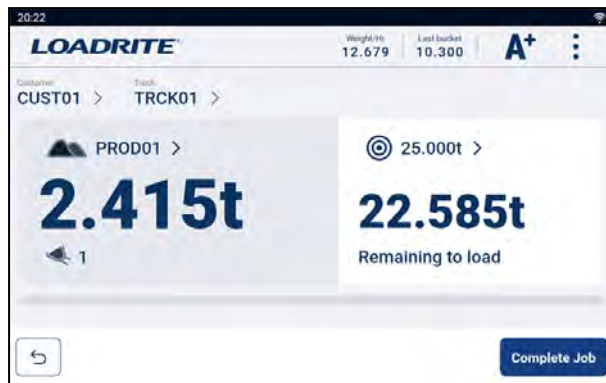

4. While keeping the bucket fully-rolled back, raise a bucketload of product smoothly through the Trigger Point using constant engine revs.
5. When the bucketload has been weighed, the Indicator will beep and the *Live Weight* screen will display the following:
  - the target weight (**Remaining weight**),
  - the current bucketload,
  - the new target weight, if the bucketload is added to the truck (**Remaining to load**).

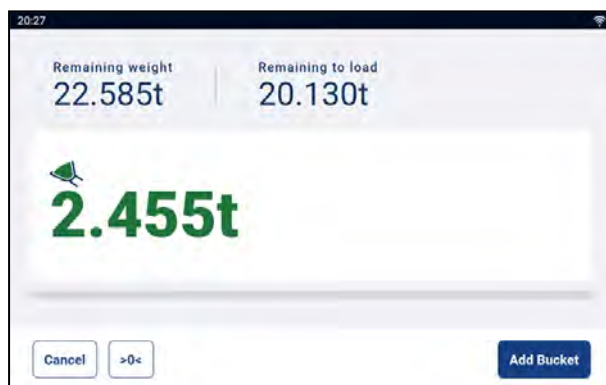

7. Tap **Add Bucket** to add the bucketload to the truck.
8. Empty the bucketload in to the truck.
9. Repeat steps 5-8 until the target weight is as close to **0** (zero) as possible.

**IMPORTANT – Legal For Trade systems:** You must zero the bucket before beginning a new load.

## 5.2 How do I return to *Total* mode?

To return to *Total* mode from *Target Weighing* mode, the target must be set to **0** (zero).

1. Tap .
2. Tap **No target**.  
The *Total* screen will re-display in *Total* mode.

# 6.0 Split Weighing mode

**Split Weighing mode is only available if enabled at installation**

*Split Weighing* mode splits the total weight into multiple sub-totals, providing an easy way to load train wagons, or a truck and trailer. *Split Weighing* mode is also used to track load distribution over a single vehicle unit, to avoid overloading an axle.

*Split Weighing* mode can be used in conjunction with *Total* or *Target Weighing* modes.

## Example of Split Weighing



A truck with a trailer requires loading. The truck can carry 10,000 tonnes and the trailer 15,000 tonnes, making a total of 25,000 tonnes. First load the truck, then use *Split Weighing* mode to load the trailer.

## 6.1 Using *Split Weighing* mode within *Total* mode

1. In *Total* mode, load the truck with the required amount or product.
2. When the required amount of product for the truck is reached, tap  to load the trailer.

The grand total of the entire vehicle is shown, along with the short total for the trailer.

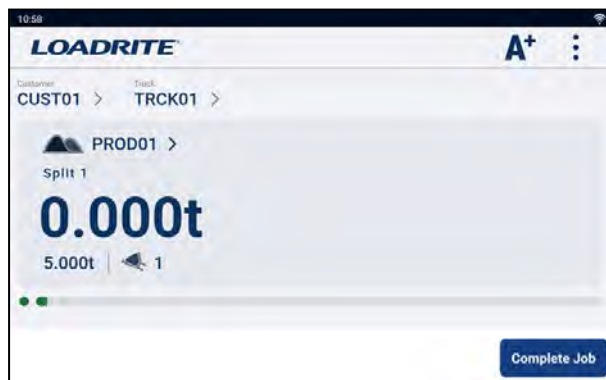



3. Add the required amount of product to the trailer.  
As each bucketload is lifted, the bucket weight, current trailer weight and total trailer weight will display. Between each lift, the *Split Mode* screen will display the new total and number of buckets lifted.

4. Tap **Complete Job**.
5. If you would like to split the load to another trailer, tap , then go back to step 3; Otherwise, continue to step 6.
6. When all trailers have been filled, tap **Complete Job** to clear the totals. The *Total* screen will display.

## 6.2 Using *Split Weighing* mode within *Target Weighing* mode

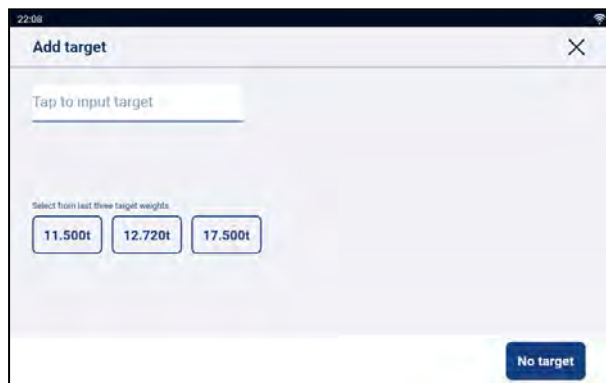
1. Use *Target Weighing* mode to set a target weight and load the truck.
  - For information on *Target Weighing* mode, see "*Target Weighing mode*" on page 29.
2. When the required amount of product for the truck is reached, tap . The *Add target* screen will display for the trailer.



3. Tap the **Tap to input target** box, then use the on-screen keyboard to enter the target weight value for the trailer, then tap ; or tap a previous target weight, if displayed. The *Total* screen will re-display, showing the target for the trailer.
4. While keeping the bucket fully-rolled back, raise a bucketload of product smoothly past the Trigger Point using constant engine revs. If *Weight Preview* functionality is enabled, a preview of the weight will display during the lift:

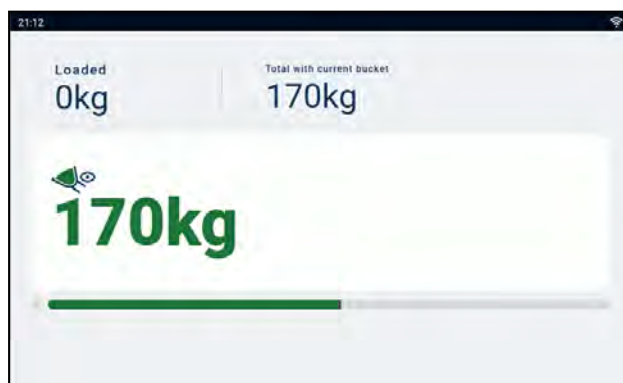



5. When the bucketload has been weighed, the Indicator will beep, the message **Weighing Complete** will display, and the *Live Weight* screen will display the following:
  - the target weight (**Remaining weight**),
  - the current bucketload,
  - the new target weight, if the bucketload is added to the trailer (**Remaining to load**).

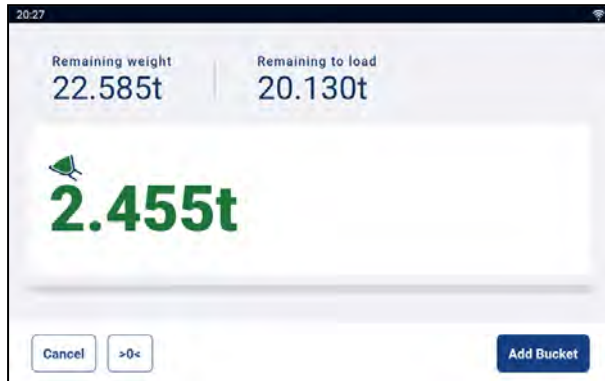

6. Tap **Add Bucket** to add the bucketload to the trailer.
7. Empty the bucketload in to the trailer.
8. Repeat steps 4-7 until the target weight is as close to **0** (zero) as possible.
9. Repeat this procedure from step 2 for each additional trailer.
10. When all trailers have been filled, tap **Complete Job** to clear the totals. The *Total* screen will re-display.

# 7.0 Loadrite 360 Job Management

***Loadrite 360 Job Management* is a purchased add-on feature and only available if your site is configured to use it. Contact your Loadrite dealer for more information.**

The *Loadrite 360 Job Management* process streamlines truck cycle times, ensuring that orders are filled correctly. Automatic sharing of ticketing information across the site prevents costly mistakes by ensuring that the correct product is loaded onto each truck. Staff can view how long each truck has been on site and ensure that they are loaded quickly.

Loadrite 360 jobs are entered using *Loadrite Communications Interface (LCI)* at the office. Loader operators can view a list of jobs for their zone, select the truck to load, then load it with the correct product to a specified weight.



The following is the basic process for day-to-day weighing with *Loadrite 360 Job Management*:

1. Turn on the Indicator.
2. Perform the required warm-up lifts.
3. Select the scale that is attached to the loader.
4. Zero the empty bucket.
5. Select a job.
6. Weigh and add each bucketload.
7. When you have finished loading the truck, clear the total. The payload data will be sent to *Loadrite Communications Interface (LCI)* at the office, where a ticket can be printed for the truck driver.

## 7.1 How do I turn on the Indicator?

The Loadrite Indicator will turn on automatically when you start the loader.

## 7.2 How do I perform a warm-up?

For best weighing accuracy, the hydraulic fluid in the lift cylinders should be at normal operating temperature. This is achieved by raising and lowering the empty bucket.

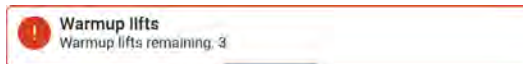

The above message will display if the Indicator has been turned off for more than one hour. If you see the above message, you need to raise and then lower the empty bucket past the Trigger Point three (3) times (the default number of warm-up lifts is three, but it may be set between 1 - 99 lifts at your site):

1. Raise the bucket past the Trigger Point.  
Progress will be shown by a green bar.
2. Lower the bucket past the Trigger Point.  
A tick will display to indicate that the warm-up lift was successful.
3. Repeat two (2) more times until the message disappears.  
When the warm-up has completed, the *Total* screen will display.

## 7.3 How do I select a scale?

**NOTE** – This step does not need to be completed if there is only one scale available. A scale only needs to be selected if more than one scale are configured.

1. Ensure that the *Total* screen is displayed.
2. Complete one of the following:

### Option 1 - More Options Menu

**NOTE** – The **Scale** option is only available on the *More Options* menu if multiple scales have been configured at installation.

- a. Tap .  
The *More Options Menu* will display.
- b. Tap **Scale**.  
The *Select Scale* screen will display.

### Option 2 - Display Metrics

**NOTE** – Only available if **Scale** has been selected to display in the **Display Metrics** area.

- a. In the **Display Metrics** area, tap the scale.  
The *Select Scale* screen will display.

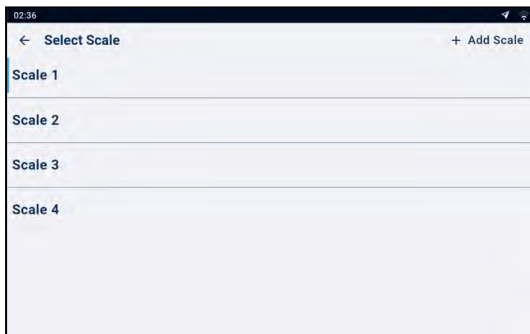

3. Tap the required scale.  
The *Total* screen will display. All bucketloads will now be recorded as having been lifted using the selected scale until a different scale is selected.

## 7.4 How do I zero the empty bucket?

The **Check Zero** functionality is only active if configured at installation.

It is necessary to periodically "zero" the bucket because small errors can occur due to a build-up of material in the bucket.



If you see the above message, you need to zero the empty bucket.

**IMPORTANT – Legal For Trade systems:** You must zero the bucket before beginning each new load.

**IMPORTANT –** When zeroing the Indicator, the bucket must be empty and kept fully-rolled back.

Complete the following to zero the bucket:

1. Ensure that the loader is level and the bucket is empty.
2. Roll the bucket backwards.
3. Lower the bucket to the lowest position.
4. Raise the empty bucket.
5. Tap .

The **Zero Updated** message will display, before the *Total* screen is displayed.

**NOTE –** If  is not displayed, the bucket is not empty enough. Empty the bucket, then return to step 1.

## 7.5 How do I select a job?

The *Jobs* screen displays a list of trucks in your zone that are waiting to be loaded. To assist you in selecting the next job, jobs are listed in the order of priority, and include the following information:

- The truck name or registration number
- The product to be loaded
- The weight of product to be loaded
- The amount of time that the truck has been waiting to be loaded.

To select a job, complete the following:

1. From the *Total* screen, tap . The *Jobs* screen will display.

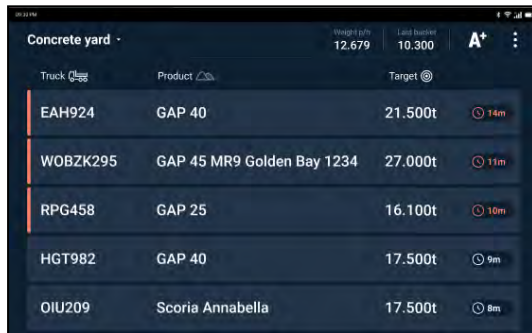

2. Check that the zone displayed at the top left of screen is correct, then complete the following:

If...	Then...
the zone is correct	continue to step 3.
the zone is incorrect	<ul style="list-style-type: none"> <li>▪ Tap the <b>Zone</b>. The <i>Select a zone</i> drop-down box will display a list of available zones.</li> <li>▪ Tap the correct zone. The <i>Jobs</i> screen will display a list of available jobs for the selected zone.</li> </ul>

3. Tap the job that you would like to work on.  
The *Total* screen will display in *Target Weighing* mode, displaying the truck, product and amount to be weighed, in order to complete the job.

## 7.5.1 How do I cancel a job?

You can cancel a job and return it to the list of jobs on the *Jobs* screen, if no bucketloads have been added. You may want to cancel the job if you selected the wrong job, or it needs to be assigned to a different loader.

To cancel a job, complete the following:

1. To cancel a job, tap **Cancel Job**.  
The *Jobs* screen will display a list of available jobs, including the canceled job.
  - If a bucketload has already been added, tap  to undo the bucketload, then tap **Cancel Job**.

## 7.5.2 How do I add a customer or other data list to the job?

**You can only select a data list if that data list has been configured and enabled at installation.**

You can add or change the customer or other data list for the active job at any time before completing the job. The only data list that cannot be changed is the **Truck** data list, as changing the truck is the same as ending the job and beginning a new job.

The following procedure shows how to add or change the **Customer** for the job:

1. Tap the **Customer** data list value.  
The *Select Customer* screen will display.



2. Tap the customer to apply to the job.
  - To reduce the number of listed customers, tap the **Search** box, then enter characters from the customer name. The list will reduce to only show those that match your search.

The *Total* screen will redisplay with the job set to the selected customer.

## 7.6 How do I weigh and add a bucketload?

After selecting a job, the *Total* screen will display in *Target Weighing* mode, displaying the truck, product and amount to be weighed in order to complete the job.

**IMPORTANT – Legal For Trade systems:** You must zero the bucket before beginning a new load.

1. Raise a bucketload of product smoothly through the Trigger Point using constant engine revs

**IMPORTANT – Legal For Trade systems:** You must keep the bucket fully-rolled back while lifting a bucketload, or a **Bucket not emptied** message will be displayed, and the bucketload will not be recorded.

2. If *Weight Preview* functionality is enabled, a preview of the weight will display during the lift:

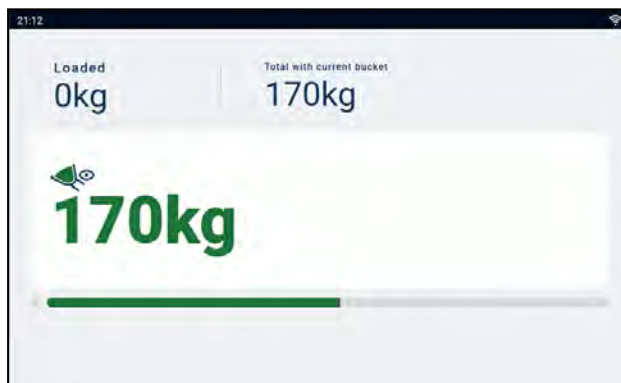

3. When the bucketload has been weighed, the Indicator will beep and the *Live Weight* screen will display the following:
  - the target weight for the job,
  - the current bucketload,
  - the new target weight, if the bucketload is added to the truck.

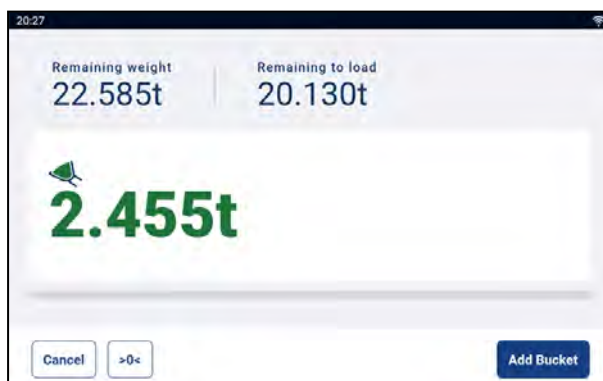

4. Tap **Add Bucket** to add the bucketload to the truck.
5. Empty the bucketload in to the truck.
6. Repeat steps 1-5 until the target weight is as close to **0** (zero) as possible.



## 7.0 Loadrite 360 Job Management

7. Tap **Complete Job** to complete the job.  
The *Jobs* screen will display. The final total will be sent to *Loadrite Communications Interface (LCI)* at the office, where a ticket can be printed for the truck driver.

To select a new job, see "*How do I select a job?*" on page 38.

### 7.6.1 Remote Buttons

The Loadrite weighing system supports optional remote buttons. Remote buttons are positioned for your convenience, such as on or near the lift lever, or wired into the horn.

Depending on configuration, pressing a remote button may add a bucketload, complete the load, zero the bucket, or split the load.

Remote buttons can be used interchangeably with the standard buttons on the Indicator.



### 7.6.2 What is Auto-Add?

**The *Auto-Add* functionality is only available if enabled at installation.**

The *Loadrite* weighing system can be set to automatically add a bucketload when lifted past the Trigger Point for a specified number of seconds. This means that you don't need to tap **Add Bucket** after lifting each load.

If *Auto-Add* is enabled, an icon will display on the *Total* screen.

The following may apply depending on how *Auto-Add* functionality was configured at installation:

- Bucket loads may not be added if under a specified amount, or is considered to be a *poor lift* or *bad lift*.
- *Auto-Add* may be turned on or off (toggled) by tapping **A<sup>+</sup>** on the *Total* screen.

#### 7.6.2.1 Auto-Add toggle

**The *Auto-Add toggle* functionality is only available if enabled at installation.**

You can toggle between using *Auto-Add* or manually adding lifted weights by tapping **A<sup>+</sup>** on the *Total* screen.

## 7.6.3 Subtract a bucketload

This *Subtract* function can be useful when only part of a final load of loose material is required. To subtract a bucketload complete the following:

1. Weigh and add a full bucketload as per normal, *but only tip the required amount of material into the truck.*
2. Re-weigh the bucket containing the remaining material, *but do not add the bucketload.*
3. Tap **Subtract**.  
The **Bucket Subtract** message will display. The re-weighed amount will be subtracted from the total, meaning that only the amount tipped in step 1 was added. The *Total* screen will re-display.

## 7.6.4 Undo/Redo

The *Undo* function allows you to correct mistakes by “undoing” the previous bucketload and removing it from the total. You can then “redo” the bucketload if you need to, in effect toggling between “undo” and “redo”.

You can also “undo” a discarded weight. For example, if you lift a bucketload but take more than 8 seconds to tap **Add Bucket**, the weight will be discarded; but if you then tap , the *Live Weight* screen will reappear and you will have the option to add the weight again.

### 7.6.4.1 Undoing a bucketload

To *undo* the previous bucketload, complete the following:

- Tap .  
The message **Undoing previous action** will display, then the *Total* screen will display a new total that doesn't include the previous bucketload.

### Redoing a bucketload

To *redo* the undone bucketload, complete the following:

- Tap  again.  
The message **Undoing previous action** will display, then the *Total* screen will display a new total that includes the previous bucketload.

You can continue to tap  to toggle between undoing and redoing the bucketload.

### 7.6.4.2 Undoing a discarded weight

After the **Discarded Weight** message has displayed, the *Total* screen will display. To *undo* the discarded weight, complete the following:

1. Tap .  
The discarded weight is canceled and the *Live Weight* screen will display the following:
  - the weight of the current bucketload,
  - the total amount of product that has been loaded,
  - the new total if the bucketload is added.

## 7.0 Loadrite 360 Job Management

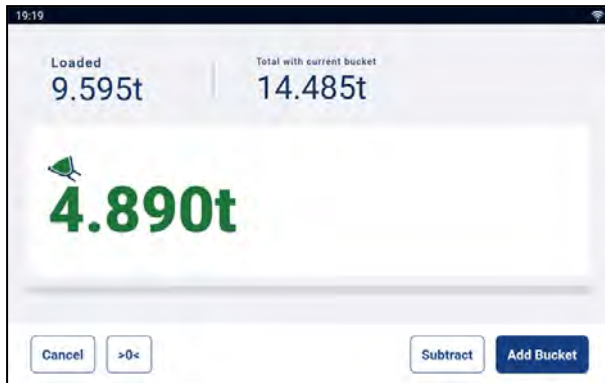

2. Tap **Add Bucket** to add the bucketload to the total.

## 7.7 How do I turn off the Indicator?

If you are not going to use the Loadrite Indicator for a while, you can put it into *Standby* mode by pressing the red power button. Press it again to exit *Standby* mode.

The Indicator will completely turn off when you turn off the loader.

# 8.0 More Options menu

**The items displayed on the *More Options Menu* depend on settings configured at installation.**

The *More Options* menu provides options for configuring the LoadriteL5000 Weighing System.

- To display the *More Options* menu, tap  when the *Total* screen is displayed.

Menu Option	Description
<b>Add a target</b>	Accesses <i>Target Weighing</i> mode functionality. <ul style="list-style-type: none"> <li>▪ For information on <i>Target Weighing</i> mode, see "<i>Target Weighing mode</i>" on page 29.</li> </ul>
<b>Scale</b>	Allows the current scale (attachment) to be changed, if more than one scale has been configured at installation.
<b>Transaction history</b>	Displays the transaction history and allows tickets to be searched for, displayed on-screen, and printed.
<b>Metrics</b>	Accesses the <i>Metrics</i> menu to view operator metrics, data totals, loading metrics, and lifetime totals.
<b>Take Snapshot</b>	Accesses the <i>Metrics</i> menu to view operator metrics, data totals, loading metrics, and lifetime totals.
<b>About</b>	Displays Indicator hardware, software and network specifications, and copyright information.
<b>Settings</b>	Accesses appearance and setup settings. <ul style="list-style-type: none"> <li>▪ An access code is required to access the <i>Installer Menu</i> and other special menus. For further information, contact your Loadrite dealer.</li> </ul>

## 8.1 Add a Target



The *Add a target* function displays the *Add target* screen to enter a target weight.

- For information on using target weighing, see "*Target Weighing mode*" on page 29.

## 8.2 Select Scale



**The *Scale* option is only available if multiple scales have been configured at installation.**

The *Select Scale* screen is used to select the correct loading attachment, to ensure that the lifted weight is accurate.

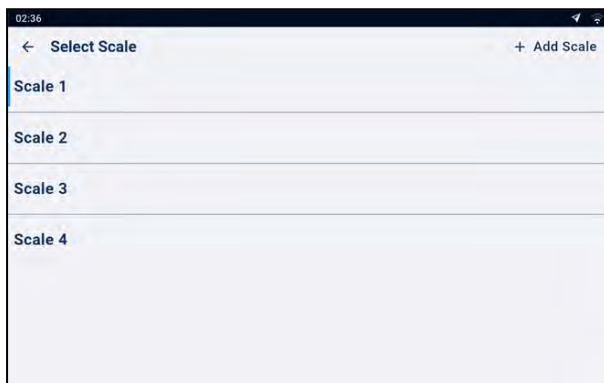

1. Tap the scale to select it.  
The *Total* screen will display with the name of the selected scale shown. All bucketloads will be recorded against the selected scale until a different scale is selected.





## 8.3 Transaction History

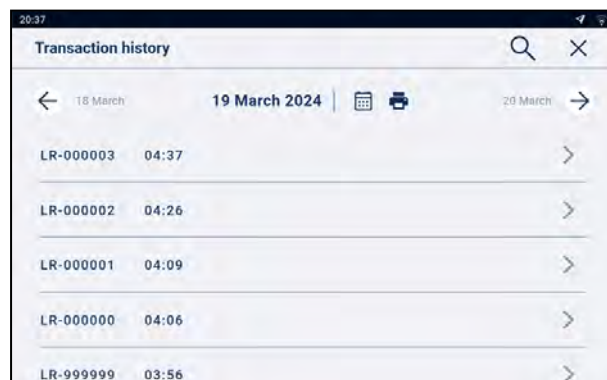

The *Transaction History* screen displays a list of all tickets for the selected date. Tickets may be searched for by ticket number, previewed on-screen, or printed to a connected printer. Ticket information is stored on the Indicator for up to 90 days.





- Tap a ticket in the list to display the details.
  - Swipe the displayed ticket left or right to display each ticket from the day, if available.
- Swipe the list up or down to scroll through the list tickets from the day, if available.

- Swipe left or tap  to display a list of tickets from the previous day.
- Swipe right or tap  to display a list of tickets from the next day.
- Tap  to select a different day from the pop-up calendar.  
Use the calendar to select a day, then tap **OK** to display a list of tickets for the selected day.
- Tap  to batch print a range of tickets.  
For more information, see "*Print a range of tickets*" on page 47.

## 8.3.1 Search for a ticket

To search for a ticket by ticket number, complete the following:

1. From the *Transaction History* screen, tap .  
The *Ticket Number* screen will display.
2. Use the on-screen keypad to enter the ticket number of the ticket that you would like to view, then tap .  
The ticket search results will display on-screen.

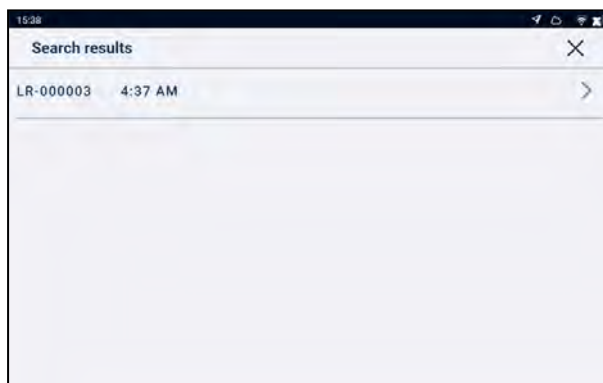

3. Tap the ticket that you would like to preview.  
The ticket will display on-screen.



- Tap **Print** to send the ticket to the connected printer.

## 8.3.2 Print a ticket

To print an individual ticket, complete the following:

- From the *Transaction History* screen, select a ticket or search for a ticket. The *Ticket* screen will display a preview of the selected ticket.



- Complete the following:

If...	Then...
the Indicator is connected to a remote printer via LG500	the options <b>Print Remote</b> and <b>Print in Cab</b> will display. <ul style="list-style-type: none"> <li>Tap <b>Print Remote</b> to print via the LG500, or</li> <li>Tap <b>Print in Cab</b> to print via the printer in the loader cab (if available).</li> </ul>
the Indicator is only connected to a printer in the loader cab	Tap <b>Print</b> . The ticket is sent to the connected printer.

## 8.3.3 Print a range of tickets

You can print all tickets created today, or print all tickets created within a range of dates (including the start and end dates). To print a range of tickets, complete the following:

- From the *Transaction History* screen, Tap . The *Select printing option* pop-up box will display.
- Complete the following:

If...	Then...
you want to print all tickets created today (not the date displayed on the <i>Transaction History</i> screen)	tap <b>Print today</b> . All tickets from today are sent to the connected printer.
you want to print all tickets created between a range of dates	<ul style="list-style-type: none"> <li>Tap <b>Print custom range</b>. The pop-up calendar will display.</li> </ul>

If...	Then...
	<ul style="list-style-type: none"> <li>Use the calendar to select the start date for the range.</li> <li>Use the calendar to select the end date for the range. The range period will be highlight. If it is incorrect, you can select a new start date and end date.</li> <li>Tap <b>OK</b>. All tickets created within the date range are sent to the connected printer.</li> </ul>

## 8.4 Metrics



> Metrics

The *Metrics* menu allows you to view operator metrics, data totals, loading metrics, and lifetime totals.

### 8.4.1 Operator Metrics



> Metrics > Operator



The *Operator Metrics* screen displays your KPI metrics since they were last reset.

Item	Description
<b>Total weight</b>	The total weight of all bucketloads added.
<b>Loaded since</b>	The date and time that the first bucketload was added
<b>Time of last load</b>	The date and time that the last bucketload was added.
<b>Average weight per hour</b>	The average weight lifted per hour.
<b>Load count</b>	The number of truckloads successfully added.



Item	Description
Last bucket weight	The weight of the last bucketload added.

## 8.4.2 Data Totals

➤ > Metrics > Data Totals

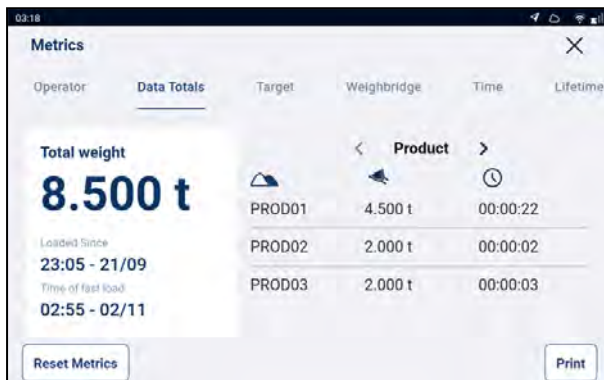

The *Data Totals* screen displays the total amount of each data list value weighed.

- Tap the name of the Data List to select a different one, or tap > or < to scroll through each one.

Item	Description
<b>Total weight</b>	The total weight of all bucketloads added.
<b>Loaded Since</b>	The date and time that the first bucketload was added.
<b>Time of last load</b>	The date and time that the last bucketload was added.
<b>Data List</b>	Scroll through each data list to display all data list values, with the total weight and total time taken to load for each one.

### 8.4.2.1 Print metrics

To print metrics, complete the following:

1. From the *Data Totals* screen, tap **Print**.
2. Select or clear each data item until only those that you would like to display on the ticket are selected, then tap **Print**.
3. The *Ticket* screen will display a preview of the ticket.





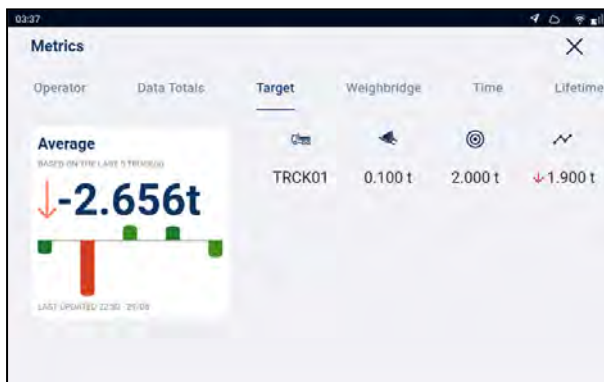

4. Tap **Print**.  
The ticket is sent to the connected printer.

## 8.4.3 Target Metrics

➤ > Metrics > Target Metrics



The *Target Metrics* screen displays the target weights and actual weights of the last five trucks, so that the difference can be monitored.





Item	Description
<b>Average</b>	The average load and average cycle time since metrics were last reset.
	The registration number/name of the truck.
	The actual loaded weight for the truck.
	The target weight for the truck.
	The difference between the target weight and actual weight for the truck.

## 8.4.4 Weighbridge Metrics

The *Weighbridge Metrics* screen is only available if *Loadrite360* is active.

➤ ⋮ > *Metrics* > *Weighbridge*

The *Weighbridge Metrics* screen displays the weights determined by the Loadrite Indicator vs the weights determined by a weighbridge, so that any difference can be monitored.



Item	Description
<b>Average</b>	The average load and average cycle time since metrics were last reset.
	The registration number/name of the truck.
	The weight as determined by the Indicator.
	The weight as determined by the weighbridge.
	The difference between the Indicator weight and the weighbridge weight.

## 8.4.5 Time Metrics

The *Time Metrics* screen is only available if *Loadrite360* is active.

➤ ⋮ > *Metrics* > *Time*

The *Time Metrics* screen displays the turnaround time (cycle time) for trucks, providing a comparison with the target loading times.

Item	Description
<b>Average Loading Time</b>	The average loading time since metrics were last reset.
<b>Average Turnaround Time</b>	The average turnaround time (cycle time) since metrics were last reset.
<b>Loaded since</b>	The date and time that the first bucketload was added
<b>Time of last load</b>	The date and time that the last bucketload was added.
	The registration number/name of the truck.
	The time taken to load the truck.
	The time elapsed from when the truck entered the site to when it exited the site.

## 8.4.6 Lifetime Totals

➤ ⋮ > Metrics > Lifetime Totals

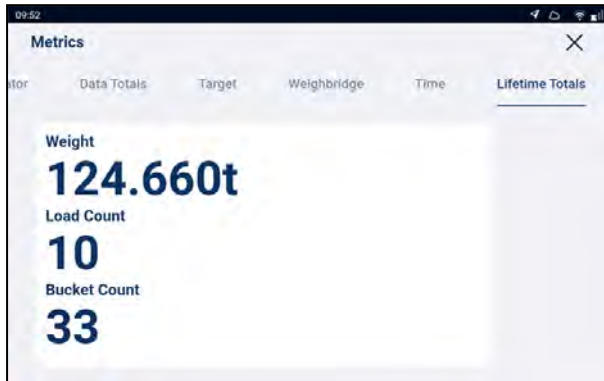

The *Lifetime Totals* screen displays the total amount weighed by the Indicator since it was last factory reset. The figures are irrespective of whether the metrics have been reset.

Item	Description
Weight	The total weight of all bucketloads ever added.
Load Count	The total number of all truckloads ever weighed.
Bucket Count	The total number of all bucketloads ever added.

## 8.4.7 How do I reset metrics?

To reset all metrics, tap **Reset Metrics** from the *Operator Metrics* or *Data Total Metrics* screen. If a printer is connected and enabled, a ticket will be printed listing all of the loader's loadout activity since the metrics were last reset.



**CAUTION** – When reset, all metrics data is deleted from the Indicator and cannot be recovered.

## 8.5 Take Snapshot

➤ ⋮ Take Snapshot

The *Take Snapshot* function is used to capture current data and settings. This information can be useful for setting up new Indicators, record keeping, and assisting with technical issues.

- The L5000 Indicator can store the ten most recent snapshots.
- Snapshots are saved as .zip files and can be downloaded from the *L5000 Web Interface*.

## 8.6 About



The *About* screen displays system information about the Loadrite L5000 Indicator, including hardware, software and network specifications, and copyright information.

## 8.7 Settings Menu



The *Settings* menu provides access to settings for configuring the Loadrite L5000 Indicator. Some settings are only accessible using access codes.

### 8.7.1 Preferences



The *Preferences* menu allows you to customize your experience.

#### 8.7.1.1 Dark Mode



When *Dark* mode is enabled, the screen theme changes from bright colors to darker colors. *Dark* mode may be easier on the eyes in lower-light environments, or for people with sensitive eyes.

#### Available options

Option	Description	Default
	<i>Dark</i> mode is enabled. All screens will have a darker tone and use darker colors.	
	<i>Dark</i> mode is disabled. All screens will have a brighter tone and use brighter colors. Also referred to as <i>Light</i> mode.	✓

#### 8.7.1.2 Brightness



Complete the following to change the brightness of the Indicator screen:

1. Tap **Brightness**.  
A *Brightness* pop-up box will display.

2. Tap and move the slider left to dim brightness, or tap and move the slider right to increase brightness. The pop-up box will close.

### 8.7.1.3 Volume



> *Settings > Preferences > Volume*

Complete the following to change the volume of the Indicator:

1. Tap **Volume**.  
A *Volume* pop-up box will display.
2. Tap and move the slider left to decrease volume, or tap and move the slider right to increase volume. The Indicator will beep at the new volume. The pop-up box will close.

### 8.7.1.4 Date and Time



> *Preferences > Date and Time*

The *Date and Time* functionality is used to set the date, time and time format used on the Indicator. It does not alter the time and date format on printed tickets.

#### 8.7.1.4.1 Set the date and time



> *Preferences > Date and Time > Date and Time*

Complete the following to set the time and date:

- Tap and scroll the date picker to select the current **Year**, **Month** and **Day**.
- Tap and scroll the time picker to select the current **Hour**, **Minute** and **Second**.
- When the time and date are correct, tap **OK** to return to the *Date and Time* screen.

#### 8.7.1.4.2 Change the time format



> *Preferences > Date and Time > 24-Hour Time*

Controls whether the clock in the **Notification Bar**, and printed tickets display the time in 12-hour format or 24-hour format.

### Available options

Option	Description
	The time is displayed in 24-hour format, for example <b>13:06</b> .
	The time is displayed in 12-hour format, for example <b>1:06 PM</b> .

## 8.7.1.5 Display Metrics



*Display Metrics* allows you to customize the metric and scale information displayed in the four (4) **Display Metric** fields of the *Total* screen. The **Display Metric** section can display up to four (4) pieces of information, specified from left to right (L-R) as **Display Metric 1** to **Display Metric 4**.

1. Tap the **Display Metric** you would like to configure.  
A pop-up box will display a list of metrics.
2. Select the metric that you would like to display in the selected **Display Metric** field:

Option	Description
Last Bucket Weight	Displays the weight of the last bucketload to be successfully added.
Total Buckets	Displays the total weight of all bucketloads added today.
Load count	Displays the number of bucketloads successfully added today.
Weight/h	Displays the average weight lifted per hour for today.
Scale	Displays the currently selected scale.
None	The <b>Display Metric</b> field does not display any information. <ul style="list-style-type: none"> <li>▪ This is the default option for all <b>Display Metric</b> fields.</li> </ul>

## 8.7.1.6 Print Buckets



**This function is ignored if *Workflow* is set to *Basic*.**

The *Print Buckets* function determines whether or not the weight of every bucketload will be printed on each ticket. The Total will always be printed, irrespective of the selected option.

### Available options

Option	Description	Default
	Bucketloads (Adds), and the Total will be printed on each ticket.	✓
	The Total will be printed on each ticket. Bucketloads will not be printed.	

### 8.7.1.7 Print Feed



The *Print Feed* functionality determines whether the connected printer will automatically feed paper after printing each ticket.

#### Available options

Option	Description	Default
	The printer will automatically feed the paper after printing each docket.	✓
	<i>Print Feed</i> functionality is not used. The operator will need to manually feed the paper when required.	

### 8.7.1.8 Number of copies



The *Number of copies* function determines the number of copies of each ticket will be printed, for example, if the value is **3**, then each time a total is cleared, three copies of the ticket will be printed. The **Number of copies** value also applies when reprinting a ticket.

#### Available options

- Valid values are **1 - 65536**.
- The default value is **1**.

### 8.7.1.9 User Manual



The User Manual for the LoadriteL5000 will display on-screen. Use the following controls to navigate the manual:

- Swipe up or down to scroll through the pages.
- Tap ▲ to display the previous page, or tap ▼ to display the next page.
- Tap and drag the page number (right side of screen) up or down to scroll through the pages.
- Tap to display a list of chapter titles. Tap a chapter title to display the first page of the chapter.



## 8.7.1.10 Language

➤ ⋮ > *Settings > Preferences > Language*

The Loadrite Indicator supports multiple languages. The **Language** setting changes the current language used on-screen.

### Available options

- Valid values depend on your region of the world.
- The default value is **English**.

## 8.7.2 Diagnostics

➤ ⋮ > *Settings > Diagnostics*

The *Diagnostics* menu consists of a range of diagnostic functions to assist in finding faults, including live information and tests.

### 8.7.2.1 System Status

➤ ⋮ > *Settings > Diagnostics > System Status*

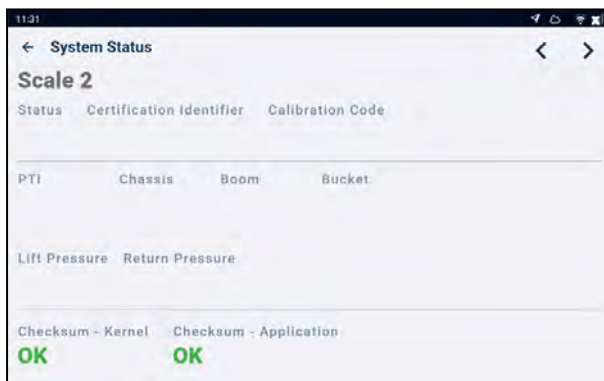

The *System Status* screen is used to verify the Trade Approval status of each scale. Information displayed includes:

- Scale ID
- Trade Approval Status
- Certification Identifier
- Calibration Code
- Detected sensors
- Transducer lift and return pressure
- Kernel checksum status
- Application checksum status.

## 8.7.2.2 Connectivity



> *Settings > Diagnostics > Connectivity*

Displays the current status and relevant information of various connections on one screen, to assist with troubleshooting.

Information displayed includes the status of cellular, WiFi, Internet and LG500 connections, as well as the serial number, current software version and OTA (firmware) update status.

## 8.7.2.3 CAN Devices



> *Settings > Diagnostics > CAN Devices*

The *CAN Devices* screen displays a list of connected CAN devices. You can view live information for each device by selecting it from the list.

## 8.7.2.4 Pressure Diagnostics



> *Settings > Diagnostics > Pressure Diagnostics*

Displays the current **Lift Pressure** and **Return Pressure** values from the pressure transducers.

## 8.7.2.5 Orientation Sensors



> *Settings > Diagnostics > Orientation Sensors*

Displays the current **Boom**, **Pitch**, **Roll** and **Bucket** values from the orientation sensors.

## 8.7.2.6 CAN Diagnostics



> *Settings > Diagnostics > CAN Diagnostics*

The *CAN Diagnostics* screen displays the current counters for CAN Bus events. Information displayed includes: **CAN Tx Queue Overflow**, **Serial Buffer Overflow**, **Serial Queue Overflow**, **Retry Counts**, **Packet Errors**, and **UART** hardware errors.

## 8.7.2.7 Input Diagnostics



> *Settings > Diagnostics > Input Diagnostics*

The *Input Diagnostics* screen displays the current assignments for the two remote buttons as specified by **Remote Button 1** and **Remote Button 2**.

## 8.7.2.8 System Time

➤ ⋮ > *Settings > Diagnostics > System Time*

Displays live time information, including **Local Time**, **UTC** (Coordinated Universal Time), **GPS Time**, **System Time**, **System Time Zone**, **Local Offset** (from UTC), **Location**, and **Sync** (synchronization status).

## 8.7.2.9 GPS

➤ ⋮ > *Settings > Diagnostics > GPS*

Displays current GPS information used to calculate location, speed, etc. Information displayed includes **Fix Type**, **Latitude**, **Longitude**, **Satellites**, and **Date and Time**.

## 8.7.2.10 Certificates

➤ ⋮ > *Settings > Diagnostics > Certificates*

Displays the current status of the processes and connections required to retrieve certificates.

## 8.7.2.11 Screen Display Test

➤ ⋮ > *Settings > Diagnostics > Screen Display Test*

Performs a test of the display screen before displaying the Checksum status.

## 8.7.2.12 Test Print

➤ ⋮ > *Settings > Diagnostics > Screen Display Test*

The *Test Print* function will send an example ticket to the connected printer. This is a simple way to check that the printer is correctly connected and configured.

1. When the *Test Print* pop-up window displays, tap **Confirm**.  
The example ticket is sent to the printer.
2. Tap **Ok**.

## 8.7.2.13 L5000 Web Interface

➤ ⋮ > Settings > Diagnostics > Web Interface



The *Web Interface* screen provides a QR Code and URL address that you can use to access the *Loadrite L5000 Web Interface* via your device. The *Loadrite L5000 Web Interface* allows you to control the following features:

- Lift Simulator
- Firmware Update
- Snapshot
- Connectivity Status
- Scope
- Ticket settings
- Data Lists.

To open the *Loadrite L5000 Web Interface*, complete the following:

1. Use the camera (or QR Code app) on your device to scan the QR code on the *Web Interface* screen (or record the URL address and type it into the address bar of your browser).
2. The *Loadrite L5000 Web Interface* will open in a new browser tab on your device.



- For information on using *Loadrite L5000 Web Interface*, contact your distributor.

## 8.7.3 Set up

The *Set up* screen provides access to the *Access Code* screen. From the *Access Code* screen, the *Installer Menu* and a range of other menus and features can be accessed, depending on the code that is entered.

- For further information, contact your Loadrite dealer.

# 9.0 Appendix A: System specifications

## 9.1 Weighing accuracy

Typical accuracy is within  $\pm 1\%$  for most loaders. This may vary with different machine types, installation options, and the operating environment.

## 9.2 Minimal weighing delay

Weighing delay is minimal, because the weighing function is carried out during a normal lift.

## 9.3 Power requirements

<b>Supply voltage</b>	24 V DC vehicular supply.
<b>Power consumption</b>	3 A maximum.

## 9.4 Physical specifications

<b>LCD display</b>	7 inch; 1280 x 800 pixels (HD); 800 cd/m <sup>2</sup> ; Sunlight-readable; 10-point multitouch capacitive.
<b>Weight</b> (excluding mounting)	LT70 Indicator: 0.8 lb (1.76 kg) LM10 Power Module: 0.25 lb (0.55 kg)
<b>Dimensions</b> (excluding mounting)	LT70 Indicator: 207.4 mm x 137.4 mm x 30.1 mm (8.17" x 5.41" x 1.19") LM10 Power Module: 109 mm x 113 mm x 45 mm (4.29" x 4.45" x 1.77")

## 9.5 Environmental specifications

<b>Operating temperature</b>	LT70 Indicator: -10° C to 65° C (14° F to 149° F) LM10 Power Module: -40° C to 80° C (-40° F to 176° F).
<b>Storage temperature</b>	LT70 Indicator: -20° C to 70° C (-4° F to 158° F) LM10 Power Module: -40° C to 85° C (-40° F to 185° F).
<b>Ingress protection</b>	LT70 Indicator: IP67 LM10 Power Module: IP31
<b>Shock and vibration</b>	MIL-STD-810G

## 9.6 Connector Specifications

<b>LT70 Indicator</b>	Power connector: M16-12P-F
<b>LM10 Power Module</b>	<ul style="list-style-type: none"> <li>▪ CAN 1: Deutsch DT04-4P or equivalent</li> <li>▪ CAN 2: Deutsch DT04-4P or equivalent</li> <li>▪ Power: Deutsch DT04-3P or equivalent</li> <li>▪ Tablet communications: Deutsch DT04-12P or equivalent</li> <li>▪ Digital I/O: Deutsch DT04-4P or equivalent</li> <li>▪ Serial GPS/Printer: Deutsch DT04-6P or equivalent.</li> </ul>

## 9.7 Wireless Specifications

<b>Bluetooth (WPAN)</b>	4.2 BLE
<b>WiFi (WLAN)</b>	IEEE 802.11 a/b/g/n/ac; 2.4GHz/5GHz
<b>Mobile broadband</b>	151020-20-A: LTE FDD: B2/B4/B5/B7/B12/B13/B14/B17/B25/B26/B66/B71  151020-20-A: LTE FDD: B1/B2/B3/B4/B5/B7/B8/B20/B28
<b>GNSS</b>	GPS/GLONASS

# 10.0 Appendix B:

## Legal information

### Disclaimer

Loadrite (Auckland) Ltd operates a policy of on-going development. Please note that while every effort has been made to ensure that the data given in this document is accurate, due to continued product development, the information, figures, illustrations, tables, specifications, and schematics contained herein are subject to change without notice. Loadrite (Auckland) Ltd does not warrant that this document is error-free. The screenshots and other presentations shown in this manual may differ from the actual screens and presentations generated by the actual product. All such differences are minor and the actual product will deliver the described functionality as presented in this document in all material respects. If you find any errors in the document, please report them to us in writing.

Loadrite (Auckland) Ltd assumes no liability in connection with the use of any Loadrite branded product.

Loadrite (Auckland) Ltd is not responsible for any radio or TV interference caused by unauthorized modifications to this equipment. Such modifications could void the user's authority to operate the equipment.

### Compliance

Domain	Policy	Description	Top-Level Requirement
Australia / New Zealand	Radiocommunications (EMC Standards) Notice 2019	Emissions (industrial)	ISO 61000-6-2, ISO 61000-6-4
	Radiocommunications (EMC Standards) Notice 2020	Radio emissions (intentional)	ETSI EN300 328
Canada	ICES-GEN 2021	Emissions (industrial)	ANSI C63.4
	RSS-GEN 2021	Radio emissions (intentional)	ETSI EN300 328
Europe	Electromagnetic Compatibility Directive 2014/30/EU	Emissions/Immunity (industrial)	ISO 61000-6-2, ISO 61000-6-4
	Radio Equipment Directive 2014/53/EU	Radio emissions (intentional)	ETSI EN300 328
	Restriction of Hazardous Substances Directive 2011/65/EU and 2015/863	Restriction of Hazardous Substances	IEC 63000:2018
United Kingdom	Electromagnetic Compatibility Regulations 2016	Emissions (industrial)	ISO 61000-6-2, ISO 61000-6-4
	Radio Equipment Regulations 2017	Radio emissions (intentional)	ETSI EN300 328
	The Restriction of the Use of Certain Hazardous Substances in Electrical and Electronic Equipment Regulations 2012	Restriction of Hazardous Substances	EN 50581:2012
United States of America	FCC 47 CFR Part 15 Subpart B - Unintentional radiators	Emissions (industrial)	ANSI C63.4
	FCC 47 CFR Part 15 Subpart C - Intentional radiators	Radio emissions (intentional)	ETSI EN300 328





This Loadrite product is fully EMC (Electro-Magnetic Compatibility) compliant and is CE marked accordingly. A Declaration of Conformity, in accordance with the EMC Directive 2014/30/EU (and as amended) is available from Loadrite (Auckland) Ltd on request: [info@goloadrite.com](mailto:info@goloadrite.com)  
Loadrite (Auckland) Ltd cannot be held responsible for modifications made by the User and the consequences thereof, which may alter the conformity of the product with CE marking.

Hereby, Loadrite (Auckland) Ltd declares that the L5000 devices are in compliance with the essential requirements and other relevant provisions of CE.

This Loadrite product is explicitly excluded from the scope of EU RoHS 2 Directive 2011/65/EU in article 2, section (4), paragraphs: (d), (e), (f) and (g).

This device complies with part 15 of the FCC Rules and Industry Canada licence-exempt RSS standard(s). Operation is subject to the following two conditions: (1) This device may not cause harmful interference, and (2) this device must accept any interference received, including interference that may cause undesired operation.



**WARNING –** This product contains chemicals known to the State of California to cause cancer, birth defects or other reproductive harm. This Notice is being provided in accordance with California's Proposition 65.

## Disposing of Loadrite electronic equipment

This electronic product is subject to the EU Directive 2012/19/EU for Waste Electrical and Electronic Equipment (WEEE) which requires the separate collection, treatment, recycling and environmentally-sound final disposal of waste of electrical and electronic equipment. As such, this product must not be disposed of at a municipal waste collection point.

Please refer to local regulations for directions on how to dispose of this product in an environmentally-friendly manner.



## Third-party software licenses

The following third-party software libraries are included as part of the L5000 software:

**jQuery:**

Licensed under the MIT License.

**JsStore:**

© Ujjwal Gupta. Licensed under the MIT License.

**Lodash:**

Licensed under the MIT License.

**MD5:**

© 2011 Sebastian Tschan, <https://blueimp.net>. Licensed under the MIT License.

**moment:**

Licensed under the MIT License.

**Picolog:**

© 2015 by Stijn de Witt. Some rights reserved. Licensed under the Creative Commons Attribution 4.0 International (CC-BY-4.0) Open Source license: <https://creativecommons.org/licenses/by/4.0/>

