

**HOBART**701 S Ridge Avenue, Troy, OH 45374  
1-888-4HOBART • www.hobartcorp.com**FT900  
FLIGHT-TYPE DISHWASHER****HOBART****STANDARD FEATURES**

- Opti-RinSe™ system
- Water usage 120 gph @ 20 psi
- Microprocessor controls
- Low temperature alert
- Single point vent connection
- 42" access doors on power wash and power rinse chambers, 34" access doors on prewash chamber
- Variable speed conveyor 4-8.5 fpm
- Start and stop switches at both ends
- Doors open indicator
- Load end flush system
- Door interlocks
- 3 H.P. TEFC prewash, power wash and power rinse pump motors
- Easy to remove wash arms
- Easy to remove scrap trays and baskets
- 30½" wide conveyor
- Insulated hinged doors
- Front and rear panels

**DIRECTION OF OPERATION**

- Right to Left
- Left to Right

**VOLTAGE**

- 208/60/3
- 240/60/3
- 480/60/3
- Other voltages available. Consult factory.

**MODEL**

- FT900 – Flight-Type Dishwasher

**OPTIONS AT EXTRA COST**

- Energy Recovery – **advansys** (will require a back draft preventer)
- Electric Tank Heat
- Steam Tank Heat
- Booster Heater
  - Electric
  - Steam
- Blower Dryer
  - Electric
  - Steam
- 6" higher than standard chamber
- Prewash temperature control
- Multiple conveyor choices
- Circuit breakers
- Insulated counterbalanced sliding doors option
- Optional conveyor speeds
- Other options available, consult factory

**ACCESSORIES**

- Feet
  - Extended
  - Flanged
- Water hammer arrestor/PRV.

Specifications, Details and Dimensions on Inside and Back.



LA Research Report #M660004

**FT900 FLIGHT-TYPE DISHWASHER**

# FT900 FLIGHT-TYPE DISHWASHER

**HOBART**

701 S Ridge Avenue, Troy, OH 45374  
1-888-4HOBART • www.hobartcorp.com

**DESIGN:** Fully automatic, flight-type dishwasher machine consisting of a load section with power recirculating prewash, an 8 foot power wash, power rinse and final rinse section. Included with each machine will be flexible plastic strip curtains to control over spray.

**CONSTRUCTION:** Stainless steel tank and chambers with No. 3 polish on appearance surfaces. Frame, legs and feet to be constructed of stainless steel. Inspection doors to be chamber width.

**PUMPS:** Recirculating stainless steel pumps with stainless steel impellers. Pump housing has easy to remove coverplate for access to impeller. All pumps are self-draining. 150 gpm prewash; 292 gpm power wash/power rinse.

**MOTORS:** Totally enclosed fan cooled design, with inherent overload protection. Prewash, power wash and power rinse motors to be 3 H.P. each, conveyor ½ H.P. Available in electrical specifications of 200-240/60/3 and 480/60/3.

**CONTROLS:** A stainless steel control center with electronic digital controls mounted at eye level. Power “On/Off” and “Start/Stop” switches integrated into keypad. Digital display indicates door(s) open, low temperature alert, tanks/final rinse temperatures, and other pertinent operating data. Additional “Start/Stop” switches are located at each end of machine.

**FLIGHT-TYPE CONVEYOR:** Stainless steel side links, tie rods and conveyor tracks. Injection molded, resilient Duraflex flight links.

**VENT:** Single built-in vent duct with dampers mounted in cleanable cross duct.

**RECIRCULATING PREWASH SECTION:** Prewash compartment is fitted with upper and lower wash arms. Prewash flush down for prewash tank bed. Large removable one piece perforated stainless steel screen sloped downward to deep stainless steel scrap basket.

**TANK HEAT:** Power wash and power rinse tank water temperatures are thermostatically controlled. Low water protection is provided. Specify either electric or steam heat.

**FINAL RINSE:** Easily removed final rinse arms.

**CONVEYOR DRIVE UNIT:** Powered by a ½ H.P. motor. Trip mechanism provided on unload section. Jam protection is provided by load sensing switch at drive platform. Conveyor speed adjustment of 4 fpm to 8.5 fpm is provided in the main control box.

**DRAINS:** Manual, hand operated, located in each tank.

## No other control system allows easier monitoring.

The controls are placed in a convenient panel that lets operators verify proper operation and temperatures at a glance.

Digital display indicates the unit is on, and confirms that the doors are closed. Automatic door interlocks

prevent the pump and conveyor from operating if the doors are open. Easy-to-read digital display indicates accurate temperatures of the 150°F wash, 160°F power rinse, 160°F dual rinse and 180°F final rinse — critical for proper HACCP system record-keeping.



## Stainless steel pump is built for long life.

The stainless steel pump housing and impeller offer greater durability and long life. The pump motor is totally enclosed and fan cooled (TEFC) to protect it from water spray during dishroom clean-up. The pump is also externally mounted to the frame for added rigidity and easy access to the clean-out port.





701 S Ridge Avenue, Troy, OH 45374  
1-888-4HOBART • www.hobartcorp.com

# FT900 FLIGHT-TYPE DISHWASHER

## Scrap baskets capture food particles and are easy to clean.

The sloped screens that carry scraps to the scrap baskets are steeper, so less soil gets into the tanks. The basket opening is larger for easy cleaning and basket handles have been designed for easy lift-out access.

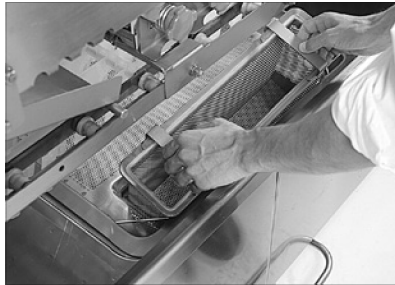

## The FT900 Series saves water and energy.

The unit is designed to cut water and energy usage, yet provide effective cleaning and sanitizing that meet NSF International requirements.

This is achieved through a carefully balanced ratio of water flow to pressure. At 292 gallons per min-

ute (gpm), the machine offers excellent wetting and flooding over ware. Insulated doors also reduce heat loss. The unit's 2.2 gpm/120 gallons per hour rinse flow rate (the lowest in the industry on a standard machine) saves both water and the energy to heat it.

## Wider, variable speed conveyor offers increased throughput.

The conveyor on the FT900 Series is wider so it can handle more ware. Result: more volume and versatility, quicker work. Its speed is service adjustable for the type of ware, soiled condition, or workforce requirements. It can be adjusted from 4 to 8.5 feet per minute.



## Optional Energy Recovery system.

The optional Energy Recovery system captures escaping heat and steam from the exhaust air and uses a heat exchanger to recycle it into energy. This free energy is used to preheat the incoming water supply before it enters the booster heater. The cold ground temperature water passes through a heat exchanger positioned directly in line with the machine's exhaust system to capture the energy from the exhaust air to elevate the temperature of the water to 128° before it enters the booster heater.



## Flush arm keeps load end clean.

The load end also has a readily removable flush arm to rinse food scraps into the prewash area scrap basket.

## Self-draining pumps help keep water clean.

Pumps are self-draining when the machine is shut down, so there is no residual water left in the pumps.

## Installation is quick and easy with modular design, minimal wiring connections, and single point vent.

Modular design means the FT900 installs quickly, and reliably. Sections fit through 42" doors. The control panel is already in place, premounted to the power wash/power rinse/final rinse section.

Wiring connections are minimal, and there is only a single vent connection, saving time and expense. The control box uses a "single plane" circuitry design for easy accessibility during installation and service. The FT900 is ready to run quickly.



# FT900 ELECTRIC L-R



701 S Ridge Avenue, Troy, OH 45374  
1-888-4HOBART • www.hobartcorp.com

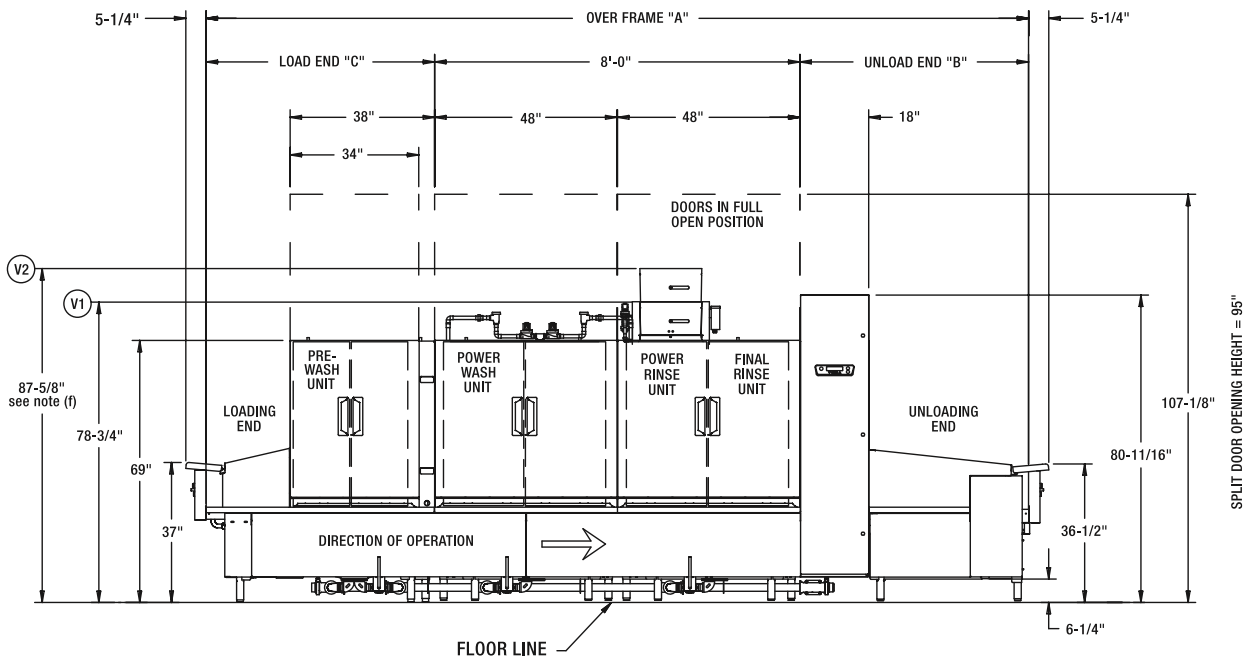
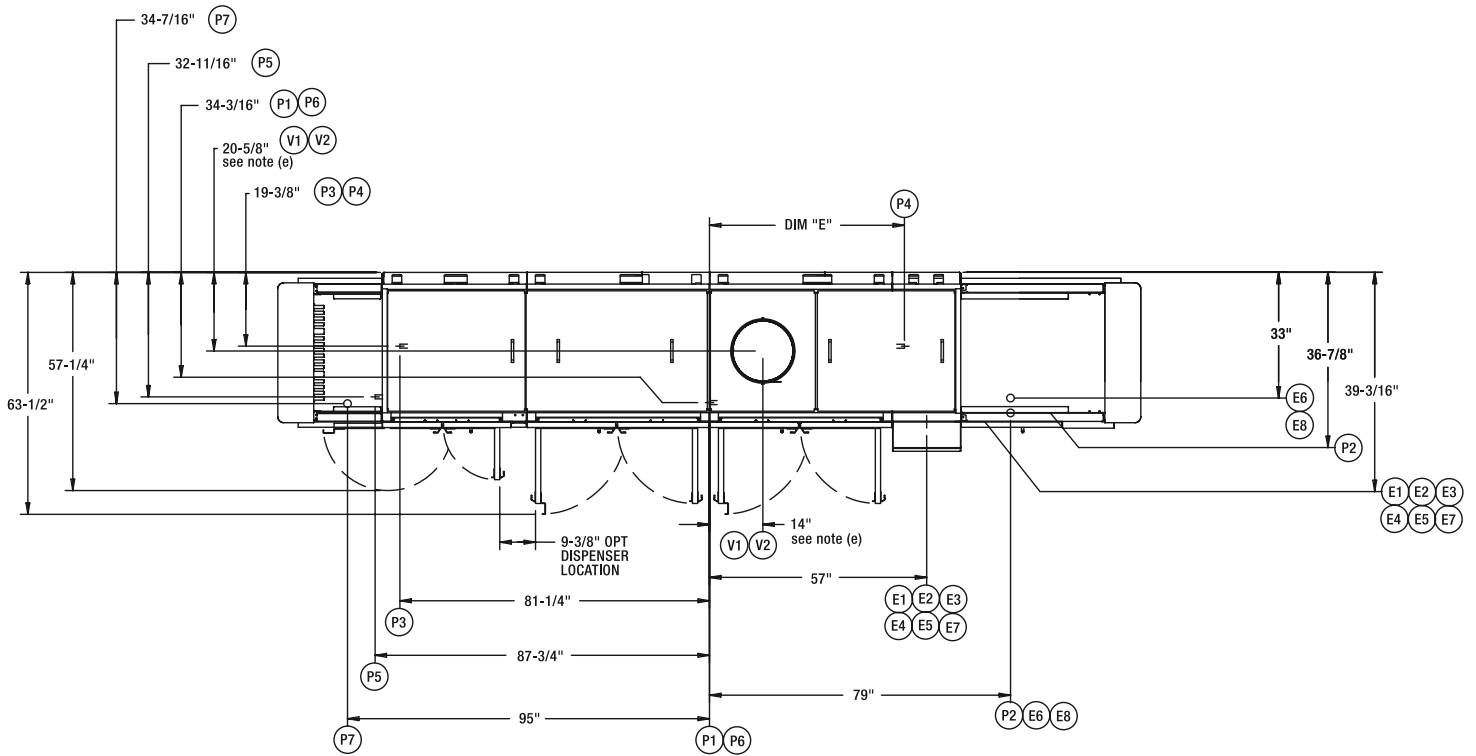



701 S Ridge Avenue, Troy, OH 45374  
1-888-4HOBART • www.hobartcorp.com

# FT900 ELECTRIC L-R

## ELECTRICAL CONNECTIONS COMMON ON ALL MODELS:

- E1 ELECTRIC CONNECTION, DETERGENT AND RINSE FEEDERS (MACHINE SERVICE VOLTAGE). 1/2" CONDUIT. 76-7/8" AFF
- E2 ELECTRIC CONNECTION, VENT FAN CONTROL (SWITCH CONTACTS) 1/2" CONDUIT. 79-3/8" AFF

## ELECTRICAL CONNECTIONS W/O CIRCUIT BREAKERS:

- E3 ELECTRIC CONNECTION, MOTORS & CONTROLS, 1" CONDUIT. 78-1/8" AFF
- E4 ELECTRIC TANK HEAT CONNECTION, 26 KW. 1" CONDUIT. 78-1/8" AFF
- E5 ELECTRIC TANK HEAT CONNECTION, 26 KW. 1" CONDUIT. 78-1/8" AFF
- E6 ELECTRIC CONNECTION, (OPTIONAL) ELECTRIC BOOSTER, 1-1/2" CONDUIT, 18-1/8" AFF

## ELECTRICAL CONNECTIONS WITH CIRCUIT BREAKERS:

- E7 ELECTRIC CONNECTION, MOTORS, CONTROLS AND TANK HEAT (WHEN CIRCUIT BREAKER OPTION IS SPECIFIED). 2" CONDUIT, 78-1/8" AFF
- E8 ELECTRIC CONNECTION, (OPTIONAL) ELECTRIC BOOSTER, 1-1/2" CONDUIT, 18-1/8" AFF

## PLUMBING CONNECTIONS:

- P1 FILL CONNECTION, (WHEN NO BOOSTER IS SPECIFIED). AUTOMATIC FILL, 140° F WATER, 1" FPT. 7-5/16" AFF
- P2 FINAL RINSE CONNECTION. (WHEN NOT SUPPLIED WITH BOOSTER WATER HEATER) 3/4" FPT. 180° F WATER MINIMUM. 11-3/16" AFF see notes (b) and (d).
- P3 COMMON DRAIN CONNECTION, (WHEN DRAIN TO LOAD END IS SPECIFIED). 2" FPT. 4-1/2" AFF
- P4 COMMON DRAIN CONNECTION, (WHEN DRAIN TO UNLOAD END OPTION IS SPECIFIED). 2" FPT. 4-1/2" AFF
- P5 COLD WATER CONNECTION, (WHEN PREWASH TEMPERATURE CONTROL OPTION IS SPECIFIED WITHOUT ENERGY RECOVERY). 1" FPT. 14-1/2" AFF
- P6 COMMON HOT WATER CONNECTION, (AUTOMATIC FILL) (WHEN ELECTRIC BOOSTER OR ENERGY RECOVERY OPTION IS SPECIFIED). 1" FPT. 140° F WATER MINIMUM. 7-5/16" AFF see notes (b) and (d).
- P7 COLD WATER CONNECTION, (WHEN ENERGY RECOVERY OPTION IS SPECIFIED WITH OR WITHOUT THE PREWASH TEMPERATURE CONTROL OPTION). 55° F WATER MINIMUM. 1" FPT. 10" AFF see notes (c) and (d)

## VENTILATION CONNECTIONS:

- V1 CUSTOMER'S VENT CONNECTION, (WHEN NOT SUPPLIED WITH ENERGY RECOVERY) MUST FIT INSIDE 16" DIAMETER VENT STACK, 750 CFM (AT STANDARD AIR CONDITIONS) EXHAUST REQUIRED. 78-3/4" AFF see note (e).
- V2 CUSTOMER'S VENT CONNECTION, (WHEN ENERGY RECOVERY OPTION IS SPECIFIED) MUST FIT INSIDE 16" DIAMETER VENT STACK, 750 CFM (AT STANDARD AIR CONDITIONS) EXHAUST REQUIRED. 87-5/8" AFF see notes (e) and (f).

## GENERAL NOTES:

- (a) THE CONTROL BOX IS ATTACHED TO THE CENTER SECTION, AND THE CONTROL BOX IS ROTATED 90 DEGREES ALLOWING THE CENTER SECTION TO FIT THROUGH A 42" WIDE, 7' DOOR OPENING.  
WITH BACK PANEL AND END CAPS REMOVED, CONTROL PANEL HINGED BACK AND ALL REAR PIPING REMOVED, OVERALL WIDTH OF MACHINE IS 39-1/8".  
AFF = ABOVE FINISHED FLOOR  
ALL DIMENSIONS TAKE FROM THE FLOOR LINE MAY INCREASE 2-1/2" OR DECREASE 1/2" WITH LEG ADJUSTMENT.  
FOR CONVENIENCE WHEN CLEANING, CUSTOMER SHOULD INSTALL WATER TAP NEAR MACHINE WITH 30 FT. OF HEAVY DUTY HOSE WITH SQUEEZE VALVE.  
THIS DRAWING IS SUPPLIED AS A REFERENCE FOR CONNECTION INFORMATION ONLY. IT WILL NOT BE UTILIZED FOR MANUFACTURING OF UNIT.

## ELECTRICAL WARNING:

ELECTRICAL AND GROUNDING CONNECTIONS MUST COMPLY WITH THE APPLICABLE PORTIONS OF THE NATIONAL ELECTRICAL CODE AND/OR OTHER ELECTRICAL CODES.  
SERVICE WIRE TEMPERATURE RATING: 90°C.

## PLUMBING NOTES:

- PLUMBING CONNECTIONS MUST COMPLY WITH APPLICABLE SANITARY, SAFETY AND PLUMBING CODES.  
RECOMMENDED WATER HARDNESS TO BE 3 GRAINS OR LESS PER GALLON FOR BEST RESULTS.
- (b) RECOMMENDED BUILDING FLOWING HOT WATER PRESSURE TO THE DISHWASHER IS 30-35 PSI.
- (c) RECOMMENDED BUILDING FLOWING COLD WATER PRESSURE TO THE DISHWASHER IS 45-50 PSI WHEN THE ENERGY RECOVERY OPTION IS SPECIFIED. IF COLD WATER IS LESS THAN 55°F CONTACT SALES ENGINEERING.
- (d) WATER HAMMER ARRESTOR (MEETING ASSE-1010 STANDARD OR EQUIVALENT) TO BE SUPPLIED (BY OTHERS) IN FINAL RINSE WATER SUPPLY LINE AT SERVICE CONNECTION.

## VENTILATION NOTES:

- (e) THIS DIMENSION IS SUBJECT TO NORMAL SHEET METAL TOLERANCES
- (f) THE VENT STACK CAN BE TEMPORARILY REMOVED FROM THE ENERGY RECOVERY UNIT TO YIELD 79" CLEARANCE FOR DOORWAYS.

SERVICE CONNECTION W/O CIRCUIT BREAKERS (3) SERVICE CONNECTIONS AS SHOWN BELOW			
ELECTRIC TANK HEAT, POWER WASH & POWER RINSE (2) 26 KW CONNECTIONS, EACH AS SHOWN BELOW			
ELEC. SPECS.	RATED AMPS	MINIMUM SUPPLY CONDUCTOR AMPACITY	MAXIMUM PROTECTIVE DEVICES
208/60/3	TWO @ 77.7 EA.	100	100
240/60/3	TWO @ 74.0 EA.	100	100
480/60/3	TWO @ 37.0 EA.	45	45
MOTORS AND CONTROLS (1) SERVICE CONNECTION AS SHOWN BELOW			
ELEC. SPECS.	RATED AMPS	MINIMUM SUPPLY CONDUCTOR AMPACITY	MAXIMUM PROTECTIVE DEVICE
208-240/60/3	29.9	40	40
480/60/3	17.5	25	25

SERVICE CONNECTION WITH CIRCUIT BREAKERS (1) SERVICE CONNECTION AS SHOWN BELOW			
MOTORS, CONTROLS AND TANK HEAT			
ELEC. SPECS.	RATED AMPS	MINIMUM SUPPLY CONDUCTOR AMPACITY	MAXIMUM PROTECTIVE DEVICES
208/60/3	185.3	225	225
240/60/3	177.9	225	225
480/60/3	91.5	125	125

MOTORS	FT900
PREWASH	3 H.P.
POWER WASH	3 H.P.
POWER RINSE	3 H.P.
CONVEYOR	1/2 H.P.

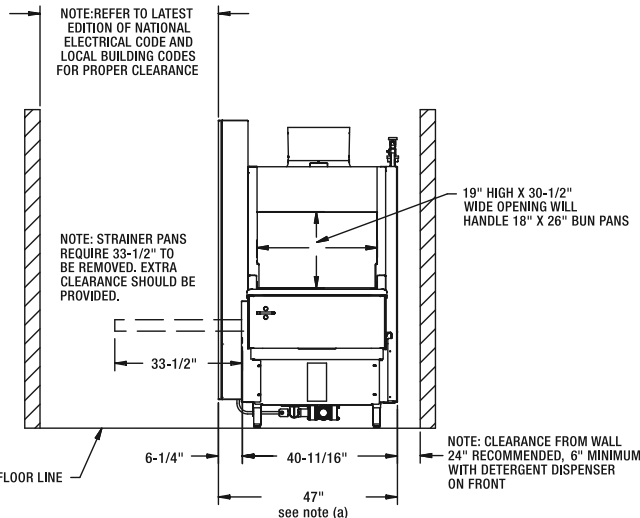

MODEL NO.	"A"	"B"	"C"	DIM "E" COMMON DRAIN CONNECTION	
				5' 7", 9" UNLOADS	11" UNLOAD
FT918 (5-8-5)	18'-0"	5'-0"	5'-0"	51-5/32"	-
FT920 (7-8-5)	20'-0"	5'-0"	7'-0"		-
FT920 (5-8-7)	20'-0"	7'-0"	5'-0"		-
FT922 (7-8-7)	22'-0"	7'-0"	7'-0"		-
FT922 (5-8-9)	22'-0"	9'-0"	5'-0"		-
FT924 (7-8-9)	24'-0"	9'-0"	7'-0"		-
FT924 (5-8-11)	24'-0"	11'-0"	5'-0"	-	117-5/32"
FT926 (7-8-11)	26'-0"	11'-0"	7'-0"	-	-

NOTE: OVERALL LENGTH OF MACHINE IS DIMENSION "A" + 10 1/2".

30KW BOOSTER CAN BE USED WITH OR WITHOUT ENERGY RECOVERY INCOMING WATER TEMPERATURE OF 105°F OR ABOVE (1) SERVICE CONNECTION AS SHOWN BELOW			
ELEC. SPECS.	RATED AMPS	MINIMUM SUPPLY CONDUCTOR AMPACITY	MAXIMUM PROTECTIVE DEVICES
208/60/3	92.4	125	125
240/60/3	80.1	100	100
480/60/3	40.1	50	50

\*15KW BOOSTER AVAILABLE FOR SPECIFIC APPLICATIONS  
CONTACT HOBART SALES ENGINEERING

MODEL:  
FT900 ELECTRIC  
L-R OPERATION  
00-919089  
REV E





701 S Ridge Avenue, Troy, OH 45374  
1-888-4HOBART • www.hobartcorp.com

# FT900 ELECTRIC R-L

## ELECTRICAL CONNECTIONS COMMON ON ALL MODELS:

- E1 ELECTRIC CONNECTION, DETERGENT AND RINSE FEEDERS (MACHINE SERVICE VOLTAGE), 1/2" CONDUIT, 76-7/8" AFF
- E2 ELECTRIC CONNECTION, VENT FAN CONTROL (SWITCH CONTACTS) 1/2" CONDUIT, 79-3/8" AFF

## ELECTRICAL CONNECTIONS W/O CIRCUIT BREAKERS:

- E3 ELECTRIC CONNECTION, MOTORS & CONTROLS, 1" CONDUIT, 78-1/8" AFF
- E4 ELECTRIC TANK HEAT CONNECTION, 26 KW, 1" CONDUIT, 78-1/8" AFF
- E5 ELECTRIC TANK HEAT CONNECTION, 26 KW, 1" CONDUIT, 78-1/8" AFF
- E6 ELECTRIC CONNECTION, (OPTIONAL) ELECTRIC BOOSTER, 1-1/2" CONDUIT, 18-1/8" AFF

## ELECTRICAL CONNECTIONS WITH CIRCUIT BREAKERS:

- E7 ELECTRIC CONNECTION, MOTORS, CONTROLS AND TANK HEAT (WHEN CIRCUIT BREAKER OPTION IS SPECIFIED), 2" CONDUIT, 78-1/8" AFF
- E8 ELECTRIC CONNECTION, (OPTIONAL) ELECTRIC BOOSTER, 1-1/2" CONDUIT, 18-1/8" AFF

## PLUMBING CONNECTIONS:

- P1 FILL CONNECTION, (WHEN NO BOOSTER IS SPECIFIED), AUTOMATIC FILL, 140° F WATER, 1" FPT, 7-5/16" AFF
- P2 FINAL RINSE CONNECTION, (WHEN NOT SUPPLIED WITH BOOSTER WATER HEATER) 3/4" FPT, 180° F WATER MINIMUM, 11-9/16" AFF see notes (b) and (d).
- P3 COMMON DRAIN CONNECTION, (WHEN DRAIN TO LOAD END IS SPECIFIED), 2" FPT, 4-1/2" AFF
- P4 COMMON DRAIN CONNECTION, (WHEN DRAIN TO UNLOAD END OPTION IS SPECIFIED), 2" FPT, 4-1/2" AFF
- P5 COLD WATER CONNECTION, (WHEN PREWASH TEMPERATURE CONTROL OPTION IS SPECIFIED WITHOUT ENERGY RECOVERY), 1" FPT, 14-1/2" AFF
- P6 COMMON HOT WATER CONNECTION, (AUTOMATIC FILL) (WHEN ELECTRIC BOOSTER OR ENERGY RECOVERY OPTION IS SPECIFIED), 1" FPT, 140° F WATER MINIMUM, 7-5/16" AFF see notes (b) and (d).
- P7 COLD WATER CONNECTION, (WHEN ENERGY RECOVERY OPTION IS SPECIFIED WITH OR WITHOUT THE PREWASH TEMPERATURE CONTROL OPTION), 55° F WATER MINIMUM, 1" FPT, 10" AFF see notes (c) and (d)

## VENTILATION CONNECTIONS:

- V1 CUSTOMER'S VENT CONNECTION, (WHEN NOT SUPPLIED WITH ENERGY RECOVERY) MUST FIT INSIDE 16" DIAMETER VENT STACK, 750 CFM (AT STANDARD AIR CONDITIONS) EXHAUST REQUIRED, 78-3/4" AFF see note (e).
- V2 CUSTOMER'S VENT CONNECTION, (WHEN ENERGY RECOVERY OPTION IS SPECIFIED) MUST FIT INSIDE 16" DIAMETER VENT STACK, 750 CFM (AT STANDARD AIR CONDITIONS) EXHAUST REQUIRED, 87-5/8" AFF see notes (e) and (f).

## GENERAL NOTES:

- (a) THE CONTROL BOX IS ATTACHED TO THE CENTER SECTION, AND THE CONTROL BOX IS ROTATED 90 DEGREES ALLOWING THE CENTER SECTION TO FIT THROUGH A 42" WIDE, 7' DOOR OPENING.  
WITH BACK PANEL AND END CAPS REMOVED, CONTROL PANEL HINGED BACK AND ALL REAR PIPING REMOVED, OVERALL WIDTH OF MACHINE IS 39-1/8".  
AFF = ABOVE FINISHED FLOOR  
ALL DIMENSIONS TAKE FROM THE FLOOR LINE MAY INCREASE 2-1/2" OR DECREASE 1/2" WITH LEG ADJUSTMENT.  
FOR CONVENIENCE WHEN CLEANING, CUSTOMER SHOULD INSTALL WATER TAP NEAR MACHINE WITH 30 FT. OF HEAVY DUTY HOSE WITH SQUEEZE VALVE.  
THIS DRAWING IS SUPPLIED AS A REFERENCE FOR CONNECTION INFORMATION ONLY. IT WILL NOT BE UTILIZED FOR MANUFACTURING OF UNIT.

## ELECTRICAL WARNING:

ELECTRICAL AND GROUNDING CONNECTIONS MUST COMPLY WITH THE APPLICABLE PORTIONS OF THE NATIONAL ELECTRICAL CODE AND/OR OTHER ELECTRICAL CODES.  
SERVICE WIRE TEMPERATURE RATING: 90°C.

## PLUMBING NOTES:

- PLUMBING CONNECTIONS MUST COMPLY WITH APPLICABLE SANITARY, SAFETY AND PLUMBING CODES.  
RECOMMENDED WATER HARDNESS TO BE 3 GRAINS OR LESS PER GALLON FOR BEST RESULTS.
- (b) RECOMMENDED BUILDING FLOWING HOT WATER PRESSURE TO THE DISHWASHER IS 30-35 PSI.
- (c) RECOMMENDED BUILDING FLOWING COLD WATER PRESSURE TO THE DISHWASHER IS 45-50 PSI WHEN THE ENERGY RECOVERY OPTION IS SPECIFIED. IF COLD WATER IS LESS THAN 55°F CONTACT SALES ENGINEERING.
- (d) WATER HAMMER ARRESTOR (MEETING ASSE-1010 STANDARD OR EQUIVALENT) TO BE SUPPLIED (BY OTHERS) IN FINAL RINSE WATER SUPPLY LINE AT SERVICE CONNECTION.

## VENTILATION NOTES:

- (e) THIS DIMENSION IS SUBJECT TO NORMAL SHEET METAL TOLERANCES
- (f) THE VENT STACK CAN BE TEMPORARILY REMOVED FROM THE ENERGY RECOVERY UNIT TO YIELD 79" CLEARANCE FOR DOORWAYS.

SERVICE CONNECTION W/O CIRCUIT BREAKERS (3) SERVICE CONNECTIONS AS SHOWN BELOW			
ELECTRIC TANK HEAT, POWER WASH & POWER RINSE (2) 26 KW CONNECTIONS, EACH AS SHOWN BELOW			
ELEC. SPECS.	RATED AMPS	MINIMUM SUPPLY CONDUCTOR AMPACITY	MAXIMUM PROTECTIVE DEVICES
208/60/3	TWO @ 77.7 EA.	100	100
240/60/3	TWO @ 74.0 EA.	100	100
480/60/3	TWO @ 37.0 EA.	45	45
MOTORS AND CONTROLS (1) SERVICE CONNECTION AS SHOWN BELOW			
ELEC. SPECS.	RATED AMPS	MINIMUM SUPPLY CONDUCTOR AMPACITY	MAXIMUM PROTECTIVE DEVICE
208-240/60/3	29.9	40	40
480/60/3	17.5	25	25

SERVICE CONNECTION WITH CIRCUIT BREAKERS (1) SERVICE CONNECTION AS SHOWN BELOW			
MOTORS, CONTROLS AND TANK HEAT			
ELEC. SPECS.	RATED AMPS	MINIMUM SUPPLY CONDUCTOR AMPACITY	MAXIMUM PROTECTIVE DEVICES
208/60/3	185.3	225	225
240/60/3	177.9	225	225
480/60/3	91.5	125	125

MOTORS	FT900
PREWASH	3 H.P.
POWER WASH	3 H.P.
POWER RINSE	3 H.P.
CONVEYOR	1/2 H.P.

MODEL NO.	"A"	"B"	"C"	DIM "E" COMMON DRAIN CONNECTION	
				5' 7", 9" UNLOADS	11" UNLOAD
FT918 (5-8-5)	18'-0"	5'-0"	5'-0"	51-5/32"	-
FT920 (7-8-5)	20'-0"	5'-0"	7'-0"		-
FT920 (5-8-7)	20'-0"	7'-0"	5'-0"		-
FT922 (7-8-7)	22'-0"	7'-0"	7'-0"		-
FT922 (5-8-9)	22'-0"	9'-0"	5'-0"		-
FT924 (7-8-9)	24'-0"	9'-0"	7'-0"		-
FT924 (5-8-11)	24'-0"	11'-0"	5'-0"	-	117-5/32"
FT926 (7-8-11)	26'-0"	11'-0"	7'-0"	-	-

NOTE: OVERALL LENGTH OF MACHINE IS DIMENSION "A" + 10 1/2".

30KW BOOSTER CAN BE USED WITH OR WITHOUT ENERGY RECOVERY INCOMING WATER TEMPERATURE OF 105°F OR ABOVE (1) SERVICE CONNECTION AS SHOWN BELOW			
ELEC. SPECS.	RATED AMPS	MINIMUM SUPPLY CONDUCTOR AMPACITY	MAXIMUM PROTECTIVE DEVICES
208/60/3	92.4	125	125
240/60/3	80.1	100	100
480/60/3	40.1	50	50

\*15KW BOOSTER AVAILABLE FOR SPECIFIC APPLICATIONS  
CONTACT HOBART SALES ENGINEERING

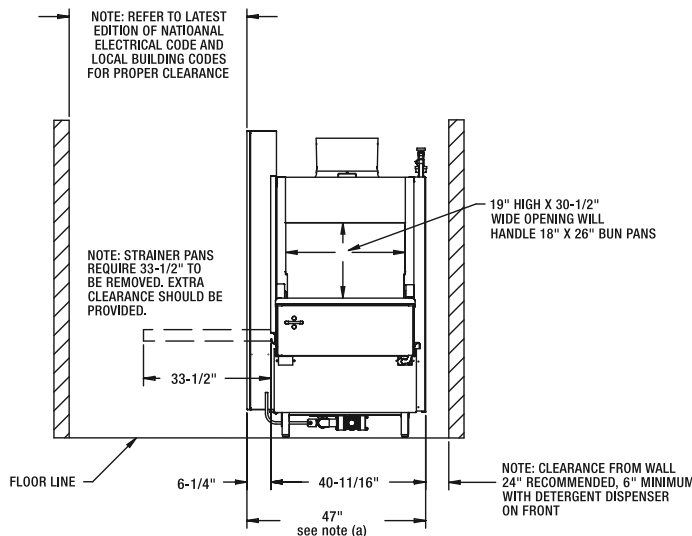

MODEL:  
FT900 ELECTRIC  
R-L OPERATION  
00-919088  
REV E

# FT900 STEAM L-R



701 S Ridge Avenue, Troy, OH 45374  
1-888-4HOBART • www.hobartcorp.com

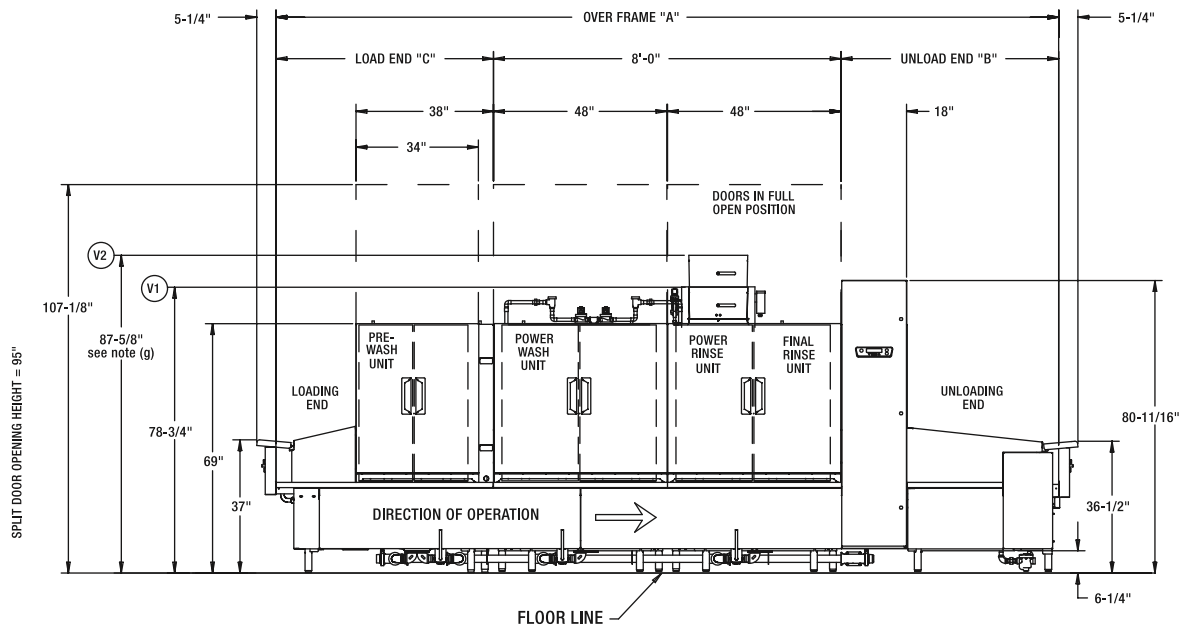
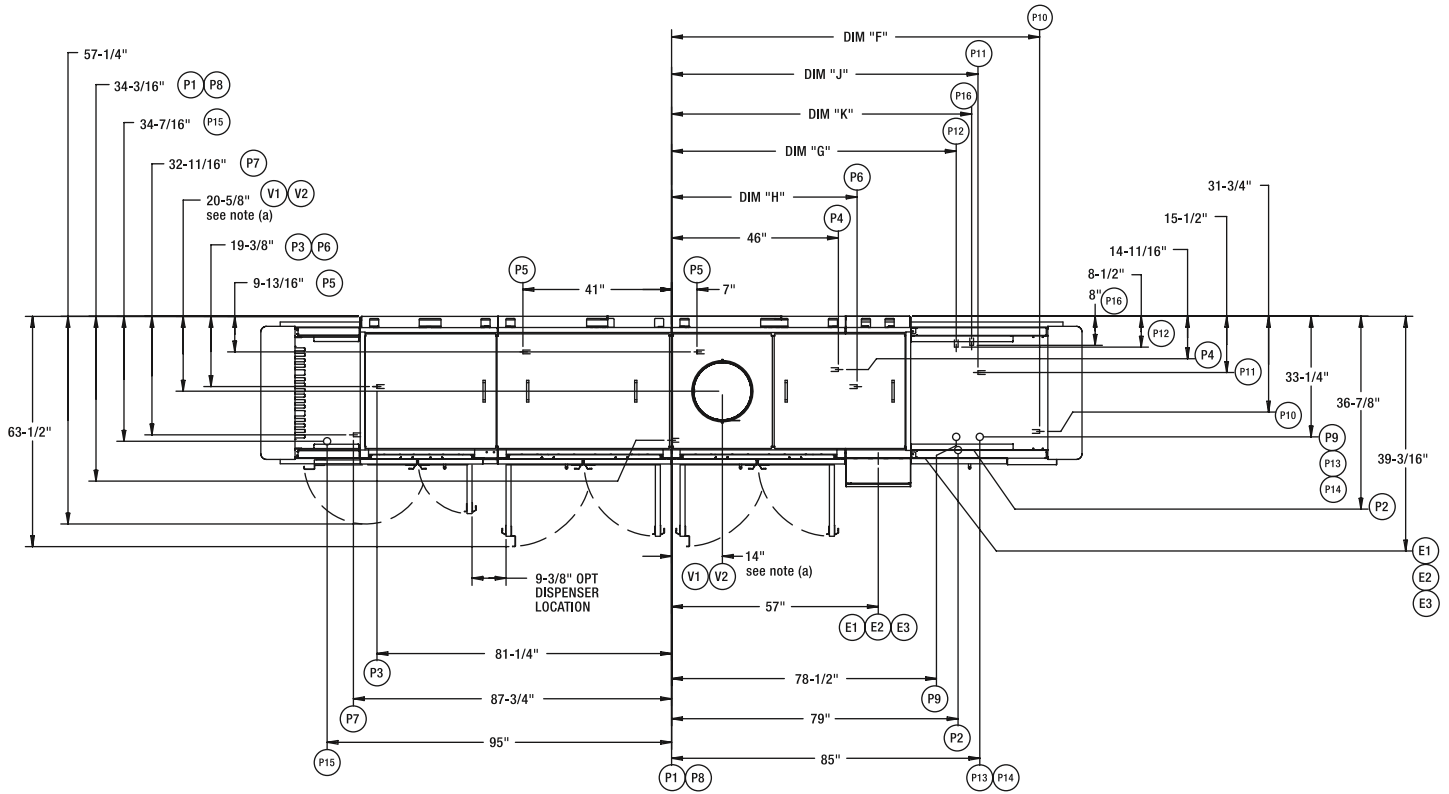





701 S Ridge Avenue, Troy, OH 45374  
1-888-4HOBART • www.hobartcorp.com

# FT900 STEAM L-R

### ELECTRICAL CONNECTIONS COMMON ON ALL MODELS:

- E1 ELECTRIC CONNECTION, DETERGENT AND RINSE FEEDERS (MACHINE SERVICE VOLTAGE), 1/2" CONDUIT, 76-7/8" AFF
- E2 ELECTRIC CONNECTION, VENT FAN CONTROL, (SWITCH CONTACTS) 1/2" CONDUIT, 79-3/8" AFF
- E3 ELECTRIC CONNECTION, MOTORS AND CONTROLS, 1" CONDUIT, 78-1/8" AFF

### PLUMBING CONNECTIONS:

- P1 FILL CONNECTION, (WHEN NO BOOSTER IS SPECIFIED), AUTOMATIC FILL, 140°F WATER, 1" FPT, 7-5/16" AFF
- P2 FINAL RINSE CONNECTION, (WHEN NOT SUPPLIED WITH BOOSTER WATER HEATER) 3/4" FPT, 180°F WATER MINIMUM, 11-9/16" AFF see notes (b) and (d).
- P3 COMMON DRAIN CONNECTION, (WHEN DRAIN TO LOAD END IS SPECIFIED), 2" FPT, 4-1/2" AFF
- P4 STEAM CONNECTION, REGULATED TANK HEAT (WHEN NO BOOSTER IS SPECIFIED), 50 P.S.I. MAX., 15-25 FLOWING PRESSURE, 1" FPT, 4-3/4" AFF see note (e).
- P5 CONDENSATE RETURN, GRAVITY CONNECTION (WHEN OPTIONAL STEAM COILS ARE SPECIFIED), BUCKET TYPE TRAPS FURNISHED, 2 CONNECTIONS, 3/4" FPT, 4-3/4" AFF
- P6 COMMON DRAIN CONNECTION, (WHEN DRAIN TO UNLOAD END OPTION IS SPECIFIED), 2" FPT, 4-1/2" AFF
- P7 COLD WATER CONNECTION, (WHEN PREWASH TEMPERATURE CONTROL OPTION IS SPECIFIED WITHOUT ENERGY RECOVERY), 1" FPT, 14-1/2" AFF
- P8 COMMON HOT WATER CONNECTION, (AUTOMATIC FILL) (WHEN STEAM BOOSTER OR ENERGY RECOVERY OPTION IS SPECIFIED), 1" FPT, 140°F WATER MINIMUM, 7-5/16" AFF see notes (b) and (d).
- P9 COMMON STEAM CONNECTION, (WHEN TANK HEAT AND OPTIONAL STEAM BOOSTER ARE SPECIFIED), 1-1/2" FPT, 8-1/8" AFF (50 P.S.I. MAX., 15-25 FLOWING PRESSURE) see note (e).
- P10 CONDENSATE RETURN, (GRAVITY CONNECTION) (WHEN STEAM BOOSTER OPTION IS SPECIFIED), 3/4" FPT, BUCKET TYPE TRAP FURNISHED, 3-3/4" AFF
- P11 STEAM RELIEF VALVE, (WHEN STEAM BOOSTER OPTION IS SPECIFIED), 1" FPT, MUST BE PIPED TO OPEN DRAIN RECEIVER IN THE FLOOR, 13-1/2" AFF
- P12 HOT WATER RELIEF VALVE, (WHEN STEAM BOOSTER OPTION IS SPECIFIED), 3/4" FPT, MUST BE PIPED TO OPEN DRAIN RECEIVER IN THE FLOOR, 15-1/2" AFF
- P13 COMMON STEAM CONNECTION, (WHEN DOUBLE STEAM INJECTOR TANK HEAT OPTION IS SPECIFIED WITHOUT A STEAM BOOSTER) 3" FPT 6-3/4" AFF, (50 PSI MAX., 15-25 FLOWING PRESSURE) see note (e).
- P14 COMMON STEAM CONNECTION, (WHEN BOTH THE DOUBLE STEAM INJECTOR TANK HEAT AND STEAM BOOSTER OPTIONS ARE SPECIFIED), 3" FPT, 6-3/4" AFF, (50 PSI MAX., 15-25 FLOWING PRESSURE) see note (e).
- P15 COLD WATER CONNECTION, (WHEN ENERGY RECOVERY OPTION IS SPECIFIED WITH OR WITHOUT THE PREWASH TEMPERATURE CONTROL OPTION), 55°F WATER MINIMUM, 1" FPT, 10" AFF see notes (c) and (d).
- P16 HOT WATER RELIEF VALVE, (WHEN ENERGY RECOVERY OPTION IS SPECIFIED), 1/2" FPT, MUST BE PIPED TO OPEN DRAIN RECEIVER IN THE FLOOR, 15-1/2" AFF

### VENTILATION CONNECTIONS:

- V1 CUSTOMER'S VENT CONNECTION, (WHEN NOT SUPPLIED WITH ENERGY RECOVERY) MUST FIT INSIDE 16" DIAMETER VENT STACK, 750 CFM (AT STANDARD AIR CONDITIONS) EXHAUST REQUIRED, 78-3/4" AFF see note (f)
- V2 CUSTOMER'S VENT CONNECTION, (WHEN ENERGY RECOVERY OPTION IS SPECIFIED) MUST FIT INSIDE 16" DIAMETER VENT STACK, 750 CFM (AT STANDARD AIR CONDITIONS) EXHAUST REQUIRED, 87-5/8" AFF see notes (f) and (g)

### GENERAL NOTES:

- (a) THE CONTROL BOX IS ATTACHED TO THE CENTER SECTION, AND THE CONTROL BOX IS ROTATED 90 DEGREES ALLOWING THE CENTER SECTION TO FIT THROUGH A 42" WIDE, 7" DOOR OPENING.  
WITH BACK PANEL AND END CAPS REMOVED, CONTROL PANEL HINGED BACK AND ALL REAR PIPING REMOVED, OVERALL WIDTH OF MACHINE IS 39-1/8".  
AFF = ABOVE FINISHED FLOOR  
ALL DIMENSIONS TAKE FROM THE FLOOR LINE MAY INCREASE 2-1/2" OR DECREASE 1/2" WITH LEG ADJUSTMENT.  
FOR CONVENIENCE WHEN CLEANING, CUSTOMER SHOULD INSTALL WATER TAP NEAR MACHINE WITH 30 FT. OF HEAVY DUTY HOSE WITH SQUEEZE VALVE.  
THIS DRAWING IS SUPPLIED AS A REFERENCE FOR CONNECTION INFORMATION ONLY. IT WILL NOT BE UTILIZED FOR MANUFACTURING OF UNIT.

### ELECTRICAL WARNING:

ELECTRICAL AND GROUNDING CONNECTIONS MUST COMPLY WITH THE APPLICABLE PORTIONS OF THE NATIONAL ELECTRICAL CODE AND/OR OTHER ELECTRICAL CODES.  
SERVICE WIRE TEMPERATURE RATING: 90°C.

### PLUMBING NOTES:

- (a) PLUMBING CONNECTIONS MUST COMPLY WITH APPLICABLE SANITARY, SAFETY AND PLUMBING CODES. RECOMMENDED WATER HARDNESS TO BE 3 GRAINS OR LESS PER GALLON FOR BEST RESULTS.
- (b) RECOMMENDED BUILDING FLOWING HOT WATER PRESSURE TO THE DISHWASHER IS 30-35 PSI.
- (c) RECOMMENDED BUILDING FLOWING COLD WATER PRESSURE TO THE DISHWASHER IS 45-50 PSI WHEN THE ENERGY RECOVERY OPTION IS SPECIFIED. IF COLD WATER IS LESS THAN 55°F CONTACT SALES ENGINEERING.
- (d) WATER HAMMER ARRESTOR (MEETING ASSE-1010 STANDARD OR EQUIVALENT) TO BE SUPPLIED (BY OTHERS) IN FINAL RINSE WATER SUPPLY LINE AT SERVICE CONNECTION.
- (e) IF STEAM PRESSURE IS UNDER 15 PSI AT THE DISHWASHER, CONTACT SALES ENGINEERING.

### VENTILATION NOTES:

- (f) THIS DIMENSION IS SUBJECT TO NORMAL SHEET METAL TOLERANCES
- (g) THE VENT STACK CAN BE TEMPORARILY REMOVED FROM THE ENERGY RECOVERY UNIT TO YIELD 79" CLEARANCE FOR DOORWAYS.

MODEL NO.	"A"	"B"	"C"	DIM "E" STEAM BOOSTER CONDENSATE RETURN		DIM "G" STEAM BOOSTER HOT WATER RELIEF VALVE		DIM "H" COMMON DRAIN CONNECTION		DIM "J" STEAM BOOSTER STEAM RELIEF VALVE		DIM "K" ENERGY RECOVERY HOT WATER RELIEF VALVE	
				WITH STEAM COIL OR SINGLE STEAM INJECTOR	WITH DOUBLE STEAM INJECTOR	WITH STEAM COIL OR SINGLE STEAM INJECTOR	WITH DOUBLE STEAM INJECTOR	5", 7", 9" UNLOADS	11" UNLOAD	WITH STEAM COIL OR SINGLE STEAM INJECTOR	WITH DOUBLE STEAM INJECTOR	WITH STEAM COIL OR SINGLE STEAM INJECTOR	WITH DOUBLE STEAM INJECTOR
FT918 (5-8-5)	18'-0"	5'-0"	5'-0"										
FT920 (7-8-5)	20'-0"	5'-0"	7'-0"										
FT920 (5-8-7)	20'-0"	7'-0"	5'-0"										
FT922 (7-8-7)	22'-0"	7'-0"	7'-0"	101-1/2"	110-3/4"	78-1/2"	87-11/16"	51-5/32"		84-1/2"	93-3/4"	82-3/4"	91-15/16"
FT922 (5-8-9)	22'-0"	9'-0"	5'-0"										
FT924 (7-8-9)	24'-0"	9'-0"	7'-0"										
FT924 (5-8-11)	24'-0"	11'-0"	5'-0"										
FT926 (7-8-11)	26'-0"	11'-0"	7'-0"						117-5/32"				

NOTE: OVERALL LENGTH OF MACHINE IS DIMENSION "A" + 10 1/2".

NOTE: REFER TO LATEST EDITION OF NATIONAL ELECTRICAL CODE AND LOCAL BUILDING CODES FOR PROPER CLEARANCE

NOTE: STRAINER PANS REQUIRE 33-1/2" TO BE REMOVED. EXTRA CLEARANCE SHOULD BE PROVIDED.

19" HIGH X 30-1/2" WIDE OPENING WILL HANDLE 18" X 26" BUN PANS

NOTE: CLEARANCE FROM WALL 24" RECOMMENDED, 6" MINIMUM WITH DETERGENT DISPENSER ON FRONT

MOTORS	FT900
PREWASH	3 H.P.
POWER WASH	3 H.P.
POWER RINSE	3 H.P.
CONVEYOR	1/2 H.P.

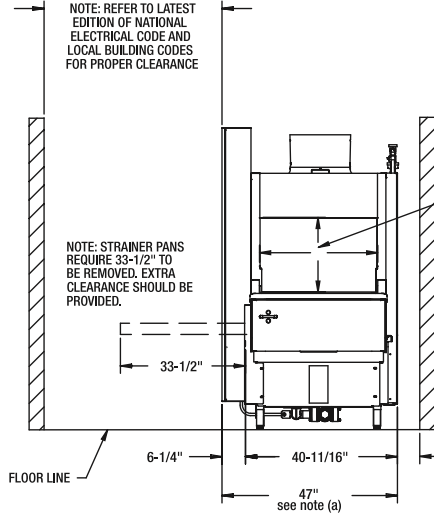

SERVICE CONNECTION WITH OR W/O CIRCUIT BREAKERS (1) SERVICE CONNECTION AS SHOWN BELOW			
MOTORS AND CONTROLS			
ELEC. SPECS.	RATED AMPS	MINIMUM SUPPLY CONDUCTOR AMPACITY	MAXIMUM PROTECTIVE DEVICE
208-240/60/3	29.9	40	40
480/60/3	17.5	25	25

MODEL:  
FT900 STEAM  
L-R OPERATION  
00-919089  
REV E

# FT900 STEAM R-L



701 S Ridge Avenue, Troy, OH 45374  
1-888-4HOBART • www.hobartcorp.com

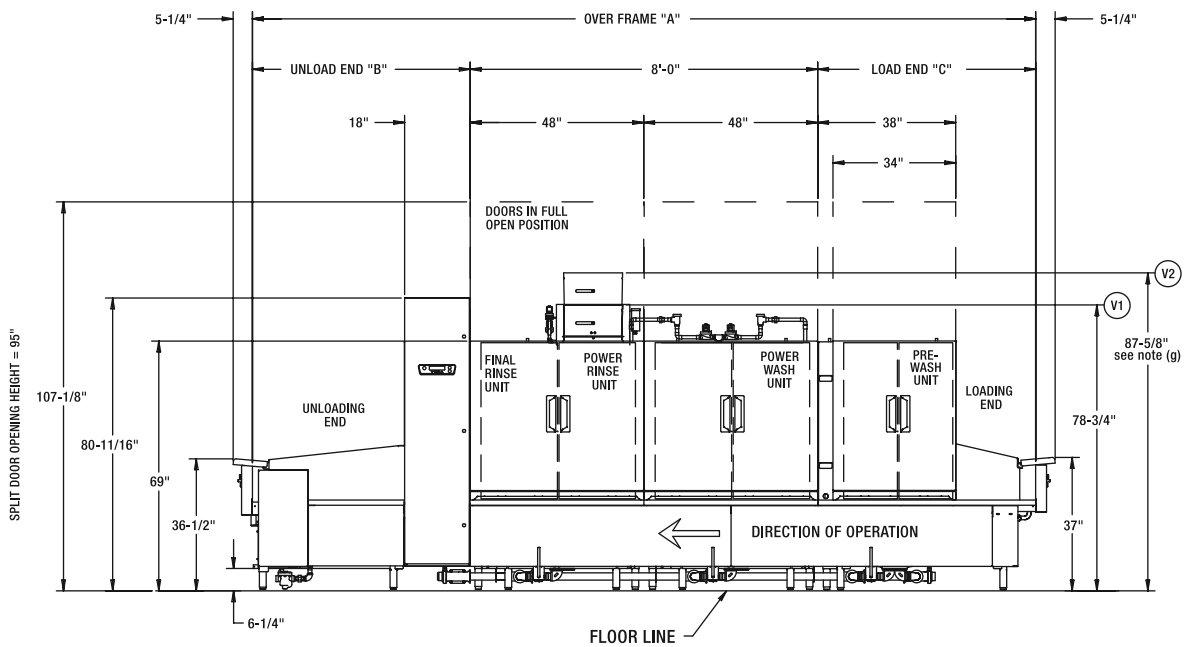
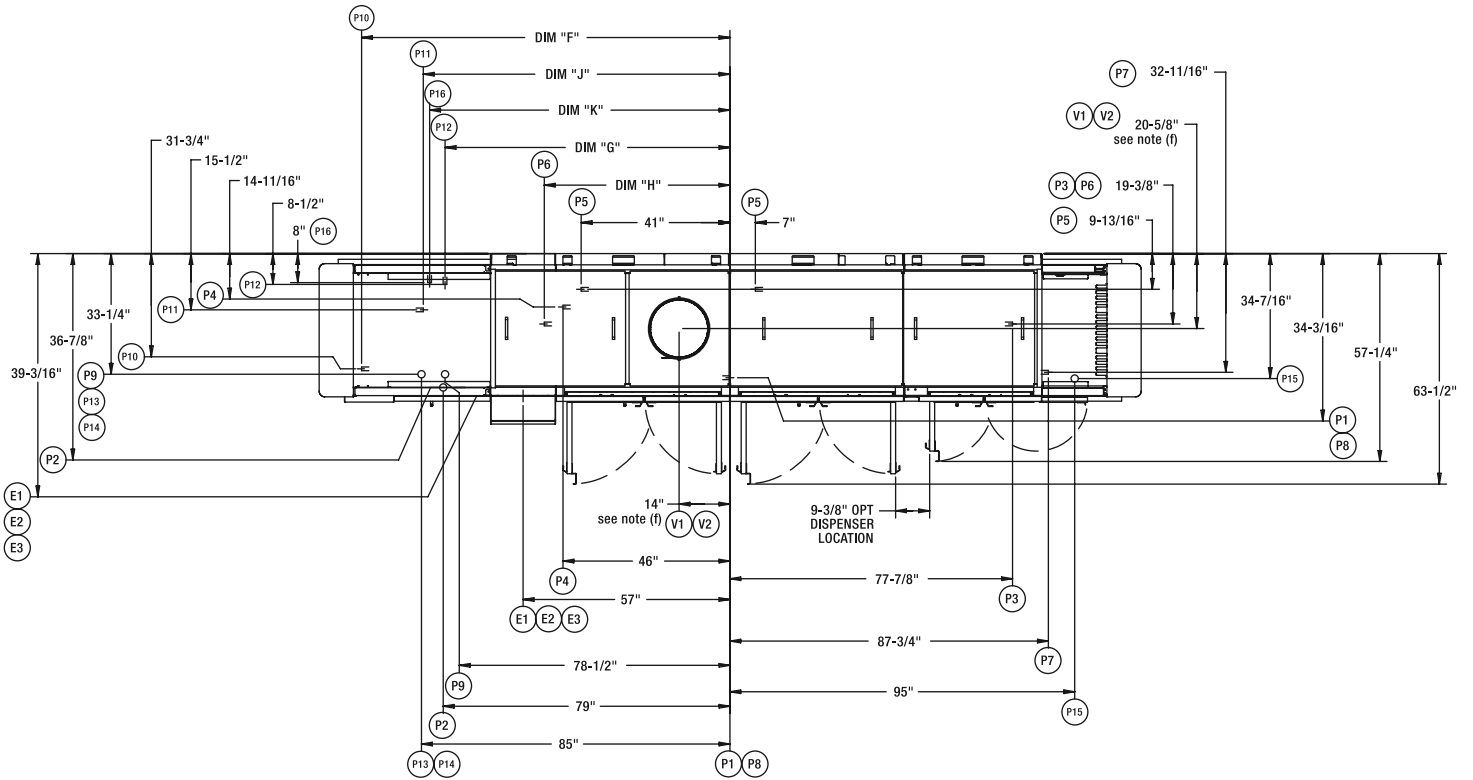



701 S Ridge Avenue, Troy, OH 45374  
1-888-4HOBART • www.hobartcorp.com

# FT900 STEAM R-L

### ELECTRICAL CONNECTIONS COMMON ON ALL MODELS:

- E1 ELECTRIC CONNECTION, DETERGENT AND RINSE FEEDERS (MACHINE SERVICE VOLTAGE), 1/2" CONDUIT, 76-7/8" AFF
- E2 ELECTRIC CONNECTION, VENT FAN CONTROL (SWITCH CONTACTS) 1/2" CONDUIT, 79-3/8" AFF
- E3 ELECTRIC CONNECTION, MOTORS AND CONTROLS, 1" CONDUIT, 78-1/8" AFF

### PLUMBING CONNECTIONS:

- P1 FILL CONNECTION, (WHEN NO BOOSTER IS SPECIFIED). AUTOMATIC FILL, 140°F WATER, 1" FPT. 7-5/16" AFF
- P2 FINAL RINSE CONNECTION, (WHEN NOT SUPPLIED WITH BOOSTER WATER HEATER) 3/4" FPT. 180°F WATER MINIMUM. 11-9/16" AFF see notes (b) and (d).
- P3 COMMON DRAIN CONNECTION, (WHEN DRAIN TO LOAD END IS SPECIFIED), 2" FPT. 4-1/2" AFF
- P4 STEAM CONNECTION, REGULATED TANK HEAT (WHEN NO BOOSTER IS SPECIFIED), 50 P.S.I. MAX., 15-25 FLOWING PRESSURE. 1" FPT. 4-3/4" AFF see note (e).
- P5 CONDENSATE RETURN, GRAVITY CONNECTION (WHEN OPTIONAL STEAM COILS ARE SPECIFIED), BUCKET TYPE TRAPS FURNISHED, 2 CONNECTIONS, 3/4" FPT. 4-3/4" AFF
- P6 COMMON DRAIN CONNECTION, (WHEN DRAIN TO UNLOAD END OPTION IS SPECIFIED), 2" FPT. 4-1/2" AFF
- P7 COLD WATER CONNECTION, (WHEN PREWASH TEMPERATURE CONTROL OPTION IS SPECIFIED WITHOUT ENERGY RECOVERY), 1" FPT. 14-1/2" AFF
- P8 COMMON HOT WATER CONNECTION, (AUTOMATIC FILL) (WHEN STEAM BOOSTER OR ENERGY RECOVERY OPTION IS SPECIFIED), 1" FPT, 140°F WATER MINIMUM. 7-5/16" AFF see notes (b) and (d).
- P9 COMMON STEAM CONNECTION, (WHEN TANK HEAT AND OPTIONAL STEAM BOOSTER ARE SPECIFIED), 1-1/2" FPT, 8-1/8" AFF (50 P.S.I. MAX., 15-25 FLOWING PRESSURE) see note (e).
- P10 CONDENSATE RETURN, (GRAVITY CONNECTION) (WHEN STEAM BOOSTER OPTION IS SPECIFIED), 3/4" FPT, BUCKET TYPE TRAP FURNISHED. 3-3/4" AFF
- P11 STEAM RELIEF VALVE, (WHEN STEAM BOOSTER OPTION IS SPECIFIED), 1" FPT, MUST BE PIPED TO OPEN DRAIN RECEIVER IN THE FLOOR. 13-1/2" AFF
- P12 HOT WATER RELIEF VALVE, (WHEN STEAM BOOSTER OPTION IS SPECIFIED), 3/4" FPT, MUST BE PIPED TO OPEN DRAIN RECEIVER IN THE FLOOR. 15-1/2" AFF
- P13 COMMON STEAM CONNECTION, (WHEN DOUBLE STEAM INJECTOR TANK HEAT OPTION IS SPECIFIED WITHOUT A STEAM BOOSTER) 3" FPT 6-3/4" AFF, (50 PSI MAX., 15-25 FLOWING PRESSURE) see note (e).
- P14 COMMON STEAM CONNECTION, (WHEN BOTH THE DOUBLE STEAM INJECTOR TANK HEAT AND STEAM BOOSTER OPTIONS ARE SPECIFIED), 3" FPT, 6-3/4" AFF, (50 PSI MAX., 15-25 FLOWING PRESSURE) see note (e).
- P15 COLD WATER CONNECTION, (WHEN ENERGY RECOVERY OPTION IS SPECIFIED WITH OR WITHOUT THE PREWASH TEMPERATURE CONTROL OPTION), 55°F WATER MINIMUM. 1" FPT. 10" AFF see notes (c) and (d).
- P16 HOT WATER RELIEF VALVE, (WHEN ENERGY RECOVERY OPTION IS SPECIFIED), 1/2" FPT, MUST BE PIPED TO OPEN DRAIN RECEIVER IN THE FLOOR. 15-1/2" AFF

### VENTILATION CONNECTIONS:

- V1 CUSTOMER'S VENT CONNECTION, (WHEN NOT SUPPLIED WITH ENERGY RECOVERY) MUST FIT INSIDE 16" DIAMETER VENT STACK, 750 CFM (AT STANDARD AIR CONDITIONS) EXHAUST REQUIRED. 78-3/4" AFF see note (f)
- V2 CUSTOMER'S VENT CONNECTION, (WHEN ENERGY RECOVERY OPTION IS SPECIFIED) MUST FIT INSIDE 16" DIAMETER VENT STACK, 750 CFM (AT STANDARD AIR CONDITIONS) EXHAUST REQUIRED. 87-5/8" AFF see notes (f) and (g)

### GENERAL NOTES:

- (a) THE CONTROL BOX IS ATTACHED TO THE CENTER SECTION, AND THE CONTROL BOX IS ROTATED 90 DEGREES ALLOWING THE CENTER SECTION TO FIT THROUGH A 42" WIDE, 7" DOOR OPENING.  
WITH BACK PANEL AND END CAPS REMOVED, CONTROL PANEL HINGED BACK AND ALL REAR PIPING REMOVED, OVERALL WIDTH OF MACHINE IS 39-1/8".  
AFF = ABOVE FINISHED FLOOR  
ALL DIMENSIONS TAKE FROM THE FLOOR LINE MAY INCREASE 2-1/2" OR DECREASE 1/2" WITH LEG ADJUSTMENT.  
FOR CONVENIENCE WHEN CLEANING, CUSTOMER SHOULD INSTALL WATER TAP NEAR MACHINE WITH 30 FT. OF HEAVY DUTY HOSE WITH SQUEEZE VALVE.  
THIS DRAWING IS SUPPLIED AS A REFERENCE FOR CONNECTION INFORMATION ONLY. IT WILL NOT BE UTILIZED FOR MANUFACTURING OF UNIT.

### ELECTRICAL WARNING:

ELECTRICAL AND GROUNDING CONNECTIONS MUST COMPLY WITH THE APPLICABLE PORTIONS OF THE NATIONAL ELECTRICAL CODE AND/OR OTHER ELECTRICAL CODES.

SERVICE WIRE TEMPERATURE RATING: 90°C.

### PLUMBING NOTES:

PLUMBING CONNECTIONS MUST COMPLY WITH APPLICABLE SANITARY, SAFETY AND PLUMBING CODES. RECOMMENDED WATER HARDNESS TO BE 3 GRAINS OR LESS PER GALLON FOR BEST RESULTS.

- (b) RECOMMENDED BUILDING FLOWING HOT WATER PRESSURE TO THE DISHWASHER IS 30-35 PSI.
- (c) RECOMMENDED BUILDING FLOWING COLD WATER PRESSURE TO THE DISHWASHER IS 45-50 PSI WHEN THE ENERGY RECOVERY OPTION IS SPECIFIED. IF COLD WATER IS LESS THAN 55°F CONTACT SALES ENGINEERING.
- (d) WATER HAMMER ARRESTOR (MEETING ASSE-1010 STANDARD OR EQUIVALENT) TO BE SUPPLIED (BY OTHERS) IN FINAL RINSE WATER SUPPLY LINE AT SERVICE CONNECTION.
- (e) IF STEAM PRESSURE IS UNDER 15 PSI AT THE DISHWASHER, CONTACT SALES ENGINEERING.

### VENTILATION NOTES:

- (f) THIS DIMENSION IS SUBJECT TO NORMAL SHEET METAL TOLERANCES
- (g) THE VENT STACK CAN BE TEMPORARILY REMOVED FROM THE ENERGY RECOVERY UNIT TO YIELD 79" CLEARANCE FOR DOORWAYS.

MODEL NO.	"A"	"B"	"C"	DIM "F" STEAM BOOSTER CONDENSATE RETURN		DIM "G" STEAM BOOSTER HOT WATER RELIEF VALVE		DIM "H" COMMON DRAIN CONNECTION		DIM "J" STEAM BOOSTER STEAM RELIEF VALVE		DIM "K" ENERGY RECOVERY HOT WATER RELIEF VALVE	
				WITH STEAM COIL OR SINGLE STEAM INJECTOR	WITH DOUBLE STEAM INJECTOR	WITH STEAM COIL OR SINGLE STEAM INJECTOR	WITH DOUBLE STEAM INJECTOR	5', 7', 9' UNLOADS	11' UNLOAD	WITH STEAM COIL OR SINGLE STEAM INJECTOR	WITH DOUBLE STEAM INJECTOR	WITH STEAM COIL OR SINGLE STEAM INJECTOR	WITH DOUBLE STEAM INJECTOR
FT918 (5-8-5)	18'-0"	5'-0"	5'-0"										
FT920 (7-8-5)	20'-0"	5'-0"	7'-0"										
FT920 (5-8-7)	20'-0"	7'-0"	5'-0"										
FT922 (7-8-7)	22'-0"	7'-0"	7'-0"										
FT922 (5-8-9)	22'-0"	9'-0"	5'-0"	101-1/2"	110-3/4"	78-1/2"	87-11/16"	51-5/32"		84-1/2"	93-3/4"	82-3/4"	91-15/16"
FT924 (7-8-9)	24'-0"	9'-0"	7'-0"										
FT924 (5-8-11)	24'-0"	11'-0"	5'-0"										
FT926 (7-8-11)	26'-0"	11'-0"	7'-0"						117-5/32"				

NOTE: OVERALL LENGTH OF MACHINE IS DIMENSION "A" + 10 1/2".

MOTORS	FT900
PREWASH	3 H.P.
POWER WASH	3 H.P.
POWER RINSE	3 H.P.
CONVEYOR	1/2 H.P.

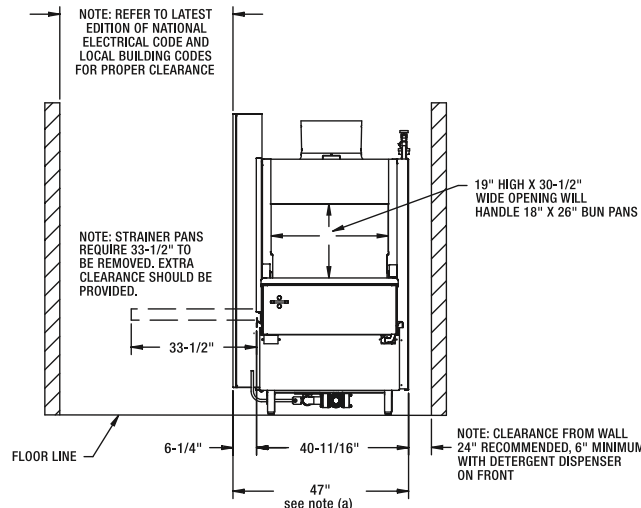

SERVICE CONNECTION WITH OR W/O CIRCUIT BREAKERS (1) SERVICE CONNECTION AS SHOWN BELOW			
MOTORS AND CONTROLS			
ELEC. SPECS.	RATED AMPS	MINIMUM SUPPLY CONDUCTOR AMPACITY	MAXIMUM PROTECTIVE DEVICE
208-240/60/3	29.9	40	40
480/60/3	17.5	25	25

MODEL:  
FT900 STEAM  
R-L OPERATION  
00-919088  
REV E

# FT900 FLIGHT-TYPE DISHWASHER



701 S Ridge Avenue, Troy, OH 45374  
1-888-4HOBART • www.hobartcorp.com

FT (flight type) Models—many additional variations of these model specifications are available. Engineering data furnished on request.

Numbers in parentheses, after model number from left to right, represent length in feet of the following respectively; Loading section, Washing and Power Rinsing sections, Unloading section.

Flight-type dishwasher with BLOWER-DRYER OPTION has the same specifications as the Basic FT900 Series EXCEPT for one additional Blower Motor (2 H.P. — 208-240/60/3 and 480/60/3) and is available on any model having either a 9 or 11 foot Unloading section.

Entire FT900 Series is listed by UL and NSF and meets requirements of ASSE Standard No. 1004.

FT900 Series (5, 7 Load / 8 Center / 5, 7, 9, 11 Unload)*	
<b>Machine Ratings (Mechanical)</b> Conveyor Speed — Feet per minute	4 - 8.5
<b>Dishes per Hour</b>	14,316
<b>Floor Space - Feet</b> — Machine length plus 10½" total for load and unload platform overhangs	*Example: FT918 = 5' Load + 8' Center + 5' Unload + 10½" Platform Overhangs = 18'10½" long
<b>Overall Dimensions (H x W)</b> — inches (standard height)	80 <sup>11</sup> / <sub>16</sub> (C) x 47 (B)
<b>Motor</b> — Horsepower	Pre-Wash - 3; Wash - 3; Rinse - 3; Conveyor - ½
<b>Tank Capacity</b> — Gallons	Pre-Wash - 40; Wash - 40; Rinse - 40
<b>Pump Capacity</b> Gallons per minute—Weir Test	Pre-Wash - 150; Wash - 292; Rinse - 292
<b>Final Rinse</b> — Minutes of operation during one hour of continuous operation	60 at continuous loading condition
<b>Rate of Final Rinse</b> — Gallons per minute at 20 PSI flow pressure	2.0
<b>Final Rinse Consumption</b> — Gallons per hour at 20 PSI flow pressure	120
<b>Exhaust Requirements</b> — Cubic feet per minute without Blower Dryer	750 (at standard air conditions)
<b>Electric Heat Requirements</b> —  Tank Heat - Kilowatt (Regulated) Optional Electric Booster - Kilowatt	Disconnect switches are recommended for each power circuit connected to dishwasher. These disconnect switches are NOT furnished by Hobart and should be installed by the electrical contractor at the time of installation. Circuit breakers optional at extra cost. Total tank heat - 52KW (Wash and Rinse) 30KW - 105°F incoming water raised to 190°F (85°F rise) (180°F minimum)
<b>Steam Heat Requirements</b> — Steam Consumption Tank Heat - Pounds per hour - maximum (Regulated) - based on 15 to 52 PSI steam at the machine and on the customer supplying final rinse water at minimum (A) (20 PSIG) Optional Steam Booster - Pounds per hour - maximum - based on 20 PSI steam at 20 PSI water flowing - 120°F incoming water raised to 190°F (70°F rise) (180°F minimum)	24 kw - 140° Incoming Water Approximately 30 lbs. per hour = 1 boiler H.P. (BHP)  175 lbs./150°F Wash minimum/160°F Rinse minimum  99 lbs.
<b>Peak Rate of Drain Flow</b> — Gallons per minute Initial rate with full tanks	38
<b>Shipping Weight Crated</b>	Varies by individual model - consult your Hobart representative

(A) If only 10-12 PSIG Steam Pressure available at machine - specify Low Pressure Steam Option.

(B) With all rear panels and plumbing removed, machine width is 39<sup>1</sup>/<sub>8</sub>".

(C) Highest item is control box - 80<sup>11</sup>/<sub>16</sub>". Can be adjusted lower 2" for door clearance.

**NOTE:** Refer to specific specification sheets for short machines (FT900S) machines with Blower-Dryers.

As continued product improvement is a policy of Hobart, specifications are subject to change without notice.