



# Patio Heaters

Edmonton

[info@patioheaters.pro](mailto:info@patioheaters.pro)

## PLATINUM SMART-HEAT™ ELECTRIC

Available in black and white, our Platinum Smart-Heat™ Electric heater is specifically suited for low-clearance and design-focused spaces. This slim-line, stainless-steel unit spreads comfort evenly in its space, all while minimizing light emission and blending seamlessly into the background with our recess mounting solutions.



2300W, 3400W & 4500W SERIES  
BLACK | WHITE



2300W, 3400W & 4500W SERIES  
BLACK | WHITE

# SPECIFICATIONS

Reference the specification guide below to help you select the correct solution for your needs.

MODEL NUMBER	2300W SERIES	3400W SERIES	4500W SERIES
PRODUCT CODES PLATINUM ELECTRIC	BH0320003   BH0320007 BH0320019   BH0320020	BH0320005   BH0320008 BH0320021   BH0320022	BH3622000   BH3622004 BH3622001   BH3622005
PRODUCT CODES PLATINUM ELECTRIC MARINE	BH0320015   BH0320017 BH0320023   BH0320024	BH0320016   BH0320018 BH0320025   BH0320026	BH3622002   BH3622006 BH3622003   BH3622007
FUEL TYPE	ELECTRIC	ELECTRIC	ELECTRIC
COLOR	BLACK   WHITE	BLACK   WHITE	BLACK   WHITE
HEAT AREA	65FT <sup>2</sup>	108FT <sup>2</sup>	143FT <sup>2</sup>
RATED CURRENT**	220 - 240V/9.6A 208V/11.1A	220 - 240V/14.2A 208V/16.3A	220 - 240V/18.8A 208V/21.6A
MINIMUM FLOOR CLEARANCE	WALL 72"   CEILING 96"	WALL 72"   CEILING 96"	WALL 72"   CEILING 96"
<b>MOUNTING OPTIONS</b>			
CEILING MOUNT	INCLUDED	INCLUDED	INCLUDED
WALL MOUNT	INCLUDED	INCLUDED	INCLUDED
RECESS KIT   FLUSH MOUNT	✓	✓	✓
CEILING RECESS KIT PRODUCT CODES	BH3130017	BH3130027	BH3623000
NEW RECESS KIT   LOW CLEARANCE	✓	✓	-
LOW CLEARANCE RECESS KIT PRODUCT CODES	BH3623009	BH3623008	-
CEILING POLE EXTENSION	✓	✓	✓
CEILING POLE (2') PRODUCT CODE	BH3130023-1	BH3130023-1	BH3623020
CEILING POLE (4') PRODUCT CODE	BH3130024-1	BH3130024-1	BH3623021
FREESTANDING	-	-	-
<b>CONTROL OPTIONS</b>			
ON   OFF	✓	✓	✓
ON   OFF PRODUCT CODE	BH3130010-1	BH3130010-1	BH3130010-1
DIMMER	✓	✓	✓
DIMMER PRODUCT CODE	BH3130011-1	BH3130011-1	BH3130011-1
MASTER REMOTE *	✓	✓	✓
MASTER REMOTE PRODUCT CODE	BH3130012-1	BH3130012-1	BH3130012-1

\* Control up to six zones of heaters with unlimited heaters per zone from a single remote control. Dimmer control required. Works with dimming controllers. Remote control operates within 100ft of heaters.

\*\* Available in 208V and 220-240V configurations.

Measurements displayed within this document are for reference only, for complete requirements see the installation/user manual. Bromic takes no responsibility for incorrect or non-compliant installations. All measurement in this document are displayed in inches.

# DIMENSIONS

With a wide range of sizes available, find the ideal heater to suit your outdoor space.

## CONTROL OPTIONS



ON | OFF CONTROL



DIMMER CONTROL



MASTER REMOTE

## PROFILE

2300W

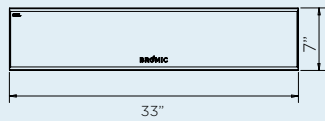

3400W

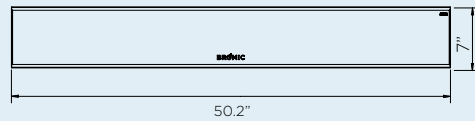

4500W

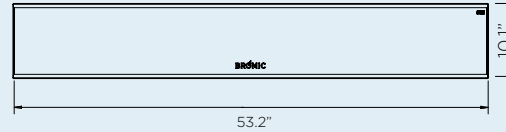

## CEILING RECESS

CEILING RECESS FRAME 2300W

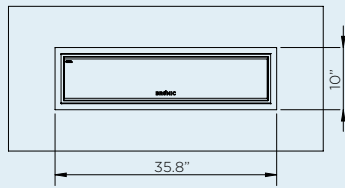

CEILING RECESS FRAME 3400W

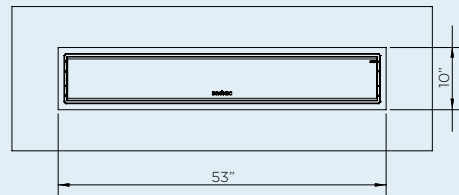

CEILING RECESS FRAME 4500W

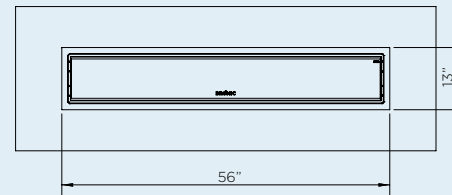

LOW CLEARANCE RECESS KIT 2300/3400W

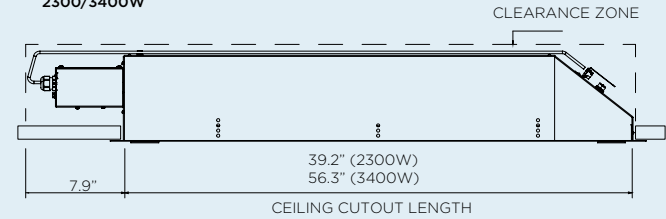

MINIMUM CAVITY OPTION 1 2300/3400W

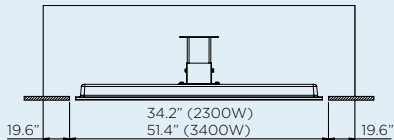

MINIMUM CAVITY OPTION 2 2300/3400W

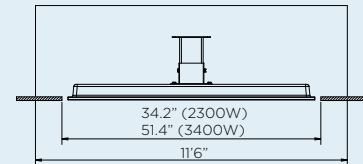

MINIMUM CAVITY FOR 4500W

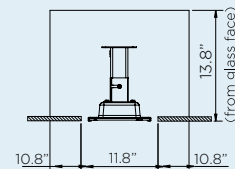
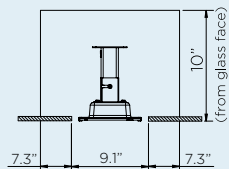
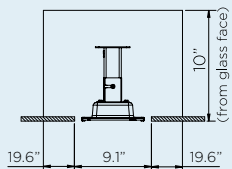
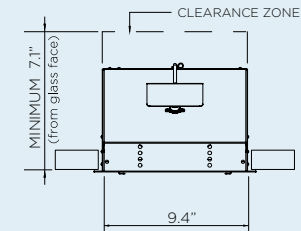
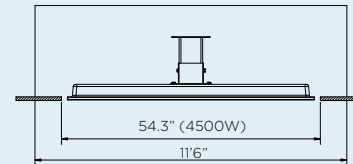

# MOUNT OPTIONS

With a wide array of mounting options, Bromic offers solutions to compliment any decor and provide functionality for ambiance and comfort.

## CEILING & WALL MOUNT

### CEILING MOUNT CLEARANCE

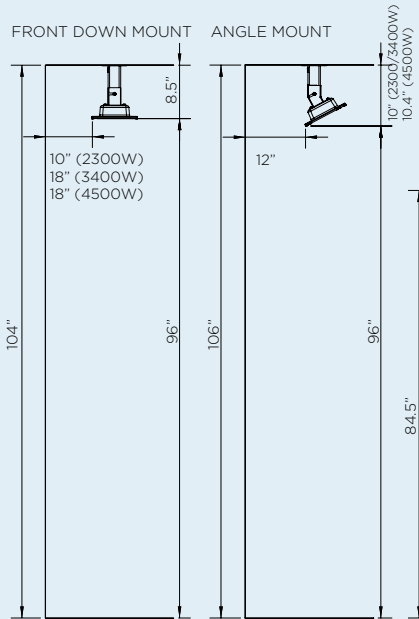

**WALL MOUNT CLEARANCE 2300/3400W**

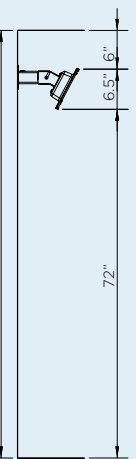

**WALL MOUNT CLEARANCE 4500W**

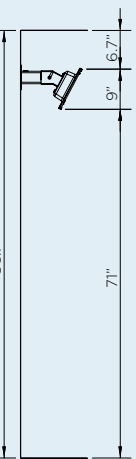

### CEILING POLE CLEARANCE

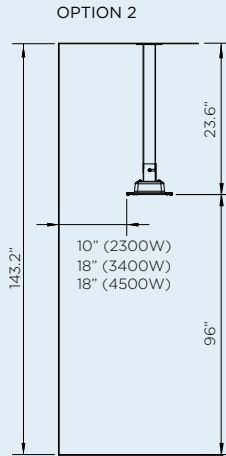
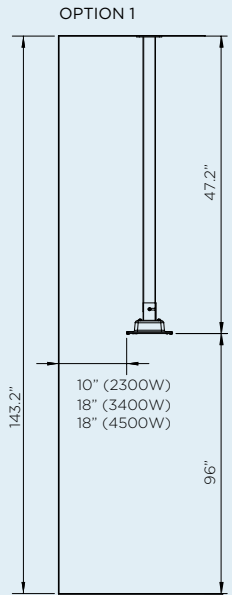

## WALL BRACKET (INCLUDED)

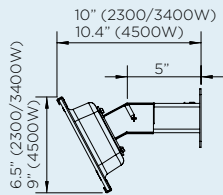

## CEILING BRACKET (INCLUDED)

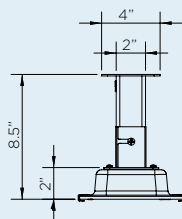

# HEATING REACH

Creating ideal comfort levels, Bromic heaters offer a variety of heat distribution options to suit your outdoor heating needs.

## HEAT AREA

**2300W SERIES**  
 HEATING APPROXIMATELY 65FT<sup>2</sup>  
 2300W HEATING POWER

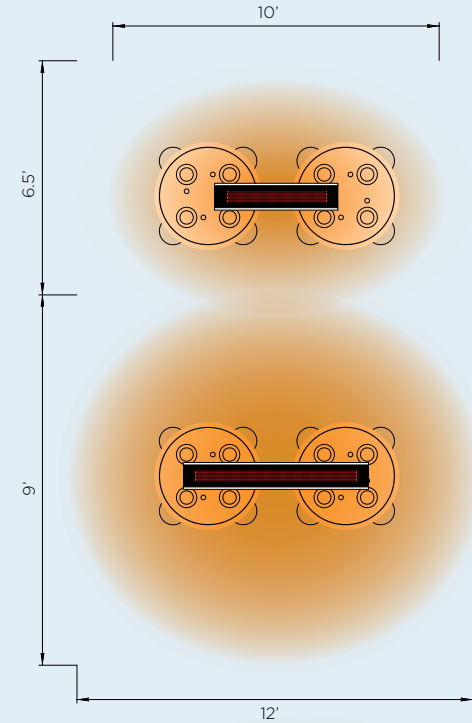

**3400W SERIES**  
 HEATING APPROXIMATELY 108FT<sup>2</sup>  
 3400W HEATING POWER

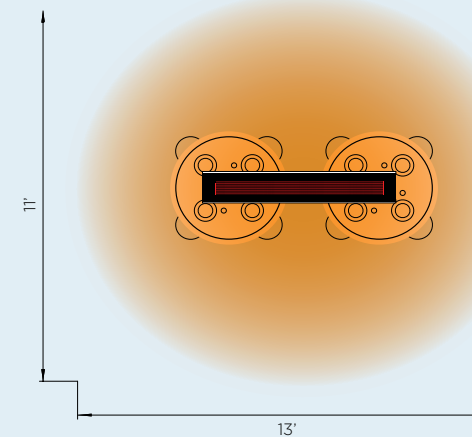

**4500W SERIES**  
 HEATING APPROXIMATELY 143FT<sup>2</sup>  
 4500W HEATING POWER

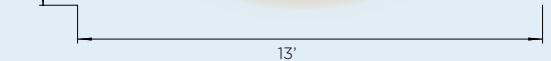



EXTEND YOUR COMFORT OUTDOORS  
WITH THE SUPERIOR HEAT AND  
AWARD-WINNING DESIGN OF OUR  
SMART-HEAT™ OUTDOOR HEATERS.

---



**VERSATILE MOUNTING SOLUTION**  
Minimal vertical clearance

**HIGH PERFORMANCE CONSTRUCTION**  
304 stainless-steel & tinted ceramic screen

**CLEAN, COMPACT AND ELEGANT DESIGN**  
For seamless integration

**ADJUSTABLE MOUNTING BRACKETS**  
Allows for directional heat distribution

  
**Patio Heaters**  
**Edmonton**  
[info@patioheaters.pro](mailto:info@patioheaters.pro)



**COMPATIBLE WITH SMART-WIRELESS TECHNOLOGY**

**BROMIC.COM**

ASIA PACIFIC | NORTH AMERICA | EUROPE

Bromic pursues a policy of continuing improvement in design and performance of its products. The right is therefore reserved to vary specifications without notice.