



PRICE LIST

Effective May 1st, 2022; VIII

Look For Our
RAPID Ship Items



TABLE OF CONTENTS

• Overhead Concealed Closers	4 - 6	• Cylinders & Lock Indicator	27
• Surface Mount Closers	7 - 12	• Stainless Steel Roller Latches	28
• Floor Closers	13	• Door Handles & Bars	29
• Pedestrian Gate Closer	14	• Pivots	30
• Gate Locks & Accessories	14	• Hinges	31 - 32
• Exit Devices	15 -21	• Germ Free Pulls & Door Holders	33
• Cylindrical LocksetS	22	• Door Sweeps & Thresholds	34
• Deadbolts & Faceplates	23 - 24	• Transmitters, Bollards & Low Energy Operators	35
• Lever & Paddle Handles	24	• Key Pads & Card Readers	36 - 37
• Strike Sets & Rescue Stops	25	• Maglocks, Strikes & Bolt Locks	38 - 41
• Flush Bolts, Coordinators	26 - 27	• Power Controllers	42 - 43

ALL PRICES ARE SUBJECT TO CHANGE WITHOUT NOTICE

SALES POLICY

TERMS: A minimum purchase of \$5,000 annually is required to maintain an open account with International Door Closers, Inc. Net 30 days from date of invoice to Customers with satisfactory and/or prior approved credit terms. It is understood that you may use your normal purchase order or other order forms in placing orders. However any such forms shall be used for convenience only and any terms or provisions which may be contained therein inconsistent with, or in addition to, those contained in our then current Acknowledgment to Customer form or other terms or provisions contained herein shall have no force or effect whatsoever. Custom material or wiring diagrams require 50% deposit. At IDC's discretion, orders in excess of \$1,500 net will be acknowledged by product, category and department and shipped on an "as ready" basis unless customer purchase order specifically states "Do not ship before _____," and "No partial shipments."

PRICES: Prices are subject to change without notice. No prices are guaranteed. All shipments will be made at prices prevailing at time of shipment. Errors or omissions in pricing are subject to correction.

PRICING POLICY: Shipments must be accepted within sixty (60) days after receipt of the order. Contracts extending beyond this period are subject to prices in effect at the time of shipment.

MINIMUM ORDER: Our minimum invoice charge is \$100 net. \$15.00 net will be added to any order that do not meet minimum.*
* Quick Ship items, minimum for Special Order items will vary. Please call IDC for more details.

ACCEPTANCE: IDC reserves the right to decline an order, in whole or in part, when the price, quantity or assortment of goods is not satisfactory to us.

CHANGE IN ORDERS: A charge of \$20 may be applied to each change on any order after said original order has been previously acknowledged by IDC, plus a cost incurred by manufacturing at point of change.

CANCELLATIONS: Any orders canceled after shipping are subject to shipping charges and / or handling fees.

FREIGHT: Prepaid on 350 pounds or \$1,500.00 whichever comes first, by carrier of our choice within the continental United States. (When customers specifies routing by another carrier or shipping oversized items (70" in length) or longer, any excess charges incurred will be billed).

Prepaid items include only in house stock (RAPID Ship items). Any outsourced items or oversized hardware are excluded.

Customers that choose to use "UPS / FedEx "collect" or 3rd party accounts to ship may do so. The shipping account information needs to be available on the original order at the time of order receipt.

Non-Transportation surcharges {i.e.: construction site delivery, oversized box or pallet, delivery notification, lift gate service, etc.} will be billed to the customer.

RETURNED GOODS: All returns require an RGA number in order to complete the return.
Customer is responsible for returning product warranty. IDC will be responsible for shipping out replacement.

A restocking fee of \$25.00 or 15% "whichever is greater" may apply to returned items. (Any outsourced items not within the RAPID Ship catalog such as access control, security products, custom size, thresholds and gasketing will be subject to our suppliers return policies).

BACK CHARGES: IDC is not responsible for, does not authorize, and will not accept any charges for the cost of any labor or material incurred by anyone other than International Door Closers, Inc. for any installation, repair, service or replacement unless incurred with prior written consent and agreement from IDC.

PRODUCT CHANGES: IDC reserves the right to modify, change, or discontinue any components as required.

SHORTAGES/DISCREPANCIES: Claims must be made within ten (10) days after receipt of material. The original invoice number will be required.

TEMPLATES: It shall be the Customer's responsibility to check all templates requested from IDC for suitability for proper door and frame preparation. Direct mail requests for the door and frame supplier will not release this Customer of this responsibility. Duplicates will be mailed to distributors.

NOTE: IDC complete sales policy as stated in our price book prevails at all times.

LIMITED WARRANTY

We warrant that all products sold by International Door Closers, Inc. are free from defects in material and workmanship and those products of our design are fit for the purpose intended by IDC when properly installed in accordance with factory instructions.

Warranty begins not more than 2 months after the date of shipment. IDC is not responsible for changes of Oil Rubbed Bronze (613/US10B) finish, which is a living finish designed to change appearance through daily use.

The extent of our liability for breach of such warranty, when such is shown to our satisfaction, shall be limited to a functionally equivalent replacement, or repair of such product, or part thereof, at IDC's sole discretion, when returned, delivery prepaid, to IDC. Customers must get a RGA from IDC before returning any material for warranty.

We shall not, except to the extent this limitation may be precluded by law, be liable for inconvenience, labor cost, damages to other property, injury or any consequential damages resulting directly or indirectly from any product defect or breach of this warranty.

This warranty is limited to the original Purchaser, is not transferable and shall not apply to maintenance, wear and tear caused by improper installation, normal use, altered product, abuse or negligence.

FINISHES

Zinc Plated	603	US2G
Bright Brass	605	US3
Satin Brass	606	US4
Bright Bronze	611	US9
Satin Bronze	612	US10
Dark Bronze	613	US10B
Bright Chrome	625	US26
Satin Chrome	626	US26D
Satin Aluminum	628	US28
Bright Stainless Steel	629	US32
Satin Stainless Steel	630	US32D
Painted Primed	600	USP
Painted Aluminum	689	S1
Painted Brass (to match US4)	696	S2
Painted Bronze (to match US10)	691	S3
Painted Black	693	S4
Painted Dark Bronze (to match US10B)	690	S5
Painted White	-	S8

Some products in this price book are protected by one or more of the following U.S. Patents (Foreign Patents are not shown): 4,021,065; 4,099,752; 4,596,411; 4,609,910; 4,623,178; 4,623,181; 4,634,155; 4,641,867; 4,826,223; 4,986,581; 5,000,497; 5,006,723; 5,033,779; 5,141,271; 5,376,910; 5,429,399; 5,525,880; 5,564,228; 5,876,073; 6,363,363; 6,363,763

Accurate, Arrow, Baldwin, Best, Cal-Royal, Corbin Russwin, Dorma, Falcon, Hager, Marks, PDQ, Sargent, Schlage, Yale and other brand names are trademarks of their respective companies.

ALL PRICES ARE SUBJECT TO CHANGE WITHOUT NOTICE

NEW "D" OVERHEAD CONCEALED OHC CLOSERS

D200 SERIES

ADA 5lb

D200	105° Back Stop with Hold-Open
D201	105° Back Stop no Hold-Open
D202	90° Back Stop with Hold-Open
D203	90° Back Stop no Hold-Open

ADA 8-1/2lb

D210	105° Back Stop with Hold-Open
D211	105° Back Stop no Hold-Open
D212	90° Back Stop with Hold-Open
D213	90° Back Stop no Hold-Open

Light Spring Tension

D220	^	105° Back Stop with Hold-Open
D221	^	105° Back Stop no Hold-Open
D222	^	90° Back Stop with Hold-Open
D223	^	90° Back Stop no Hold-Open

Medium Spring Tension

D230	^	105° Back Stop with Hold-Open
D231	^	105° Back Stop no Hold-Open
D232	^	90° Back Stop with Hold-Open
D233	^	90° Back Stop no Hold-Open

<u>SINGLE UNIT PRICE</u>	<u>CASE OF 4 UNIT PRICE</u>	<u>WEIGHT PER CASE</u>
\$259.10	\$254.00	53#



Heavy Spring Tension

D240	^	105° Back Stop with Hold-Open
D241	^	105° Back Stop no Hold-Open
D242	^	90° Back Stop with Hold-Open
D243	^	90° Back Stop no Hold-Open

^ Add \$6.50 to list price for JO and VO type offset arm in lieu of S, A, K, or PT type arms
 ADA opening force may not provide sufficient power to reliably close and latch a door

D200-SA SERIES EXTENDED SPINDLE

Medium Spring Tension

D230-SA	^	105° Back Stop with Hold-Open
D231-SA	^	105° Back Stop no Hold-Open
D232-SA	^	90° Back Stop with Hold-Open
D233-SA	^	90° Back Stop no Hold-Open

Heavy Spring Tension

D240-SA	^	105° Back Stop with Hold-Open
D241-SA	^	105° Back Stop no Hold-Open
D242-SA	^	90° Back Stop with Hold-Open
D243-SA	^	90° Back Stop no Hold-Open

<u>SINGLE UNIT PRICE</u>	<u>CASE OF 4 UNIT PRICE</u>	<u>WEIGHT PER CASE</u>
\$297.20	\$292.10	53#



NEW "D" OVERHEAD CONCEALED OHC CLOSERS

D300 SERIES ADJUSTABLE SPRING POWER

ADA 5lb or 8-1/2lb to Medium

D310	^	105° Back Stop with Hold-Open
D311	^	105° Back Stop no Hold-Open
D312	^	90° Back Stop with Hold-Open
D313	^	90° Back Stop no Hold-Open



<u>SINGLE UNIT PRICE</u>	<u>CASE OF 4 UNIT PRICE</u>	<u>WEIGHT PER CASE</u>
\$313.70	\$308.70	53#

3/4" Spindle (ADA 5lb or 8-1/2lb to Medium)

D310-20-A-DP		105° Back Stop with Hold-Open
D311-20-A-DP		105° Back Stop no Hold-Open
D312-20-A-DP		90° Back Stop with Hold-Open
D313-20-A-DP		90° Back Stop no Hold-Open

<u>SINGLE UNIT PRICE</u>	<u>CASE OF 4 UNIT PRICE</u>	<u>WEIGHT PER CASE</u>
\$351.80	\$346.80	53#



^ Add \$6.50 to list price for JO and VO type offset arm in lieu of S, A, K, or PT type arms
 ADA opening force may not provide sufficient power to reliably close and latch a door

D500 SERIES ADJUSTABLE SPRING POWER GRADE 1

ADA 5lb to Medium

D510	^	105° Back Stop with Hold-Open
D511	^	105° Back Stop no Hold-Open
D512	^	90° Back Stop with Hold-Open
D513	^	90° Back Stop no Hold-Open



<u>SINGLE UNIT PRICE</u>	<u>CASE OF 4 UNIT PRICE</u>	<u>WEIGHT PER CASE</u>
\$403.90	\$398.80	53#



^ Add \$6.50 to list price for JO and VO type offset arm in lieu of S, A, K, or PT type arms
 ADA opening force may not provide sufficient power to reliably close and latch a door

NEW "D" OVERHEAD CONCEALED OHC CLOSERS

PARTS AND ACCESSORIES



		LIST PRICE
D2000-B	D200 Series Body Only	\$209.60
D2000-B-20	D200-SA Series Body Only (Extended Spindle)	\$247.70
D3000-B	D300 Series Body Only	\$264.20
D3000-B-31	D300-SA Series Body Only (Extended Spindle)	\$302.30
D5000-B	D500 Series Body Only	\$354.40
3010-S	S Type Adjustable Side Loading Top Arm Assembly, 1/2" Depth Top Rail	\$45.40
3010-A	A Type End Loading Top Arm Assembly, 1" Depth Top Rail	\$45.40
3010-SA	A Short Type End Loading Top Arm Assembly, 1" Depth Top Rail	\$45.40
3010-K	K Type End Loading Top Arm Assembly, 5/8" Depth Top Rail	\$45.40
3010-PT	PT Type End Loading Top Arm Assembly, 7/8" Depth Top Rail	\$49.70
3010-JO	JO Type Offset Top Arm Assembly, Mortise Type, 9/16" Depth Top Rail <i>Painted arm - AL Aluminum or DU Storefront Bronze</i>	\$70.30
3020-VO	VO Type Offset Top Arm Assembly, Surface Type, 7/8" Depth Top Rail <i>Painted arm - AL Aluminum or DU Storefront Bronze</i>	\$74.70
3010-FS	Anchor Set (Standard for D200 Series)	\$15.00
3010-FA	Anchor Set (Optional for D200 Series)	\$15.00
3010-FK	Anchor Set (Optional for D200 Series)	\$15.00
3010-FSP	Anchor Set (Standard for D300/D500 Series)	\$16.10
3010-DP	Adjustable Dual Purpose Bottom Pivot Set (Standard)	\$39.00
3010-G	Adjustable Floor Mount Bottom Pivot Set	\$45.40
3010-G*	Adjustable Floor Mount Bottom Pivot Set (in lieu of Standard)	\$12.90
3010-GE	Adjustable Threshold Mount Bottom Pivot Set	\$41.20
3010-GE*	Adjustable Threshold Mount Bottom Pivot Set (in lieu of Standard)	\$5.50
D2000-B-Pivot	OHC Closer, Pivot Function Only	\$116.90
D2000-B-Pivot-LS	OHC Closer, Long Spindle Pivot - Function Only	\$142.30

SURFACE MOUNT CLOSERS

44CI ADJUSTABLE SPRING POWER GRADE 1 CERTIFIED

		<u>SINGLE UNIT PRICE</u>	<u>CASE OF 4 UNIT PRICE</u>	<u>WEIGHT PER CASE</u>
44CI	Cast Iron Body (includes Dress Cover, Standard Arm, & Parallel Bracket)	\$212.00	\$208.00	52#



44CI FINISHES

AL	Aluminum	N/C
DU	Storefront Bronze	

44CI PARTS AND ACCESSORIES



		<u>LIST PRICE</u>
44-2021	Complete Arm Assembly	\$42.10
44-2022	Cushion Hold-Open Arm Mechanical Turn Type	\$141.10
44-2022*	Cushion Hold-Open Arm Mechanical Turn Type (in lieu of Standard)	\$99.40
44-2023	Cushion Stop Only Arm	\$141.10
44-2023*	Cushion Stop Only Arm (in lieu of Standard)	\$99.40
44-2024	Friction Hold-Open Arm	\$90.00
44-2024*	Friction Hold-Open Arm (in lieu of Standard)	\$48.20
44-2026	Heavy Duty EDA Arm	\$116.00
44-2026*	Heavy Duty EDA Arm (in lieu of Standard)	\$74.50
425	Parallel Bracket	\$10.40
44-18	Drop Plate for Standard Installation	\$41.80
44-18G	Drop Plate for Top Jamb Installation	\$41.80
44-18J	Drop Plate for Top Jamb Installation	\$41.80
44-18PA	Drop Plate for Parallel Arm Installation	\$42.40
44-19	Blade Stop Spacer	\$24.80
44-20	Cush Shoe Support	\$18.00
DC-44	Dress Cover	\$18.70

SURFACE MOUNT CLOSERS

850 SERIES STANDARD



Size 1

851	Regular Arm
851-P	Parallel Arm

Size 2

852	Regular Arm
852-P	Parallel Arm

Size 3

853	Regular Arm
853-P	Parallel Arm

Size 4

854	Regular Arm
854-P	Parallel Arm

Size 5

855	Regular Arm
855-P	Parallel Arm



**SINGLE
UNIT PRICE**

**CASE OF 6
UNIT PRICE**

**WEIGHT
PER CASE**

\$71.70	\$66.40	24#
\$74.90	\$69.60	26#
\$82.40	\$77.20	31#
\$86.80	\$81.50	35#
\$86.70	\$81.20	33#
\$90.70	\$85.40	37#
\$94.30	\$88.90	39#
\$98.10	\$92.80	43#
\$99.40	\$94.20	41#
\$103.30	\$98.00	45#

880 SERIES ADJUSTABLE BACK-CHECK



Size 3

883	Regular Arm
883-P	Parallel Arm

Size 4

884	Regular Arm
884-P	Parallel Arm

Size 5

885	Regular Arm
885-P	Parallel Arm

**SINGLE
UNIT PRICE**

**CASE OF 6
UNIT PRICE**

**WEIGHT
PER CASE**

\$95.20	\$90.00	33#
\$99.50	\$94.30	37#
\$105.70	\$100.30	39#
\$110.10	\$104.70	43#
\$109.20	\$104.00	41#
\$113.30	\$107.90	45#

850/880 SERIES FINISHES

AL	Aluminum	N/C
DU	Storefront Bronze	

SURFACE MOUNT CLOSERS

1800 SERIES FIXED SPRING POWER GRADE 1

Size			SINGLE UNIT PRICE	CASE OF 6 UNIT PRICE	WEIGHT PER CASE
1802	Standard		\$86.60	\$80.60	40#
Size 3					
1803	Standard		\$90.90	\$85.00	41#
1803-BC	Back-Check		\$100.80	\$94.50	42#
Size 4					
1804	Standard		\$97.70	\$91.70	42#
1804-BC	Back-Check		\$107.90	\$101.70	43#
Size 5					
1805	Standard		\$103.20	\$97.10	42#
1805-BC	Back-Check		\$112.60	\$106.70	43#

1800 SERIES FINISHES

AL	Aluminum	N/C
DU	Storefront Bronze	

850/880/1800 SERIES PARTS AND ACCESSORIES

Size			LIST PRICE
Size 1			
510	Main Arm		\$8.30
511	Regular Forearm		\$10.10
515	Parallel Bracket for Regular Arm		\$3.90
Size 2			
520	Main Arm		\$9.40
521	Regular Forearm		\$10.60
522	Hold-Open Forearm		\$40.20
522*	Hold-Open Forearm (in lieu of Standard)		\$25.90
525	Parallel Bracket for Regular Arm		\$4.70
527	Flat Drop Plate		\$11.10
Size 3			
520	Main Arm		\$9.40
521	Regular Forearm		\$10.60
522	Hold-Open Forearm		\$40.20
522*	Hold-Open Forearm (in lieu of Standard)		\$25.90
525	Parallel Bracket for Regular Arm		\$4.70
537	Flat Drop Plate		\$12.20
TJB-53	Top Jamb Bracket		\$11.60
DC-8000	Dress Cover		\$11.00
Sizes 4 & 5			
520	Main Arm		\$9.40
521	Regular Forearm		\$10.60
522	Hold-Open Forearm		\$40.20
522*	Hold-Open Forearm (in lieu of Standard)		\$25.90
525	Parallel Bracket for Regular Arm		\$4.70
547	Flat Drop Plate		\$14.40
TJB-54	Top Jamb Bracket		\$12.40
DC-8000	Dress Cover		\$11.00
TBGN-50	Thru Bolt & Grommet Nut Set of 4		\$5.70
TBGN-50*	Thru Bolt & Grommet Nut Set of 4 Packed with Closer		\$5.90
18-SN	Sex Nuts Set of 4		\$5.90
18-SN*	Sex Nuts Set of 4 Packed with Closer		\$6.10

SURFACE MOUNT CLOSERS

5000-TP SERIES ADJUSTABLE SPRING POWER GRADE 1

Adjustable Size 1-6, Back-Check & Delayed Action		SINGLE UNIT PRICE	CASE OF 6 UNIT PRICE	WEIGHT PER CASE
5001-TP	^ Tri-Packed with Parallel Bracket & Dress Cover	\$169.00	\$165.00	48#



5000-TP SERIES FINISHES

AL	Aluminum	N/C
DU	Storefront Bronze	

5000-TP SERIES PARTS AND ACCESSORIES



		LIST PRICE
501	Complete Arm Assembly	\$26.20
522	Hold-Open Forearm	\$40.20
522*	Hold-Open Forearm (in lieu of Standard)	\$25.90
525	Parallel Bracket for Regular Arm	\$4.70
5007	Flat Drop Plate with Dress Cover	\$24.50
DC-5000	Dress Cover	\$14.70
TBGN-50	Thru Bolt & Grommet Nut Set of 4	\$5.70
TBGN-50*	Thru Bolt & Grommet Nut Set of 4 Packed with Closer	\$5.90
18-SN	Sex Nuts Set of 4	\$5.90
18-SN*	Sex Nuts Set of 4 Packed with Closer	\$6.10

SURFACE MOUNT CLOSERS

8000-TP SERIES ADJUSTABLE SPRING POWER GRADE 1

			SINGLE UNIT PRICE	CASE OF 6 UNIT PRICE	WEIGHT PER CASE
Adjustable Size 1-6, Back-Check					
8051-TP	^	Tri-Packed with Parallel Bracket & Dress Cover	\$130.00	\$126.00	39#
Adjustable Size 1-6, Delayed Action					
8052-TP	^	Tri-Packed with Parallel Bracket & Dress Cover	\$130.00	\$126.00	39#



8000-TP SERIES FINISHES

AL	Aluminum	N/C
DU	Storefront Bronze	

8000-TP SERIES PARTS AND ACCESSORIES

		LIST PRICE
520	Main Arm	\$9.40
521	Regular Forearm	\$10.60
522	Hold-Open Forearm	\$40.20
522*	Hold-Open Forearm (in lieu of Standard)	\$25.90
525	Parallel Bracket for Regular Arm	\$4.70
547	Flat Drop Plate	\$14.40
TJB-54	Top Jamb Bracket	\$12.40
DC-8000	Dress Cover	\$11.00
TBGN-50	Thru Bolt & Grommet Nut Set of 4	\$5.70
TBGN-50*	Thru Bolt & Grommet Nut Set of 4 Packed with Closer	\$5.90
18-SN	Sex Nuts Set of 4	\$5.90
18-SN*	Sex Nuts Set of 4 Packed with Closer	\$6.10



SURFACE MOUNT CLOSERS

9000-TP SERIES ADJUSTABLE SPRING POWER GRADE 1

Adjustable Size 1-6, Back-Check & Delayed Action		SINGLE UNIT PRICE	CASE OF 6 UNIT PRICE	WEIGHT PER CASE
9001-TP	Tri-Packed with Parallel Bracket & Dress Cover	\$149.00	\$145.00	48#
9003-TP	Interior ADA Applications Tri-Packed with Parallel Bracket & Dress Cover	\$149.00	\$145.00	48#



9000-TP SERIES FINISHES

AL	Aluminum	N/C
DU	Storefront Bronze	

9000-TP SERIES PARTS AND ACCESSORIES



		LIST PRICE
901	Complete Arm Assembly	\$26.20
522	Hold-Open Forearm	\$40.20
522*	Hold-Open Forearm (in lieu of Standard)	\$25.90
514	Top Jamb Forarm Extender	\$4.70
525	Parallel Bracket for Regular Arm	\$4.70
9007	Flat Drop Plate	\$23.10
TJB-9000	Top Jamb Bracket	\$22.70
TBGN-50	Thru Bolt & Grommet Nut Set of 4	\$5.70
TBGN-50*	Thru Bolt & Grommet Nut Set of 4 Packed with Closer	\$5.90
18-SN	Sex Nuts Set of 4	\$5.90
18-SN*	Sex Nuts Set of 4 Packed with Closer	\$6.10

FLOOR CLOSERS

ST75 SERIES FIXED CLOSING FORCE

ST75EN3	Standard and External Doors up to 950lbs		LIST PRICE
			\$371.60

ST80 SERIES ADJUSTABLE CLOSING FORCE

ST80P	^ Standard and External Doors, Adjustable for 950lbs to 1400lbs		LIST PRICE
			\$1,050.00

^ Standard Full Set includes German type Spindle with Center Hung Arm and Pivot

Door Operator Options

These door operator options are special ordered, please call for ETA

		LIST PRICE
8011	Standard Bottom Arm set	\$19.50
8012	Standard Top Pivot set	\$54.30
8021	Offset Bottom Arm RH/LH set	\$22.70
8023	Offset Top Pivot RH set	\$92.90
8024	Offset Top Pivot LH set	\$92.90
8011SSS	Floor cover Plate in Satin Stainless Steel	\$34.60
8011PSS	Floor cover Plate in Polished Stainless Steel	\$36.50
8011PB	Floor cover Plate in Polished Brass	\$59.00
8061	Cement Case & screws	\$41.00
8030	Double Acting Spindle Adapter Extension Standard Length(3MM)	\$26.40
8031	Double Acting Spindle Adapter Extension 5MM	\$27.50
8032	Double Acting Spindle Adapter Extension 10MM	\$30.50
8033	Double Acting Spindle Adapter Extension 15MM	\$33.40
8034	Double Acting Spindle Adapter Extension 20MM	\$37.30
8035	Double Acting Spindle Adapter Extension 25MM	\$41.50
8036	Double Acting Spindle Adapter Extension 30MM	\$45.40
8040L	LH OFFSET 3DEG STD SPINDLE (3MM)	\$31.30
8041L	LH O/SET 3DEG EXTND SPIND+5MM	\$32.50
8042L	LH O/SET 3DEG EXTND SPIND+10MM	\$35.60
8043L	LH O/SET 3DEG EXTND SPIND+15MM	\$38.20
8044L	LH O/SET 3DEG EXTND SPIND+20MM	\$42.40
8045L	LH O/SET 3DEG EXTND SPIND+25MM	\$46.70
8046L	LH O/SET 3DEG EXTND SPIND+30MM	\$50.60
8040R	RH OFFSET 3DEG STD SPINDLE (3MM)	\$31.30
8041R	RH O/SET 3DEG EXTND SPIND+5MM	\$32.50
8042R	RH O/SET 3DEG EXTND SPIND+10MM	\$35.60
8043R	RH O/SET 3DEG EXTND SPIND+15MM	\$38.20
8044R	RH O/SET 3DEG EXTND SPIND+20MM	\$42.40
8045R	RH O/SET 3DEG EXTND SPIND+25MM	\$46.70
8046R	RH O/SET 3DEG EXTND SPIND+30MM	\$50.60

PEDESTRIAN GATE CLOSER

SWINGER

311-RVLS	Hydraulic Pedestrian Gate Closer	<u>UNIT PRICE</u> \$1,044.50	<u>PER CASE</u> 19#
----------	----------------------------------	--	------------------------



GATE ACCESSORIES

CHAIN TENSIONERS

4041-1	Single	<u>LIST PRICE</u> Contact IDC
4041-2	Pair	Contact IDC

ELECTROMECHANICAL GATE LOCKS

GL160AI	Fail-safe	<u>LIST PRICE</u> Contact IDC
GL163AI	Fail-safe with Key Switch	Contact IDC
GL260AH	Fail-secure	Contact IDC
GL263AH	Fail-secure with Key Switch	Contact IDC
GL260MRAH	Fail-secure with Mechanical Key Release	Contact IDC

Cylinders not included



ELECTROMECHANICAL GATE LOCK OPTIONS

B	Bolt Position Sensor, 10 Amp @ 30VDC	<u>ADD TO LIST PRICE</u> Contact IDC
D	Gate Position Sensor, 10 Amp @ 30VDC	Contact IDC
BR64XL	Rectifier for AC Operation	Contact IDC



GATE EMLOCK® ACCESSORIES

For Sliding Gates		<u>LIST PRICE</u>
1576-BK	Mounting Bracket	Contact IDC
1576-AB	Armature Mounting Bracket	Contact IDC
For Swinging Gates		
1576-MP	Lock Mounting Plate	Contact IDC
1576-ZB	Lock Mounting Bracket	Contact IDC

EXIT DEVICES

5000 SERIES LIGHT DUTY



* US20A and US28 Finishes Only

Rim Type

5510S	Panic Rated, 36"
5610S	Panic Rated, 36", Narrow Stile
5510S	Panic Rated, 48"
5610S	Panic Rated, 48", Narrow Stile
5510F	Fire Rated, 36"
5610F	Fire Rated, 36", Narrow Stile
5510F	Fire Rated, 48"
5610F	Fire Rated, 48", Narrow Stile



**US20A,
US28**

\$198.40
\$198.40
\$219.80
\$219.80
\$261.30
\$261.30
\$281.40
\$281.40

Surface Vertical Rod Type

5530S	Panic Rated, 36"
5630S	Panic Rated, 36", Narrow Stile
5530S	Panic Rated, 48"
5630S	Panic Rated, 48", Narrow Stile
5530F	Fire Rated, 36"
5630F	Fire Rated, 36", Narrow Stile
5530F	Fire Rated, 48"
5630F	Fire Rated, 48", Narrow Stile

5000 SERIES TRIMS

Escutcheon

58L01A	Classroom/Cylinder
58L01B	Passage/Blank
58L01C	Night Latch
58L01D	Dummy



**US20A,
US28**

\$150.70
\$133.90
\$150.70
\$129.30

Round Rose

53K01A	Classroom/Cylinder
53K01B	Passage/Blank
53K01C	Storeroom/Night Latch
53K01D	Dummy

- * 52R/53K/56P/58L
- * 5510/5610
- * 5530/5630
- * 52R/53K/56P/58L

EXIT DEVICES**5000 SERIES PULL PLATES**

		<u>US20A, US28</u>
Standard		
56P3A/54P3A	Night Latch/Cylinder	\$101.50
56P3B/54P3B	Dummy/Blank	\$60.20
56P3D/54P3D	Exit Only/Flat	\$29.50
Raised-Lip Type		
52R2A	Night Latch/Cylinder	\$20.30
52R2B	Dummy/Blank	\$18.70
52R2D	Exit Only/Flat	\$11.00

5000 SERIES STRIKES

		<u>LIST PRICE</u>
531	Strike Shim for 5510/5610	\$17.20
532	Panic Rim Strike for 5510/5610	\$19.50
533	Fire Rim Strike for 5510	\$19.40
534	Top Strike for 5630	\$24.90
537	Bottom Strike for 5630	\$27.40

5000 SERIES OPTIONS

		<u>ADD TO LIST PRICE</u>
FL001	Fire Latch Bolt	\$48.80
CD	Keyed Cylinder Dogging	\$40.40
426	Rim Cylinder	\$41.70
526	Mortise Cylinder	\$45.60
208	Interchangeable Core, Mortise Cylinder	\$117.50
308	Interchangeable Core, Rim Cylinder	\$117.20

EXIT DEVICES

7100-G1 SERIES GRADE 1 CONCEALED VERTICAL ROD PANIC

7101-G1	Exit Unit Only, No Outside Hardware	<u>36"</u> \$331.40	<u>48"</u> \$364.60
---------	-------------------------------------	------------------------	------------------------

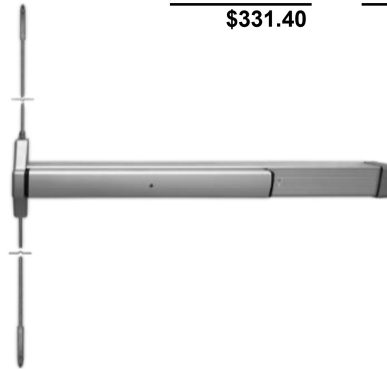

7300-G1 SERIES GRADE1 RIM PANIC

7301-G1	Exit Unit Only, No Outside Hardware	<u>36"</u> \$281.10	<u>48"</u> \$315.70
---------	-------------------------------------	------------------------	------------------------



7100-G1/7300-G1 SERIES GRADE 1 FINISHES

AL	Aluminum		N/C
DU	Storefront Bronze		

7100-G1/7300-G1 SERIES GRADE 1 PARTS AND ACCESSORIES

		<u>ADD TO LIST PRICE</u>
PH-6000	Outside Pull Handle	\$49.70
MP-6000	Pull Handle Mounting Plate	\$12.10
MP-6182	Cylinder Mounting Pad with Locking Ring	\$15.20
CZ-1001	Mortise Key Cylinder (Zinc) with 1 Key & Ring	\$14.30
RZ-1003	Rim Cylinder (Zinc) with 2 Keys & Ring	\$9.30
ST-6312	Standard Surface Roller Strike	\$14.30
RE-6112	12" Rod Extender with Coupler	\$10.70
RE-6124	24" Rod Extender with Coupler	\$13.00
SN12-175	12-24 x 1.75 Sex Nut	\$1.20
7100 / 7300 Dogging Assembly		\$18.90

EXIT DEVICES

8000 SERIES HEAVY DUTY GRADE 1

		<u>US10B</u>	<u>US32D</u>
Rim Type			
8510S/8710S	Panic Rated, 36", Narrow Stile	\$594.50	\$574.60
8610S/8810S	Panic Rated, 36"	\$594.50	\$574.60
8510S/8710S	Panic Rated, 48", Narrow Stile	\$649.80	\$629.70
8610S/8810S	Panic Rated, 48"	\$649.80	\$629.70
8510F/8710F	Fire Rated, 36", Narrow Stile	\$663.70	\$643.50
8610F/8810F	Fire Rated, 36"	\$663.70	\$643.50
8510F/8710F	Fire Rated, 48", Narrow Stile	\$718.70	\$698.80
8610F/8810F	Fire Rated, 48"	\$718.70	\$698.80
Mortise Lock Type			
8620S/8820S	Panic Rated, 36"	\$1,030.20	\$1,008.90
8620S/8820S	Panic Rated, 48"	\$1,085.50	\$1,064.20
8620F/8820F	Fire Rated, 36"	\$1,099.50	\$1,078.10
8620F/8820F	Fire Rated, 48"	\$1,154.80	\$1,133.10
Surface Vertical Rod Type			
8530S/8730S	Panic Rated, 36", Narrow Stile	\$856.70	\$838.70
8630S/8830S	Panic Rated, 36"	\$856.70	\$838.70
8530S/8730S	Panic Rated, 48", Narrow Stile	\$912.30	\$893.90
8630S/8830S	Panic Rated, 48"	\$912.30	\$893.90
8530F/8730F	Fire Rated, 36", Narrow Stile	\$926.00	\$905.90
8630F/8830F	Fire Rated, 36"	\$926.00	\$905.90
8530F/8730F	Fire Rated, 48", Narrow Stile	\$981.20	\$961.40
8630F/8830F	Fire Rated, 48"	\$981.20	\$961.40
Concealed Vertical Rod Type			
8550S/8750S	Panic Rated, 36", Narrow Stile	\$856.70	\$837.00
8650S/8850S	Panic Rated, 36"	\$856.70	\$837.00
8550S/8750S	Panic Rated, 48", Narrow Stile	\$912.30	\$892.10
8650S/8850S	Panic Rated, 48"	\$912.30	\$892.10
8550F/8750F	Fire Rated, 36", Narrow Stile	\$926.00	\$905.90
8650F/8850F	Fire Rated, 36"	\$926.00	\$905.90
8550F/8750F	Fire Rated, 48", Narrow Stile	\$981.20	\$961.40
8650F/8850F	Fire Rated, 48"	\$981.20	\$961.40
Less Bottom Rod Surface Vertical Rod Type			
LBR8630S/8830S	Panic Rated, 36"	\$732.40	\$712.50
LBR8630S/8830S	Panic Rated, 48"	\$787.90	\$767.90
LBR8630F/8830F	Fire Rated, 36"	\$801.70	\$781.60
LBR8630F/8830F	Fire Rated, 48"	\$856.70	\$837.00



8000 SERIES ESCUTCHEON TRIMS

		<u>US10B</u>	<u>US32D</u>
Narrow Stile			
87L01A	Classroom/Cylinder	\$312.00	\$296.70
87L01B	Passage/Blank	\$295.00	\$281.40
87L01C	Night Latch	\$312.00	\$296.70
87L01D	Dummy	\$259.60	\$244.40
Wide Stile			
88L01A/89L01A	Classroom/Cylinder	\$312.00	\$296.70
88L01B/89L01B	Passage/Blank	\$295.00	\$281.40
88L01C/89L01C	Night Latch	\$312.00	\$296.70
88L01D/89L01D	Dummy	\$259.60	\$244.40

QUIET DUO™ LATCH RETRACTION / DOGGING KIT

LR100-K Field Installed Retrofit Kit, 700 mA Inrush, 200 mA Continuous @ 24VDC

Contact IDC



* US32D Finish Only
 * 8810/8710
 * 8830/8730
 * 85P/87P/88L/89L

EXIT DEVICES**8000 SERIES PULL PLATES**

		US10B	US32D
Narrow Stile			
84P-3A/85P-3A	Classroom/Cylinder with Thumbpiece	\$221.20	\$227.60
84P-3B/85P-3B	Passage/Blank with Thumbpiece	\$181.30	\$189.20
84P-3C/85P-3C	Night Latch/Cylinder	\$107.80	\$113.90
84P-3D/85P-3D	Dummy	\$66.20	\$72.40
Wide Stile			
86P-5A/87P-5A	Classroom/Cylinder with Thumbpiece	\$244.40	\$250.40
86P-5B/87P-5B	Passage/Blank with Thumbpiece	\$204.50	\$212.10
86P-5C/87P-5C	Night Latch/Cylinder	\$130.70	\$137.00
86P-5D/87P-5D	Dummy	\$89.30	\$95.40

8000 SERIES STRIKES

		LIST PRICE
801	Rim Strike for 8510S/8710S, 8610S/8810S, 13/16" Projection	\$17.50
802	Rim Strike for 8510F/8710F, 8610F/8810F, 13/16" Projection	\$19.20
818	Mortise Strike for 8620S/8820S	\$15.90
828	Mortise Strike for 8620S/8820S	\$15.30
812	Top Strike for 8530S/8730S, 8630S/8830S, 29/32" Projection	\$17.50
822	Top Strike for 8530S/8730S, 8630S/8830S, 1-1/8" Projection	\$15.90
813	Top Strike for 8550S/8750S, 8650S/8850S	\$27.40
823	Top Strike for 8550S/8750S, 8650S/8850S, 3/4" Mortise	\$27.40
815	Bottom Strike for 8530S/8730S, 8630S/8830S, 8550S/8750S, 8650S/8850S	\$27.40
825	Bottom Strike for 8530S/8730S, 8630S/8830S, 8550S/8750S, 8650S/8850S	\$27.40
888	Strike for LBR8630S/8830S and Mullion 7200, 7/8" Projection	\$63.30
689	Hook for LBR8630S/8830S and Mullion 7200, 7/8" Projection	\$63.30
862	Threshold Strike, 6/16" Projection	\$12.30
720	Double Door Strike, 1-15/16" Projection	\$43.00
618	Sex Nut and Bolt for Standard 1-3/4" thick door	\$14.10
623	Sex Nut and Bolt for 2-1/4" thick door	\$14.10
630	Sex Nut and Bolt for 2-1/2" thick door	\$14.10

8000 SERIES AUXILIARY HARDWARE

		LIST PRICE
Surface Mounted Door Coordinators		
SMC-32	32" Length	\$139.90
SMC-42	42" Length	\$149.10
SMC-52	52" Length	\$160.10
SMC-60	60" Length	\$175.20
Filler Bars		
F6012	12" Length	\$14.10
F6020	20" Length	\$21.80
F6036	36" Length	\$37.10
F6048	48" Length	\$47.80
Mounting Brackets		
MB2	For Stop Width Over 2-1/4"	\$41.70
MB3	For Stop Width 7/8" to 2-1/4"	\$45.00
Keyed Removable Mullions		
7100	Non-Fire Rated Set	\$850.10
7200	Fire Rated Set	\$850.10

EXIT DEVICES**8000 SERIES OPTIONS**

		<u>ADD TO LIST PRICE</u>
FL001	Fire Latch Bolt	\$48.80
CD	Keyed Cylinder Dogging	\$40.40
426	Rim Cylinder	\$41.70
526	Mortise Cylinder	\$45.60
208	Interchangeable Core, Mortise Cylinder	\$117.50
308	Interchangeable Core, Rim Cylinder	\$117.20
E	Dual Electric Latch Retraction and Dogging	\$1,026.60
R	Request-to-Exit Output, SPDT	\$118.40
L	Latch Position Status Output, SPDT, 3 Amp	\$118.40
EMC	Sequencer Module for Automatic Doors	\$221.80
AL-A	Exit Alarm, 9V Battery Operated, Monitors Push Bar	\$637.60
AL-B	Exit Alarm, 9V Battery Operated, Monitors Push Bar & Latch Bolt	\$698.80
MF/MS	Mortise Exit Device, Failsafe/Failsecure, 600/300 mA @ 12/24VDC	\$295.50
DE	Delayed Egress, Wall Mount Controller with Keypad Control and Reset	\$1,845.70
KDE	Delayed Egress, Wall Mount with Keypad/Keyswitch Control and Reset	\$1,993.50
G	Electric Dogging, 170/100 mA @ 12/24VDC	\$664.70
		<u>LIST PRICE</u>
EKE03/GKE03	Standard or R Lever Electric Trim, less Mortise Cylinder	\$996.90
LS	Electric Trim Locked/Unlocked Status, SPDT 3 Amp contact	\$118.40

EXIT MECHANICAL SWITCH BARS

		<u>LIST PRICE</u>
MSB550V	Non-Latching Push Bar, 36" Standard, 628 Aluminum Anodized	Contact IDC
MSB550Y	Non-Latching Push Bar, 36" Standard, 335 Black Anodized	
MSB550S	Non-Latching Push Bar, 36" Standard, 629 Bright Stainless Steel	
MSB550U	Non-Latching Push Bar, 36" Standard, 630 Brushed Stainless Steel	

SURE EXIT® SENSE BARS

		<u>LIST PRICE</u>
PSB560V	Request-To-Exit Sense Bar, Non-Latching, 628 Aluminum Anodized	Contact IDC
PSB560Y	Request-To-Exit Sense Bar, Non-Latching, 335 Black Anodized	
PSB560S	Request-To-Exit Sense Bar, Non-Latching, 629 Bright Stainless Steel	
PSB560U	Request-To-Exit Sense Bar, Non-Latching, 630 Brushed Stainless Steel	

EXIT BAR OPTIONS

		<u>ADD TO LIST PRICE</u>
2	2 SPDT Contacts (MSB550)	Contact IDC
42	Bar for 42" Door (may be field cut)	
48	Bar for 48" Door (may be field cut)	
500GL-KIT	One Glass Door Mounting Kit with Adhesive for 8-10 Bars	
500GL-MB	One Glass Door Mounting Kit without Adhesive	
500-SK	Shim Kit	
PT-3V	Armored Flex Conduit, less wires, with Wire Junction Box	



EXIT DEVICES

QUIET DUO™ LATCH RETRACTION / DOGGING KIT

LR100-K Field Installed Retrofit Kit, 700 mA Inrush, 200 mA Continuous @ 24VDC

**LIST
PRICE**
Contact IDC

Compatible Exit Devices

Adams Rite
Arrow
Cal-Royal
Corbin Russwin
Dor-O-Matic
Detex
Dorma

Falcon
Falcon IR
Jackson
Hager
Marshall Best
PDQ
PHI



Sargent
SDC
Stanley K2
Tell
TownSteel
Von Duprin
Yale

Customer to provide IDC with exit device for factory kit installation

**ADD TO
LIST PRICE**
Contact IDC

LR-1L	Retrofit Latch Status Kit
LR-1R	Retrofit Pushpad/Dogging Status or REX Status Kit
602RF	1 Amp Power Supply for 1 to 2 Exit Devices
632RF	2 Amp Power Supply for 3 to 4 Exit Devices
EMC	Sequencer Module for Automatic Doors
PTH-2+4Q	16 Amp Inrush, Six Conductor Power Transfer Hinge
PTH-4Q	4-wire Electric Hinge, 1 Amp max.
PTH-4Q-DPS	4-wire Electric Hinge with Concealed Door Status Contact, 1 Amp max.
PTH-10Q	Ten Conductor Power Transfer Hinge
PT-3V	Armored Flex Conduit, less wires, with Wire Junction Box
PT-5	UL Listed Concealed Power Transfer Device
PTM-2	(2) 18 ga. Wires, 5 Amp @ 12/24V AC/DC
PTM-10	(10) 24 ga. Wires, 1 Amp @ 12/24V AC/DC
400U-L2	2 LEDs, 1 Red and 1 Green, 1 Gang Plate
400NU-L2	2 LEDs, 1 Red and 1 Green, Narrow Plate

500 SERIES EXIT DEVICE REX SWITCHES

510-590 SPDT, 5 Amp @ 30VDC Switch Kits

**LIST
PRICE**
Contact IDC

Compatible Exit Devices

Adams Rite
Cal Royal
Corbin
Dor-O-Matic

Hager
Jackson
Kawneer
Monarch

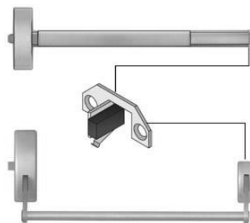

Precision
Sargent
Von Duprin
Yale

LOCKSETS

3000L CYLINDRICAL LOCKS GRADE 2 (LEVER)

			<u>626</u>	<u>613</u>
3010L	Passage		\$83.80	\$87.00
3025L	Exit		\$74.20	\$77.30
3040L	Privacy		\$84.40	\$87.60
3053L	Entrance		\$87.00	\$90.20
3053LIC	Entrance, Interchangeable Core		\$87.00	\$90.20
3070L	Classroom		\$93.30	\$96.50
3070LIC	Classroom, Interchangeable Core		\$93.30	\$96.50
3080L	Storeroom		\$87.00	\$90.20
3080LIC	Storeroom, Interchangeable Core		\$87.00	\$90.20
3170L	Single Dummy		\$26.50	\$29.70

3000K CYLINDRICAL LOCKS GRADE 2 (KNOB)

			<u>626</u>	<u>613</u>
3010K	Passage		\$47.80	\$50.90
3040K	Privacy		\$49.00	\$52.10
3053K	Entrance		\$51.60	\$54.80
3070K	Classroom		\$56.90	\$59.80
3080K	Storeroom		\$51.60	\$54.80
3170K	Single Dummy		\$47.20	\$50.30

4000L SERIES CYLINDRICAL LOCKS GRADE 2

			<u>626</u>	<u>613</u>
4010L	Passage		\$88.80	\$92.00
4025L	Exit		\$79.10	\$82.30
4040L	Privacy		\$89.50	\$92.70
4053L	Entrance		\$92.00	\$95.00
4053LIC	Entrance, Interchangeable Core		\$92.00	\$95.00
4070L	Classroom		\$98.20	\$101.40
4070LIC	Classroom, Interchangeable Core		\$98.20	\$101.40
4080L	Storeroom		\$92.00	\$95.00
4080LIC	Storeroom, Interchangeable Core		\$92.00	\$95.00
4170L	Single Dummy		\$31.60	\$34.70

5000L CYLINDRICAL LOCKS GRADE 1

			<u>626</u>	<u>613</u>
5010L	Passage		\$125.40	\$128.60
5025L	Exit		\$129.80	\$122.40
5040L	Privacy		\$126.10	\$129.30
5053L	Entrance		\$128.60	\$131.70
5053LIC	Entrance, Interchangeable Core		\$128.60	\$131.70
5070L	Classroom		\$134.90	\$138.00
5070LIC	Classroom, Interchangeable Core		\$136.20	\$138.00
5080L	Storeroom		\$128.60	\$131.70
5080LIC	Storeroom, Interchangeable Core		\$128.60	\$131.70
5170L	Single Dummy		\$58.60	\$61.60

DEADBOLTS

HEAVY-DUTY GRADE 1 DEADBOLTS

		626	605	613
40DBKTS6	Grade 1 Single Deadbolt, Key w/ Thumbturn	\$73.70	\$78.40	\$79.50
40DBKKS6	Grade 1 Double Deadbolt, 2 Keys	\$107.50	\$112.30	\$113.60
40DBINS6	Grade 1 Indicator Deadbolt	\$39.50	\$44.30	\$45.50
40DBBT	Grade 1 One Side Deadbolt, Blank w/ Thumbturn	\$67.70	\$72.40	\$73.70

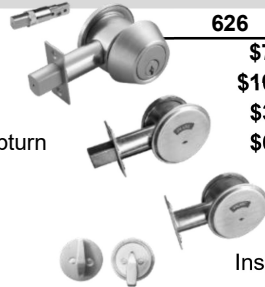

Inside Rose Assembly Style Available

FINISHES AVAILABLE

SN	Satin Nickle	ORB	Oil Rubbed Bronze
SC	Satin Chrome	PVD	Lifetime Finish

DEADLOCKS & DEADLATCHES



- * DT-1850 Long Throw Deadlock
- * DH-1820 Hook Bolt/Short Throw
- * DL-4510 Deadlatch

31/32" or 1-1/8" Cylinder Backset

		SINGLE UNIT PRICE	QUANTITY PER CASE
DH-1820-H	Hook Bolt Deadlock Only	\$23.90	25
DH-1821-H	Hook Bolt Deadlock, Flat Faceplate	\$26.80	25
DH-1822-H	Hook Bolt Deadlock, Radius Faceplate	\$26.80	25
DH-1823-H	Hook Bolt Deadlock, Radius Weatherstripped	\$27.60	25
DH-1824-H	Hook Bolt Deadlock, Left Hand Beveled Faceplate	\$26.80	25
DH-1825-H	Hook Bolt Deadlock, Right Hand Beveled Faceplate	\$26.80	25
DH-1820-S	Short Throw Deadlock, 1-1/8" Backset	\$23.90	25
DH-1821-S	Short Throw Deadlock, Flat Faceplate	\$26.80	25
DH-1822-S	Short Throw Deadlock, Radius Faceplate	\$26.80	25
DH-1823-S	Short Throw Deadlock, Radius Weatherstripped	\$27.60	25
DH-1824-S	Short Throw Deadlock, Left Hand Beveled Faceplate	\$26.80	25
DH-1825-S	Short Throw Deadlock, Right Hand Beveled Faceplate	\$26.80	25
DT-1850	Long Throw Deadlock Only	\$23.90	25
DT-1851	Long Throw Deadlock, Flat Faceplate	\$26.80	25
DT-1852	Long Throw Deadlock, Radius Faceplate	\$26.80	25
DT-1853	Long Throw Deadlock, Radius Weatherstripped	\$27.60	25
DT-1854	Long Throw Deadlock, Left Hand Beveled Faceplate	\$26.80	25
DT-1855	Long Throw Deadlock, Right Hand Beveled Faceplate	\$26.80	25
DL-4510	Deadlatch Only, Field Reversible	\$28.10	25
DL-4511	Deadlatch Deadlock, Flat Faceplate	\$31.20	25
DL-4512	Deadlatch Deadlock, Radius Faceplate	\$31.20	25
DL-4513	Deadlatch Deadlock, Radius Weatherstripped	\$31.90	25
DL-4514	Deadlatch Deadlock, Left Hand Beveled Faceplate	\$31.20	25
DL-4515	Deadlatch Deadlock, Right Hand Beveled Faceplate	\$31.20	25

1-1/2" Cylinder Backset

DH-1820-H	Hook Bolt Deadlock Only	\$28.10	25
DH-1821-H	Hook Bolt Deadlock, Flat Faceplate	\$31.20	25
DH-1822-H	Hook Bolt Deadlock, Radius Faceplate	\$31.20	25
DH-1823-H	Hook Bolt Deadlock, Radius Weatherstripped	\$31.90	25
DH-1824-H	Hook Bolt Deadlock, Left Hand Beveled Faceplate	\$31.20	25
DH-1825-H	Hook Bolt Deadlock, Right Hand Beveled Faceplate	\$31.20	25
DT-1850	Long Throw Deadlock Only	\$28.10	25
DT-1851	Long Throw Deadlock, Flat Faceplate	\$31.20	25
DT-1852	Long Throw Deadlock, Radius Faceplate	\$31.20	25
DT-1853	Long Throw Deadlock, Radius Weatherstripped	\$31.90	25
DT-1854	Long Throw Deadlock, Left Hand Beveled Faceplate	\$31.20	25
DT-1855	Long Throw Deadlock, Right Hand Beveled Faceplate	\$31.20	25

DOOR HARDWARE

FACEPLATES

For Use with DH-1820-H and DH-1820-S

FP-1821	Flat
FP-1822	Radius
FP-1823	Radius Weatherstripped
FP-1824	Left Hand Beveled
FP-1825	Right Hand Beveled



SINGLE UNIT PRICE	QUANTITY PER CASE
\$3.10	25
\$3.10	25
\$4.20	25
\$3.10	25
\$3.10	25

For Use with DT-1850

FP-1851	Flat
FP-1852	Radius
FP-1853	Radius Weatherstripped
FP-1854	Left Hand Beveled
FP-1855	Right Hand Beveled



\$3.10	25
\$3.10	25
\$4.20	25
\$3.10	25
\$3.10	25

For Use with DL-4510

FP-4511	Flat
FP-4512	Radius
FP-4513	Radius Weatherstripped
FP-4514	Left Hand Beveled

\$3.10	25
\$3.10	25
\$4.20	25
\$3.10	25

FP-4515	Right Hand Beveled	\$3.10	25
---------	--------------------	--------	----

LOCK AND FACEPLATE FINISHES

AL	Anodized Dull Aluminum	N/C
BK	Anodized Black	
DU	Anodized Bronze	

LEVER & PADDLE HANDLES

PH-4521	Paddle Handle with Cam Plug, "Push" to the Left
PH-4522	Paddle Handle with Cam Plug, "Push" to the Right
PH-4523	Paddle Handle with Cam Plug, "Pull" to the Left
PH-4524	Paddle Handle with Cam Plug, "Pull" to the Right
CP-4560	Cam Plug Only
HL-4560	Lever Handle with Cam Plug



LIST PRICE
\$71.90
\$71.90
\$71.90
\$71.90
\$8.00
\$33.90

LEVER & PADDLE HANDLE FINISHES

AL	Baked Dull Aluminum Paint	N/C
DU	Baked Storefront Bronze Paint	



FRAME PORTION TOP PIVOT, DRESS PLATE AND DOOR PORTION TOP PIVOT

		LIST PRICE
400-PF	Frame Portion Top Pivot - DR	\$22.00
400-PF-1	Frame Portion Top Pivot - CL	\$22.00
400-PD	Door Portion Top Pivot	\$12.00
400-PC-AL	Frame Portion Dress Plate - Baked Dull Aluminum Paint	\$7.00
400-PC-DU	Frame Portion Dress Plate - Baked Dull Storefront Bronze Paint	\$7.00

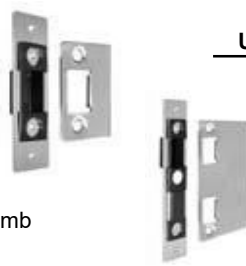
STRIKE SETS

				SINGLE UNIT PRICE	QUANTITY PER CASE
For DL-4510 Deadlatch					
SS-4510	Standard Strike			\$9.10	100
SC-4510	Strike Set			\$14.10	100
SC-4520	Strike Set for MS Type Lock Replacement			\$12.00	100
SC-4540-1	Strike Set, 4" Jamb			\$15.60	100
SC-4545-1	Strike Set, 4-1/2" Jamb			\$16.00	100
SC-4540-2	Strike Set for MS Type Lock Replacement, 4" Jamb			\$18.70	100
SC-4545-2	Strike Set for MS Type Lock Replacement, 4-1/2" Jamb			\$20.20	100



DOUBLE LIPPED STRIKES

			US32D	US4 US10, US10B,	US3, US32
For Center Hung Door					
DS4510	5-3/4" x 2-3/4"		\$87.30	\$106.00	\$123.60
DS4520	6-3/4" x 2-3/4"				
For 1/8" Inset Door					
DS4530	5-3/4" x 2-3/4"				
DS4540	6-3/4" x 2-3/4"				
SDS4500	Custom Size for Cylindrical or Mortise			Contact IDC	

DUST PROOF STRIKES

			US26D US32D	US3, US4, US10, US10B
1870	Rectangular		\$25.10	\$32.30

COMBO DOUBLE LIPPED STRIKE AND RESCUE STOPS

			US32D	US4 US10, US10B,	US3, US32
For Center Hung Door					
CR4550/CR4591	5-3/4" x 2-3/4"		\$258.10	\$321.80	\$340.60
CR4560/CR4592	6-3/4" x 2-3/4"				
For 1/8" Inset Door					
CR4570/CR4594	5-3/4" x 2-3/4"		\$258.10	\$321.80	\$340.60
CR4580/CR4596	6-3/4" x 2-3/4"				
SCR4550/SCR4590	Custom Size for Cylindrical Latch			Contact IDC	
SCRM4550/SCRM4590	Custom Size for Mortise Lock			Contact IDC	

RESCUE STOPS

			US32D	US4 US10, US10B,	US3, US32
4590	Stand Alone Rescue Stop		\$171.30	\$231.90	\$253.90

FLUSH BOLTS

Positive "U" Joint Actuator with 5/8" Throw

FB-1201	1/8" Offset with 7/8" Backset, without Guide
FB-1202	1/8" Offset with 7/8" Backset, with Guide
FB-1203	1/4" Offset with 7/8" Backset, without Guide
FB-1204	1/4" Offset with 7/8" Backset, with Guide
FB-1205	3/16" Offset with 7/8" Backset, without Guide
FB-1206	3/16" Offset with 7/8" Backset, with Guide



SINGLE UNIT PRICE	QUANTITY PER CASE
\$14.50	20
\$15.00	20
\$14.50	20
\$15.00	20
\$14.50	20
\$15.00	20

Positive "U" Joint Actuator with 7/8" Throw

FB-2201	1/8" Offset with 7/8" Backset, without Guide
FB-2202	1/8" Offset with 7/8" Backset, with Guide
FB-2203	1/4" Offset with 7/8" Backset, without Guide
FB-2204	1/4" Offset with 7/8" Backset, with Guide

FLUSH BOLT FINISHES

AL	Baked Dull Aluminum Paint	N/C
BK	Baked Black Paint	
DU	Baked Storefront Bronze Paint	

BOLTS & COORDINATORS

FLUSH BOLT ACCESSORIES



ER-1200	Flush Bolt Extension Rod, 12"
FG-1200	Standard Flush Bolt Guide
FG-1250	Extended Hole Flush Bolt Guide
FR-1200-RM	Flush Bolt Rod with Round Tip
FR-1600-S	Flush Bolt Rod with Square Tip



SINGLE UNIT PRICE	QUANTITY PER CASE
\$5.40	10
\$1.50	50
\$1.50	50
\$5.50	10
\$6.20	10

AUTOMATIC FLUSH BOLTS

1860P	Pair for Metal Doors
1862P	Pair for Wood Doors



US32D	US3, US4, US10, US10B
Contact Us	Contact Us
Contact Us	Contact Us

MANUAL FLUSH BOLTS

1855S	Single for Metal Doors
1857S	Single for Wood Doors



US26D	US3, US4, US10, US10B
Contact Us	Contact Us
Contact Us	Contact Us

SURFACE BOLTS

1815TB	8" with Top & Bottom Strike
1815TBL	8" with Top & Bottom Strike, Locking Bracket
1815TBDL	8" with Top & Bottom Strike, Double Locking Bracket
1825TB	12" with Top & Bottom Strike
1825TBL	12" with Top & Bottom Strike, Locking Bracket
1825TBDL	12" with Top & Bottom Strike, Double Locking Bracket
HD1825TB	12" with Top & Bottom Strike, Heavy Duty
HD1835TB	24" with Top & Bottom Strike, Heavy Duty



US32D
Contact Us
Contact Us
Contact Us
Contact Us
Contact Us
Contact Us
Contact Us

Continue to Bolts, Cylinders and Roller Latches on the next page

BOLTS & COORDINATORS

THRESHOLD BOLTS

TB-4015	Threshold Bolt Kit for up to 53-1/2" Cylinder Height
TB-4016	Threshold Bolt Kit for 34"-37" Cylinder Height



SINGLE UNIT PRICE	QUANTITY PER CASE
\$14.90	50
\$14.90	50

HEADER BOLTS

HB-4085	Header Bolt Set for 84" Height Door
HB-4086	Header Bolt Set for 96"-108" Height Door
HB-4087	Header Bolt Set for 120" Height Door
HS-4089	Header Sign
HB-4015-N	Special Header Bolt Set
ER-4015-N	Extension Rod Kit for 8'-9' Door Heights



SINGLE UNIT PRICE	QUANTITY PER CASE
\$27.60	50
\$28.60	50
\$30.80	50
\$3.40	100
\$36.00	50
\$8.30	50

CYLINDERS & LOCK INDICATORS

CYLINDERS

CZ-1001	Pair of Mortise Key Cylinders (Zinc) with 2 Keys & 2 Rings
DC-2001	Mortise Dummy Cylinder (Zinc) with Ring
RZ-1003	Rim Cylinder (Zinc) with 2 Keys & Ring
TZ-3001	Mortise Thumbturn Cylinder (Zinc) with Ring
CG-4043	Cylinder Guard Set
CR-1155	5/32" Cylinder Ring
CR-1195	Standard Cylinder Ring
CR-1215	7/32" Cylinder Ring



SINGLE UNIT PRICE	QUANTITY PER CASE
\$14.30	100 pairs
\$5.70	100
\$9.30	100
\$7.10	100
\$9.00	100
\$1.30	100
\$1.30	100
\$1.30	100

CYLINDER FINISHES

AL	Anodized Dull Aluminum
BK	Anodized Black
DU	Anodized Bronze



N/C

LOCK INDICATOR SET

HS-4089	Header Sign Only
LI-4088	Lock Indicator Only
LI-4089	Lock Indicator Set



SINGLE UNIT PRICE	QUANTITY PER CASE
\$3.40	100
\$9.80	50
\$11.40	50

LOCK INDICATOR FINISHES

AL	Baked Dull Aluminum Paint
BK	Baked Black Paint
DU	Baked Storefront Bronze Paint

N/C

STAINLESS STEEL ROLLER LATCHES

1890	5/16" Projection, Cast Strike
1890S	5/16" Projection, Custom Strike
1891	5/16" Projection, ASA Strike
1892	5/16" Projection, T-Strike
1893	Integrated Angle Stop, Cast Strike
1894	5/16" Projection, Extended Cast Strike
1895	1/2" Projection, T-Strike
1896	1/2" Projection, ASA Strike
1897	1/2" Projection, Cast Strike
1898	1/2" Projection, Extended Cast Strike



US32D

Contact Us
Contact Us
Contact Us
Contact Us
Contact Us
Contact Us
Contact Us
Contact Us
Contact Us
Contact Us

**US3, US4,
US10, US10B
US32**

Contact Us
Contact Us
Contact Us
Contact Us
Contact Us
Contact Us
Contact Us
Contact Us
Contact Us
Contact Us

DOOR HANDLES & BARS

OFFSET PULL HANDLES

			<u>AL LIST PRICE</u>	<u>DU LIST PRICE</u>
PH-4000-9	CTC 9"	 	\$58.60	\$60.70
PH-4000-10	CTC 10"		\$62.50	\$64.30
PH-4000-12	CTC 12"		\$67.30	\$69.90
PH-4000-2-9	CTC 9" Set		\$117.20	\$121.30
PH-4000-2-10	CTC 10" Set		\$125.00	\$128.50
PH-4000-2-12	CTC 12" Set		\$134.60	\$139.80

PUSH BARS

			<u>AL LIST PRICE</u>	<u>DU LIST PRICE</u>
PB-1000-33	CTC 33-1/16", Single Bend	 	\$91.10	\$95.50
PB-1000-39	CTC 39-1/16", Single Bend		\$107.90	\$111.80
PB-1000-45	CTC 45-1/16", Single Bend		\$129.10	\$132.90
PB-2000-33	CTC 33-1/16", Double Bend		\$94.90	\$98.80
PB-2000-39	CTC 39-1/16", Double Bend		\$110.40	\$114.20
PB-2000-45	CTC 45-1/16", Double Bend		\$132.00	\$135.60

PUSH/PULL SETS

			<u>AL LIST PRICE</u>	<u>DU LIST PRICE</u>
PP-1000-9-33	CTC 9" Pull Handle, 33-1/16" Single Bend Push Bar		\$149.70	\$156.10
PP-1000-10-33	CTC 10" Pull Handle, 33-1/16" Single Bend Push Bar		\$153.60	\$159.70
PP-1000-12-33	CTC 12" Pull Handle, 33-1/16" Single Bend Push Bar		\$158.40	\$165.30
PP-1000-9-39	CTC 9" Pull Handle, 39-1/16" Single Bend Push Bar		\$166.50	\$172.50
PP-1000-10-39	CTC 10" Pull Handle, 39-1/16" Single Bend Push Bar		\$170.40	\$176.10
PP-1000-12-39	CTC 12" Pull Handle, 39-1/16" Single Bend Push Bar		\$175.20	\$181.70
PP-1000-9-45	CTC 9" Pull Handle, 45-1/16" Single Bend Push Bar		\$177.70	\$193.50
PP-1000-10-45	CTC 10" Pull Handle, 45-1/16" Single Bend Push Bar		\$187.70	\$197.10
PP-1000-12-45	CTC 12" Pull Handle, 45-1/16" Single Bend Push Bar		\$191.60	\$202.80
PP-2000-9-33	CTC 9" Pull Handle, 33-1/16" Double Bend Push Bar		\$196.40	\$159.40
PP-2000-10-33	CTC 10" Pull Handle, 33-1/16" Double Bend Push Bar		\$153.50	\$163.00
PP-2000-12-33	CTC 12" Pull Handle, 33-1/16" Double Bend Push Bar		\$157.40	\$168.70
PP-2000-9-39	CTC 9" Pull Handle, 39-1/16" Double Bend Push Bar		\$162.20	\$174.80
PP-2000-10-39	CTC 10" Pull Handle, 39-1/16" Double Bend Push Bar		\$169.00	\$178.40
PP-2000-12-39	CTC 12" Pull Handle, 39-1/16" Double Bend Push Bar		\$172.90	\$184.10
PP-2000-9-45	CTC 9" Pull Handle, 45-1/16" Double Bend Push Bar		\$190.60	\$196.20
PP-2000-10-45	CTC 10" Pull Handle, 45-1/16" Double Bend Push Bar		\$194.50	\$199.90
PP-2000-12-45	CTC 12" Pull Handle, 45-1/16" Double Bend Push Bar		\$199.30	\$205.50

PUSH/PULL FINISHES

AL	Anodized Dull Aluminum	N/C
DU	Anodized Bronze	

PUSH/PULL HARDWARE

		<u>LIST PRICE</u>
T1-AL	All Glass Door Push/Pull Thru Bolt Set, Aluminum Cap	\$3.00
T1-DU	All Glass Door Push/Pull Thru Bolt Set, Storefront Bronze Cap	\$3.00
T5-Z	BTB Fastener	\$4.40
T6-Z	Concealed Studs	\$3.90

PIVOTS

OFFSET PIVOT SETS

			<u>SINGLE UNIT PRICE</u>	<u>QUANTITY PER CASE</u>
OP-2000 Series	Flush or Recessed Door	 	\$30.00	50
OP-3000 Series*	Flush or Recessed Door		\$32.00	50
OP-4000 Series*	Flush Doors		\$32.00	50
OP-5000 Series*	1/8" Recessed Doors		\$50.00	50
OP-6000 Series*	7/64" Recessed Doors		\$32.00	50
OP-7000 Series*	Kawneer Type		\$70.00	25
OP-1689 Series	Jackson Style Pivot Set (Only Available at IDC West Warehouse)		\$115.00	50

*Please specify handing when ordering

OFFSET PIVOT SET FINISHES

AL	Baked Dull Aluminum Paint	N/C
BK	Baked Black Paint	
DU	Baked Storefront Bronze Paint	

INTERMEDIATE PIVOT SETS

			<u>SINGLE UNIT PRICE</u>	<u>QUANTITY PER CASE</u>
IP-1900 Series	Mortised	 	\$52.00	50
IP-2200 Series	Slotted		\$58.00	50

INTERMEDIATE PIVOT SET FINISHES

AL	Baked Dull Aluminum Paint	N/C
BK	Baked Black Paint	
DU	Baked Storefront Bronze Paint	

BOTTOM PIVOTS

			<u>SINGLE UNIT PRICE</u>	<u>QUANTITY PER CASE</u>
600-PS	Floor Mount		\$49.70	50

HEAVY DUTY HINGES

ALUMINUM CONTINUOUS GEARED HINGES

				83"	95"	120"
117FMC	Full Concealed			\$159.10	\$179.50	\$223.10
117FMD	Full Concealed			\$166.20	\$186.60	\$230.10
217FMC	Full Concealed, Mortise Geared Hinge			\$175.30	\$198.10	\$245.80
217FMD	Full Concealed, Mortise Geared Hinge			\$182.40	\$205.10	\$252.90
317FSC	Full Surface			\$218.80	\$248.10	\$308.30
317FSD	Full Surface			\$225.90	\$255.20	\$315.30
417FSC	Full Surface	\$206.40	\$233.80	\$290.40		
417FSD	Full Surface	\$213.50	\$240.90	\$297.50		
517FSC	Full Surface	\$214.10	\$242.80	\$302.40		
517FSD	Full Surface	\$221.20	\$249.90	\$309.40		
617HSC	Half Surface	\$214.10	\$242.80	\$302.40		
617HSD	Half Surface	\$221.20	\$249.90	\$309.40		

ALUMINUM CONTINUOUS HINGE FINISHES

C	Clear
D	Dark Bronze

FULL MORTISE BALL BEARING BUTT HINGES

		LIST PRICE
Standard Weight		Contact Us
IDCBB814545US26D	5 Knuckle Ball Bearing 4.5 x 4.5 Steel Hinge, Dull Chrome	
IDCBB814545US10B	5 Knuckle Ball Bearing 4.5 x 4.5 Steel Hinge, Oil Rubbed Bronze	
IDCBB514545US32D	5 Knuckle Ball Bearing 4.5 x 4.5 Stainless Steel Hinge	
IDCBB814540-820	5 Knuckle Ball Bearing 4.5 x 4.0 Hinge, Aluminum Powder Coat	
IDCBB814540-812	5 Knuckle Ball Bearing 4.5 x 4.0 Hinge, Dark Bronze Powder	
IDCBB814540-800	5 Knuckle Ball Bearing 4.5 x 4.0 Hinge, Black Powder Coat	
Heavy Weight		
IDC4B814545US26D	5 Knuckle Ball Bearing 4.5 x 4.5 Steel Hinge, Dull Chrome	
IDC4B814545US10B	5 Knuckle Ball Bearing 4.5 x 4.5 Steel Hinge, Oil Rubbed Bronze	
IDC4B514545US32D	5 Knuckle Ball Bearing 4.5 x 4.5 Stainless Steel Hinge	

FULL MORTISE SPRING BUTT HINGES

		LIST PRICE
IDCSP814545US26D	Spring Hinge 4.5 x 4.5 Steel Hinge, Dull Chrome	Contact Us
IDCSP814545US10B	Spring Hinge 4.5 x 4.5 Steel Hinge, Oil Rubbed Bronze	

FULL MORTISE SWING CLEAR BALL BEARING BUTT HINGES

		LIST PRICE
IDCSCBB814545US26D	Swing Clear 4.5 x 4.5 Steel Hinge, Dull Chrome	Contact Us
IDCSCBB814545US10B	Swing Clear 4.5 x 4.5 Steel Hinge, Oil Rubbed Bronze	

BUTT HINGE OPTIONS

		ADD TO LIST PRICE
NRP	Non-Removable Pin	Contact Us

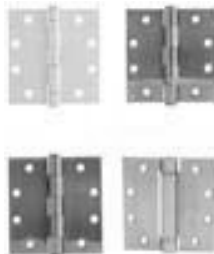

All butt hinges are available in other types, sizes, and finishes

POWER TRANSFERS

POWER TRANSFER HINGES

PTH-4Q	Four Conductor Power Transfer Hinge
PTH-4Q-DPS	Four Conductor Power Transfer Hinge with Door Status Contact
PTH-10Q	Ten Conductor Power Transfer Hinge
PTH-10Q-DPS	Ten Conductor Power Transfer Hinge with Door Status Contact
PTH-2+4Q	16 Amp Inrush, Six Conductor Power Transfer Hinge
PTH-2+4Q-DPS	16 Amp Inrush, Six Conductor Power Transfer Hinge with Door Status



**LIST
PRICE**
Contact Us

POWER TRANSFER HINGE FINISHES

Q	626	Dull Chrome (Standard)
C	605	Bright Brass
H	613	Oil Rubbed Bronze
P	625	Bright Chrome

N/C

POWER TRANSFERS

PT-5	Concealed Power Transfer Device, UL Listed
PT-2U	Armored Flex Conduit, less wires, 18" long, 1/4" ID
PT-3V	Armored Flex Conduit, less wires, with Wire Junction Box



**LIST
PRICE**
Contact Us

POWER TRANSFER DEVICES

PT1000	(10) 24 AWG Wires (S5 OR US28)
PT200	(2) 18 AWG Wires (S5 OR US28)
PT1000EZ	(12) 24 AWG Wires with Molex Connectors (S5 or US28)
PT200EZ	(2) 18 AWG Wires with Molex Connectors (S5 or US28)
PTC5E	CAT-5E Ethernet Cable Wire (S5 or US28)
PT105/PTR105	Square or Rounded 105° Door Swing, No Wire Provided (US32D)
PT180/PTR180	Square or Rounded 180° Door Swing, No Wire Provided (US32D)
PTS105/180	Security Bracket (US32D)
PTM-2	(2) 18 ga. Wires, 5 Amp @ 12/24V AC/DC
PTM-10	(10) 24 ga. Wires, 1 Amp @ 12/24V AC/DC



**LIST
PRICE**
Contact Us

GERM FREE SOLUTIONS - DOOR, FOOT PULL & FOOT PULL HOLDER SET

DOOR PULLS (Only Available at IDC West Warehouse)

- IDC-HA-DOOR PULL* Hand and Arm Pull for a No-Touch Germ Free Solution
*Only Available at IDC West Warehouse
- IDC-ARM PULL* Hand and Arm Pull for a No-Touch Germ Free Solution
*Only Available at IDC West Warehouse



**LIST
PRICE**
\$100.00

\$175.00

FOOT PULLS (Only Available at IDC West Warehouse)

- IDC-HF-FOOT* Foot Operated, for a No-Touch Germ Free Solution
*Only Available at IDC West Warehouse



**LIST
PRICE**
\$70.00

DOOR STOPS & HOLDERS

KICK DOWN HOLDERS

- DH-6000 Heavy Duty Kick Down Holder
- DH-6000-TIP Replacement Rubber Bottom Tip



**LIST
PRICE**
\$28.40
\$2.40

- DH-8000-CB* Foot Operated and Holder Set, for a No-Touch Germ Free Solution
*Only Available at IDC West Warehouse



\$60.00

DOOR SWEEPS / GASKETING

SWEEPS / GASKETING

IDC-601A	7/8" x 1" Aluminum Door Sweep/Brush
IDC-601DKB	7/8" x 1" Dark Bronze Door Sweep/Brush
IDC-673A	9/16" x 1" Aluminum Door Sweep/Brush, Concealed
IDC-673DKB	9/16" x 1" Dark Bronze Door Sweep/Brush, Concealed
IDC-97VA	7/8" x 1" Aluminum Door Sweep/Vinyl
IDC-97VDKB	7/8" x 1" Dark Bronze Door Sweep/Vinyl

**LIST
PRICE**
Contact Us

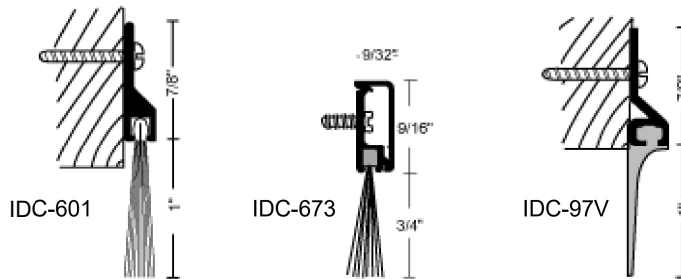

DOOR SWEEPS / GASKETING

Thresholds

IDC-413	1/4" x 4" Aluminum Handicap Threshold
IDC-413DKB	1/4" x 4" Dark Bronze Handicap Threshold
IDC-424E	1/2" x 4" Aluminum Handicap Threshold
IDC-424EDKB	1/2" x 4" Dark Bronze Handicap Threshold
IDC-425E	1/2" x 5" Aluminum Saddle Threshold
IDC-425EDKB	1/2" x 5" Dark Bronze Saddle Threshold
IDC-427E	1/2" x 7" Aluminum Saddle Threshold
IDC-427EDKB	1/2" x 7" Dark Bronze Saddle Threshold
IDC-513	1/4" x 5" Aluminum Saddle Threshold
IDC-513DKB	1/4" x 5" Dark Bronze Saddle Threshold
IDC-713	1/4" x 7" Aluminum Saddle Threshold
IDC-713DKB	1/4" x 7" Dark Bronze saddle Threshold
IDC-1013	1/4" x 10" Aluminum Saddle Threshold
IDC-1013DKB	1/4" x 10" Dark Bronze Saddle Threshold

**LIST
PRICE**
Contact Us

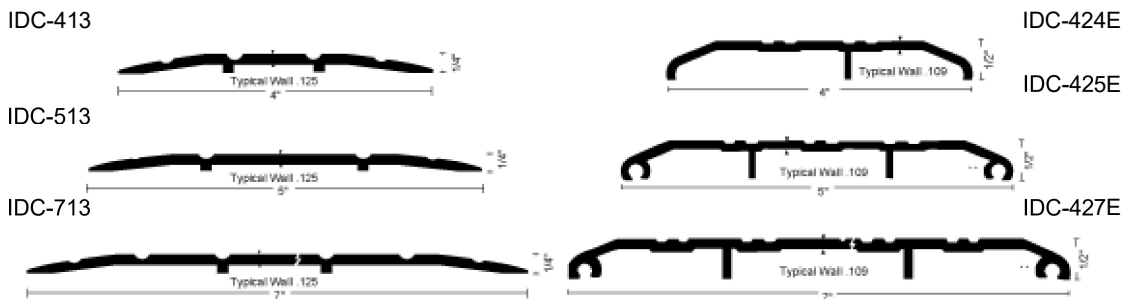

**LIST
PRICE**
Contact Us

IDC-404	3/8" x 4" Aluminum Carpet Divider
IDC-404DKB	3/8" x 4" Dark Bronze Carpet Divider
IDC-414	3/8" x 1-3/4" Aluminum Carpet & Tile Divider
IDC-414DKB	3/8" x 1-3/4" Dark Bronze Carpet & Tile Divider

TRANSMITTERS

10 SERIES 433 MHz TRANSMITTER

10RD433	433 MHz Digital Receiver
10RD433EH	433 MHz Digital Receiver Extended Hold
10TD433HH1	433 MHz Digital Handheld Transmitter 1 Button
10TD433HH2	433 MHz Digital Handheld Transmitter 2 Buttons
10TD433HH3	433 MHz Digital Handheld Transmitter 3 Buttons
10TD433HH4	433 MHz Digital Handheld Transmitter 4 Buttons
10TD433PB3V	433 MHz Digital Wired Transmitter 1 Button with 3 Volt Battery
10TD433PB9V	433 MHz Digital Wired Transmitter 1 Button with 9 Volt Battery



**LIST
PRICE**

Contact Us

10 SERIES 900 MHz TRANSMITTER

10RD900	900 MHz Digital Receiver
10TD900HH1	900 MHz Digital Handheld Transmitter 1 Button
10TD900HH2	900 MHz Digital Handheld Transmitter 2 Buttons
10TD900HH3	900 MHz Digital Handheld Transmitter 3 Buttons
10TD900HH4	900 MHz Digital Handheld Transmitter 4 Buttons
10TD900PB	900 MHz Digital Hardwired Transmitter
10TD900RT	900 MHz Digital Retrofit Transmitter



**LIST
PRICE**

Contact Us

BOLLARDS

10 SERIES BOLLARDS

10BOLLARDBLK	Bollard 42"H X 6"W X 4"D Black
10BOLLARDBRZ	Bollard 42"H X 6"W X 4"D Bronze
10BOLLARDSL	Bollard 42"H X 6"W X 4"D Silver



**LIST
PRICE**

Contact Us

LOW ENERGY OPERATORS

SW SERIES

SW19.10	Low Energy
SW10.10	Full Energy



**LIST
PRICE**

**Contact IDC
Contact IDC**

KEY PADS & CARD READERS

918 INDOOR ENTRY CHECK™ DIGITAL KEYPAD

- 918  Indoor Blue Backlit, Moisture Resistant, Thick S.S. Faceplate 3/32",
500 User Codes, 2 Relays, Timed Anti-Passback, Request-to-Exit/Enter Input
- 918W With Wiegand Output

**LIST
PRICE**

Contact Us

918 INDOOR ENTRY CHECK™ FINISHES

- | | | | | | |
|---|-----|---------------------------------|---|-----|-------------------|
| U | 630 | Dull Stainless Steel (Standard) | | | |
| C | 605 | Bright Brass | H | 613 | Oil Rubbed Bronze |
| D | 606 | Dull Brass | P | 625 | Bright Chrome |

**ADD TO
LIST PRICE**

Contact Us

918 INDOOR ENTRY CHECK™ OPTIONS

- TR12 Plug-In Power Supply
- 900-PS Privacy and Rain Shroud for 918 & 920

**ADD TO
LIST PRICE**

Contact Us

920 INDOOR/OUTDOOR ENTRY CHECK™

- 920  Heavy Cast Vandal Resistant Housing, Heavy Cast Blue Backlit Keys,
500 User Codes, 2 Relays, Timed Anti-Passback, Request-to-Exit/Enter Input
- 920P With Prox Reader
- 920PW With Prox Reader & Wiegand Output

**LIST
PRICE**

Contact Us

KEY PADS & CARD READERS

921P/924P INDOOR/OUTDOOR 2-PIECE ENTRY CHECK™

		<u>LIST PRICE</u>
921P	Heavy Cast Vandal Resistant Housing, Heavy Cast Blue Backlit Keys, 2-Piece Configuration Keypad with Prox Reader and Controller, 500 User Codes	Contact Us
924P	2-Piece Configuration Narrow Keypad with Prox Reader and Controller	



923/923P NARROW INDOOR/OUTDOOR ENTRY CHECK™

		<u>LIST PRICE</u>
923	Heavy Cast Vandal Resistant Housing, Heavy Cast Blue Backlit Keys, Narrow Keypad, 500 User Codes, 2 Relays, Request-to-Exit/Enter Input	Contact Us
923P	With Prox Reader	
923PW	With Prox Reader & Weigand Output	



E5 ENTRY CHECK™ PC MANAGED OR STANDALONE ACCESS CONTROL

		<u>LIST PRICE</u>
E5P	Controller, HID Compatible Prox and PIN Reader, and Remote Relay Module	Contact Us
E5C	Controller Only	



E5 ENTRY CHECK™ ACCESS CONTROL WEIGAND FORMAT CARD AND KEYPAD READERS

		<u>LIST PRICE</u>
6005B	HID Proximity Reader	Contact Us
E5PW	Proximity Reader, HID Compatible	
E5KPW	Proximity and PIN Reader, HID Compatible	
K30W	Narrow Keypad Reader	
K40W	1 Gang Keypad Reader, Heavy Duty Stainless Steel	

E5 ENTRY CHECK™ ACCESS CONTROL PC DATA INTERFACE HARDWARE

		<u>LIST PRICE</u>
E5DI-1	RS485 to USB Data Converter for 1 PC	Contact Us
E5DI-2	RS485/TCP/IP Data Converter for Multiple PCs	

CARDS AND KEY FOBs

		<u>LIST PRICE</u>
HID1326-25	HID ProxCard® II, 25 cards	Contact Us
HID1326-100	HID ProxCard® II, 100 cards	
HID1346-10	HID ProxKey® II, 10 key fobs	
HID1346-100	HID ProxKey® II, 100 key fobs	



MAGLOCKS - UL LISTED ELECTROMAGNETIC LOCKS

10 SERIES UL LISTED MAGLOCKS

1200lb Holding Force

10MAGLOCK1UL Single
 10MAGLOCK5UL Double

600lb Holding Force

10MAGLOCK3UL Single
 10MAGLOCK6UL Double



**LIST
PRICE**

Contact Us

10 SERIES DELAYED EGRESS UL MAGLOCK KIT

1200lb Holding Force

10MAGDE1 All-in-one Delayed Egress Maglock Kit for Single Outswinging Doors
 (includes Maglock, Resettable Key Switch, External Sounder, & Alarm Signage)

Mortise cylinder not included

**LIST
PRICE**

Contact Us

10 SERIES UL LISTED MAGLOCK ACCESSORIES

10LZBRMAG1UL (1) L Bracket & (1) Z Bracket for use with 10MAGLOCK1UL
 10LZBRMAG3UL (1) L Bracket & (1) Z Bracket for use with 10MAGLOCK3UL
 10UBRACKETUL U-Bracket for Mounting to a Glass Door up to 1/2" thick
 MAG5LZUL (2) L Brackets & (2) Z Brackets for use with 10MAGLOCK5UL
 MAG6LZUL (2) L Brackets & (2) Z Brackets for use with 10MAGLOCK6UL
 10FILLER12UL 1/2" x 1 1/4" Filler Bar
 10FILLER34UL 3/4" x 1 1/4" Filler Bar
 10SPACER1UL Vertical Spacer for use with 1200lb UL Listed Maglocks
 10SPACER3UL Vertical Spacer for use with 600 lb UL Listed Maglocks
 10RIMHOUSING1UL Armature Housing for use with 1200lb UL Listed Maglocks
 10RIMHOUSING3UL Armature Housing for use with 600lb UL Listed Maglocks



**LIST
PRICE**

Contact Us

Plated

Special Order - No Cancellations, No Returns

P 625 Bright Chrome Q 626 Dull Chrome

SINGLE

Contact Us

DOUBLE

Contact Us

10 SERIES WEATHER RESISTANT UL LISTED MAGLOCKS

1200lb Holding Force

10GL1200SR Side Mount, without Conduit Fitting
 10GL1200R Front Mount, with Conduit Fitting
 10LZBRGATE1200 (1) L Bracket & (1) Z Bracket



**LIST
PRICE**

Contact Us

STRIKES

15 SERIES ELECTRIC STRIKES

For Cylindrical & Mortise Locksets with 5/8"-3/4" Latch Bolts

15-4F12U	4-7/8", Failsafe, 12VDC
15-4F24U	4-7/8", Failsafe, 24VDC
15-4S12U	4-7/8", Failsecure, 12VDC
15-4S24U	4-7/8", Failsecure, 24VDC

630 Dull Stainless Steel Standard Finish



LIST
PRICE
Contact Us

25 SERIES ELECTRIC STRIKES

For Cylindrical & Mortise Locksets with up to 5/8" Throw Latch Bolts

25-4U	4-7/8" Square Corner, Failsecure, Reversible Failsafe
-------	---

630 Dull Stainless Steel Standard Finish



LIST
PRICE
Contact Us

25 SERIES OPTIONS

BR64XL	Rectifier for AC Operation
RMB	Buzzer, 12/24V AC/DC Operation

ADD TO
LIST PRICE
Contact Us

30 SERIES ELECTRIC STRIKES

For Rim Mount Exit Devices with Pullman Latch Bolts

30-4-12	Stainless Steel 3/4", Failsecure, .51 Amp @ 12VDC
30-4-24	Stainless Steel 3/4", Failsecure, .25 Amp @ 24VDC



LIST
PRICE
Contact Us

30 SERIES OPTIONS

BR64XL	Rectifier for AC Operation
FS	Failsafe Operation
LCBMA-30	Latch and Locking Cam Monitor

ADD TO
LIST PRICE
Contact Us

45 SERIES UniFLEX™ MULTI-APPLICATION ELECTRIC STRIKES

For Locksets with up to 3/4" Latch Bolts

45-4S	4-7/8" x 1-1/4" Square Corner, Reversible Failsafe/Failsecure <i>630 Dull Stainless Steel Standard Finish</i>
45-4R	4-7/8" x 1-1/4" Radius Corner, Reversible Failsafe/Failsecure <i>628 Dull Aluminum Standard Finish</i>
45-6R	6-7/8" x 1-1/4" Radius Corner, Reversible Failsafe/Failsecure <i>628 Dull Aluminum Standard Finish</i>
45-7R	7-15/16" x 1-7/16" Radius Corner, Reversible Failsafe/Failsecure <i>628 Dull Aluminum Standard Finish</i>

LIST
PRICE
Contact Us

45-A	Strike with 3 Faceplates Pack (1) 4-7/8" x 1-1/4" Square Corner Faceplate <i>630 Dull Stainless Steel Standard Finish</i> (1) 4-7/8" x 1-1/4" Radius Corner Faceplate <i>628 Dull Aluminum Standard Finish</i> (1) 7-15/16" x 1-7/16" Radius Corner Faceplate <i>628 Dull Aluminum Standard Finish</i>
------	--



LIST
PRICE
Contact Us

STRIKES**45 SERIES FINISHES**

						ADD TO LIST PRICE Contact Us
U	630	Dull Stainless Steel (Square)	V	628	Dull Aluminum (Radius)	
D	606	Dull Brass	H	613	Oil Rubbed Bronze	
Y	335	Black Anodized				
		Special Finishes for 45-A (3 Faceplates)				

45 SERIES OPTIONS

						ADD TO LIST PRICE Contact Us
K		Keeper Open/Close Status				
RMB		Buzzer, 12/24V AC/DC Operation				

LIP EXTENSION KITS

						LIST PRICE Contact Us
LE451		1" Lip Extension Kit				
LE452		2" Lip Extension Kit (includes two 1" extensions)				
LE453		3" Lip Extension Kit (includes three 1" extensions)				

55 SERIES UniFLEX™ UNIVERSAL APPLICATION GRADE 1 HEAVY DUTY ELECTRIC STRIKES**For Installation in Hollow Metal Frames**

						LIST PRICE Contact Us
55-ABC		Universal Strike				
55-A		Cylindrical Locksets and Locksets with ANSI Centerline Latch Entry				
55-B		Mortise Locksets/Exit Devices with/without Deadlatch Below Latch Bolt				
55-C		Mortise Locksets/Exit Devices with/without Deadlatch Above Latch Bolt				
55-D		Mortise Locksets with Deadbolt and Deadlatch Below Latch Bolt				
55-E		Mortise Locksets with Deadbolt and without Deadlatch				
55-F		Mortise Locksets with Deadbolt and Deadlatch Above Latch Bolt				

All strikes without monitoring are non-handed

Compatible Locks

IDC	(A, C, F)	Corbin Russwin	(B, D)	Marks	(B, D)
Accurate	(B, D)	Dorma	(B, D)	Sargent	(B, D)
Arrow	(B, D)	Falcon	(B, D)	Schlage	(C, F)
Baldwin	(C, E)	Hager	(C, F)	Yale	(B, D)
Best	(B, D)				

55 SERIES FINISHES

						ADD TO LIST PRICE Contact Us
U	630	Dull Stainless Steel (Standard)				
D	606	Dull Brass	P	625	Bright Chrome	
G	612	Dull Bronze	Q	626	Dull Chrome	
H	613	Oil Rubbed Bronze				

55 SERIES MONITORING

						ADD TO LIST PRICE Contact Us
LBM		Latch Bolt Monitor				
LBM/LCM		Door Secure Monitor				
DBM		Deadbolt Monitor, Left or Right Hand (Models 55-D/55-E/55-F Only)				



Models 55-D, 55-E, and 55-F with monitoring are handed

STRIKES

55 SERIES OPTIONS

		<u>ADD TO LIST PRICE</u> Contact Us
BR64XL	Rectifier for AC Operation	
LT	Tri-Color LED (indicates strike is energized)	
RMB	Buzzer, 12/24V AC/DC Operation	

MONITORING STRIKE LATCH STATUS KITS

		<u>LIST PRICE</u> Contact Us
MS-12	2-3/4", Cylindrical Lock Latch or Deadbolt Status, SPDT, 5 Amp	Contact Us
MS-12D	2-3/4", Cylindrical Lock Latch or Deadbolt Status, DPDT, 5 Amp	Contact Us
MS-14	4-7/8", Cylindrical Lock Latch or Deadbolt Status, SPDT, 5 Amp	Contact Us
MS-14D	4-7/8", Cylindrical Lock Latch or Deadbolt Status, DPDT, 5 Amp	Contact Us
MS-16	4-7/8", Mortise Lock Latch Status, SPDT, 5 Amp	Contact Us
MS-16D	4-7/8", Mortise Lock Latch Status, DPDT, 5 Amp	Contact Us
MS-18	4-7/8", Mortise Lock Deadbolt Status, SPDT, 5 Amp	Contact Us
MS-18D	4-7/8", Mortise Lock Deadbolt Status, SPDT, 5 Amp	Contact Us
MS-20	4-7/8", Mortise Lock Latch and Deadbolt Status, SPDT, 5 Amp	Contact Us
MS-20D	4-7/8", Mortise Lock Latch and Deadbolt Status, SPDT, 5 Amp	Contact Us

MS-20 and MS-20D are handed but reversible

10 SERIES RIM EXIT ELECTRIC STRIKE

			<u>LIST PRICE</u> Contact Us
10STRIKERE	Surface Mount Strike for Rim Exit Devices, 12-24V AC/DC <i>US32D Brushed Stainless Steel Standard Finish</i>		Contact Us

10 SERIES UNIVERSAL CYLINDRICAL ELECTRIC STRIKE

			<u>LIST PRICE</u> Contact Us
10STRIKECU	Universal Cylindrical Strike with 3 Modular Faceplates, 12-24V AC/DC <i>US32D Brushed Stainless Steel Standard Finish</i>		Contact Us

POWER CONTROLLERS

(2) OUTPUT SWITCHING POWER SUPPLY/CHARGER

AL175UL Supply/Charger That Converts a 115VAC 60Hz input into (2) individually PTC Protected 12VDC or 24DC outputs.



**LIST
PRICE**
Contact Us

ACCESS CONTROL POWER SUPPLIES CLASS 2

602RFL 1 Amp Power Supply Only
 602RF 1 Amp Power Supply, 12"W x 12"H x 3.75"D Cabinet
 602RFA 1 Amp Power Supply, 16"W x 14"H x 6.5"D Cabinet
 631RFL 1.5 Amp Power Supply Only
 631RF 1.5 Amp Power Supply, 12"W x 12"H x 3.75"D Cabinet
 631RFA 1.5 Amp Power Supply, 16"W x 14"H x 6.5"D Cabinet
 632RFL 2 Amp Power Supply Only
 632RF 2 Amp Power Supply, 12"W x 12"H x 3.75"D Cabinet
 632RFA 2 Amp Power Supply, 16"W x 14"H x 6.5"D Cabinet
 634RF 4 Amp Power Supply, Field Select (1) 4 Amp Output or (2) 2 Amp Outputs
 636RF 6 Amp Power Supply, Field Select (1) 6 Amp Output or (3) 2 Amp Outputs



**LIST
PRICE**
Contact Us

ACCESS CONTROL POWER SUPPLY OPTIONS

12VR Dual 12VDC and 24VDC Output Capability
 MR Cover Mounted Manual Reset Switch for Fire/Emergency Release (except 631RF)
 PS-1 System On-Off Push Switch Inside Enclosure
 PS-1A System On-Off Push Switch On Enclosure Cover
 14-2 7 Day Skip-a-Day Programmable Timer
 PC 6ft Power Cord
 KL Key Lock Cover
 RB12V4 12V/4Ah Battery Back-up
 RB12V7 12V/7Ah Battery Back-up
 230V 220/230VAC, 50/60Hz Input



**ADD TO
LIST PRICE**
Contact Us

POWER CONTROLLERS

VALUE SERIES ACCESS CONTROL POWER SUPPLIES 1 AMP CLASS 2

		LIST PRICE
621PJ	Power Supply and Cabinet, LED Status, UL Listed, 40 VA Plug-In Transformer	Contact Us 
621J	Power Supply and Cabinet with Door Mounted LED System Status Indicator	
621P	Power Supply, Retrofit Mounting Hardware, UL Listed, 40 VA Plug-In Transformer	
621B	Power Supply and Retrofit Mounting Hardware	
RB12V4	12V/4Ah Battery Back-up	
RB12V7	12V/7Ah Battery Back-up	

MULTIPLE OUTPUT & DOOR CONTROL MODULES

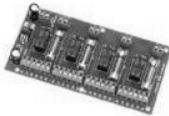
		LIST PRICE
PSM	Power Supply Remote Monitoring Module	Contact Us 
ACM-1	Access Control Module	
CR-4	Control Board with Four Relays	
FB-4	Fused Terminal Board, 4 Individually Fused Outputs	
PB-8	Power Booster, 8 Amp Surge Output	
PB-16	Power Booster, 16 Amp Surge Output	
EMC	Sequencer Module for Pair of Doors and Automatic Doors (602RF/632RF)	

DC POWER SUPPLIES & TRANSFORMERS

		LIST PRICE
TR12	1 Amp 12VDC Regulated Plug-In Power Supply	Contact Us
TR24	1 Amp 24VDC Regulated Plug-In Power Supply	
FB4DC	AC to 4 DC Fused Output Module	
TP1220	1 .6 Amp 12VAC Plug-In Transformer	
TP2440	1 .6 Amp 24VAC Plug-In Transformer	
TJ2440	1 .6 Amp 24VAC Transformer, Foot Plate or Knockout Mount	
TB2450	2 Amp 24VAC Transformer, Foot or Hub Mounted	
TB2475	3 Amp 24VAC Transformer, Foot or Hub Mounted	
BR64XL	Bridge Rectifier, Converts AC Transformer Output to DC	

UNIVERSAL CONTROLLER & MANTRAP MODULES

		LIST PRICE
UR-1	Universal Controller for up to 2 Doors, 12 Selectable Relay & System Logic Modes	Contact Us
UR2-4	Universal Controller for 2 Doors, Field Select TD, LR, TD/LR, Mantrap A, B, C	
UR4-8	Universal Controller for 4 Doors, Field Select TD, LR, TD/LR, Mantrap A, B, C	