

PRO-LOK®

Automotive • Commercial • Facility • Residential • Retail Solutions

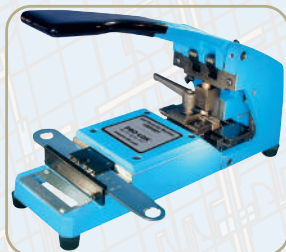

PRODUCT GUIDE



Our Family of Brands:

PRO-LOK®



MARCH 2019

Our Family of Brands:

PRO-LOK



PRO-LOK is built on decades of experience in the manufacturing, security, and retail industries. **PRO-LOK** merges innovative thinking, superior engineering, and distinct industry knowledge to develop high quality products that create valuable solutions that solve problems, save time, and make our customers money. **PRO-LOK** is known for its continued commitment to excellence in customer service and product quality.

As a family owned and family operated manufacturing company based in Orange, CA, **PRO-LOK** has been manufacturing USA MADE products since 1983. Based on the knowledge we have collected, and 17 patents awarded, we have been able to supply the right solutions for the right situation.

WORLD HEADQUARTERS

PRO-LOK

655 North Hariton Street
Orange, California 92868
United States of America

Phone: 866.679.1366

Fax: 714.633.0470

Email: HelpDesk@**PRO-LOK**.com

© 2019 All Rights Reserved. **PRO-LOK** is not responsible for typographical errors found in this literature.

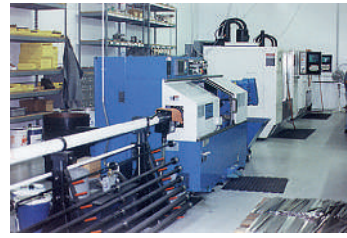

PRO-LOK®

TOOL DIVISION 04

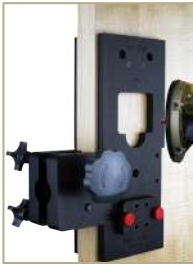

Door Hardware Installation	06
Installation Templates	10
Installation Jigs	06
Installation Accessories	14



Security Door Hardware	15
Entry Armor	15

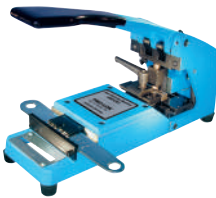

Blue Punch Key Machines	04
Blue Punch Key Machines	05
Blue Punch Accessories	05

Lock Servicing	49
Key Decoders	51
Key Hooks	51
Key Tags	51
Lock Picking	45
Safe "Butter" Bits	50
Automotive Servicing	42
Shop Tools	52



Automotive	35
Automotive Opening Kits	36
Automotive Opening Tools	40
Automotive Opening Lights	41
Automotive Opening Accessories	41



RETAIL DIVISION 15/55

Entry Armor	15
Latch Protectors	23
Wrap Plates	17
Strike Plates	27
Home and Commercial Security	30

Kalifornia Key Chains	55
------------------------------	-----------



PRO-LOK[®]

Soft comfortable handle allows for easy use

NO ELECTRICITY NEEDED

Heavy duty Top Jaw allows for easier and tighter key clamping

Slide the Code Bar to easily change the punching depth

Automatic spacing allows for continuous key punching

Decodes cut depths for rekeying and code cutting to factory specifications and tolerances



Blue Punch Key Machines[™]

PRO-LOK[®]

The Blue Punch™ Key Machine is a dedicated punch machine designed to provide factory original keys. The Blue Punch™ Key Machine creates keys at the speed of a duplicator and is fast, extremely accurate, and easy to use. The Blue Punch™ Key Machine is set up at the factory to provide automatic spacing and depth. An ideal key machine for the system integrator, commercial locksmith, hotels, housing complexes, schools, and other institutions. Fast and easy to use, the Blue Punch™ is a precision machine to the tightest tolerances. Portable, dependable, and hand operated - no electrical outlet needed.

BLUE PUNCH KEY MACHINE™ KEYWAY SPECIFICS

ITEM #	DESCRIPTION	SPECIFIC KEYWAYS
BP201ARFC	ARROW FLEXCORE	• Arrow Flexcore 51, 52, 53, 54, 61, 81, 83, 84 * will cut A3 & A4 w/purchase of code bar
BP201C70	CORBIN C70	• Most Popular Corbin System 70 Keyways 59 Series A1, A2, B1, B2, 60 Series 6 pin
BP201DE	DEXTER / MASTER	• Master Door Locks, All Dexter Cylinder
BP201FW	FALCON / WEISER	• Falcon Standard (Non I/C) - *will Not Cut 8 Or 9 Depths, All Weiser Cylinders
BP201HA	HAGER	• Hager Key Sections H (I.E. H1, H2, H3, H12, H23, H123, etc)
BP201IC	I-CORE	• A2 Standard Interchangeable Core (I/C) - * will cut A3 & A4 w/purchase of code bar • Best, Falcon & Arrow Small Format I/C Key Sections A-R, TA-TE, W Arrow 1A-4D • Exclusions: Arrow Flexcore, Kaba Peaks, Insta-Key
BP201IC-A3	I-CORE A3 SYSTEM	• Interchangeable Core (I/C) A3 System * will cut A2 & A4 w/purchase of code bar
BP201IC-A4	I-CORE A4 SYSTEM	• Interchangeable Core (I/C) A4 System * will cut A2 & A3 w/purchase of code bar
BP201KW	KWIKSET	• Kwikset Standard - *Titan - *Will Not Cut Square 1st Cut, Yale residential
BP201MB	MARSHALL BEST	• Marshall Best Keyways. Call PRO-LOK for keyway verification.
BP201ME07	MEDECO KM - 7°	• Medeco 7° Keyways
BP201ME14	MEDECO KM - 14°	• Medeco 14° Keyways
BP201MEX4	MEDECO KM - X4	• Medeco X4 Keyways. Must be ordered through MEDECO. Contact Medeco directly.
BP201SC	SCHLAGE - CLASSIC	• Schlage Classic (Including I/C) Obverse Key Sections Only C, CE, E, EF, F, FG, G, H, J, K, L (Aftermarket L Blanks Only) • Primus - Same Key Sections As Obverse Except A "P" Has Been Added To Keyway # (ie: CP, CEP, EP, ...Etc.) • Schlage Everest - C Key Sections (I.E. C123, C124, C126, C135, C145..... etc.) (Including I/C) • Everest Primus - Uses Same Names • Everest 29 S Key Sections (S + 3 Digits) • Exclusions: Numbered Key Sections, Quad Key Sections, Reverse Key Sections, Everest-B (B+3 Digits), Everest-D (D+3 Digits)
BP201SCEB	SCHLAGE -SMALL FORMAT	• Schlage Everest - B Key Sections Only - B123, B125, B234, B235, All Other Keys With A B + 3 Digits • Everest 29 R Key Sections (R + 3 Digits) * will cut A3 & A4 w/purchase of code bars
BP201SCED	SCHLAGE - EVEREST D	• Schlage Everest - D Key Sections Only - D120, D123, D124, D134, D135, D145, D234, D235, D245, D345, All Other Keys With a D + 3 Digits • Everest 29 T Key Sections (T + 3 Digits)
BP201SCRV	SCHLAGE - REVERSE	• Schlage Reverse Sections - D,DQ,Q,QS,S,T,U,V,W & Y
BP201WK	WESLOCK	• All Weslock Cylinders
BP201YA	YALE	• Yale KeyMark Key Sections Only - 2A, 2C, 2D, 2E, 2F



BLUE PUNCH KEY MACHINE™ PARTS AND ACCESSORIES

BP-CASE Blue Punch Case



Take your Blue Punch™ almost anywhere with this specialty constructed Blue Punch™ case. The case is designed from rugged hard plastic and includes a sturdy handle to make transportation easier. The inside has a customized area to support your Blue Punch™ machine and a special area for your code bar.



PRO-LOK[®]

Quality Solid Construction

Machined aluminum with hardened bushings

Durable powder coat finish

Easy Backset Changing

Turn backset knobs 180 degrees to positive ball bearing lock. Change the backset from 2-3/8" to 2-3/4" in a instant!

Large comfortable knobs

Eight quality recessed rubber pads help to protect the door finish

2-1/8" hole size

1-1/2" hole size

Easy to Change Hole Sizes

This Jig is unique by easily changing back & forth between 2-1/8" and 1-1/2" holes. Replaceable bushing plates are removed & switched with two screws.

Door thickness adjustment allows you to easily adjust the jig to the thickness of the door. The brass bushing keeps the adjustment knob properly aligned.



Standard Installation Jig



INJIG-KJ Killer Jig Installation Kit



The Killer Jig is made from aircraft-grade machined aluminum that gives a tremendous amount of strength with a light weight and includes hardened bushing and a durable powder coated finish. The large comfortable knobs and door thickness adjustment allows for easy door thickness adjustment. The eight recessed rubber pads are machined into the tool and help protect the finish of the door. Save time with the easy to change backset knob and bore size adaptors. The commercial-grade cutters and markers ensures a professional installation. Includes all items below.

INJIG-100 Heavy Duty Strike Plate Marker

Size: 2-3/4" x 1-1/8" Diameter: 7/8"
Distance b/t screw markers: 2-1/8"

Tool for marking the wood frame for mortising many standard deadbolt strike plates.

INJIG-101 Heavy Duty Latch Marker

Size: 2-1/4" x 1" Diameter: 7/8"
Distance b/t screw markers: 1-5/8"

Tool for marking the wood door for mortising many standard deadbolt and latch face plates.

INJIG-102 Heavy Duty Deadbolt Marker

Size: 2-1/4" x 1-1/8" Diameter: 1"
Distance b/t screw markers: 1-5/8"

Tool for marking the wood door for mortising many commercial deadbolt and latch face plates.

INJIG-103 Heavy Duty Latch Marker

Size: 2-1/4" x 1" Diameter: 1"
Distance b/t screw markers: 1-5/8"

Tool for marking the wood door for mortising many commercial deadbolt and latch face plates.

INJIG-104 Heavy Duty Lip Strike Marker

Size: 2-1/4" x 1-5/8" Diameter: 1"

Tool for marking the wood frame for mortising many standard dead-latch strike plates.

INJIG-108KJ Killer Jig (Jig Only)

Quality solid construction, easy backset changing, easy to change hole sizes, rubber pads to protect the door, large comfortable knobs, easy door thickness adjustment, durable powder coat finish.

INJIG-114 Heavy Duty Carrying Case

Custom molded case with heavy-duty polyurethane interior to protect and store INJIG-KJ tools

INJIG-116 Strike Locator

After the 1" edge bore is drilled, insert the Strike Locator into the hole, close the door, press the Strike Locator toward the frame and the sharp center marks the frame where to drill for property latch or deadbolt alignment.

INJIG-118 1-1/2" Multi-Spur Bit

Commercial-grade spur bit designed to last long and cut more holes. For use on hardware requiring a 1-1/2" cross bore. Designed for use on wood doors.

INJIG-120 2-1/8" Multi-Spur Bit

Commercial-grade spur bit designed to last long and cut more holes. For use on hardware requiring a 2-1/8" cross bore. Designed for use on wood doors.

INJIG-122 Heavy-Duty Auger Bit

Commercial-grade bit used to drill the edge bore for most deadbolts and latches on wood doors. Also designed to drill the hole in wood frames for the deadbolt or latch.

INJIG-124 1-1/2" Bushing Plate

Replacement Bushing Plate, qty 1.

INJIG-126 2-1/8" Bushing Plate

Replacement Bushing Plate, qty 1.

PRO-LOK

- Preps Mortise In Under 5 mins
- For Wood & Aluminum Doors
- Cut Out the Full Lock Body & Face Plate with Ease
- Expandable for Door Coring & Hinge/Strike Prep

Top Clamp and Height Stop

Self-Centering Housing

Shaft with Depth Stop

Bottom Clamp and Lower Stop

Mortise Installation Jig

PRO-LOK®



INJIG-MORT Mortise Jig Installation Kit

Includes the Carrying Case, Aluminum Housing with hardware, 3 cutters (CWB22, CWB25, CWB32), Self Centering Action, Stops, Long Boring Shaft, and Instructions. For doors up to 2-1/8" thickness



DOOR CORING

INJIG-MORT-LDA Door Coring Adaptor

Adaptor for the INJIG-MORT for door coring and installation of electric lock cables through wooden doors from lock to hinge.

Will need a coring cutter (Item # INJIG-MORT-DB3X516 or INJIG-MORT-DB4X516



HINGE AND STRIKE PREP

INJIG-MORT-OMA Offset Mortise Adaptor

Adaptor for the INJIG-MORT for hinge and strike prep. Allows cutting off the hinge recesses and mortise for the strike plate on door frames less than 3-3/4"

Will need a plunger cutter (Item # INJIG-MORT-PD18, INJIG-MORT-PD23, or INJIG-MORT-PD25



INJIG-MORT-SS
Short Boring Shaft
(locks up to 3-1/2")

INJIG-MORT-LS
Long Boring Shaft
(locks up to 6")

INJIG-MORT-CXL
Long Boring Shaft
(locks up to 10-5/8")

THE 5 MINUTE MORTISE Cuts a lock mortise in under 5 minutes!

Both the full lock body and face-plate can be cut out with ease. The mortise hole is automatically centered on the door and accurate results are obtained every time. No other combination of tools can produce such fast and accurate mortise installations.

CUTS A MORTISE INTO WOODEN AND ALUMINUM DOORS

The jig and its precision cutters will cut a mortise in hard wood, soft wood, composite doors and with the use of special cutters, aluminum doors as well, all in under five minutes!



Wood Door
Carbide Tipped



Aluminum Door

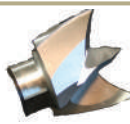

Plunger / Coring

CUTTER ITEM #	SIZE	TYPE
INJIG-MORT-CAB19	3/4"	ALUMINUM CUTTER
INJIG-MORT-CAB25	1"	ALUMINUM CUTTER
INJIG-MORT-CAB32	1-1/4"	ALUMINUM CUTTER
INJIG-MORT-CWB16	5/8"	WOOD CUTTER
INJIG-MORT-CWB18	11/16"	WOOD CUTTER
INJIG-MORT-CWB19	3/4"	WOOD CUTTER
INJIG-MORT-CWB20	25/32	WOOD CUTTER
INJIG-MORT-CWB21	13/16"	WOOD CUTTER
INJIG-MORT-CWB22	7/8"	WOOD CUTTER
INJIG-MORT-CWB24	15/16"	WOOD CUTTER
INJIG-MORT-CWB25	1"	WOOD CUTTER
INJIG-MORT-CWB27	1-1/16"	WOOD CUTTER
INJIG-MORT-CWB29	1-1/8"	WOOD CUTTER
INJIG-MORT-CWB32	1-1/4"	WOOD CUTTER
INJIG-MORT-DB3X516	36" X 5/16"	CORING CUTTER
INJIG-MORT-DB4X516	48" X 5/16"	CORING CUTTER
INJIG-MORT-PD18	11/16"	PLUNGER CUTTER
INJIG-MORT-PD23	29/32"	PLUNGER CUTTER
INJIG-MORT-PD25	1"	PLUNGER CUTTER

DOORS GREATER THAN 2-1/8" THICKNESS INJIG-MORT-CHKS

Adaptor for the INJIG-MORT for mortise prep for doors greater than 2-1/8" thickness, up to 3-1/8".



PRO-LOK

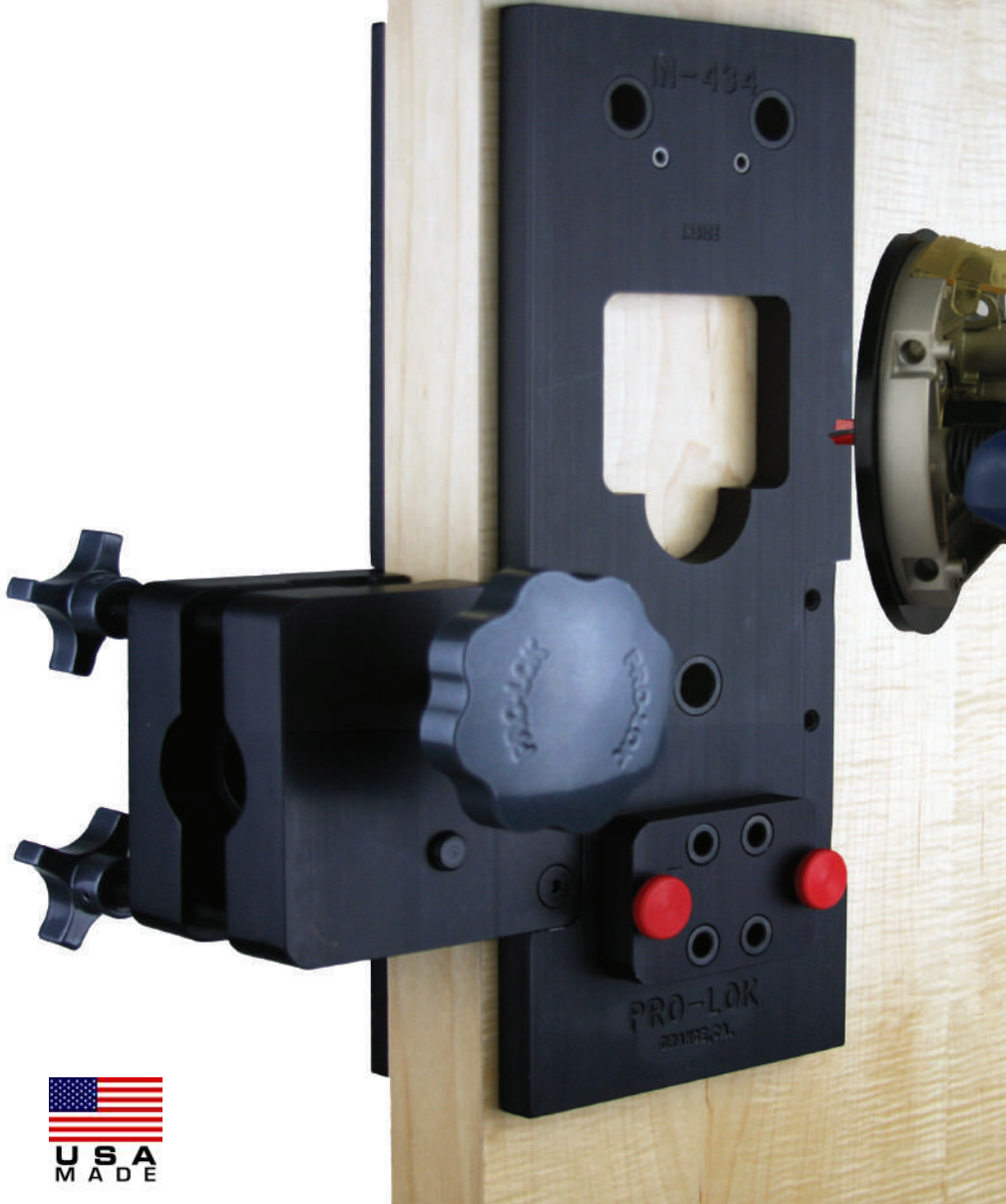

Installation Templates

PRO-LOK[®]

INSTALLATION SOLUTIONS

The heart of the installation system is the “INCL-PRO: Professional Series Universal Clamp”. All templates are designed to work with the INCL-PRO Professional Series Universal Clamp. Additional templates can be purchased at any time, as needed, to be used with the same clamp. This system makes for fewer tools at a more economical price. These items are milled from solid aluminum with a black anodized finish.

The INCL-PRO is specifically engineered to prep both the inside and outside of the door.

Benefits and Features

- Modular design for fewer tools at a more economical price.
- Features true sized holes to eliminate hole size guessing and ensure accuracy.
- Designed to prep both the inside and outside of the door.
- Features hardened, heat treated steel bushings (where applicable).
- Maintains full contact with the door to reduce installation errors.
- Self-centering
- Ideal for retrofitting



INCL-PRO: Professional Universal Clamp

+

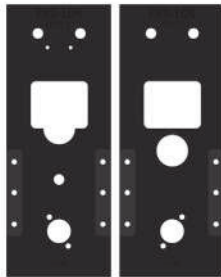

Hardware Specific Installation Templates

=



Quick Template Reference

The table below is to be used as a quick reference and is organized by lock manufacture, hardware type, and finally by part number. Please visit PRO-LOK.com for additional products as we are continuously adding to our line.



MAKE	HARDWARE	TEMPLATE #	FLAT PLATE #
Alarm Lock	Trilogy	IN15-PRO	EWP-IN10-FP-S
Alarm Lock	Cylindrical Locks	IN15-PRO	EWP-IN10-FP-S
Arrow	MLX Series Grade 2	IN20-PRO	EWP-IN20-FP-S-9 or -14
Arrow	Revolution	IN490-PRO	EWP-IN490-FP-S
Arrow	Sierra H-Series	IN75-PRO	EWP-IN20-FP-S-9 or -14
Arrow	QL Series Grade 1	IN20-PRO	EWP-IN20-FP-S-9 or -14
Authority	8160 Series	IN20-PRO	EWP-IN20-FP-S-9 or -14
Baldwin	Mortise Locks	IN65-PRO	N/A
Best	7K Series	IN20-PRO	EWP-IN20-FP-S-9 or -14
Best	9K Series	IN79-PRO	N/A
Cal-Royal	Pioneer Series	IN20-PRO	EWP-IN20-FP-S-9 or -14
Corbin/Russwin	800 Series	IN70-PRO	EWP-IN20-FP-S-9 or -14
Corbin/Russwin	CL3400 Series	IN70-PRO	EWP-IN20-FP-S-9 or -14
Corbin/Russwin	Access 600 CL 33600 TCRNE1 x M802 Integrated Wiegand	IN320-PRO	EWP-IN320-FP-S
Corbin/Russwin	Access 600 ML 20600 TCRNE1 x M802 Integrated Wiegand/iCLASS	IN321-PRO	EWP-IN321-FP-S
Corbin/Russwin	Access 700 CL 33700 TCPAC1 / Offline	IN330-PRO	EWP-IN330-FP-S
Corbin/Russwin	Access 700 CL 33700 TCPIP Online PoE	IN331-PRO	EWP-IN331-FP-S
Corbin/Russwin	Access 700 ML 20700 Offline	IN334-PRO	EWP-IN334-FP-S
Corbin/Russwin	Access 700 ML 20700 Online PoE	IN336-PRO	EWP-IN336-FP-S
Corbin/Russwin	Access 800 CL 33800 TCPIP1 Online PoE	IN340-PRO	EWP-IN340-FP-S
Corbin/Russwin	Access 800 ML 20800 TCAC2 Offline, TCIP1 Online PoE	IN342-PRO	EWP-IN342-FP-S
Falcon	B Series	IN20-PRO	EWP-IN20-FP-S-9 or -14
Falcon	D Series	IN20-PRO	EWP-IN20-FP-S-9 or -14
Falcon	K Series	IN20-PRO	EWP-IN20-FP-S-9 or -14
Falcon	H Series	IN20-PRO	EWP-IN20-FP-S-9 or -14
Falcon	T Series	IN20-PRO	EWP-IN20-FP-S-9 or -14
ILCO	4000 Series	IN20-PRO	EWP-IN20-FP-S-9 or -14
ILCO	Solitaire 850/950	IN13-PRO	N/A
ITEK	Grade 1 Levers	IN78-PRO	EWP-IN20-FP-S-9 or -14
Kaba	Simplex 1000/5000	IN10-PRO	EWP-IN10-FP-S
Kaba	E-Plex 5086, 5286, 5686, 5786, 5886	IN600-MORT-PRO	EWP-IN600-MORT-FP-S
Kaba	E-Plex 2000 (Cylindrical)	IN640-PRO	EWP-IN640-FP-S
Kaba	E-Plex 2000 (Mortise)	IN640-MORT-PRO	EWP-IN640-MORT-FP-S
Kaba	E-Plex 5000, 5200, 5600, 5700, 5800 (Cylindrical)	IN650-PRO	EWP-IN650-FP-S
Kaba	E-Plex 5000, 5200, 5600, 5700, 5800 (Mortise)	IN650-MORT-PRO	EWP-IN650-MORT-FP-S
Lockwood	8000 Series	IN20-PRO	EWP-IN20-FP-S-9 or -14
LSDA	LX1000 Series	IN78-PRO	EWP-IN20-FP-S-9 or -14
Marks	195 - Series	IN78-PRO	EWP-IN20-FP-S-9 or -14
Marks	295 - Series	IN78-PRO	EWP-IN20-FP-S-9 or -14
Medeco	Embassy 17 Series	IN20-PRO	EWP-IN20-FP-S-9 or -14

PRO-LOK®



Add Hardware Specific Flat Cover Plates To Assist In Most Retrofit Situations, Where Legacy Holes Need To Be Covered



MAKE	HARDWARE	TEMPLATE #	FLAT PLATE #
Medeco	Embassy 19 Series	IN78-PRO	EWP-IN20-FP-S-9 or -14
PDQ	SP - Series	IN20-PRO	EWP-IN20-FP-S-9 or -14
PLS	CL- Series	IN20-PRO	EWP-IN20-FP-S-9 or -14
PLS	L -Series	IN20-PRO	EWP-IN20-FP-S-9 or -14
Precision	11 - Series	IN311-PRO	N/A
S. Parker	8161 - Series	IN20-PRO	EWP-IN20-FP-S-9 or -14
Sargent	10 - Line	IN75-PRO	EWP-IN20-FP-S-9 or -14
Sargent	6500 Line	IN78-PRO	EWP-IN20-FP-S-9 or -14
Sargent	7800 / 8800 Mortise	IN440-PRO	EWP-IN440-FP-S
Sargent	8800 Series Rim Exit	IN420-PRO	EWP-IN420-FP-S
Sargent	Passport 10 Line	IN430-PRO	EWP-IN430-FP-S
Sargent	Passport 10 Line	IN431-PRO	EWP-IN431-FP-S
Sargent	Passport 8200 PG offline	IN434-PRO	EWP-IN434-FP-S
Sargent	Passport 8200 / Harmony 10 Line	IN436-PRO	EWP-IN436-FP-S
Sargent	Harmony 10 Line	IN460-PRO	EWP-IN460-FP-S
Sargent	Harmony 8200	IN480-PRO	EWP-IN480-FP-S
Sargent	IN Series (Cylindrical)	IN482-PRO	N/A
Sargent	IN Series (Mortise)	IN482-MORT-PRO	N/A
Sargent	Profile 10 Line / Profile 8200	IN484-PRO	EWP-IN484-FP-S
Sargent	Profile 8200	IN486-PRO	EWP-IN486-FP-S
Schlage	AD - Series (Cylindrical)	IN500-PRO	EWP-IN500-FP-S
Schlage	AD - Series (Mortise)	IN500-MORT-PRO	EWP-IN500-MORT-FP-S
Schlage	AL - Series	IN20-PRO	EWP-IN20-FP-S-9 or -14
Schlage	CO - Series (Cylindrical)	IN510-PRO	EWP-IN510-FP-S
Schlage	CO-Series (Mortise)	IN510-MORT-PRO	EWP-IN510-MORT-FP-S
Schlage	D - Series	IN20-PRO	EWP-IN20-FP-S-9 or -14
Schlage	L - Series / LE - Series	IN50-PRO / IN51	EWP-IN50-FP-S
Schlage	Locknetics	IN52-PRO	N/A
Schlage	ND / NDE - Series	IN20-PRO	EWP-IN20-FP-S-9 or -14
Taco	Grade 1 Levers	IN78-PRO	EWP-IN20-FP-S-9 or -14
USCAN	Grade 1 Cylindrical Levers	IN20-PRO	EWP-IN20-FP-S-9 or -14
USCAN	Grade 2 Cylindrical Levers	IN78-PRO	EWP-IN20-FP-S-9 or -14
U.S. Lock	2000 Series Levers	IN78-PRO	EWP-IN20-FP-S-9 or -14
Von Duprin	99 Series (old style)	IN30-PRO	N/A
Von Duprin	99 Series (new style)	IN30-PRO	N/A
Von Duprin	9927	IN30-PRO / IN40-PRO	N/A
Yale	5400L	IN20-PRO	EWP-IN20-FP-S-9 or -14
Yale	7086 / 7088	IN445-PRO	EWP-IN445-FP-S
Yale	AU / PB	IN78-PRO	EWP-IN20-FP-S-9 or -14
Yale	InTouch	IN490-PRO	EWP-IN490-FP-S

PRO-LOK®

INCL-PRO: PROFESSIONAL SERIES UNIVERSAL CLAMP

The INCL-PRO: Professional Series Universal Clamp is the cornerstone of the modular PRO-LOK® IN-Series Installation Template system. It is designed to hold both (2) the front and back specialty IN-Series templates at one time, for one easy set-up and lightening fast door prep!

The INCL-PRO holds templates in full contact with the door to reduce the chances of installation errors, damage to the door finish or misalignment.

Easy to use on 1-3/4" wood or metal doors with a 2-3/4" backset or adjustable for other size doors with adapter accessories

Made from lightweight aluminum and featuring three sure-grip knobs

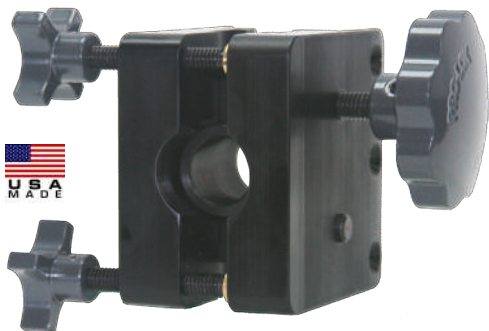

INEXT3-PRO: 3-3/4" BACKSET ADAPTOR



This Adaptor Set is designed to adjust the Professional Universal Clap (INCL-PRO) for proper alignment of an IN-PRO Series template on a door with a 3-3/4" backset.

Made from heavy-duty aluminum.



INEXT5-PRO: 5" BACKSET ADAPTOR



This Adaptor Set is designed to adjust the Professional Universal Clap (INCL-PRO) for proper alignment of an IN-PRO Series template on a door with a 5" backset.

Made from heavy-duty aluminum.



INCLA-PRO: BACKSET/DOOR THICKNESS ADAPTOR



This Adaptor Set is designed to adjust the Professional Universal Clap (INCL-PRO) for proper alignment of an IN-PRO Series on a 1-3/4" door with a 2-3/4" backset to 2-3/8".

Made from heavy-duty aluminum.



IN51: MORTISE ALIGNMENT CENTERING TOOL



The Mortise Alignment Tool is used with the Professional Universal Clap (INCL-PRO) for mortise templates to center the template on a door with a mortise pocket already cut out. Made from heavy-duty aluminum with an anodized finish.



INCL-PRO: Professional Universal Clamp

Hardware Specific Installation Templates

VIEW ALL
INSTALLATION
TOOLS



ONLINE AT
PRO-LOK.com

Home and Commercial Security Hardware



Secure Today,
Protect Tomorrow.

www.EntryArmor.com

MARKETING AIDS

ENTRY ARMOR PRO-LOK

ELP-240
Elongated Design Fits The Widest Array Of Commercial Locksets. One Spacer Provided.
Mounting Hardware.

Entry Armor's Patent Pending "Spacers" Assist With The Height Or Offset Adjustment Between The Door And Frame For A Tight Fit.

ELP-250
Compact Design To Fit Standard Commercial Locksets. One Spacer* Provided.
Mounting Hardware.

ELP-251
RIGHT HAND

ELP-252
LEFT HAND

ELP-210
For Standard Commercial Level* Locks

ELP-210
Center
Offers A Perfect Fit For Commercial Locks And Deadbolts Which Is Available In 3 Configurations: Center (Shown), Left Hand Or Right Hand

ELP-100
Interlocking For In-Opening Doors. Also Available In 12" Length ELP-110

3 VERSIONS TO CHOOSE FROM
LEVEL 1 SECURITY
Heavy-Duty To Deliver Forward Entry And Clear, Built-In Blast-Resistant Reinforcing 3-Axis-Spread Pins

LEVEL 2 SECURITY
Provides Additional Commercial Grade Security To Deliver Forward Entry And Clear (Anti-Separation Reinforcing 1-Axis-Spread Pins)

LEVEL 3 SECURITY
Provides Commercial Grade Security To Deliver Forward Entry

ELP-200 ELP-210

Visit www.ENTRYARMOR.com For More Security Door Hardware!

ENTRY ARMOR PRO-LOK

RESIDENTIAL SECURITY

DOOR LOCKS

RDL-100
Single-Use Door Lock Used For In-Opening Doors Available In White & Chrome

RD-100
Door-Open/Close Lock Available In Chrome & White

PATIO DOOR LOCKS

EPD-100
For Use On Patio And Outside Sliding Doors. Features 4-Point Contact And Blast-Resistant Reinforcing 2-Axis

EPD-100D
For Use On Patio And Outside Sliding Doors. Features 4-Point Contact And Blast-Resistant Reinforcing 2-Axis

WINDOW LOCKS

EWL-100
Single-Use Lock For Windows And Screen Doors

EWL-100D
Single-Use Lock For Windows And Screen Doors

Large Wall Displays

Display Board Size: 33" x 23"

ENTRY ARMOR PRO-LOK

WRAP PLATE DOOR REINFORCERS

SPECIALTY PLATES

Model	Height	Width	Depth	Weight
SP-100	1-1/8"	3-3/8"	1/2"	1.5 lbs
SP-100D	1-1/8"	3-3/8"	1/2"	1.5 lbs
SP-100S	1-1/8"	3-3/8"	1/2"	1.5 lbs

MOUNTING PLATES

Model	Height	Width	Depth	Weight
MP-100	1-1/8"	3-3/8"	1/2"	1.5 lbs
MP-100D	1-1/8"	3-3/8"	1/2"	1.5 lbs
MP-100S	1-1/8"	3-3/8"	1/2"	1.5 lbs

EDGE GUARDS

Model	Height	Width	Depth	Weight
EG-100	1-1/8"	3-3/8"	1/2"	1.5 lbs
EG-100D	1-1/8"	3-3/8"	1/2"	1.5 lbs
EG-100S	1-1/8"	3-3/8"	1/2"	1.5 lbs

1-1/8" TOP ROSE & 1-1/8" BOTTOM ROSE

Model	Height	Width	Depth	Weight
TR-100	1-1/8"	3-3/8"	1/2"	1.5 lbs
TR-100D	1-1/8"	3-3/8"	1/2"	1.5 lbs
TR-100S	1-1/8"	3-3/8"	1/2"	1.5 lbs

1-1/8" TOP ROSE & 1-1/8" BOTTOM ROSE

Model	Height	Width	Depth	Weight
TR-100	1-1/8"	3-3/8"	1/2"	1.5 lbs
TR-100D	1-1/8"	3-3/8"	1/2"	1.5 lbs
TR-100S	1-1/8"	3-3/8"	1/2"	1.5 lbs

ADA LEVERS - 0-1/8" ROSE

Model	Height	Width	Depth	Weight
AL-100	0-1/8"	3-3/8"	1/2"	1.5 lbs
AL-100D	0-1/8"	3-3/8"	1/2"	1.5 lbs
AL-100S	0-1/8"	3-3/8"	1/2"	1.5 lbs

1-1/8" TOP ROSE & 1-1/8" BOTTOM ROSE

Model	Height	Width	Depth	Weight
TR-100	1-1/8"	3-3/8"	1/2"	1.5 lbs
TR-100D	1-1/8"	3-3/8"	1/2"	1.5 lbs
TR-100S	1-1/8"	3-3/8"	1/2"	1.5 lbs

BLANKS

Model	Height	Width	Depth	Weight
BK-100	1-1/8"	3-3/8"	1/2"	1.5 lbs
BK-100D	1-1/8"	3-3/8"	1/2"	1.5 lbs
BK-100S	1-1/8"	3-3/8"	1/2"	1.5 lbs

Visit www.ENTRYARMOR.com For More Security Door Hardware!

Counter Displays Available



Secure Today,
Protect Tomorrow.

Threaded inserts for
latch/bolt screws



- **Provides additional protection**
- **Deters forced entry**
- **Attractive retail packaging**
- **Packaging is resealable**
- **Backside of packaging is see through for easy bore and finish recognition without opening the package**



Wrap Plates



1-1/2" BORE

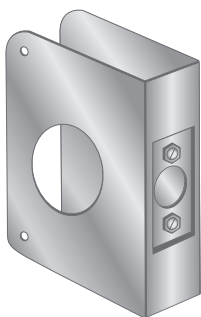

ITEM #	BACKSET	DOOR THICKNESS	OVERALL SIZE
EWP-100- ____ PB, S <small>Finish</small>	2-3/8"	1-3/8"	4" x 4-1/2"
EWP-101- ____ PB, S <small>Finish</small>		1-3/4"	4" x 4-1/2"
EWP-110- ____ PB, S <small>Finish</small>	2-3/4"	1-3/8"	4-1/4" x 4-1/2"
EWP-111- ____ PB, S <small>Finish</small>		1-3/4"	4-1/4" x 4-1/2"

ADA Levers - 2-1/8" BORE



EWP-160

ITEM #	BACKSET	DOOR THICKNESS	OVERALL SIZE
EWP-160- ____ PB, S <small>Finish</small>	2-3/4"	1-3/4"	4-3/4" x 4-1/2"
EWP-161- ____ PB, S <small>Finish</small>			4-3/4" x 9"
EWP-163- ____ PB, S <small>Finish</small>			4-3/4" x 12"
EWP-164- ____ PB, S <small>Finish</small>			5" x 14"
EWP-164-CTR ____ PB, S <small>Finish</small>			5" x 14"
EWP-165- ____ PB, S <small>Finish</small>			6-1/2" x 9"
EWP-166- ____ S <small>Finish</small>			5-3/4" x 20"



EWP-161
EWP-163

EWP-164

* **EWP-164-CTR**
bore is in the center



EWP-165

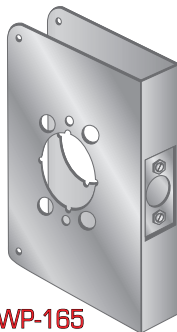

EWP-166



AB = ANTIQUE BRASS

PB = POLISHED BRASS

S = STAINLESS STEEL

DU = DURONODIC is available upon request

* Stock Finishes Are Listed Under Each Part Number ** Most wrap plates are provided in a clamshell packaging, with full color graphics for retail display.

2-1/8" BORE



ITEM #	BACKSET	DOOR THICKNESS	OVERALL SIZE
EWP-120 ____ PB, S <small>Finish</small>	2-3/8"	1-3/8"	4" x 4-1/2"
EWP-121 ____ AB, PB, S <small>Finish</small>			4" x 9"
EWP-122 ____ AB, PB, S <small>Finish</small>			4" x 4-1/2"
EWP-123 ____ AB, PB, S <small>Finish</small>			4" x 9"
EWP-124 ____ PB, S <small>Finish</small>			5" x 20"
EWP-130 ____ PB, S <small>Finish</small>	2-3/4"	1-3/4"	4-1/4" x 4-1/2"
EWP-131 ____ PB, S <small>Finish</small>			4-1/4" x 9"
EWP-132 ____ PB, S <small>Finish</small>			4-1/4" x 4-1/2"
EWP-133 ____ AB, PB, S <small>Finish</small>			4-1/4" x 9"
EWP-134 ____ PB, S <small>Finish</small>			5" x 12"
EWP-135 ____ PB, S <small>Finish</small>			5" x 14"
EWP-135-CTR ____ PB, S <small>Finish</small>			5" x 14"
EWP-136 ____ PB, S <small>Finish</small>			5" x 20"
EWP-137 ____ PB, S <small>Finish</small>			6-1/2" x 9"
EWP-151 ____ PB, S <small>Finish</small>			5"

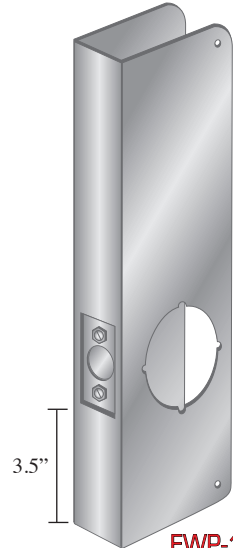

EWP-135
* EWP-135-CTR
bore is in the center

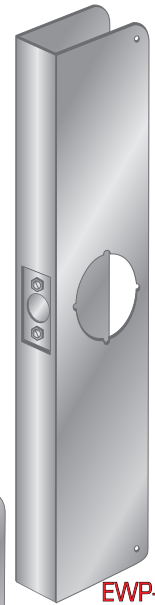

EWP-136



**EWP-121, EWP-123,
EWP-131, EWP-133,
EWP-134**



**EWP-137
EWP-151**

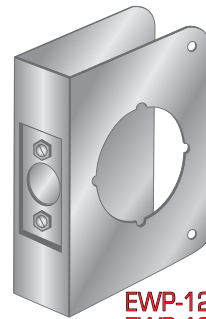

**EWP-120, EWP-122,
EWP-130, EWP-132**



1-1/2" TOP BORE, 2-1/8" BOTTOM BORE



ITEM #	BETWEEN HOLES	BACKSET	DOOR THICKNESS	OVERALL SIZE
EWP-200- ____ PB, S <small>Finish</small>	4"	2-3/8"	1-3/8"	4" x 9"
EWP-201- ____ PB, S <small>Finish</small>			1-3/4"	4" x 9"
EWP-210- ____ PB, S <small>Finish</small>		2-3/4"		4-1/4" x 9"
EWP-211- ____ PB, S <small>Finish</small>	6"			4-1/4" x 12"



2-1/8" TOP BORE, 2-1/8" BOTTOM BORE

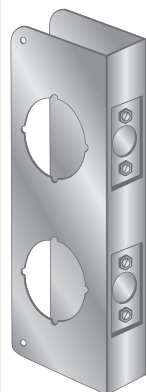

ITEM #	BETWEEN HOLES	BACKSET	DOOR THICKNESS	OVERALL SIZE
EWP-220- ____ PB, S <small>Finish</small>	3-5/8"	2-3/8"	1-3/8"	4" x 9"
EWP-221- ____ PB, S <small>Finish</small>	3-5/8"			4" x 9"
EWP-222- ____ PB, S <small>Finish</small>	4"			
EWP-223- ____ PB, S <small>Finish</small>	5-1/2"	2-3/4"	1-3/4"	4" x 12"
EWP-225- ____ PB, S <small>Finish</small>	3-5/8"			4-1/4" x 9"
EWP-226- ____ PB, S <small>Finish</small>	4"			4-1/4" x 9"
EWP-227- ____ PB, S <small>Finish</small>	5-1/2"			4-1/4" x 12"
EWP-228- ____ PB, S <small>Finish</small>	6"			4-1/4" x 12"



EDGE GUARDS * Not Retail Packaged



EWP-232



**EWP-230
EWP-231**

ITEM #	DOOR THICKNESS	OVERALL SIZE
EWP-230- ____ PB, S <small>Finish</small>	1-3/8"	4-1/2" x 1"
EWP-231- ____ PB, S <small>Finish</small>	1-3/4"	4-1/2" x 1"
EWP-232- ____ S <small>Finish</small>	1-3/4"	12" x 1"



EWP-250



EWP-251



EWP-252

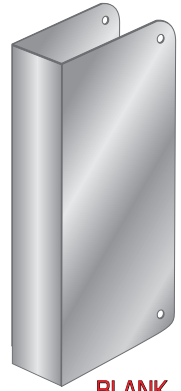

BLANK

ITEM #	HOLE SIZE	BACKSET	DOOR THICKNESS	OVERALL SIZE	DESCRIPTION
EWP-250- S Finish	1-1/2"	2-3/4"	1-3/4"	5" x 12"	1-1/4" x 8" face plate, 1-7/8" x 6" side prep
EWP-251- S Finish	1-1/2"	2-3/4"	1-3/4"	5" x 12"	1-1/4" x 8" face plate, 1-5/8" x 7-5/16" side prep
EWP-252- PB, S Finish	N/A	N/A	1-3/4"	5" x 12"	86 cut out, 1-1/4" x 8" face plate, blank sides

BLANKS



ITEM #	HOLE SIZE	BACKSET	DOOR THICKNESS	OVERALL SIZE
EWP-290- PB, S Finish	N/A	N/A	1-3/8"	4-1/4" x 4-1/2"
EWP-292- PB, S Finish	N/A	N/A		4-1/4" x 9"
EWP-291- PB, S Finish	N/A	N/A	1-3/4"	4-1/4" x 4-1/2"
EWP-293- PB, S Finish	N/A	N/A		4-1/4" x 9"
EWP-294- PB, S Finish	N/A	N/A		5" x 12"
EWP-295- PB, S Finish	N/A	N/A		5" x 20"

SPECIALTY PLATES

1-3/4" Door Thickness, 2-3/4" Backset

ITEM #	DESCRIPTION
EWP-300- ____ PB, S _____ Finish	Alarm Lock T2 & T3 5" x 14"
EWP-320- ____ PB, S _____ Finish	Best 93K 5-1/2" x 12-1/2"
EWP-500- ____ S _____ Finish	Kaba E-Plex 2000 5" x 14"
EWP-501- ____ S _____ Finish	Kaba E-Plex 5700 5" x 14"
EWP-541- ____ PB, S _____ Finish	Medeco & Marks Levers 4-3/4" x 5-1/2"
EWP-542- ____ PB, S _____ Finish	Marks I-Q 5" x 15"
EWP-545- ____ S _____ Finish	Mas Hamilton Power Levers 5" x 15"
EWP-660- ____ S _____ Finish	Simplex & Kaba from Knob Lock 5" x 9"
EWP-661- ____ PB, S _____ Finish	Simplex & Kaba from Knob Mortise 5" x 14"
EWP-670- ____ S _____ Finish	Sargent 6500 Series 4-3/4" x 5-1/2"
EWP-671- ____ PB, S _____ Finish	Sargent 6500 Series 4-3/4" x 9"
EWP-680- ____ S _____ Finish	Schlage Cobra 5" x 12"
EWP-681- ____ PB, S _____ Finish	Schlage Cobra 5" x 14"



FLAT COVER PLATES

Includes Inside and Outside Plates

ITEM #	DESCRIPTION
EWP-IN10-FP- ____ S _____ Finish	Kaba Simplex 1000/5000
EWP-IN15-FP- ____ S _____ Finish	Alarm Lock Trilogy
EWP-IN20-FP- ____ S _____ Finish	Schlage D, ND, NDE Series
EWP-IN434-FP- ____ S _____ Finish	Sargent Passport 8200 PG Offline
EWP-IN482-FP- ____ S _____ Finish	Sargent IN Series CYC
EWP-IN482- MORT-FP- ____ S _____ Finish	Sargent IN Series Mortise
EWP-IN510-FP- ____ S _____ Finish	Schlage CO Series CYC
EWP-IN510- MORT-FP- ____ S _____ Finish	Schlage CO Series Mortise
EWP-IN500-FP- ____ S _____ Finish	Schlage AD Series CYC
EWP-IN500- MORT-FP- ____ S _____ Finish	Schlage AD Series Mortise

**Full List of Flat
Plates on Page
12-13**

Samples of Specialty Plates

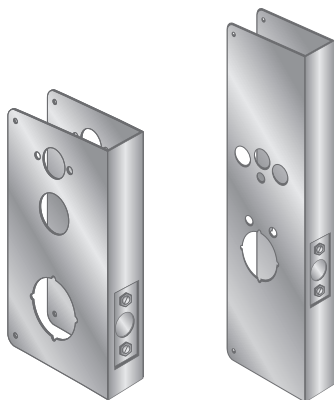

EWP-661

EWP-681

VIEW ENTIRE SELECTION OF
WRAP PLATES AND FLAT PLATES



ONLINE AT **PRO-LOK**.com



Secure Today,
Protect Tomorrow.



- **New Installation Spacers**
- **New Designs**
- **New Finish Options**
- **Attractive Display Packaging**

Latch Protectors

When needed, our spacer allows the latch protector to be installed if there is a large offset between the door and the frame. In many instances latch protectors could not be properly installed without our spacer.

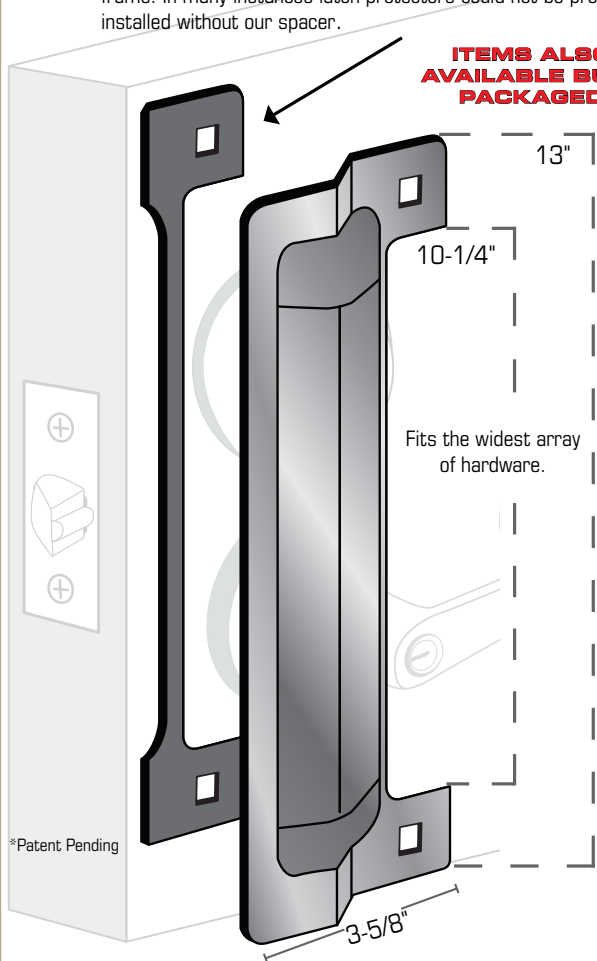

Additional Spacers
ELP-240-XSP 3/pack

Sex Bolts Available:
Item: ZELP-SCREW-SB
Sex Bolt Set w/ Allen Wrench

ELP-240- Finish
Latch Protector w/ no pin
13" x 3-5/8"

- Accommodates a wide variety of locks
 - Includes 1 spacer to adjust offset between door and jamb
 - Designed for out-opening doors
 - 15/box
 - 1/4" offset
- AB, AL, B, C, DU, S

ELP-240-1- Finish
Latch Protector w/ 1 pin
13" x 3-5/8"

- Accommodates a wide variety of locks
 - Includes 1 spacer to adjust offset between door and jamb
 - Designed for out-opening doors
 - 15/box
 - 1/4" offset
- AB, AL, B, C, DU, S

ELP-240-2- Finish
Latch Protector w/ 2 pins
13" x 3-5/8"

- Accommodates a wide variety of locks
 - Includes 1 spacer to adjust offset between door and jamb
 - Designed for out-opening doors
 - 15/box
 - 1/4" offset
- AB, AL, B, C, DU, S

LEVEL 3 SECURITY



Model: ELP-240



LEVEL 2 SECURITY

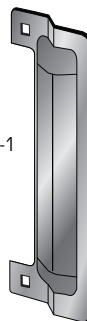

Model: ELP-240-1



Anti-Spread Pin

LEVEL 1 SECURITY



Model: ELP-240-2



Anti-Spread Pins

When needed, our spacer allows the latch protector to be installed if there is a large offset between the door and the frame. In many instances latch protectors could not be properly installed without our spacer.

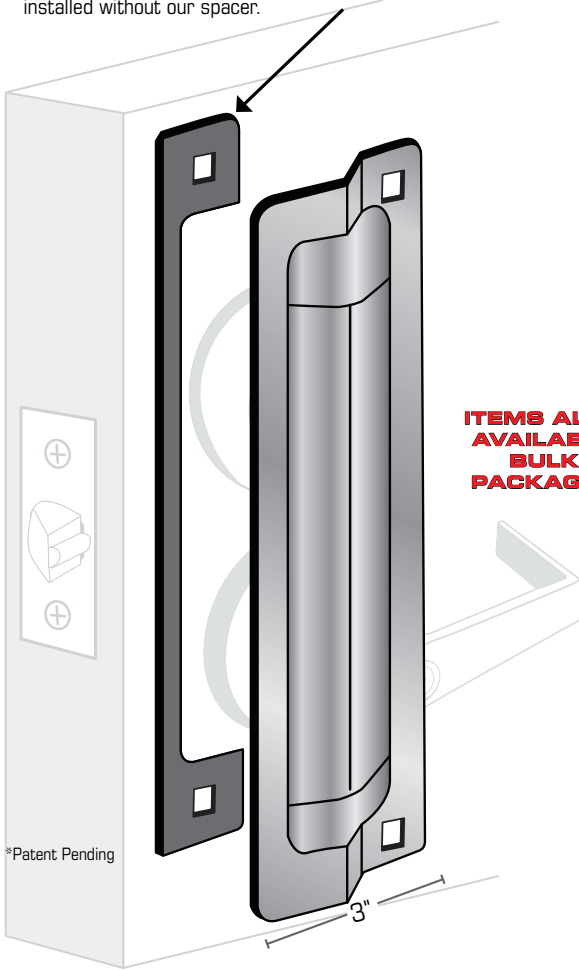

ITEMS ALSO AVAILABLE BULK PACKAGED

Additional Spacers
ELP-250-XSP 3/pack

Sex Bolts Available:
Item: ZELP-SCREW-SB
 Sex Bolt Set w/Allen Wrench

LEVEL 3 SECURITY



Model: ELP-250



LEVEL 2 SECURITY

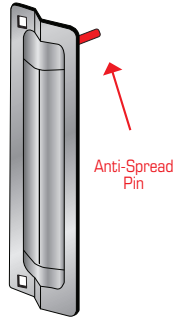

Model: ELP-250-1



LEVEL 1 SECURITY

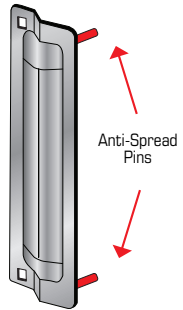

Model: ELP-250-2



ELP-250-

Finish

Latch Protector w/ no pin 11" x 3"

- Accommodates a wide variety of locks
- Includes 1 spacer to adjust offset between door and jamb
- Designed for out-opening doors
- 15/box
- 1/4" offset

AB, AL, B, C, DU, S

ELP-250-1-

Finish

Latch Protector w/ 1 pin 11" x 3"

- Accommodates a wide variety of locks
- Includes 1 spacer to adjust offset between door and jamb
- Designed for out-opening doors
- 15/box
- 1/4" offset

AB, AL, B, C, DU, S

ELP-250-2-

Finish

Latch Protector w/ 2 pin 11" x 3"

- Accommodates a wide variety of locks
- Includes 1 spacer to adjust offset between door and jamb
- Designed for out-opening doors
- 15/box
- 1/4" offset

AB, AL, B, C, DU, S

AB - ANTIQUE BRASS AL - ALUMINUM B - BRASS C - CHROME DU - DURONODIC PB - POLISHED BRASS PC - PRIME COAT S - STAINLESS STEEL W - WHITE

*Stock Finishes Are Listed Under Each Part Number. Additional Finishes Are Available Upon Request. ** All Items Display Packaged Unless Noted



ELP-100- Finish

Latch Protector - 7" Interlocking

- Designed for in-opening doors
- Deters spreading the door from the frame
- Compatible with deadbolts and locksets
- Size: 7" x 5/8"
- 10/box

AL, B, C, DU



ELP-110- Finish

Latch Protector - 12" Interlocking

- Designed for in-opening doors
- Deters spreading the door from the frame
- Compatible with deadbolts and locksets
- Size: 12" x 5/8"
- 10/box

AL, B, C, DU



ELP-120- Finish

Latch Protector - T Style

- Designed for use on in and out-opening doors
- Deters tampering of bolt and latch
- Size: 6" x 1-13/16"
- 10/box

AL, B

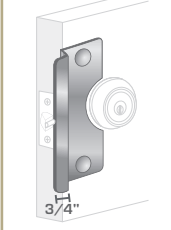

ELP-200- Finish

Latch Protector - 6" Center Rose

- Protect the latch or deadbolt
- For out-opening doors
- Compatible with deadbolts, and locksets
- Size: 6" x 2-13/16"
- 10/box

AL, B, C

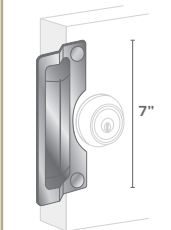

ELP-210- Finish

Latch Protector - 7" x 3" Center Rose

- Designed for out-opening doors
- Accepts up to a 3-1/2" rose
- For right or left handed doors
- Compatible with deadbolts, and locksets
- 22/box



AL, B, C, DU, S

ELP-220 Series

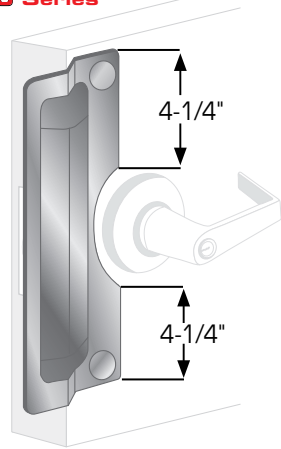

ELP-220- Finish

Latch Protector - 11" x 3" Center Rose

- Designed for out-opening doors
- Accepts up to a 3-1/2" rose
- For right or left handed doors
- For all backsets, deadbolts, and locksets

AL, B, C, DU, S

Anti-Spread Pin Options Available

ELP-220-1 or ELP-220-2

Spacers Available

ELP-220-XSP 3/pack

ZELP-SCREW-SS

Sex Bolt; Set w/Allen Wrench

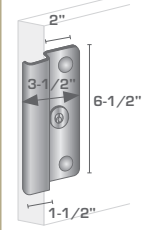

ELP-300- Finish

Latch Protector - Narrow Stile Door

- Designed for out-opening narrow stile doors
- 1 bolt and 1 drive rivet included
- 6-1/2 X 3-1/2"
- 5/box

AL, DU

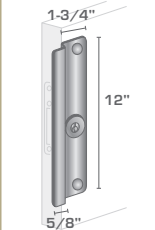

ELP-310- Finish

Latch Protector - Narrow Stile Door

- Designed for out-opening doors
- 10/box

AL, DU



Need A Custom Product Or Custom Finish? Contact Our Custom Department Today!

AB - ANTIQUE BRASS AL - ALUMINUM B - BRASS C - CHROME DU - DURONODIC PG - POLISHED BRASS PC - PRIME COAT S - STAINLESS STEEL W - WHITE

*Stock Finishes Are Listed Under Each Part Number. Additional Finishes Are Available Upon Request.

** All Items Display Packaged Unless Noted



Secure Today,
Protect Tomorrow.

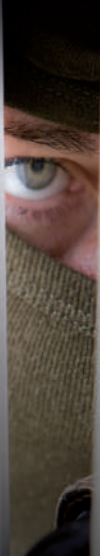

Double Lip



High Security Box

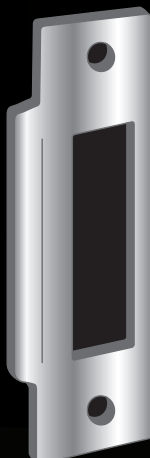

Mortise



"T" Strike



Adjustable

Strike Plates



ESP-100-
Finish
Strike Plate - "T"

- Size: 1-1/8" x 2-3/4"
- Replaces old strike plates
- Fits in standard "T" cut out
- Screws provided
- 10/box

B, C



ESP-131-
Finish
Strike Plate - Double Lip

- Fits double locks with 5-1/2" or 6" centers
- Size: 11" x 1-5/8"
- 10/box

B



ESP-104-
Finish
Strike Plate - Full Lip

- Size: 2-1/4" x 1-1/8"
- Replaces standard strike plates
- Fits in standard residential holes
- Wood screws provided
- 25/box

AB, B, C



ESP-140-
Finish
Strike Plate - 6" Security

- Size: 6" x 1-1/8"
- Six 1-1/2" long screws included for additional holding power
- 10/box

B, C



ESP-110-
Finish
Strike Plate - Security Lip

- Size: 8" x 1-1/4"
- Reinforces door jamb for added strength and security
- Deters tampering and kick-ins
- Includes 1-1/4" and 3" screws
- 10/box

B



ESP-141-
Finish
Strike Plate - 7-3/4" Security

- Size: 7-3/4" x 1-5/8"
- Reinforces door jamb for added strength and security
- Deters tampering and kick-ins
- Includes 1-1/4" and 3" long screws
- 10/box

B



ESP-120-
Finish
Strike Plate - Large Lip

- Size: 4-7/8" x 1-1/4"
- Covers smaller strike plate holes
- 2-1/2" long screws for added security
- 10/box

B



ESP-142-
Finish
Strike Plate - 3-5/8" Security

- Size: 3-5/8" x 1-1/4"
- Reinforces door jamb for added strength and security
- Deters tampering and kick-ins
- Includes 1-1/4" and 3" long screws
- 10/box

B

ESP-120-BULK

- 10/box

ESP-130-
Finish
Strike Plate - Double Lip w/ 3-5/8" Center

- Size: 11" x 1-5/8"
- Fits double locks with 3-5/8" or 4" centers
- 5/box

B



ESP-143-
Finish
Strike Plate - 4-7/8" Security

- Size: 4-7/8" x 1-1/4"
- Reinforces door jamb for added strength and security
- Deters tampering and kick-ins
- Includes 1-1/4" and 3" long screws
- 10/box

B



Need A Custom Product Or Custom Finish? Contact Our Custom Department Today!

AB = ANTIQUE BRASS AL = ALUMINUM B = BRASS C = CHROME DU = DURONODIC PB = POLISHED BRASS PC = PRIME COAT S = STAINLESS STEEL W = WHITE

*Stock Finishes Are Listed Under Each Part Number. Additional Finishes Are Available Upon Request. ** All Items Display Packaged Unless Noted

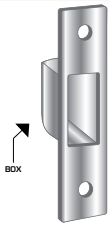

ESP-150-
Finish

Strike Plate - High Security Box Strike

- Size: 4-7/8" x 1-1/4"
- Box encloses bolt
- Reinforces door jamb for added strength and security
- Deters tampering and kick-ins
- Includes 2" long screws
- 5/box

B, C



ESP-172-
Finish

Strike Plate - Large Lip

- Size: 4-7/8" x 1-1/6"
- Covers small strike plates holes
- Covers damaged wood
- Metal and wood screws provides
- 10/box

S



ESP-170-
Finish

Strike Plate - Mortise

- Size: 4-7/8" x 1-1/4"
- Bulk packaged 1/poly bag
- 50/box

C



ESP-180-
Finish

Strike Plate - Small Adjustable

- Size: 2-3/4" x 1-1/8"
- Adjustable plate allowing for a tighter fit of the door to the frame and weather stripping
- 10/box

B



ESP-171-
Finish

Strike Plate - ANSI Lip

- Size: 4-7/8" x 1-1/4"
- Wood and machine screws included
- Bulk packaged 1/poly bag
- 50/box

C



ESP-181-
Finish

Strike Plate - Large Adjustable

- Size: 4-7/8" x 1-1/4"
- Adjustable plate allowing for a tighter fit of the door to the frame and weather stripping
- 10/box

B



AB = ANTIQUE BRASS AL = ALUMINUM B = BRASS C = CHROME DU = DURNODIC PB = POLISHED BRASS PC = PRIME COAT S = STAINLESS W = WHITE

*Stock Finishes Are Listed Under Each Part Number. Additional Finishes Are Available Upon Request. ** All Items Display Packaged Unless Noted



Secure Today,
Protect Tomorrow.



Residential & Commercial
Security



Security Door Hardware

EAP-100-^{Finish} **Adaptor Plate - 2-5/8"**



- Covers up wood damage around lock
- For mortise and rim cylinders
- 1-1/4" inside hole diameter
- 2-5/8" outside diameter
- Includes 1 part
- 10/box

B

EFP-100-^{Finish} **Filler Plate - 8" x 1-1/4"**



- Converts 86 cut out to 161 prep
- 3/8" off center line
- Bulk packaged, 1/poly bag
- 25/box

PC

EAP-110-^{Finish} **Adaptor Plate - 2-3/4"**

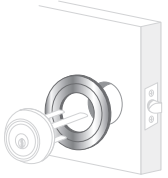

- Changes 2-1/8" bore to 1-1/2" bore
- Covers up wood damage around lock
- 1-1/2" inside hole diameter
- 2-3/4" outside diameter
- Includes 2 parts
- 25/box

B, C

EFP-110-^{Finish} **Filler Plate - 4-7/8" x 1-1/4"**



- Size 4-7/8" x 1-1/4"
- Bulk packaged, 1/poly bag
- 25/box

PC

EAP-120-^{Finish} **Adaptor Plate - 3-1/2"**



- Covers up wood damage around lock
- For locks with a 2-1/8" bore
- Convert 2-3/8" to 2-3/4" backset
- Allows for use on Grade 1 key-in-lever locks on 1-3/8" door
- 2-1/8" inside hole diameter
- 3-1/2" outside diameter
- Includes 2 part
- 25/box

AB, B, C

EFP-120-^{Finish} **Filler Plate - 2-1/4" x 1-1/8"**



- Size 2-1/4" x 1-1/8"
- Filler plates for 161 cut-out
- Bulk packaged, 1/poly bag
- 25/box

PC

EHC-100-^{Finish} **Hole Cover - 2-5/8"**

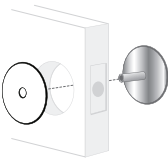

- Hole cover for 1-1/2" or 2-1/8" holes
- 5/box

B, C, PC

EHC-100-PC-BULK **Hole Cover - 2-5/8"**

- Hole cover for 1-1/2" or 2-1/8" holes
- 10/box

EFP-130-^{Finish} **Filler Plate - 8" x 1-1/4"**



- Size 8" x 1-1/4"
- Filler plates for 86 mortise lock cut-out
- Bulk packaged, 1/poly bag
- 25/box

PC

EDK-100-^{Finish} **Knob Set - Brass w/Spindle**

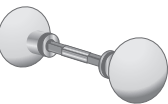

- Solid brass knob set
- Spindle included
- 5/box packaged

B

EDK-101-^{Finish} **Knob Set - Glass w/Spindle**

- Solid glass knob set
- Spindle included
- 5/Bulk

Glass

EFP-131-^{Finish} **Filler Plate - 2-1/4" x 1"**



- Size 2-1/4" x 1"
- Filler plates for 160 cut-out
- Bulk packaged, 1/poly bag
- 25/box

PC



Need A Custom Product Or Custom Finish? Contact Our Custom Department Today!

AB - ANTIQUE BRASS AL - ALUMINUM B - BRASS C - CHROME DU - DURONODIC PB - POLISHED BRASS PC - PRIME COAT S - STAINLESS STEEL W - WHITE

*Stock Finishes Are Listed Under Each Part Number. Additional Finishes Are Available Upon Request. ** All Items Display Packaged Unless Noted

EDL-100-^{Finish}

Door Guard - Swing Bar



- Size: 2-1/2" x 4"
- Works on in-opening doors
- 10/box

B, C

EDL-154-^{Finish}

Door Guard - Security Foot Bolt



- 4" foot bolt
- Provides extra strength and security for wood doors
- Deadlocking latch bolt
- 10/box

C

EDL-110-^{Finish}

Door Guard - Chain 3-5/8"

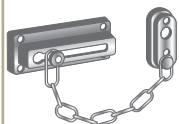

- Size: 2-1/4" x 4-1/4"
- For wood or metal doors
- Extra long screws included
- 10/box

AB, B

EDV-100-^{Finish}

Door Viewer - 160° 1/2" Small



- Clear lens
- Scratch proof lens
- Moist/water proof
- For doors 1-3/8" to 2" thick
- 1/2" barrel diameter
- 10/box

PB

EDL-130-^{Finish}

Door Guard - Key Locked

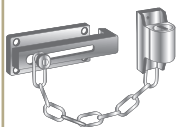

- Size: 2-1/4" x 4-1/4"
- Lock and unlock from the inside and outside
- Key lock with 2 keys included
- 7/box

B

EDV-120-^{Finish}

Door Viewer - 190° 1/2" Medium



- Wide angle clear lens
- Scratch proof lens
- Moist/water proof
- For doors 1-3/8" to 2" thick
- 1/2" barrel diameter
- 10/box

C, PB

EDL-140-^{Finish}

Door Guard - Multi-Purpose Keyed Bolt

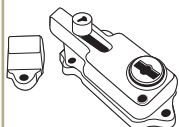

- Use on doors or cabinets
- Option for a flush mount
- 5 wafer cylinder for added security
- Key lock with 2 keys included, Y13 Keyway
- Plated steel
- 10/box

B

EDV-130-^{Finish}

Door Viewer - 160° 1" Large

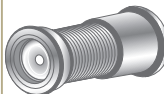

- Super wide view lens
- Scratch proof lens
- Moist/water proof
- For doors 1-3/8" to 2" thick
- 1" barrel diameter
- 10/box

PB

EDL-152-^{Finish}

Door Guard - Security Chain Bolt



- 4" Chain Bolt
- Provides extra strength and security for wood doors
- Ideal for in-swinging or out-swinging double doors, garages, etc.
- 10/box

C

EFL-100-^{Finish}

Privacy Flip Lock



- Size: 2-3/4" x 1-1/2"
- For in-opening doors
- Left or right handed doors
- 10/box

B, W



Need A Custom Product Or Custom Finish? Contact Our Custom Department Today!

AB - ANTIQUE BRASS AL - ALUMINUM B - BRASS C - CHROME DU - DURONODIC PB - POLISHED BRASS PC - PRIME COAT S - STAINLESS STEEL W - WHITE STEEL

*Stock Finishes Are Listed Under Each Part Number. Additional Finishes Are Available Upon Request.

** All Items Display Packaged Unless Noted

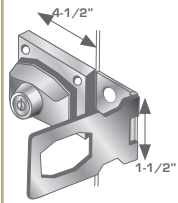

ELK-110- Finish
Hasp Lock - 4-1/2

- Size: 4-1/2" x 1-1/2"
- Use on doors, gates, trunks, or boxes
- Keyed for additional protection
- Available keyed alike or keyed different
- 10/box

Locked Position



C

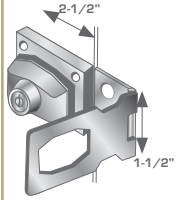

ELK-111- Finish
Hasp Lock - 2-1/2

- Size: 2-1/2" x 1-1/2"
- For in-opening doors
- Left or right handed doors
- Available keyed alike or keyed different
- 10/box

Locked Position



C

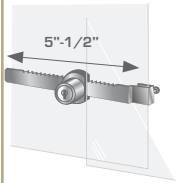

ELK-130- Finish
Showcase Lock

- Locks sliding glass doors
- Keyed lock with 2 keys included
- 25/box

C

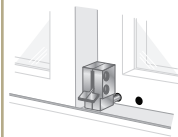

EPL-100- Finish
Patio Door Lock - Lever

- 2" X 5/8"
- Inside and outside sliding doors
- Locks door in fully closed and ventilation position
- 19/box

AL



EPL-101- Finish
Patio Door Lock - Top Knob

- Size: 1-1/2" x 2-1/4"
- Inside and outside sliding doors
- Locks door in fully closed and ventilation position
- 10/box

AL, W

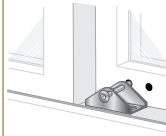

EPL-102- Finish
Patio Door Lock - Pull Pin

- Size: 2" x 1-3/4"
- Inside and outside sliding doors
- Locks door in fully closed and ventilation position
- 10/box

AL

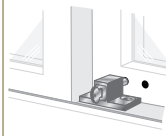

EPL-104- Finish
Patio Door Lock - Keyed

- Size: 1-1/8" x 1-3/4"
- Inside and outside sliding doors
- Locks door in fully closed and ventilation position
- Keyed lock with 2 keys
- 10/box

AL



EPL-105- Finish
Patio Door Lock - Keyed Lever

- Size: 2-1/4" x 2"
- Inside and outside sliding doors
- Locks door in fully closed and ventilation position
- Key lock with 2 keys
- 10/box

AL



EPL-106- Finish
Patio Door Lock - Keyed Large Rectangle

- Size: 6" x 1-1/8"
- Heavy-duty steel bolt
- Use on inside and outside sliding doors
- Key lock with 2 keys
- 10/box

AL, W



EPL-108- Finish
Patio Door Lock - No Key Large Rectangle

- Size: 6" x 1-1/8"
- Heavy-duty steel bolt
- Use on inside and outside sliding doors
- No key required
- 10/box

W



Need A Custom Product Or Custom Finish? Contact Our Custom Department Today!

AB = ANTIQUE BRASS AL = ALUMINUM B = BRASS C = CHROME DU = DURONODIC PB = POLISHED BRASS PC = PRIME COAT S = STAINLESS STEEL W = WHITE

*Stock Finishes Are Listed Under Each Part Number. Additional Finishes Are Available Upon Request. ** All Items Display Packaged Unless Noted



Security Door Hardware

EPL-110- Finish

Patio Door Lock - Pin

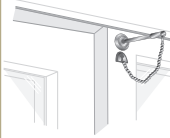

- 3-1/4" length
- Lock and unlock door quickly
- Pin locks in place
- Cut to length
- 10/box

AL

EPL-111- Finish

Patio Door Lock - Side Knob

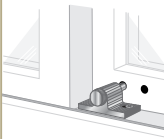

- Size: 2" x 2-1/4"
- Inside and outside sliding doors
- Locks door in fully closed and ventilation position
- 20/box

AL

EWL-100- Finish

Window Lock - Single Wing Nut



- Works on top and bottom tracks
- 1 wing nut
- 10/box

AL

EWL-120- Finish

Window Lock - Lever

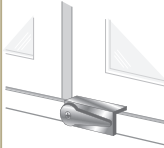

- Easy to use lever
- Works on most sliding windows
- No tools required for installation
- 10/box

AL

EWL-111- Finish

Window Lock - Wood Sash Keyed

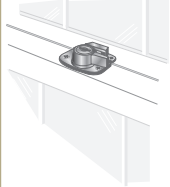

- Key locking prevents breaking the glass and easily unlocking the window
- Locks and unlocks quickly
- 2 keys included
- 10/box

B

EWL-150- Finish

Window Lock - Double Wing Nut

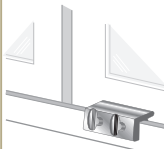

- Works on top and bottom tracks
- 2 wing nuts
- 10/box

AL

Visit **PRO-LOK**.com for more products!

PRO-LOK



KALIFORNIA KEY CHAINS

Full Line of:

- Auto Opening Kits
- Auto Opening Tools
- Auto Opening Lights
- Blue Punch Key Machines
- Door Installation Tools
- Key Decoders
- Key Hooks
- Locksmith Tools
- Lock Picks
- Safe Bits

Full Line of:

- Adaptor Plates
- Door Knobs
- Door Viewers
- Filler Plates
- Hole Covers
- Latch Protectors
- Patio Door Locks
- Strike Plates
- Window Locks
- Wrap Plates

Full Line of:

- Key Identification/Tags
- Coils
- Pull-a-Parts
- C-Clips
- Key Reels/Badge Pulls
- Belt Hooks
- Key Hiding
- Chains/Necklaces
- Lanyards/Wrist Straps
- Split Rings

AB = ANTIQUE BRASS AL = ALUMINUM B = BRASS C = CHROME DU = DURONODIC PB = POLISHED BRASS PC = PRIME COAT S = STAINLESS STEEL W = WHITE

*Stock Finishes Are Listed Under Each Part Number. Additional Finishes Are Available Upon Request. ** All Items Display Packaged Unless Noted

PRO-LOK[®]



Automotive Tools

PRO-LOK®

AK42-MEGA: 13 PC MEGA LONG REACH KIT

This 13 piece updated kit includes everything needed to gain entry into a vehicle. From a variety of car opening tools to lock picks, there is nothing this kit can't do.



Item: AO42-LA **Description:** 58" Long Reach Tool w/ Neon Glow Tip. **Applications:** All* Vehicles
Notes: Unlocks most vehicles, smaller diameter for easy insertion, powder-coated



Item: AO65
Description: Inflatable Ballistic Pump Wedge
Applications: All Vehicles
Size: 6.25" x 13.5" x 1.75"

Notes: Rounded Corners & stiff interior backing for easy insertion



Item: AO68 **Description:** Door Gapper Dual Tool
Applications: All Vehicles



Creates space between the door and the frame to allow for quick insertion of the Pump Wedge to perform Long Reach Car Openings.



Item: AO10 **Description:** Original Slim Jim **Size:** 22.5" x 0.75" x 0.035" **Applications:** Late model vehicles

Item: AO86 **Description:** Lock Lifter Tool



Applications: Vehicles with Vertical Buttons



Item: AO42SL
Description: Door, Paint, Window Defender
Applications: All Vehicles

Item: AO64-A **Description:** Mini Plastic Wedge



Notes: Made from impact resistant plastic with a unique crown for better wedging



Item: AO60 **Description:** Double Sided Wedge



Notes: Made from impact resistant plastic. The varying height design allows for adjustment for different doors



Item: AO67 **Description:** Mini Rubber Wedge



Notes: Made from non-marring high grade rubber



Item: Pick Starter Kit

Description: Includes 3 picks and an 8 page mini instructional book. Picks made from Tempered stainless steel.

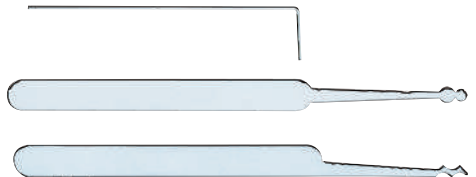

PRO-LOK®

AK42-LA: 58" LONG REACH KIT

This 4 piece 58" Long Reach Tool Kit is designed to enter into the passenger compartment of vehicle through the door using wedges and/or door jack type tools.



Item: AO42-LA **Description:** 58" Long Reach Tool w/ Neon Glow Tip.
Notes: Unlocks most vehicles, smaller diameter for easy insertion, powder-coated

Applications: All* Vehicles



Item: AO65
Description: Inflatable Ballistic Pump Wedge



Applications: All Vehicles

Size: 6.25" x 13.5" x 1.75"

Notes: Rounded Corners & stiff interior backing for easy insertion



Item: AO42SL

Description: Door, Paint, Window Defender

Applications: All Vehicles



Item: AO67

Description: Mini Rubber Wedge

Notes: Made from non-marring high grade rubber

AK42-LAXL: 76" LONG REACH KIT

This 4 piece 76" Long Reach Tool Kit is designed to enter into the passenger compartment of vehicle through the door using wedges and/or door jack type tools.

Item: AO42-LAXL **Description:** 76" Long Reach Tool w/ Neon Glow Tip. **Applications:** All* Vehicles
Notes: Unlocks most vehicles, smaller diameter for easy insertion, powder-coated

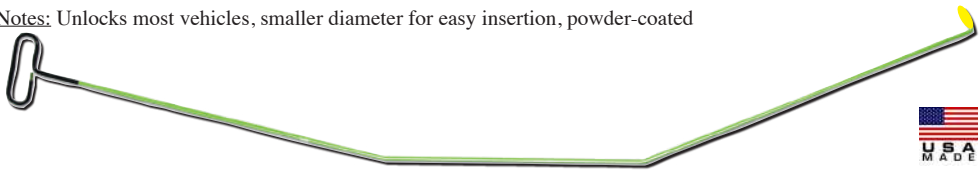

Item: AO65
Description: Inflatable Ballistic Pump Wedge



Applications: All Vehicles

Size: 6.25" x 13.5" x 1.75"

Notes: Rounded Corners & stiff interior backing for easy insertion



Item: AO42SL

Description: Door, Paint, Window Defender

Applications: All Vehicles



Item: AO67

Description: Mini Rubber Wedge

Notes: Made from non-marring high grade rubber

VIEW ALL
TOOL OPTIONS



ONLINE AT
PRO-LOK.com

PRO-LOK[®]

QUICK CHANGE[™] LONG REACH TOOL

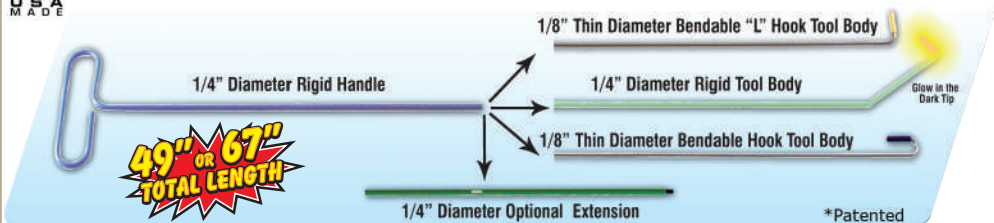

NO COUPLERS

A coupler is commonly used to screw 2 pieces of tool together to make one longer tool. A coupler needs to be made of a considerably thicker diameter than the material making up the two tool pieces. The Pro-Lok design does not use couplers. One half of the tool screws directly into the other half (without a coupler). This feature allows for a smooth and smaller diameter tool. This is a very important feature because you won't have to wedge the door or window wider to allow room for the coupler.

5 PIECE "USER CHOICE"

Our patent pending tool is unlike any other. Different vehicles and opening methods may require or at the very least are easier to perform with the right shape or designed "tool body". Our 1/4" diameter "handle" provides firm and stiff tool control and attaches to your choice of 3 different "tool bodies" and one longer reach "extension". You simply choose the "tool body" that will best suit the vehicle and opening method that you are performing and screw it directly into the handle. In some instances, if you need longer reach from your tool, the 18" extension screws between the "handle" and the "tool body" to make your long reach tool up to 67" long.

COMPACT

You will look very professional with the best compact case available. Not just for easy storage in your truck or car but also providing a custom place for each tool. No searching for lost tools. No tools all tangled together.

EXTRA LENGTH WHEN NEEDED

Some vehicles require extra length in your long reach tool. Reaching the locking button, reaching the console or across the car is impossible with some tools. The Pro-Lok Quick Change[™] Long Reach tool provides you the best of both worlds. The shorter long reach tool (just the handle and body) is used for most openings. It provides you with better control and use of the tool. When you are faced with a vehicle that requires a little more length, simply screw the 18" "extension" between the "handle" and the "body".

GLOW IN THE DARK TIP

The rubber protective tip on PRO-LOK's 1/4" tool body is made of a specialty formulated glow in the dark material. This feature comes in handy on some openings at night. You can easily see the tip of the tool guiding it inside the vehicle while pushing or pulling the desired unlocking feature.

Quick Changing to your Needs

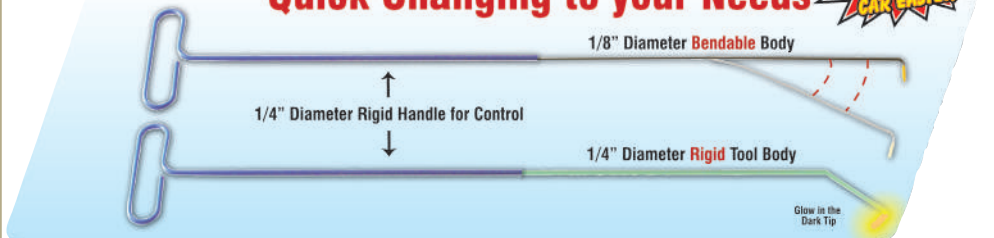

PRO-LOK®

AKUC: 18 PIECE ULTRA COMBO KIT

The 18 Piece Ultra Combo Car Opening Kit is a mix of the most popular traditional car opening tools strategically fit into the lid of the case as well as an assortment of 5 “Quick Change” Long Reach Tools custom fit into the bottom of the specialty molded case. Simply choose the “Tool Body” that best suits the vehicle opening method. Screw the chosen “Tool Body” directly into the handle for a seamless design. The 1/4” tools body comes with a glow in the dark tip for easy openings at night.

Base includes: 5pc Long Reach Tool • Pump Wedge • 2 Rubber Wedges • 2 Plastic Wedges • Protective Tool Sleeve
Lid includes: Slim Jim • 2 Linkage Tools • Under-the-Window Tool • Wedge Starter • 2 Instructional Booklets



AKUL: 12 PIECE ULTRA LONG REACH KIT

The 12 Piece Ultra Long Reach Car Opening Kit is a mix of the most popular traditional car opening tools strategically fit into the lid of the case as well as an assortment of 5 “Quick Change” Long Reach Tools custom fit into the bottom of the specialty molded case. Simply choose the “Tool Body” that best suits the vehicle opening method. Screw the chosen “Tool Body” directly into the handle for a seamless design. The 1/4” tools body comes with a glow in the dark tip for easy openings at night.

Base includes: 5pc Long Reach Tool • Pump Wedge • 2 Rubber Wedges • 2 Plastic Wedges • Protective Tool Sleeve
Lid includes: 2 Instructional Booklets



PRO-LOK®

A042-LA: 58" LONG REACH TOOL

The versatile 58" in. Long Arm Car Opening Tool is designed to enter into the passenger compartment of the vehicle through the door using wedges and/or door jack type tools. The soft vinyl Bright Glow Yellow Tip allows for easy lock manipulation.



A042-LAXL: 76" LONG REACH TOOL

The versatile 76" in. Long Arm Car Opening Tool is designed to enter into the passenger compartment of the vehicle through the door using wedges and/or door jack type tools. The soft vinyl Bright Glow Yellow Tip allows for easy lock manipulation.

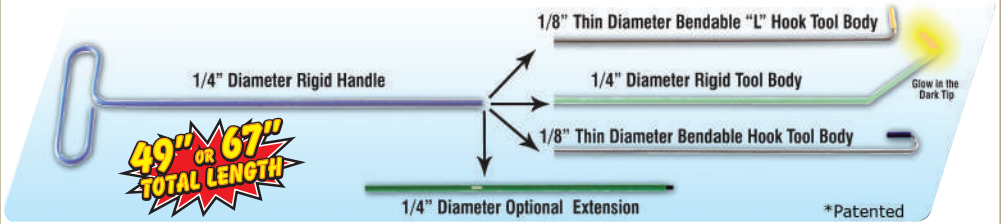

A042-QC1: QUICK CHANGE LONG REACH TOOL

The 3 Piece Quick Change Long Reach Tool is designed to unlock many vehicles through the passenger door using wedges and/or door jack type tools. Features a specialty formulated Glow-in-the-Dark tip and 18" in. extension arm which may be mounted between the rigid 'handle' and 'tool body' without using a bulky coupler.



A042-QC2: QUICK CHANGE LONG REACH ACCESSORY

The 2 Piece Quick Change Long Reach Accessory Tools features a thin diameter body which screw directly into the A042-QC1 'handle' or 18" in. extension without the use of a bulky coupler. The thinner material may provide less wedging or stress on the vehicle while still easily bending to pull or push on the desired unlocking feature.



A042SL: LONG REACH TOOL SLEEVE

Use the Long Reach Tool Sleeve to protect the glass, weather stripping, paint, and edge of the door from tools while performing an auto opening. The Long Reach tool is fed through the sleeve to avoid contact with the vehicle



A085: EURO STRIP TOOL

The flexible design allows technicians to bypass doors on foreign and domestic vehicles and attack vertical buttons. Machine cutout with a heavy duty rubber band for extra strength. Full Color Instructions included.



PRO-LOK®

A086: LOCK LIFTER TOOL



Use the Long Reach Tool Sleeve to protect the glass, weather stripping, paint, and edge of the door from tools while performing an auto opening. The Long Reach tool is fed through the sleeve to avoid contact with the vehicle



A068: DOOR GAPPER DUAL TOOL

The double sided Door Gapper Dual Tool makes Auto Entry easy! This tool helps create space between the door and the frame to allow for quick insertion of the Pump Wedge to perform Long Reach Car Openings.

- Door Jack Tool on one end, Wedge on the other
- Easily creates a gap for Long Reach Tool
- Soft rubber bumper for extra protection



A065: PUMP WEDGE

The Pump Wedge is a unique and versatile tool for expanding openings to unlock vehicles. The inflatable wedge made of non-marring ballistic material and has rounded corners for easy entry. Includes a stiff interior for extra strength and easier insertion.



Lifetime Warranty from manufacturer's defect.

Size: 6.25" W x 5.5" L



A065-VXL: XL PUMP WEDGE

The Extra Large Pump Wedge is a larger version of the popular A065 Pump Wedge. Made of non-marring ballistic material and has rounded corners for easy entry. Includes a stiff interior for extra strength and easier insertion.



Size: 9.0" W x 6.93" L

Lifetime Warranty from manufacturer's defect.



AL6000: PROGLO SUCTION LIGHT

The Pro-Glo Hands-Free light uses a suction cup to rest on the exterior of vehicle's windshield, illuminating the desired work area so the entry technician can see to manipulate the interior locking mechanisms. A great accessory to any Long Reach Tool, the Pro-Glo features 6 powerful and uniquely angled LCD lights to throw light on specific area of the vehicle's interior.



PRO-LOK®

A060: DOUBLE SIDED WEDGE



Made of high impact plastic to assist in expanding opening in order to unlocking vehicles. The varying height design on each side (1/2" and 3/4") allows technicians to adjust to doors with varying flexibility.



Full Color Instruction Included

A064: MINI WEDGE DUO



The Mini Duo Orange Wedge with a unique crown makes expanding even tight doors easy. Includes a set of two (2) wedges.

Size: 4.5" x 1" x 1"

Full Color Instruction Included



A061: GRAY RUBBER WEDGE



The Grey Rubber Wedge is made from heavy-duty non-marking high grade rubber to assist in expanding openings in order to unlock vehicles

Size: 4.75" x 2" x 1-3/8"

Full Color Instruction Included



A067: MINI RUBBER WEDGE



The Grey Rubber Wedge is made from heavy-duty non-marking high grade rubber to assist in expanding openings in order to unlock vehicles

Size: 4.75" x 1" x 1-3/8"

Full Color Instruction Included



LT216: STRAMER REMOVER TOOL



The Stramer Remover Tool removes the steering column lock plate retainer ring on GM "Square Column" vehicles.



LT410: CLIP ZIP DOOR PANEL TOOL



This quick and easy to use tool slides down the door frame to remove the panel clips and separate it from the door body without damage to the panel or clip.



LT413: FLAT DOOR PANEL TOOL



This is a "spatula" style door clip remover. The tool slips around the base of the door clip, between the car door panel and the steel door, to carefully pry the door panel clip free from the door.



LT450: FACE CAP REMOVAL PLIERS



The versatile Face Cap Removal Pliers safely and easily removes face caps from domestic and foreign auto locks.



LT460: WINDOW CRANK TOOL

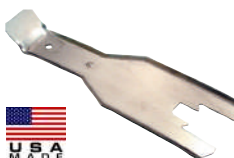

The Window Crank Tool slips behind the window crank and removes the spring clip making manual window crank removal easy and risk-free.



LT740: FACE CAP CLINCHER TOOL



The Face Cap Clincher Tool quickly and easily crimps the tabs on replacement auto lock caps of foreign and domestic vehicles.



VIEW ALL
TOOL OPTIONS



ONLINE AT
PRO-LOK.com

PRO-LOK®

A001: SLIDE LOCK TOOL

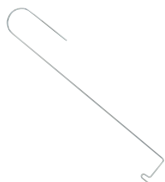

Actually two (2) tools in one. The Slide Lock tool opens foreign and domestic vehicles with both horizontal locking devices and vertical buttons.



A014: WINDOW VENT SET



The 2 pc Vent Window Set allows you to vent windows on cars, trucks, and van doors.



A027: HANDLE OPENER TOOL



Designed to access and manipulate pull handles on vehicles that have stiffer handle springs such as certain BMW, Mercedes and Land Rovers.



A031: BUTTON LIFTER TOOL



Designed to reach under windows to unlock vehicles with raised vertical buttons. Simply remove the protective cap and use the precision ground tip.



A034: NARROW TOOL



The Narrow tool is designed to go under the window and inside the car to unlock the door.



A036: LONG TOOL



Designed to stretch under the window of a variety of vehicle types for hard to reach activators.



VIEW ALL TOOL OPTIONS



ONLINE AT **PRO-LOK.com**

A024: HANDLE OPENER TOOL



Designed to access and manipulate closed pull handles on vehicles that have stiff handle springs or which require higher pull strength.



A028: FAT TOOL



The Fat Multi-Car Opening Tool is designed to bypass window regulators that run the length of the window glass.



A032: WIDE EXTRA LONG TOOL

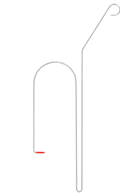

Designed to have a wide reach and extra long length for use on multiple cars with locking mechanisms that were just out of your reach.



A035: WIDE TOOL

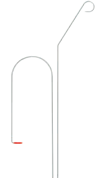

The Wide Tool is designed to access a variety of vehicle types with wide door panels.



A039: DOUBLE SLIDE TOOL

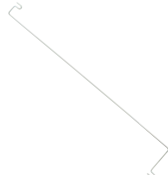

The Double Slide Tool is a multi-functional tool with a short reach for narrow doors and a reverse tip for reaching under horizontal linkage.



VIEW ALL
TOOL OPTIONS



ONLINE AT
PRO-LOK.com

A045: LOOP-D-LOOP TOOL

Fed in under the window, the 'loop' is fixed around the straight or mushroom style button head and pulled tight, then lifted up to unlock. The heavy duty coated wire is securely crimped.



A095: TOOL USAGE INSTRUCTION

The 52 page Tool Usage and Instruction Booklet is a great resource for understanding different auto locking systems and how to use our tools for car openings. Keep on hand for most car opening situations.



A010: THE ORIGINAL SLIM JIM

The Original Slim Jim is still the best for opening cars. The Slim Jim design unlocks a variety of foreign and domestic vehicles. Made of stainless steel. Full Color Instructions included. Lifetime warranty from manufacturer's defect.

Size: 3/4" x 22 1/2" x .032" thick.



A011: SUPER SLIM JIM

The Super Slim Jim is wider and thicker than the Original Slim Jim. Designed to unlock many foreign and domestic vehicles. Made of stainless steel. Full Color Instructions included. Lifetime warranty from manufacturer's defect.

Size: 1 1/4 x 25" x .032" thick.



A025: EZ SLIM JIM

The E-Z Jim is a medium thickness Slim Jim designed to unlock a wide variety of foreign and domestic vehicles. Made of stainless steel. Full Color Instructions included. Lifetime warranty from manufacturer's defect.

Size: 1" x 25" x .042" thick.



A030: EXTRA LONG SLIM JIM

The 30" in. Extra Long Slim Jim is like the Original Slim Jim, but designed to reach even the deepest linkage. Made of stainless steel. Full Color Instructions included. Lifetime warranty from manufacturer's defect.

Size: 3/4" x 29 1/2" x .032" thick.



PRO-LOK[®]



Lock Picking Tools

Picks with Handles

PKX-DB-H

Double Ball Pick with Handle



PKX-DM-H

Double Ball Mountain with Handle



PKX-HDL-H

Large 1/2 Diamond with Handle



PKX-HDS-H

Small 1/2 Diamond with Handle



PKX-KE-H

Key Extractor with Handle



PKX-LC-H

Large Comb with Handle



PKX-LH-H

Large Hook with Handle



PKX-MH-H

Medium Hook with Handle



PKX-SB-H

Small Ball with Handle



PKX-SC-H

Small Comb with Handle



PKX-TR-H

Traditional Rake with Handle



Picks without Handles

PKX-DB-P

Double Ball Pick - Plain



PKX-DM-P

Double Ball Mountain - Plain



PKX-HDL-P

Large 1/2 Diamond - Plain



PKX-HDS-P

Small 1/2 Diamond - Plain



PKX-KE-P

Key Extractor - Plain



PKX-LC-P

Large Comb - Plain



PKX-LH-P

Large Hook - Plain



PKX-MH-P

Medium Hook - Plain



PKX-SB-P

Small Ball - Plain



PKX-SC-P

Small Comb - Plain



PKX-TR-P

Traditional Rake - Plain



MISC. PICKS AND TENSION WRENCHES

PKX-TW-F

Forked Tension Wrench



PKX-TW-L Light Tension

PKX-TW-M Medium Tension



PKX-TW-R

Rigid Tension Wrench



PKX-TW-TL Long Twist Tension

PKX-TW-TS Short Twist Tension



PKX-DR-C

Diamond Comb Rake



PKX-HR-C

Comb Hook / Rake



PRO-LOK®

PKX-11: 11 Picks and Case Set

Includes 3 picks with stainless steel handles, 3 standard picks, a double ended slim line pick, broken key extractor, and 3 tension wrenches in a soft leather snap case.



PKX-14: 14 Picks and Case Set

Includes 9 picks and a broken key extractor all manufactured of tempered stainless steel and with rivetless stainless steel handles. Includes 4 tension wrenches in a soft leather snap case.



PKX-20: 20 Picks and Case Set

Includes 14 assorted picks (6 with rivetless stainless steel handles), a broken key extractor and 5 tension wrenches in a soft leather zip case.



PKX-32: 32 Picks and Case Set

Includes a variety of tempered stainless steel hooks, rakes, balls, diamonds, key extractors, and tension wrenches in a soft leather zip case.



PKX-62: 62 Picks and Case Set

This is the complete pick set. Open the quality zippered leather case and you will find the finest lock picks made. The PKX-62 includes an array of hooks, diamonds, balls, rakes, broken key extractors manufactured from tempered stainless steel and featuring our rivetless stainless steel handles that provide maximum picking comfort, six tension wrenches, and our PKX-WP5 wardered pick set.

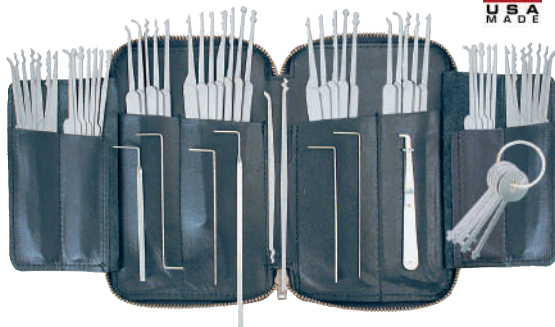

MAEZ2 EZ Picking Manual

Packed with full color cut-away illustrations and detailed instructions. Clearly written making it easy to understand the science of lock picking. More than 100 pages of the best information ever written on the subject of lock picking.

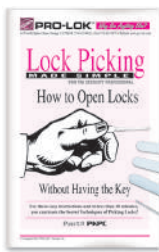

PKX-BOOKLET Picking Basics

Basic picking instructions for the beginner. Fully illustrated and includes 3 picks and 1 tension wrench.



PRO-LOK®

PKA2 Deluxe Ace Pick

For 7 pin tubular locks, picks left hand, right hand, and center allowing locks to be picked by 2 methods (each pin individually or all at once). Includes its own decoder. Manufactured out of aluminum and 12L14 steel featuring 1095 carbon spring steel picks. Glossy black anodized finish. Packaged in a custom wood box.



VIEW ALL TOOL OPTIONS



ONLINE AT **PRO-LOK**.com

PKX-A1 7-Pin Ace Pick

Precision tool designed to easily open any standard 7-pin center Ace type lock. Set tension, insert, and rotate back and forth until the cylinder turns. Features a hard steel body, smooth sliding picking needles, knurled brass handles, & vinyl sleeves. Decoder included.



PKX-GUN-M Manual Pick Gun

Used by professions everywhere, the pick gun allows you to pick quickly. Includes 3 tips and a tension wrench. Limited lifetime warranty.

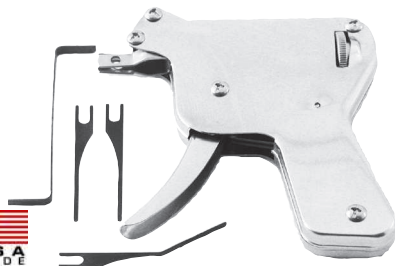

PKX-A3 8-Pin Ace Pick

Precision tool designed to easily open any standard 8-pin center Ace type lock. Set tension, insert, and rotate back and forth until the cylinder turns. Features a hard steel body, smooth sliding picking needles, knurled brass handles, & vinyl sleeves. Decoder included.



PKPS Padlock Shim Pick Set

Designed to use on both combination and key operated padlocks. 20 piece set. 4 sizes, 5 each.

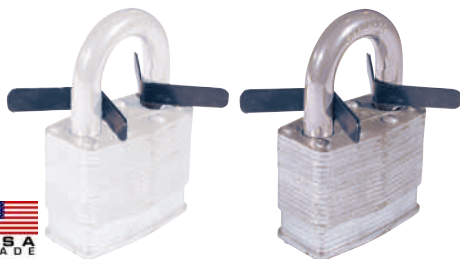

PKX-WP5 Warded Padlock Set

5 Piece pick set includes 5 stainless steel lock picks for common warded padlocks.



PKXGUN-RP Pick Gun Replacement Picks

Replacement picks for pick guns.

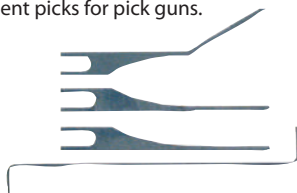

PRO-LOK™

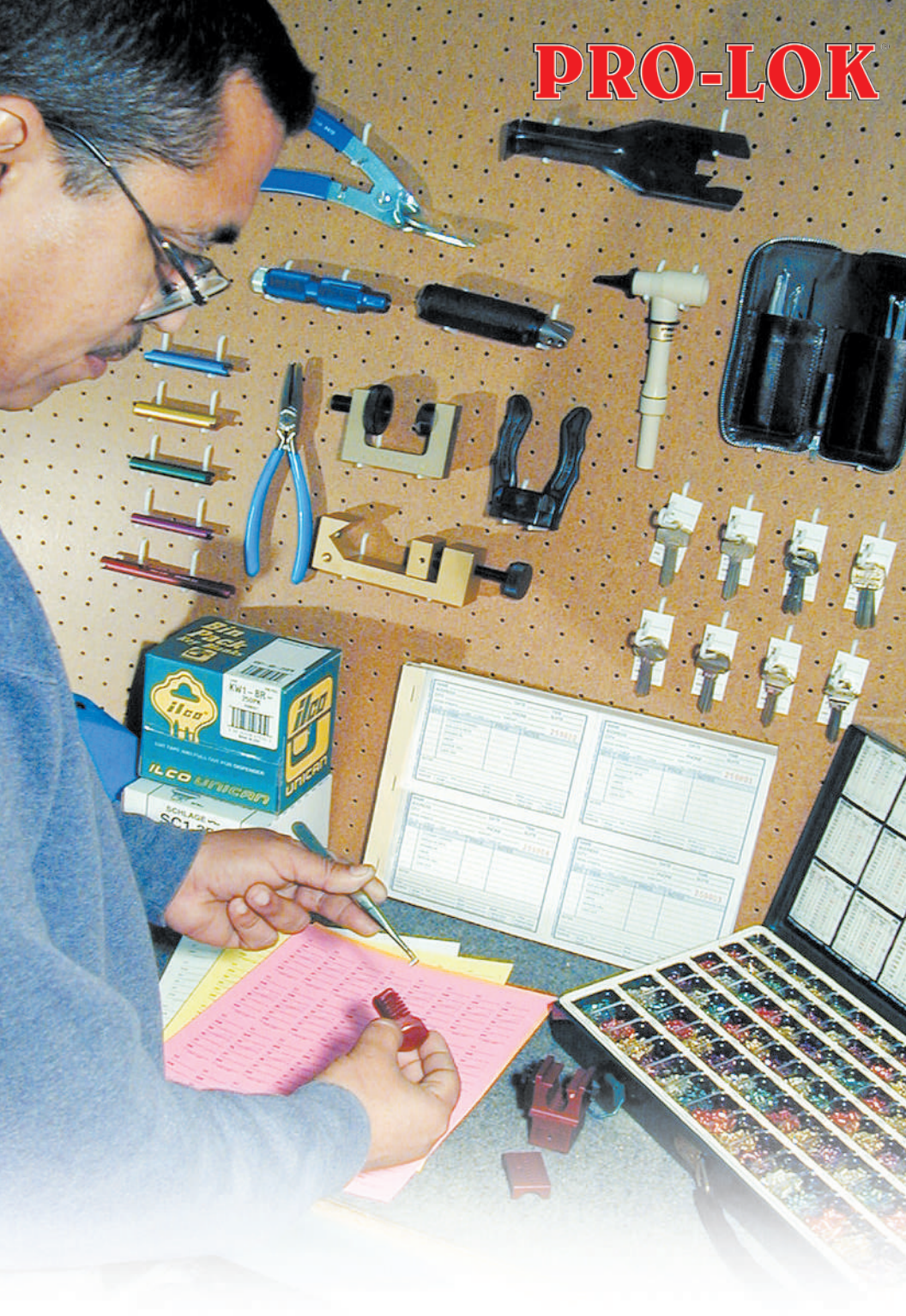

Lock Tools

PRO-LOK[®]

HARDPLATE DRILL BITS



For security we do not show the proper drill point.

- Designed For Safes & Drilling Difficult Material Such As Concrete & Stainless Steel.
- Tungsten Carbide With Diamond Ground Tips.
- Unique Negative Rake Angle & Shortened Chisel Edge That Increases Effectiveness & Reduces Tip Failure.
- Hardened Shanks.
- Fast Starting & Faster Cutting.

SB01: 3/16" X 3-1/2"

SB02: 3/16" X 6"

SB05: 1/4" X 4"

SB06: 1/4" X 6"

SB11: 5/16" X 5"

SB12: 5/16" X 8"

SB15: 3/8" X 5"

SB16: 3/8" X 8"

SB17: 3/8" X 12"

SB20: 1/2" X 6"

SB21: 1/2" X 12"

Featuring



Diamond
Ground Tips

** Items are not to scale, please refer to the listed dimensions **

PRO-LOK®



KD01

Key Decoder

Decoder for Kwikset, Schlage, Weiser, and Weslock.

Made from Stainless Steel



KEY HOOKS

Keys won't fall off of these hooks! Pliable, durable, colorful no-spill key hooks. Unique design securely holds 25-30 blanks per hook and won't allow the blanks to come off until needed. The special formula material eliminates breaking and drooping. Use with the Key Tag System below for the ultimate key board organization. 100 hooks per bag. Fits 1/8" pegboard.

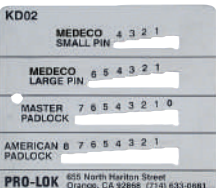

KD02

KD02

Key Decoder

Decoder for Medeco Small Pin, Medeco Large Pin, Master Padlock, and American Padlock.

Made from Stainless Steel

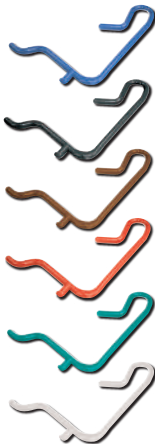

KHBL

Blue Key Hooks

KHBLK

Black Key Hooks

KHBR

Brown Key Hooks

KHRE

Red Key Hooks

KHTE

Teal Key Hooks

KHWH

White Key Hooks

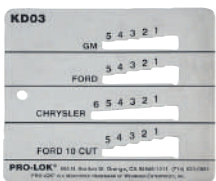

KD03

KD03

Key Decoder

Decoder for GM, Ford, Chrysler, and Ford 10 Cut.

Made from Stainless Steel



KD98

KD98

Key Decoder

Decoder for ASSA.

Made from Stainless Steel



LT420

Domestic Key Tag System

Organize residential & commercial keys on your board. Used behind key hooks. Set contains more than 1000 tags. Lists blank manufacturer & part number for reordering blanks.



KDIC

KDIC

Key Decoder

Decoder for Best/Falcon and other I/C/ keys using standard A2 increments.

Made from Stainless Steel



LT422

Blank (White) Key Tag System

Make your own key tags that go behind the hooks on your keyboard. Set contains 96 blank tags. Use the template online to input your blanks.



KDKW

KDKW

Key Decoder

Decoder for Kwikset.

Made from Stainless Steel

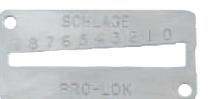

KDSC

KDSC

Key Decoder

Decoder for all Schlage and other (Schlage type) keys using factory increments.

Made from Stainless Steel



LT423

Fluorescent Blank Key Tag System

Make your own key tags that go behind the hooks on your keyboard. 3 fluorescent colors: pink, orange, and yellow to help find popular blanks. Set contains 96 blank tags.



PRO-LOK[®]

LT300

KeyCheck™ Key Blank ID



An Ideal tool to train on key blank identification. Forms & holds the keyway on any sample key and allows you to match the right blank every time.



LT340

IC Rekey / Decode / Dump Tool

Several tools in one. Clear chambers and decode. Chamber cap and retainer sleeve staking feature. Holds the key cylinder and provides a place to dump the pins for decoding or disposal. Also acts as a holding fixture for rekeying.

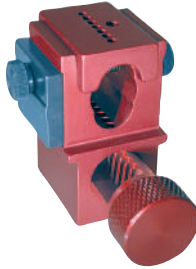

LT341

IC Rekeying Ejector Pin



LT342

IC Rekeying Staking Tool



LT350

Single Plug Holder

The single plug holder will accommodate all Schlage full size plugs, including Primus plugs with side bars. The holder has 2 grooves for the side bar in Primus plugs, so any plug may be inserted from either end of the holder. Making it easy to insert pins into plug.



LT350-12

Multiple Plug Holder

Will accommodate up to 12 plugs with sidebars.



LT470 8 pc Tool Set in Case

Heat-treated, chrome-plated tools vanadium steel shafts with magnetic tips and high visibility handles.

Includes curved hook, offset 45° hook, 90° hook, straight pick, 1/8" flat driver, #0 Phillips driver, SD-15 star driver, SD-20 star driver.



LT500 Rhodes Nut Tool

Aluminum tool replaces plastic nut driver that comes with the Rhodes locks. Durable and easy to handle. Ideal for high volume retrofit jobs. Saves valuable time.



LT605 The DiskBuster™

Clamps onto most brands of disk/circular type padlocks and automatically centers the shear line for quick drilling. Prevents the possibility of drilling your hand.



LT9505 Fire Cabinet Lock

Self contained trip lever cylinder lock assembly fits glass fire cabinet doors. Keyed alike to LL24.



PRO-LOK®

LT1202 Lock & Safe Scope

Provides a strong beam of light for safe work or reading wafers. Made of impact-resistant plastic and includes three (3) magnification tips, carrying case, batteries and bulb.



LT1202B Bulb

Replacement bulb for LT1202

LT370 Master Pin Follower

A versatile tool to be used for removal of upper chamber master pins (up to .100) with a quick twist. May also be used for standard rekeying tasks.

Made from machined aluminum to exacting tolerances with an anodized finish.



LT371 4 Piece Follower Set

Includes LT371-395, LT371-495, LT371-500, LT371-555



LT371-395 .395 Diameter
For removal of most small pin tumblers.

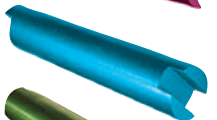

LT371-495 .495 Diameter
Standard follower with two different end configurations.



LT371-500 .500 Diameter
For standard rim cylinders. 2 different end configurations



LT371-555 .555 Diameter
Standard follower with two different end configurations.



LT700 Standard Impressioning Tool

Ideal for pin tumbler and wafer locks using a true center-line action. Easy-to-grip handle fits hands comfortably, securely holds the head of the key.



LT1202 Headspecs

1.8x, 2.3x, 3.7x, and 4.8x magnification glasses with dual light sources and head harness with 2 lights. Ideal for detail work, close observations, precise inspections, and more!



(2) AAA batteries per light.
(Batteries not included)

LT374 Pin Tweezers

Ideal for pinning locks. Designed with a special notch to hold the pin.



LT430 Service Call Dispatch Book

Makes it easy to track service calls for dispatch and billing.

The book features 200 individually numbered tickets with 3-copy NCR paper allowing one copy to dispatcher, one to service technician, and retain a permanent copy in the book for easy record keeping.



LT705 Tubular Impressioning Tool

Aluminum impressioning tool for 7-pin center tubular locks. Made from corrosion resistant aluminum alloy with an anodized finish.

Use with the Tubular Impressioning File (LT705F).



LT705F

LT800 Door Latch Opening Shim Set

Set of 5 door latch shims makes it easy to open the door. Strong and flexible material with rounded corners makes it easy to reach and manipulate the latch

PRO-LOK
Item: LT800
Door Latch Shim



VIEW ALL TOOL OPTIONS



ONLINE AT **PRO-LOK.com**

VIEW THE FULL PRODUCT LINE.



Visit **PRO-LOK.com** for more products!

PRO-LOK®

Full Line of:

- Auto Opening Kits
- Auto Opening Tools
- Auto Opening Lights
- Blue Punch Key Machines
- Door Installation Tools
- Key Decoders
- Key Hooks
- Locksmith Tools
- Lock Picks
- Safe Bits



Full Line of:

- Adaptor Plates
- Door Knobs
- Door Viewers
- Filler Plates
- Hole Covers
- Latch Protectors
- Patio Door Locks
- Strike Plates
- Window Locks
- Wrap Plates

KALIFORNIA KEY CHAINS

Full Line of:

- Key Identification/Tags
- Coils
- Pull-a-Parts
- C-Clips
- Key Reels/Badge Pulls
- Belt Hooks
- Key Hiding
- Chains/Necklaces
- Lanyards/Wrist Straps
- Split Rings

KALIFORNIA KEY CHAINS

Powered by
PRO-LOK

 **BETTER
VARIETY**

 **BETTER
QUALITY**

 **BETTER
PRICING**

Cards



Multi-Cards



Bulk



Drums



KaliforniaKeyChains.com

Key Identifiers (Standard Colors)

Color code keys for quick and easy ID. Soft rubber fits onto the head of existing keys. **6** Key Identifiers per card. **Assorted colors.**



K100
6/Card

K100-B
200/Bulk

K100-D
200/Drum

Key Identifiers (Neon Colors)

Color code keys for quick and easy ID. Soft rubber fits onto the head of existing keys. **6** Key Identifiers per card. **Assorted colors.**



K101
6/Card

K101-B
200/Bulk

K101-D
200/Drum

Key Identifiers (Solid Cover)

Color code keys for quick and easy ID. Soft rubber fits onto the head of existing keys. **6** Key Identifiers per card **Assorted colors.**



K102
6/Card

K102-B
200/Bulk

K102-D
200/Drum

Key Identifiers (Large Size)

Color code keys for quick and easy ID. Soft rubber fits onto the head of existing keys. **4** Key Identifiers per card **Assorted colors.**



K103
4/Card

K103-B
200/Bulk

K103-D
200/Drum

Key Identifiers (Sports Caps)

Color code keys for quick and easy ID. Fits most standard size key heads. **6** Key Identifiers per card



K104
6/Card

K104-B
200/Bulk

K104-D
200/Drum

Key Identifiers (Happy Face Caps)

Color code keys for quick and easy ID. **6** Key Identifiers per card. **Assorted colors.**



K105
6/Card

K105-B
200/Bulk

K105-D
200/Drum

Soft Wrist Coil

The soft coil fits comfortably on the wrist. Coil is approximately 2-1/2" in diameter and stretches to a diameter of 15". **Assorted colors.**

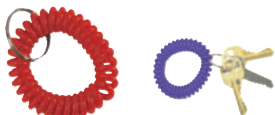

K200
1/Card

K200-B
12/Bulk

K200-C
12/Multi-Card

K200-D
50/Drum

Trigger Snap Coil

The nickel plated Trigger Snap quickly and easily attaches to a belt loop or purse strap. Coil is approximately 5" and stretches to 42". **Assorted colors.**



K201
1/Card

K201-B
12/Bulk

K201-C
12/Multi-Card

Wrist Coil & Whistle

Have the added security of a whistle to use when attention is needed. Coil is 2-1/2" in diameter and stretches 15". **Assorted colors.**



K202
1/Card

K202-B
12/Bulk

Wrist Coil & Badge Holder

ID badge & keys are always together and easy to carry. Coil is 2-1/2" in diameter and stretches to diameter of 15". **Assorted colors.**



K203
1/Card

K203-B
12/Bulk

Casino- Jogger Coil

Plastic Snap quickly and easily attaches to belt loop or purse strap. Coil is 5-1/2" and stretches to 48". **Assortment of colors.**



K808
6/Card

K208-B
200/Bulk

K208-D
200/Drum



K200-C
12/Multi-Card



K200-D
50/Drum

Pull-A-Part (Nickel Plated)

Quickly separate personal keys from office keys, allowing you to give the valet only the keys needed. Nickel Plated finish.

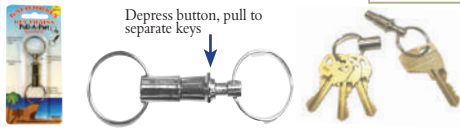

K210
1/Card

K210-C
12/Multi-Card

Pull-A-Part (Transparent Color)

Quickly separate personal keys from office keys, allowing you to give the valet only the keys needed. Assorted of colors.

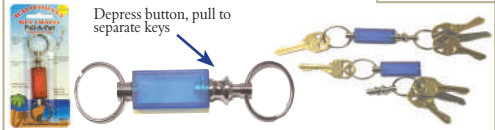

K211
1/Card

K211-C
12/Multi-Card

Pull-A-Part Deluxe (Brushed Silver)

Quickly separate personal keys from office keys, allowing you to give the valet only the keys needed. Brushed silver finish.



K212
1/Card

K212-C
12/Multi-Card

Small C-Clip (Screw Locked)

Keys will not accidentally fall off this key ring which features a screw locking mechanism. Assorted colors.

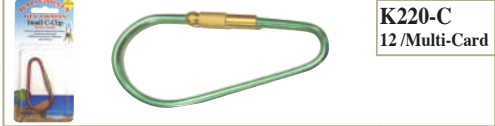

K220
1/Card

K220-B
12/Bulk

K220-C
12/Multi-Card

X-Large C-Clip (Screw Locked)

Keys will not accidentally fall off this key ring which features a screw locking mechanism. Assorted colors.



K221
1/Card

K221-B
12/Bulk

K221-C
12/Multi-Card

Small C-Clip (Spring Loaded)

Perfect to quickly hang or attach your keys to belt loops, purse strap or other convenient place. Assorted colors.



K222
1/Card

K222-B
12/Bulk

K222-C
12/Multi-Card

Large C-Clip (Spring Loaded)

Perfect to quickly hang or attach your keys to belt loops, purse strap or other convenient place. Assorted colors.



K223
1/Card

K223-B
12/Bulk

K223-C
12/Multi-Card

Silver Key Reel

Keys are conveniently pulled 24" and quickly retracted back inside of the reel. Tempered clip easily slides onto a belt or pants.



K230
1/Card

K230-C
12/Bulk

Black Key Reel

Keys are conveniently pulled 24" and quickly retracted back inside of the reel. Tempered clip easily slides onto a belt or pants.



K235
1/Card

K235-C
12/Bulk

ID Badge Mini Reel (Snap On)

Snap-on badge holder is attached to a retractable 19" cord. Convenient clip on the back to attach to shirt, belt or purse.



K240
1/Card

K240-B
36/Bulk

K240-D
36/Drum

ID Badge Mini Reel (Key Ring)

Split key ring holder is attached to a retractable 19" cord. Convenient clip on the back to attach to shirt, belt or purse.



K241
1/Card

K241-B
36/Bulk

K241-D
36/Drum

Slide-On Belt

Your belt slides through the nickel plated carrier. The key ring is secure and cannot be lost from the carrier.



K250
1/Card

K250-B
12/Bulk

K250-C
12/Multi-Card



K223-C
12 /Multi-Card



K223
1 /Card

Clip-On Belt

This nickel plated carrier clips onto a belt, pants or strap. The key ring is secure and cannot be lost from the carrier.



K251
1 /Card

K251-B
12 /Bulk

K251-C
12 /Multi-Card

"S" Belt hook

This nickel plated key ring easily slides onto your belt or pants. Securely holding your keys in place until you need them.



K252
1 /Card

K252-B
12 /Bulk

K252-C
12 /Multi-Card

Slip-On Belt Hook

The key ring is easily removed from the nickel plated clip without removing the strap from your belt.



K254
1 /Card

K254-B
12 /Bulk

K254-C
12 /Multi-Card

Large Snap Clip

Snap clip will quickly attach to many things. Key ring is secure to the solid ring and will not fall off. Full 360 degree rotating swivel.



K261
1 /Card

K261-C
12 /Multi-Card

Small Snap Clip

Snap clip will quickly attach to many things. Key ring is secure to ring and will not fall off. Full 360 degree rotating swivel. Chrome Plated.



K262
1 /Card

K262-C
12 /Multi-Card

Trigger Snap Clip

Snap clip will quickly attach to many things. Key ring is secure to the solid ring and will not fall off. Full 360 degree rotating swivel.



K263
1 /Card

K263-C
12 /Multi-Card

Double-Ended Snap

This snap clip will quickly attach to many things including a belt loop or purse strap. Chrome Plated.



K264
1 /Card

K264-C
12 /Multi-Card

Casino- Jogger Coil

Plastic Snap quickly and easily attaches to belt loop or purse strap. Coil is 5-1/2" and stretches to 48". Assorted of colors.



K266
1 /Card

K266-B
12 /Bulk

K266-D
12 /Multi-Card

Wrist Coil & Badge Holder

ID badge & keys are always together and easy to carry. Coil is 2-1/2" in diameter and stretches to diameter of 15". Assorted colors.



K267
1 /Card

K265-B
100 /Bulk

K267-C
12 /Multi-Card

K267-D
100 /Drum

Magnetic Key Case

Weather resistant key case is great to 'hide' an extra key. Works great for autos, boats, houses.



K270
1 /Card

K270-B
12 /Bulk

K270-R
24 /Board

Jumbo Magnetic Key Case

Weather resistant key case is great to 'hide' an extra key. Simply, place the case against or on a flat metal object out of sight.



K271
1 /Card

K271-B
12 /Bulk

K271-R
12 /Board

Key & Cash Pouch

Place keys/cash inside weather resistant case and store out of sight with the adhesive velcro backing.



Front Side

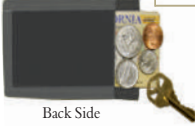

Back Side

K272
1/Card

K272-B
12/Bulk

Rock-Key-Hider

Hide the Rock outside someplace out of sight and where it blends in unnoticeable to store an extra key.



K273
1/Card

30" Beaded Chain

Place key or pendant on the chain and place over head.

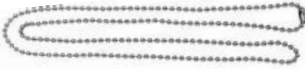

K280
1/Card

K280-C
12/Multi-Card

4" Dog Tag Key Chain

Quality dog tag can be engraved with ID or a special message. Keys can also be attached.



K281
1/Card

K281-C
12/Multi-Card

24" Dog Tag Neck Chain

Quality dog tag can be engraved with ID or a special message. Keys can also be attached.

Assorted Colors.



K282
1/Card

K282-C
12/Multi-Card

Trigger Snap Chain

Quickly attach to belt loop, purse strap or wallet and always have your keys secure and ready to use.



K283
1/Card

K283-C
12/Multi-Card

Pocket Chain

Quickly attach to belt loop, purse strap or wallet and always have your keys secure and ready to use.



K284
1/Card

K284-C
12/Multi-Card

36" Neck Lanyard (Standard Colors)

Hang keys, whistle or name badge on the 1-1/4" split key ring with 360 degree swivel.

Assorted Colors.



K290
1/Card

K290-C
12/Multi-Card

36" Neck Lanyard (Neon Colors)

Hang keys, whistle or name badge on the 1-1/4" split key ring w/ 360° swivel comfortably around the neck.

Assorted Colors.



K291
1/Card

K291-C
12/Multi-Card

36" Neck Lanyard (3/8" Wide)

Hang keys, whistle or name badge on the 1-1/4" split key ring w/ 360° swivel comfortably around the neck.

Assorted Colors.



K292
1/Card

K292-C
12/Multi-Card

Whistle Lanyard

36" lanyard featuring a 1-1/4" split key ring with 360 degree swivel. Great for safety, personal use, or coaches.



K293
1/Card

K293-C
12/Multi-Card

ID Badge Mini Reel (Key Ring)

Split key ring holder is attached to a retractable 19" cord. Convenient clip on the back to attach to shirt, belt or purse.



K296
1/Card

K296-C
12/Multi-Card



**Point of Purchase
Display Drums**

30-06 Brass Bullet

Showcase your passion for sporting. This is the real deal empty shell.



K300

1/Card

K300-B
50/Bulk

K300-C
12 /Multi-Card

Elastic Wrist Band

Take to the gym, beach or pool. Makes hanging onto your keys easy.



K297

1/Card

K297-C

12 /Multi-Card

357 Magnum Bullet

Showcase your passion for sporting. This is the real deal empty shell.



K302

1/Card

K302-B
50 /Bulk

K302-C
12 /Multi-Card

44 Magnum Bullet

Showcase your passion for sporting. This is the real deal empty shell.



K301

1/Card

K301-B
50 /Bulk

K301-C
12 /Multi-Card

Acrylic Flag (U.S.A)

3/8" thick Acrylic tag.



K320

1/Card

K320-C
12 /Multi-Card

Acrylic Flag

1-1/2" Acrylic key tag.



U.S.A.

K310

1/Card

K310-C
12 /Multi-Card

Mexico

K311

1/Card

K311-C
12 /Multi-Card

Acrylic Flag (Mexico)

3/8" thick Acrylic tag.



K321

1/Card

K321-C
12 /Multi-Card

Lucky Rabbit Foot

This rabbit foot may bring a little extra luck when needed. **Assorted Colors.**



K330

1/Card

K330-B
50/Bulk

K330-C
12 /Multi-Card

Jumbo Dice

Large colorful die makes keys easy to find and hold. Small link chain attached with a split ring to hold keys. **Assorted Colors.**



K331

1/Card

K331-B
50 /Bulk

K331-C
12 /Multi-Card

Metal Luggage Tag

Identity protection. Name shows through the window but address is not visible. Made of anodized aluminum. **Assorted Colors.**



K341

1/Card

K341-C
12 /Multi-Card

Detailed info
when opened

Squeeze Coin Case

Soft heavy-duty material opens easily when squeezed and closes tight when released. **Assorted Colors.**



K353

1/Card

K353-C

12 /Multi-Card

Coins/key not included

Flashlight Bug

This small, but bright LED light gives extra light when needed. **Assortment of Colors.**



K360
1/Card

K360-B
50/Bulk

K360-C
12/Multi-Card



Flashlight Designer

This slim, sleek designer design provides an amazingly bright LED light. **Available in many designer colors.**



K361
1/Card

K361-B
50/Bulk

K361-C
12/Multi-Card



Flashlight Chain

Flashlight key chain is simple and easy to use giving an instant bright light. Easy battery replacement. **Assorted Colors.**



K362
1/Card

K362-B
50/Bulk

K362-C
12/Multi-Card



Flashlight Chip

Casino Chip key chain has a flashlight built into the bottom of the chip.



K363
1/Card

K363-B
50/Bulk

K363-C
12/Multi-Card



Flashlight C-Clip

Quickly hang or attach keys to belt loops or purse strap Extra BRIGHT light when needed. **Assorted Colors.**



K364
1/Card

K364-B
50/Bulk

K364-C
12/Multi-Card



Flashlight Pig

Push the button and the pig says OINK, OINK while a bright light shines through the pig's snout. Easy battery replacement.



K365
1/Card

K365-B
50/Bulk



Opener- Shark

Always have a bottle opener available! Made from quality aluminum and anodized for a durable finish. **Assorted Colors.**



K370
1/Card

K370-B
50/Bulk

K370-C
12/Multi-Card

Opener- Claw

Always have a bottle opener available! Made from quality aluminum and anodized for a durable finish. **Assorted Colors.**



K371
1/Card

K371-B
50/Bulk

K371-C
12/Multi-Card

Opener- Hidden

Bottle opener swings in and out of the clear transparent case. **Assortment of Colors.**



K372
1/Card

K372-B
50/Bulk

K372-C
12/Multi-Card

Safety Whistle

The added comfort, confidence and safety is just a whistle away. Keep your keys and whistle together.



K380
1/Card

K380-C
12/Multi-Card

Baseball Key Ring

Love and support your favorite sport. Looks and feels like the real ball.



K381
1/Card

K381-B
50/Bulk

K381-C
12/Multi-Card

Basketball Key Ring

Love & support your favorite sport. Looks and feels like the real ball.



K382
1/Card

K382-B
50/Bulk

K382-C
12/Multi-Card

Golf Key Ring

Love and support your favorite sport. Looks and feels like the real ball.



K383

1/Card

K383-B
50/Bulk

K383-C
12/Multi-Card

Football Key Ring

Love and support your favorite sport. Looks and feels like the real ball.



K384

1/Card

K384-B
50/Bulk

K384-C
12/Multi-Card

Soccer Key Ring

Love and support your favorite sport. Looks and feels like the real ball.



K385

1/Card

K385-B
50/Bulk

K385-C
12/Multi-Card

Tennis Key Ring

Love and support your favorite sport. Looks and feels like the real ball.



K386

1/Card

K386-B
50/Bulk

K386-C
12/Multi-Card

Floating Buoy

Keeps keys highly visible and easy to find. Keys will float!



K387

1/Card

K387-B
50/Bulk

K387-C
12/Multi-Card

Floating Squeeze

Keeps keys highly visible and easy to find. Keys will float!



K388

1/Card

K388-B
50/Bulk

K388-C
12/Multi-Card

Flip-Flop

Always feel like you are at the beach with the beachy flip-flop key chain.



K500

1/Card

K500-B
50/Bulk

K500-C
12/Multi-Card

Jumbo Safety Pin

Easily identify keys with this 5-1/2" tall Safety Pin. Assortment of Colors.



K501

1/Card

K501-C
12/Multi-Card

Pill Box Keeper

Conveniently carry meds with your keys. 1-3/4" body unscrews from lid. Assorted Colors.



K503

1/Card

K503-B
50/Bulk

Stainless Ring

Heavy-duty flexible steel ring. Connector cap unscrews from one end of the cable so that keys can easily be added. 6-1/4" end to end.



K504

1/Card

K504-C
12/Multi-Card

Spring Sleeve

The sleeve is spring loaded making it easy to add keys. Nickel Plated. 2" x 3/4".



K505

1/Card

K505-C
12/Multi-Card

Key Tag w/ Chain

Quickly and easily identify keys. The ball chain secures the ID card in place. 4 tags per card. Assorted Colors.



K800

4/Card

K800-B
100/Bulk

K800-D
100/Drum

Key Tag w/ Ring

Quickly and easily ID keys. Lift the cover & paper insert slides out making it easy to write. 4 tags per card. **Assorted colors.**



K810
4/Card

K810-B
100/Bulk

K810-D
100/Drum

Key I.D. w/ Swivel

Quickly and easily ID keys. Pop the cover and paper insert slides out making it easy to write. 4 tags per card. **Assorted Colors.**



K820
4/Card

K820-B
100/Bulk

K820-D
100/Drum

Key I.D. w/ Ring (Standard Colors)

Quickly and easily ID keys. Pop the cover and paper insert slides out making it easy to write. 4 tags per card. **Assorted Colors.**



K830
4/Card

K830-B
100/Bulk

K830-D
100/Drum

1-1/4" Color Tag

Easily ID keys. Easy to write on, while the erasable surface allows tag to be reused. 15 tags per card. **Assorted Colors**



K861
15/Card

K861-B
50/Bulk

PAPER KEY TAGS

Easily ID keys. Easy to write on, erasable surface.

Item #	Description	Package
K850	15/16" Paper Tag	15/ Card
K850-B	15/16" Paper Tag	50/Bulk
K851	1-1/4" Paper Tag	15/ Card
K851-B	1-1/4" Paper Tag	50/Bulk
K852	1-9/16" Paper Tag	10/ Card
K852-B	1-9/16" Paper Tag	50/Bulk
K853	2-1/4" Paper Tag	10/ Card
K853-B	2-1/4" Paper Tag	50/Bulk

SPLIT KEY RINGS



Item #	Description	Package
K911	5/8" Split Rings	100/Bulk
K912	3/4" Split Rings	100/Bulk
K913	7/8" Split Rings	100/Bulk
K914	1" Split Rings	100/Bulk
K915	1-1/16" Split Rings	100/Bulk (gold)
K916	1-1/8" Split Rings	100/Bulk
K917	1-1/4" Split Rings	100/Bulk
K918	1-3/8" Split Rings	100/Bulk
K919	1-1/2" Split Rings	100/Bulk
K920	2" Split Rings	50/Bulk
K921	3" Split Rings	25/Bulk

1-1/4" Fiber Tag

Easily ID keys. Easy to write on, while giving it more durability. 15 tags per card.



K871
1/Card

K871-B
50/Bulk

3/4" Give Away Rings



K900
1000/Bulk

1" Give Away Rings



K900
1000/Bulk

Our Family of Brands:

PRO-LOK®



Full Line of:

- Auto Opening Kits
- Auto Opening Tools
- Auto Opening Lights
- Blue Punch Key Machines
- Door Installation Tools
- I/C Core Tools
- Key Decoders
- Key Hooks
- Key Tags
- Locksmith Tools
- Lock Picks
- Safe Bits

Full Line of:

- Adaptor Plates
- Door Knobs
- Door Viewers
- Filler Plates
- Hole Covers
- Hasp Locks
- Latch Protectors
- Patio Door Locks
- Strike Plates
- Window Locks
- Wrap Plates
- Escutcheon Plates

Full Line of:

- Key Identification/Tags
- Coils
- Pull-a-Parts
- C-clips
- Key Reels/Badge Pulls
- Belt Hooks
- Snaps
- Key Hiding
- Chains/Necklaces
- Lanyards/Wrist Straps
- Key Cases
- Split Rings

WORLD HEADQUARTERS

PRO-LOK®

655 North Hariton Street
Orange, California 92868
United States of America

Phone: 866.679.1366

Fax: 714.633.0470

Email: HelpDesk@pro-lok.com