

KEYS LLAVES

Opening the world access
MX C.13





We are a people-focused company, leading the global locksmith industry. Our commitment lies in providing expertise, technology, and innovation to create profitable opportunities in the market of opening solutions.

We strive to grow with you, embrace change, and constantly evolve.

Somos una empresa comprometida con las personas, con liderazgo mundial en el sector de la cerrajería. Te acompañamos aplicando conocimiento, tecnología e innovación para generar negocio en soluciones de apertura.

Estamos abiertos a evolucionar contigo.

Open to your
needs

Abiertos a tus
necesidades

JMA[®]

Opening
the future

JMA UNIVERSE

Universo JMA
Univers JMA

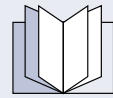

A8 — A17 FROM TRADITION TO INTERNATIONAL PROJECTION

De la tradición a proyección internacional
De la tradition à la projection
internationale

A18 — A25 TOGETHER TO BE THE FIRST

Juntos para ser los primeros
Ensemble pour être les premiers

A26 — A32 QUALITY MATERIALS FOR LONG-LASTING KEYS

Materiales de calidad para llaves que
duran toda la vida
Matériaux de qualité pour des clés qui
durent toute la vie

JMA KEYS. CATALOGUE

Llaves JMA. Catálogo
Clés JMA. Catalogue

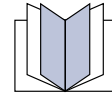

K01 01 — 65

VEHICLE KEYS

Llaves de vehículos
Clés de voitures

K02 67 — 82

MOTORCYCLE KEYS

Llaves de motocicletas
Clés de motos

K03 83 — 167

CYLINDER KEYS

Llaves de serreta y especiales
Clés plates et spéciales

K04 169 — 181

DIMPLE KEYS

Llaves de puntos
Clés à points

K05 183 — 185

FLAT & LOCKER KEYS.

Llaves para casillas
Clés pour casiers

K06 187 — 195

BIT AND BARREL KEYS

Llaves de Gorja
Clés à gorge

K07 197 — 201

CROSS - SHAPED KEYS

Llaves de cruz
Clés cruciformes

K08 203 — 214

QUICK BLANKS LINES

Llaves quick blanks
Clés quick blanks

USER GUIDE FOR THIS CATALOGUE. BRAND INDEX

Guía de uso de este catálogo. índice de marcas
Guide d'utilisation du catalogue. Index marque



215 — 217 MANUAL OF USE

Manual de uso
Manuel d'utilisation

218 DESCRIPTION AND TERMINOLOGY

Descripción y terminología
Description et terminologie

219 SYMBOLS AND NATIONALITIES

Símbolos y nacionalidades
Symboles et nationalités

221 — 227 KEY CUTTING MACHINES

Máquinas duplicadoras
Machines de reproduction

229 — 243 BENCHMARK INDEX

Índice de referencias
Index des références

244 — 248 BRAND INDEX

Índice de marcas
Index marque

249 — 282 COMPETITOR CROSS REFERENCE

Índice comparativo
Index comparatif

Index



De la tradición a la
proyección internacional

From tradition to a global prominence

TRADITION AND VALUES

Since our humble artisanal beginnings in 1942, we have maintained our commitment to a traditional model grounded in the metal industry, enriched with enduring human values.

We possess extensive expertise in key manufacturing, bolstered by our own fusion equipment, which provides the flexibility to meticulously craft our products and deliver unparalleled customer service.

TRADICIÓN Y VALORES

Desde nuestros inicios más artesanales en 1942, nos hemos mantenido fieles a un modelo tradicional basado en una industria del metal con unos fuertes valores humanos.

Somos expertos en la fabricación de llaves, y también disponemos de nuestro propio equipo de fusión, lo que nos da la flexibilidad para garantizar el cuidado meticuloso de nuestros productos y el más alto nivel de servicio al cliente.

Our origins stemmed from the metal industry



COMMITMENT TO QUALITY

One of our group's core strengths lies in our unwavering dedication to ensuring the quality of our products.

This is evident through our partnerships with demanding locksmith manufacturers and our presence in the automotive market. Moreover, our quality management system is certified according to [IATF 16949:2016](#) and [ISO 9001:2015](#) standards.

COMPROMISO CON LA CALIDAD

Uno de los puntos fuertes de nuestro grupo es nuestra dedicación a garantizar la calidad de nuestros productos.

Prueba de ello es que suministramos a los fabricantes de cerrajería más exigentes, así como al mercado de la automoción, y que nuestro sistema de gestión de la calidad cuenta con las certificaciones [IATF 16949:2016](#) e [ISO 9001:2015](#).

Tradition, innovation, and progress



INNOVATIVE TECHNOLOGIES

With our extensive experience, we possess the expertise to develop unique solutions that are precise, sophisticated, and reliable, setting us apart in the industry.

Our investments in automated industrial processes and groundbreaking technologies enable us to deliver exceptional products, efficient services, and user-friendly solutions that meet global market demands.

TECNOLOGÍAS INNOVADORAS

Nuestros años de experiencia nos han dotado de los conocimientos necesarios para crear soluciones precisas, sofisticadas y de garantía que nos hacen únicos en el sector.

Realizamos inversiones en procesos industriales automatizados y tecnologías innovadoras inventivas que proporcionan productos excelentes, servicios eficaces y soluciones intuitivas. Generamos un negocio global que satisface todas las demandas del mercado.

Sophisticated and guarantee solutions



IMPACTFUL INITIATIVES

Our keys are manufactured using solely renewable energy sources and 100% recycled materials. By managing our own supply of brass and nickel silver, we minimize transportation emissions and reduce our carbon footprint. In addition to sourcing local materials, we are at the forefront of developing lead-free products to minimize their environmental impact.

Our environmental management system is [ISO 14001:2015](#) certified, and our occupational health and safety system complies with [ISO 45001:2018](#) standards.

GESTOS QUE MARCAN LA DIFERENCIA

Nuestras llaves se fabrican utilizando únicamente energía de fuentes renovables y materiales 100% reciclados. Gracias a que gestionamos nuestra propia fuente de suministro de latón y alpaca, limitamos las emisiones del transporte, reduciendo nuestra huella de carbono. Además de utilizar materiales Km 0, también estamos a la vanguardia del desarrollo de productos sin plomo con el objetivo de reducir su uso en la producción de llaves y minimizar su impacto medioambiental.

Nuestro sistema de gestión medioambiental cuenta con la certificación [ISO 14001:2015](#), y nuestro sistema de salud y seguridad en el trabajo, con la [ISO 45001:2018](#).

Dedicated to responsible practices



CONFIDENCE EXPERTS

We are renowned experts in the global opening solutions industry, offering a wide range of adaptable products and services that are user-friendly.

Thanks to our extensive presence, we instil confidence and make ourselves available wherever you need us. We enhance your experience by embracing new technical and technological challenges.

We invest in the development and manufacturing of tailored solutions specifically for professionals in the locksmith, hardware, and vast supply chain industries.

ESPECIALISTAS DE CONFIANZA

Somos expertos en soluciones de apertura global gracias a una amplia gama de productos y servicios adaptables y fáciles de usar.

Nuestra presencia global nos permite generar confianza y presentarnos allí donde nos necesites. Diseñamos una mejor experiencia abordando nuevos retos técnicos y tecnológicos.

Invertimos en el desarrollo y fabricación de soluciones personalizadas para ti, profesional del sector de la cerrajería, la ferretería y la gran cadena de suministro.

Your trusted professional, always within reach



EMBRACING NEW POSSIBILITIES

With our inventive and service-oriented approach, we have become a global industry leader.

Our global strategy spans more than sixteen countries, with twelve sales offices across Europe, America, Asia, and Africa. We have production facilities in both Europe and America, and our products are sold in over 100 countries worldwide.

NUEVAS OPORTUNIDADES

Gracias a nuestra estrategia global, basada en nuestra vocación innovadora y orientada al servicio, somos referentes mundiales del sector.

Estamos presentes en diez países, con oficinas de ventas repartidas por Europa, América, Asia y África, instalaciones de producción tanto en Europa como en América y ventas en más de 100 países de todo el mundo.

Together, we unlock future opportunities



JMA®

HEADQUARTERS

SPAIN

MANUFACTURING

SPAIN. MEXICO.

LOGISTICS & DISTRIBUTION

USA. UK. PORTUGAL. POLAND. MOROCCO. FRANCE. PERU. COLOMBIA.



● DISTRIBUTION CENTERS ● MANUFACTURING PLANTS

OPEN-MINDEDNESS

We promote the development of new concepts that offer adaptable, effective, and complementary solutions for the locksmith industry.

Our commitment to innovation is evident in our wide product range, which includes key-cutting machines, remote controls, automotive solutions, and accessories.

Through enhanced networking capabilities, we design reliable solutions that align with your work style, providing confidence at every step.

ABIERTOS A EVOLUCIONAR

Promovemos el desarrollo de nuevos conceptos que aporten soluciones adaptables, eficaces y complementarias para la industria de las llaves, así como para máquinas duplicadoras, mandos a distancia, automóviles y accesorios.

Nuestro enfoque innovador puede apreciarse en toda la gama de productos, que incluye máquinas duplicadoras, mandos a distancia, automoción y accesorios.

Con capacidades de conexión en red que nos ayudan a acercarnos a su estilo de trabajo, diseñamos soluciones fiables que inspiran confianza.

Sustainable growth via innovative solutions.



EVERY DAY IS THE START OF THE FUTURE

Our success is built on our unwavering commitment to people. We design products that cater to global opening solutions, meeting the ever-evolving demands of the market.

Your requirements are our top priority, and your future is the driving force behind our daily efforts. We are always nearby, ready to assist you in every possible way.

EL FUTURO EMPIEZA TODOS LOS DÍAS

Nuestro compromiso con las personas es la base de nuestro éxito. Diseñamos productos que aportan soluciones globales de apertura para satisfacer las demandas del mercado.

Soluciones que mejoren tu vida respetando el medio ambiente por medio de una planificación cuidadosa, tecnología innovadora y procesos de fabricación sostenibles. Porque tus necesidades son nuestra principal preocupación y tu futuro es la razón por la que empezamos cada día.

Always prioritising the end user





**Quality
materials
for long-
lasting
keys**

THE HIGHEST QUALITY KEYS

In order to create the highest quality keys and provide our customers with unparalleled service, the quality of raw materials is paramount. We meticulously choose the finest materials, tailored to meet the specific requirements and intended usage of our customers.

Our expertise enables us to manufacture versatile and customized keys using different techniques. We source materials like nickel silver, brass, steel, and aluminium from multiple channels to provide tailored solutions for each customer's unique needs. The integration of our foundry within the Altuna group gives us a competitive advantage, allowing us to develop new materials and enhance service quality.

LLAVES DE LA MÁS ALTA CALIDAD

Para producir las mejores llaves y ofrecer a nuestros clientes el mejor servicio, las materias primas son esenciales. Dependiendo de los requisitos de nuestros clientes y del uso previsto, podemos producirlas utilizando diferentes técnicas.

Nuestra capacidad para fabricar llaves utilizando materiales como alpaca, latón, acero y aluminio de diversas fuentes de suministro, nos permite ofrecer soluciones específicas para cada necesidad de nuestros clientes. Disponer de una fundición dentro del grupo Altuna también nos proporciona una ventaja competitiva en el desarrollo de nuevos materiales y en la calidad del servicio.

We meticulously select the raw material



EXUDING SOPHISTICATION AND EXCELLENCE

A hallmark of our key production lies in the meticulous attention to detail, showcased by the impeccable polished finish adorning each and every key in our extensive catalogue.

We take great pride in overseeing every aspect of our work, ensuring the highest standards of quality and sophisticated solutions.

SOFISTICACIÓN Y AUTOEXIGENCIA

Nuestra seña de identidad, que se transmite en la creación de todas las familias de llaves, es un acabado pulido brillo muy cuidado.

Hemos sido reconocidos por supervisar meticulosamente cada aspecto de nuestro trabajo, al tiempo que ofrecemos las soluciones más completas y sofisticadas disponibles.

Polished and lustrous finish





Keys

JMA KEYS. CATALOGUE

Llaves JMA. Catálogo
Clés JMA. Catalogue



Key families

Familias de llaves



K01 01 – 65

VEHICLE KEYS

Llaves de vehículos
Clés de voitures



K02 67 – 82

MOTORCYCLE KEYS

Llaves de motocicletas
Clés de motos



K03 83 – 167

CYLINDER KEYS

Llaves de serreta y especiales
Clés plates et spéciales



K04 169 – 181

DIMPLE KEYS

Llaves de puntos
Clés à points



K05 183 – 185

FLAT & LOCKER KEYS

Llaves para casillas
Clés pour casiers



K06 187 – 195

BIT AND BARREL KEYS

Llaves de Gorja
Clés à gorge



K07 197 – 201

CROSS - SHAPED KEYS

Llaves de cruz
Clés cruciformes

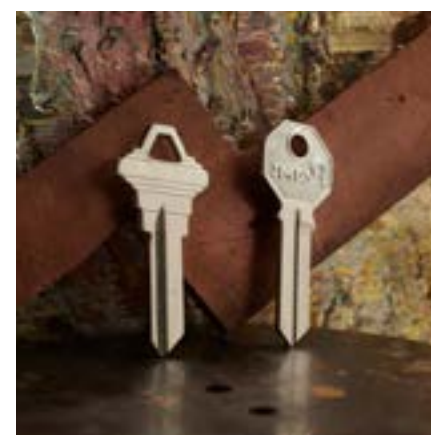

K08 203 – 214

QUICK BLANK LINES

Llaves quick blank
Clés quick blank

Distinctive keys*

Llaves especiales



COINED

Grabado
Gravure



ALUMINIUM

Aluminio
Aluminium



NEON KEYS



FUN COLOR KEYS



CRISTAL KEYS



VEHICLE KEYS

Llaves de vehículos
Clés de voitures

* **Check References.** Consultar Referencias. Voir Références.

** **Customizable models.** Modelos personalizables. Modèles personnalisables

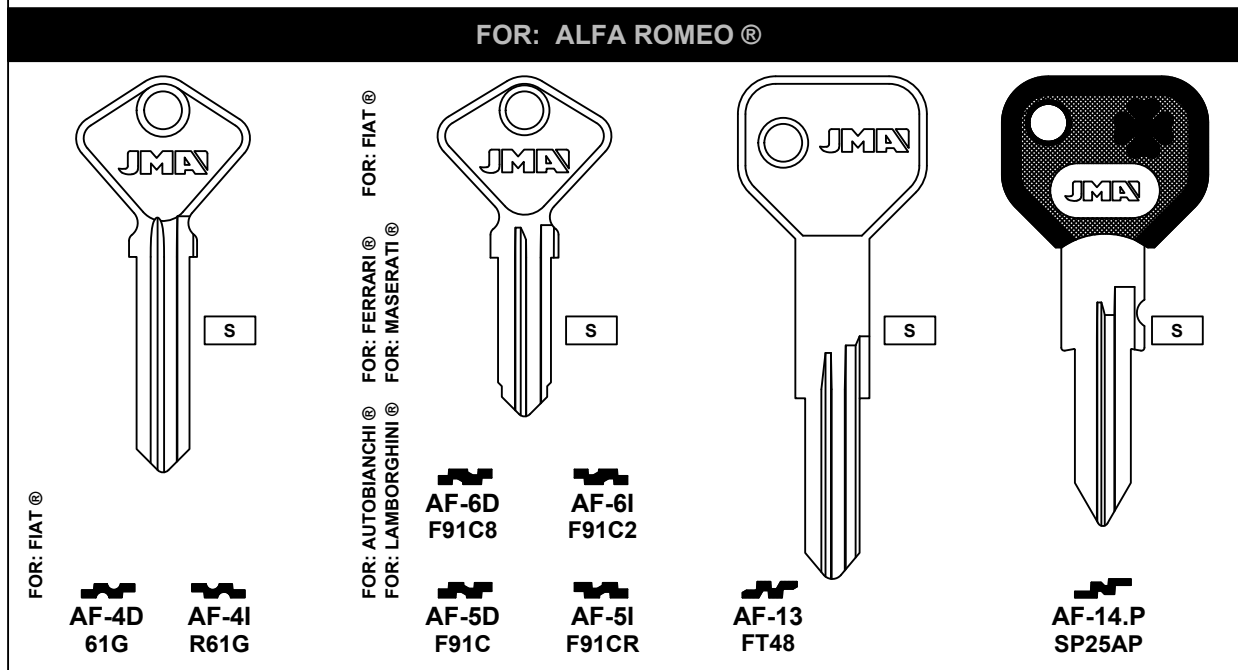
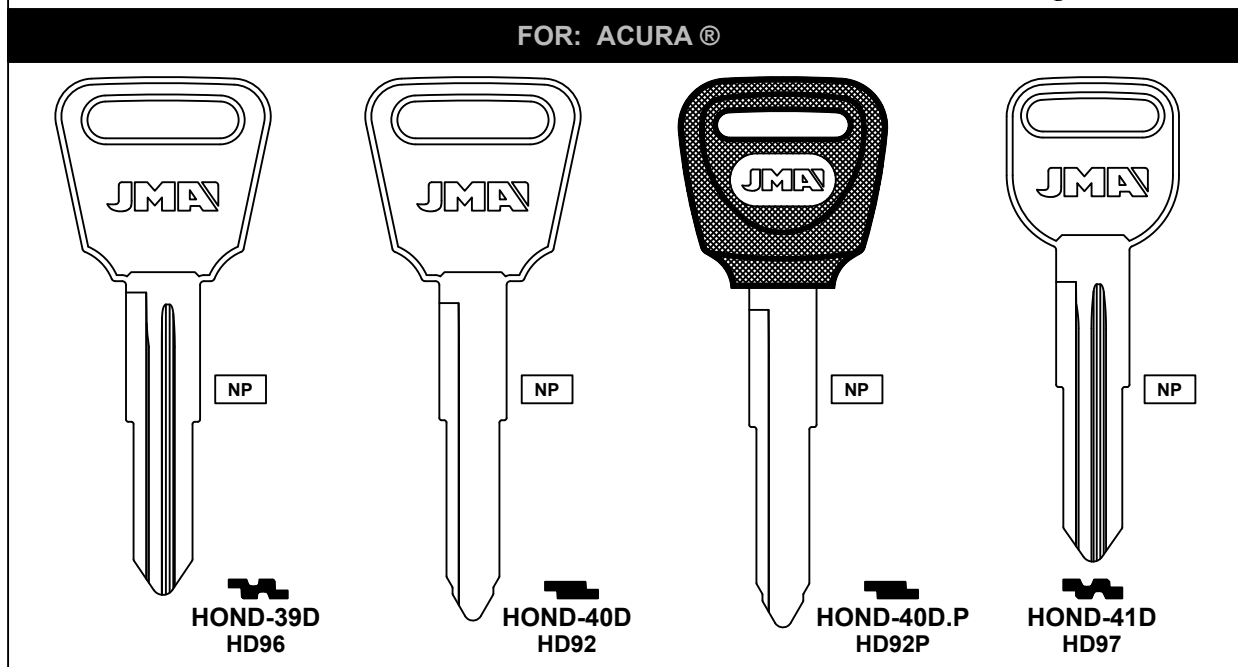
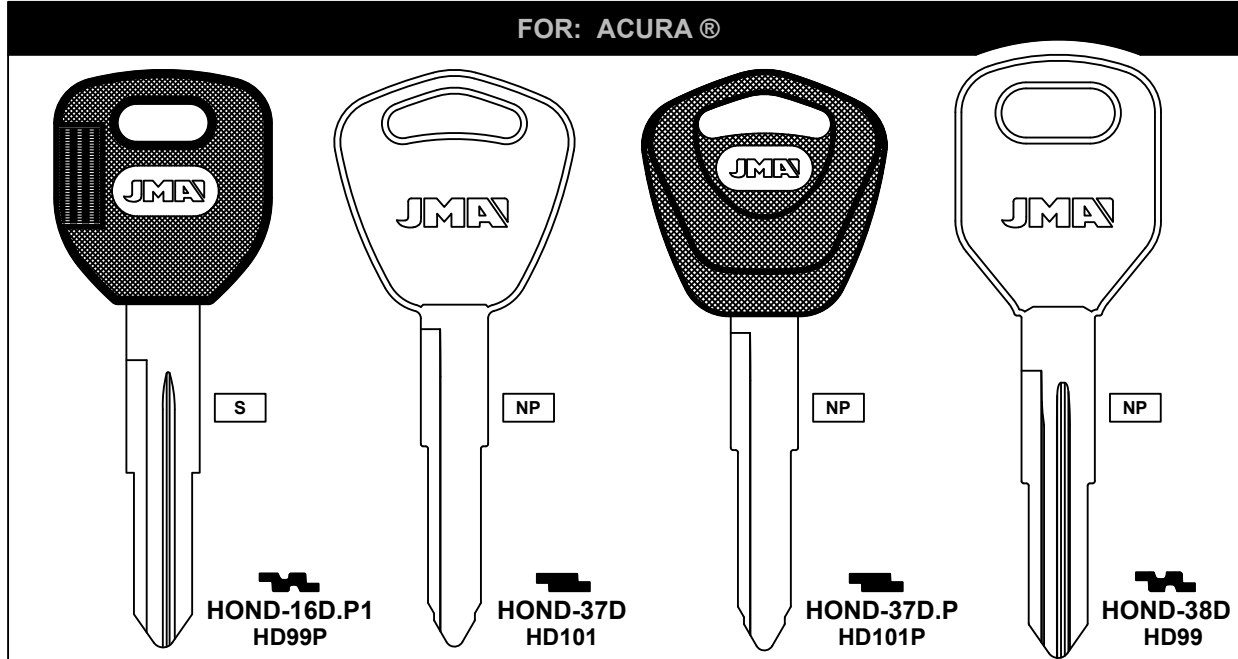

Z ZAMAK
NS N.SILVER / ALPACA
S STEEL / ACERO
NE NEON
NP NICKEL PLATED / LATON NIQUELADO
FUN COLOR
CM CRISTAL KEYS / PLASTICO COLOR
ALUMINUM / ALUMINIO
B BRASS / LATON

! Concerning the marks and commercial denominations see note in index.

Concerniente a las marcas y denominaciones comerciales ver nota en indice.

Concernant les marques et denominations commerciales voir la note dans l'index.





Concerning the marks and commercial denominations see note in index.

Concerniente a las marcas y denominaciones comerciales ver nota en índice.

Concernant les marques et dénominations commerciales voir la note dans l'index.



Concerning the marks and commercial denominations see note in index.

Concerniente a las marcas y denominaciones comerciales ver nota en índice.

Concernant les marques et dénominations commerciales voir la note dans l'index.



A ALUMINUM / ALUMINIO B BRASS / LATON CM FUN COLOR CK CRISTAL KEYS / PLASTICO COLOR NE NEON NP NICKEL PLATED / LATON NIQUELADO NS N.SILVER / ALPACA S STEEL / ACERO Z ZAMAK	FOR: ALFA ROMEO ®				FOR: AMERICAN MOTORS ®			
	 FOR: AUTOBIANCHI ® FEM-2I F91H FEM-2D F91G FEM-1I F91F FEM-1D F91E		 FOR: FERRARI ® FOR: IVECO ® FOR: LAMBORGHINI ® FOR: PANTERA ® IMS-5 FT37 IMS-3 FT38		 FOR: JEEP ® FOR: RENault ® UN-44 62DG UN-44D R62DG AMM-2 RA3		 FOR: JEEP ® FOR: RENault ® AMM-2 RA3	
	FOR: AMERICAN MOTORS ®				FOR: AMERICAN MOTORS ®			
 FOR: JEEP ® AMM-3 RA4		 FOR: JEEP ® AMM-4 B5		 FOR: JEEP ® FOR: RENault ® BS-11 RA2		 FOR: JEEP ® FOR: RENault ® GM-9 B46		
FOR: AMERICAN MOTORS ®				FOR: AMERICAN MOTORS ®				
 FOR: JEEP ® FOR: RENault ® GM-9.P B46P		 FOR: JEEP ® FOR: RENault ® NE-16 RN25		 FOR: JEEP ® FOR: RENault ® NE-20 RN30		 FOR: JEEP ® FOR: RENault ® NE-22.P RN24P		

FOR: AMERICAN MOTORS ®				FOR: ASTON MARTIN ®			
 FOR: JEEP ® FOR: RENault ® NE-28 RN31		 FOR: JEEP ® FOR: RENault ® VA-10 RN29		 FOR: BRITISH LEYLAND ® FR FO-FR F81E		 FOR: D.A.F. ® FOR: FORD ® FO-TX FO-TX FC7	
FOR: ASTON MARTIN ®				FOR: ASTON MARTIN ®			
 FOR: D.A.F. ® FOR: FORD ® FO-TX.P FC7P		 FOR: JEEP ® FP IN-1 H62DP		 FOR: BRITISH LEYLAND ® FOR: MOB ® UN-FP 62DP		 FOR: BRITISH LEYLAND ® FOR: NORTON ® FOR: JAGUAR ® FOR: VOLVO ® UN-FS 62FS	
FOR: ASTON MARTIN ®		FOR: ASTON MARTIN ®		FOR: AUDI ®		FOR: AUDI ®	
 FOR: BEDFORD ® FOR: BRITISH LEYLAND ® UN-FT F68YT		 HV AU-1		 AH AU-AH		 AH AU-AH.P V35P	

Z ZAMAK NS N. SILVER / ALPACA S STEEL / ACERO NE NEON NP NICKEL PLATED / LATON NIQUELADO CM FUN COLOR CK CRISTAL KEYS / PLASTICO COLOR A ALUMINUM / ALUMINIO B BRASS / LATON	FOR: AUDI®			
	 AH AU-AH.P1	 FOR: OPEL® FOR: VIKING® AU-C AD1	 HV FOR: VOLKSWAGEN® AU-HV PA8	 HV FOR: VOLKSWAGEN® AU-HV.P1 PA8P
	FOR: AUDI®			
	 AU-W PA5	 HU-MN AU15	 FOR: BEDFORD® FOR: HONDA® FOR: BRITISH LEYLAND® FOR: JAGUAR® NE-1 AA2	 HV FOR: PORSCHE® VO-HV 73VB
FOR: AUDI®		FOR: BMW®		
 HV VO-HV.P 73VBP	 BM-2 BMW3	 BM-2.P BMW3P	 BM-3	

Z ZAMAK NS N. SILVER / ALPACA S STEEL / ACERO NE NEON NP NICKEL PLATED / LATON NIQUELADO CM FUN COLOR CK CRISTAL KEYS / PLASTICO COLOR A ALUMINUM / ALUMINIO B BRASS / LATON	FOR: BMW®			
	 3.5 mm BM-4 S6BW	 BM-5.P S7BWP	 BM-6.P HU92RP	 BM-B WT3
	FOR: BMW®			
	 NB BM-NB HF40	 NB BM-NB.P	 HB BM-HB.P1	 BM-W BMW1
FOR: BMW®		FOR: BOMBARDIER®	FOR: BORGWARD®	
 FOR: N.S.U.® HU-SX 63Y	 NE-8	 BOB-1D	 FOR: D.K.W.® FOR: VOLKSWAGEN® HU-P 62VG	



Concerning the marks and commercial denominations see note in index.

Concerniente a las marcas y denominaciones comerciales ver nota en indice.

Concernant les marques et denominations commerciales voir la note dans l'index.



Concerning the marks and commercial denominations see note in index.

Concerniente a las marcas y denominaciones comerciales ver nota en indice.

Concernant les marques et denominations commerciales voir la note dans l'index.



Z ZAMAK NS N. SILVER / ALPACA S STEEL / ACERO NE NEON NP NICKEL PLATED / LATON NIQUELADO NE NEON NP NICKEL PLATED / LATON NIQUELADO CM FUN COLOR CK CRISTAL KEYS / PLASTICO COLOR A ALUMINUM / ALUMINIO B BRASS / LATON	FOR: BORGWARD® FOR: L.K.W.® FOR: MAGIRUS-DEUTZ® BH-1 NE10	FOR: BOSCH® FOR: MACK® BH-2	 NP BH-4 1.95 mm	 S BH-5 2 mm BH12
	FOR: BRITISH LEYLAND®			
	FOR: BRIGGS & STRATTON® FOR: MACK® BS-10 B1	FOR: FREIGHTLINER® FOR: MIS. SWITCHES® NP BS-11 B4	FOR: BRIGGS & STRATTON® NP BS-12 1595	FOR: JAGUAR® S GEM-JC BL6
	FOR: BRITISH LEYLAND®			
 S FO-FK FT6	FOR: FORD INTERNATIONAL® S FO-TC CE6	 NP HUD-6 1561	FOR: VAN GUARD® FOR: VAUXHALL® S FK IN-5 BR18R	
			FS IN-4 H62DR	FP IN-1 H62DP

FOR: BRITISH LEYLAND®			
FOR: IVECO® S LF-RO LF17	FOR: MASERATTI® S	FOR: FERRARI® FOR: FORD INTERNATIONAL® S NE-25 H61VR	FOR: NORTON® FOR: VOLVO® S UN-MRN 62DC
FOR: JAGUAR® FOR: ROOTES GROUP® S UN-FFE 62DM	FOR: JAGUAR® FOR: JAGUAR® S UN-3 R62DM	FOR: JAGUAR® FOR: JAGUAR® S UN-1FS 62DS	FOR: JAGUAR® FOR: JAGUAR® S UN-NC 62DJ
FOR: BRITISH LEYLAND®		FOR: BUELL®	
FOR: JAGUAR® FOR: VAUXHALL® S UN-NH MG1	FOR: ROOTES GROUP® FOR: VAUXHALL® S FR UN-4 BR9	FOR: FORD INTERNATIONAL® FOR: JAGUAR® S UN-44 62DG	 NP DIAMETRO EXTERIOR 9.5 mm DIAMETRO INTERIOR 7.9 mm CHI-1T 1137B
FOR: CATERPILLAR®			
 NP CAT-1.P	 B CAT-1.P1S	 NP CAT-2 1560	 NP CAT-3 CNA2



Concerning the marks and commercial denominations see note in index.

Concerniente a las marcas y denominaciones comerciales ver nota en indice.

Concernant les marques et denominations commerciales voir la note dans l'index.



Concerning the marks and commercial denominations see note in index.

Concerniente a las marcas y denominaciones comerciales ver nota en indice.

Concernant les marques et denominations commerciales voir la note dans l'index.

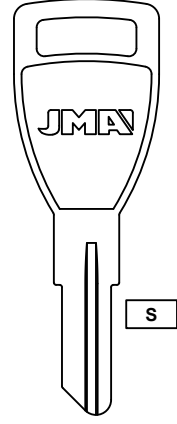
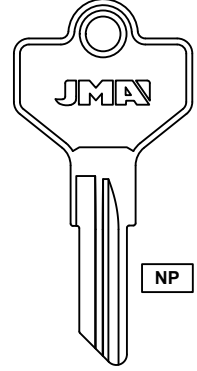
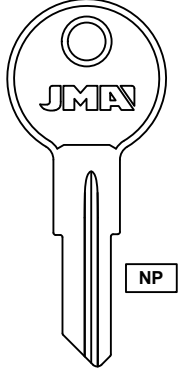
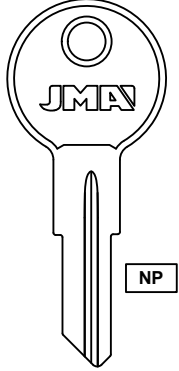
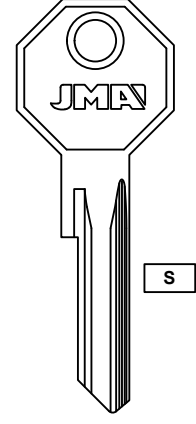
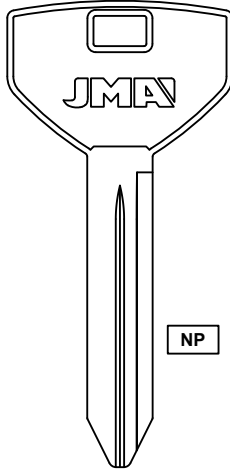
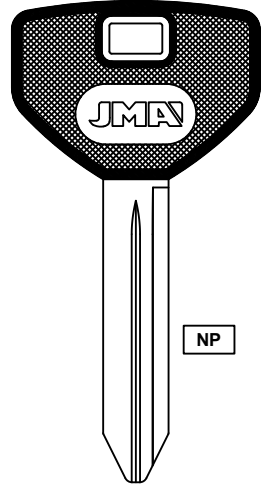
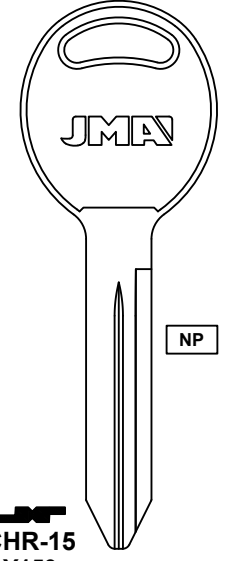
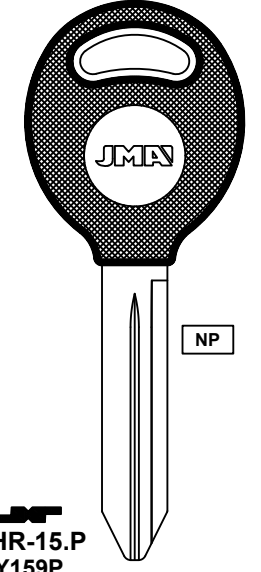
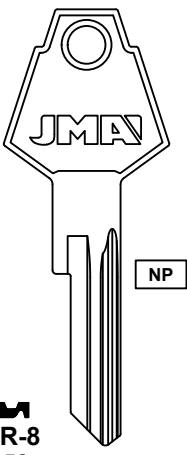
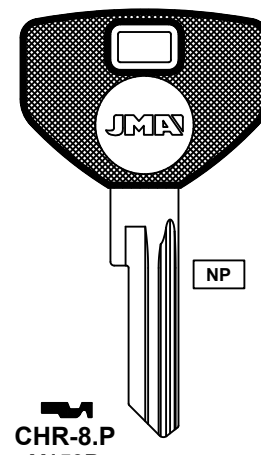
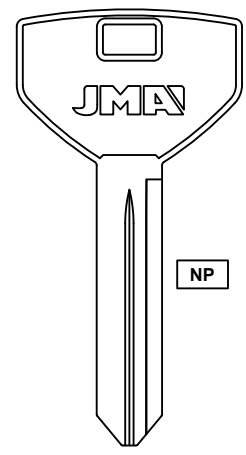
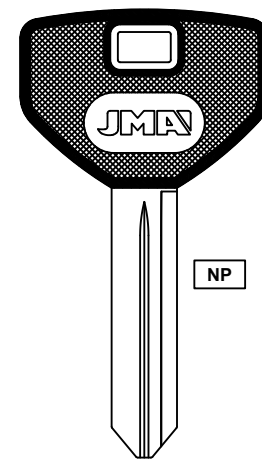
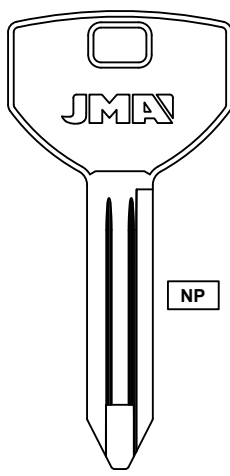
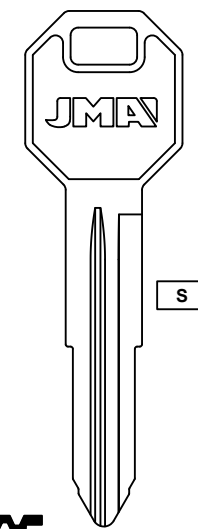
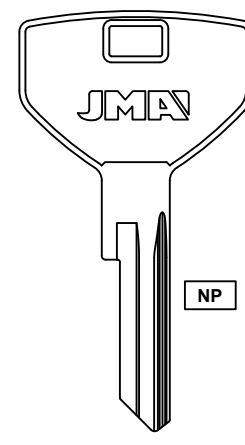
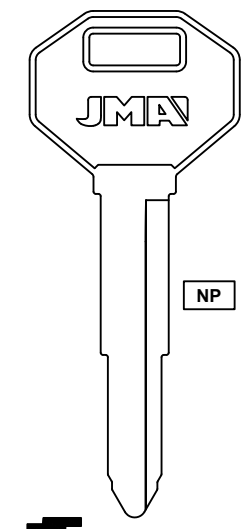
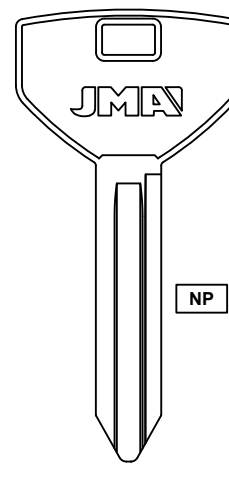
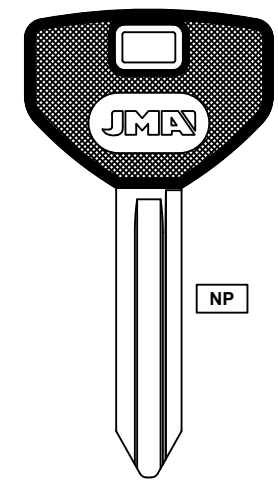
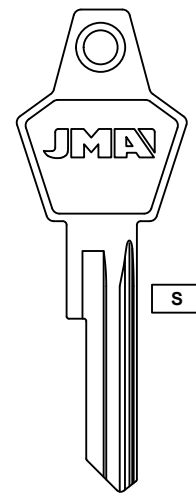
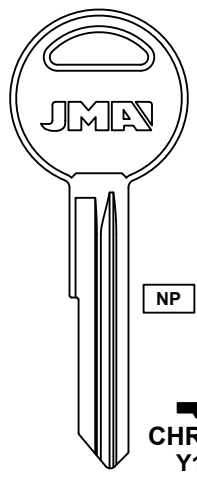
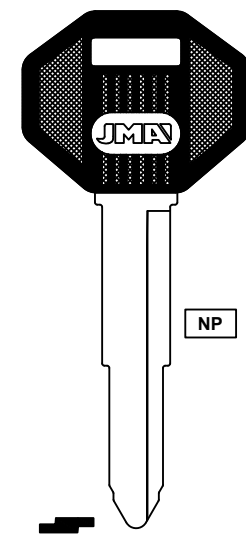
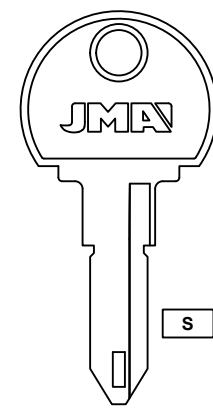
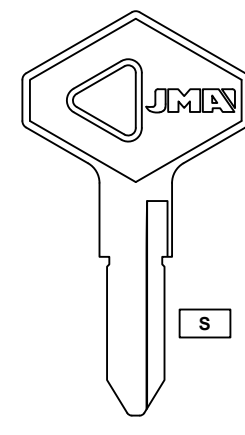
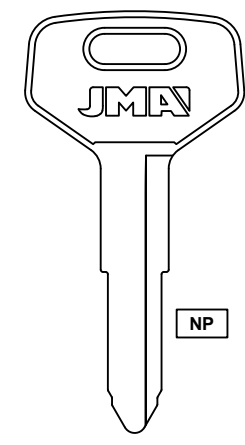

<p>Z ZAMAK</p> <p>NS N. SILVER / ALPACA</p> <p>S STEEL / ACERO</p> <p>NE NEON</p> <p>NP NICKEL PLATED / LATON NIQUELADO</p> <p>FM FUN COLOR</p> <p>GM CRISTAL KEYS / PLASTICO COLOR</p> <p>A ALUMINUM / ALUMINIO</p> <p>B BRASS / LATON</p>	<p>FOR: CESSNA®</p>		<p>FOR: CHRYSLER®</p>		<p>FOR: CHRYSLER®</p>				
	 <p>CN-1D C1054B</p>	 <p>CN-2D 1664</p>	<p>FOR: MIS. SWITCHES® FOR: STUDEBAKER®</p>  <p>YA-45D Y12</p>	 <p>YA-44D Y11</p>	 <p>BAS-21 X1199B</p>	 <p>CHR-14 Y157</p>	 <p>CHR-14.P Y157P</p>	 <p>CHR-15 Y159</p>	 <p>CHR-15.P Y159P</p>
	<p>FOR: CHRYSLER®</p>				<p>FOR: CHRYSLER®</p>				
	 <p>CHR-8 Y152</p>	 <p>CHR-7.P Y153P</p>	 <p>CHR-9 Y154</p>	 <p>CHR-9.P Y154P</p>	 <p>CHR-16 1793V</p>	 <p>CHR-17 MIT2</p>	 <p>CHR-18 Y153</p>	 <p>MIT-21 DC3</p>	
	<p>FOR: CHRYSLER®</p>				<p>FOR: CHRYSLER®</p>				
	 <p>CHR-10 Y155</p>	 <p>CHR-10.P Y155P</p>	 <p>CHR-11 1770CH</p>	 <p>CHR-12 Y149</p>	 <p>MIT-21.P DC3P</p>	 <p>NE-20 RN30</p>	 <p>NE-28 RN31</p>	 <p>TOYO-14 DC1</p>	

Concerning the marks and commercial denominations see note in index.

Concerniente a las marcas y denominaciones comerciales ver nota en indice.

Concernant les marques et denominations commerciales voir la note dans l'index.











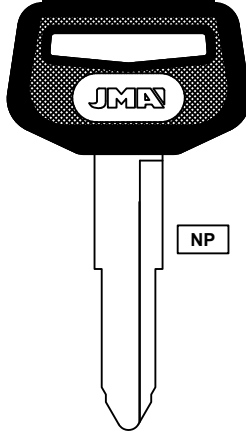
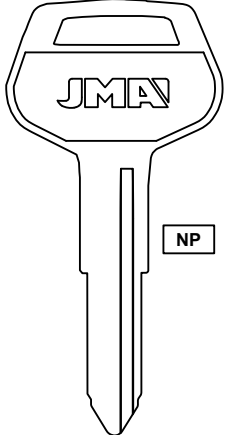
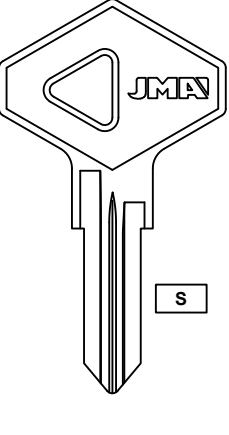
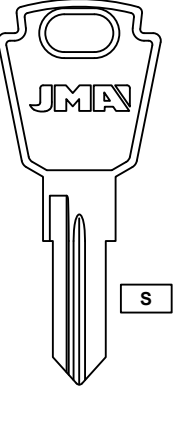
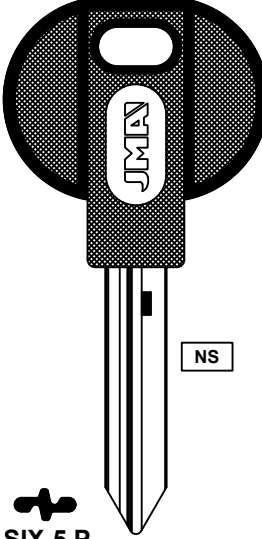
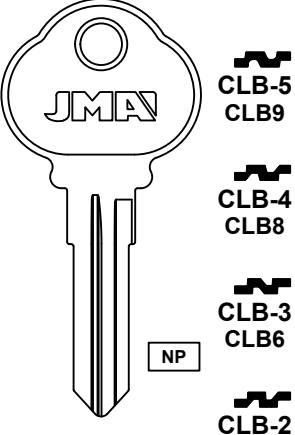
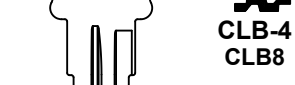
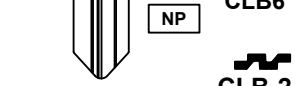

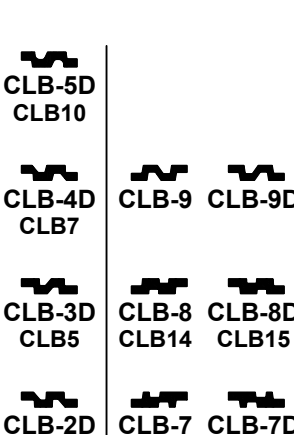
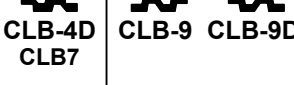
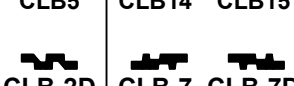







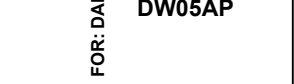

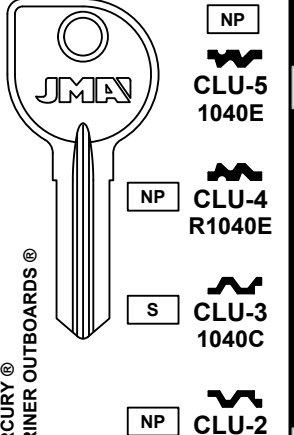
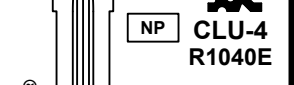
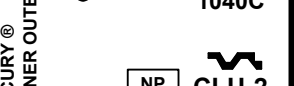
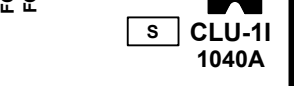

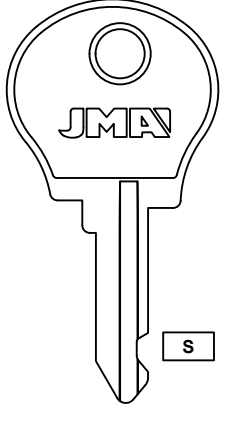

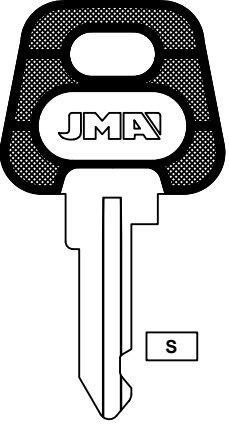
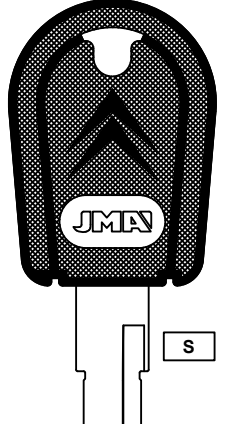
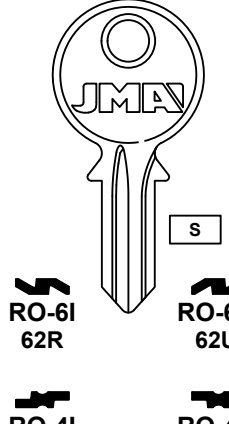
Concerning the marks and commercial denominations see note in index.

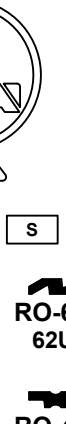
Concerniente a las marcas y denominaciones comerciales ver nota en indice.

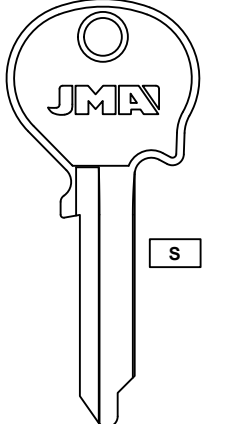
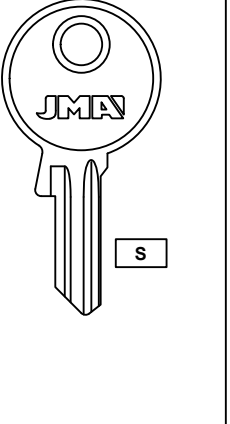
Concernant les marques et denominations commerciales voir la note dans l'index.

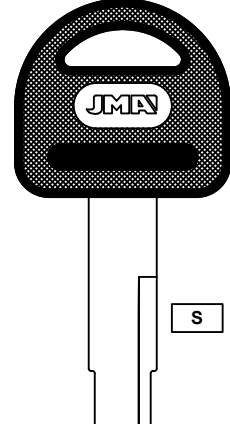
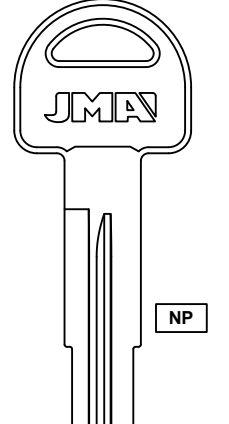
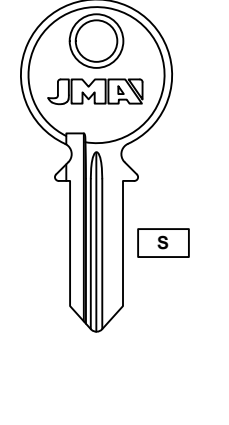
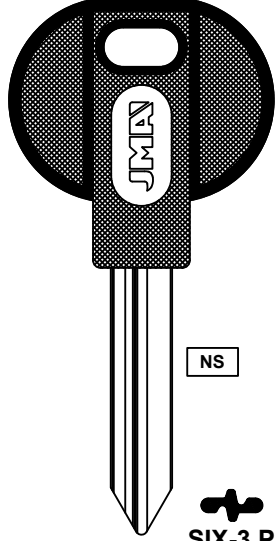
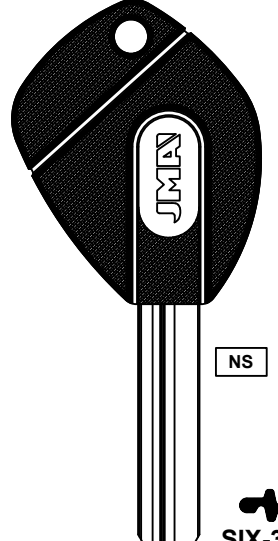
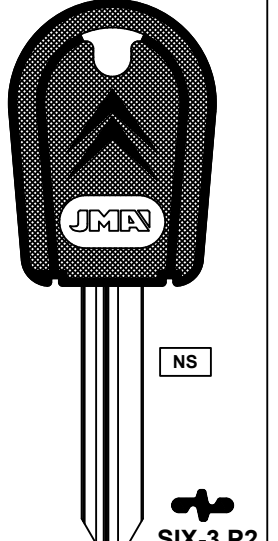
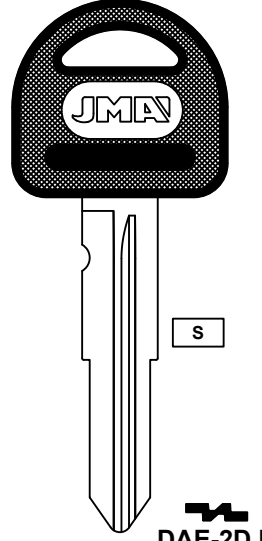
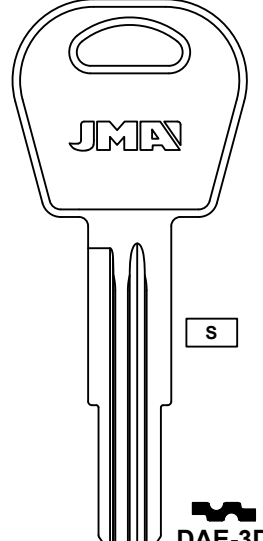
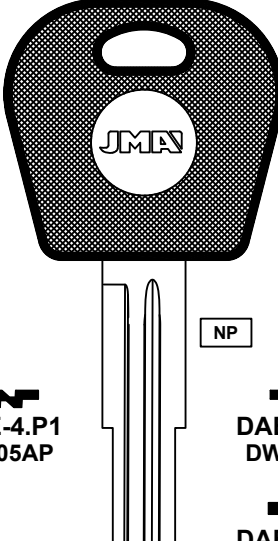
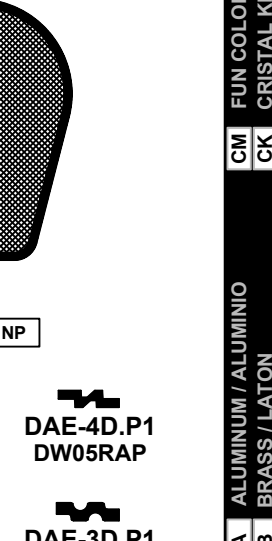

<p>Z ZAMAK</p> <p>NS N.SILVER / ALPACA</p> <p>S STEEL / ACERO</p> <p>NE NEON</p> <p>NP NICKEL PLATED / LATON NIQUELADO</p> <p>CM FUN COLOR</p> <p>CK CRISTAL KEYS / PLASTICO COLOR</p> <p>A ALUMINUM / ALUMINIO</p> <p>B BRASS / LATON</p>	<p>FOR: CHRYSLER®</p>  <p>NP</p> <p>TOYO-14.P DC1P</p>  <p>NP</p> <p>TOYO-24 MS13</p>  <p>S</p> <p>VA-10 RN29</p>			<p>FOR: CITROEN®</p>  <p>S</p> <p>CHR-4D SMS8</p> <p>FOR: SEAT® FOR: SIMCA-TALBOT-MATRA®</p>			<p>FOR: CITROEN®</p>  <p>NS</p> <p>SIX-5.P</p>		<p>FOR: THE CLUB®</p>  <p>NP</p> <p>CLB-5 CLB9</p>  <p>CLB-4 CLB8</p>  <p>CLB-3 CLB6</p>  <p>CLB-2 CLB4</p>  <p>CLB-1 CLB2</p>  <p>CLB-5D CLB10</p>  <p>CLB-4D CLB7</p>  <p>CLB-3D CLB5</p>  <p>CLB-2D CLB3</p>  <p>CLB-1D CLB1</p>  <p>CLB-9 CLB14</p>  <p>CLB-8 CLB15</p>  <p>CLB-7 CLB12</p>  <p>CLB-6 CLB11</p>  <p>CLB-9D CLB15</p>  <p>CLB-8D CLB15</p>  <p>CLB-7D CLB13</p>  <p>CLB-6D CLB11</p>				<p>FOR: CLUM IMBOARDS MOTORS®</p>  <p>NP</p> <p>CLU-5 1040E</p>  <p>NP</p> <p>CLU-4 R1040E</p>  <p>S</p> <p>CLU-3 1040C</p>  <p>NP</p> <p>CLU-2 R1040C</p>  <p>S</p> <p>CLU-11 1040A</p> <p>FOR: MERCURY® FOR: MARINER OUTBOARDS®</p>	
	<p>FOR: CITROEN®</p>  <p>S</p> <p>NE-4 NE18</p>  <p>NE-4D</p>  <p>S</p> <p>NE-4.P</p>  <p>S</p> <p>NE-20.P3</p>  <p>S</p> <p>RO-61 62R</p>  <p>RO-41 R62UC</p>  <p>RO-21 R62Z</p>  <p>RO-6D 62U</p>  <p>RO-4D 62UC</p>  <p>RO-2D 62Z</p>				<p>FOR: D.K.W®</p>  <p>S</p> <p>NE-13 NE2</p> <p>FOR: FORD INTERNATIONAL®</p>  <p>S</p> <p>BL-11 BU1</p>  <p>BL-1D BU2</p>		<p>FOR: DAEWOO®</p>  <p>S</p> <p>DAE-1.P</p>  <p>NP</p> <p>DAE-2D</p>							
	<p>FOR: CITROEN®</p>  <p>S</p> <p>RO-5D L62UC</p> <p>FOR: PEUGEOT®</p>  <p>NS</p> <p>SIX-3.P</p>  <p>NS</p> <p>SIX-3.P1</p>  <p>NS</p> <p>SIX-3.P2</p>				<p>FOR: DAEWOO®</p>  <p>S</p> <p>DAE-2D.P</p>  <p>S</p> <p>DAE-3D</p> <p>FOR: DAIHATSU®</p>  <p>NP</p> <p>DAE-4.P1 DW05AP</p>  <p>NP</p> <p>DAE-4D.P1 DW05RAP</p>  <p>DAE-3D.P1</p>									

Concerning the marks and commercial denominations see note in index.

Concerniente a las marcas y denominaciones comerciales ver nota en indice.

Concernant les marques et denominations commerciales voir la note dans l'index.







Concerning the marks and commercial denominations see note in index.

Concerniente a las marcas y denominaciones comerciales ver nota en indice.

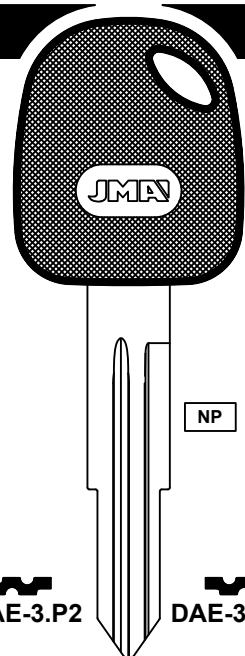
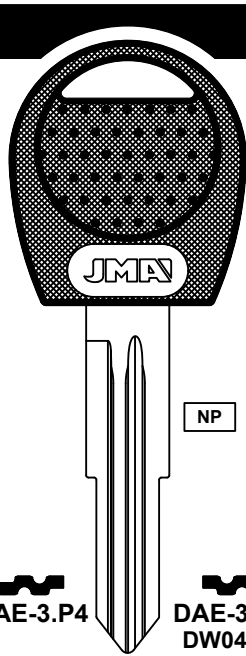
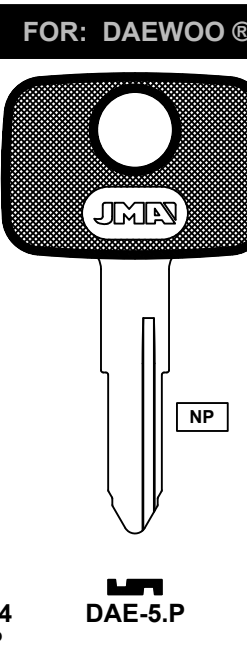
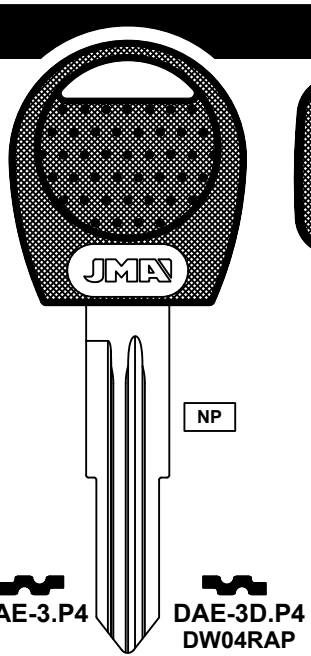
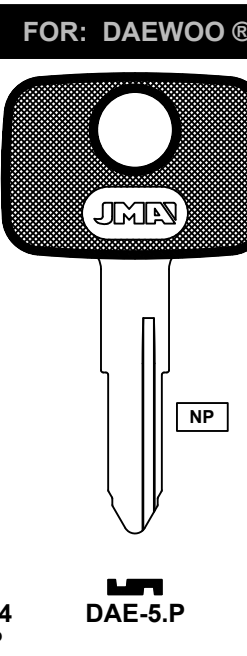
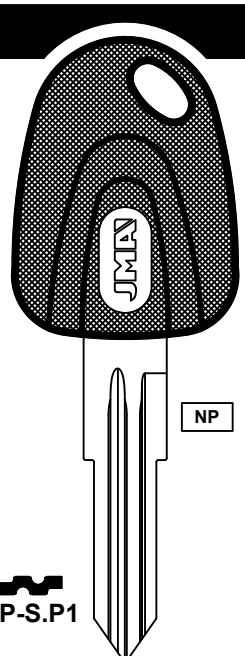
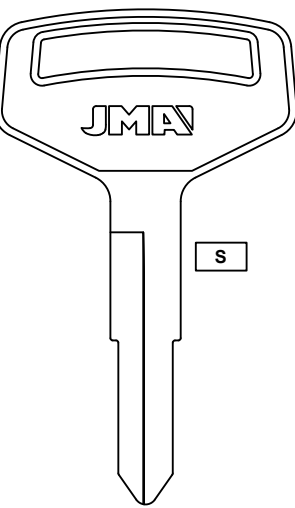
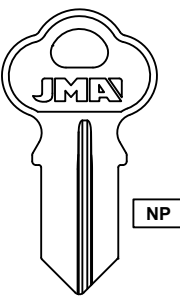
Concernant les marques et denominations commerciales voir la note dans l'index.

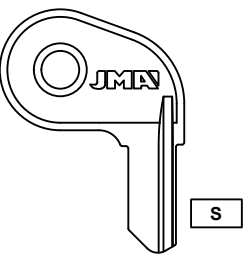
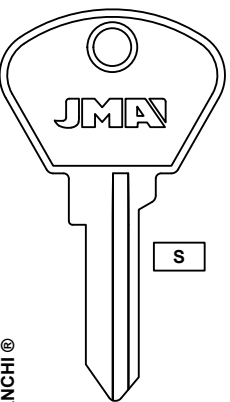
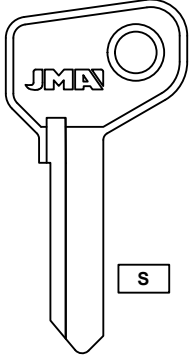
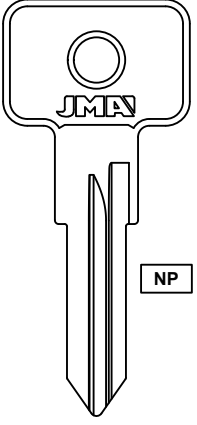
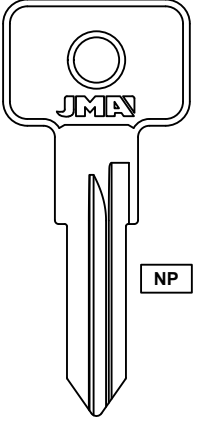
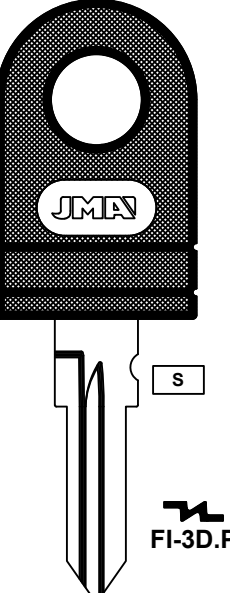
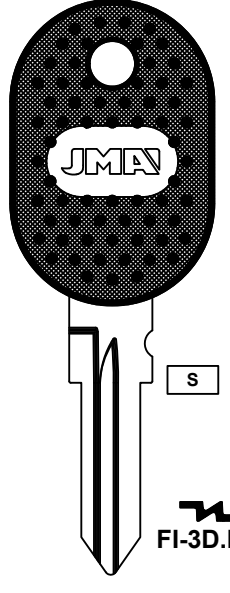
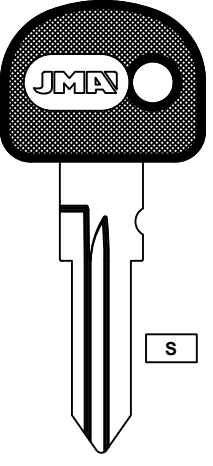
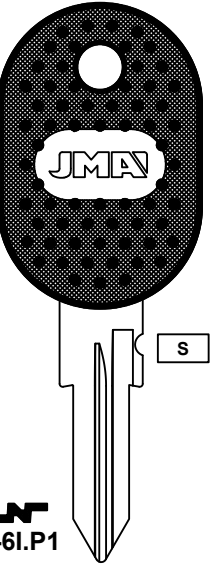
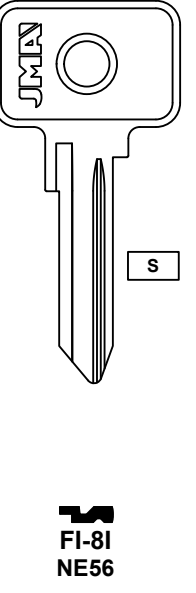
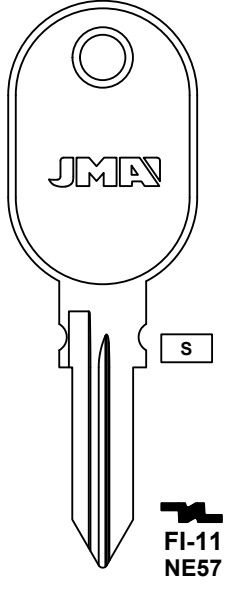
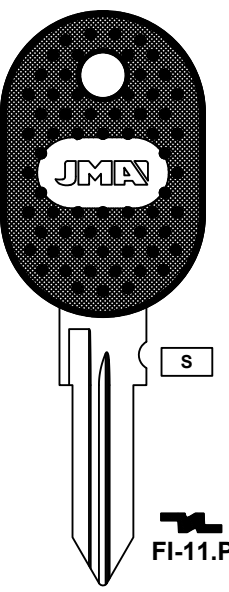
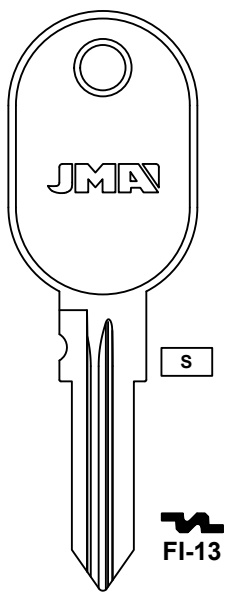
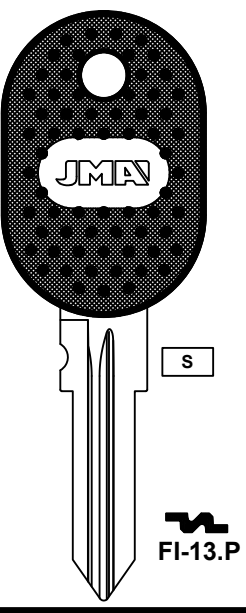
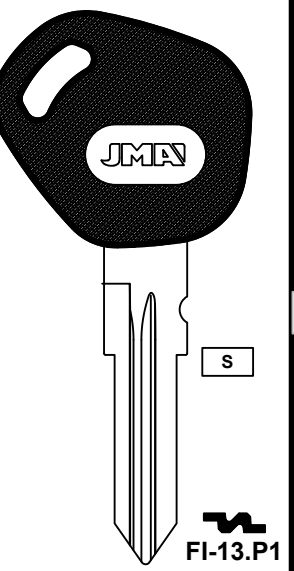
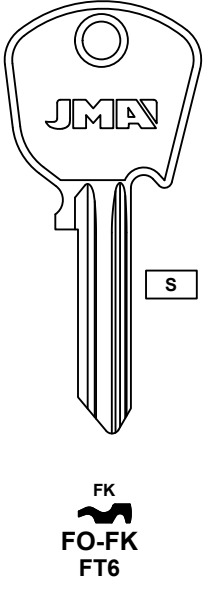
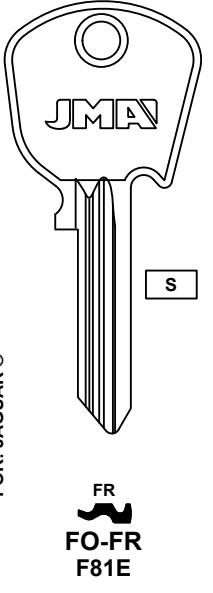
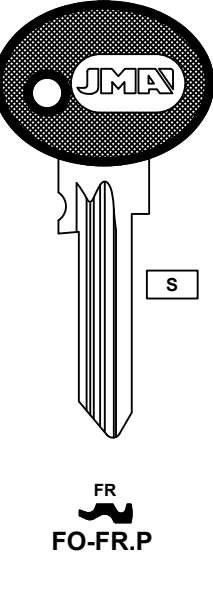
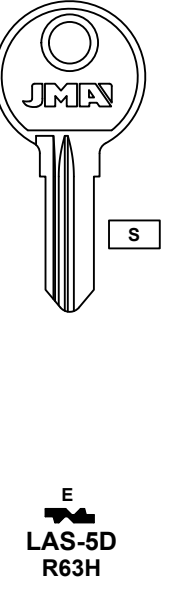

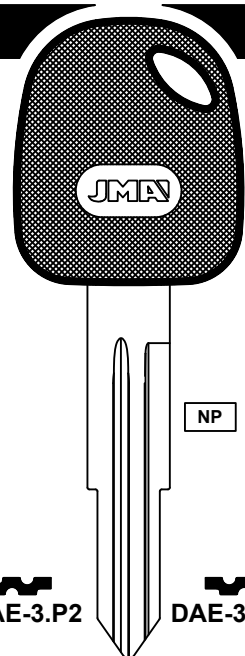
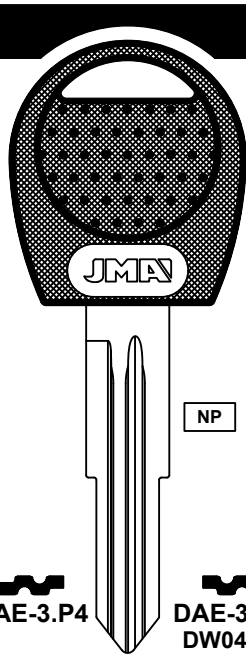
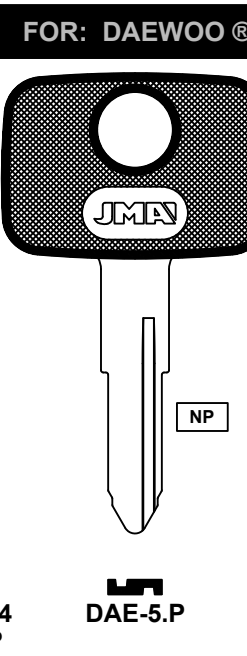
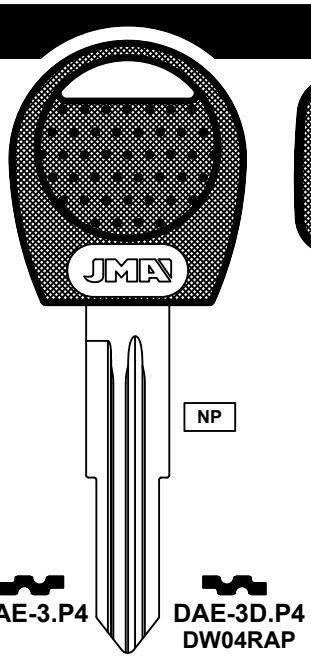
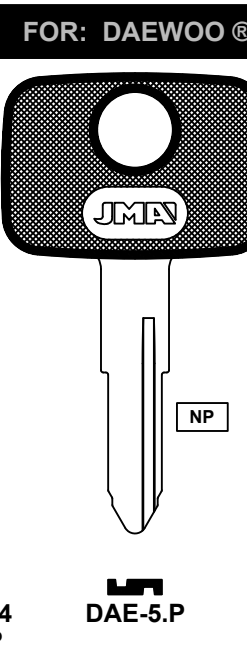
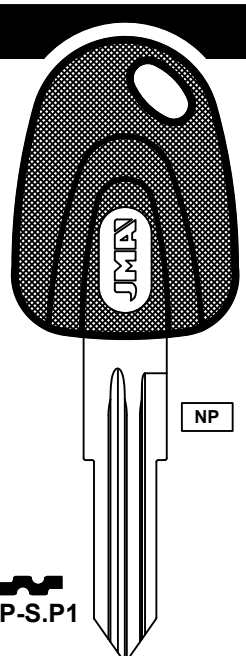
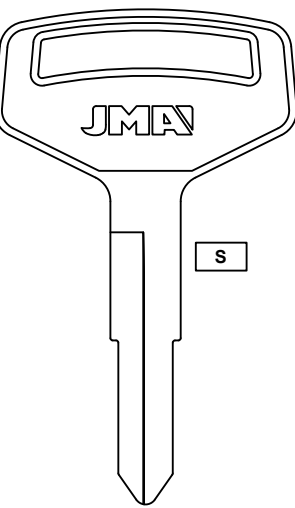
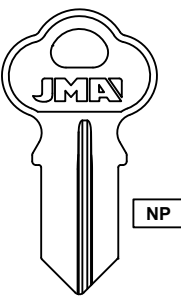
Z ZAMAK NS N. SILVER / ALPACA S STEEL / ACERO NE NEON NP NICKEL PLATED / LATON NIQUELADO CM FUN COLOR CK CRISTAL KEYS / PLASTICO COLOR A ALUMINUM / ALUMINIO B BRASS / LATON	FOR: DAEWOO®  DAE-3.P2  DAE-3D.P2  DAE-3.P4  DAE-3D.P4 DW04RAP  DAE-5.P  OP-S.P1			
	FOR: DAIHATSU®  DAI-2D	FOR: EVINRUDE MOTORS® FOR: JONHSTON MOTORS® FOR: OMC®  CHI-2 CG1  CHI-1 CG2 FOR: JONHSTON MOTORS® FOR: OMC®  PLL-1 OM10		FOR: FIAT® FOR: ALFA ROMEO® FOR: AUTOBIANCHI®  AF-71 F44
	FOR: FIAT®  CL-5D F54  FI-3  FI-3D NE54  FI-3D.P  FI-3D.P1			
	FOR: FIAT®  FI-3D.P3  FI-6I.P1  FI-8I NE56  FI-11 NE57			
FOR: FIAT®  FI-11.P  FI-13  FI-13.P  FI-13.P1				
FOR: FIAT®  FK FO-FK FT6 FOR: JAGUAR®  FR FO-FR F81E  FR FO-FR.P  E LAS-5D R63H				

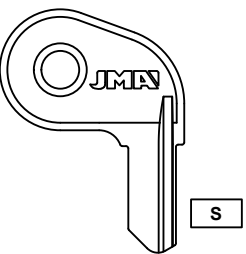
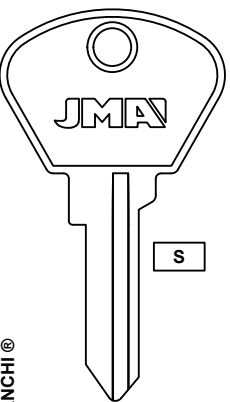
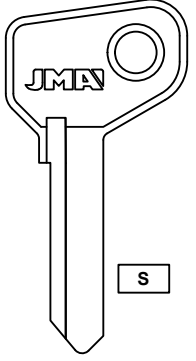
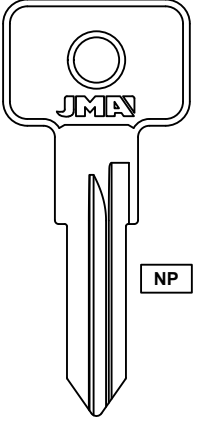
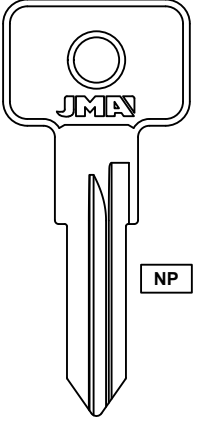
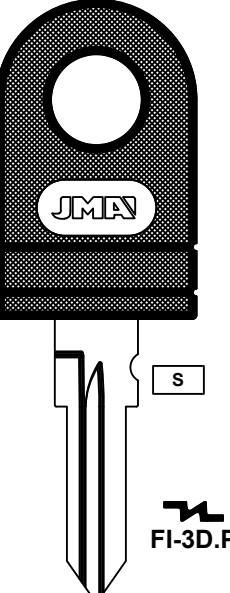
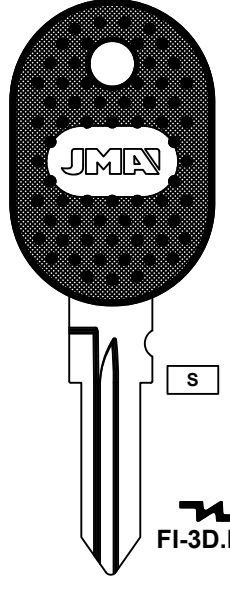
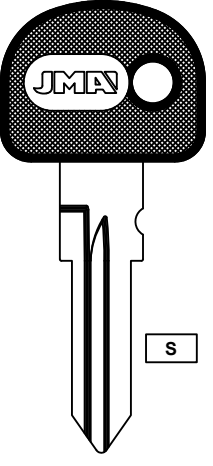
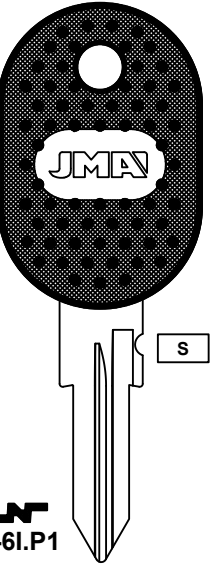
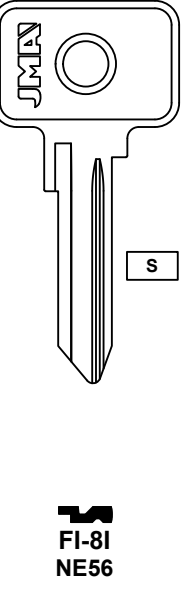
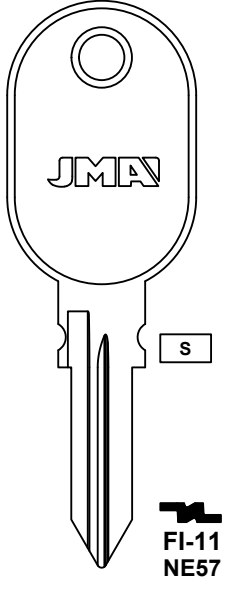
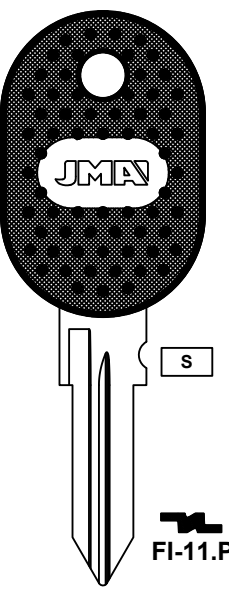
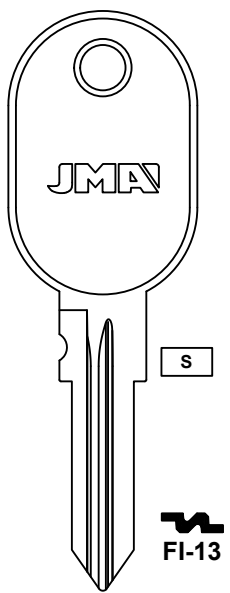
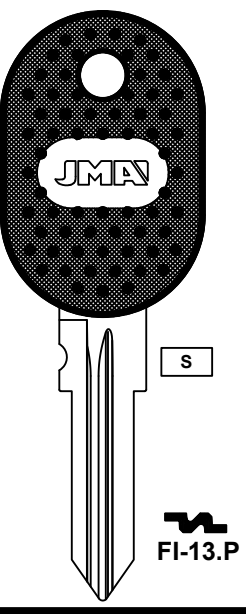
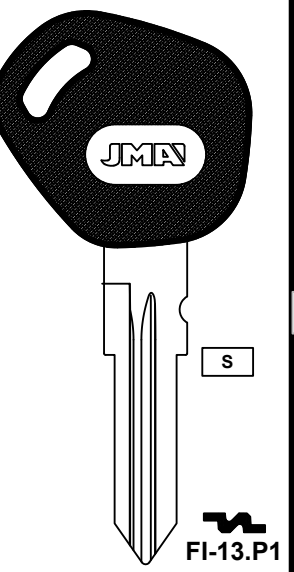
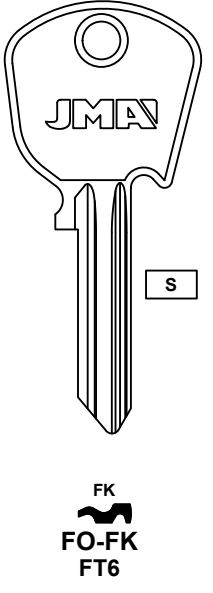
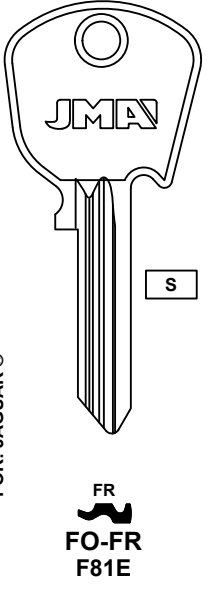
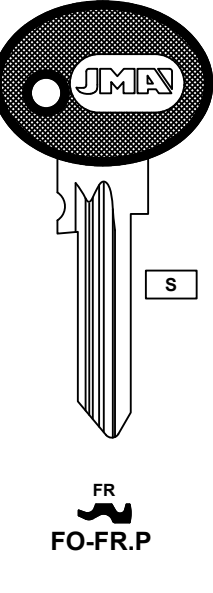
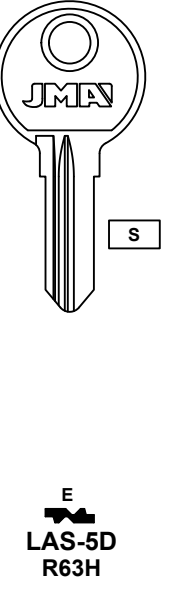
Z ZAMAK NS N. SILVER / ALPACA S STEEL / ACERO NE NEON NP NICKEL PLATED / LATON NIQUELADO CM FUN COLOR CK CRISTAL KEYS / PLASTICO COLOR A ALUMINUM / ALUMINIO B BRASS / LATON	FOR: DAEWOO®  DAE-3.P2  DAE-3D.P2  DAE-3.P4  DAE-3D.P4 DW04RAP  DAE-5.P  OP-S.P1			
	FOR: DAIHATSU®  DAI-2D	FOR: EVINRUDE MOTORS® FOR: JONHSTON MOTORS® FOR: OMC®  CHI-2 CG1  CHI-1 CG2 FOR: JONHSTON MOTORS® FOR: OMC®  PLL-1 OM10		FOR: FIAT® FOR: ALFA ROMEO® FOR: AUTOBIANCHI®  AF-71 F44
	FOR: FIAT®  CL-5D F54  FI-3  FI-3D NE54  FI-3D.P  FI-3D.P1			
	FOR: FIAT®  FI-3D.P3  FI-6I.P1  FI-8I NE56  FI-11 NE57			
FOR: FIAT®  FI-11.P  FI-13  FI-13.P  FI-13.P1				
FOR: FIAT®  FK FO-FK FT6 FOR: JAGUAR®  FR FO-FR F81E  FR FO-FR.P  E LAS-5D R63H				

Concerning the marks and commercial denominations see note in index.

Concerniente a las marcas y denominaciones comerciales ver nota en indice.

Concernant les marques et denominations commerciales voir la note dans l'index.



Concerning the marks and commercial denominations see note in index.

Concerniente a las marcas y denominaciones comerciales ver nota en indice.

Concernant les marques et denominations commerciales voir la note dans l'index.

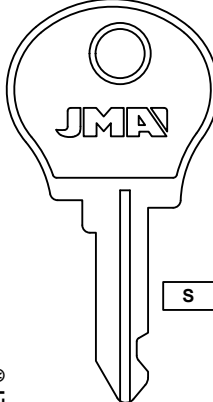
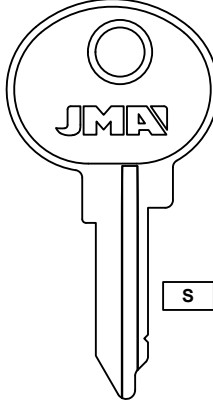
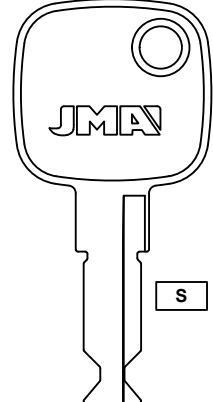
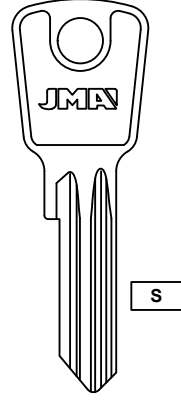
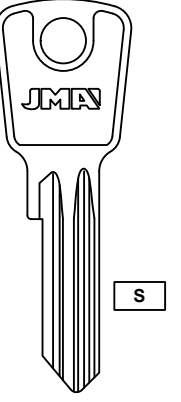
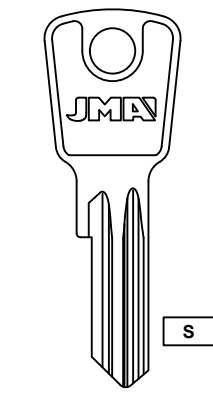
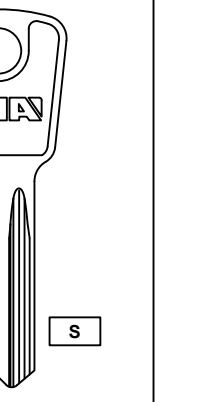
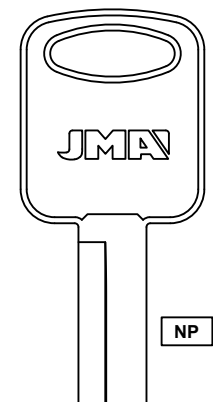
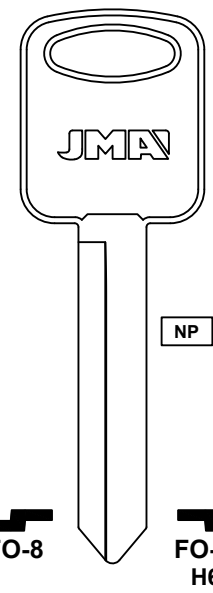
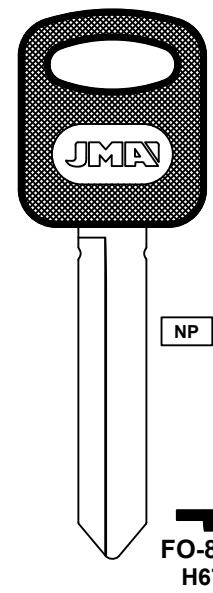
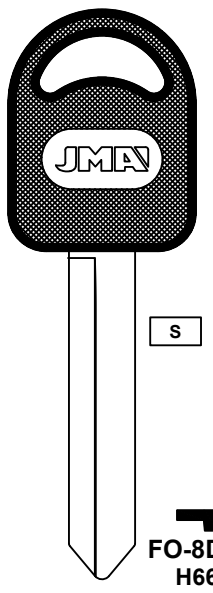
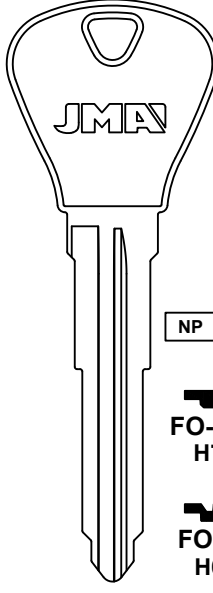
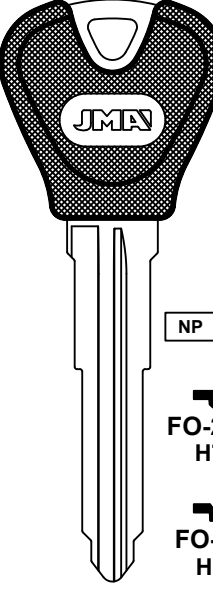
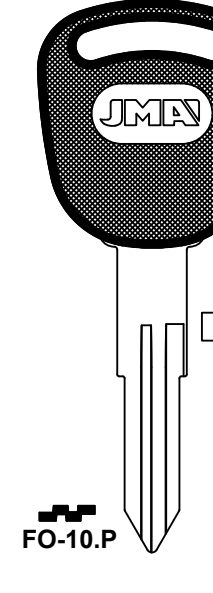
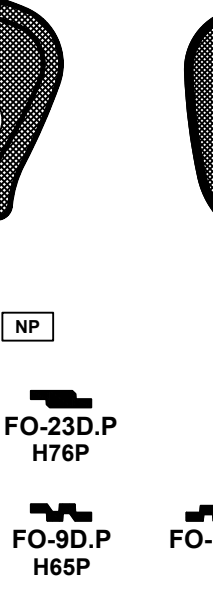
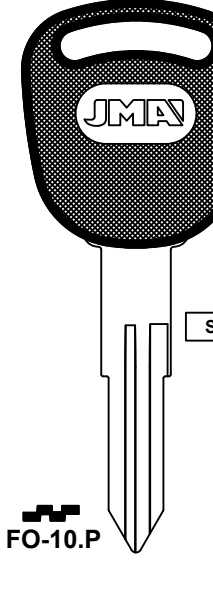
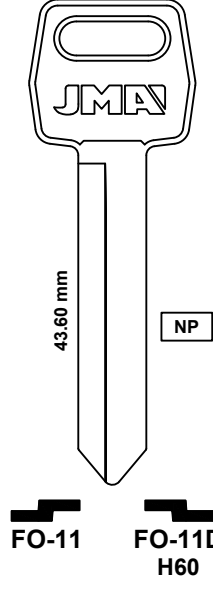
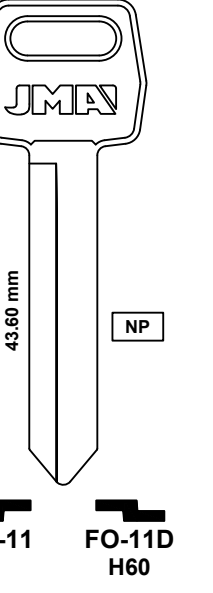

Z ZAMAK NS N. SILVER / ALPACA S STEEL / ACERO NE NEON NP NICKEL PLATED / LATON NIQUELADO FUN COLOR CM CRISTAL KEYS / PLASTICO COLOR AL ALUMINUM / ALUMINIO B BRASS / LATON	FOR: FIAT®					
	 <p>NE-151 NE13</p>	 <p>NE-37 NE9</p>	 <p>NE-47</p>	 <p>WAS-71 WS4</p>	 <p>WAS-7D WS2</p>	
	FOR: RENAULT®					
FOR: FIAT®		FOR: FORD®				
 <p>WAS-9 WS1</p>	 <p>WAS-9D WS3</p>	 <p>FO-8</p>	 <p>FO-8D H67</p>	 <p>FO-8D.P H67P</p>	 <p>FO-8D.P1 H66P</p>	
FOR: FORD®						
 <p>FO-23D H76</p>	 <p>FO-23D.P H76P</p>	 <p>FO-9D H65</p>	 <p>FO-9D.P H65P</p>	 <p>FO-10.P</p>	 <p>FO-11</p>	 <p>FO-11D H60</p>

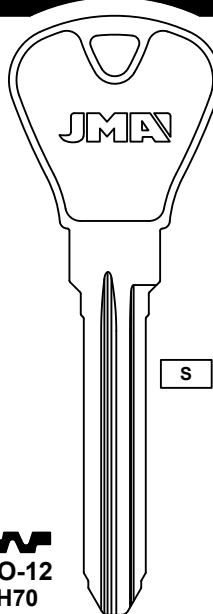
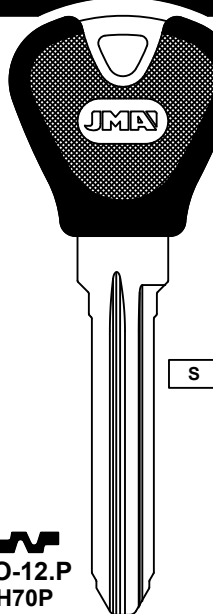
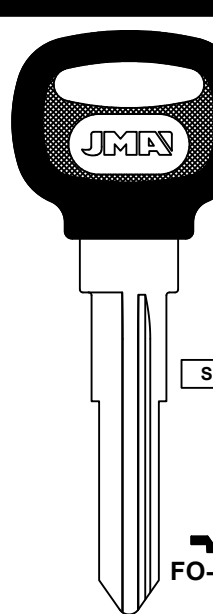
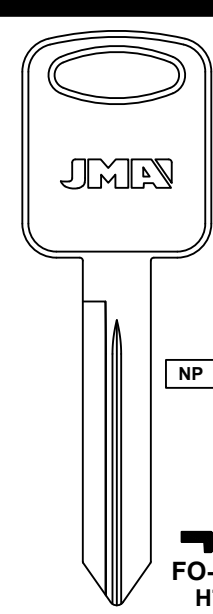
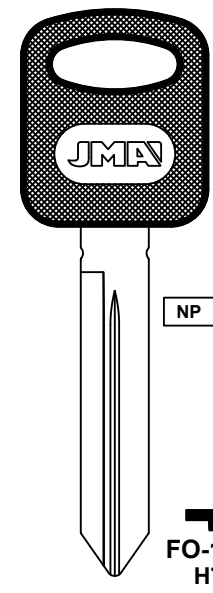
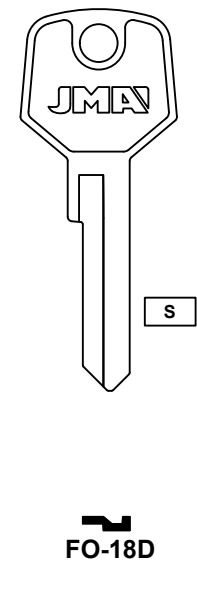
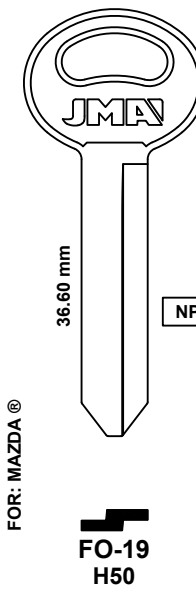
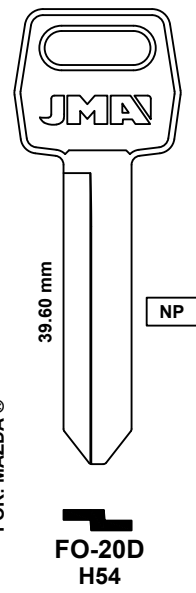
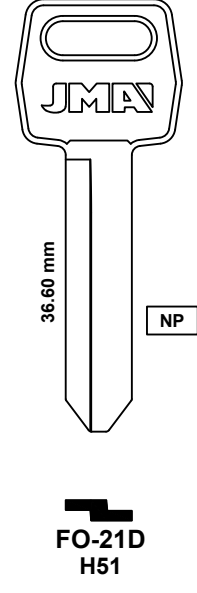
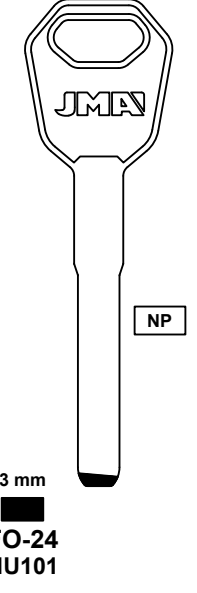
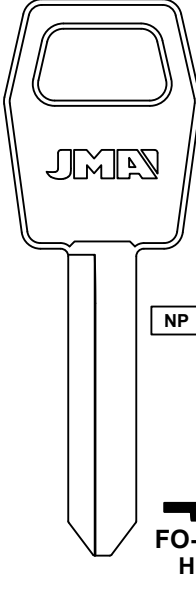
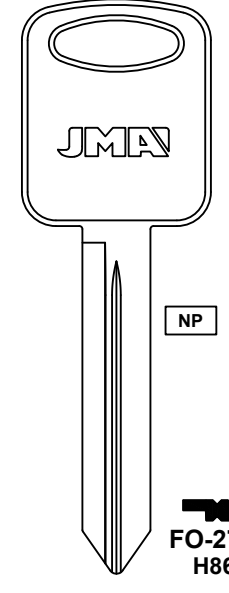
Z ZAMAK NS N. SILVER / ALPACA S STEEL / ACERO NE NEON NP NICKEL PLATED / LATON NIQUELADO FUN COLOR CM CRISTAL KEYS / PLASTICO COLOR AL ALUMINUM / ALUMINIO B BRASS / LATON	FOR: FORD®				
	 <p>FO-12 H70</p>	 <p>FO-12.P H70P</p>	 <p>FO-13D.P</p>	 <p>FO-15D H75</p>	
	FOR: FORD®				
FOR: FORD®		FOR: FORD®			
 <p>FO-15D.P H75P</p>	 <p>FO-18D</p>	 <p>FO-19 H50</p>	 <p>FO-20D H54</p>		
FOR: FORD®					
 <p>FO-21D H51</p>	 <p>FO-24 HU101</p>	 <p>FO-26D H55</p>	 <p>FO-27D H86</p>		



Concerning the marks and commercial denominations see note in index.

Concerniente a las marcas y denominaciones comerciales ver nota en indice.

Concernant les marques et denominations commerciales voir la note dans l'index.



Concerning the marks and commercial denominations see note in index.

Concerniente a las marcas y denominaciones comerciales ver nota en indice.

Concernant les marques et denominations commerciales voir la note dans l'index.



Z ZAMAK
NS N. SILVER / ALPACA
S STEEL / ACERO
NE NEON
NP NICKEL PLATED / LATON NIQUELADO
CM FUN COLOR
CK CRISTAL KEYS / PLASTICO COLOR
A ALUMINIUM / ALUMINIO
B BRASS / LATON

Z ZAMAK
NS N. SILVER / ALPACA
S STEEL / ACERO
NE NEON
NP NICKEL PLATED / LATON NIQUELADO
CM FUN COLOR
CK CRISTAL KEYS / PLASTICO COLOR
A ALUMINIUM / ALUMINIO
B BRASS / LATON

FOR: FORD®

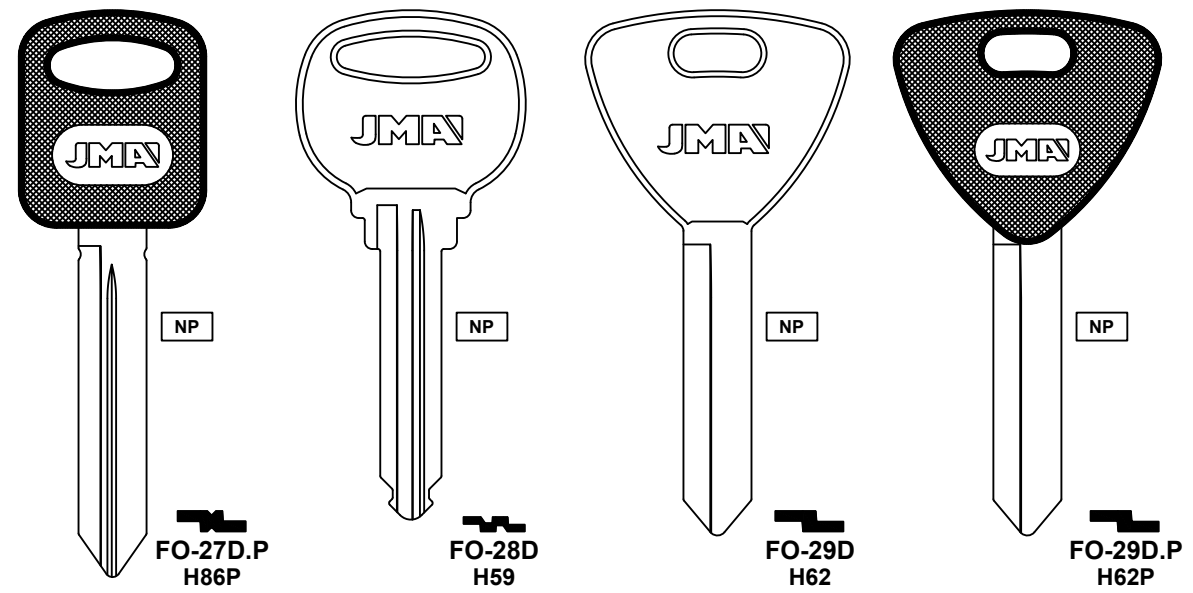

FOR: FORD®

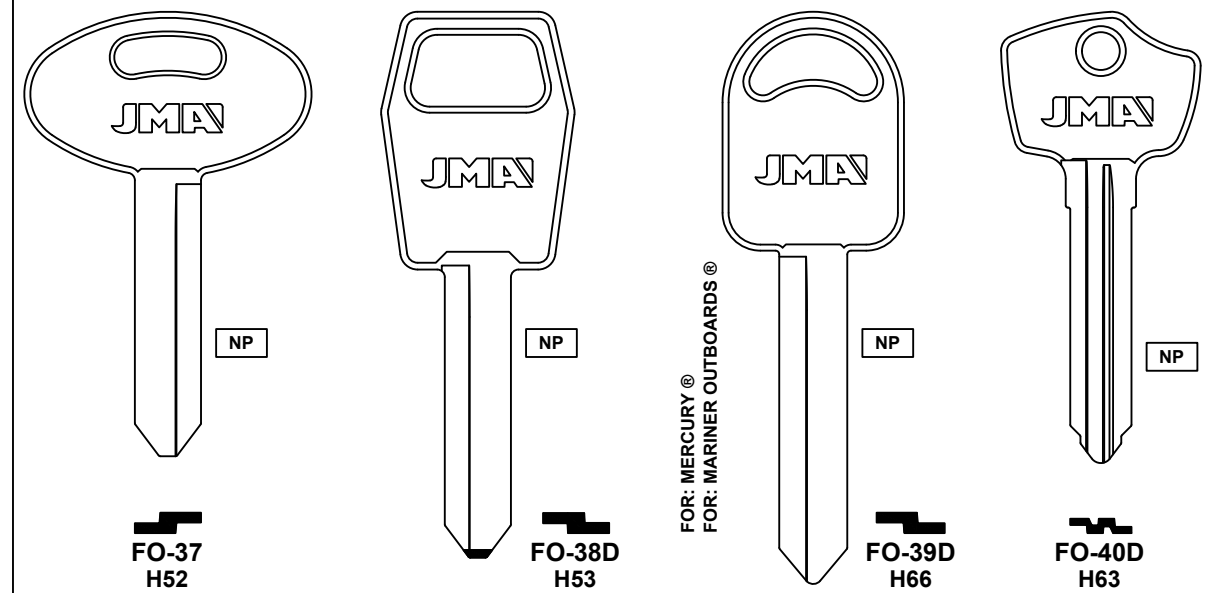

FOR: FORD®

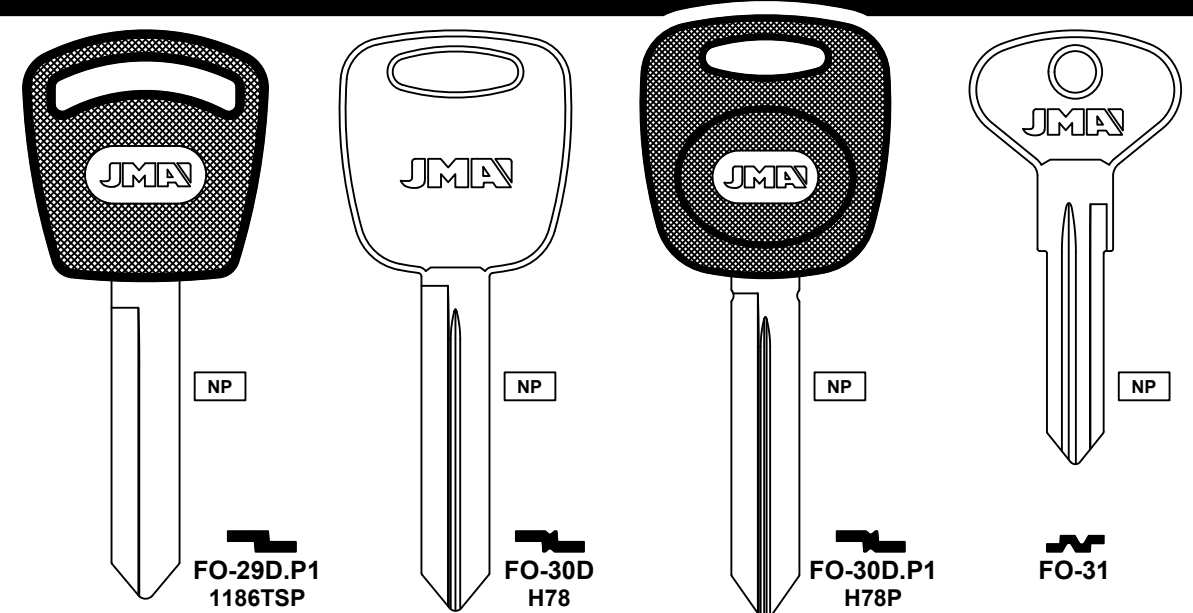

FOR: FORD®

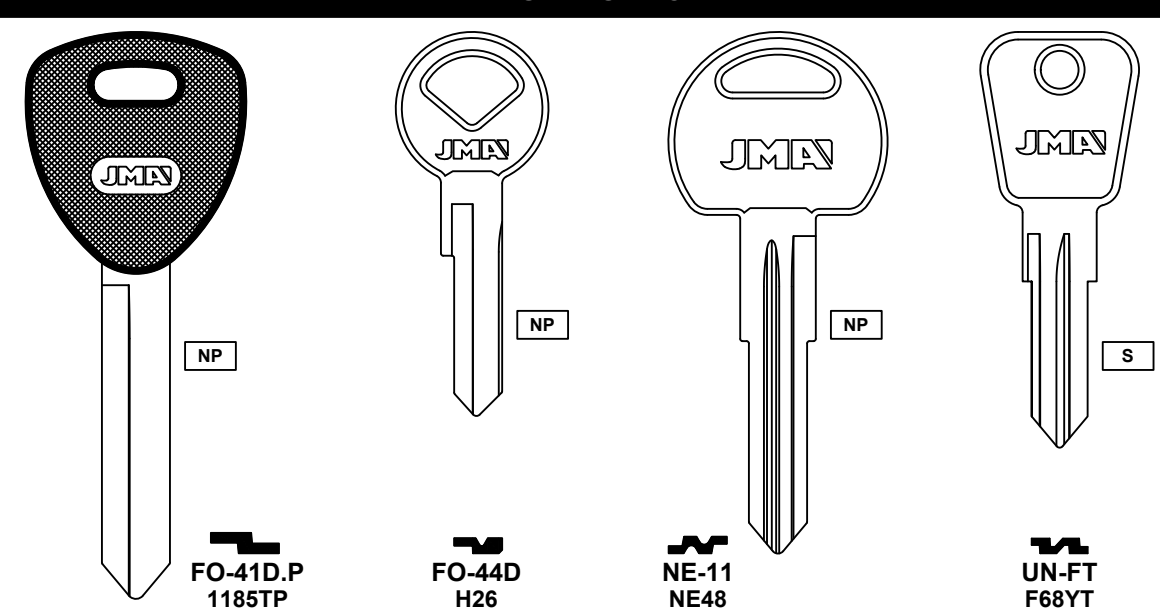

FOR: FORD®

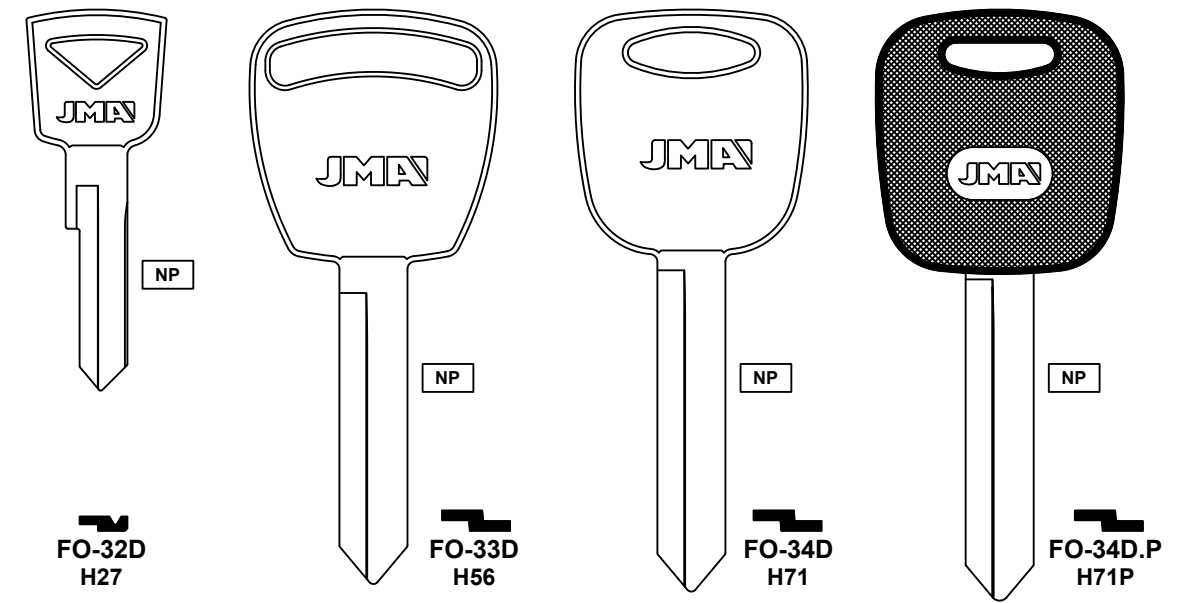

FOR: FORD INTERNATIONAL®

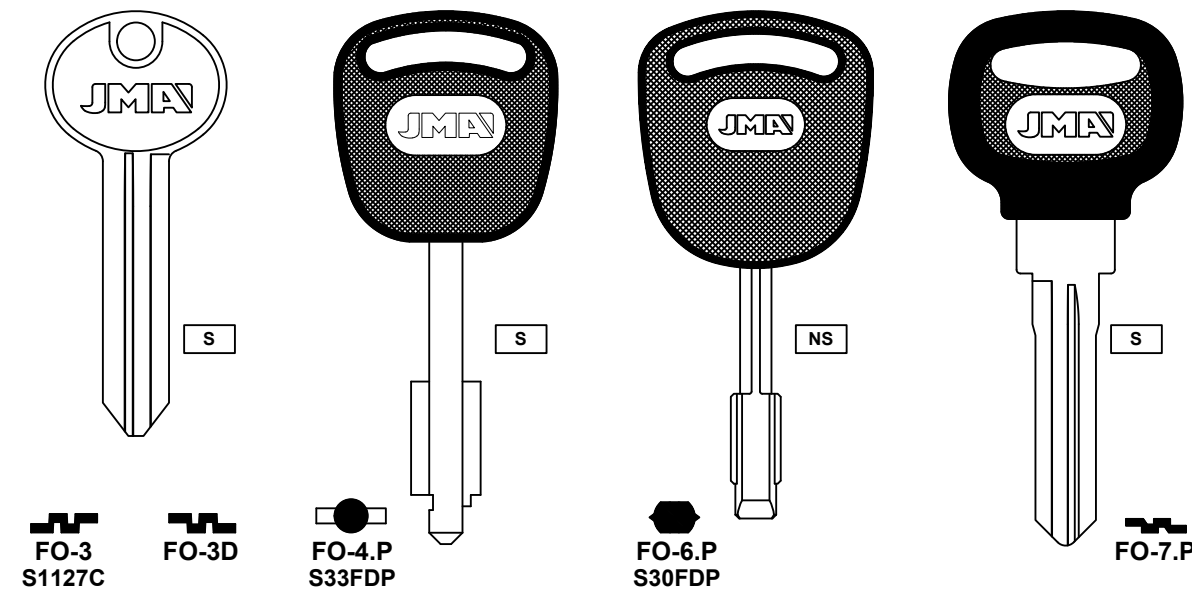

Concerning the marks and commercial denominations see note in index.

Concerniente a las marcas y denominaciones comerciales ver nota en indice.

Concernant les marques et denominations commerciales voir la note dans l'index.



Concerning the marks and commercial denominations see note in index.

Concerniente a las marcas y denominaciones comerciales ver nota en indice.

Concernant les marques et denominations commerciales voir la note dans l'index.



<p>Z ZAMAK</p> <p>NS N. SILVER / ALPACA</p> <p>S STEEL / ACERO</p> <p>NE NEON</p> <p>NP NICKEL PLATED / LATON NIQUELADO</p> <p>FM FUN COLOR</p> <p>CK CRISTAL KEYS / PLASTICO COLOR</p> <p>GM ALUMINUM / ALUMINIO</p> <p>B BRASS / LATON</p>	<p>FOR: FORD INTERNATIONAL®</p>				<p>FOR: FORD INTERNATIONAL®</p>		<p>FOR: FORD TRACTOR®</p>		<p>FOR: FORD TRUCK COVER®</p>			
	<p>FOR: FORD INTERNATIONAL®</p>				<p>FOR: FREIGHTLINER®</p>							
	<p>FOR: FORD INTERNATIONAL®</p>				<p>FOR: FREIGHTLINER®</p>		<p>FOR: GAS®</p>					

Concerning the marks and commercial denominations see note in index.

Concerniente a las marcas y denominaciones comerciales ver nota en indice.

Concernant les marques et denominations commerciales voir la note dans l'index.



Concerning the marks and commercial denominations see note in index.

Concerniente a las marcas y denominaciones comerciales ver nota en indice.

Concernant les marques et denominations commerciales voir la note dans l'index.



Z ZAMAK
NS N. SILVER / ALPACA
S STEEL / ACERO
NE NEON
NP NICKEL PLATED / LATON NIQUELADO
FM FUN COLOR
CK CRISTAL KEYS / PLASTICO COLOR
GM ALUMINUM / ALUMINIO
CK BRASS / LATON
A ALUMINUM / ALUMINIO
B BRASS / LATON

Z ZAMAK
NS N. SILVER / ALPACA
S STEEL / ACERO
NE NEON
NP NICKEL PLATED / LATON NIQUELADO
FM FUN COLOR
CK CRISTAL KEYS / PLASTICO COLOR
GM ALUMINUM / ALUMINIO
CK BRASS / LATON
A ALUMINUM / ALUMINIO
B BRASS / LATON

FOR: GAS®

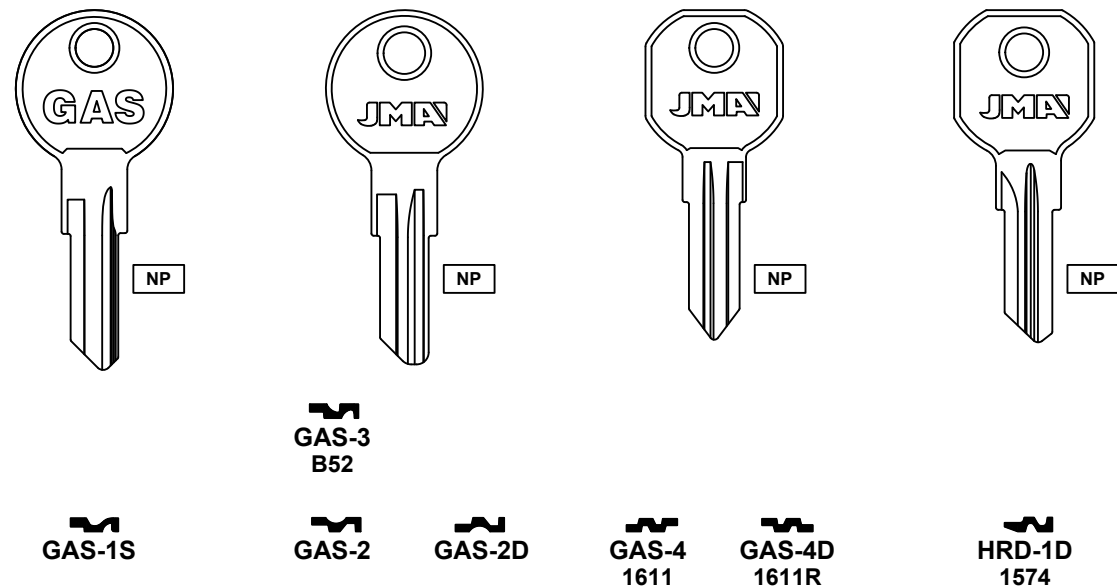

FOR: GAS®

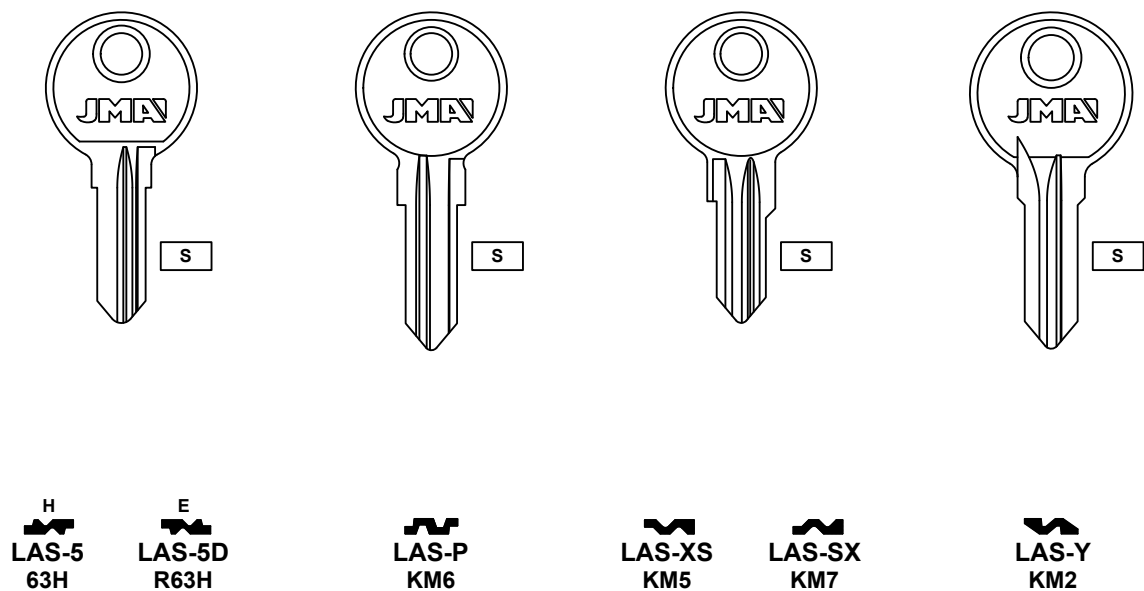

FOR: GAS®

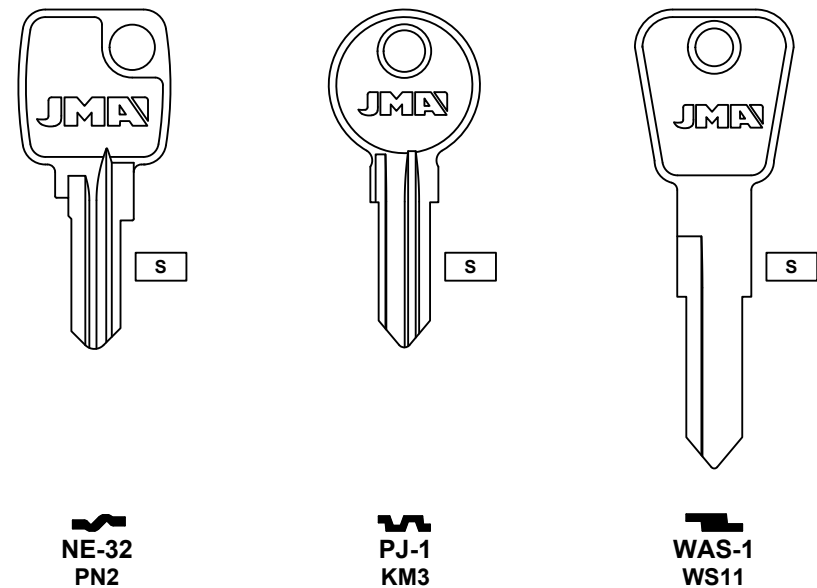

FOR: GENERAL MOTORS®

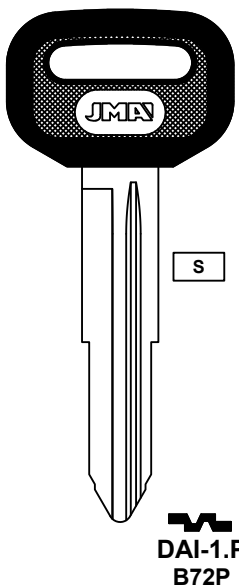

FOR: GENERAL MOTORS®

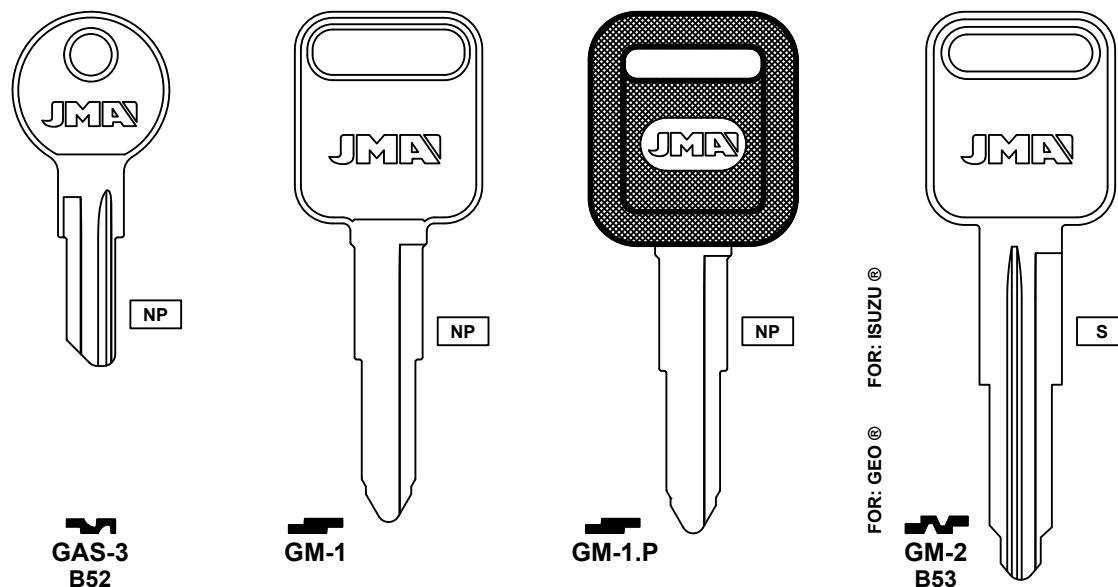

FOR: GENERAL MOTORS®

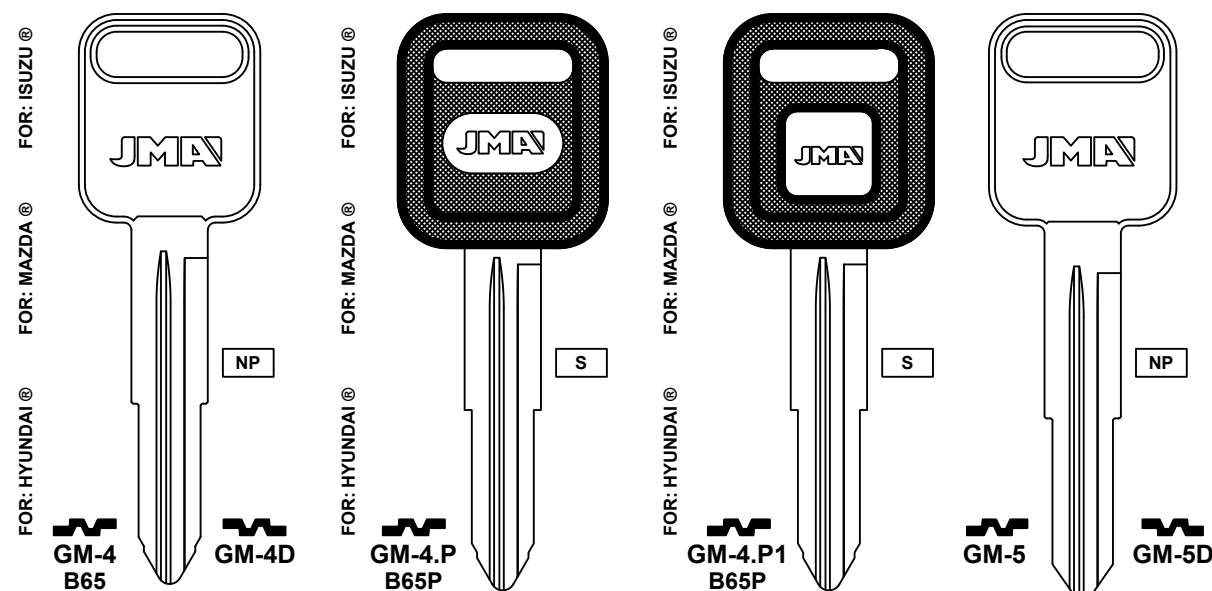

FOR: GENERAL MOTORS®

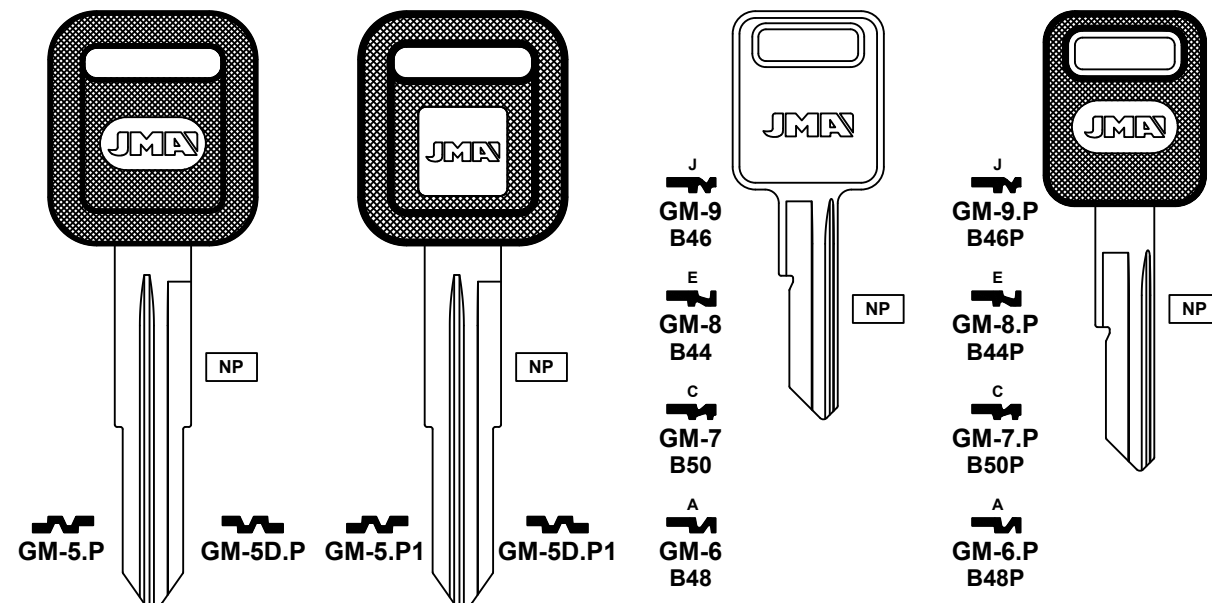

Concerning the marks and commercial denominations see note in index.

Concerniente a las marcas y denominaciones comerciales ver nota en indice.

Concernant les marques et denominations commerciales voir la note dans l'index.



Concerning the marks and commercial denominations see note in index.

Concerniente a las marcas y denominaciones comerciales ver nota en indice.

Concernant les marques et denominations commerciales voir la note dans l'index.



Z ZAMAK
NS N. SILVER / ALPACA **S** STEEL / ACERO
NE NEON **NP** NICKEL PLATED / LATON NIQUELADO
GM FUN COLOR **CK** CRISTAL KEYS / PLASTICO COLOR
A ALUMINUM / ALUMINIO **B** BRASS / LATON

Z ZAMAK
NS N. SILVER / ALPACA **S** STEEL / ACERO
NE NEON **NP** NICKEL PLATED / LATON NIQUELADO
GM FUN COLOR **CK** CRISTAL KEYS / PLASTICO COLOR
A ALUMINUM / ALUMINIO **B** BRASS / LATON

FOR: GENERAL MOTORS®

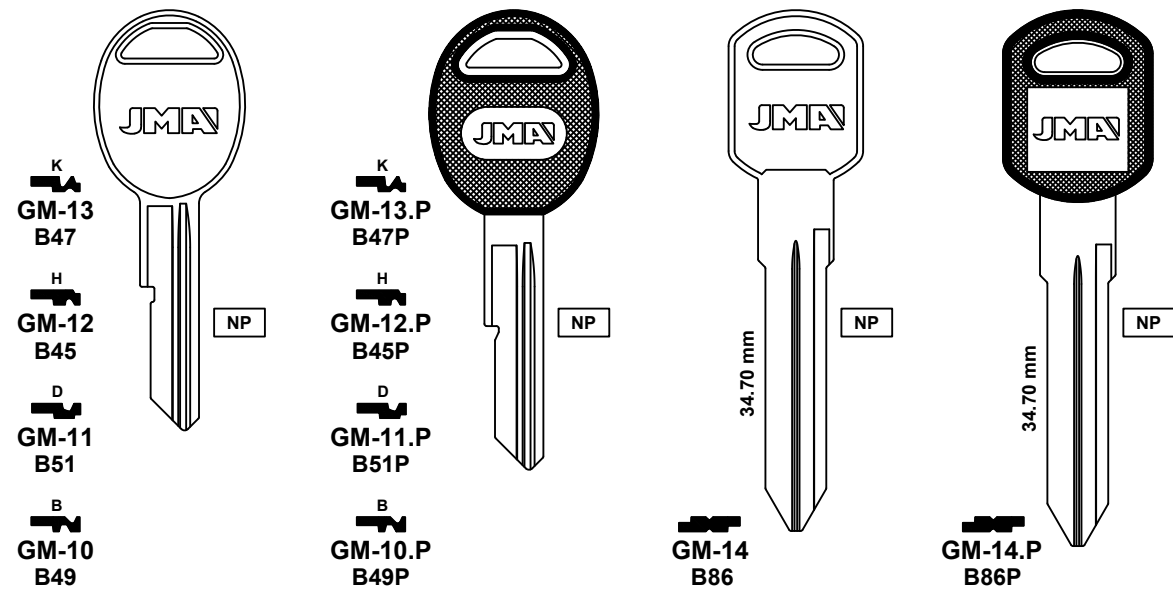

FOR: GENERAL MOTORS®

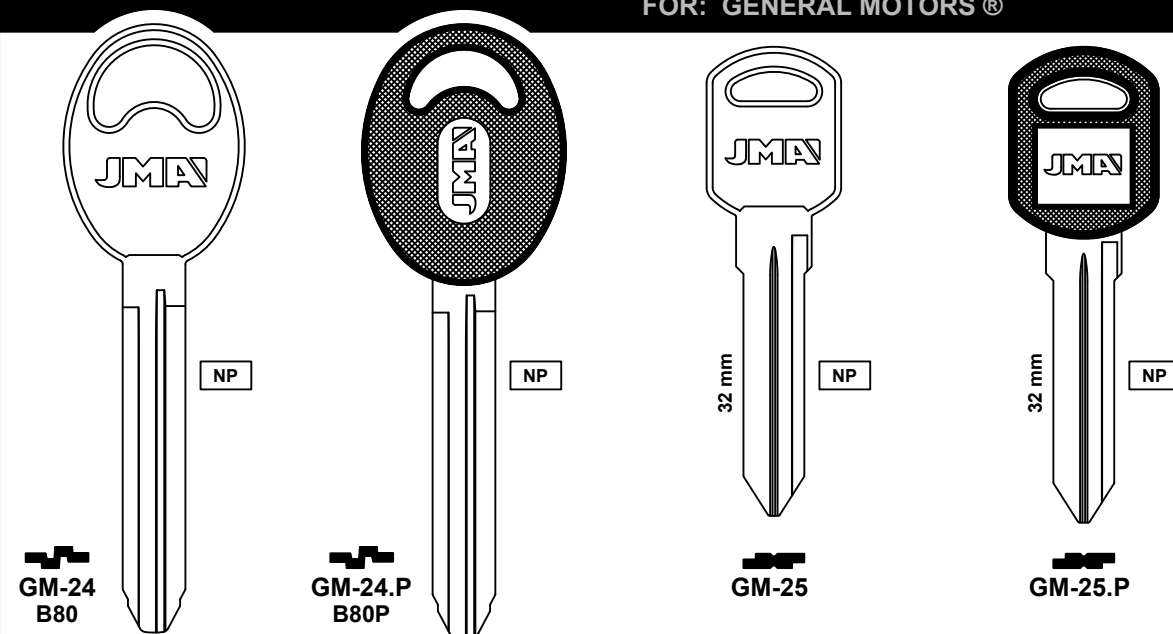

FOR: GENERAL MOTORS®

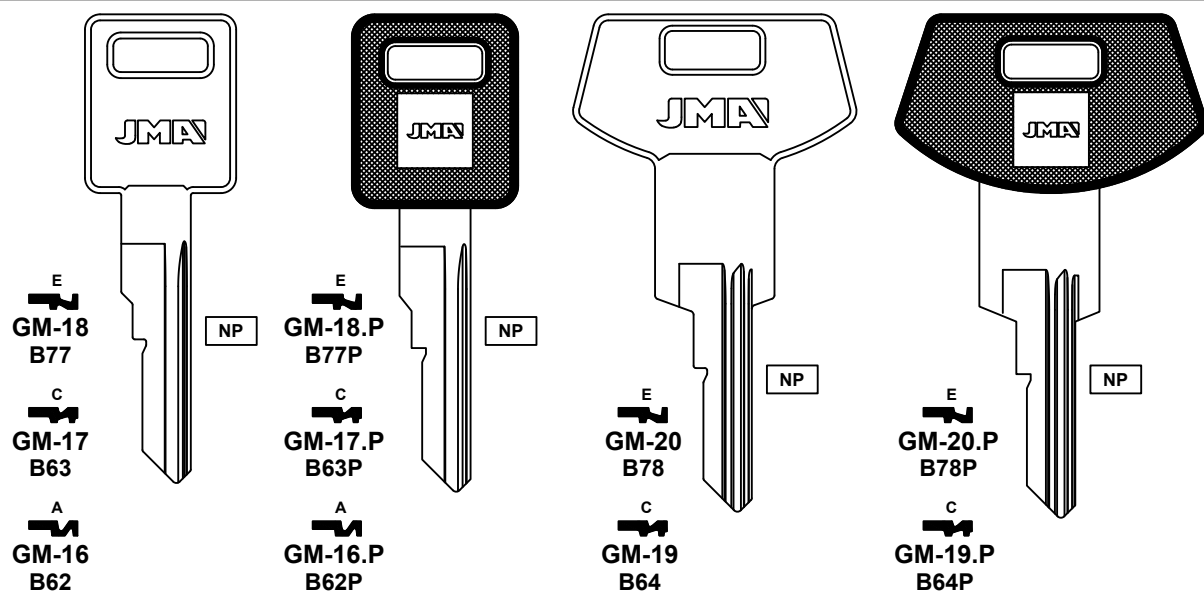

FOR: GENERAL MOTORS®

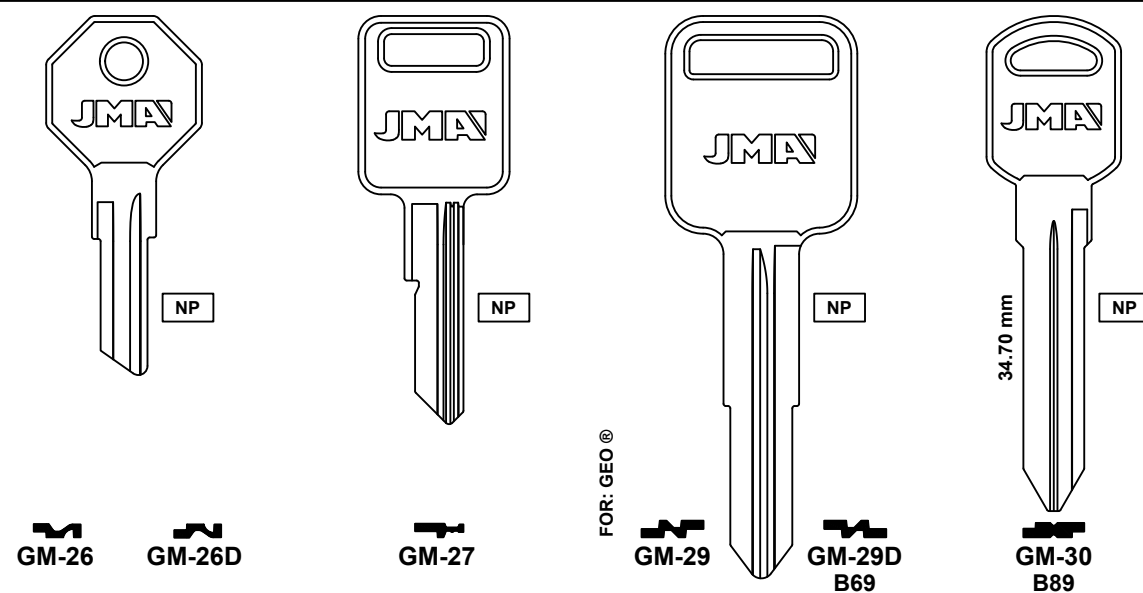

FOR: GENERAL MOTORS®

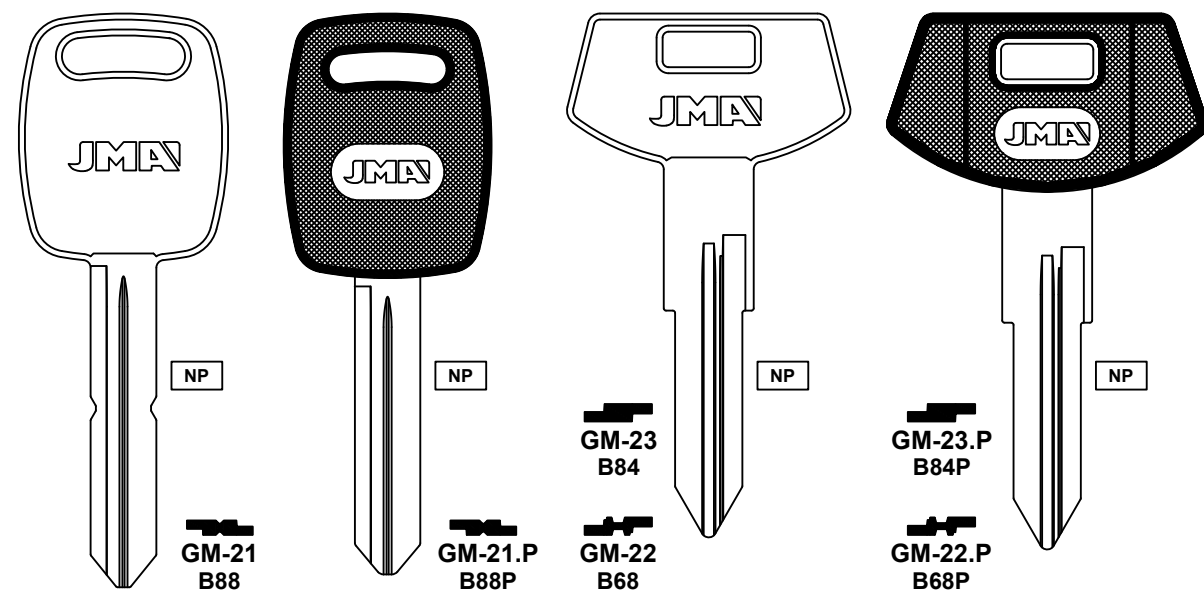

FOR: GENERAL MOTORS®

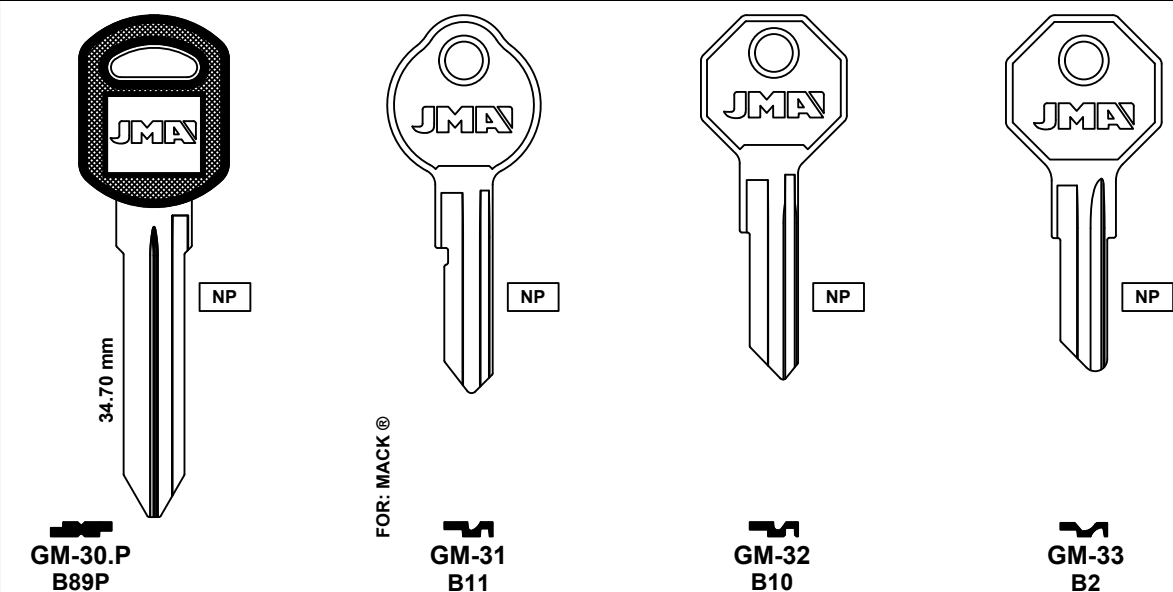

! Concerning the marks and commercial denominations see note in index.

Concerniente a las marcas y denominaciones comerciales ver nota en indice.

Concernant les marques et denominations commerciales voir la note dans l'index.



! Concerning the marks and commercial denominations see note in index.

Concerniente a las marcas y denominaciones comerciales ver nota en indice.

Concernant les marques et denominations commerciales voir la note dans l'index.

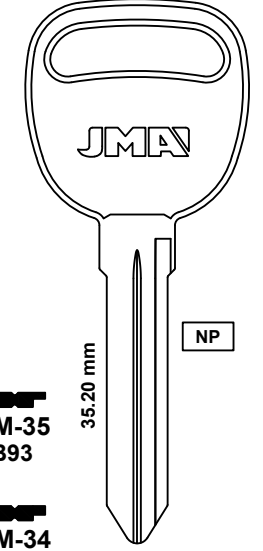
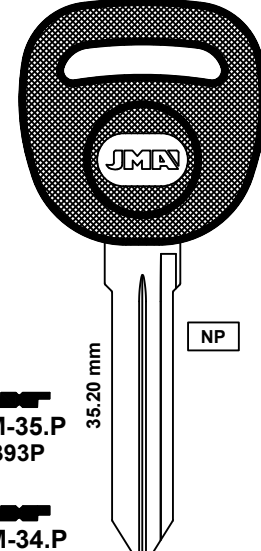
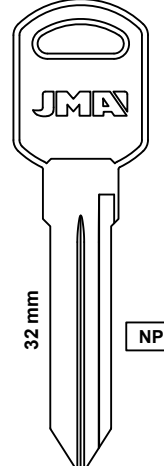
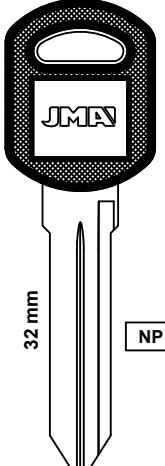

FOR: GENERAL MOTORS ®

			
GM-35 B93	GM-35.P B93P	GM-36 B92	GM-36.P B92P
35.20 mm	35.20 mm	32 mm	32 mm
NP	NP	NP	NP

FOR: GENERAL MOTORS ®

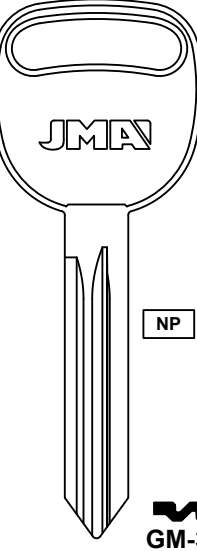
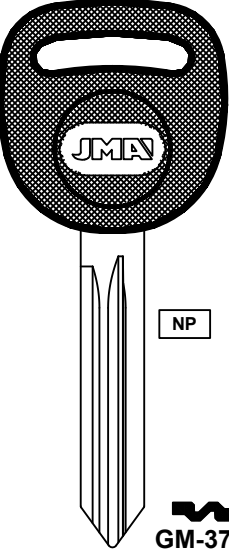
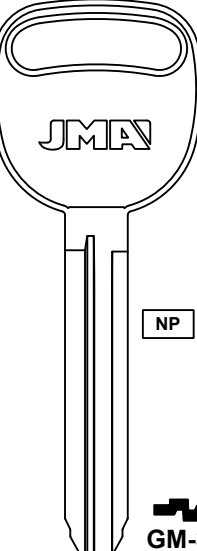
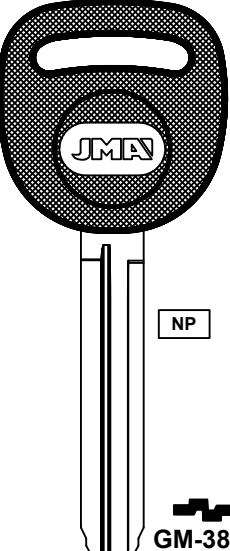
			
GM-37 B106	GM-37.P B106P	GM-38 B110	GM-38.P B110P
NP	NP	NP	NP

FOR: GENERAL MOTORS ®

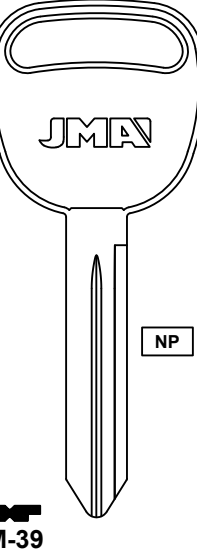
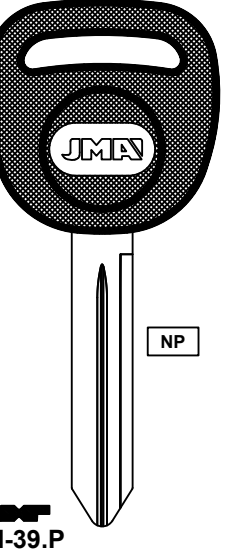
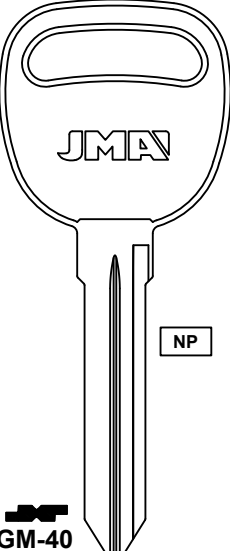
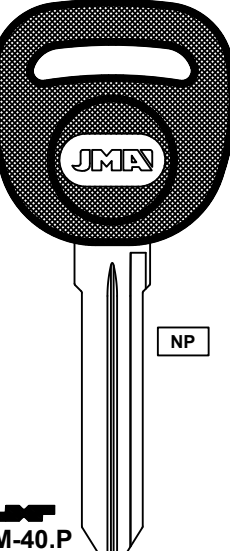
			
GM-39 B102	GM-39.P B102P	GM-40 B96	GM-40.P B96P
NP	NP	FOR: SATURN ®	FOR: SATURN ®

Z ZAMAK

NS N. SILVER / ALPACA

S STEEL / ACERO

NE NEON

NP NICKEL PLATED / LATON NIQUELADO

GM FUN COLOR

CK CRISTAL KEYS / PLASTICO COLOR

A ALUMINUM / ALUMINIO

B BRASS / LATON

Z ZAMAK

NS N. SILVER / ALPACA

S STEEL / ACERO

NE NEON

NP NICKEL PLATED / LATON NIQUELADO

GM FUN COLOR

CK CRISTAL KEYS / PLASTICO COLOR

A ALUMINUM / ALUMINIO

B BRASS / LATON

FOR: GENERAL MOTORS ®

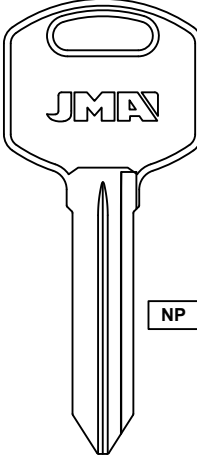
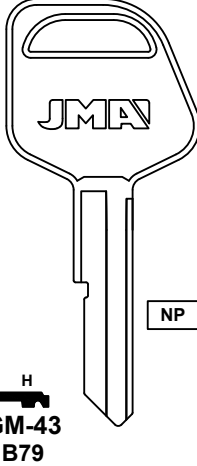
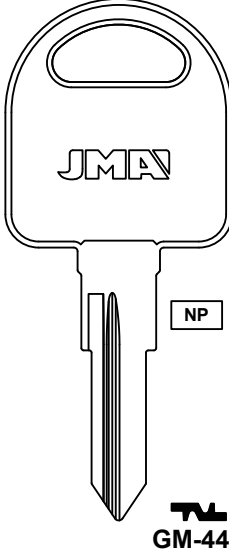
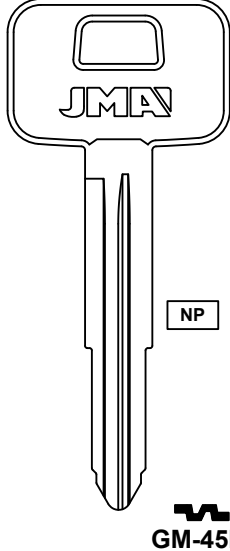
			
GM-41 B85	GM-43 B79	GM-42D B67	GM-44D B59
NP	NP	NP	NP

FOR: GENERAL MOTORS ®

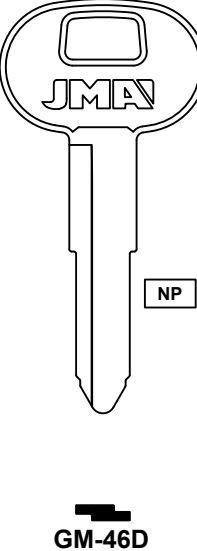
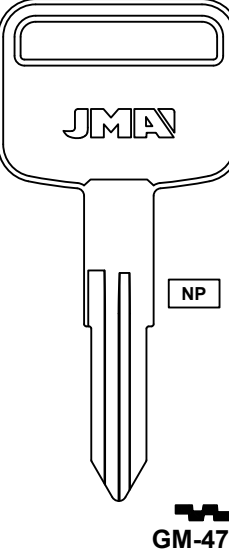
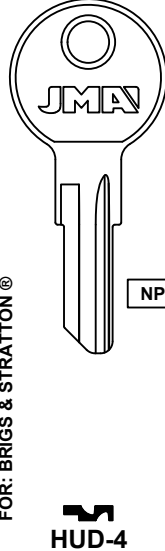
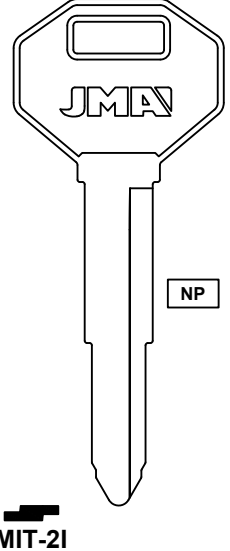
			
GM-46D B56	GM-47D B54	HUD-4 1098X	MIT-21 DC3
FOR: TOYOTA ®	NP	FOR: BRIGGS & STRATTON ®	NP

FOR: GENERAL MOTORS ®

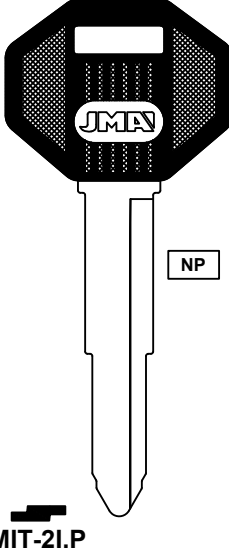
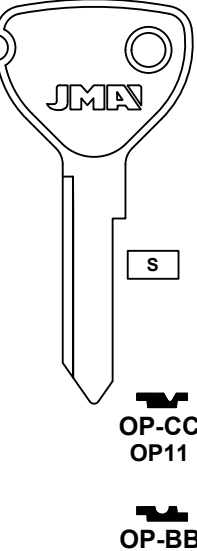
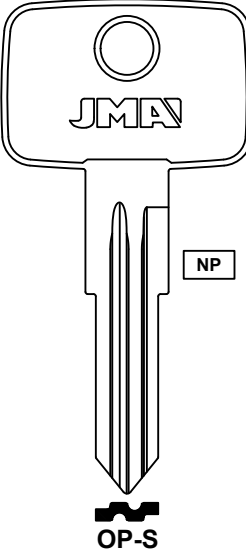
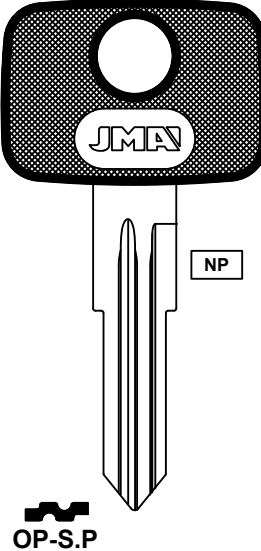
			
MIT-21.P DC3P	OP-CC OP11	OP-S B61	OP-S.P
NP	S	NP	NP

Z ZAMAK

NS N. SILVER / ALPACA

S STEEL / ACERO

NE NEON

NP NICKEL PLATED / LATON NIQUELADO

GM FUN COLOR

CK CRISTAL KEYS / PLASTICO COLOR

A ALUMINUM / ALUMINIO

B BRASS / LATON

Z ZAMAK

NS N. SILVER / ALPACA

S STEEL / ACERO

NE NEON

NP NICKEL PLATED / LATON NIQUELADO

GM FUN COLOR

CK CRISTAL KEYS / PLASTICO COLOR

A ALUMINUM / ALUMINIO

B BRASS / LATON

! Concerning the marks and commercial denominations see note in index.

Concerniente a las marcas y denominaciones comerciales ver nota en indice.

Concernant les marques et denominations commerciales voir la note dans l'index.

! Concerning the marks and commercial denominations see note in index.

Concerniente a las marcas y denominaciones comerciales ver nota en indice.

Concernant les marques et denominations commerciales voir la note dans l'index.



<p>Z ZAMAK</p> <p>NS N SILVER / ALPACA</p> <p>S STEEL / ACERO</p> <p>NE NEON</p> <p>NP NICKEL PLATED / LATON NIQUELADO</p> <p>GM FUN COLOR</p> <p>CK CRISTAL KEYS / PLASTICO COLOR</p> <p>A ALUMINUM / ALUMINIO</p> <p>B BRASS / LATON</p>	FOR: GENERAL MOTORS®		FOR: GOLF CART®	
	TOYO-14 DC1	TOYO-14.P DC1P	FEM-2D F91G	GOC-1D CC1
	FOR: GOLF CART®		FOR: HINO®	
	GOC-2D CC2	HIN-1 HN3	HIN-1.P	TOYO-12 TR33
FOR: HINO®		FOR: HONDA®		
TOYO-12.P TR33P	GM-15D B74	GM-15D.P B74P	HOND-34 HD70U	
			HOND-2 HD71	
			HOND-1 HD70	

FOR: HONDA®							
HOND-2.P HON33P	HOND-11	HOND-10 HD90	HOND-11.P	HOND-10.P HD90P	HOND-13 X130	HOND-12 HD82	
FOR: HONDA®							
HOND-13.P HON38RP	HOND-12.P HD82P	HOND-14	HOND-14.P	HOND-15 HD91			
FOR: HONDA®							
HOND-15.P HD91P	HOND-16 HD103	HOND-16.D.P HD103P	HOND-17.P				
							3.5 mm



Concerning the marks and commercial denominations see note in index.

Concerniente a las marcas y denominaciones comerciales ver nota en indice.

Concernant les marques et denominations commerciales voir la note dans l'index.











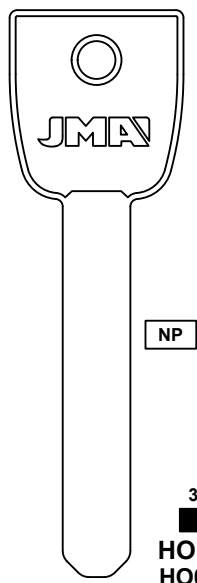
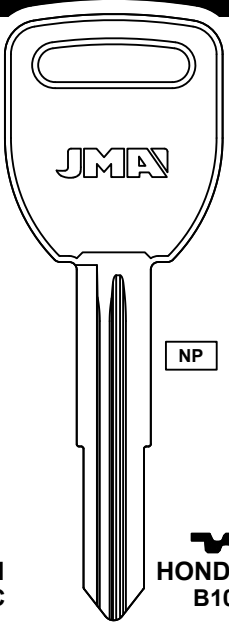
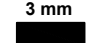

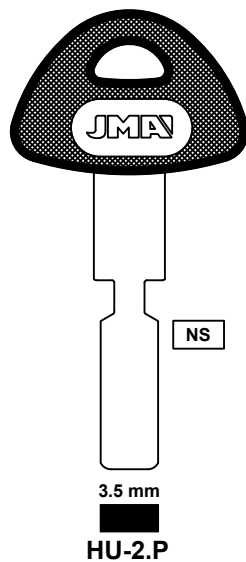

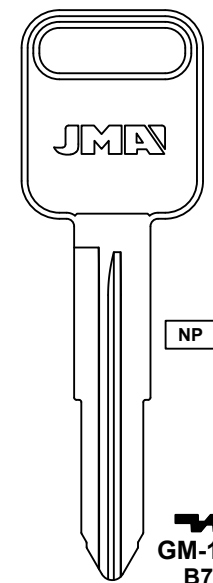

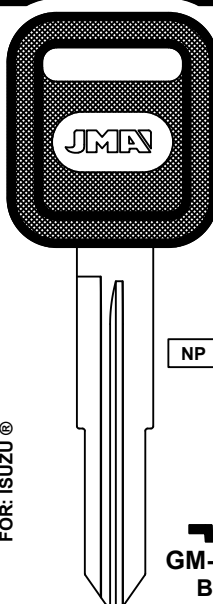

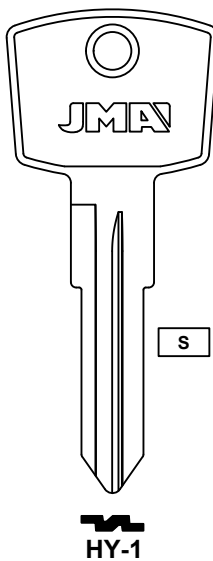
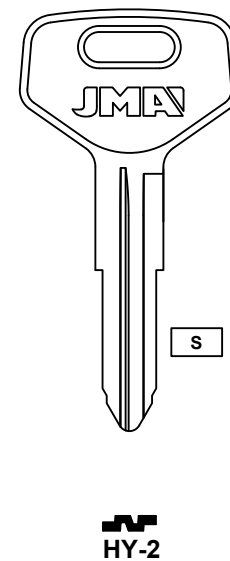
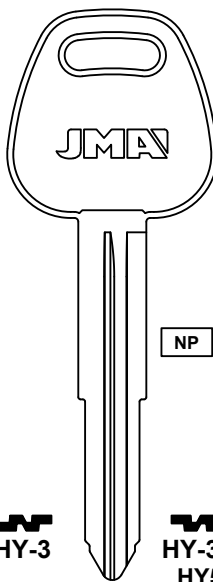
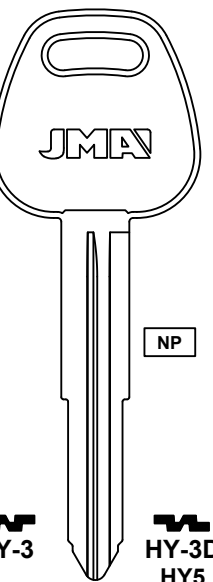
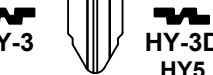

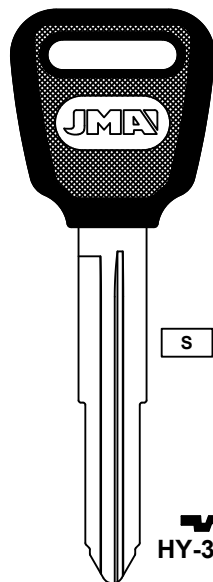
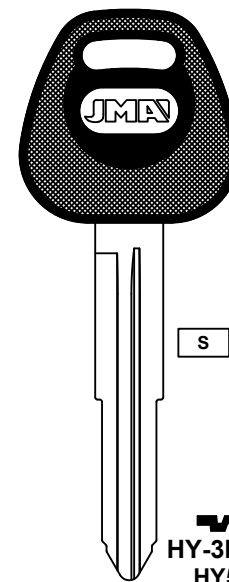
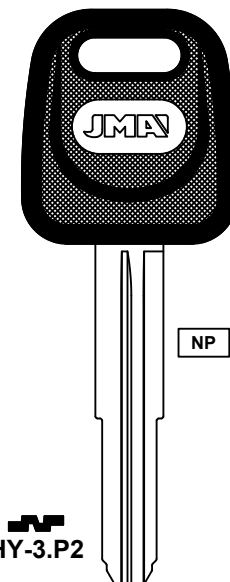
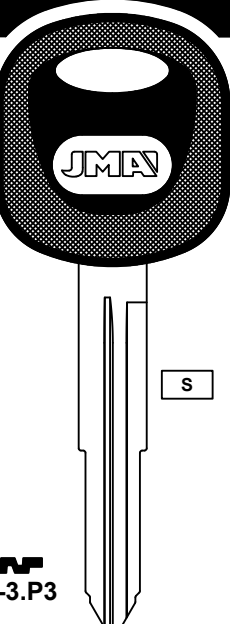

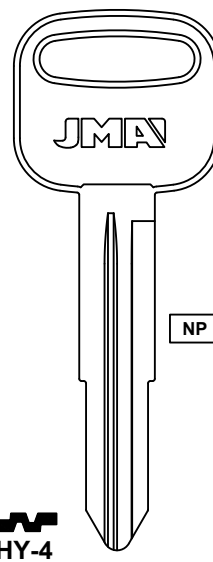
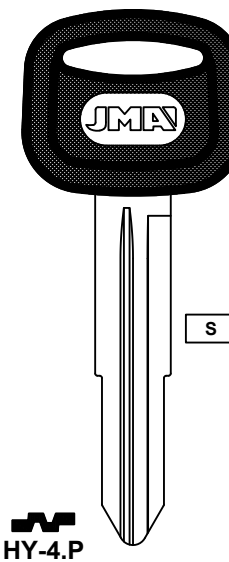
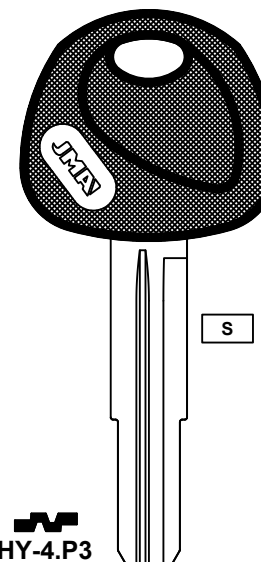
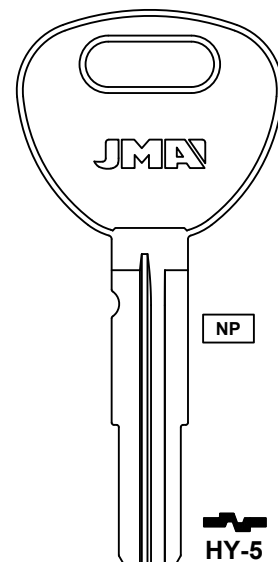





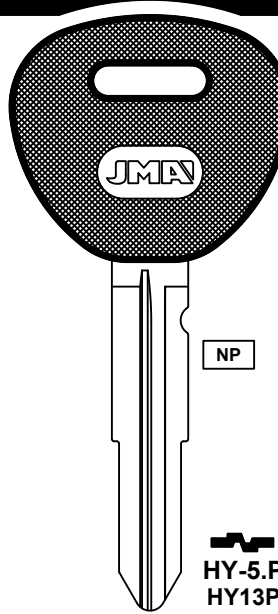
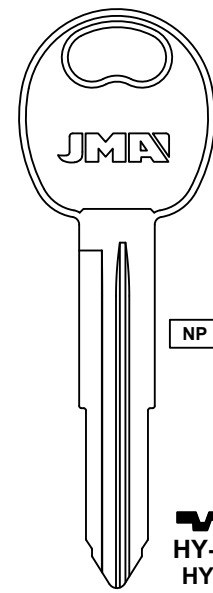
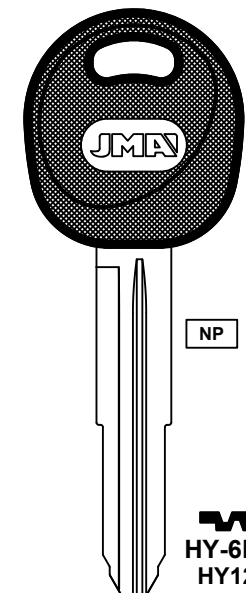
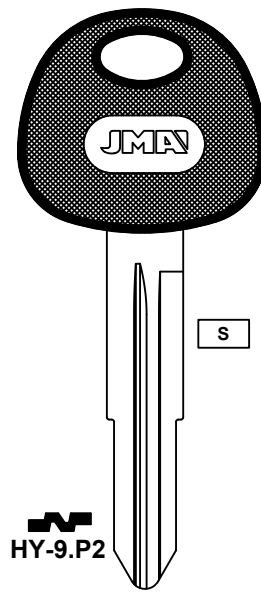





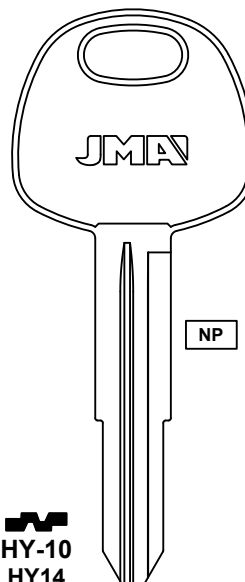
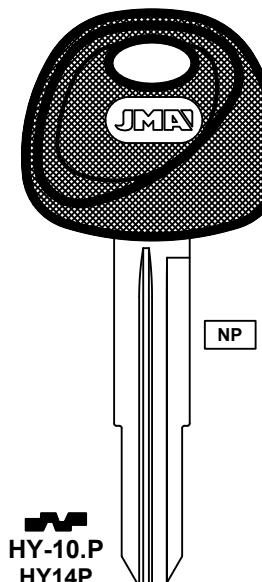
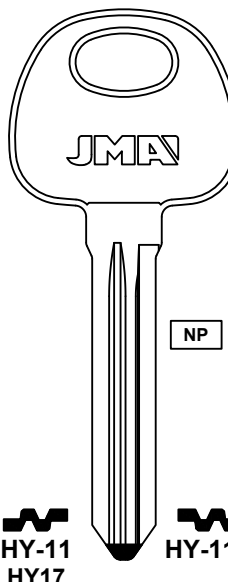
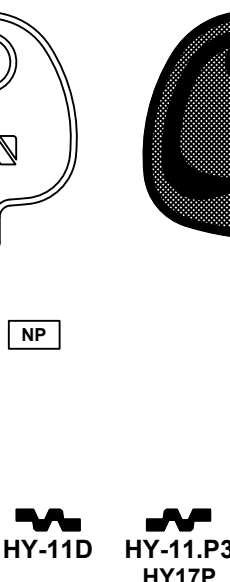
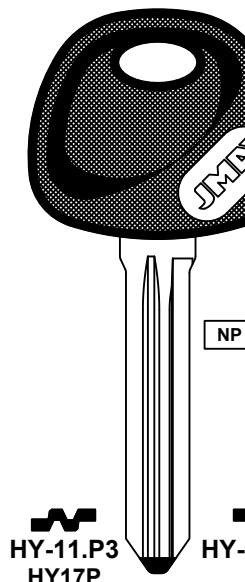
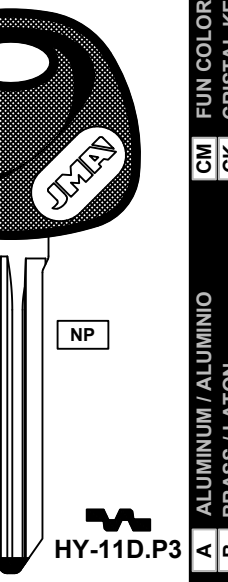

Concerning the marks and commercial denominations see note in index.

Concerniente a las marcas y denominaciones comerciales ver nota en indice.

Concernant les marques et denominations commerciales voir la note dans l'index.



Z ZAMAK NS N. SILVER / ALPACA S STEEL / ACERO NE NEON NP NICKEL PLATED / LATON NIQUELADO GM FUN COLOR CK CRISTAL KEYS / PLASTICO COLOR A ALUMINUM / ALUMINIO B BRASS / LATON	FOR: HONDA®  NP  NP 3 mm  HOND-31  HOND-32D B101		FOR: HUF®  NS 3.5 mm  HU-2.P	FOR: HYUNDAI®  NP FOR: ISUZU®  GM-15D B74
	FOR: HYUNDAI®  NP FOR: ISUZU®  GM-15D.P B74P			
	 S  S  NP  NP  HY-3D  HY-5			
FOR: HYUNDAI®  S  S  NP  S				

Z ZAMAK NS N. SILVER / ALPACA S STEEL / ACERO NE NEON NP NICKEL PLATED / LATON NIQUELADO GM FUN COLOR CK CRISTAL KEYS / PLASTICO COLOR A ALUMINUM / ALUMINIO B BRASS / LATON	FOR: HYUNDAI®  NP  S  S  NP  HY-4  HY-4.P  HY-4.P3  HY-5  HY-13			
	FOR: HYUNDAI®  NP  NP  NP  S  HY-5.P  HY-13P  HY-6D  HY-12  HY-6D.P  HY-12P  HY-9.P2			
	FOR: HYUNDAI®  NP  NP  NP  NP  NP  NP  HY-10  HY-14  HY-10.P  HY-14P  HY-11  HY-17  HY-11D  HY-11P3  HY-17P  HY-11D.P3			



Concerning the marks and commercial denominations see note in index.

Concerniente a las marcas y denominaciones comerciales ver nota en indice.

Concernant les marques et denominations commerciales voir la note dans l'index.



Concerning the marks and commercial denominations see note in index.

Concerniente a las marcas y denominaciones comerciales ver nota en indice.

Concernant les marques et denominations commerciales voir la note dans l'index.



FOR: HYUNDAI®

 HY-12 HY16	 HY-12.P3 HY16P	 HY-13D HY15	 HY-13D.P3 HY15P
FOR: HYUNDAI®			
 HY-14	 HY-15D HY2	 HY-16 HY3	 HY-17 HY4
FOR: HYUNDAI®			
 HY-18 LXP90	 HY-18.P	 HY-18.P3 KK10P	FOR: KIA® HY-19.P3 HY18RP
 HY-19D.P3 HY18P			

FOR: HYUNDAI®

 HY-19.P5	 3 mm HY-20.P	 3 mm HY-21.P3 KK12P	 MIT-21 DC3
FOR: HYUNDAI®		FOR: ISUZU®	
 MIT-21.P DC3P	 GM-47D B54	 ISU-1	 ISU-1D
FOR: ISUZU®			
 ISU-3D.P	 ISU-4	 ISU-5 B113	 ISU-5.P

Z ZAMAK
 NS N.SILVER / ALPACA
 S STEEL / ACERO
 NE NEON
 NP NICKEL PLATED / LATON NIQUELADO
 FM FUN COLOR
 GM CRISTAL KEYS / PLASTICO COLOR
 A ALUMINUM / ALUMINIO
 B BRASS / LATON

Z ZAMAK
 NS N.SILVER / ALPACA
 S STEEL / ACERO
 NE NEON
 NP NICKEL PLATED / LATON NIQUELADO
 FM FUN COLOR
 GM CRISTAL KEYS / PLASTICO COLOR
 A ALUMINUM / ALUMINIO
 B BRASS / LATON



Concerning the marks and commercial denominations see note in index.

Concerniente a las marcas y denominaciones comerciales ver nota en índice.

Concernant les marques et dénominations commerciales voir la note dans l'index.



Concerning the marks and commercial denominations see note in index.

Concerniente a las marcas y denominaciones comerciales ver nota en índice.

Concernant les marques et dénominations commerciales voir la note dans l'index.



Z ZAMAK
NS N. SILVER / ALPACA
S STEEL / ACERO
NE NEON
NP NICKEL PLATED / LATON NIQUELADO
FOR: YARD TRACTOR®
FOR: INDAK®
FUN COLOR
GM CRISTAL KEYS / PLASTICO COLOR
CK
A ALUMINUM / ALUMINIO
B BRASS / LATON
FOR: BRIGGS & STRATTON®

Z ZAMAK
NS N. SILVER / ALPACA
S STEEL / ACERO
NE NEON
NP NICKEL PLATED / LATON NIQUELADO
FOR: PETERBILT®
FUN COLOR
GM CRISTAL KEYS / PLASTICO COLOR
CK
A ALUMINUM / ALUMINIO
B BRASS / LATON

FOR: ISUZU®

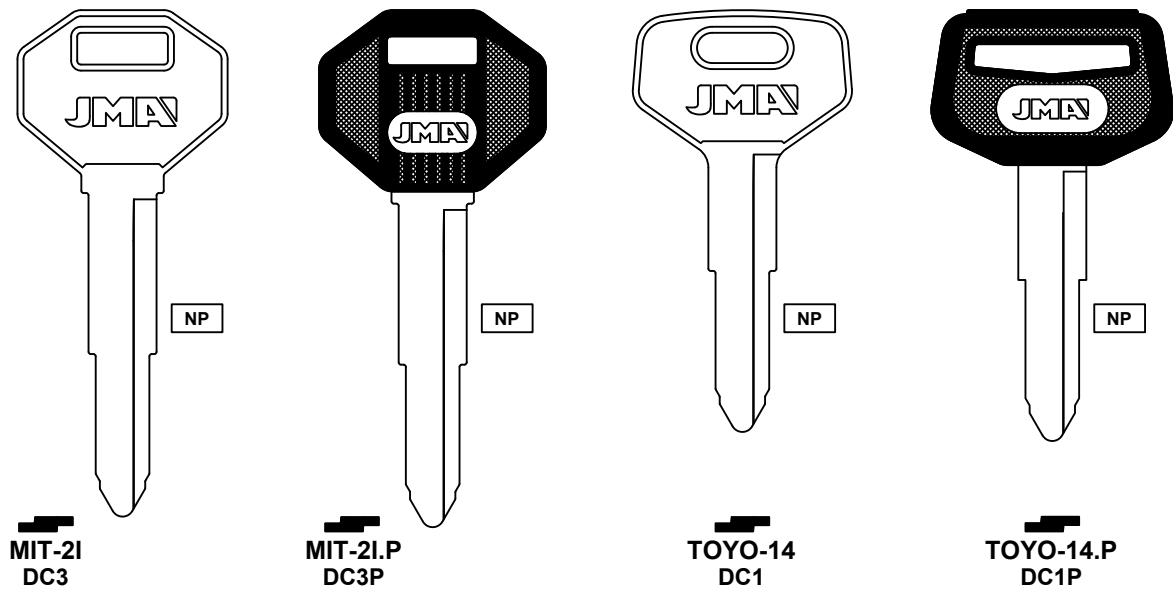

FOR: KENWORTH®

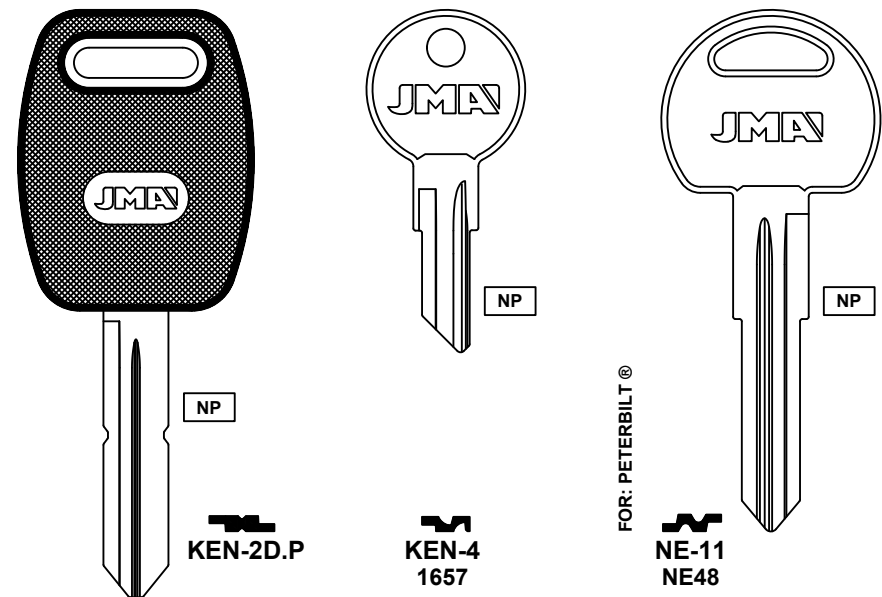

FOR: KIA®

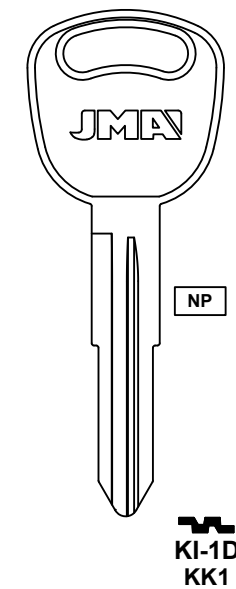

FOR: JOHN DEERE®

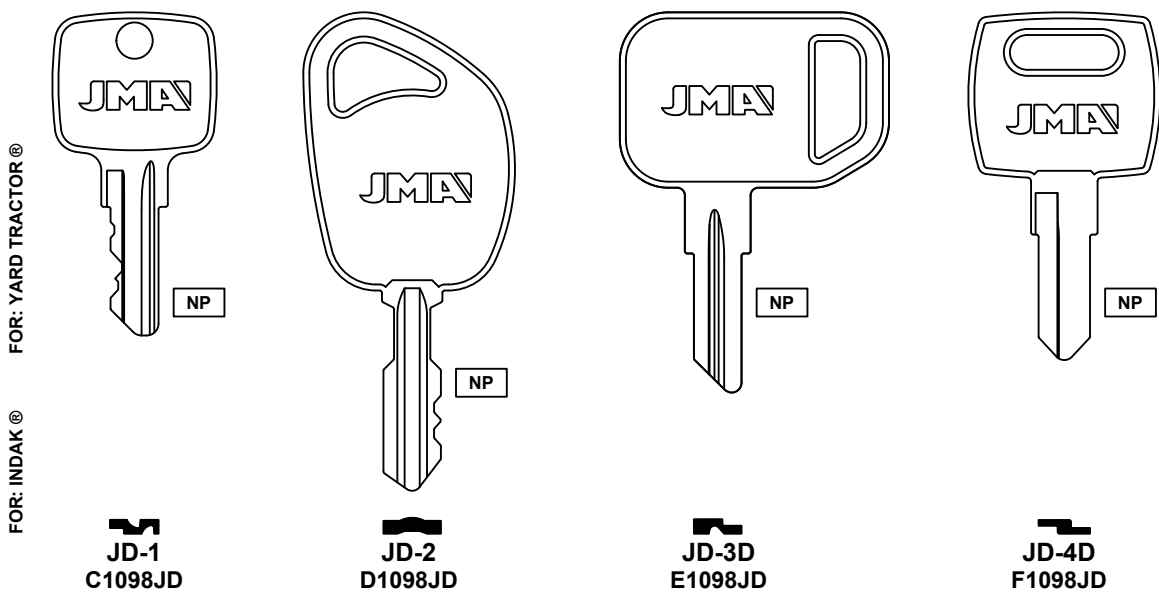

FOR: KIA®

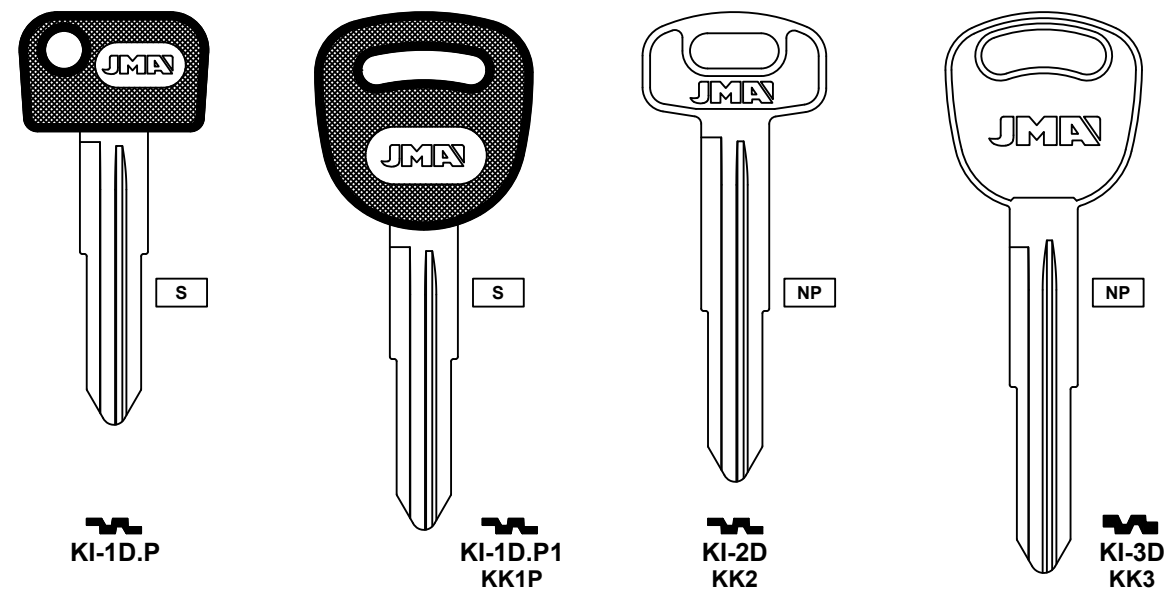

FOR: KENWORTH®

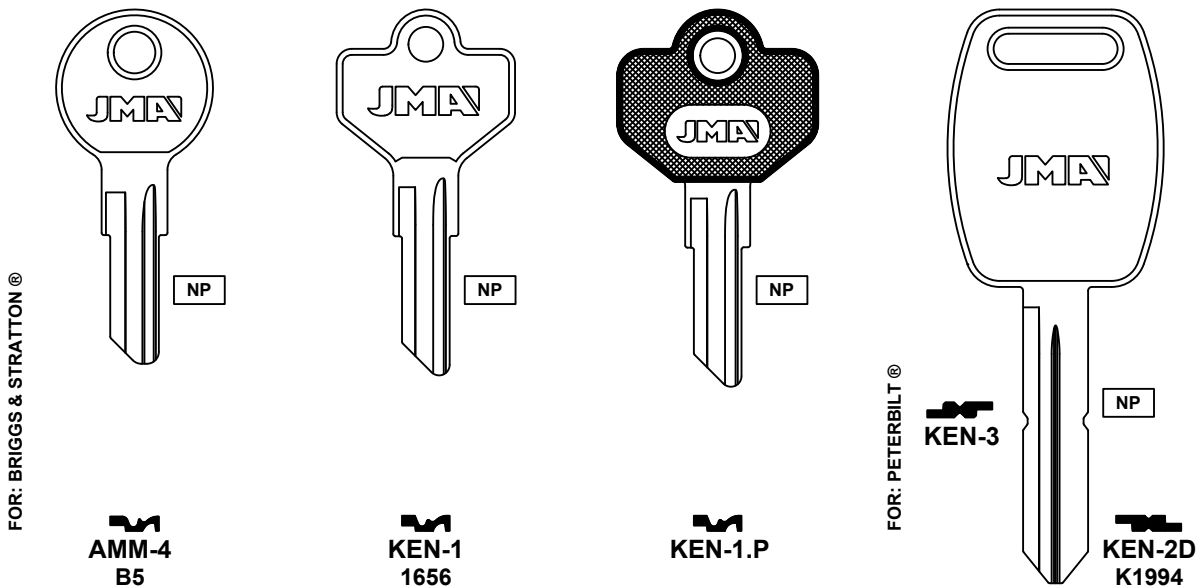

FOR: KIA®

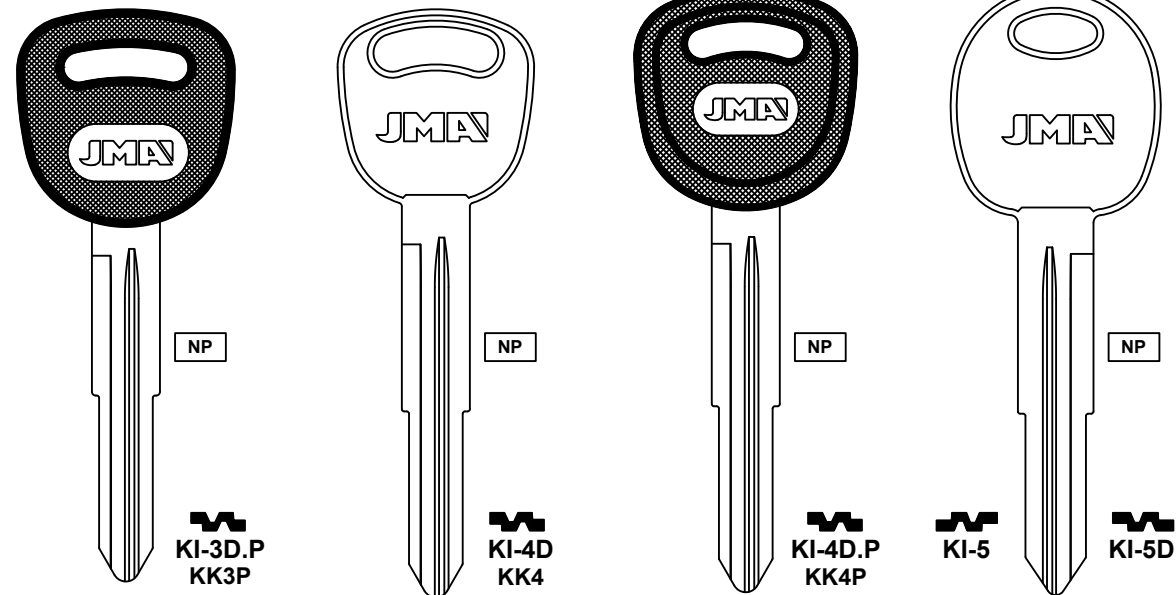

Concerning the marks and commercial denominations see note in index.

Concerniente a las marcas y denominaciones comerciales ver nota en indice.

Concernant les marques et denominations commerciales voir la note dans l'index.



Concerning the marks and commercial denominations see note in index.

Concerniente a las marcas y denominaciones comerciales ver nota en indice.

Concernant les marques et denominations commerciales voir la note dans l'index.

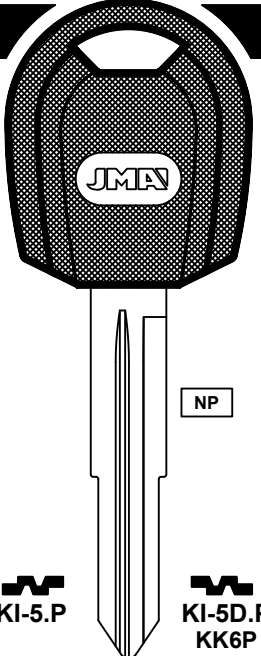
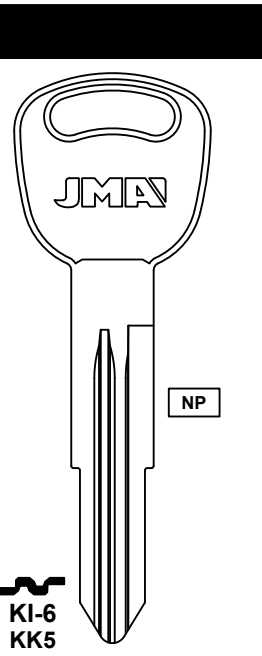
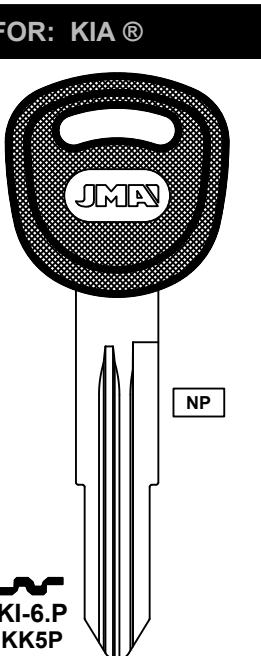
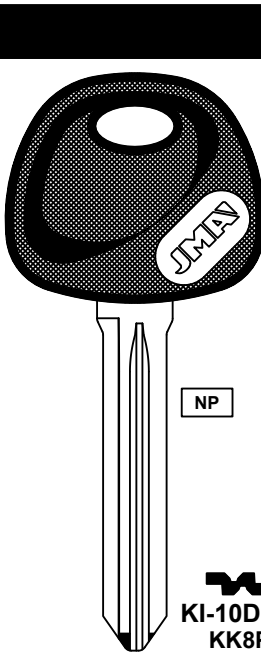
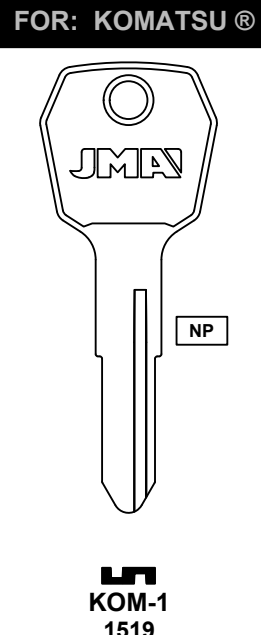
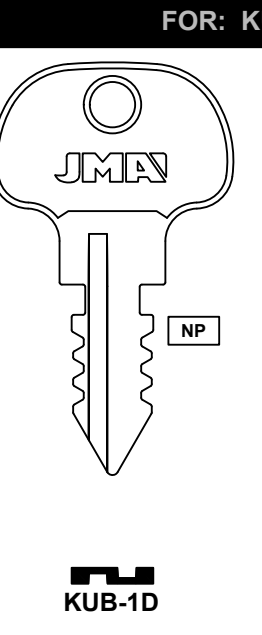
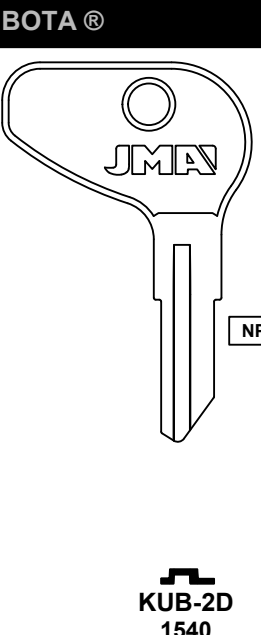
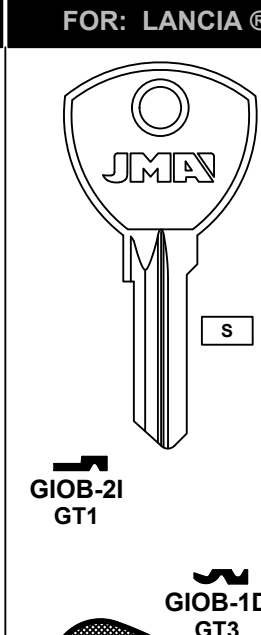
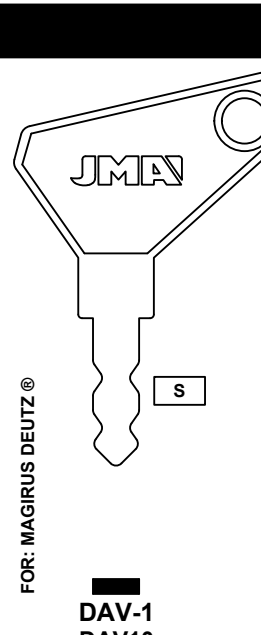
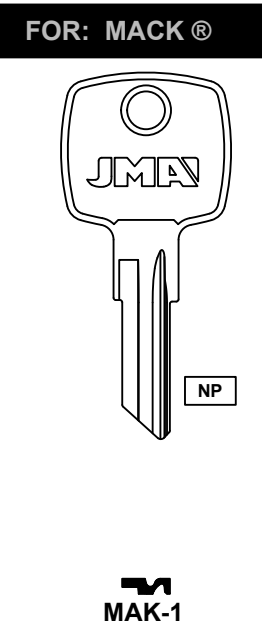
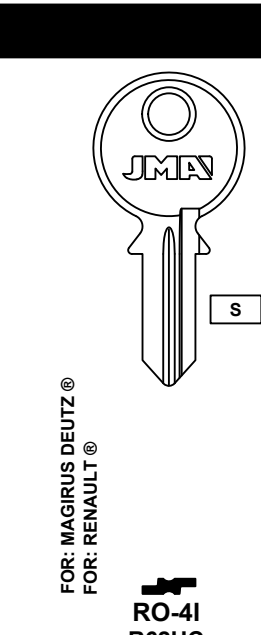
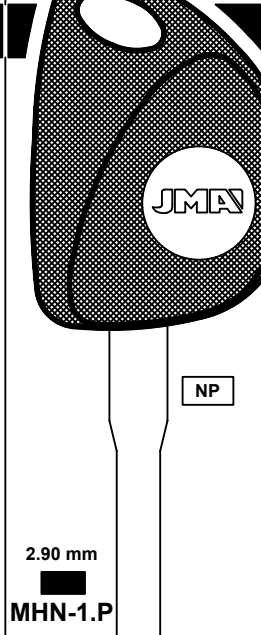

Z ZAMAK NS N. SILVER / ALPACA S STEEL / ACERO NE NEON NP NICKEL PLATED / LATON NIQUELADO CM FUN COLOR CK CRISTAL KEYS / PLASTICO COLOR A ALUMINUM / ALUMINIO B BRASS / LATON	FOR: KIA®  NP  NP  NP  NP			
	 NP KOM-1 1519	 NP KUB-1D	 NP KUB-2D 1540	 S GIOB-2I GT1 GIOB-1D GT3 FOR: FERRARI® FOR: MASERATTI®
	FOR: MACK®  S FOR: MAGIRUS DEUTZ® DAV-1 DAV10			
	 NP MAK-1	 S FOR: MAGIRUS DEUTZ® FOR: RENAULT® RO-4I R62UC	 NP 2.90 mm MHN-1.P FOR: MAHINDRA®	

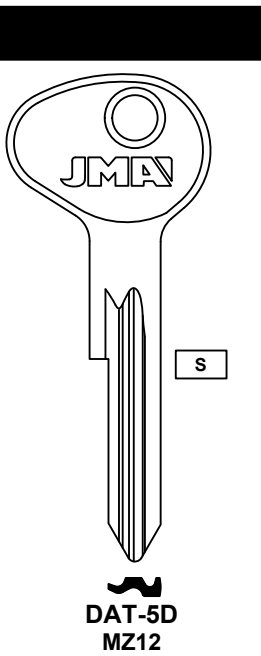
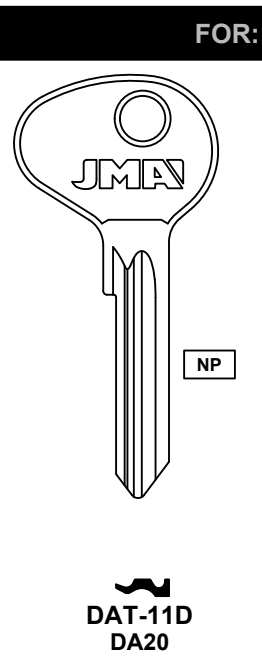
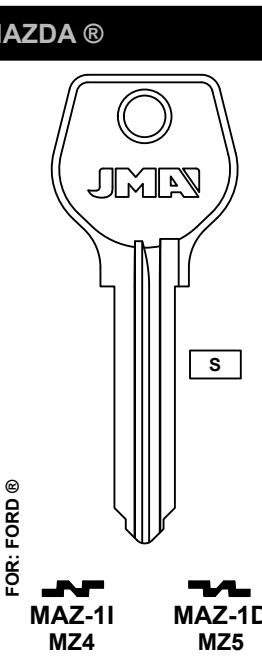
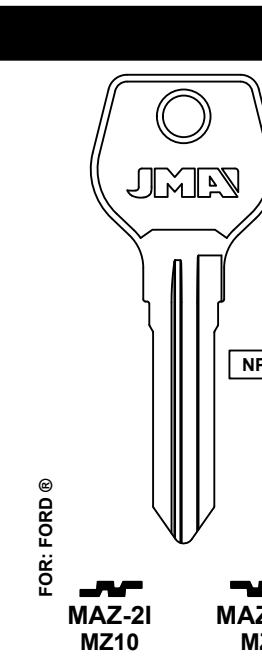
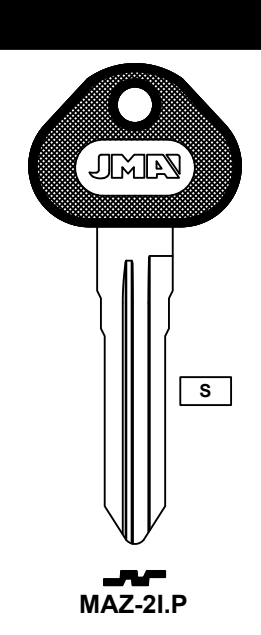
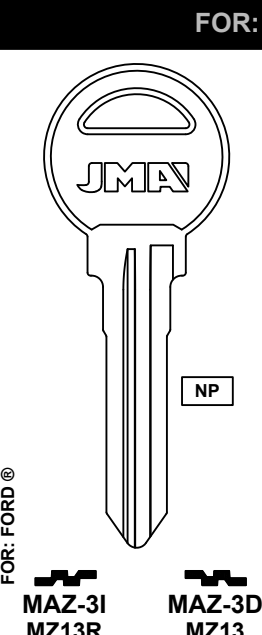
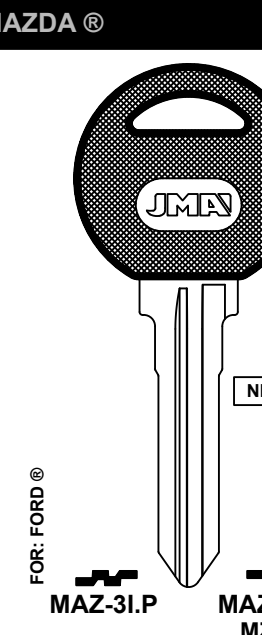
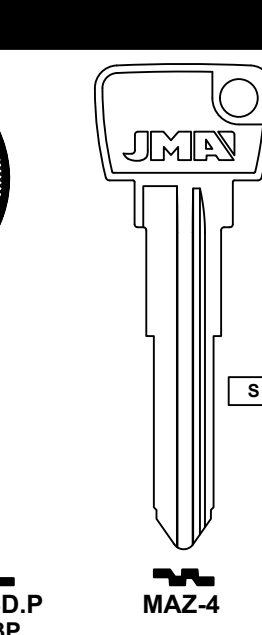
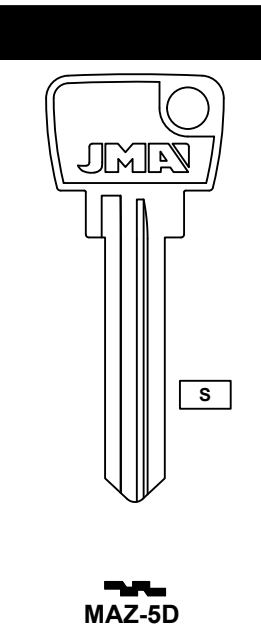
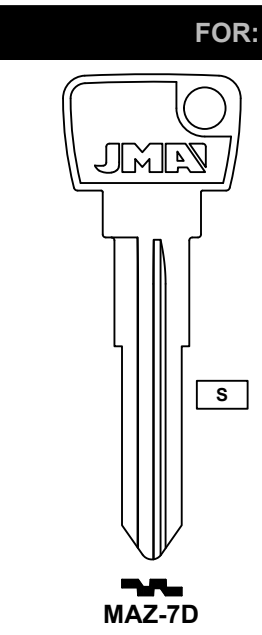
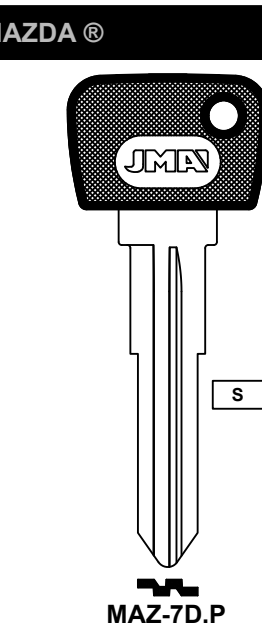
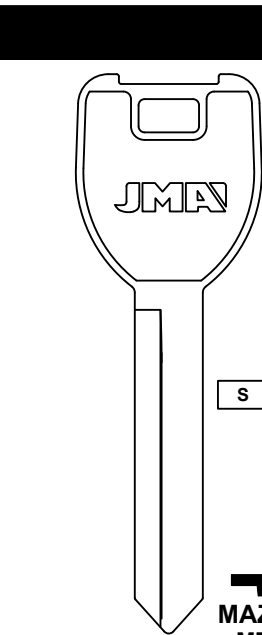
Z ZAMAK NS N. SILVER / ALPACA S STEEL / ACERO NE NEON NP NICKEL PLATED / LATON NIQUELADO CM FUN COLOR CK CRISTAL KEYS / PLASTICO COLOR A ALUMINUM / ALUMINIO B BRASS / LATON	FOR: MAZDA®  S DAT-5D MZ12			
	 NP DAT-11D DA20	 S FOR: FORD® MAZ-1I MZ4 MAZ-1D MZ5	 NP FOR: FORD® MAZ-2I MZ10 MAZ-2D MZ9	
	 S MAZ-2I.P	 NP FOR: FORD® MAZ-3I MZ13R MAZ-3D MZ13	 NP FOR: FORD® MAZ-3I.P MAZ-3D.P MZ13P	 S MAZ-4
	 S MAZ-5D	 S MAZ-7D	 S MAZ-7D.P	 S MAZ-8D MZ25



Concerning the marks and commercial denominations see note in index.

Concerniente a las marcas y denominaciones comerciales ver nota en indice.

Concernant les marques et denominations commerciales voir la note dans l'index.



Concerning the marks and commercial denominations see note in index.

Concerniente a las marcas y denominaciones comerciales ver nota en indice.

Concernant les marques et denominations commerciales voir la note dans l'index.



Z ZAMAK
NS N.SILVER / ALPACA S STEEL / ACERO
NE NEON NP NICKEL PLATED / LATON NIQUELADO
CM FUN COLOR CK CRISTAL KEYS / PLASTICO COLOR
A ALUMINUM / ALUMINIO B BRASS / LATON

Z ZAMAK
NS N.SILVER / ALPACA S STEEL / ACERO
NE NEON NP NICKEL PLATED / LATON NIQUELADO
CM FUN COLOR CK CRISTAL KEYS / PLASTICO COLOR
A ALUMINUM / ALUMINIO B BRASS / LATON

FOR: MAZDA®

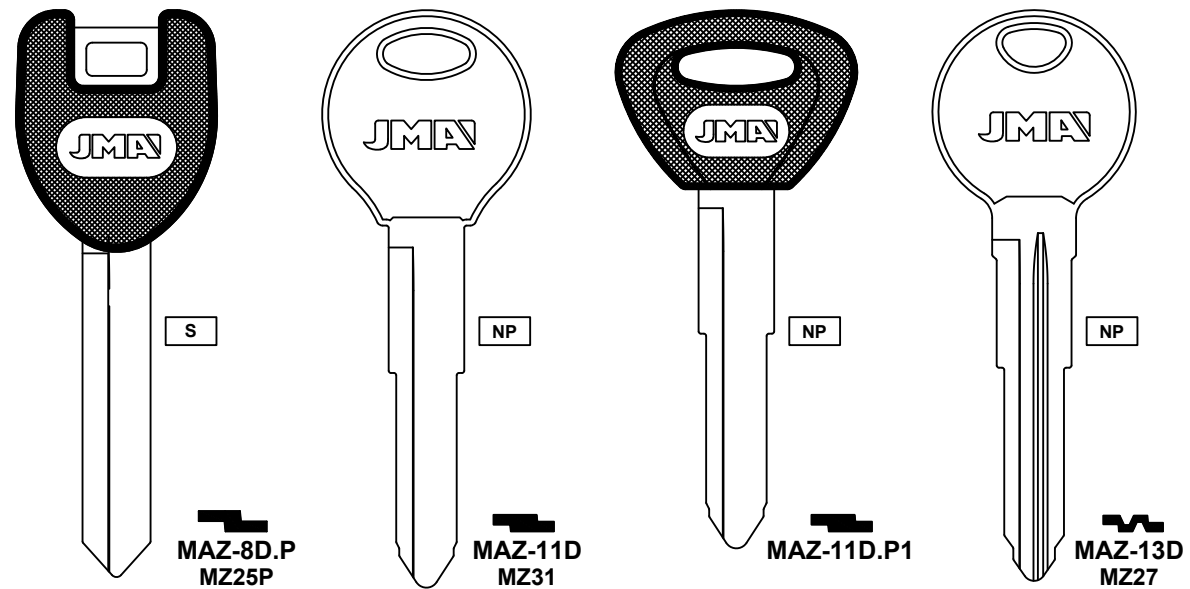

FOR: MAZDA®

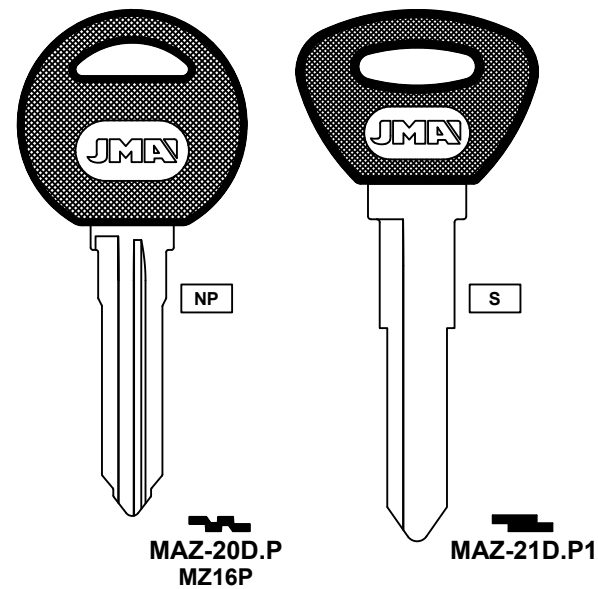

FOR: MERCEDES BENZ®

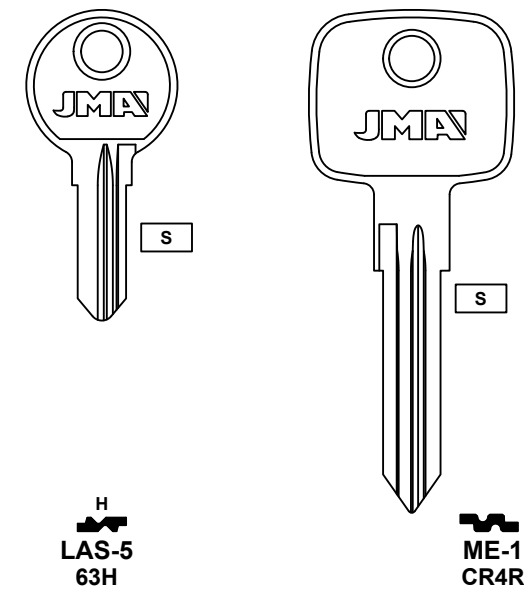

FOR: MAZDA®

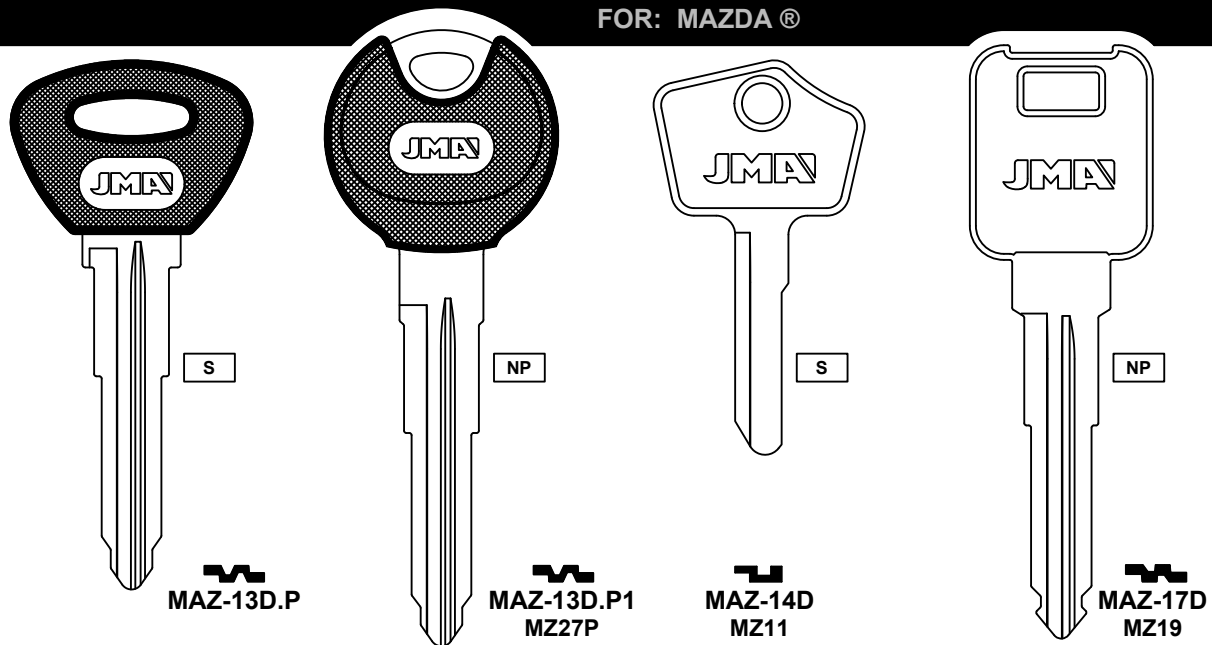

FOR: MERCEDES BENZ®

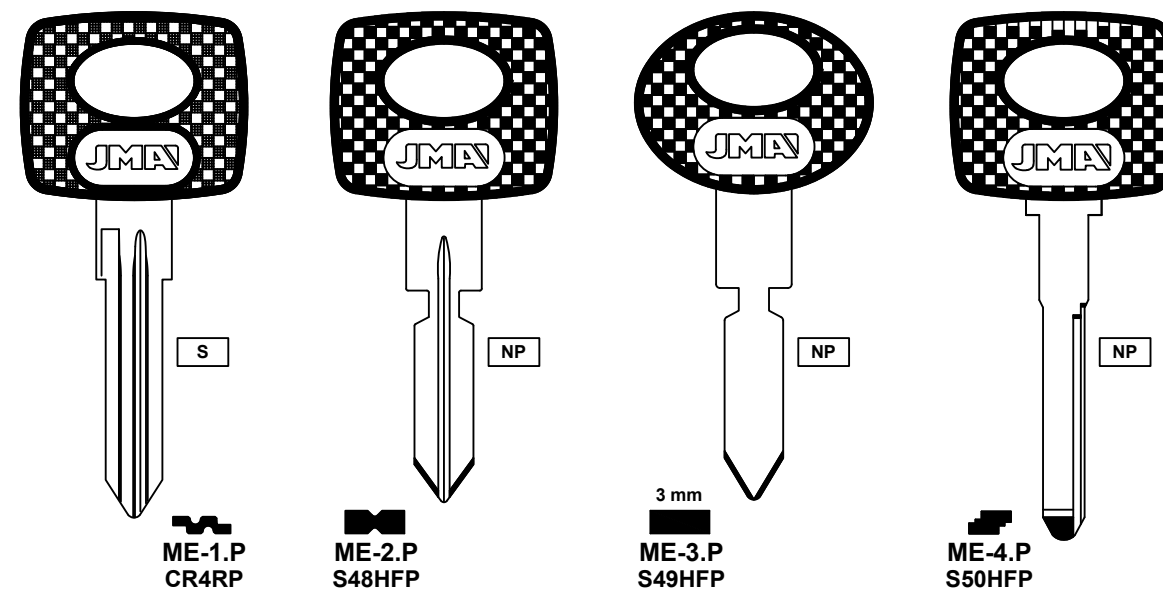

FOR: MAZDA®

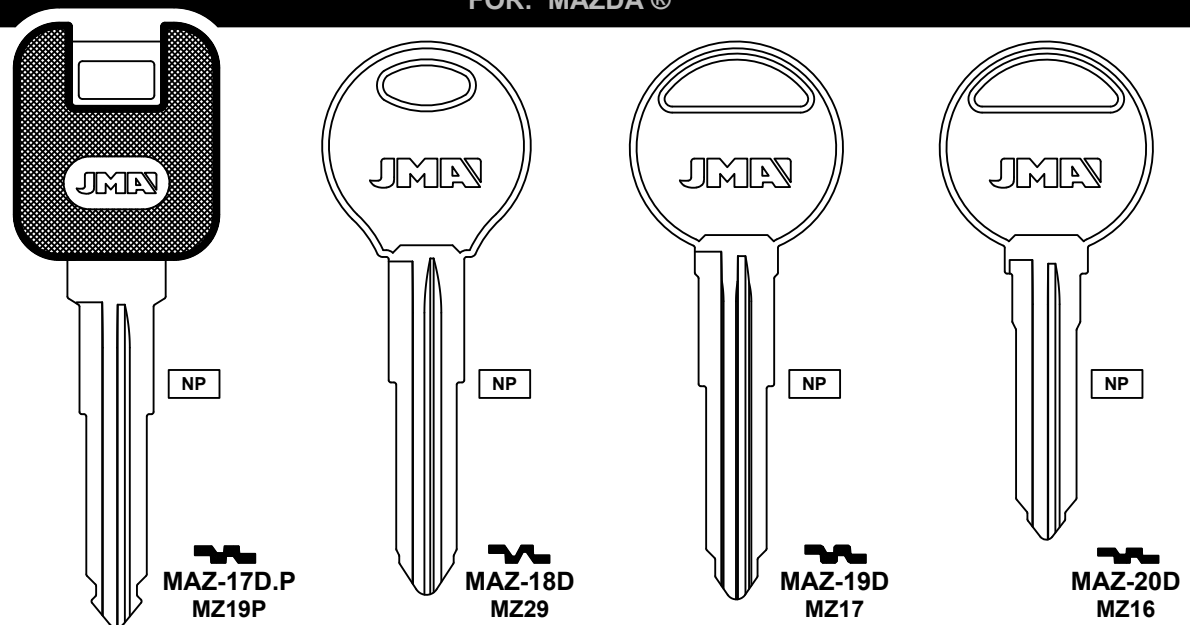

FOR: MERCEDES BENZ®

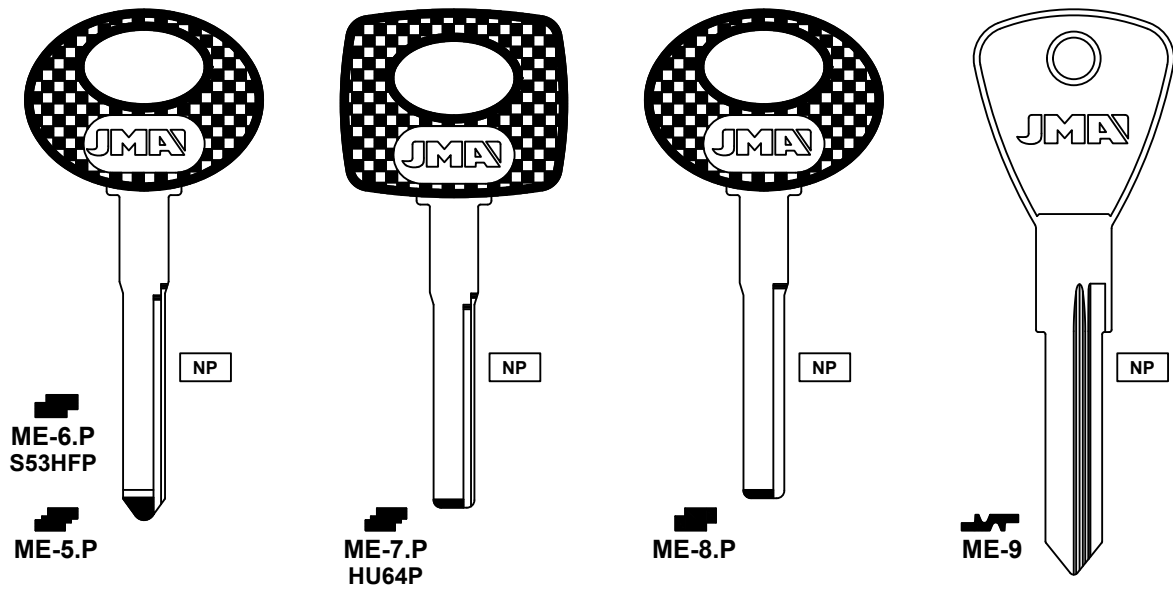

Concerning the marks and commercial denominations see note in index.

Concerniente a las marcas y denominaciones comerciales ver nota en indice.

Concernant les marques et denominations commerciales voir la note dans l'index.



Concerning the marks and commercial denominations see note in index.

Concerniente a las marcas y denominaciones comerciales ver nota en indice.

Concernant les marques et denominations commerciales voir la note dans l'index.



Z ZAMAK	NS N SILVER / ALPACA S STEEL / ACERO	FOR: MERCEDES BENZ®			
		ME-9.P	ME-11.P S34YSP	ME-12.P S58HFP	ME-14.P
NE NEON NP NICKEL PLATED / LATON NIQUELADO	CM FUN COLOR CK CRISTAL KEYS / PLASTICO COLOR	FOR: MERCEDES BENZ®			
		ME-15 HF7	ME-15D HF15	ME-HD MB15	ME-HZ.P MB18P
A ALUMINUM / ALUMINIO B BRASS / LATON	CM FUN COLOR CK CRISTAL KEYS / PLASTICO COLOR	FOR: MERCEDES BENZ®			
		ME-HF MB16	ME-HM MB17	ME-NY	ME-NU.P
		ME-HM.P MB15P	ME-HY MB39	ME-HY.P MB39P	ME-HU MB41

Z ZAMAK	NS N SILVER / ALPACA S STEEL / ACERO	FOR: MERCEDES BENZ®		FOR: MERCURY®		FOR: MIS.SWITCHES®			
		ME-L YM16	NE-25 H61VR	BS-9 1040U	BS-8 CU10	BS-7 CU-7	BS-9D CU12	BS-8D CU9	
NE NEON NP NICKEL PLATED / LATON NIQUELADO	CM FUN COLOR CK CRISTAL KEYS / PLASTICO COLOR	FOR: MIS.SWITCHES®		FOR: MITSUBISHI®					
		YA-45 Y14	CHR-17 MIT2	HY-3D HY5	HY-3D.P1 HY5P				
		FOR: MITSUBISHI®		FOR: POLARIS®					
HY-15D HY2	MIT-11	MIT-1D	MIT-11.P	MIT-1D.P	MIT-21 DC3	MIT-2D			

Concerning the marks and commercial denominations see note in index.
Concerniente a las marcas y denominaciones comerciales ver nota en indice.
Concernant les marques et denominations commerciales voir la note dans l'index.

Concerning the marks and commercial denominations see note in index.
Concerniente a las marcas y denominaciones comerciales ver nota en indice.
Concernant les marques et denominations commerciales voir la note dans l'index.



<p>Z ZAMAK</p> <p>NS N. SILVER / ALPACA</p> <p>S STEEL / ACERO</p> <p>NE NEON</p> <p>NP NICKEL PLATED / LATON NIQUELADO</p> <p>CM FUN COLOR</p> <p>CK CRISTAL KEYS / PLASTICO COLOR</p> <p>A ALUMINUM / ALUMINIO</p> <p>B BRASS / LATON</p>	FOR: MITSUBISHI ®			
	MIT-21.P DC3P	MIT-2D.P	MIT-3	MIT-3.P
	FOR: POLARIS ®			
	MIT-4			
	FOR: MITSUBISHI ®			
	MIT-4.P	MIT-6	FOR: CHRYSLER ® MIT-7 MIT4	FOR: CHRYSLER ® MIT-7.P MIT4P
	FOR: MITSUBISHI ®			
	MIT-8D	MIT-8D.P	MIT-9	MIT-10
FOR: MITSUBISHI ®				
MIT-11D FU2	MIT-12	FOR: CHRYSLER ® MIT-13D MIT5	FOR: CHRYSLER ® MIT-14D MIT3	
FOR: MITSUBISHI ®				
MIT-15.P	FOR: CHRYSLER ® MIT-16 MIT1	FOR: CHRYSLER ® MIT-16.P MIT1P	MIT-17 MIT7	
FOR: MITSUBISHI ®				
MIT-18 MIT6	MIT-18D	MIT-18.P MIT6P	MIT-18D.P	
FOR: MITSUBISHI ®				
TOYO-14 DC1				
FOR: MITSUBISHI ®				
TOYO-14.P DC1P				

! Concerning the marks and commercial denominations see note in index.

Concerniente a las marcas y denominaciones comerciales ver nota en indice.

Concernant les marques et denominations commerciales voir la note dans l'index.



! Concerning the marks and commercial denominations see note in index.

Concerniente a las marcas y denominaciones comerciales ver nota en indice.

Concernant les marques et denominations commerciales voir la note dans l'index.



<p>CM CK</p> <p>FUN COLOR CRISTAL KEYS / PLASTICO COLOR</p> <p>NE NP</p> <p>NEON NICKEL PLATED / LATON NIQUELADO</p> <p>NS S</p> <p>N.SILVER / ALPACA STEEL / ACERO</p> <p>Z ZAMAK</p>	FOR: MORETTI®				FOR: NISSAN®				FOR: NISSAN®			
	AF-4I R61G				DAT-11.P				DAT-11			
	DAT-1D.P				DAT-21 DA23				DAT-11D DA20			
DAT-2I.P DA23P				DAT-2D DA24				DAT-12 DA25				
FOR: NISSAN®				FOR: SUBARU®				FOR: NISSAN®				
DAT-4I DT7				DAT-14 DA30				DAT-15 DA35				
DAT-4D DT8				DAT-14.P DA30P				DAT-15.P				
FOR: SUNBEAM®												
DAT-7				DAT-13				DAT-16 DA34				
DAT-6				DAT-13.P				DAT-16.P DA34P				
DAT-6D				DAT-13.P				DAT-16.P DA34P				
DAT-6.P DA25P				DAT-13.P				DAT-16.P DA34P				
DAT-6D.P				DAT-13.P				DAT-16.P DA34P				
FOR: NISSAN®				FOR: INFINITI®				FOR: NISSAN®				
DAT-6.P1				DAT-17				DAT-17D				
DAT-6D.P1				DAT-18 DA28				DAT-19 DA32				
DAT-8I				DAT-18 DA28				DAT-19.P DA32P				
DAT-8 62DV				DAT-19.P DA32P				DAT-19.P DA32P				
DAT-10 DA38				DAT-19.P DA32P				DAT-19.P DA32P				
DAT-10.P DA38P				DAT-19.P DA32P				DAT-19.P DA32P				

! Concerning the marks and commercial denominations see note in index.

Concerniente a las marcas y denominaciones comerciales ver nota en indice.

Concernant les marques et denominations commerciales voir la note dans l'index.



! Concerning the marks and commercial denominations see note in index.

Concerniente a las marcas y denominaciones comerciales ver nota en indice.

Concernant les marques et denominations commerciales voir la note dans l'index.



Z ZAMAK NS N SILVER / ALPACA S STEEL / ACERO NE NEON NP NICKEL PLATED / LATON NIQUELADO FM FUN COLOR GM CRISTAL KEYS / PLASTICO COLOR A ALUMINUM / ALUMINIO B BRASS / LATON	FOR: NISSAN ®				FOR: NISSAN ®				FOR: NISSAN ®							
	NP	NP	NP	NP	NP	NP	NP	NP	FK	FR	OP-6	OP-7	OP-8	OP-9		
	DA37	DA37P	62DT	62DU	DA31	DA31P	DA39				YM6	YM7	YM8	YM9		
FOR: INFINITI ®				FOR: SUBARU ®				FOR: MERCEDES BENZ ®				FOR: VOLKSWAGEN ®				
NP	NP	NP	NP	S	NP	NP	S	S	S	NP	S	S	S	S		
DA31P	DA39															
FOR: OPEL ®				FOR: OPEL ®				FOR: OPEL ®				FOR: PANHARD ®				
NP	S	S	NP	S	S	S	S	S	S	NP	NP	S	S	S	S	
HU100	BU1	BU2	A62VN	YM6	YM7	YM8	YM9									

FOR: VAUXHALL ®				FOR: OPEL ®				FOR: OPEL ®				FOR: OPEL ®			
S	S	S	S	S	S	S	S	S	NP	S	S	S	S	S	S
YM29	YM30														
FOR: FORD INTERNATIONAL ®				FOR: OPEL ®				FOR: OPEL ®				FOR: PANHARD ®			
S	S	S	S	S	S	S	S	S	NP	S	S	S	S	S	S
FOR: VAUXHALL ®				FOR: OPEL ®				FOR: OPEL ®				FOR: PANHARD ®			
S	S	S	S	S	S	S	S	S	NP	S	S	S	S	S	S

Concerning the marks and commercial denominations see note in index.
 Concerniente a las marcas y denominaciones comerciales ver nota en indice.
 Concernant les marques et denominations commerciales voir la note dans l'index.

Concerning the marks and commercial denominations see note in index.
 Concerniente a las marcas y denominaciones comerciales ver nota en indice.
 Concernant les marques et denominations commerciales voir la note dans l'index.

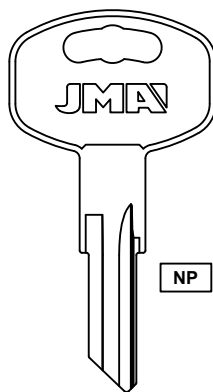
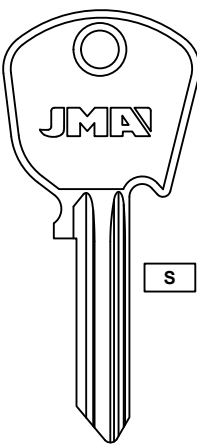
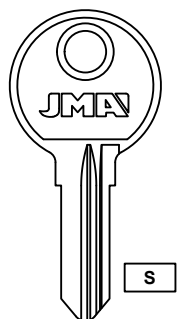
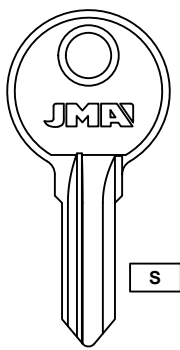
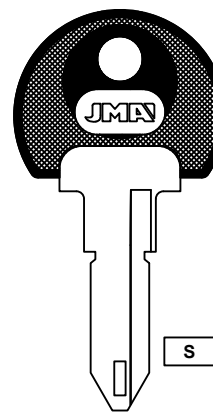
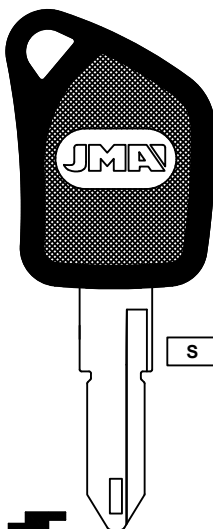
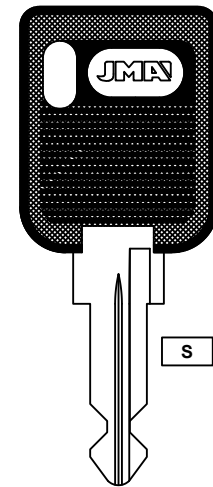
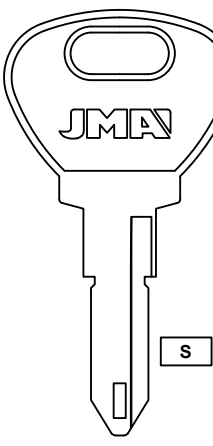
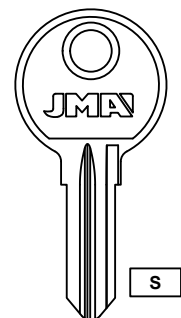
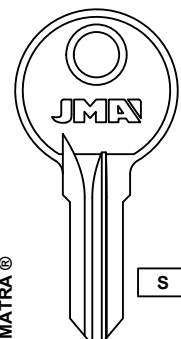
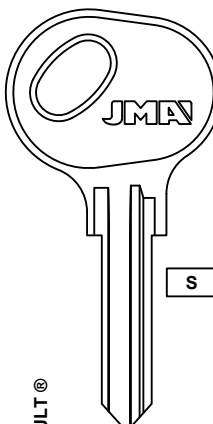
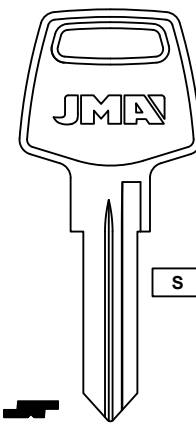
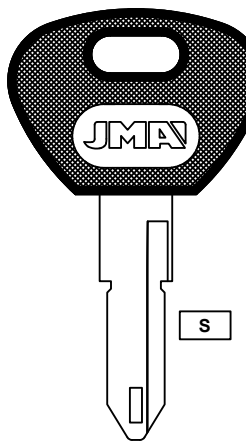
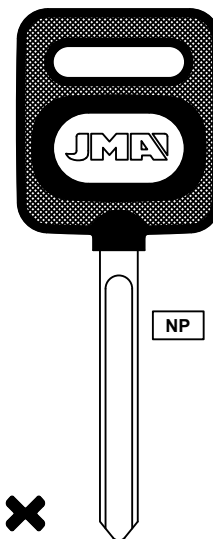
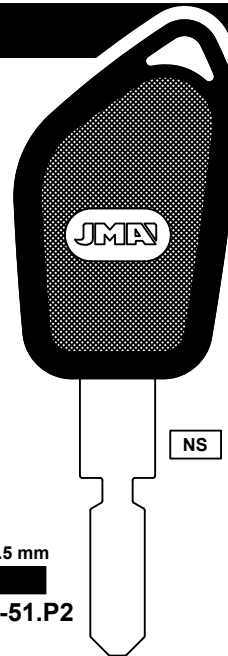
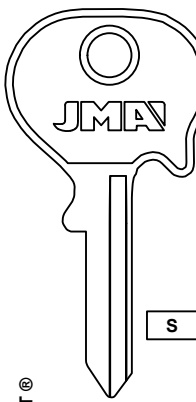
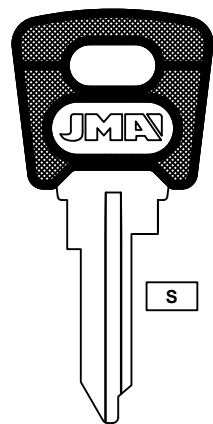
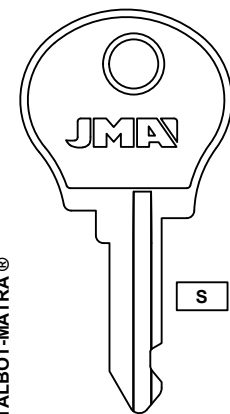
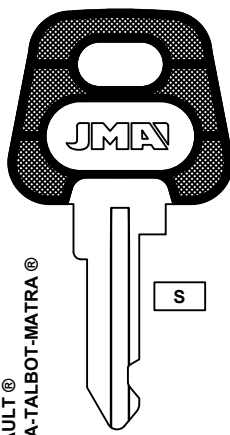
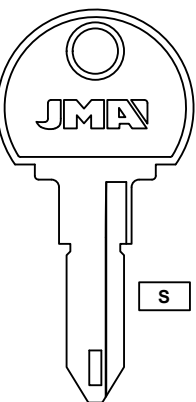
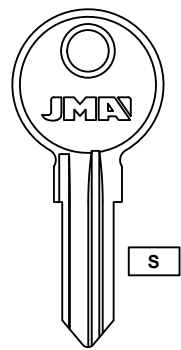
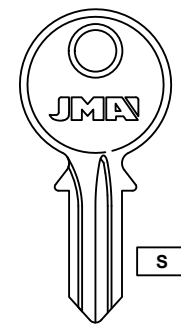
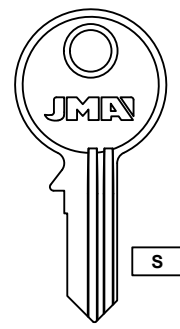
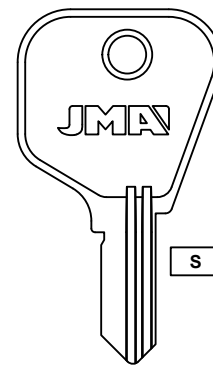
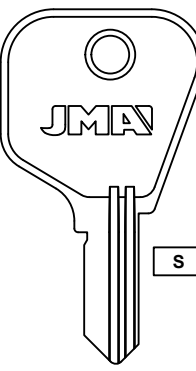
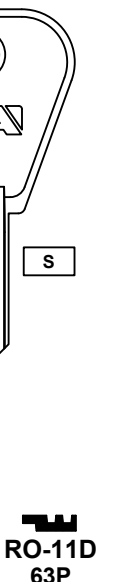

<p>Z ZAMAK</p> <p>NS N. SILVER / ALPACA</p> <p>S STEEL / ACERO</p> <p>NE NEON</p> <p>NP NICKEL PLATED / LATON NIQUELADO</p> <p>CM FUN COLOR</p> <p>CK CRISTAL KEYS / PLASTICO COLOR</p> <p>A ALUMINUM / ALUMINIO</p> <p>B BRASS / LATON</p>	<p>FOR: PETERBILT®</p>  <p>PER-1 1098PB</p>				<p>FOR: PEUGEOT®</p>  <p>FO-FK FT6</p>  <p>LAS-5 63H</p>  <p>LAS-5D R63H</p> <p>LAS-R KM8</p> <p>LAS-V KM9</p>				<p>FOR: PEUGEOT®</p>  <p>NE-20.P</p>  <p>NE-20.P2</p>  <p>NE-22.P RN24P</p>  <p>NE-29</p>			
	<p>FOR: PEUGEOT®</p>  <p>LAS-U N63G</p>  <p>LAS-X NR63G</p>  <p>LAS-Y KM2</p>  <p>LMP-2 RT19</p> <p>LMP-4 NE47</p> <p>LMP-5 NE45</p>				<p>FOR: PEUGEOT®</p>  <p>NE-29.P</p>  <p>NE-34.P</p>  <p>NE-51.P2 3.5 mm</p>  <p>NE-56 NE44</p>							
	<p>FOR: PEUGEOT®</p>  <p>NE-3.P1</p>  <p>NE-4 NE18</p>  <p>NE-4D</p>  <p>NE-4.P</p> <p>NE-20 RN30</p>				<p>FOR: PEUGEOT®</p>  <p>PJ-1 KM3</p>  <p>RO-21 R62Z</p>  <p>RO-2D 62Z</p>  <p>RO-71 VR61S</p>  <p>RO-111</p>  <p>RO-11D 63P</p>							



Concerning the marks and commercial denominations see note in index.

Concerniente a las marcas y denominaciones comerciales ver nota en indice.

Concernant les marques et denominations commerciales voir la note dans l'index.



Concerning the marks and commercial denominations see note in index.

Concerniente a las marcas y denominaciones comerciales ver nota en indice.

Concernant les marques et denominations commerciales voir la note dans l'index.

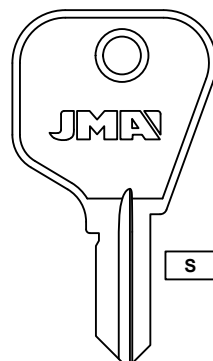
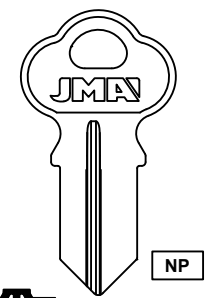
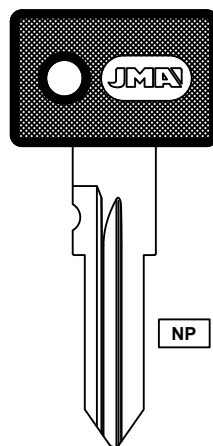
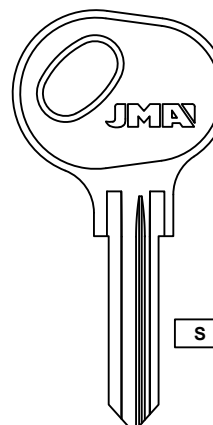
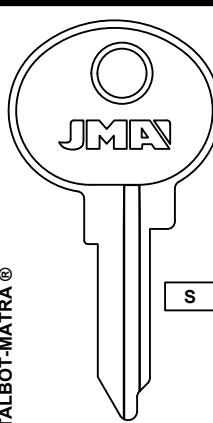
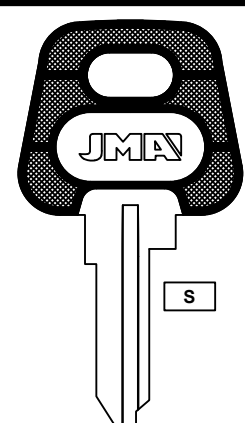
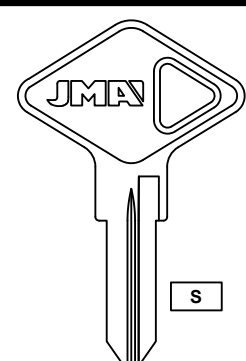
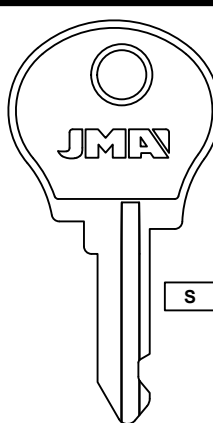
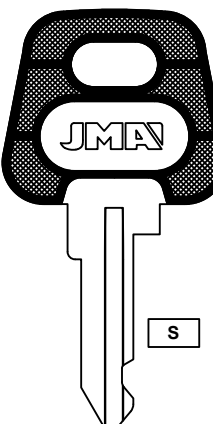
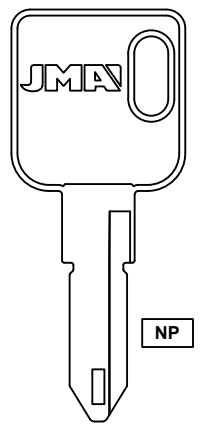
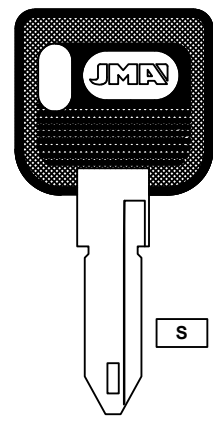
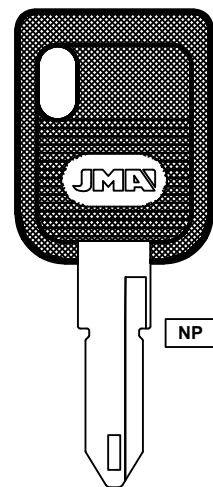

Z ZAMAK NS N.SILVER / ALPACA S STEEL / ACERO NE NEON NP NICKEL PLATED / LATON NIQUELADO CM FUN COLOR CK CRISTAL KEYS / PLASTICO COLOR A ALUMINUM / ALUMINIO B BRASS / LATON	FOR: PEUGEOT®  VA-6 63PX	FOR: POLARIS®  CHI-35 1041K CHI-4 1041GB CHI-3 1041GR	FOR: PORSCHE®  ZA-2.P ZD14RP	FOR: RENAULT®  LMP-1
	FOR: RENAULT®			
	FOR: SIMCA-TALBOT-MATRA®  NE-3 NE20	 NE-3.P	 NE-5 NE40	 NE-15D
	FOR: RENAULT®			
 NE-15D.P	 NE-19	 NE-19.P	 NE-19.P1	

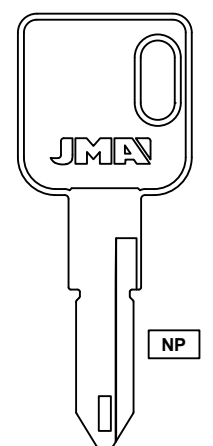
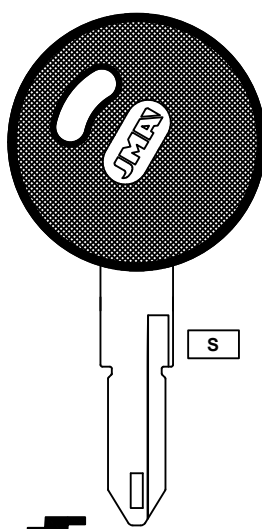
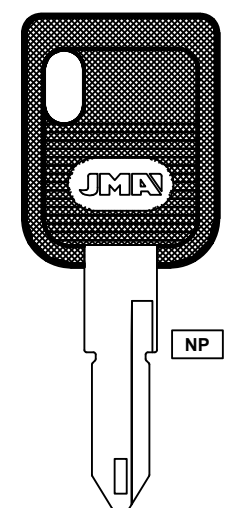
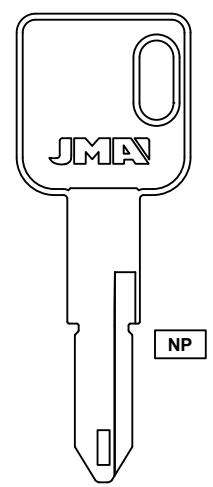
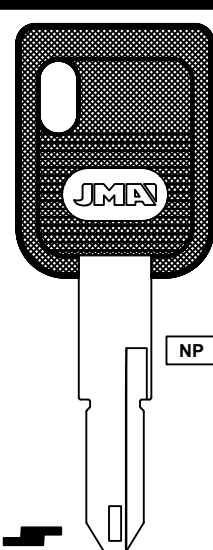
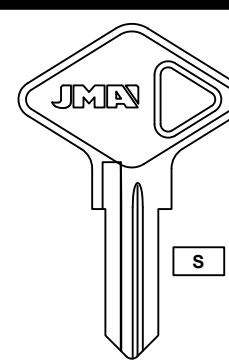
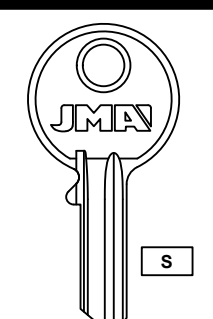
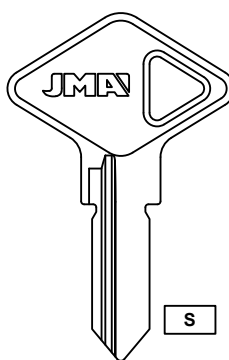
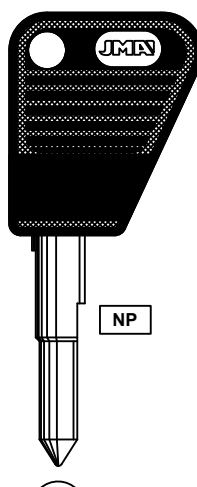
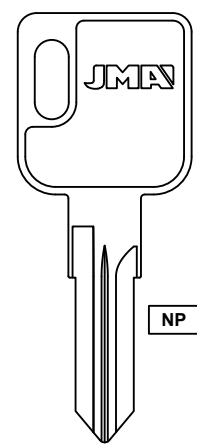
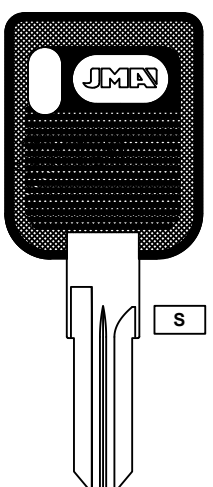
FOR: RENAULT®			
 NE-36	 NE-36.P	 NE-36.P1	 NE-38
FOR: RENAULT®			
 NE-38.P1	FOR: PANHARD® RO-6I 62R RO-2I R62Z	RO-6D 62U RO-2D 62Z	 RO-15
			 RO-16I HVR61 RO-16D HV61
FOR: RENAULT®			
 VA-7 VC29	 VA-17.P NE33	 VA-34	 VA-34.P



Concerning the marks and commercial denominations see note in index.

Concerniente a las marcas y denominaciones comerciales ver nota en indice.

Concernant les marques et denominations commerciales voir la note dans l'index.



Concerning the marks and commercial denominations see note in index.

Concerniente a las marcas y denominaciones comerciales ver nota en indice.

Concernant les marques et denominations commerciales voir la note dans l'index.

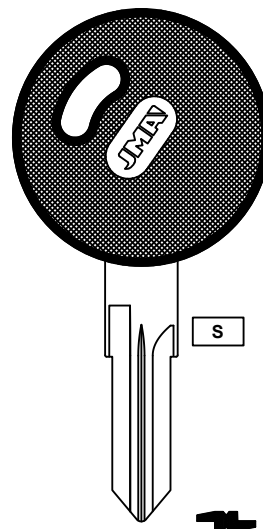
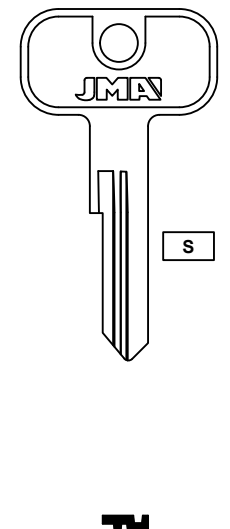
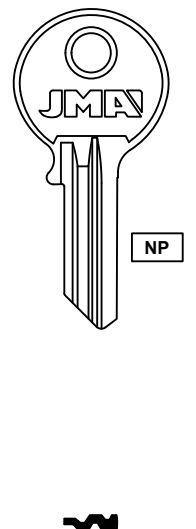
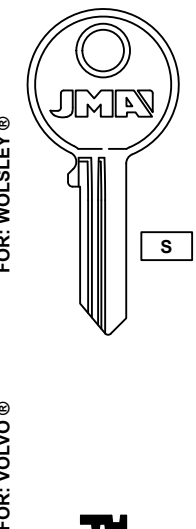
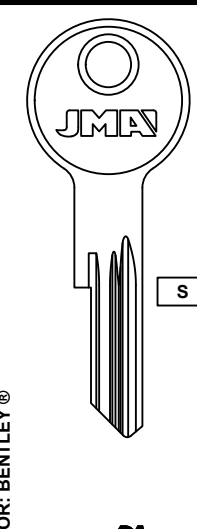
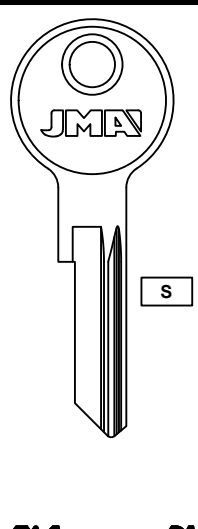
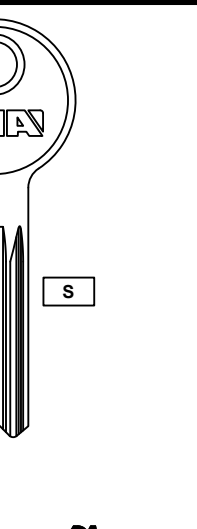
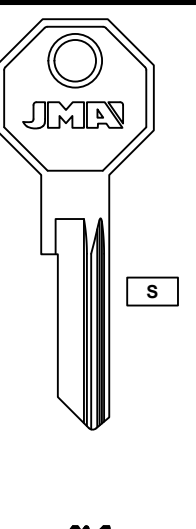
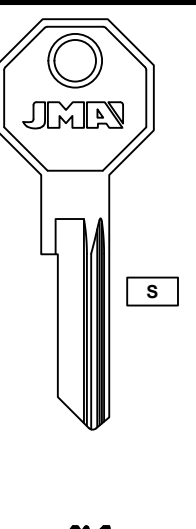
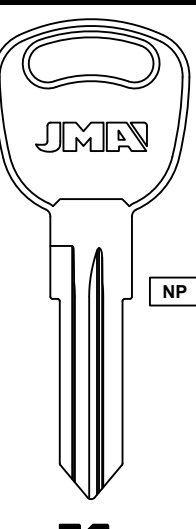
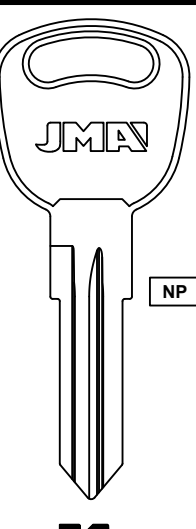
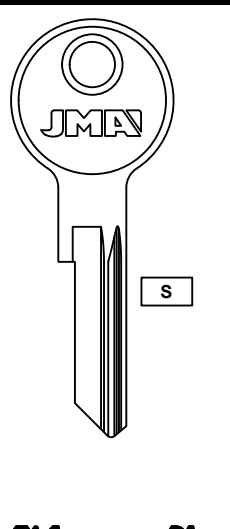
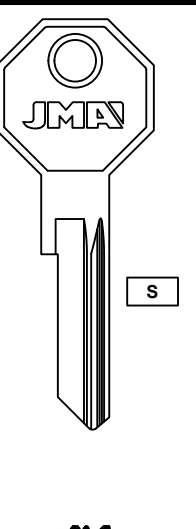
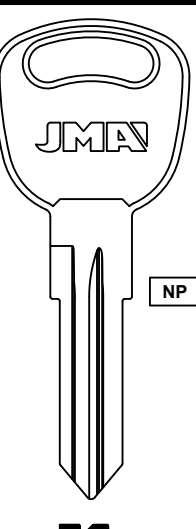
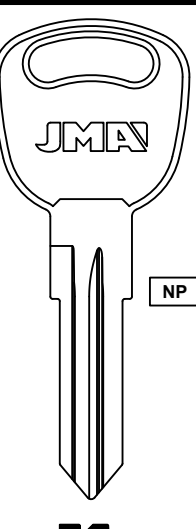
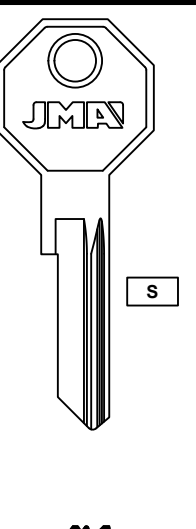
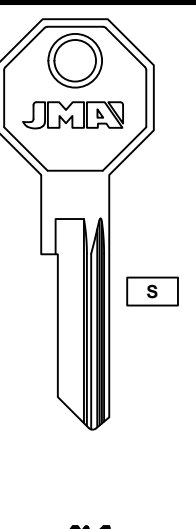
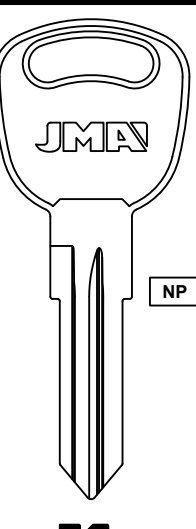
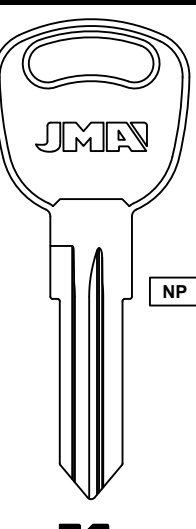
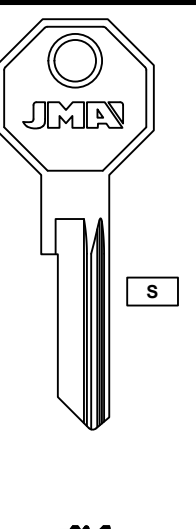
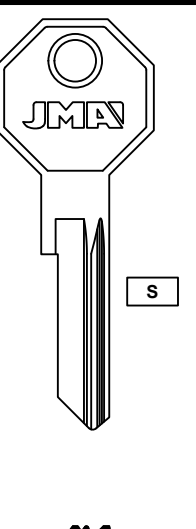
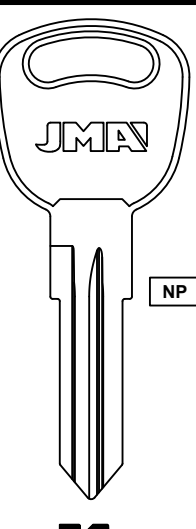
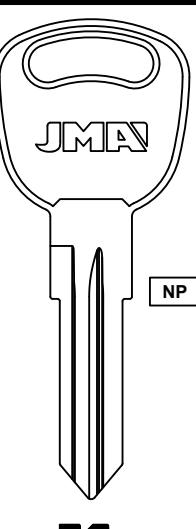
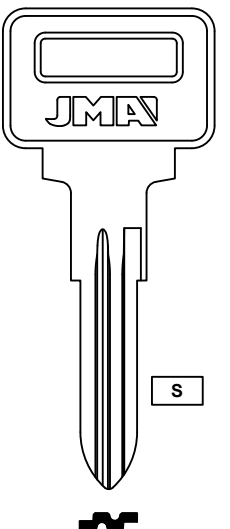
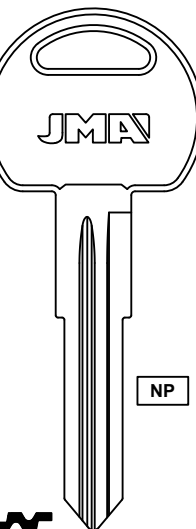
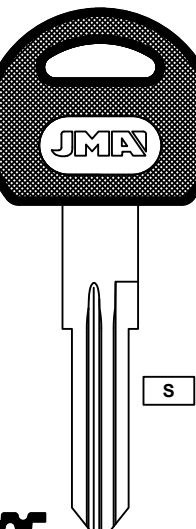
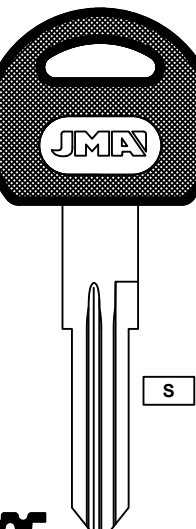
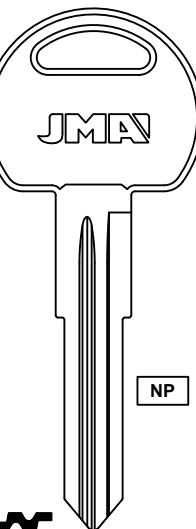
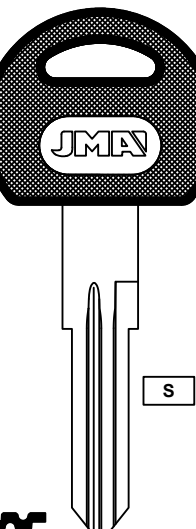
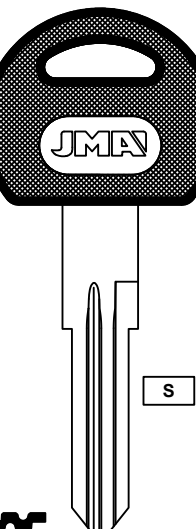
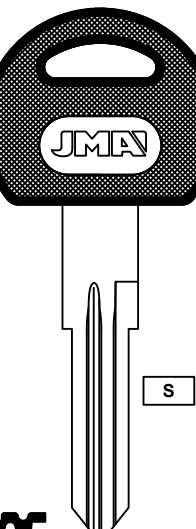
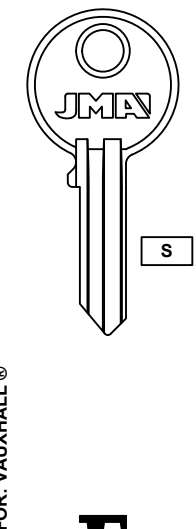
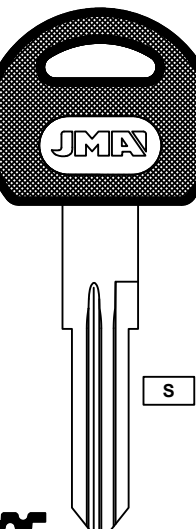
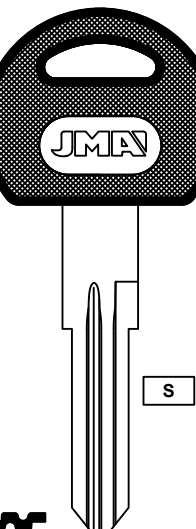
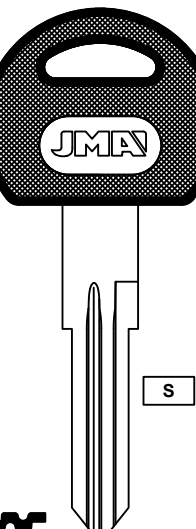

Z ZAMAK NS N.SILVER / ALPACA S STEEL / ACERO NE NEON NP NICKEL PLATED / LATON NIQUELADO CM FUN COLOR CK CRISTAL KEYS / PLASTICO COLOR A ALUMINUM / ALUMINIO B BRASS / LATON	FOR: RENAULT®  VA-34.P1	FOR: RILEY®  IN-1 H62DP	FOR: ROLLS ROYCE®  YA-16D YL5	
	FOR: VAUXHALL® FOR: WOLSKLEY®  UN-FP 62DP	FOR: ROLLS ROYCE®  YA-18D 62HD	FOR: ROLLS ROYCE®  YA-20I 62HG	FOR: ROLLS ROYCE®  YA-20D 62HE
	FOR: VAN GUARD® FOR: VOLVO®  UN-FP 62DP	FOR: ROLLS ROYCE®  YA-21I 62HF	FOR: ROLLS ROYCE®  FO-TX FC7	FOR: ROVER®  FO-TX FC7
	FOR: ROOTES GROUP® FOR: WOLSKLEY®  IN-1 H62DP	FOR: ROLLS ROYCE®  YA-21I 62HF	FOR: ROLLS ROYCE®  FO-TX FC7	FOR: ROVER®  FO-TX FC7
	FOR: VAUXHALL® FOR: WOLSKLEY®  UN-FP 62DP	FOR: ROLLS ROYCE®  YA-21I 62HF	FOR: ROLLS ROYCE®  FO-TX FC7	FOR: ROVER®  FO-TX FC7
	FOR: VAUXHALL® FOR: WOLSKLEY®  UN-FP 62DP	FOR: ROLLS ROYCE®  YA-21I 62HF	FOR: ROLLS ROYCE®  FO-TX FC7	FOR: ROVER®  FO-TX FC7
FOR: BEDFORD® FOR: BRITISH LEYLAND®  NE-10 VO73	FOR: ROLLS ROYCE®  YA-21I 62HF	FOR: ROLLS ROYCE®  FO-TX FC7	FOR: ROVER®  FO-TX FC7	
FOR: STERLING TRUCK®  NE-11 NE48	FOR: ROLLS ROYCE®  FO-TX FC7	FOR: ROLLS ROYCE®  FO-TX FC7	FOR: ROVER®  FO-TX FC7	
FOR: VAUXHALL®  UN-44 62DG	FOR: ROLLS ROYCE®  FO-TX FC7	FOR: ROLLS ROYCE®  FO-TX FC7	FOR: ROVER®  FO-TX FC7	

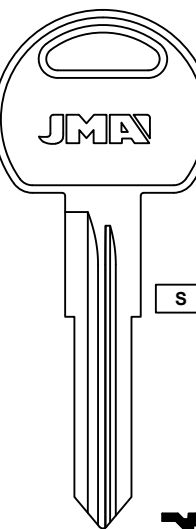
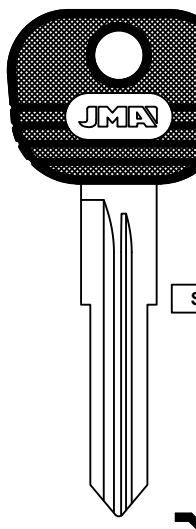
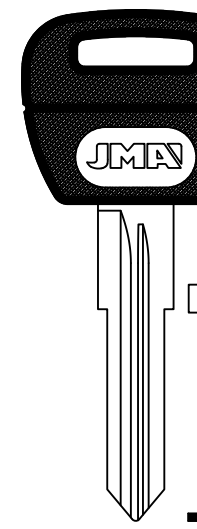
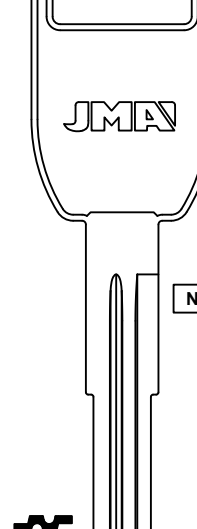
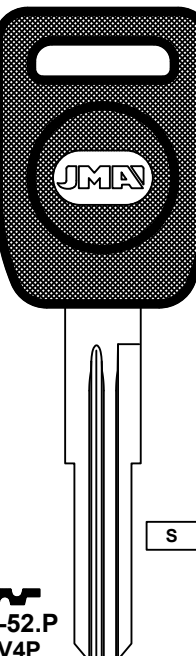
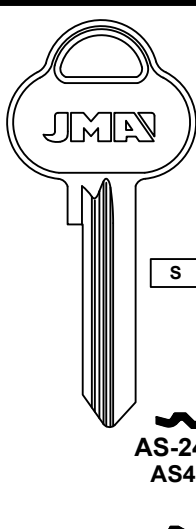
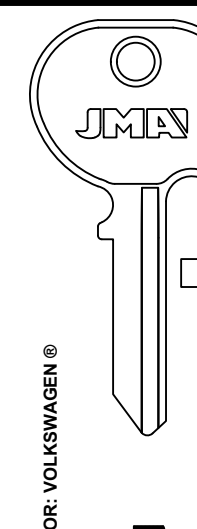
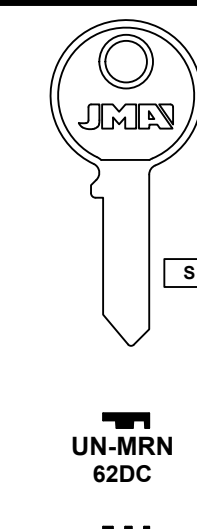
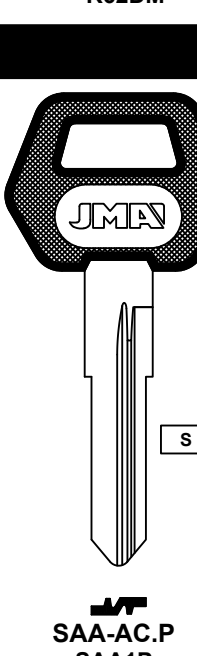
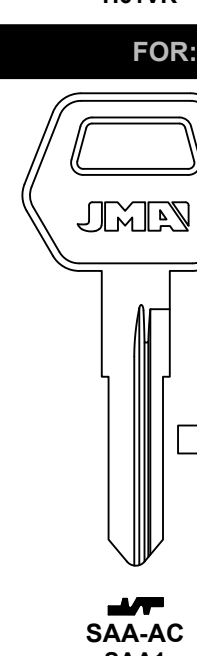
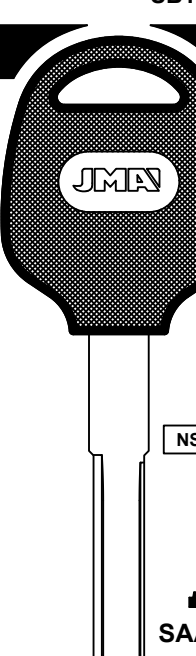
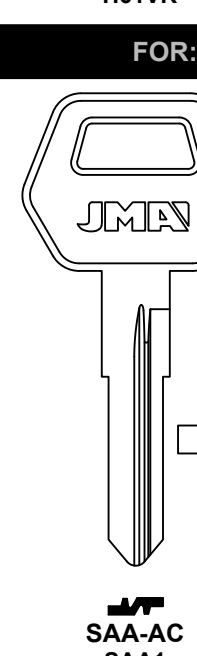
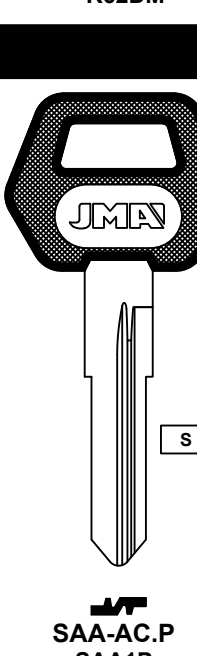
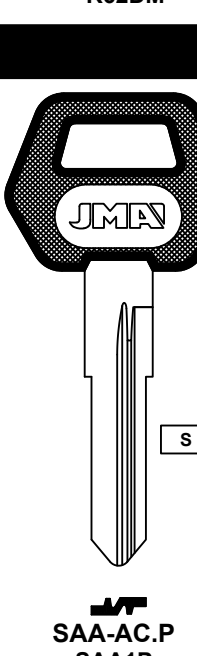
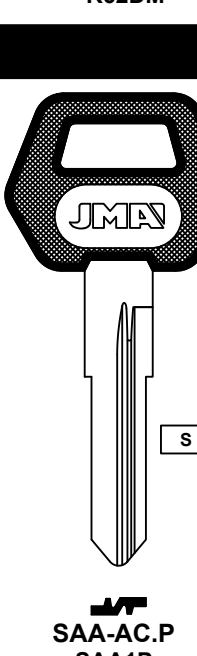
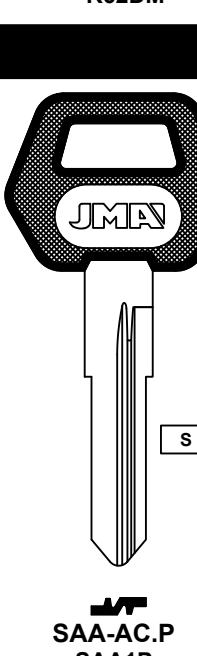
FOR: ROVER®  NE-35 NE71R	FOR: ROVER®  NE-35.P	FOR: ROVER®  NE-35.P2 NE71RDP	FOR: ROVER®  NE-52 RV4
FOR: ROVER®  NE-52.P RV4P	FOR: SAAB®  AS-24D AS41	FOR: SAAB®  AS-1D SB11	FOR: SAAB®  UN-MRN 62DC
FOR: SAAB®  UN-3 R62DM	FOR: SAAB®  NE-25 H61VR	FOR: SAAB®  SAA-1.P1	FOR: SAAB®  SAA-AC SAA1
FOR: SAAB®  SAA-AC.P SAA1P	FOR: SAAB®  SAA-AC.P SAA1P	FOR: SAAB®  SAA-AC.P SAA1P	FOR: SAAB®  SAA-AC.P SAA1P



Concerning the marks and commercial denominations see note in index.

Concerniente a las marcas y denominaciones comerciales ver nota en indice.

Concernant les marques et denominations commerciales voir la note dans l'index.



Concerning the marks and commercial denominations see note in index.

Concerniente a las marcas y denominaciones comerciales ver nota en indice.

Concernant les marques et denominations commerciales voir la note dans l'index.

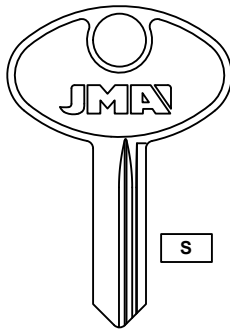
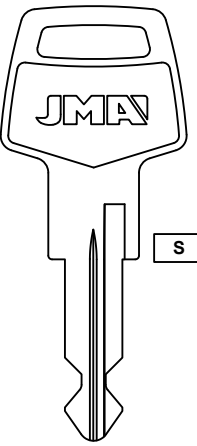
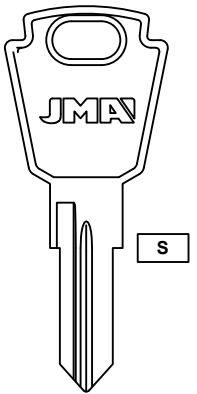
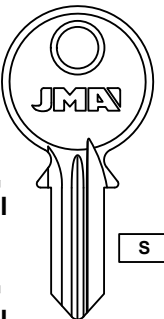
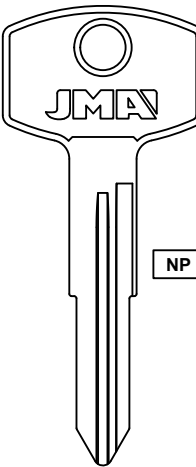
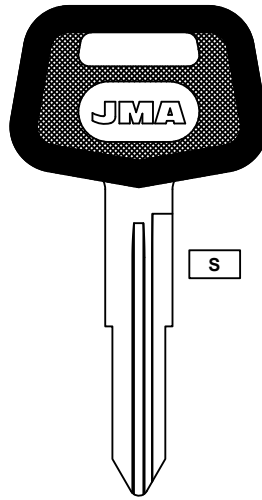
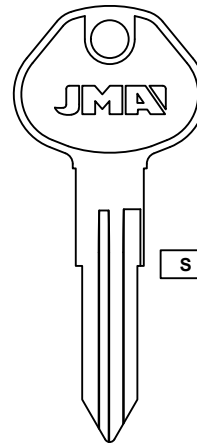
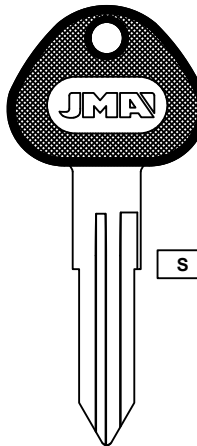
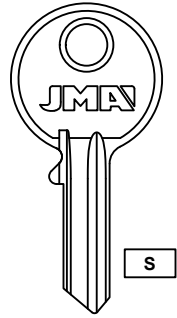
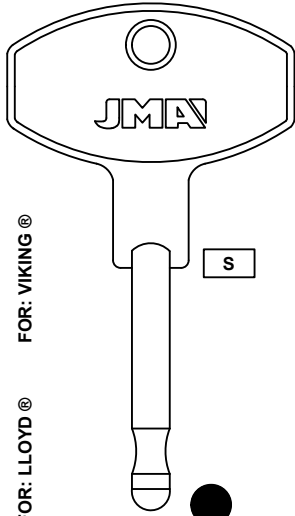
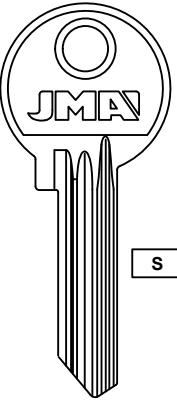
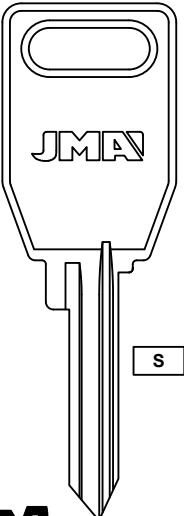
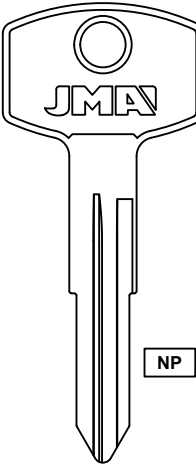
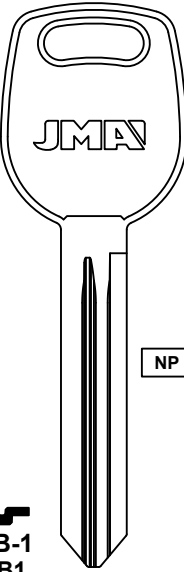
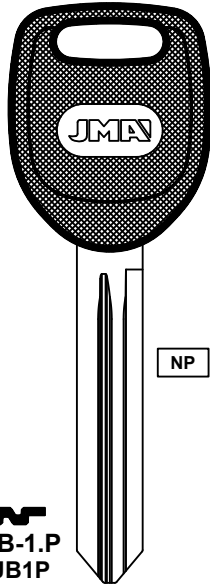
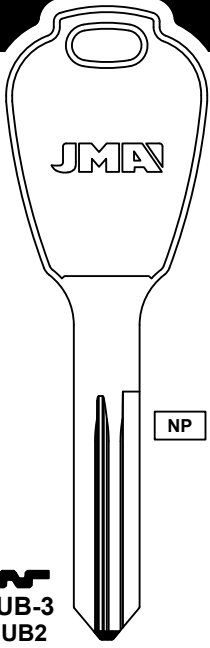
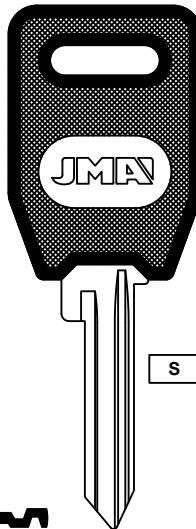
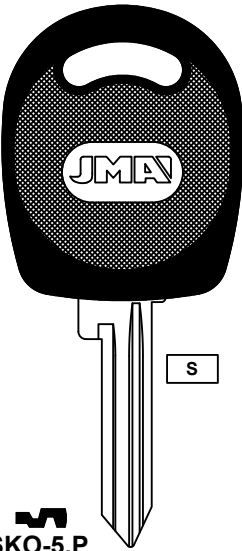
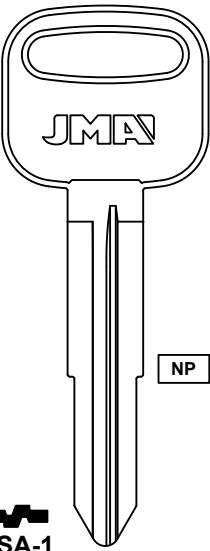
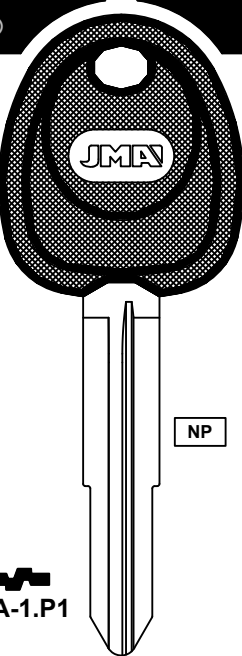
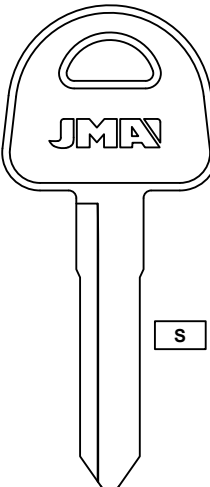
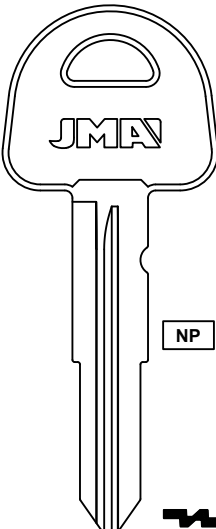
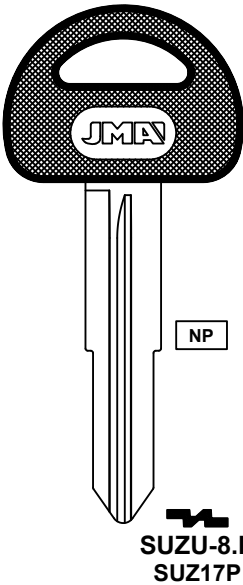
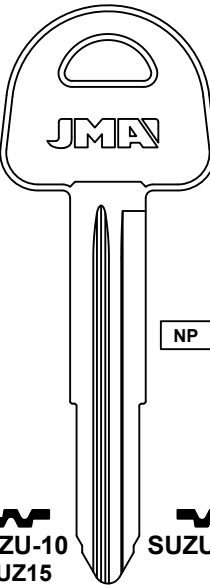

<p>Z ZAMAK</p> <p>NS N.SILVER / ALPACA S STEEL / ACERO</p> <p>NE NEON NP NICKEL PLATED / LATON NIQUELADO</p> <p>CM FUN COLOR CK CRISTAL KEYS / PLASTICO COLOR</p> <p>A ALUMINUM / ALUMINIO B BRASS / LATON</p>	<p>FOR: SEAT ®</p>  <p>AF-1I SE3C AF-1D SE4C</p>	<p>FOR: SIMCA-TALBOT-MATRA ®</p>    <p>RO-6I 62R RO-6D 62U RO-4I R62UC RO-4D 62UC RO-3 SM9C RO-2I R62Z RO-2D 62Z RO-1I SM6 RO-1D SM7</p> <p>CHR-3 NE34 RO-1IS 61P RO-1DS R61P</p>				<p>FOR: SUBARU ®</p>     <p>DAT-2I DA23 DAT-2I.P DA23P DAT-6 DAT-6.P DA25P</p>
	<p>FOR: SIMCA TALBOT-MATRA ®</p>  <p>RO-16I HVR61 RO-16D HV61</p>	<p>FOR: SKODA ®</p>  <p>FOR: LLOYD ® FOR: VIKING ®</p>   <p>BH-3 138 FB-19 65CE SKO-3I</p>				<p>FOR: SUBARU ®</p>     <p>DAT-2I 62DT SUB-1 SUB1 SUB-1.P SUB1P SUB-3 SUB2</p>
	<p>FOR: SKODA ®</p>   <p>SKO-3I.P SKO-5.P</p>		<p>FOR: SSANGYONG ®</p>   <p>SSA-1 SSA-1.P1</p>		<p>FOR: SUZUKI ®</p>     <p>SUZU-7 SUZU-8 SUZ17 SUZU-8.P SUZ17P SUZU-10 SUZ15 SUZU-10D</p>	

! Concerning the marks and commercial denominations see note in index.

Concerniente a las marcas y denominaciones comerciales ver nota en indice.

Concernant les marques et denominations commerciales voir la note dans l'index.



! Concerning the marks and commercial denominations see note in index.

Concerniente a las marcas y denominaciones comerciales ver nota en indice.

Concernant les marques et denominations commerciales voir la note dans l'index.



<p>Z ZAMAK</p> <p>NS N.SILVER / ALPACA</p> <p>S STEEL / ACERO</p> <p>NE NEON</p> <p>NP NICKEL PLATED / LATON NIQUELADO</p> <p>GH FUN COLOR</p> <p>GM CRISTAL KEYS / PLASTICO COLOR</p> <p>A ALUMINUM / ALUMINIO</p> <p>B BRASS / LATON</p>	FOR: SUZUKI®			
	SUZU-10.P SUZ15P	SUZU-19D.P SUZ20P	TOYO-14 DC1	TOYO-14.P DC1P
	FOR: SWEDISH CAMP CAR®		FOR: TITAN®	
	6 PIN - 22.50 mm			
	GH-GX GH1	GH-HX GH2	TIT-7D TT1	TOO-1D 1605
	FOR: TOOL BOX®		FOR: TOOL BOX®	
	HRD-2 1536R	HRD-2D 1536	TOO-1D 1605	TOO-1D 1605
FOR: TOOL BOX®		FOR: TOYOTA®		
TOO-2 1620	TOYO-2 T61F	TOYO-3	TOYO-K1 T61C	
			TOYO-4 TR28	

<p>Z ZAMAK</p> <p>NS N.SILVER / ALPACA</p> <p>S STEEL / ACERO</p> <p>NE NEON</p> <p>NP NICKEL PLATED / LATON NIQUELADO</p> <p>GH FUN COLOR</p> <p>GM CRISTAL KEYS / PLASTICO COLOR</p> <p>A ALUMINUM / ALUMINIO</p> <p>B BRASS / LATON</p>	FOR: TOYOTA®			
	TOYO-K1.P T61CP	TOYO-4.P TR28P	TOYO-5.P	TOYO-6 TA23
	FOR: TOYOTA®			
	TOYO-8I.P	TOYO-8.P	TOYO-9	TOYO-9.P TR40P
	FOR: TOYOTA®			
	TOYO-11	TOYO-11.P	TOYO-10.P1 TR46P	TOYO-13 TR37
	TOYO-10 TR39	TOYO-10.P		TOYO-12D
			TOYO-12 TR33	

! Concerning the marks and commercial denominations see note in index.

Concerniente a las marcas y denominaciones comerciales ver nota en indice.

Concernant les marques et denominations commerciales voir la note dans l'index.

! Concerning the marks and commercial denominations see note in index.

Concerniente a las marcas y denominaciones comerciales ver nota en indice.

Concernant les marques et denominations commerciales voir la note dans l'index.

FOR: TOYOTA®

 TOYO-12D.P TR33P	 TOYO-12.P TR33P	 TOYO-12D.P1	 TOYO-12.P1	 TOYO-15 TR47	 TOYO-15.P TR47P	 TOYO-15D.P
FOR: TOYOTA®						
 TOYO-16D	 TOYO-16	 TOYO-16.P	 TOYO-16.P1	 TOYO-17 TR53		
FOR: TOYOTA®						
 TOYO-17.P TR53P	 TOYO-18.P LXP90P	 TOYO-19.P	 TOYO-20 TR40	<p style="text-align: center;">FOR: MAZDA®</p>		

FOR: TOYOTA®

 TOYO-22	 TOYO-22D	 TOYO-25 TA6	 TOYO-27	 TOYO-28.P
FOR: TOYOTA®				
 TOYO-29	 TOYO-30.P1	 TOYO-34 TR46	 TOYO-33D TR44	 TOYO-35D TR25
FOR: TOYOTA®		FOR: TRABANT®		FOR: VAUXHALL®
 TOYO-39 T61B	 TOYO-40 TR47	 TOYO-40D	 DOB-2 DB2	 DOB-2D DB1
			 DOB-1D	 CEM-BP CE2

Z ZAMAK
 NS N.SILVER / ALPACA
 S STEEL / ACERO
 NE NEON
 NP NICKEL PLATED / LATON NIQUELADO
 FUN COLOR
 CM CRISTAL KEYS / PLASTICO COLOR
 A ALUMINUM / ALUMINIO
 B BRASS / LATON

Z ZAMAK
 NS N.SILVER / ALPACA
 S STEEL / ACERO
 NE NEON
 NP NICKEL PLATED / LATON NIQUELADO
 FUN COLOR
 CM CRISTAL KEYS / PLASTICO COLOR
 A ALUMINUM / ALUMINIO
 B BRASS / LATON

! Concerning the marks and commercial denominations see note in index.

Concerniente a las marcas y denominaciones comerciales ver nota en indice.

Concernant les marques et denominations commerciales voir la note dans l'index.



! Concerning the marks and commercial denominations see note in index.

Concerniente a las marcas y denominaciones comerciales ver nota en indice.

Concernant les marques et denominations commerciales voir la note dans l'index.



FOR: VOLKSWAGEN®

 AU-AN	 FOR: FORD INTERNATIONAL® FO-PN HR62FD	 HU-HAA.P1 HU66P	 PJ-2
-----------	---	------------------------	----------

FOR: VOLKSWAGEN®

 VO-1 LF12	 VO-2	 VO-2.P	 VO-2.D.P
 VO-5.P	 VO-8.P	 VO-8.P1	 VO-8.D.P1

FOR: VOLKSWAGEN®

 VO-VB	 VO-VBD	 VO-N V33	 VO-N.P
 VO-AH	 VO-10D	 VO-HV.P 73VBP	 VO-AH.P V37P
 VO-8	 VO-9D X132		

CM FUN COLOR

CK CRISTAL KEYS / PLASTICO COLOR

GM ALUMINUM / ALUMINIO

B BRASS / LATON

A ALUMINUM / ALUMINIO

NE NEON

NP NICKEL PLATED / LATON NIQUELADO

NS N.SILVER / ALPACA

S STEEL / ACERO

Z ZAMAK

FOR: VOLKSWAGEN®

 VO-11	 VO-FH.P1	 VO-K V78JK	 VO-L.P
-----------	--------------	-------------------	------------

FOR: VOLKSWAGEN®

 VO-M VW71	 VO-R VW71A	 VO-VA VW20	 VO-VB.P1
------------------	-------------------	-------------------	--------------

FOR: VOLVO®

 HU-DH.P S60HFP	 HU-DN.P	 NE-9 VO73S	 NE-10 VO73
-----------------------	-------------	-------------------	-------------------

CM FUN COLOR

CK CRISTAL KEYS / PLASTICO COLOR

GM ALUMINUM / ALUMINIO

B BRASS / LATON

A ALUMINUM / ALUMINIO

NE NEON

NP NICKEL PLATED / LATON NIQUELADO

NS N.SILVER / ALPACA

S STEEL / ACERO

Z ZAMAK

! Concerning the marks and commercial denominations see note in index.

Concerniente a las marcas y denominaciones comerciales ver nota en índice.

Concernant les marques et dénominations commerciales voir la note dans l'index.

! Concerning the marks and commercial denominations see note in index.

Concerniente a las marcas y denominaciones comerciales ver nota en índice.

Concernant les marques et dénominations commerciales voir la note dans l'index.



Z ZAMAK	FOR: VOLVO [®]			
	 NP NE-18 VL8	 S NE-18.P VL8P	 NP NE-40 NE66GTS	 NP NE-40.P S66NNP
NS N.SILVER / ALPACA				
S STEEL / ACERO				
NE NEON	FOR: VOLVO [®]		FOR: YAMAHA OUTBOARD [®]	FOR: YUGO [®]
	 NP NE-41.P S67NNP	 S UN-44 62DG	 NP YAMA-34D YH52	 S YU-1D YU1
NP NICKEL PLATED / LATON NIQUELADO				
CM FUN COLOR				
	CK CRISTAL KEYS / PLASTICO COLOR			
A ALUMINUM / ALUMINIO				
B BRASS / LATON				



Concerning the marks and commercial denominations see note in index.

Concerniente a las marcas y denominaciones comerciales ver nota en índice.



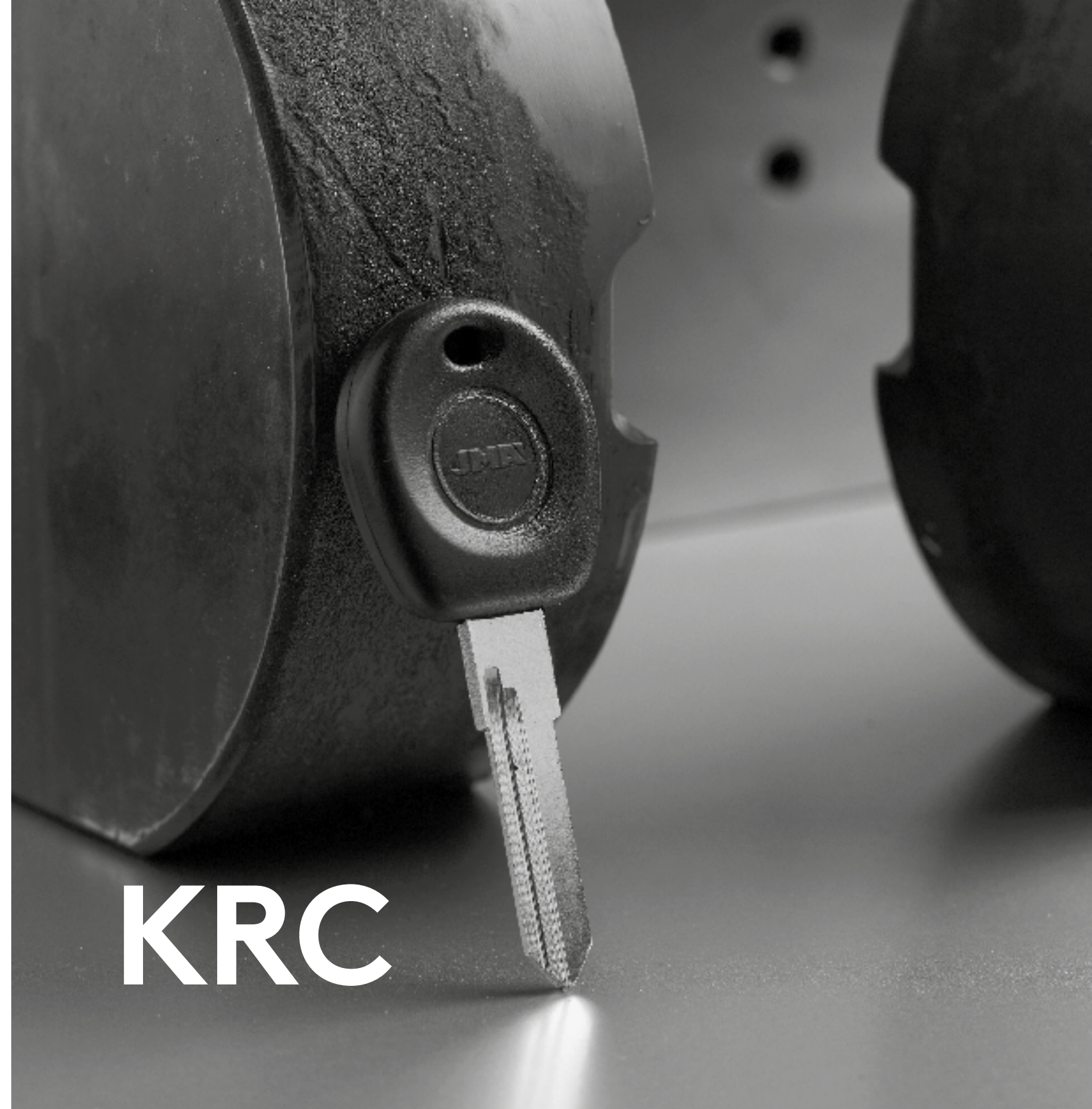















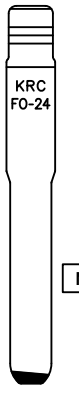

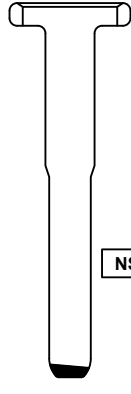
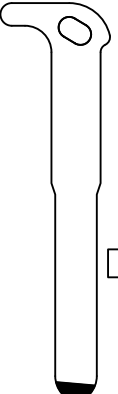
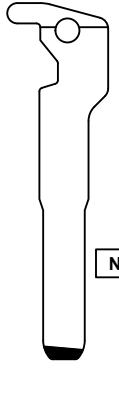

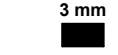

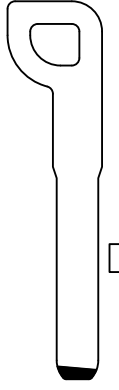

Concernant les marques et dénominations commerciales voir la note dans l'index.

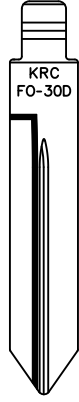

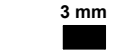
KRC

VEHICLE KEYS

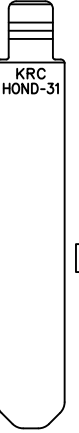
Llaves de vehículos
Clés de voitures

FOR: CHRYSLER®		FOR: DACIA®		FOR: FIAT®		FOR: FORD®	
	NP		NP		NP		NP
	KRCCHR-15		KRCDAC-6D		KRCFI-13		KRCFO-15D
				FOR: GIOBERT®			
	NP						
	KRCFO-24						
FOR: FORD®							
	NS		NS		NS		NS
	FO-24C1		FO-24C3 HU198T		FO-24C4		FO-24C5
	NS						
	FO-24C6						
FOR: FORD®				FOR: G. MOTORS®		FOR: HONDA®	
	NS		NS		NP		NP
	FO-24C7		FO-24C9		KRCFO-30D		KRCGM-37
	NP						
	KRCHOND-31						

Z ZAMAK
 NS N.SILVER / ALPACA
 S STEEL / ACERO
 NE NEON
 NP NICKEL PLATED / LATON NIQUELADO
 CM FUN COLOR
 CK CRISTAL KEYS / PLASTICO COLOR
 A ALUMINUM / ALUMINIO
 B BRASS / LATON

! Concerning the marks and commercial denominations see note in index.

Concerniente a las marcas y denominaciones comerciales ver nota en indice.

Concernant les marques et denominations commerciales voir la note dans l'index.



Z ZAMAK	NS N.SILVER / ALPACA S STEEL / ACERO	FOR: HYUNDAI®		FOR: MAZDA®		FOR: MITSUBISHI®		FOR: NISSAN®			
		 KRC HY-18 NP	 KRC HY-20 NP	 KRC MAZ-11D NP	 KRC MIT-8D NP	 KRC DAT-15 NP	 KRCHY-18	 KRCHY-20 2.95 mm	 KRCMAZ-11D	 KRCMIT-8D	 KRCDAT-15
NE NEON NP NICKEL PLATED / LATON NIQUELADO	CM FUN COLOR CK CRISTAL KEYS / PLASTICO COLOR	FOR: OPEL®				FOR: PEUGEOT®					
		 KRC OP-D NP	 KRC OP-S NP	 OP-11C1 NS	 OP-WHC1 NS	 PEU-1C1 NS	 KRCOP-D	 KRCOP-S	 OP-11C1 2.97 mm	 OP-WHC1	 PEU-1C1 3 mm
A ALUMINUM / ALUMINIO B BRASS / LATON		FOR: PEUGEOT®		FOR: RENAULT®							
		 PEU-2C1 NS	 KRCNE-36 NP	 NE-60C1 S	 KRCVA-34 NP	 VA-61C1 S	 PEU-2C1 3.5 mm	 KRCNE-36	 NE-60C1	 KRCVA-34	 VA-61C1

Z ZAMAK	NS N.SILVER / ALPACA S STEEL / ACERO	FOR: SUZUKI®		FOR: TOYOTA®			FOR: VOLKSWAGEN®		
		 KRCSUZU-14 NP	 KRCTOYO-15 NP	 KRCTOYO-19 NP	 KRCTOYO-20D NP	 KRCHU-HAA NP	 KRCSUZU-14	 KRCTOYO-15	 KRCTOYO-19
NE NEON NP NICKEL PLATED / LATON NIQUELADO	CM FUN COLOR CK CRISTAL KEYS / PLASTICO COLOR	FOR: VOLKSWAGEN®							
		 HU-HAAC2 NS	 HU-HAAC4 NS	 HU-HAAC5 NS	 HU-HAAC2	 HU-HAAC4	 HU-HAAC5	 HU-HAAC2	 HU-HAAC4



Concerning the marks and commercial denominations see note in index.

Concerniente a las marcas y denominaciones comerciales ver nota en indice.

Concernant les marques et denominations commerciales voir la note dans l'index.



Concerning the marks and commercial denominations see note in index.

Concerniente a las marcas y denominaciones comerciales ver nota en indice.

Concernant les marques et denominations commerciales voir la note dans l'index.





MOTORCYCLE KEYS

Llaves de motocicleta
Clés de motos

FOR: APRILIA®		FOR: BAJAJ®	
<p>FOR: BIMOTA®</p> <p>ZA-6D.P1 ZD22RBP</p>	<p>FOR: BOXER® FOR: DISCOVERY® FOR: PULSAR®</p> <p>BAJ-1</p>	<p>FOR: BOXER® FOR: DISCOVERY® FOR: PULSAR®</p> <p>BAJ-4.P</p>	<p>FOR: TVS®</p> <p>BAJ-2.P BAJ-2D.P</p>
FOR: BAJAJ®			
<p>FOR: PULSAR® FOR: SUZUKI® FOR: TVS®</p> <p>BAJ-2.P2</p>	<p>FOR: DISCOVERY®</p> <p>BAJ-2.P3</p>	<p>3 mm</p> <p>BAJ-3.P</p>	<p>3 mm</p> <p>BAJ-3.P1</p>
FOR: BAJAJ®		FOR: BMW MOTORCYCLE®	
<p>FOR: BOXER® FOR: DISCOVERY®</p> <p>BAJ-5.P</p>	<p>HB</p> <p>BM-HB BMW2</p>	<p>HB</p> <p>BM-HB.P BMW2P</p>	<p>DIAMETRO EXTERIOR 9.5 mm DIAMETRO INTERIOR 7.9 mm</p> <p>CHI-1T 1137B</p>

Z ZAMAK
 NS N SILVER / ALPACA
 S STEEL / ACERO
 NE NEON
 NP NICKEL PLATED / LATON NIQUELADO
 CM FUN COLOR
 CK CRISTAL KEYS / PLASTICO COLOR
 A ALUMINUM / ALUMINIO
 B BRASS / LATON

! Concerning the marks and commercial denominations see note in index.

Concerniente a las marcas y denominaciones comerciales ver nota en indice.

Concernant les marques et denominations commerciales voir la note dans l'index.



Z ZAMAK
NS N.SILVER / ALPACA
S STEEL / ACERO
NE NEON
NP NICKEL PLATED / LATON NIQUELADO
CM FUN COLOR
CK CRISTAL KEYS / PLASTICO COLOR
A ALUMINUM / ALUMINIO
B BRASS / LATON

Z ZAMAK
NS N.SILVER / ALPACA
S STEEL / ACERO
NE NEON
NP NICKEL PLATED / LATON NIQUELADO
CM FUN COLOR
CK CRISTAL KEYS / PLASTICO COLOR
A ALUMINUM / ALUMINIO
B BRASS / LATON

FOR: BMW MOTORCYCLE®

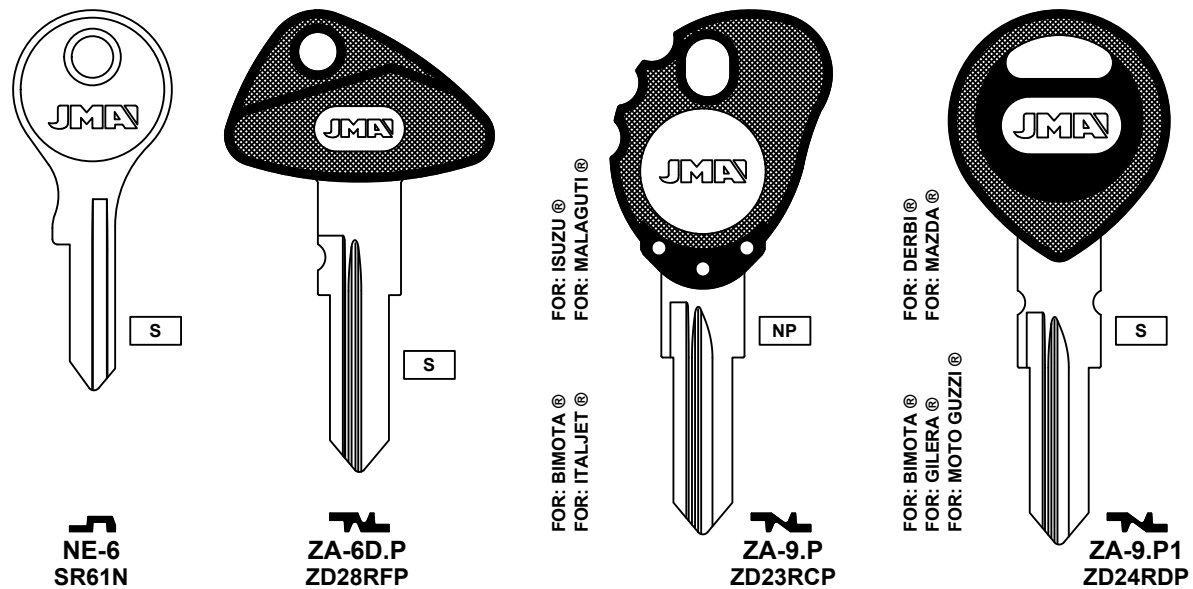

FOR: CAGIVA®

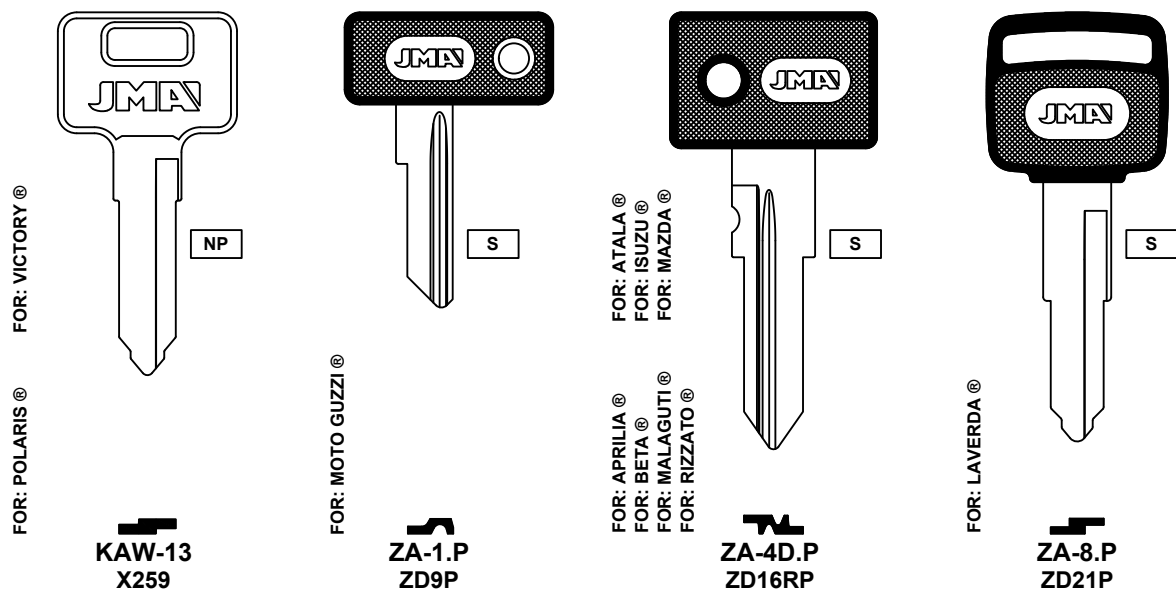

FOR: GILERA®

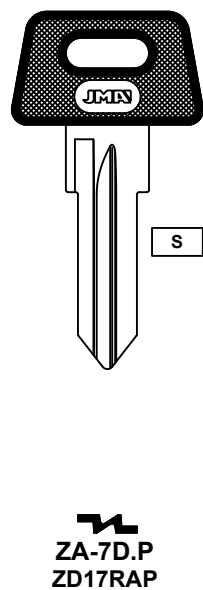

FOR: GIVI®

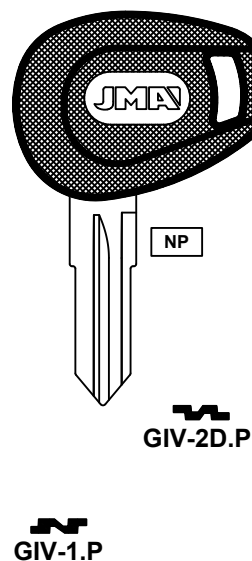

FOR: HARLEY DAVIDSON®

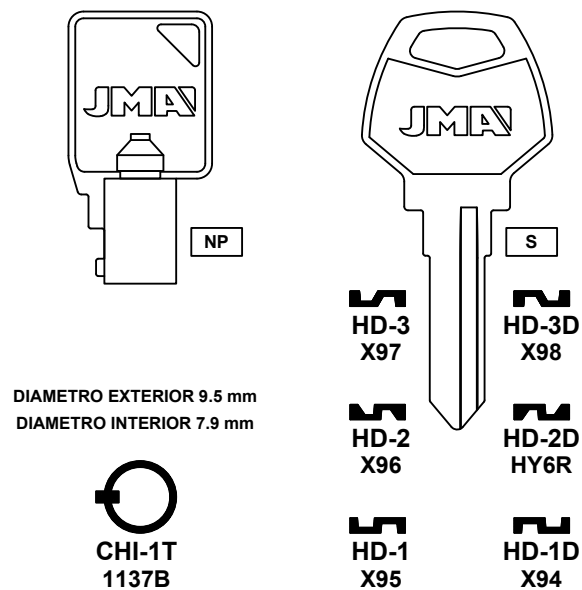

FOR: HARLEY DAVIDSON®

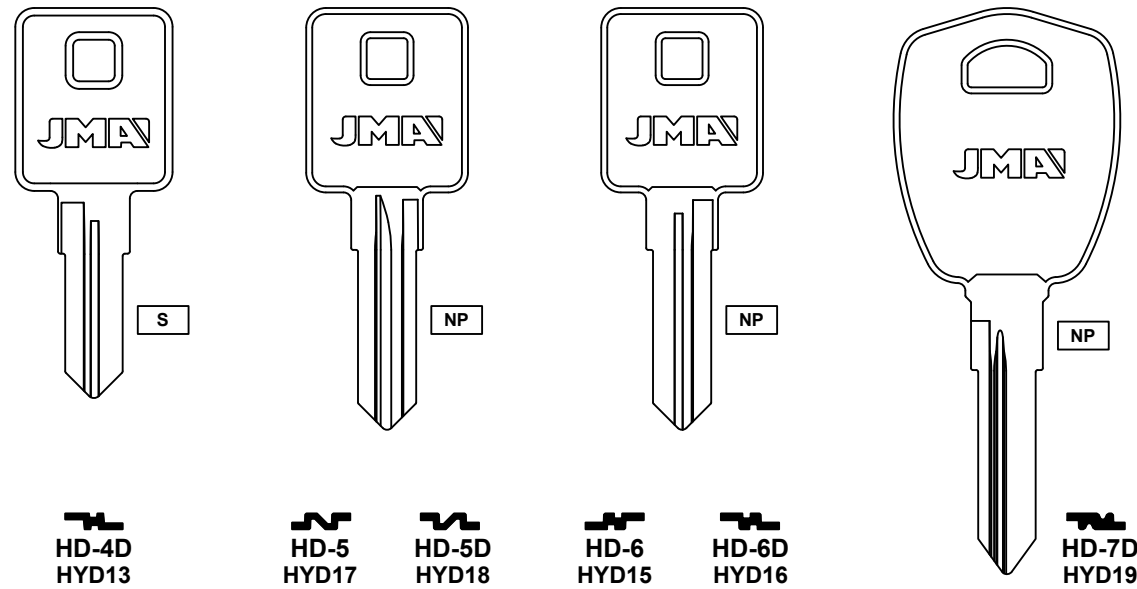

FOR: HONDA®

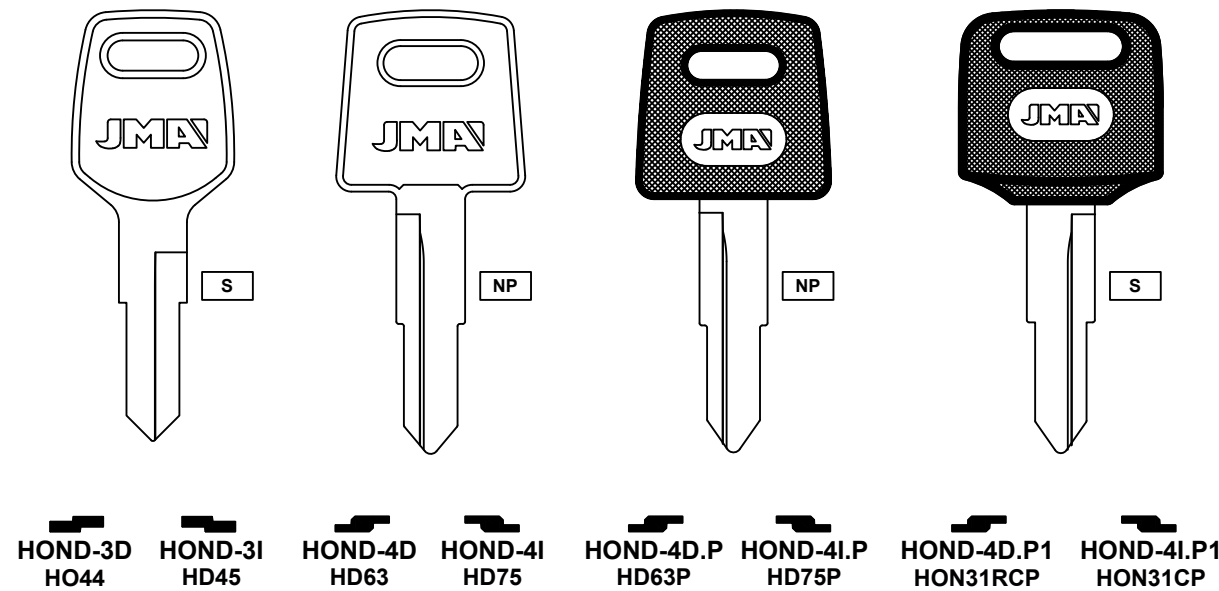

FOR: HONDA®

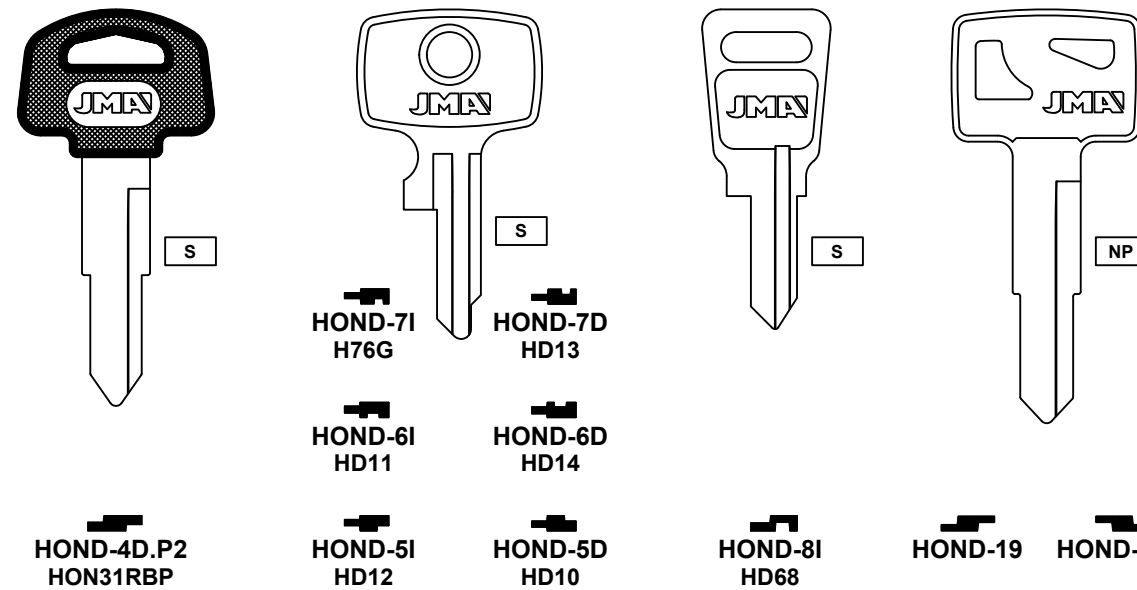

Concerning the marks and commercial denominations see note in index.

Concerniente a las marcas y denominaciones comerciales ver nota en indice.

Concernant les marques et denominations commerciales voir la note dans l'index.



Concerning the marks and commercial denominations see note in index.

Concerniente a las marcas y denominaciones comerciales ver nota en indice.

Concernant les marques et denominations commerciales voir la note dans l'index.



Z ZAMAK	NS N.SILVER / ALPACA S STEEL / ACERO	FOR: HONDA®			
		HOND-19.P	HOND-19D.P HON39P	HOND-20 HON42	HOND-20D HON42
NE NEON NP NICKEL PLATED / LATON NIQUELADO	S S	FOR: HONDA®			
		HOND-28.P HON41P	HOND-28D.P HON41P	HOND-29.P HON41P	HOND-29D.P HON41P
CM FUN COLOR CK CRISTAL KEYS / PLASTICO COLOR	A ALUMINUM / ALUMINIO B BRASS / LATON	FOR: HONDA®			
		HOND-36.P1	HOND-36D.P1	HOND-36D.P4	HOND-42.P
A ALUMINUM / ALUMINIO B BRASS / LATON	S S	FOR: HONDA®			
		HOND-43.P HON64BP	HOND-43D.P HON64RBP	HOND-43.P HON64BP	HOND-43D.P HON64RBP

Z ZAMAK	NS N.SILVER / ALPACA S STEEL / ACERO	FOR: HONDA®					
		HOND-47D.P	HOND-48.P	HOND-48D.P	HOND-50 HD109		
NE NEON NP NICKEL PLATED / LATON NIQUELADO	S S	FOR: HONDA®					
		HOND-52 HD105	HOND-52D HD108	HOND-57.P	HOND-57D.P		
CM FUN COLOR CK CRISTAL KEYS / PLASTICO COLOR	A ALUMINUM / ALUMINIO B BRASS / LATON	FOR: HONDA®		FOR: ITALIKA®			
		HOND-59.P	HOND-59D.P	HOND-60D.P	ZA-9.P1 ZD24RDP	ITA-1	ITA-1D

! Concerning the marks and commercial denominations see note in index.

Concerniente a las marcas y denominaciones comerciales ver nota en indice.

Concernant les marques et denominations commerciales voir la note dans l'index.

! Concerning the marks and commercial denominations see note in index.

Concerniente a las marcas y denominaciones comerciales ver nota en indice.

Concernant les marques et denominations commerciales voir la note dans l'index.







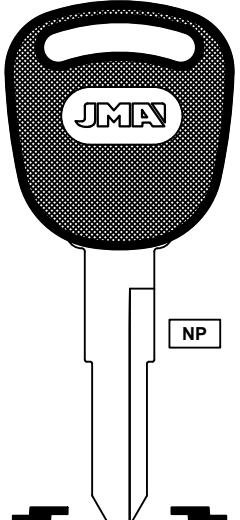
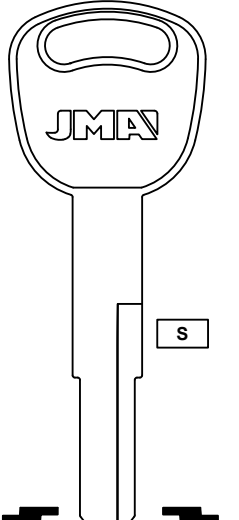
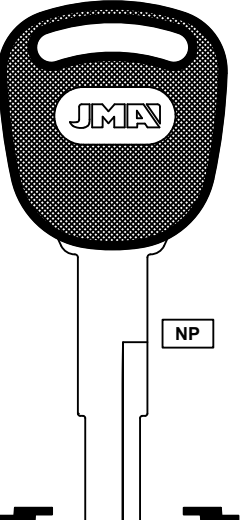
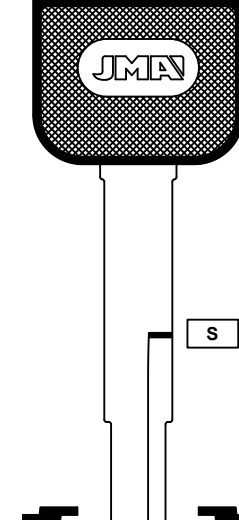

Z ZAMAK NS N. SILVER / ALPACA S STEEL / ACERO NE NEON NP NICKEL PLATED / LATON NIQUELADO N FUN COLOR GM CRISTAL KEYS / PLASTICO COLOR A ALUMINUM / ALUMINIO B BRASS / LATON	FOR: ITALIKA®				FOR: KAWASAKI®								
	ITA-1.P	ITA-1D.P	ITA-2.P 2.40 mm	ITA-3.P	KAW-21 X91	KAW-2D X90	KAW-11 KA11	KAW-1D KA15					
FOR: KAWASAKI®								FOR: KAWASAKI®					
KAW-3 KA14	KAW-4 KA13	KAW-5 KW12	KAW-5.P	KAW-13 X259	KAW-14 X257	KAW-14D X256	KAW-15 X255	KAW-15D X254	YAMA-19D YH49	YAMA-19I YH48	YAMA-18D YH47	YAMA-18I YH46	ZA-12 ZD7
FOR: KAWASAKI®								FOR: KAWASAKI®					
KAW-6.P KW14AP	KAW-6D.P	KAW-7 KA30	KAW-7.P KW15BP	KAW-9 KA31	HD-4D HYD13	HOND-4I HD75	HOND-4I.P1 HON31CP	HOND-5I HD74					

Z ZAMAK NS N. SILVER / ALPACA S STEEL / ACERO NE NEON NP NICKEL PLATED / LATON NIQUELADO N FUN COLOR GM CRISTAL KEYS / PLASTICO COLOR A ALUMINUM / ALUMINIO B BRASS / LATON	FOR: KAWASAKI®				FOR: KAWASAKI®						
	KAW-9.P	KAW-10.P	KAW-10D.P	KAW-11 X261	KAW-11D X260	KAW-12D X262	KAW-13D X258	KAW-12D X262			
FOR: KAWASAKI®								FOR: KAWASAKI®			
KAW-13 X259	KAW-14 X257	KAW-14D X256	KAW-15 X255	KAW-15D X254	YAMA-19D YH49	YAMA-19I YH48	YAMA-18D YH47	YAMA-18I YH46	ZA-12 ZD7		
FOR: KAWASAKI®								FOR: KAWASAKI®			
HD-4D HYD13	HOND-4I HD75	HOND-4I.P1 HON31CP	HOND-5I HD74	KAW-9 KA31							

! Concerning the marks and commercial denominations see note in index.
 Concerniente a las marcas y denominaciones comerciales ver nota en indice.
 Concernant les marques et denominations commerciales voir la note dans l'index.

! Concerning the marks and commercial denominations see note in index.
 Concerniente a las marcas y denominaciones comerciales ver nota en indice.
 Concernant les marques et denominations commerciales voir la note dans l'index.

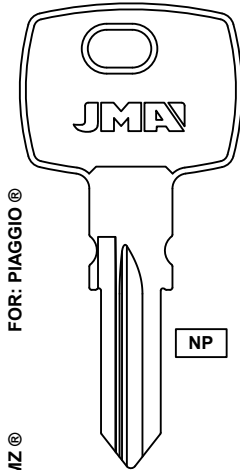
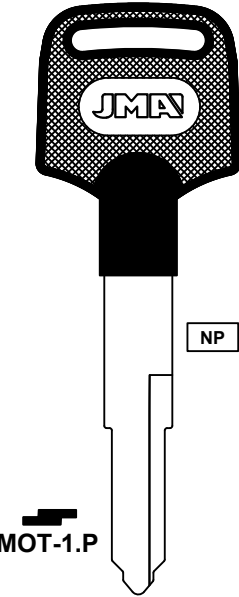
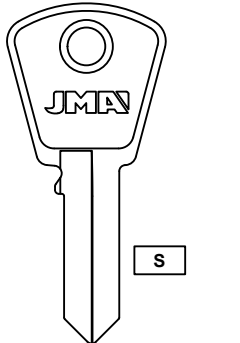
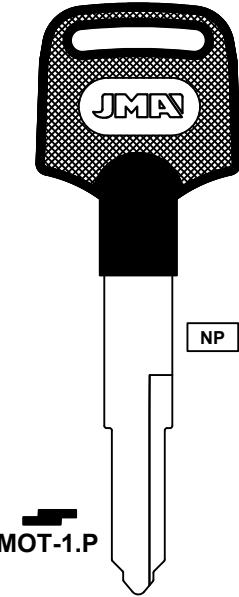
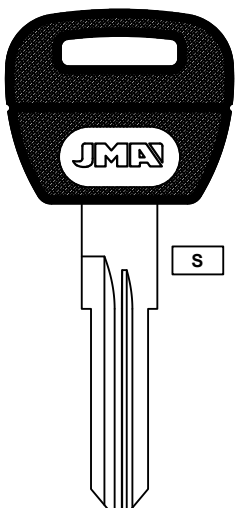
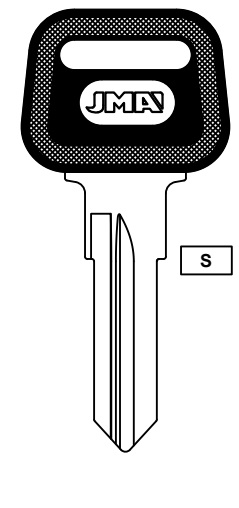
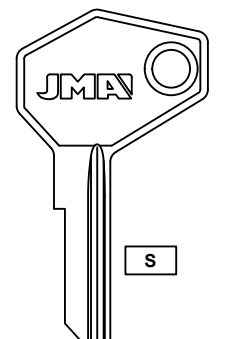
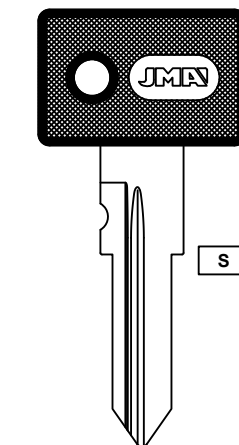
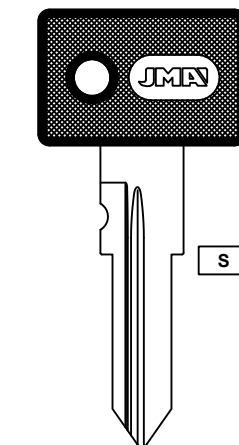

Z ZAMAK NS N. SILVER / ALPACA S STEEL / ACERO NE NEON NP NICKEL PLATED / LATON NIQUELADO FM FUN COLOR GM ALUMINUM / ALUMINIO CK BRASS / LATON A ALUMINUM / ALUMINIO B BRASS / LATON	FOR: KYMCO®  NP  S  NP  S  KYM1P  KYM1RP  KYM2  KYM2D.P  KYM-2.P  KYM-2D.P  KYM-3.P  KYM-3D.P			
	FOR: KYMCO®  NP  NP FOR: MALAGUTI® FOR: MZ® FOR: MOTO GUZZI® FOR: PIAGGIO® FOR: MAZDA® FOR: MOTO GUZZI® TRP-1D TMC1 ZA-9.P1 ZD24RDP CAM-1D LA13		FOR: LAMBRETTA®  S FOR: MOTOMEL®  NP	
	FOR: PEUGEOT MOTORCYCLE®  S  S  S  S NE-35.P2 NE71RDP NE-45.P NE74P ZA-12 ZD7 ZA-4D.P ZD16RP			
	FOR: PIAGGIO®  S			

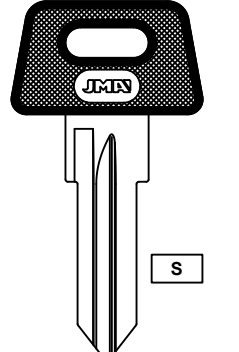
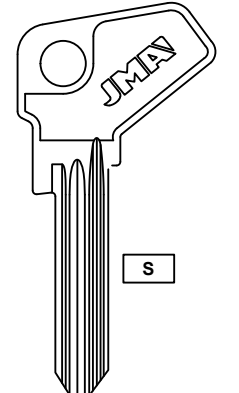
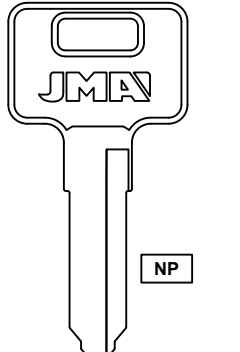
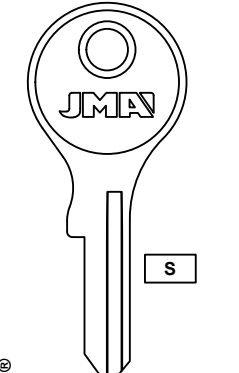
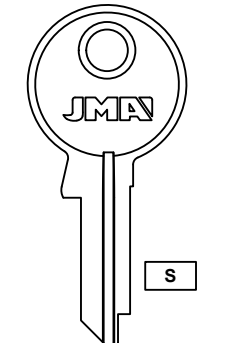
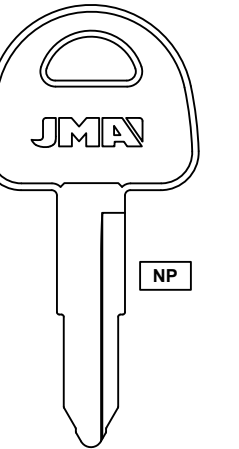
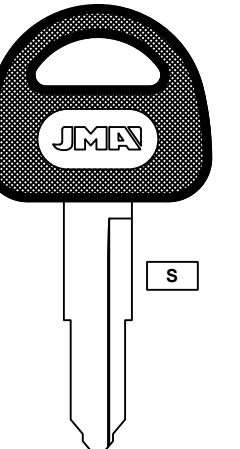
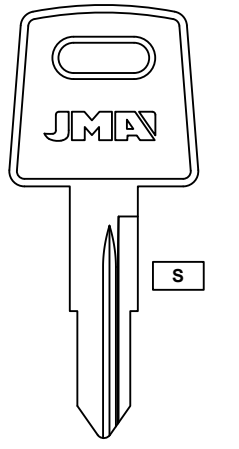
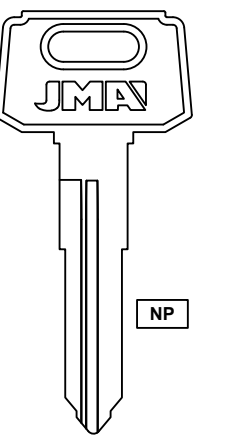
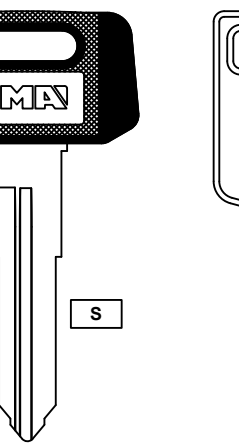
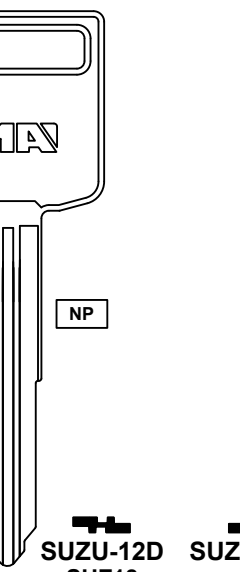
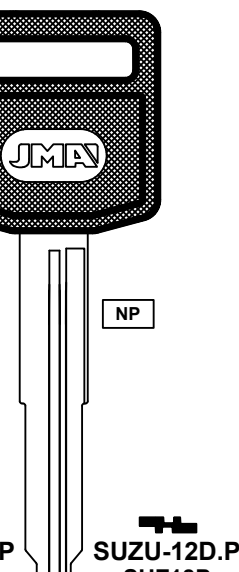
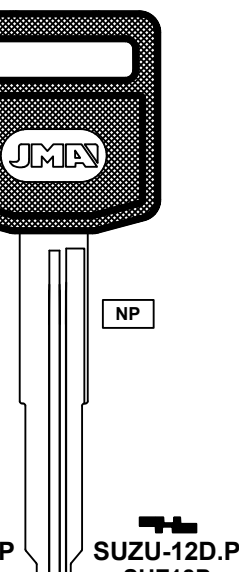
Z ZAMAK NS N. SILVER / ALPACA S STEEL / ACERO NE NEON NP NICKEL PLATED / LATON NIQUELADO FM FUN COLOR GM ALUMINUM / ALUMINIO CK BRASS / LATON A ALUMINUM / ALUMINIO B BRASS / LATON	FOR: PIAGGIO®  S ZA-7D.P ZD17RAP	FOR: SKODA MOTORBIKE®  S SKO-2 FB7	FOR: SUZUKI MOTORCYCLE®  NP  S KAW-13 X259 NE-6 SR61N FOR: KAWASAKI®	
	FOR: SUZUKI MOTORCYCLE®  S  NP  S  S SUZU-21 SUZ3 SUZU-2D SUZ4 SUZU-11 SUZ2 SUZU-1D SUZ1 SUZU-5 SUZ11 SUZU-5.P SZ5P SUZU-6			
	FOR: SUZUKI MOTORCYCLE®  NP  S  NP  NP  NP SUZU-11D SUZ12 SUZU-11D.P SZ10RP SUZU-12 SUZU-12D SUZ18 SUZU-12.P SUZU-12D.P SUZ18P			

Concerning the marks and commercial denominations see note in index.

Concerniente a las marcas y denominaciones comerciales ver nota en indice.

Concernant les marques et denominations commerciales voir la note dans l'index.



Concerning the marks and commercial denominations see note in index.

Concerniente a las marcas y denominaciones comerciales ver nota en indice.

Concernant les marques et denominations commerciales voir la note dans l'index.



Z ZAMAK	NS N.SILVER / ALPACA	S STEEL / ACERO	FOR: SUZUKI MOTORCYCLE®			
			SUZU-14.P2	SUZU-16 SZ4	SUZU-16D SUZ4P	SUZU-16D.P SUZ4RP
NE NEON	NP NICKEL PLATED / LATON NIQUELADO	S STEEL / ACERO	FOR: SUZUKI MOTORCYCLE®			
			SUZU-18 SUZ19	SUZU-18D.P	SUZU-18.P1	SUZU-22.P
CM FUN COLOR	CK CRISTAL KEYS / PLASTICO COLOR	S STEEL / ACERO	FOR: SUZUKI MOTORCYCLE®			
			SUZU-23.P	YAMA-19D YH49	YAMA-19I YH48	YAMA-20D YH51
A ALUMINUM / ALUMINIO	B BRASS / LATON	S STEEL / ACERO	FOR: SUZUKI MOTORCYCLE®			
			YAMA-20I YH50	YAMA-23D.P YH29P	YAMA-23I.P YH29RP	

Z ZAMAK	NS N.SILVER / ALPACA	S STEEL / ACERO	FOR: SUZUKI MOTORCYCLE®		FOR: TRIUMPH MOTORCYCLE®	
			FOR: ISUZU® ZA-4D.P ZD16RP	FOR: MALAGUTI® ZA-9.P1 ZD24RDP	FOR: APRILIA® FOR: BMW® FOR: DERBI®	FOR: BUELL® FOR: CAGIVA® FOR: ISUZU®
NE NEON	NP NICKEL PLATED / LATON NIQUELADO	S STEEL / ACERO	FOR: TRIUMPH MOTORCYCLE®			
			UN-3 R62DM	UN-FS 62FS	ZA-9.P1 ZD24RDP	ZA-12 ZD7
CM FUN COLOR	CK CRISTAL KEYS / PLASTICO COLOR	S STEEL / ACERO	FOR: TVS®		FOR: YAMAHA®	
			FOR: RTR® FOR: VICTORY® TVS-1.P	TVS-2D.P	TVS-1.P1	TVS-3.P
A ALUMINUM / ALUMINIO	B BRASS / LATON	S STEEL / ACERO	FOR: YAMAHA®			
			NTC-23D M1069L			

Concerning the marks and commercial denominations see note in index.

Concerniente a las marcas y denominaciones comerciales ver nota en indice.

Concernant les marques et denominations commerciales voir la note dans l'index.



Concerning the marks and commercial denominations see note in index.

Concerniente a las marcas y denominaciones comerciales ver nota en indice.

Concernant les marques et denominations commerciales voir la note dans l'index.



FOR: YAMAHA®

YAMA-21 YH9	YAMA-2D	YAMA-11 YH20	YAMA-1D YH16	YAMA-3I YH39	YAMA-3D YH40	YAMA-4D X48	YAMA-5I YH28	YAMA-5D YH27

FOR: YAMAHA®

YAMA-6I YH6	YAMA-6D YH6R	YAMA-7I YH29	YAMA-7D YH24	YAMA-12D YH38	YAMA-12I YH37	YAMA-15I YH32	YAMA-15D YH30	YAMA-17I YH33	YAMA-17D YH34	YAMA-13I YH45	YAMA-13D YH44

FOR: YAMAHA®

YAMA-14I YH35	YAMA-14D YH36	YAMA-16I YM56	YAMA-16D YM55	YAMA-18D YH47	YAMA-18I YH46	YAMA-20D YH51	YAMA-20I YH50

FOR: YAMAHA®

YAMA-19D YH49	YAMA-19I YH48	YAMA-18D.P YH28BP	YAMA-18I.P YH28RBP	YAMA-21I YH31R	YAMA-21I.P YH31RAP

FOR: YAMAHA®

YAMA-24D.P YH30P	YAMA-24I.P YH30RP	YAMA-23D.P YH29P	YAMA-23I.P YH29RP	YAMA-22D.P YH28P	YAMA-22I.P YH28RP	YAMA-25D.P	YAMA-26 YM64	YAMA-26D YM63	YAMA-26.P	YAMA-26D.P YH35RBP

FOR: YAMAHA®

YAMA-27	YAMA-27D	YAMA-27.P YH34P	YAMA-27D.P YH34RP	YAMA-28.P	YAMA-29.P	YAMA-30.P



Concerning the marks and commercial denominations see note in index.

Concerniente a las marcas y denominaciones comerciales ver nota en índice.

Concernant les marques et dénominations commerciales voir la note dans l'index.



Concerning the marks and commercial denominations see note in index.

Concerniente a las marcas y denominaciones comerciales ver nota en índice.

Concernant les marques et dénominations commerciales voir la note dans l'index.



Z ZAMAK NS N.SILVER / ALPACA S STEEL / ACERO NE NEON NP NICKEL PLATED / LATON NIQUELADO FM FUN COLOR GM CRISTAL KEYS / PLASTICO COLOR AL ALUMINUM / ALUMINIO B BRASS / LATON	FOR: YAMAHA®			
	NP	NP	NP	NP
	YAMA-31D.P	YAMA-32D.P	YAMA-35D.P2	YAMA-36D.P
				FOR: FZ® FOR: LIBERO®
	FOR: YAMAHA®			
	NP	S	S	
	YAMA-37D YH65	ZA-4D.P ZD16RP	ZA-9.P1 ZD24RDP	



Concerning the marks and commercial denominations see note in index.

Concerniente a las marcas y denominaciones comerciales ver nota en indice.

Concernant les marques et denominations commerciales voir la note dans l'index.



CYLINDER KEYS

Llaves de serreta y especiales
Clés plates et spéciales

FOR: ABLOY®				FOR: ABSA®
NP	NP	NP	NP	B
ABL-1 AL1	ABL-2	ABL-3 c	ABL-4	ABL-5
FOR: ABSA®				FOR: ABUS®
S	NP	S	S	S
AB-6I	ABU-14	ABU-21 AB21	ABU-20	ABU-20
		ABU-2D AB18	ABU-12I	ABU-22D
		ABU-1 AB20	ABU-1D AB19	ABU-23D
FOR: ABUS®				
S	S	NS	S	S
ABU-27D AB16	ABU-28	ABU-29.P	ABU-40 AB15	ABU-42 AB62CR
				ABU-42D AB62C

Z ZAMAK
NS N.SILVER / ALPACA
S STEEL / ACERO
NE NEON
NP NICKEL PLATED / LATON NIQUELADO
FUN COLOR
CM CRISTAL KEYS / PLASTICO COLOR
CK
A ALUMINUM / ALUMINIO
B BRASS / LATON

! Concerning the marks and commercial denominations see note in index.
Concerniente a las marcas y denominaciones comerciales ver nota en indice.
Concernant les marques et denominations commerciales voir la note dans l'index.



Z ZAMAK	NS S	N SILVER / ALPACA STEEL / ACERO	FOR: ABUS®						
			ABU-60 AB14	ABU-50 AB13	ABU-51D AB23	ABU-56	ABU-90	ABU-95	
			NE NP	NEON NICKEL PLATED / LATON NIQUELADO	FOR: ABUS®		FOR: AGA®		
					ABU-97	ABU-98	AGA-1T	AGA-2T	AGA-4D
CM CK	FUN COLOR CRISTAL KEYS / PLASTICO COLOR	FOR: AGA®							
A B	ALUMINUM / ALUMINIO BRASS / LATON								

Z ZAMAK	NS S	N SILVER / ALPACA STEEL / ACERO	FOR: AGB®		FOR: AGE®		FOR: AGUIA®		FOR: ALIANCA®				
			AGB-1	AGB-1D	AGE-2D AG5		AG-10I AU4	AG-10D AU3	AG-8I AGU1	AG-8D AG1R	AG11 AU2	AG-11D AU1	ALC-1D
NE NP	NEON NICKEL PLATED / LATON NIQUELADO	FUN COLOR CRISTAL KEYS / PLASTICO COLOR	FOR: ALIANCA®		FOR: ALISON®		FOR: ALPHA®		FOR: AMC®				
			ALC-2D	ALS-1	ALP-3 ALP4	ALP-5D ALP5	AMC-1	AMC-1D					
CM CK	FUN COLOR CRISTAL KEYS / PLASTICO COLOR	FOR: AMERICAN LOCK®											
A B	ALUMINUM / ALUMINIO BRASS / LATON	5 PIN - 21.20 mm	6 PIN - 24 mm				5 PIN - 21.20 mm	5 PIN - 21.20 mm					

! Concerning the marks and commercial denominations see note in index.

Concerniente a las marcas y denominaciones comerciales ver nota en indice.

Concernant les marques et denominations commerciales voir la note dans l'index.

! Concerning the marks and commercial denominations see note in index.

Concerniente a las marcas y denominaciones comerciales ver nota en indice.

Concernant les marques et denominations commerciales voir la note dans l'index.

Z ZAMAK	NS N. SILVER / ALPACA	S STEEL / ACERO	FOR: AMERICAN LOCK®		FOR: ANKER®			FOR: ARCA®		FOR: AROUCA®			FOR: ARROW®											
			 6 PIN - 24.30 mm NP AME-5 A1041U JU-2 1046A	 6 PIN - 24.20 mm NP AME-9 AM7L	 FOR: ODA® ANK-1 AK1	 FOR: ODA® ANK-2 AK2	 FOR: ODA® ANK-3 AK3	 ACA-7D	 ARO-1D	 ARO-2	 ARR-3 755U	 FOR: ALMET® ARR-4 AR1	NS N. SILVER / ALPACA	S STEEL / ACERO	Z ZAMAK	NE NEON	NP NICKEL PLATED / LATON NIQUELADO							
NE NEON	NP NICKEL PLATED / LATON NIQUELADO	FOR: ANKER®		FOR: ANVER®			FOR: ARROW®																	
NE NEON	NP NICKEL PLATED / LATON NIQUELADO	NP NICKEL PLATED / LATON NIQUELADO	FOR: ANKER®		FOR: ANVER®			FOR: ARROW®					NE NEON	NP NICKEL PLATED / LATON NIQUELADO										
			 ANK-4 AK6	 ANA-1 H61V	 ANV-1D	 ANV-5 ANV-4D ANV-3D ANV-2	 ANV-6D	 FOR: ALMET® ARR-5D AR4	 FOR: ALMET® ARR-6D AR3	 ARR-10 A1179E	 ARR-11 A1179F	 ARR-12 A1179G			 ARR-13 A1179H	 ARR-14 A1179J	 ARR-15 A1179K	 ARR-16 A1179L	 ARR-17 A1179N	 ARR-18 A1179P	 ARR-19 A1179R	 ARR-20 A1179S	 ARR-21 A1179T	 ARR-22 A1179U
A ALUMINUM / ALUMINIO	B BRASS / LATON	CM FUN COLOR	CK CRISTAL KEYS / PLASTICO COLOR	FOR: ARCA®					FOR: ARROW®		FOR: ASHICO®		FOR: ASIA®		FOR: ASSA®									
				 ACA-1D	 ACA-4D ACA-2D	 ACA-3D	 ACA-5D	 ACA-6D	 ARR-7D B1179-1D	 ASH-4 ASH-1	 ASI-1	 AS-N5 61W	 AS-P5 R61W	 AS-G5 AS1	 AS-M5 AS3	 AS-E5 61Q	 AS-F5 R61Q	 AS-A5 61T	 AS-B5 R61T					

Concerning the marks and commercial denominations see note in index.

Concerniente a las marcas y denominaciones comerciales ver nota en indice.









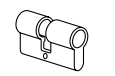

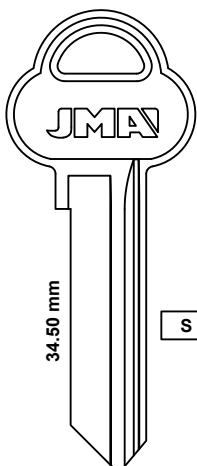
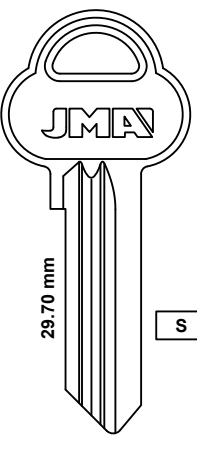

























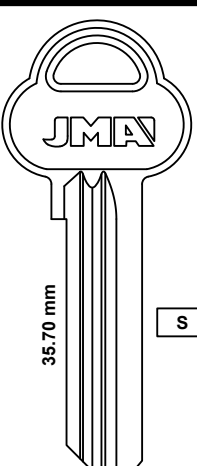
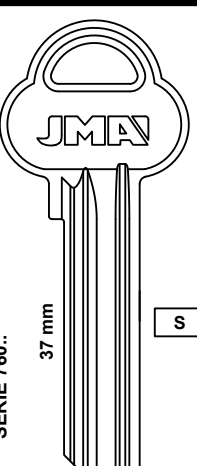























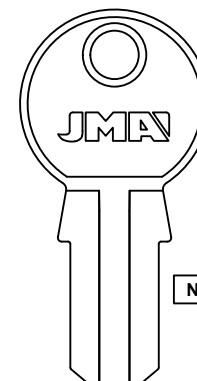
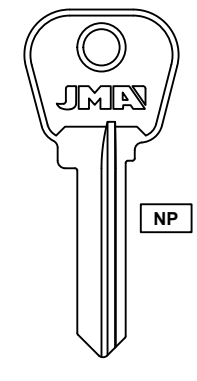
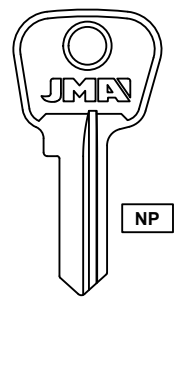
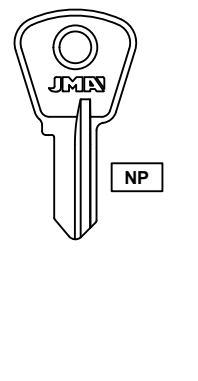
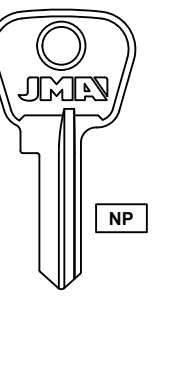
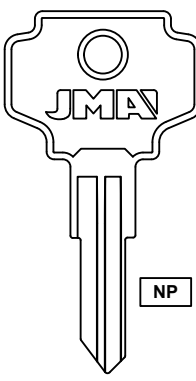
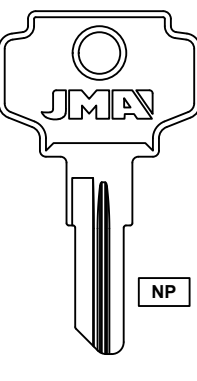
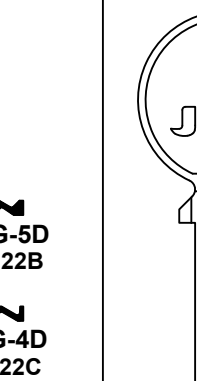
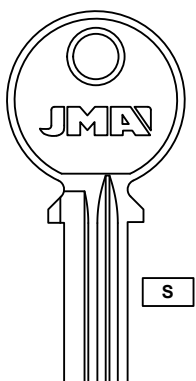
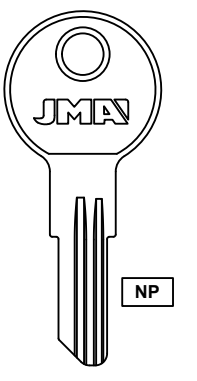
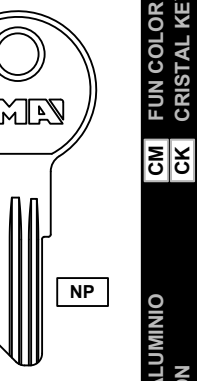
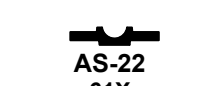

Concernant les marques et denominations commerciales voir la note dans l'index.





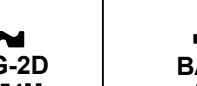



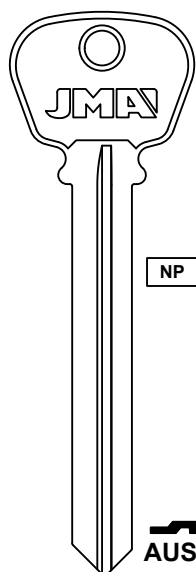
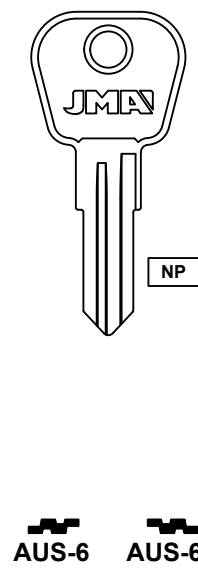
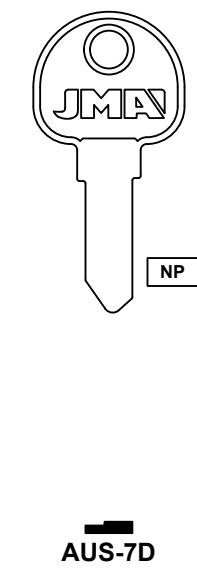
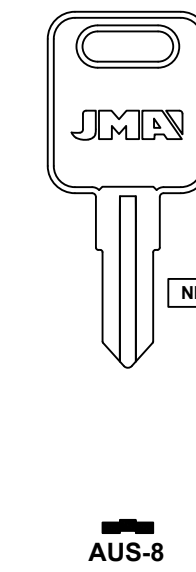
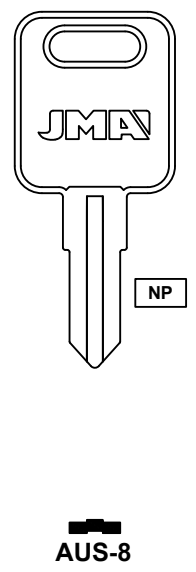
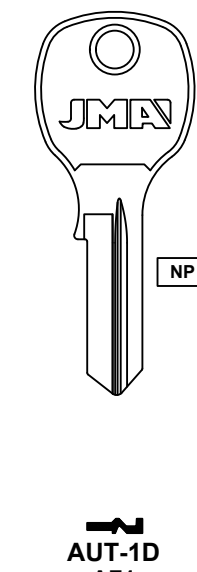
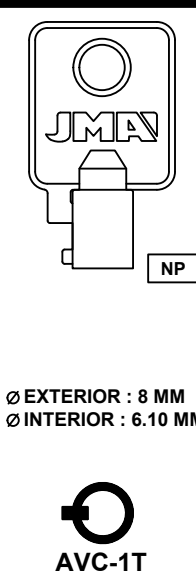
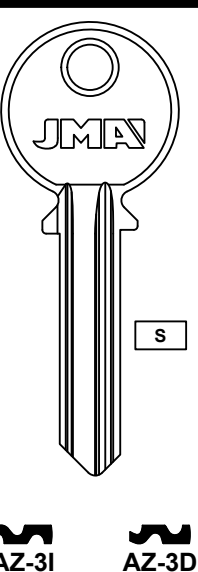
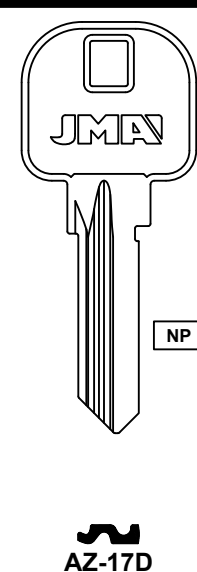
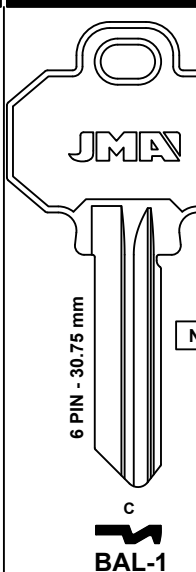
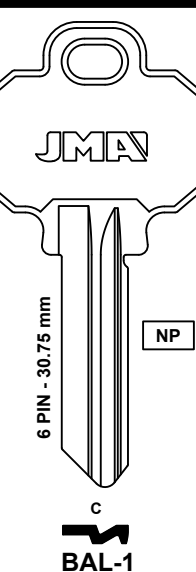
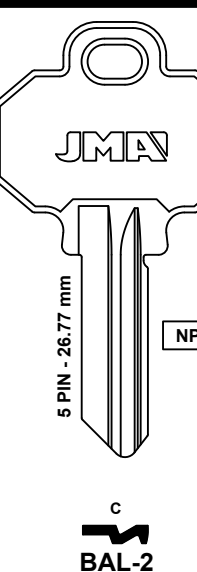
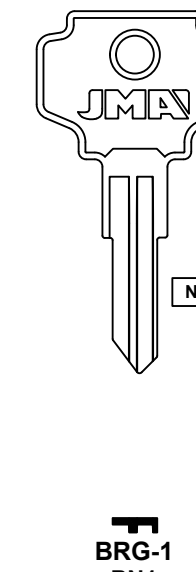
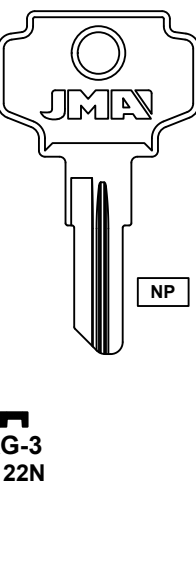
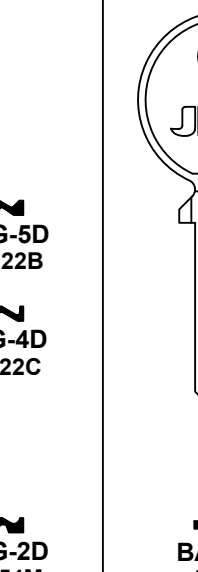
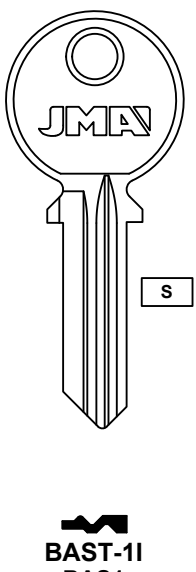
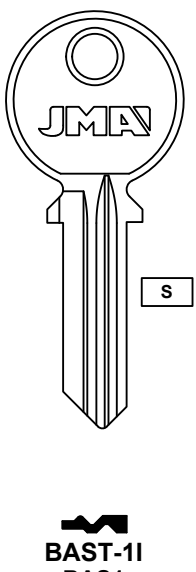
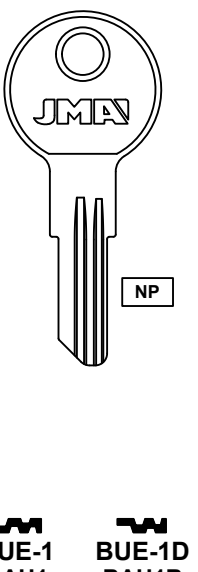
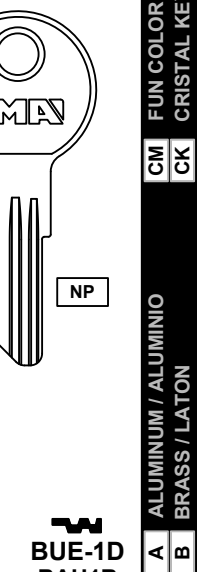
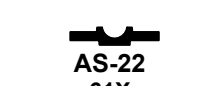

Concerning the marks and commercial denominations see note in index.

Concerniente a las marcas y denominaciones comerciales ver nota en indice.

Concernant les marques et denominations commerciales voir la note dans l'index.

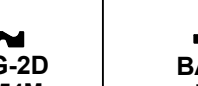

Z ZAMAK	NS S	N SILVER / ALPACA STEEL / ACERO	FOR: ASSA®																											
			 SERIE 760..	 SERIE 560..	 AS-V5 AS11	 AS-W5 AS77	 AS-GL5 AS47	 AS-GM5 AS53	 AS-T5 AS9	 AS-U5 AS75	 AS-L7 AS8	 AS-M7 AS4	 AS-N7 A61W	 AS-EL5 AS13	 AS-EM5 AS21	 AS-FK5 AS35	 AS-GK5 AS27	 AS-F7 AR61Q	 AS-G7 AS2	 AS-K7 AS6	 AS-DK5 AS29	 AS-DL5 AS49	 AS-DM5 AS51	 AS-EK5 AS17	 AS-A7 A61T	 AS-B7 AR61T	 AS-E7 A61Q	 AS-AK5 AS19	 AS-AL5 AS15	 AS-AM5 AS55
NE NEON	NS S	N SILVER / ALPACA STEEL / ACERO	FOR: ASSA®																											
			 SERIE 760..	 SERIE 760..	 AS-W7 AS78	 AS-X7 AS32	 AS-Z7 AS34	 AS-GM7 AS54	 AS-H7 AS74	 AS-NN7 AS84	 AS-T7 AS10	 AS-U7 AS76	 AS-V7 AS12	 AS-EM7 AS22	 AS-FK7 AS36	 AS-FL7 AS44	 AS-FM7 AS70	 AS-GK7 AS28	 AS-GL7 AS48	 AS-D7 AS72	 AS-DK7 AS30	 AS-DL7 AS50	 AS-DM7 AS52	 AS-EK7 AS18	 AS-EL7 AS14	 AS-AK7 AS20	 AS-AL7 AS16	 AS-AM7 AS56	 AS-BK7 AS38	 AS-BL7 AS46
GM CK	NS S	N SILVER / ALPACA STEEL / ACERO	FOR: ASSA®					FOR: AUSTRAL®																						
			 AS-22 61X	 AUS-1	 AUS-2	 AUS-3	 AUS-4	 BRG-1 BN1	 BRG-3 K1122N	 BRG-2D L1054M	 BAST-11 BAS1	 BUE-1 BAU1	 BUE-1D BAU1R																	
A B	NS S	N SILVER / ALPACA STEEL / ACERO	FOR: ASSA®																											
			 AS-22 61X	 AUS-1	 AUS-2	 AUS-3	 AUS-4	 BRG-1 BN1	 BRG-3 K1122N	 BRG-2D L1054M	 BAST-11 BAS1	 BUE-1 BAU1	 BUE-1D BAU1R																	

Z ZAMAK	NS S	N SILVER / ALPACA STEEL / ACERO	FOR: AUSTRAL®					FOR: AUTH FLORENCE®						
			 AUS-5	 AUS-6	 AUS-6D	 AUS-7D	 AUS-8	 AUT-1D AF1						
NE NEON	NS S	N SILVER / ALPACA STEEL / ACERO	FOR: AVCE®		FOR: AZBE®		FOR: BALDWIN®							
			 AVC-1T	 AZ-3I AZ2	 AZ-3D AZ2R	 AZ-17D	 BAL-1 1511	 BAL-2 BW2						
GM CK	NS S	N SILVER / ALPACA STEEL / ACERO	FOR: BARGMAN®					FOR: BASTA®		FOR: BAUER®				
			 BRG-1 BN1	 BRG-3 K1122N	 BRG-4D K1122C	 BRG-5D K1122B	 BAST-11 BAS1	 BUE-1 BAU1	 BUE-1D BAU1R					
A B	NS S	N SILVER / ALPACA STEEL / ACERO	FOR: ASSA®											
			 AS-22 61X	 AUS-1	 AUS-2	 AUS-3	 AUS-4	 BRG-1 BN1	 BRG-3 K1122N	 BRG-2D L1054M	 BAST-11 BAS1	 BUE-1 BAU1	 BUE-1D BAU1R	

Concerning the marks and commercial denominations see note in index.

Concerniente a las marcas y denominaciones comerciales ver nota en índice.

Concernant les marques et dénominations commerciales voir la note dans l'index.



Concerning the marks and commercial denominations see note in index.

Concerniente a las marcas y denominaciones comerciales ver nota en índice.

Concernant les marques et dénominations commerciales voir la note dans l'index.



Z ZAMAK	NS N.SILVER / ALPACA S STEEL / ACERO	FOR: BAUER®			FOR: BELLEVILLE®	
NE NEON NP NICKEL PLATED / LATON NIQUELADO	NS N.SILVER / ALPACA S STEEL / ACERO	FOR: BEST®				
CM FUN COLOR CK CRISTAL KEYS / PLASTICO COLOR	NS N.SILVER / ALPACA S STEEL / ACERO	FOR: BEST®				
A ALUMINUM / ALUMINIO B BRASS / LATON	NS N.SILVER / ALPACA S STEEL / ACERO	FOR: BETA®				

Z ZAMAK	NS N.SILVER / ALPACA S STEEL / ACERO	FOR: BILMA®		FOR: BKS®				
NE NEON NP NICKEL PLATED / LATON NIQUELADO	NS N.SILVER / ALPACA S STEEL / ACERO	FOR: BKS®		FOR: BRASIL®		FOR: BREVETTO®		
CM FUN COLOR CK CRISTAL KEYS / PLASTICO COLOR	NS N.SILVER / ALPACA S STEEL / ACERO	FOR: BRICARD®		FOR: BRUMME®		FOR: BURG®		

! Concerning the marks and commercial denominations see note in index.

Concerniente a las marcas y denominaciones comerciales ver nota en indice.

Concernant les marques et denominations commerciales voir la note dans l'index.

! Concerning the marks and commercial denominations see note in index.

Concerniente a las marcas y denominaciones comerciales ver nota en indice.

Concernant les marques et denominations commerciales voir la note dans l'index.

Z ZAMAK NS N. SILVER / ALPACA S STEEL / ACERO NE NEON NP NICKEL PLATED / LATON NIQUELADO GM FUN COLOR CK CRISTAL KEYS / PLASTICO COLOR A ALUMINUM / ALUMINIO B BRASS / LATON	FOR: BURG®				FOR: BUVA®	
	BUR-12 BUR1	BUR-13D BUR13	BUR-28 BUR9	BUR-29D BUR15	BU-11 BV2	BU-1D BV1
	FOR: CAM LOCK®					FOR: CANADA POST®
CML-1 1631	CNP-1 1632	CNP-3 1558	CNP-4 1659	CNP-4D 1659R	CNP-5 1669	
FOR: CANADA POST®		FOR: CANTOL®			FOR: CASH BOX®	
CNP-6D 1661	CTO-1	CTO-2	CTO-3D	CSB-2D		

Z ZAMAK NS N. SILVER / ALPACA S STEEL / ACERO NE NEON NP NICKEL PLATED / LATON NIQUELADO GM FUN COLOR CK CRISTAL KEYS / PLASTICO COLOR A ALUMINUM / ALUMINIO B BRASS / LATON	FOR: CAVERS®					
	CA-11 CA91	CA-21 CA91B	CA-31 CAV91	CA-41 ZE91CR	CA-4D ZE91C	CA-51 CA91D
	FOR: CAVERS®			FOR: CCL®		
CA-151 CA91A	CCL-27 XO1000GR	CCL-26 XO1000FR	CCL-26D XO1000F	CCL-13D 1000FX		
CCL-1 X1000GR	CCL-1D CO10	CCL-2 SX1000FR	CCL-2D CO17	CCL-3 X1000FR	CCL-3D CO19	
FOR: CCL®						
CCL-32 CO12	CCL-34D 1000XK	CCL-33D 1000P	CCL-32D R1000T	CCL-29 S1000T	CCL-31D S1000XK	
CCL-12 CO26	CCL-5D CO63	CCL-35D CO9	CCL-11 CO68	CCL-11D SR1000V		

Concerning the marks and commercial denominations see note in index.

Concerniente a las marcas y denominaciones comerciales ver nota en indice.

Concernant les marques et denominations commerciales voir la note dans l'index.

Concerning the marks and commercial denominations see note in index.

Concerniente a las marcas y denominaciones comerciales ver nota en indice.

Concernant les marques et denominations commerciales voir la note dans l'index.

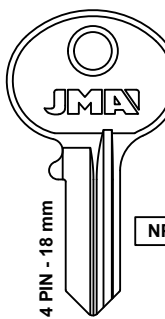
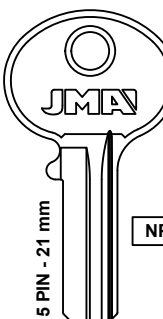
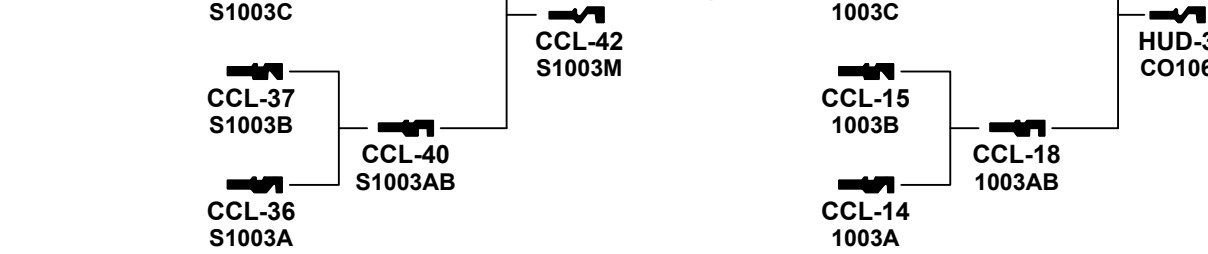
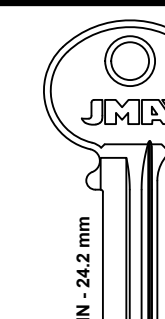
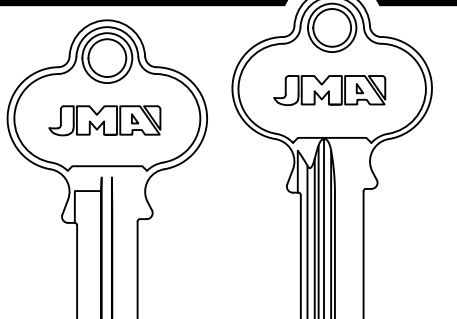
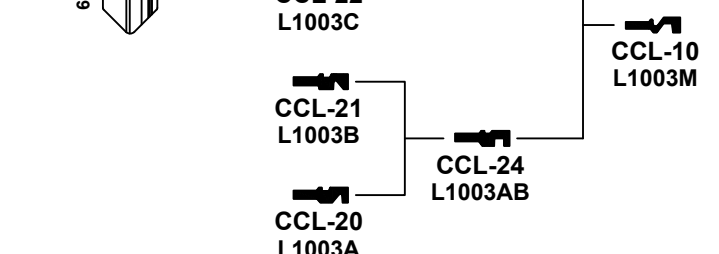
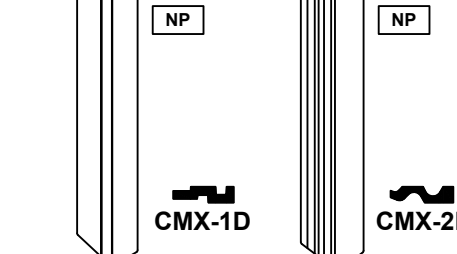
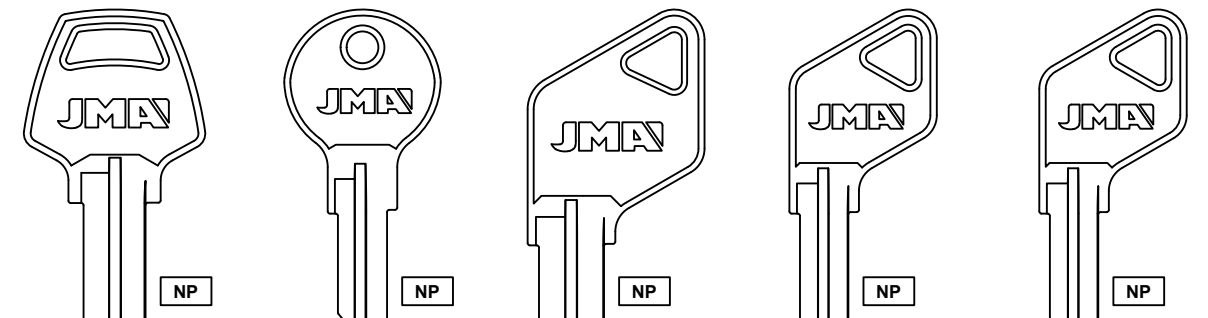
Z ZAMAK NS N.SILVER / ALPACA S STEEL / ACERO NE NEON NP NICKEL PLATED / LATON NIQUELADO GM FUN COLOR CK CRISTAL KEYS / PLASTICO COLOR A ALUMINUM / ALUMINIO B BRASS / LATON	FOR: CCL®  		
	CCL-39 S1003D CCL-38 S1003C CCL-37 S1003B CCL-36 S1003A	CCL-41 S1003CD CCL-40 S1003AB CCL-42 S1003M	
	CCL-17 1003D CCL-16 1003C CCL-15 1003B CCL-14 1003A	CCL-19 1003CD CCL-18 1003AB HUD-3 CO106	
			
FOR: CCL® 		FOR: CEMEX® 	
CCL-23 L1003D CCL-22 L1003C CCL-21 L1003B CCL-20 L1003A		CCL-25 L1003CD CCL-24 L1003AB CCL-10 L1003M	
			
FOR: CEMEX® 			
CMX-3D CMX-4D 1550 CMX-5D CMX-6D CMX-7D			

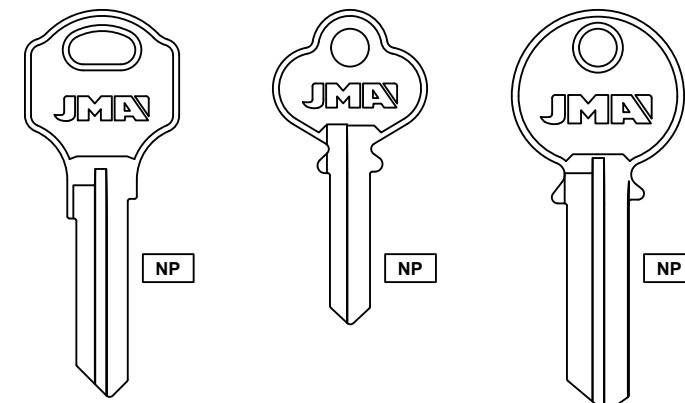
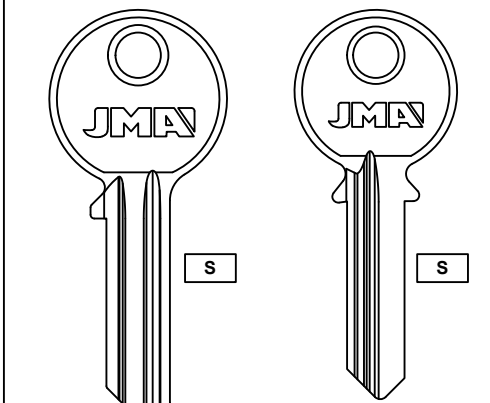
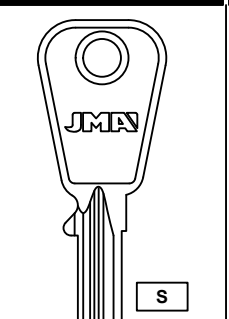
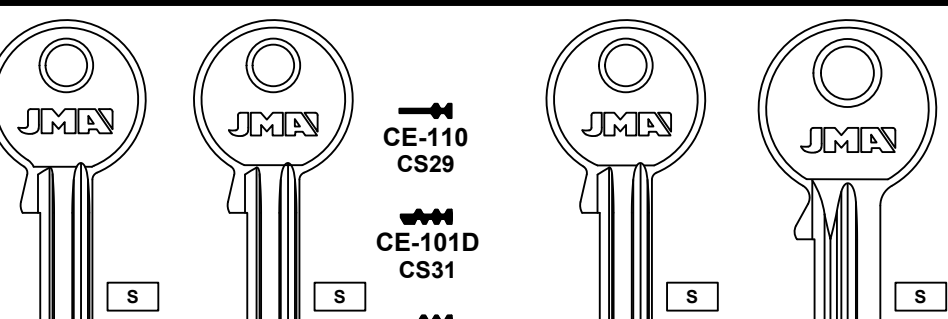
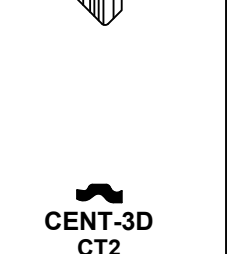
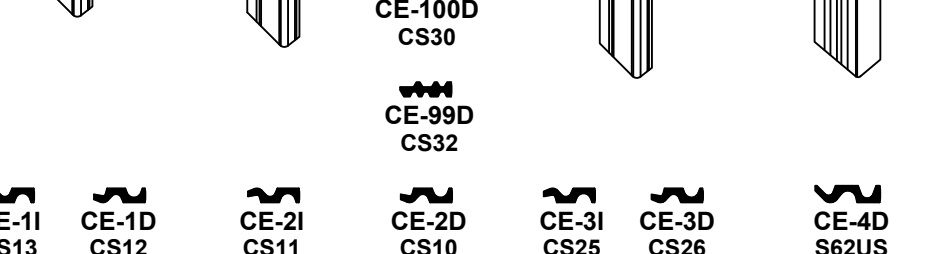
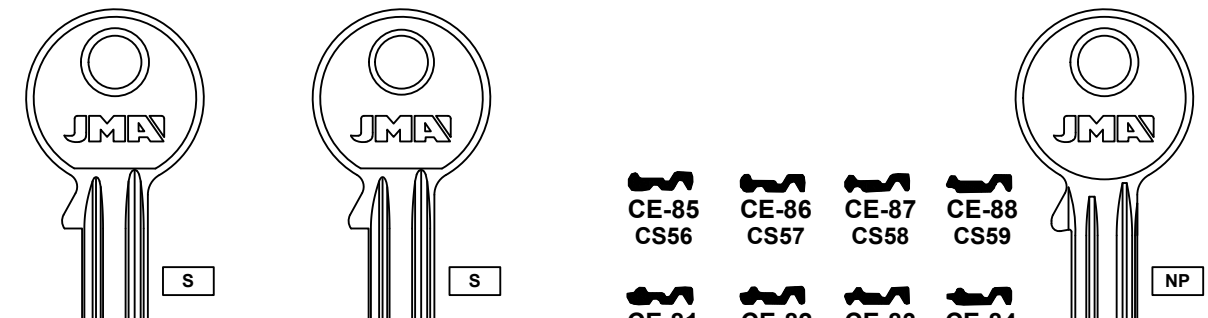
FOR: CEMEX® 			FOR: CENTURY® 		
CMX-8D CMX-9D CMX-10D 1548			CENT-11 R62CA CENT-1D CE1 CENT-2D CT1		
FOR: CENTURY® 		FOR: CES® 			
CENT-3D CT2		CE-11 CS13 CE-1D CS12 CE-21 CS11 CE-2D CS10 CE-31 CS25 CE-3D CS26 CE-4D S62US			
					
FOR: CES® 					
CE-5 R62US CE-5D ST91A CE-61 LR62US CE-6D L62US CE-85 CS56 CE-86 CS57 CE-87 CS58 CE-88 CS59 CE-81 CS52 CE-82 CS53 CE-83 CS54 CE-84 CS55 CE-77 CS44 CE-78 CS46 CE-79 CS47 CE-80 CS48 CE-50 CS45 CE-55 CS49 CE-56 CS50 CE-57 CS51					



Concerning the marks and commercial denominations see note in index.

Concerniente a las marcas y denominaciones comerciales ver nota en indice.

Concernant les marques et denominations commerciales voir la note dans l'index.











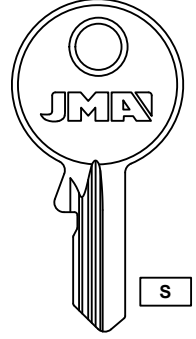
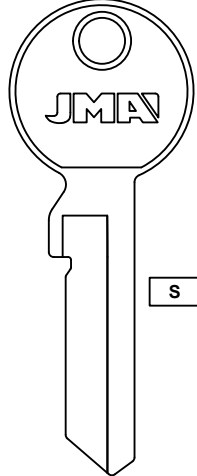
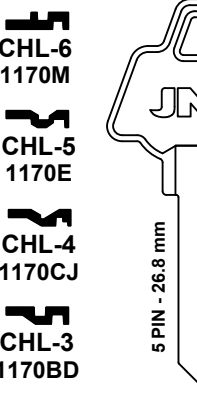
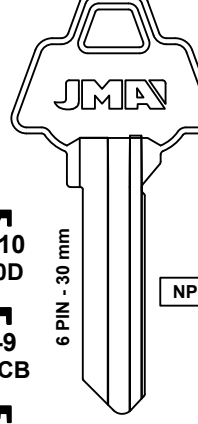
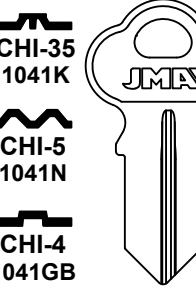
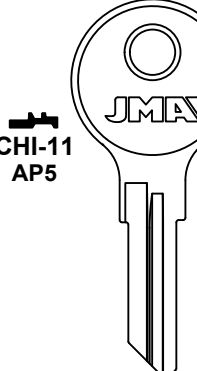
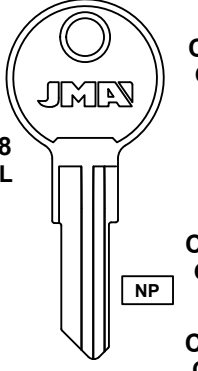
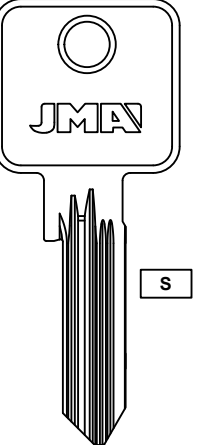
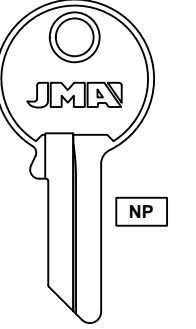
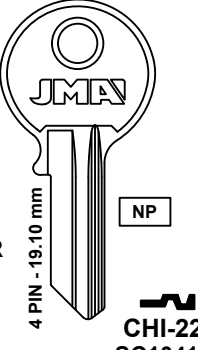
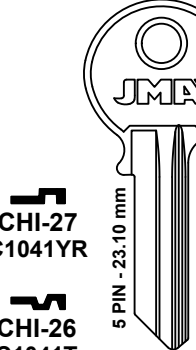
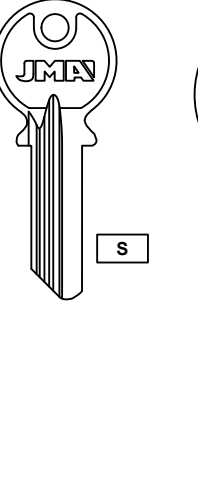

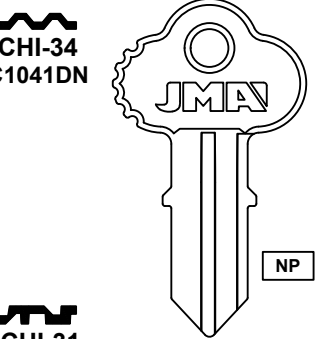



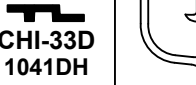

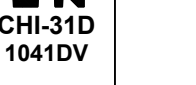
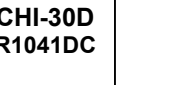
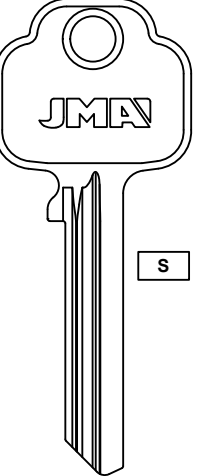
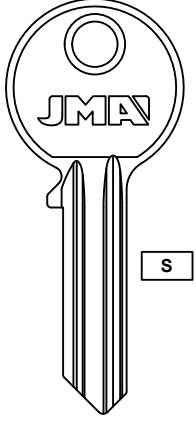
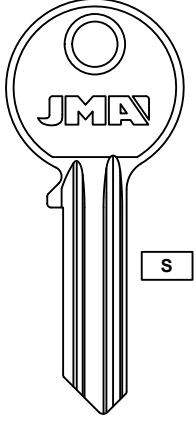
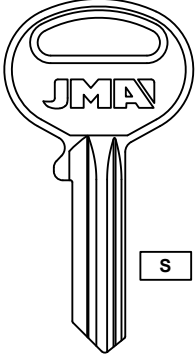
Concerning the marks and commercial denominations see note in index.

Concerniente a las marcas y denominaciones comerciales ver nota en indice.

Concernant les marques et denominations commerciales voir la note dans l'index.

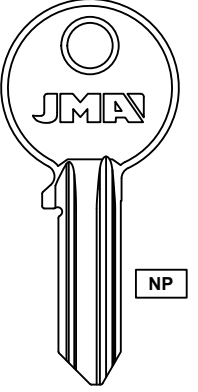
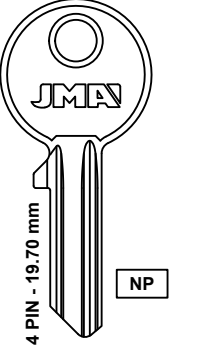
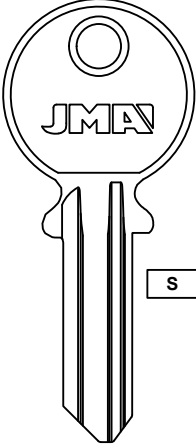
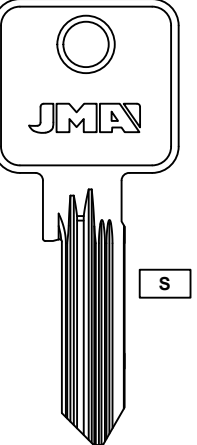
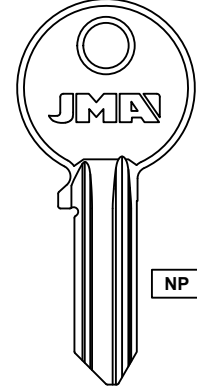

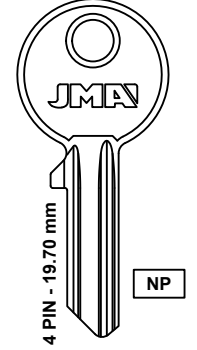
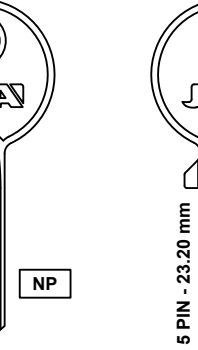
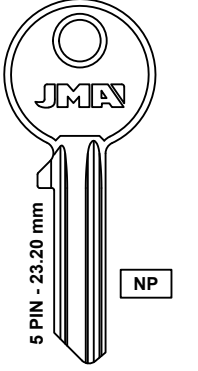
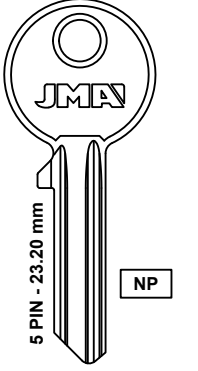
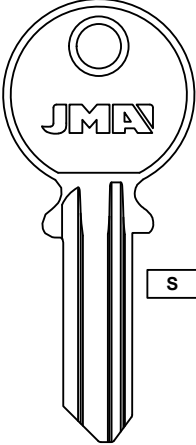
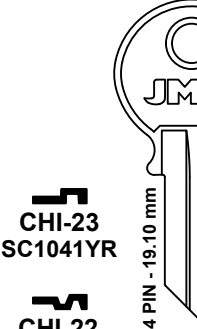
Z ZAMAK	NS S	N SILVER / ALPACA STEEL / ACERO	FOR: CES®		FOR: CHALLENGER®	
						
			CE-131D CS14	CE-134 CS43	CHL-6 1170M	CHL-10 A1170D
NE NP	NEON NICKEL PLATED / LATON NIQUELADO	N SILVER / ALPACA STEEL / ACERO	FOR: CHICAGO®		FOR: CHICAGO®	
						
			CHI-35 1041K	CHI-11 AP5	CHI-18 C1041L	CHI-19D C1041N
GM CK	FUN COLOR CRISTAL KEYS / PLASTICO COLOR	A ALUMINUM / ALUMINIO B BRASS / LATON	FOR: CHICAGO®		FOR: CHICAGO®	
						
			CHI-23 SC1041YR	CHI-27 C1041YR	CHI-26 C1041T	CHI-26D C1041TR

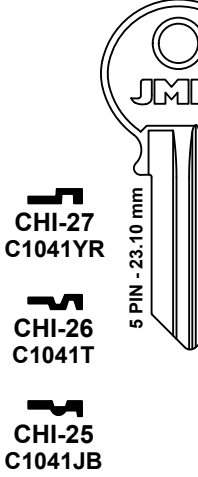
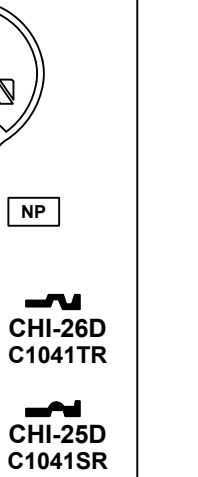
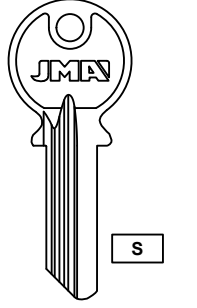
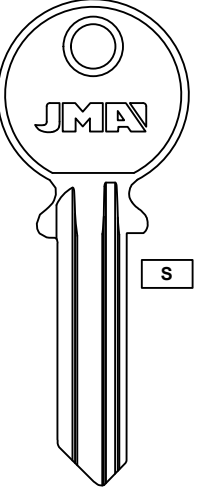
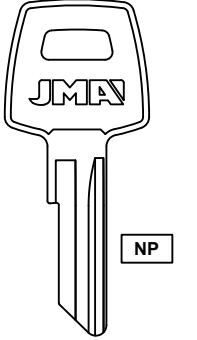
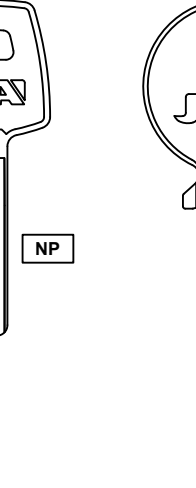
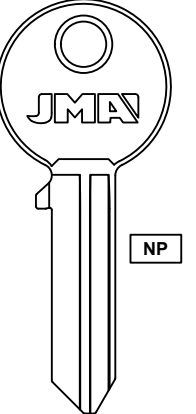
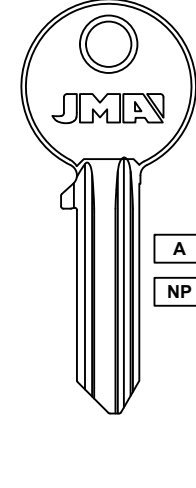
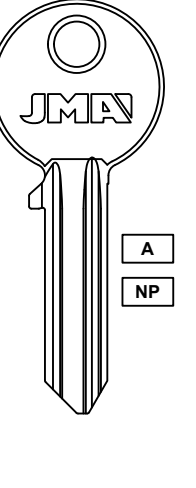
Z ZAMAK	NS S	N SILVER / ALPACA STEEL / ACERO	FOR: CHICAGO®		FOR: CHUBB®	FOR: CIEF®	FOR: CINA®											
																		
			CHI-34 C1041DN	CHI-31 R1041DV	CHI-30 1041DC	CHI-29 1041DB	CHI-33D 1041DH	CHI-32D 1041DE	CHI-31D 1041DV	CHI-30D R1041DC	CHU-1D 1516	CF-1I CF2	CF-1D CF1	ALI-1				
NE NP	NEON NICKEL PLATED / LATON NIQUELADO	N SILVER / ALPACA STEEL / ACERO	FOR: CHICAGO®		FOR: CISA®													
																		
			CHI-5 1041N	CHI-4 1041GB	CHI-3 1041GR	CHI-2 CG1	CHI-1 CG2	CHI-17D C1041J	CHI-15D C1041P	CHI-12D CG16	CI-1D	CI-4I NSR9CS	CI-4D NS9CS	CI-4IP CS91C	CI-4DP CS91CR	CI-5IP AB62ER	CI-5DP AB62E	CI-20 CS91
GM CK	FUN COLOR CRISTAL KEYS / PLASTICO COLOR	A ALUMINUM / ALUMINIO B BRASS / LATON	FOR: CHICAGO®		FOR: CISA®													
																		
			CHI-22 SC1041T	CHI-21D SC1041SR	CHI-25 C1041JB	CHI-25D C1041SR	CI-22D CS91FR	CI-24 AB1	CI-28	CI-28D 9CX	CI-40	CI-IL R9CS	CI-DL 9CS					

Concerning the marks and commercial denominations see note in index.

Concerniente a las marcas y denominaciones comerciales ver nota en índice.

Concernant les marques et dénominations commerciales voir la note dans l'index.



Concerning the marks and commercial denominations see note in index.

Concerniente a las marcas y denominaciones comerciales ver nota en índice.

Concernant les marques et dénominations commerciales voir la note dans l'index.



Z ZAMAK	NS N.SILVER / ALPACA S STEEL / ACERO	FOR: CLINTON®		FOR: CLUB CAR®		FOR: CORBIN®							
		CLN-1 CL1	GOC-1D CC1	COR-3	COR-8 CO87	COR-138D 1001MK	COR-7 CO97	COR-8S ZI-60-5					
NE NEON NP NICKEL PLATED / LATON NIQUELADO	NS N.SILVER / ALPACA S STEEL / ACERO	FOR: CORBIN®											
		COR-155D 1001A2	COR-154D 1001A1	COR-10 O1001E	COR-9 CO88	COR-9D A1001EHR	COR-9S ZI-60-6	COR-11	COR-11D	COR-12	COR-13	COR-15D	
CM FUN COLOR CK CRISTAL KEYS / PLASTICO COLOR	NS N.SILVER / ALPACA S STEEL / ACERO	FOR: CORBIN®											
		COR-16D	COR-17D	COR-20	COR-20D	COR-25I	COR-27D						
A ALUMINIUM / ALUMINIO B BRASS / LATON	NS N.SILVER / ALPACA S STEEL / ACERO	FOR: CORBIN®											
		COR-161D R1001EL	COR-158 A1001MA	COR-113 B1001EJ	COR-46 1000A	COR-220 R1001GA	COR-159D A1001MB	COR-156 1001E	COR-47 1001EL	COR-220D 1001GA	COR-160 A1001MF	COR-157D 1001EJ	COR-85 1001A

Z ZAMAK	NS N.SILVER / ALPACA S STEEL / ACERO	FOR: CORBIN®											
		COR-29D	COR-30 CB1	COR-32	COR-33	COR-34	COR-40 CB2						
NE NEON NP NICKEL PLATED / LATON NIQUELADO	NS N.SILVER / ALPACA S STEEL / ACERO	FOR: CORBIN®											
		COR-42	COR-43D	COR-41D	COR-173D R1001ET	COR-174 CO4	COR-169 R1001EK	COR-170 R1001EP	COR-171D R1001EM	COR-172D A1001MJR			
CM FUN COLOR CK CRISTAL KEYS / PLASTICO COLOR	NS N.SILVER / ALPACA S STEEL / ACERO	FOR: CORBIN®											
		COR-165D 1001MD	COR-112 A1001MJ	COR-44 CO2	COR-166D 1001MG	COR-162 1001MA	COR-163 1001MB	COR-84 CO6	COR-167D R1001ED	COR-168 CO35	COR-164 1001MC		
A ALUMINIUM / ALUMINIO B BRASS / LATON	NS N.SILVER / ALPACA S STEEL / ACERO	FOR: CORBIN®											
		COR-50/60 CB3	COR-55D CO62	COR-161D R1001EL	COR-158 A1001MA	COR-113 B1001EJ	COR-46 1000A	COR-220 R1001GA	COR-159D A1001MB	COR-156 1001E	COR-220D 1001GA	COR-160 A1001MF	COR-157D 1001EJ

Concerning the marks and commercial denominations see note in index.

Concerniente a las marcas y denominaciones comerciales ver nota en índice.

Concernant les marques et dénominations commerciales voir la note dans l'index.



Concerning the marks and commercial denominations see note in index.

Concerniente a las marcas y denominaciones comerciales ver nota en índice.

Concernant les marques et dénominations commerciales voir la note dans l'index.



Z ZAMAK
 NS N.SILVER / ALPACA S STEEL / ACERO
 NE NEON NP NICKEL PLATED / LATON NIQUELADO
 CM FUN COLOR CK CRISTAL KEYS / PLASTICO COLOR
 A ALUMINUM / ALUMINIO B BRASS / LATON

Z ZAMAK
 NS N.SILVER / ALPACA S STEEL / ACERO
 NE NEON NP NICKEL PLATED / LATON NIQUELADO
 CM FUN COLOR CK CRISTAL KEYS / PLASTICO COLOR
 A ALUMINUM / ALUMINIO B BRASS / LATON

FOR: CORBIN®

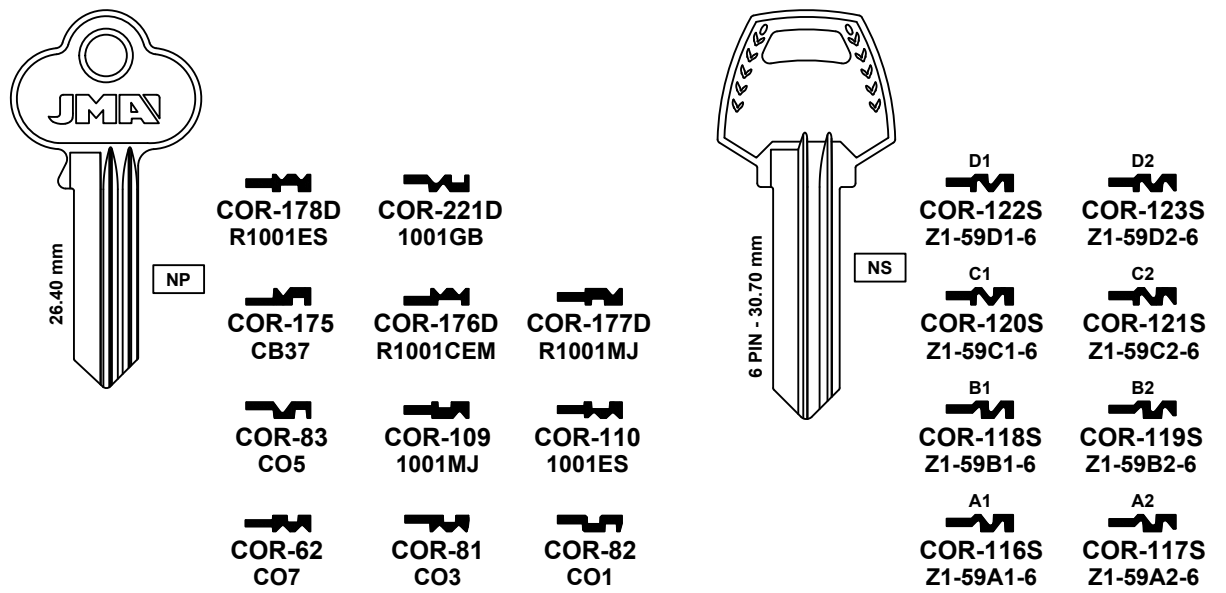

FOR: CORBIN®

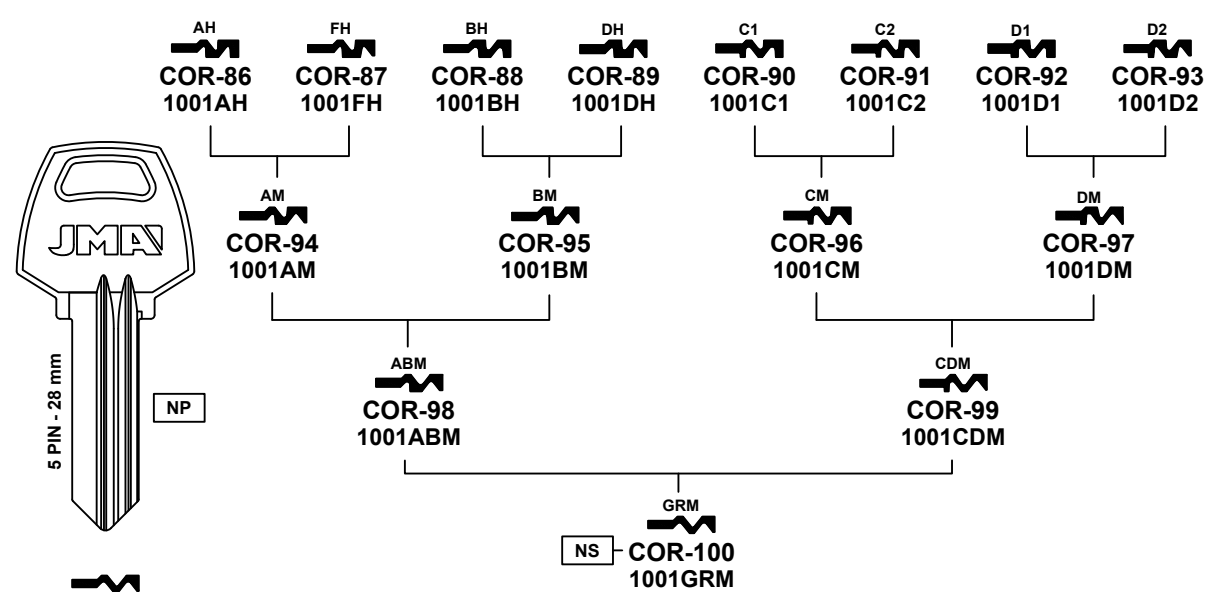

FOR: CORBIN®

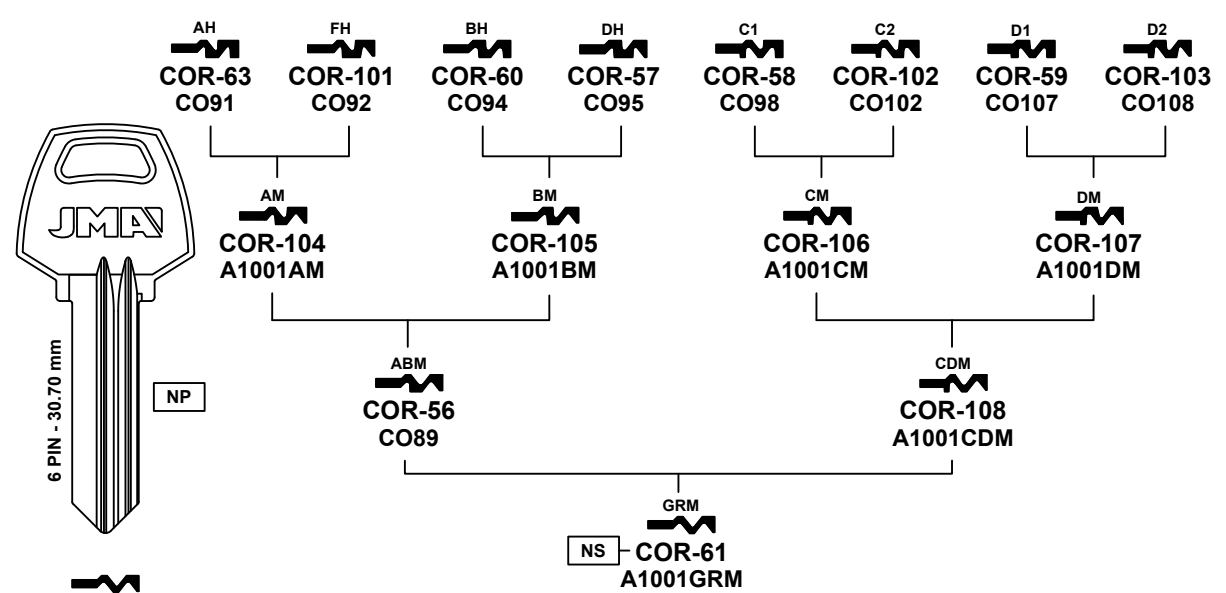

FOR: CORBIN®

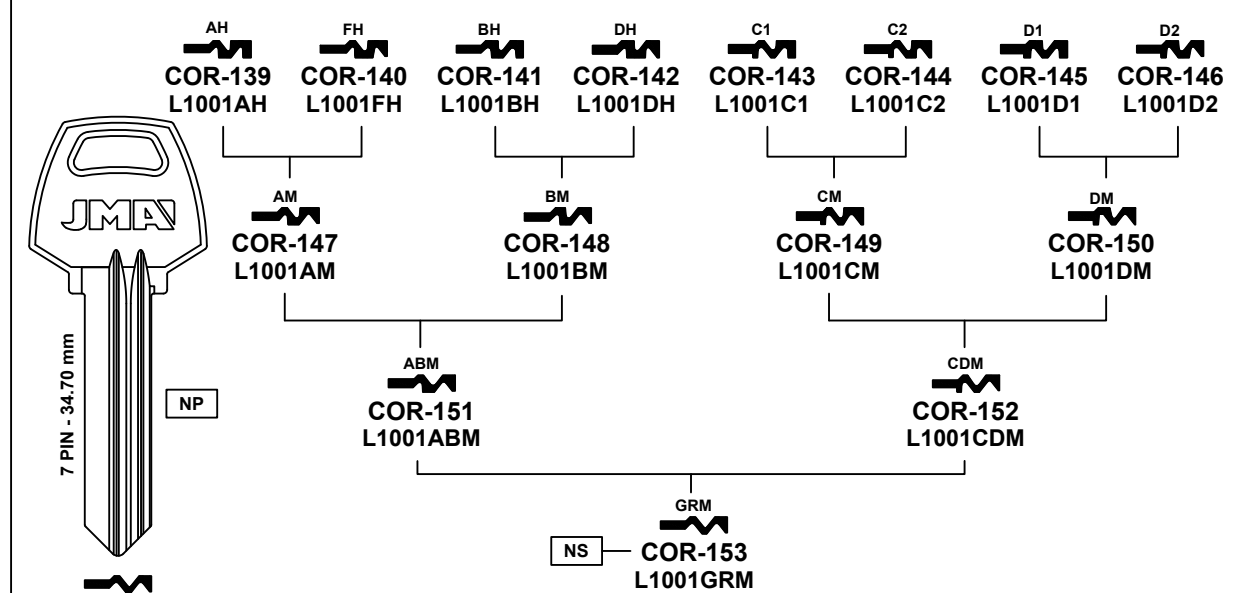

FOR: CORBIN®

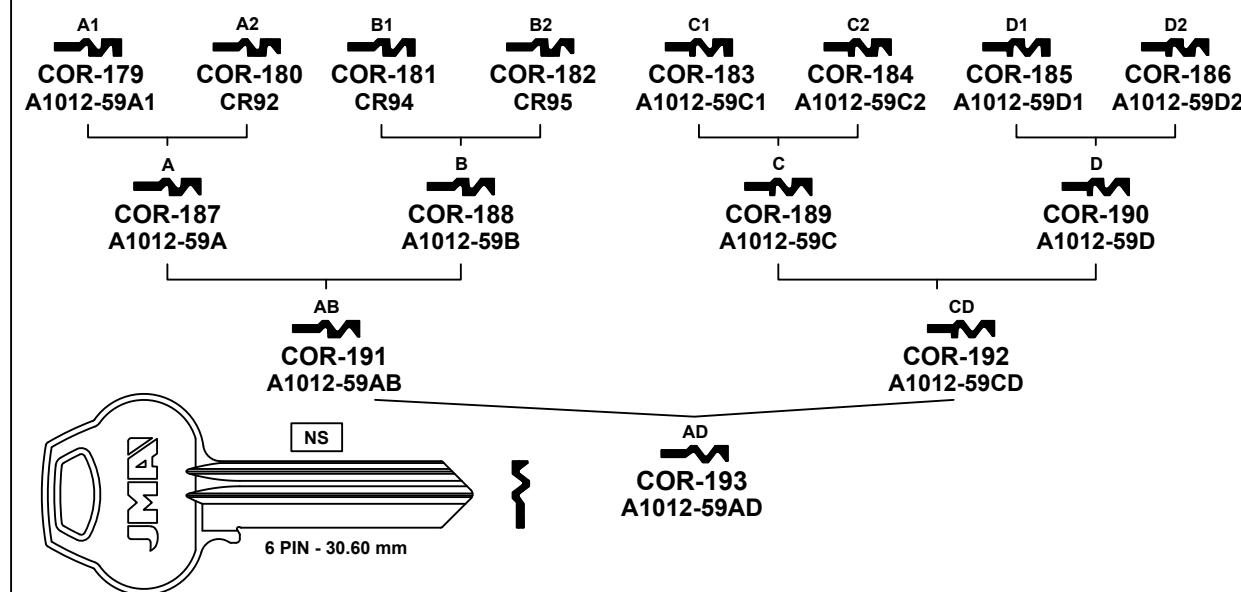

FOR: CORBIN®

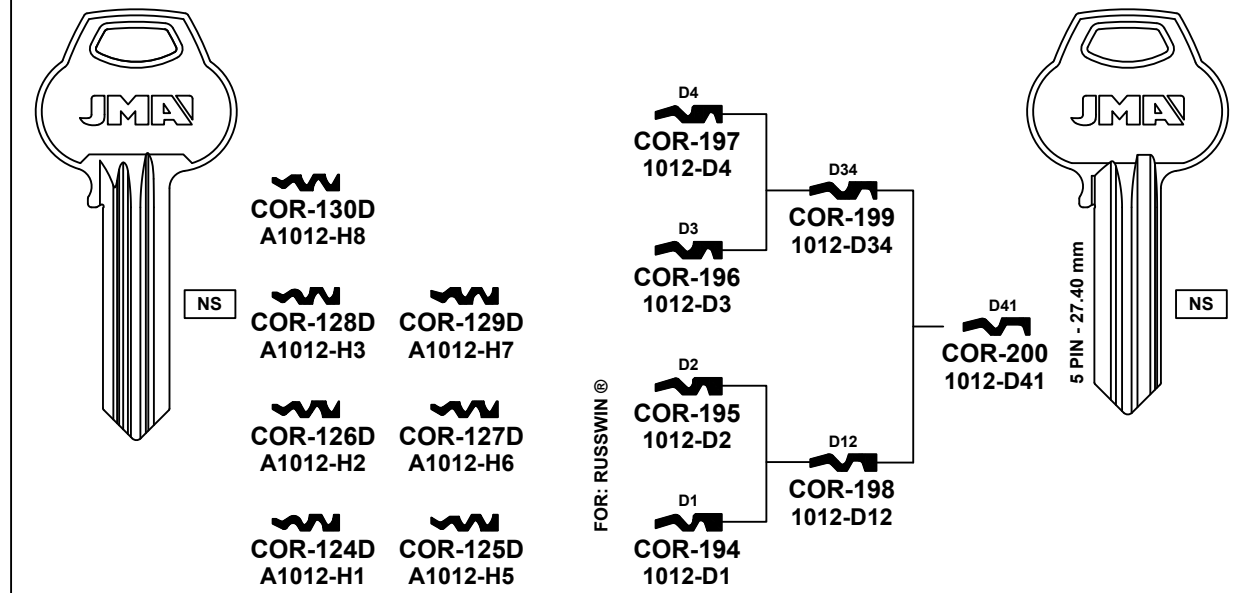

Concerning the marks and commercial denominations see note in index.

Concerniente a las marcas y denominaciones comerciales ver nota en índice.

Concernant les marques et dénominations commerciales voir la note dans l'index.



Concerning the marks and commercial denominations see note in index.

Concerniente a las marcas y denominaciones comerciales ver nota en índice.

Concernant les marques et dénominations commerciales voir la note dans l'index.



Z ZAMAK	NS N.SILVER / ALPACA S STEEL / ACERO	FOR: CORBIN®						
NE NEON NP NICKEL PLATED / LATON NIQUELADO	FOR: RUSSWIN®	FOR: CORBIN®						
GM FUN COLOR CK CRISTAL KEYS / PLASTICO COLOR	A ALUMINUM / ALUMINIO B BRASS / LATON	FOR: CORBIN®						
A ALUMINUM / ALUMINIO B BRASS / LATON	GM FUN COLOR CK CRISTAL KEYS / PLASTICO COLOR	FOR: CORBIN®		FOR: CORONA®		FOR: CVL®		

FOR: DAD®		FOR: DAF®	FOR: DEKABA®	FOR: DEXTER®
FOR: DEXTER®				
FOR: DEXTER®				

Concerning the marks and commercial denominations see note in index.

Concerniente a las marcas y denominaciones comerciales ver nota en indice.

Concernant les marques et denominations commerciales voir la note dans l'index.



Concerning the marks and commercial denominations see note in index.

Concerniente a las marcas y denominaciones comerciales ver nota en indice.

Concernant les marques et denominations commerciales voir la note dans l'index.



<p>Z ZAMAK NS N. SILVER / ALPACA S STEEL / ACERO NE NEON NP NICKEL PLATED / LATON NIQUELADO FM FUN COLOR CK CRISTAL KEYS / PLASTICO COLOR GM ALUMINUM / ALUMINIO B BRASS / LATON</p>	FOR: DOM [®]				FOR: DOMINION LOCK [®]	FOR: EARLE [®]	FOR: EBERHARD [®]	FOR: ELEPHANT [®]	FOR: ELGIN [®]					
	FOR: DOMINION LOCK [®]				FOR: DURALOCK [®]	FOR: ELGIN [®]	FOR: EMKA [®]	FOR: ENGELSDA [®]	FOR: ERA [®]	FOR: ESP [®]				
			FOR: CANADIAN POST [®]											
	FOR: EAGLE LOCK [®]					FOR: ESP [®]	FOR: EURO BOX [®]	FOR: EURO LOCKS [®]	FOR: EVERGOOD [®]					

Concerning the marks and commercial denominations see note in index.

Concerniente a las marcas y denominaciones comerciales ver nota en indice.

Concernant les marques et denominations commerciales voir la note dans l'index.



Concerning the marks and commercial denominations see note in index.

Concerniente a las marcas y denominaciones comerciales ver nota en indice.

Concernant les marques et denominations commerciales voir la note dans l'index.

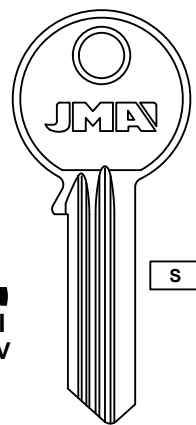
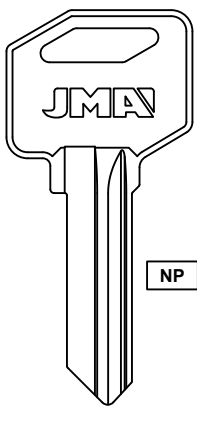
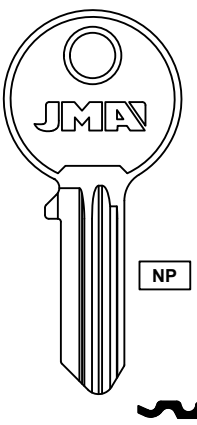
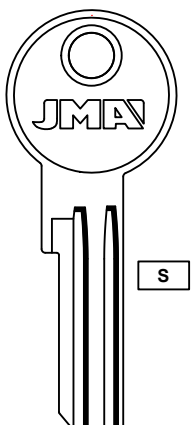
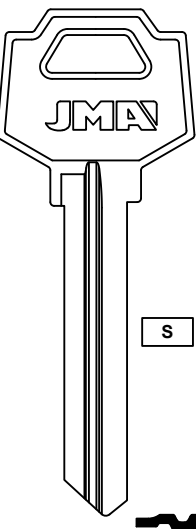
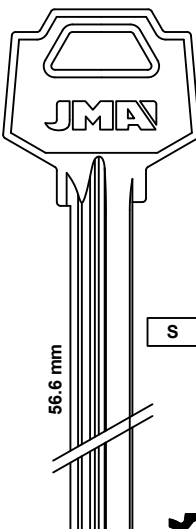
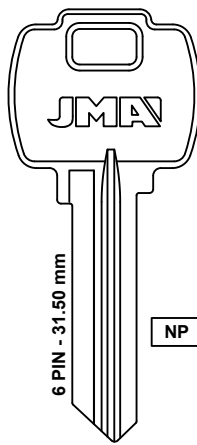
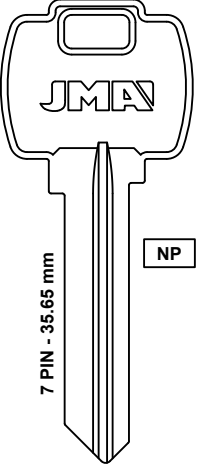
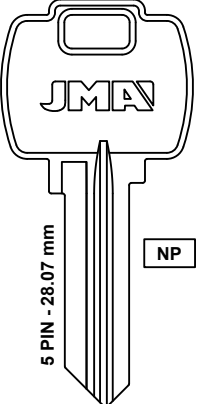

Z ZAMAK NS N. SILVER / ALPACA S STEEL / ACERO NE NEON NP NICKEL PLATED / LATON NIQUELADO CM FUN COLOR CK CRISTAL KEYS / PLASTICO COLOR A ALUMINUM / ALUMINIO B BRASS / LATON	FOR: EVVA®  2F EV-31 R62EV S EV-13D EV4 F EV-3D 62EV C EV-2 EVA1R A EV-1 EV6	FOR: EZ SET®  NP EZS-1 EZ2	FOR: F.F®  NP FF-12D FF-3	FOR: FAB®  S FB-17
	FOR: FAC®  S FAC-2D  S FAC-14D 56.6 mm	FOR: FALCON®  NP 6 PIN - 31.50 mm WP FAL-7D A1054WP WN FAL-6D A1054WN WL FAL-5D A1054WL WK FAL-4D A1054WK WH FAL-3D A1054WH WD FAL-1D FA3 WJ FAL-9D A1054WJ WR FAL-2D A1054WR WF FAL-8D A1054WF		
	FOR: FALCON®  NP 7 PIN - 35.65 mm WH FAL-12D L1054WH WD FAL-11D L1054WD WC FAL-10D L1054WC	FOR: FALCON®  NP 5 PIN - 28.07 mm WP FAL-18D 1054WP WN FAL-17D 1054WN WL FAL-16D 1054WL WK FAL-15D 1054WK WH FAL-14D 1054WH WD FAL-13D 1054WD WJ FAL-20D 1054WJ WR FAL-21D 1054WR WF FAL-19D 1054WF		

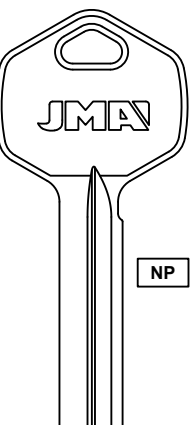
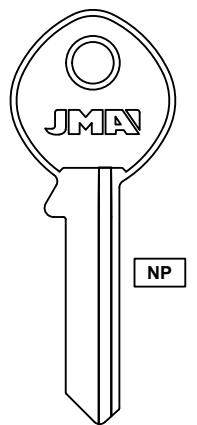
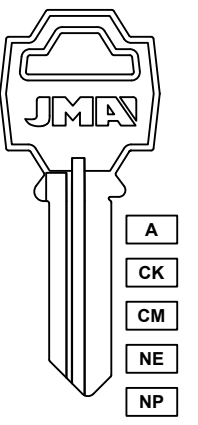
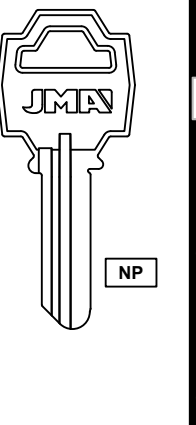
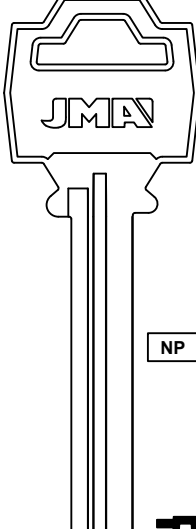
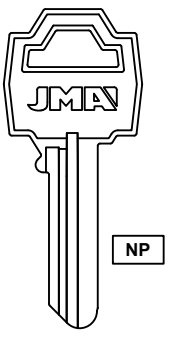
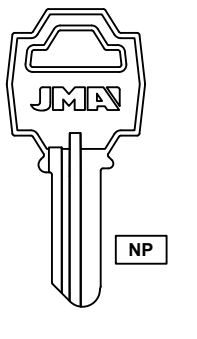
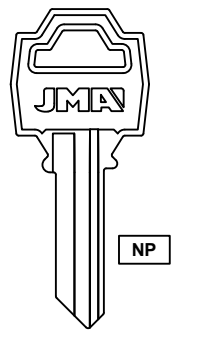
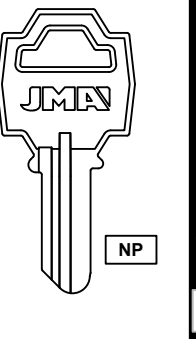
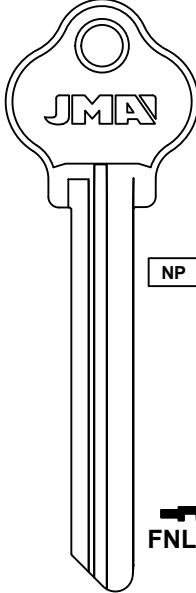
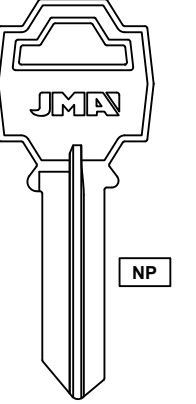
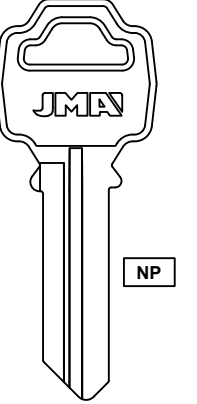
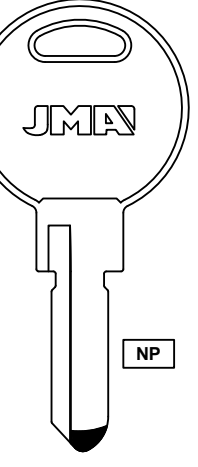
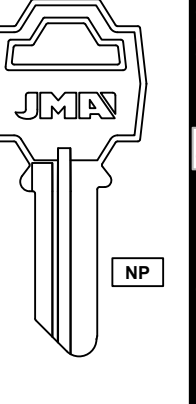
FOR: FALCON®  NP J FAL-30D FL9 G FAL-28D FL7 C FAL-26D FL5 D FAL-24D FL3 A FAL-22D FL1 FM FAL-31D FL10 H FAL-29D FL8 F FAL-27D FL6 E FAL-25D FL4 B FAL-23D FL2	FOR: FAMA®  NP FAM-1 FAM-1D	FOR: FANAL®  NP A CK CM NE NP FNL-1D R63  NP FNL-2D R64
FOR: FANAL®  NP FNL-3D  NP FNL-4D  NP FNL-5D  NP FNL-6  NP FNL-7D		
FOR: FANAL®  NP FNL-8D  NP FNL-10D  NP FNL-11D  NP FNL-12  NP FNL-13D		

Concerning the marks and commercial denominations see note in index.

Concerniente a las marcas y denominaciones comerciales ver nota en indice.

Concernant les marques et denominations commerciales voir la note dans l'index.



Concerning the marks and commercial denominations see note in index.

Concerniente a las marcas y denominaciones comerciales ver nota en indice.

Concernant les marques et denominations commerciales voir la note dans l'index.

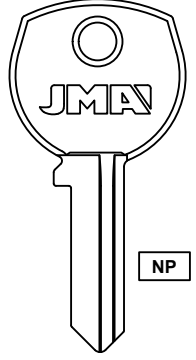
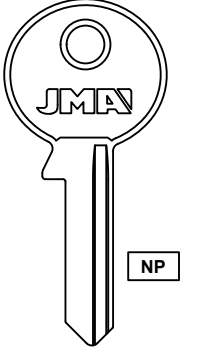
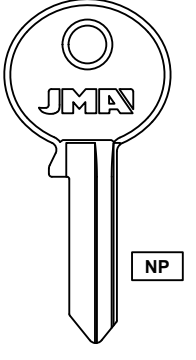
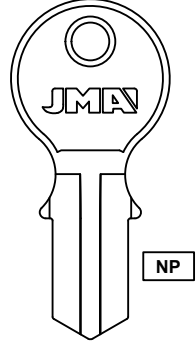
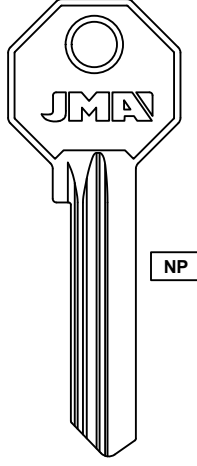
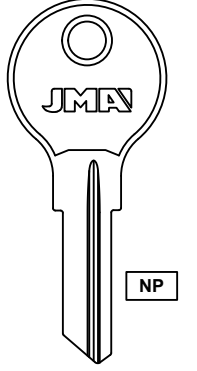
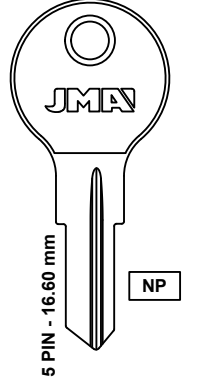
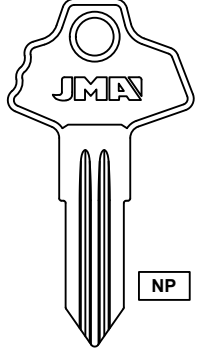
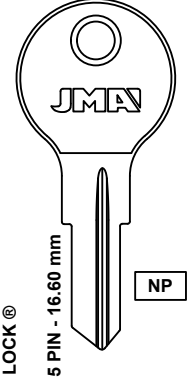
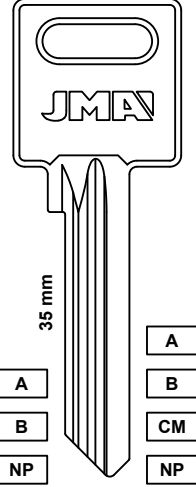
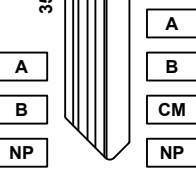
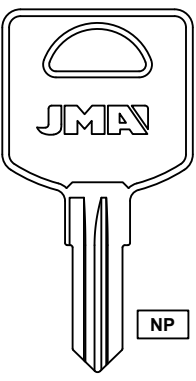
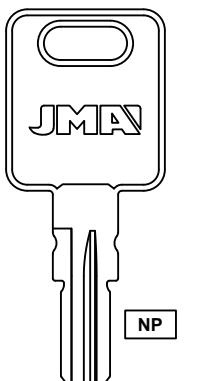
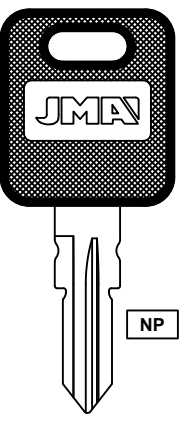
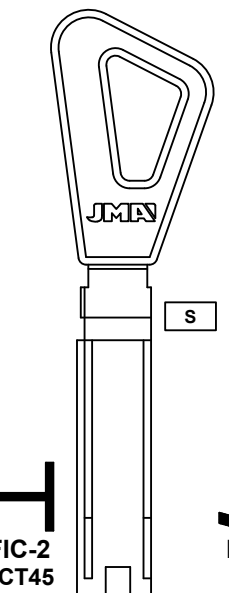
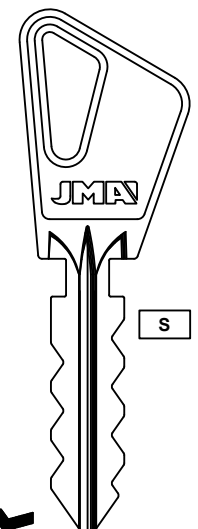
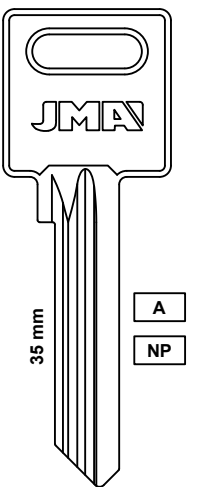
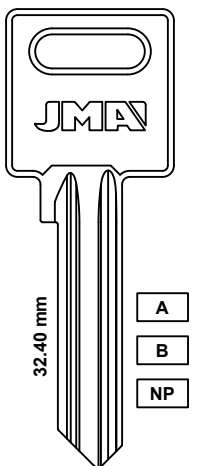
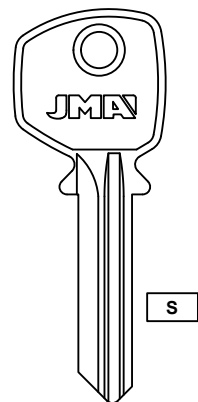
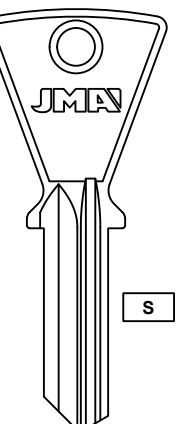
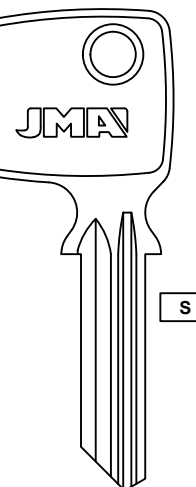
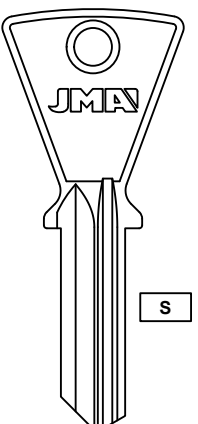
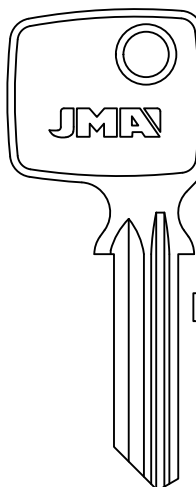
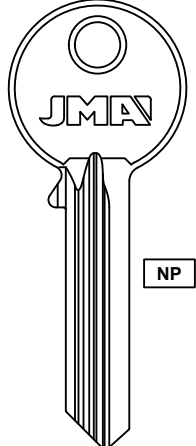
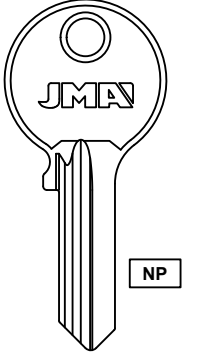
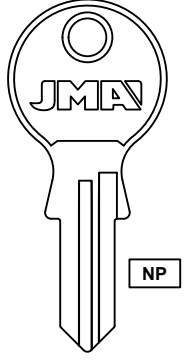
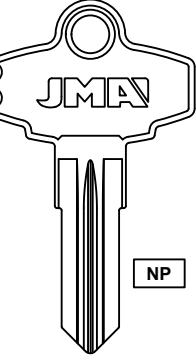
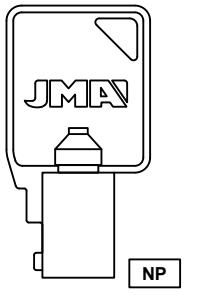
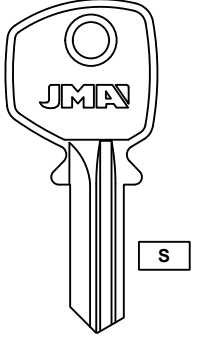
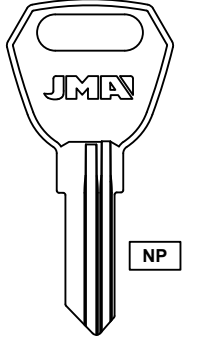
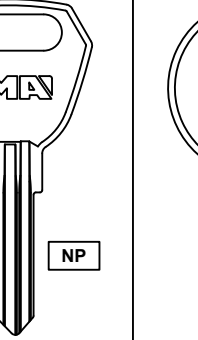
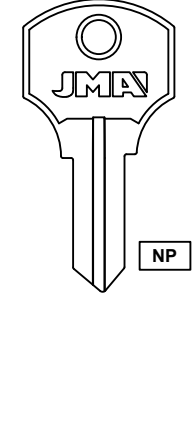
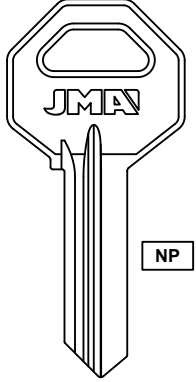
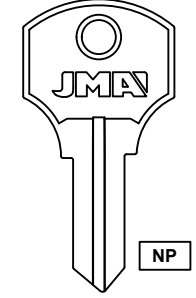

<p>Z ZAMAK NS N. SILVER / ALPACA S STEEL / ACERO NE NEON NP NICKEL PLATED / LATON NIQUELADO GM FUN COLOR CK CRISTAL KEYS / PLASTICO COLOR A ALUMINUM / ALUMINIO B BRASS / LATON</p>	<p>FOR: FECHADURA®</p>    <p>FEC-4D FEC-5 FEC-6D</p>			<p>FOR: FEMSA®</p>  <p>FEM-4D</p>		<p>FOR: FERP®</p>  <p>FRP-1D</p>		<p>FOR: FORT®</p>     <p>FR-11D FR-12D FR-13 FR-14D</p>				<p>FOR: FORTE®</p>   <p>FTE-1 FTE-1D</p>	
	<p>FOR: FIC®</p>    <p>FCS-1D FCS-2D FCS-2D.P</p>			<p>FOR: FICHET®</p>   <p>FIC-2 FIC-7</p>		<p>FOR: FORTE®</p>     <p>FTE-2 FTE-2D FTE-3 FTE-3D</p>				<p>FOR: FTH®</p>    <p>TD-1 TD-3 TD-4</p>			
	<p>FOR: FLOOD®</p>    <p>FLD-1D FLD-2D FLD-3</p>			<p>FOR: FORT®</p>   <p>ARR-2 CHI-1T</p>		<p>FOR: FTH®</p>  <p>TD-15</p>				<p>FOR: FULTON HITCH®</p>   <p>FLT-1 FLT-1D</p>		<p>FOR: GATO®</p>    <p>GAT-1 GAT-2D GAT-3D</p>	
				<p>Ø EXTERIOR : 9.50 MM Ø INTERIOR : 7.90 MM</p>									

Concerning the marks and commercial denominations see note in index.

Concerniente a las marcas y denominaciones comerciales ver nota en indice.

Concernant les marques et denominations commerciales voir la note dans l'index.

Concerning the marks and commercial denominations see note in index.

Concerniente a las marcas y denominaciones comerciales ver nota en indice.

Concernant les marques et denominations commerciales voir la note dans l'index.

Z ZAMAK NS N. SILVER / ALPACA S STEEL / ACERO NE NEON NP NICKEL PLATED / LATON NIQUELADO GM FUN COLOR CK CRISTAL KEYS / PLASTICO COLOR A ALUMINUM / ALUMINIO B BRASS / LATON	FOR: GATO® GAT-4 GAT-4D NP	FOR: GE-GE® GE-1D GE5 GE-21D GE6 S	FOR: GENERAL® GEN-1D G191 GEN-2D G192 GEN-3D G193 GEN-4D G194 GEN-5D G190B NS 5 PIN - 27.60 mm	
	FOR: GENERAL®			
	 GEN-13D G197 NS 5 PIN - 27.60 mm	 GEN-12D G196 GEN-11D G195 GEN-1D G191 GEN-14D G190C	 GEN-20D G199 GEN-19D G198 GEN-11D G195 GEN-2D G192 GEN-21D G190D	 GEN-24D G190 GEN-19D G198 GEN-12D G196 GEN-3D G193 GEN-25D G190E
FOR: GENERAL®				
 GEN-24D G190 NS 5 PIN - 27.60 mm	 GEN-20D G199 GEN-13D G197 GEN-4D G194 GEN-28D G190F	 GEN-9D G194A GEN-8D G193A GEN-7D G192A GEN-6D G191A GEN-10D G190BA	 GEN-26D G190A GEN-16D G196A GEN-6D G191A GEN-27D G190EA	

FOR: GENERAL®				
 GEN-16D G196A NS 6 PIN - 31.40 mm	 GEN-15D G195A GEN-6D G191A GEN-17D G190CA	 GEN-15D G195A GEN-7D G192A GEN-22D G190DA	 GEN-26D G190A GEN-9D G194A GEN-29D G190FA	 GEN-18D G190M NS 5 PIN - 27.60 mm
FOR: GENERAL® GEN-23D G190MA NS 6 PIN - 31.40 mm	FOR: GIBBONS® GIB-1D 1033G S	FOR: GIUSSANI® GIU-1 SIM2 S	FOR: GLOBE® GLO-1 GLO-1D GLO-2 GLO-2D NP	
FOR: GLOBE®				
 GLO-3 NP	 GLO-3D NP	 GLO-4I NP	 GLO-4D NP	 GLO-5I NP
 GLO-6 NP	 GLO-6D NP	 GLO-7 NP	 GLO-7D NP	 GLO-7D NP



Concerning the marks and commercial denominations see note in index.

Concerniente a las marcas y denominaciones comerciales ver nota en indice.

Concernant les marques et denominations commerciales voir la note dans l'index.



Concerning the marks and commercial denominations see note in index.

Concerniente a las marcas y denominaciones comerciales ver nota en indice.

Concernant les marques et denominations commerciales voir la note dans l'index.



Z ZAMAK	NS N.SILVER / ALPACA S STEEL / ACERO	FOR: GLOBE®								
		GLO-9D GB3	GLO-10 GB4	GLO-13D	GLO-14 GB1	GLO-15				
NE NEON NP NICKEL PLATED / LATON NIQUELADO	NE NEON NP NICKEL PLATED / LATON NIQUELADO	FOR: GLOBE®								
		GLO-16	GLO-16D	GLO-17	GLO-17D	GLO-18				
A ALUMINUM / ALUMINIO B BRASS / LATON	GM FUN COLOR CK CRISTAL KEYS / PLASTICO COLOR	FOR: GLOBE®		FOR: GOLD®		FOR: GUARD SECURITY®		FOR: GUERVILLE®		
		GLO-21	GLD-1	GRS-1 1672	GR-21 GU91F	GR-2D GU91G	GR-11 GU4	GR-1D GU4R	GR-31 GU3	GR-3D GU91B

Z ZAMAK	NS N.SILVER / ALPACA S STEEL / ACERO	FOR: HAFELE®		FOR: HALO®		FOR: HARLOC®		FOR: HAYWORTH®		
		HAF-7	HAF-2	HAF-2D 1670	HAO-1D HL1	HAR-11 EA27	HAR-2D HR1	HAW-4D HAW3	HAW-3D HAW2	HAW-2D HAW4
NE NEON NP NICKEL PLATED / LATON NIQUELADO	NS N.SILVER / ALPACA S STEEL / ACERO	FOR: HENDERSON®		FOR: HERD®			FOR: HUDSON®			
		HEN-1 HN2	HER-1	HER-2D	HER-3	AMM-4 B5				
A ALUMINUM / ALUMINIO B BRASS / LATON	GM FUN COLOR CK CRISTAL KEYS / PLASTICO COLOR	FOR: HUDSON®								
		CCL-11 CO68	CCL-34D 1000XK	CHI-12D CG16	HUD-3 CO106	HUD-3D BO1	HUD-4 1098X			



Concerning the marks and commercial denominations see note in index.

Concerniente a las marcas y denominaciones comerciales ver nota en indice.

Concernant les marques et denominations commerciales voir la note dans l'index.



Concerning the marks and commercial denominations see note in index.

Concerniente a las marcas y denominaciones comerciales ver nota en indice.

Concernant les marques et denominations commerciales voir la note dans l'index.



		FOR: HUDSON®			FOR: HURD®				
Z	ZAMAK								
		NP	NP	NP	NP	NP	NP	NP	
NS	N SILVER / ALPACA								
S	S STEEL / ACERO								
		FOR: HUWIL®		FOR: IFAM®					
NE	NEON								
		NP	S	NS	NP	S			
NE	NICKEL PLATED / LATON NIQUELADO								
NP	PLASTICO COLOR								
		FOR: IFAM®							
CM	FUN COLOR								
		S	S	S	S	S	S	S	S
CK	CRISTAL KEYS / PLASTICO COLOR								
A	ALUMINUM / ALUMINIO								
B	BRASS / LATON								

		FOR: IFAM®			FOR: ILARGI®		FOR: ILCO®		
Z	ZAMAK								
		NP	S	NP	S	NP	NP		
NS	N SILVER / ALPACA								
S	S STEEL / ACERO								
		FOR: ILCO®							
NE	NEON								
		NP	NP	NP	NP	NP	NP	NP	
NE	NICKEL PLATED / LATON NIQUELADO								
NP	PLASTICO COLOR								
		FOR: ILCO®							
CM	FUN COLOR								
		NP	NP	NP	NP	NP	NP	NP	
CK	CRISTAL KEYS / PLASTICO COLOR								
A	ALUMINUM / ALUMINIO								
B	BRASS / LATON								

! Concerning the marks and commercial denominations see note in index.
Concerniente a las marcas y denominaciones comerciales ver nota en indice.
Concernant les marques et denominations commerciales voir la note dans l'index.

! Concerning the marks and commercial denominations see note in index.
Concerniente a las marcas y denominaciones comerciales ver nota en indice.
Concernant les marques et denominations commerciales voir la note dans l'index.

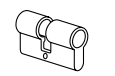
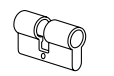

Z ZAMAK	FOR: ILLINOIS®					
NS S						
NE NP	FOR: ILLINOIS®		FOR: IMPORT®		FOR: JEN-WEI®	FOR: JIS®
CM CK	FOR: JOWIL®		FOR: JUNIE®		FOR: KALE®	

FOR: KALE®		FOR: KEIL®		FOR: KJV®		FOR: KIMBALL®	
	FOR: KWIKSET®		FOR: KWIKSET®		FOR: KWIKSET®		
		FOR: KIMBERLEY®		FOR: KWIKSET®		FOR: KWIKSET®	

Z ZAMAK	FOR: KWIKSET®			FOR: LAPERCHE®	FOR: LAPORTE®
	 NP	 NP	 NP	 S	 S
	 KWI-5D KW11	 KWI-9D KW5		 LAP-1	 LPO-1 LAP2
NS S	FOR: LAPORTE®			FOR: LARSON DOOR®	FOR: LAS®
	 S	 NP	 S	 S	 S
	 LPO-2 LAP1	 LRD-1 LD2	 LRD-1D LD1	 LAS-FH L6S	 LAS-KT L4RM
NE NP	FOR: LAS®			FOR: LASBOLAGET®	FOR: LEGGE®
	 S	 S	 S	 S	 S
	 LAS-1D L2EX	 LAS-4 L6FM	 LAS-6D L4A1	 LASB-3D LS33	 LEG-1D 62LG
CM CK	FOR: LAS®			FOR: LASBOLAGET®	FOR: LANCE®
	 S	 S	 S	 S	 S
	 LAS-XY L3XY	 LASB-2 LS10	 LASB-2D LS11	 LASB-1 LS18	 LIN-11 LC1
A B	FOR: LAS®			FOR: LASBOLAGET®	FOR: LANCE®
	 S	 S	 S	 S	 S
	 LAS-TX L3TX	 LASB-3D LS33	 LASB-1D LS19	 LIN-1D LC1	 LIN-1D LC2

FOR: LINCE®						
 S	 S	 S	 S	 S	 S	 S
 LIN-15I LC8	 LIN-15D S1096G	 LIN-3I LC5R	 LIN-3D S1096G	 LIN-5I LC5R	 LIN-5D LC5	 LIN-6D LC4
FOR: LION®		FOR: LIPS®		FOR: LITTO®		
 NP	 S	 S	 S	 S	 S	 S
 LIO-1	 LIP-2 LP29	 LIP-2D LP29R	 LIP-33 LP7	 LIT-11 LT3	 LIT-5I LT2	 LT-5D LT1
FOR: LOCK®						
 NP	 NP	 NP	 NP	 NP		
 ABU-3 2.90 mm	 LOC-1D 1585	 LOC-1T	 LOC-2D	 LOC-3D	Ø EXTERIOR : 7 MM Ø INTERIOR : 5.40 MM	



Concerning the marks and commercial denominations see note in index.

Concerniente a las marcas y denominaciones comerciales ver nota en indice.

Concernant les marques et denominations commerciales voir la note dans l'index.



Concerning the marks and commercial denominations see note in index.

Concerniente a las marcas y denominaciones comerciales ver nota en indice.

Concernant les marques et denominations commerciales voir la note dans l'index.



Z ZAMAK
NS N. SILVER / ALPACA
S STEEL / ACERO
NE NEON
NP NICKEL PLATED / LATON NIQUELADO
CM FUN COLOR
CK CRISTAL KEYS / PLASTICO COLOR
A ALUMINUM / ALUMINIO
B BRASS / LATON

Z ZAMAK
NS N. SILVER / ALPACA
S STEEL / ACERO
NE NEON
NP NICKEL PLATED / LATON NIQUELADO
CM FUN COLOR
CK CRISTAL KEYS / PLASTICO COLOR
A ALUMINUM / ALUMINIO
B BRASS / LATON

FOR: LOCK®

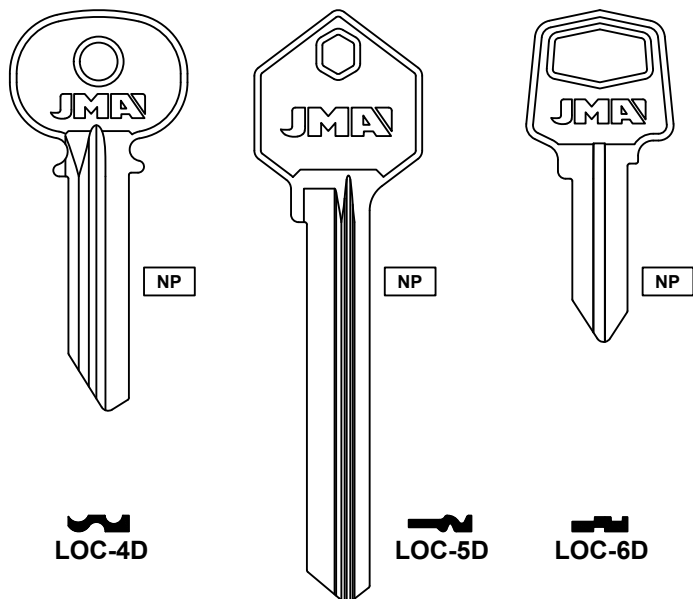

FOR: LOCKWOOD®

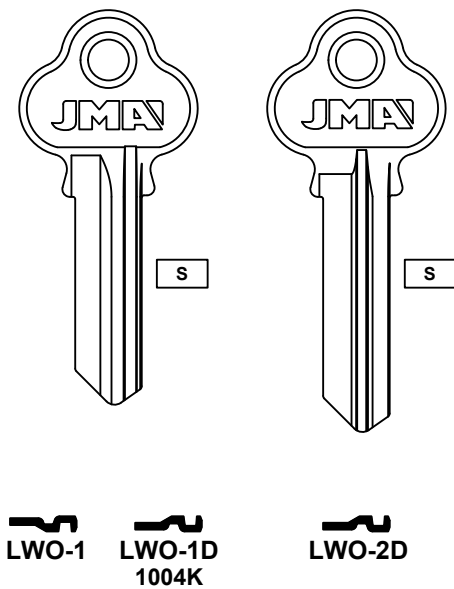

FOR: LORI®

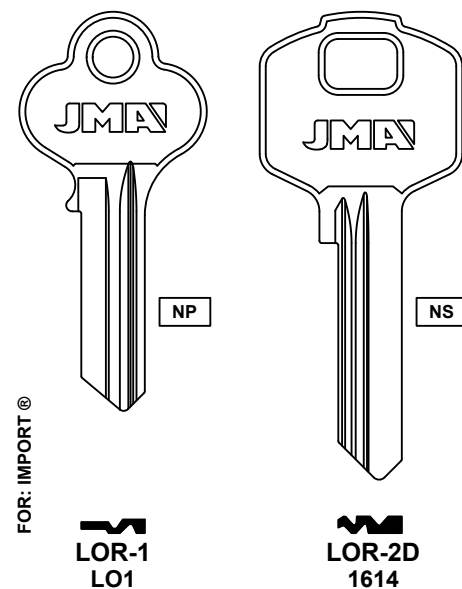

FOR: LOWE & FLETCHER®

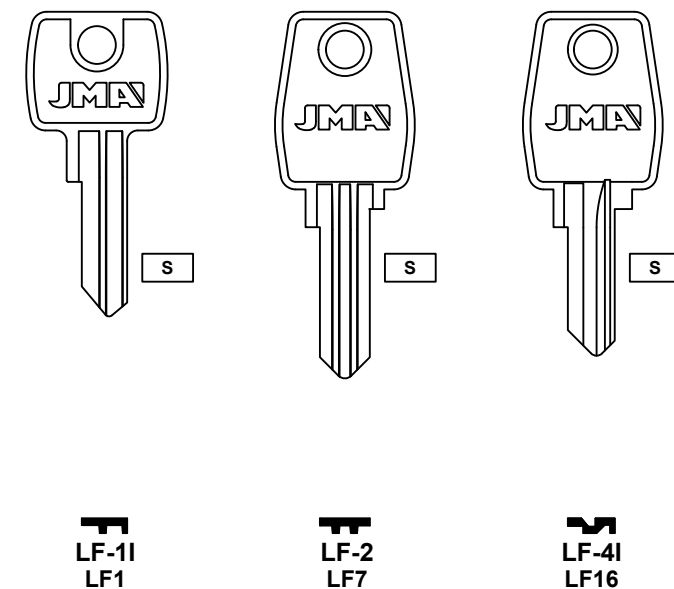

FOR: LOCKWOOD®

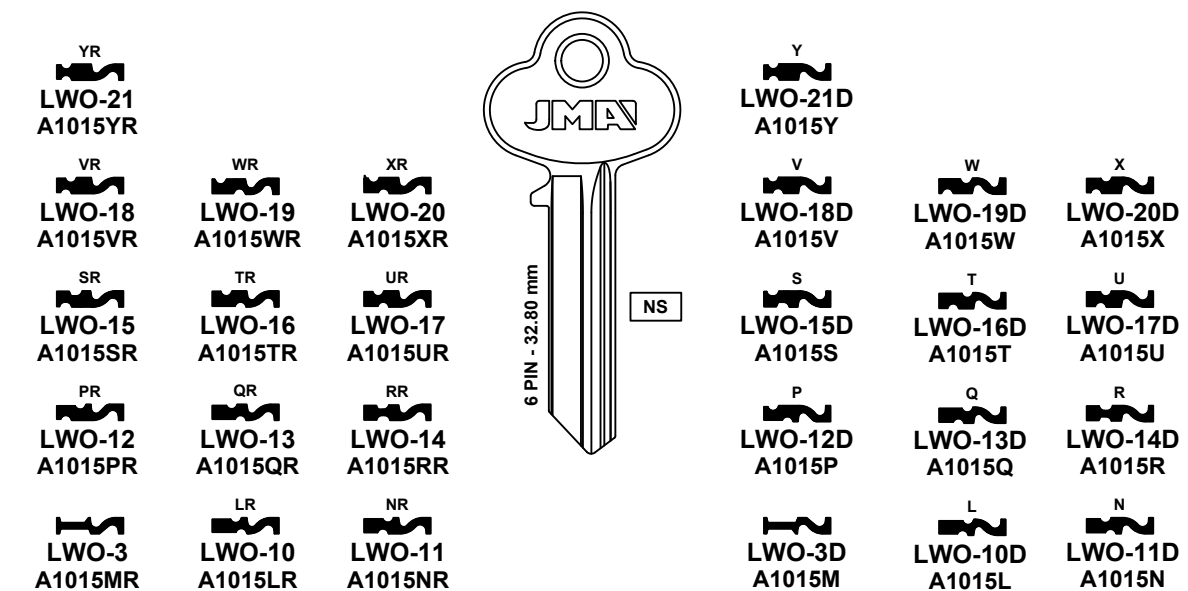

FOR: LOWE & FLETCHER®

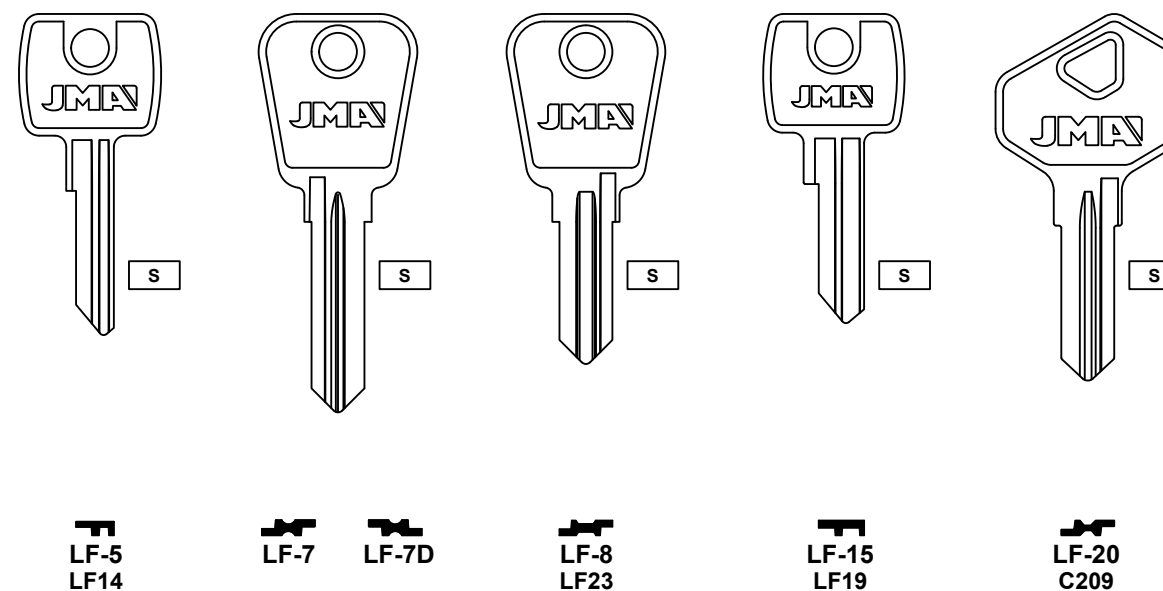

FOR: LOCKWOOD®

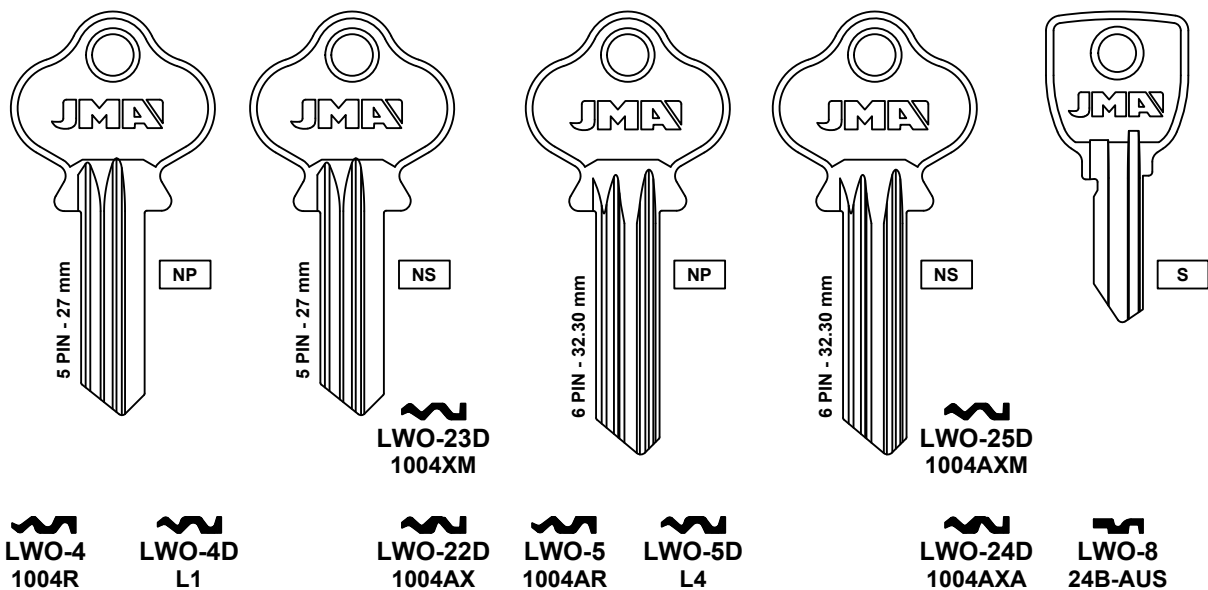

FOR: LOWE & FLETCHER®

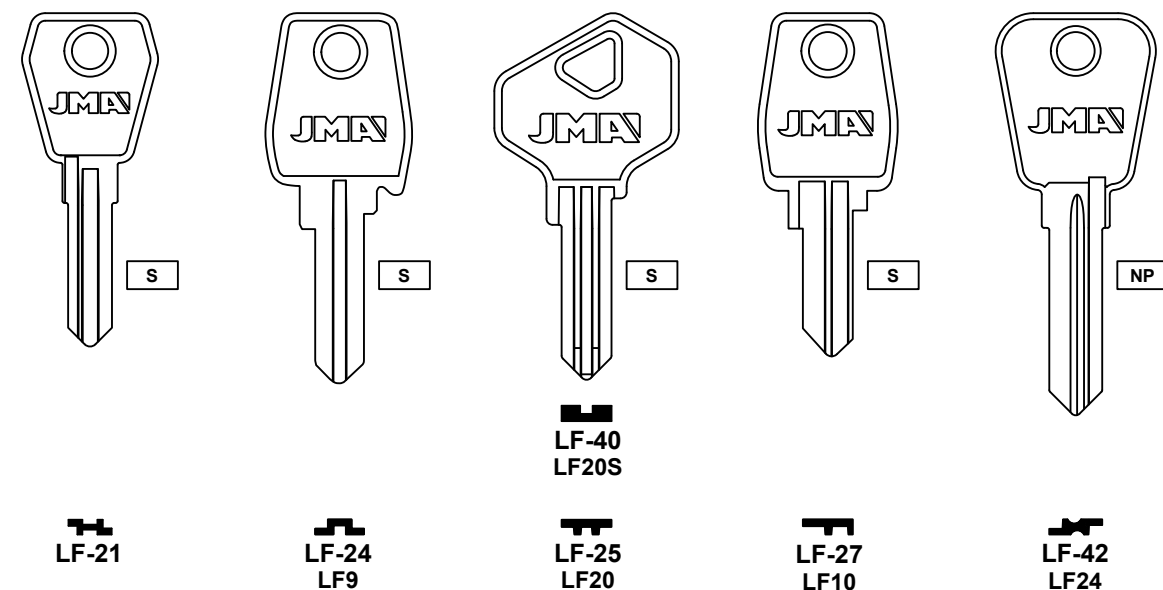

Concerning the marks and commercial denominations see note in index.

Concerniente a las marcas y denominaciones comerciales ver nota en indice.

Concernant les marques et denominations commerciales voir la note dans l'index.

Concerning the marks and commercial denominations see note in index.

Concerniente a las marcas y denominaciones comerciales ver nota en indice.

Concernant les marques et denominations commerciales voir la note dans l'index.



Z ZAMAK NS N.SILVER / ALPACA S STEEL / ACERO NE NEON NP NICKEL PLATED / LATON NIQUELADO CM FUN COLOR CK CRISTAL KEYS / PLASTICO COLOR A ALUMINUM / ALUMINIO B BRASS / LATON	FOR: LSDA® NP LSD-1D EZ1	FOR: MAGNUN® NP MAG-3D	FOR: MASTER® NP MAS-24D M26 NP MAS-11 NP MAS-11D M5 NP MAS-12D M4 NP MAS-2D M21 NP MAS-3D M12		
	FOR: MASTER® NP MAS-4D NP MAS-5D M11 NP MAS-6 NP MAS-7 M2 NP MAS-7D M3 NP MAS-8 M14 NP MAS-9 M10 NP MAS-9D M16				
	FOR: MASTER® NP MAS-9S 15K / M10 NP MAS-9DS M16 NP MAS-10 M1 NP MAS-10D 1092R NP MAS-10C DNDM1 NP MAS-10S 1K / M1 NP MAS-10DS NP MAS-13D M13				

Z ZAMAK NS N.SILVER / ALPACA S STEEL / ACERO NE NEON NP NICKEL PLATED / LATON NIQUELADO CM FUN COLOR CK CRISTAL KEYS / PLASTICO COLOR A ALUMINUM / ALUMINIO B BRASS / LATON	FOR: MASTER® NP MAS-14 NP MAS-16D MD17 NP MAS-17 NP MAS-17D NP MAS-18D M20 NP MAS-19 M19 NP MAS-25D M25 NP MAS-34D				
	FOR: MASTER® NP MAS-33 1092E NP MAS-33D 1092DD NP MAS-21D M17 NP MAS-23 NP MAS-26 NP MAS-26D NP MAS-27D NP MAS-28 NP MAS-29D				
	FOR: MASTER® NP MAS-31D M18 NP MAS-32 NP MAS-35 NP MAS-36D M29 NP MAS-39D M27				



Concerning the marks and commercial denominations see note in index.

Concerniente a las marcas y denominaciones comerciales ver nota en indice.

Concernant les marques et denominations commerciales voir la note dans l'index.











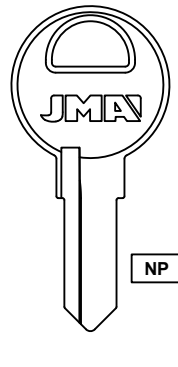
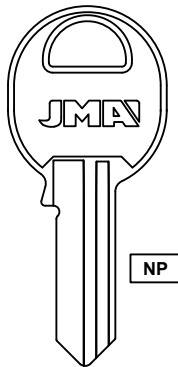
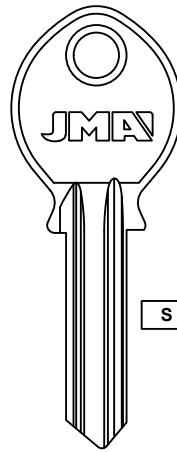
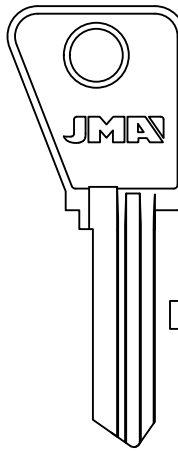
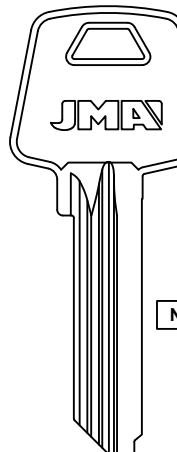
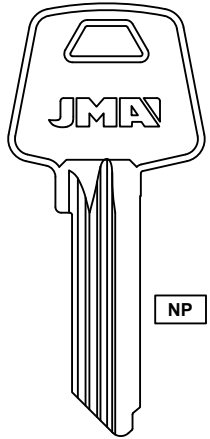
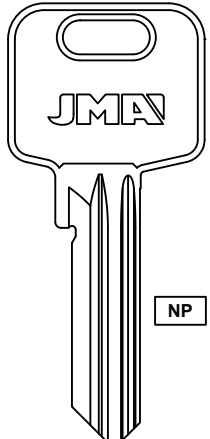
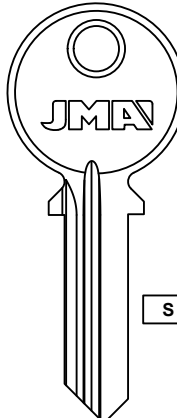
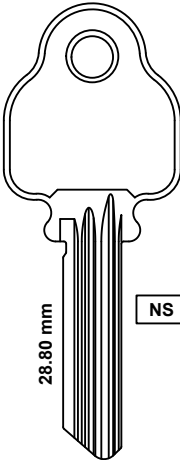
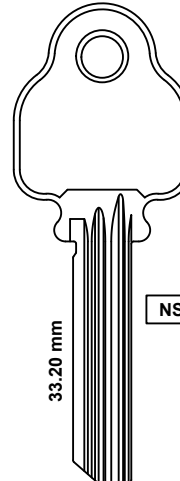
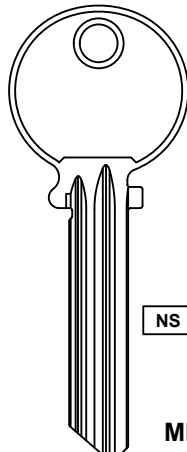
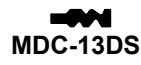

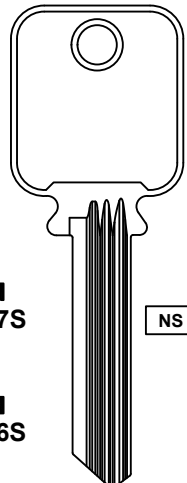
Concerning the marks and commercial denominations see note in index.

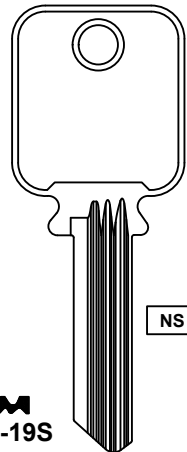
Concerniente a las marcas y denominaciones comerciales ver nota en indice.

Concernant les marques et denominations commerciales voir la note dans l'index.

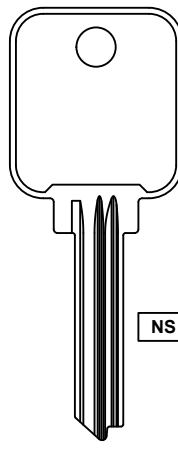
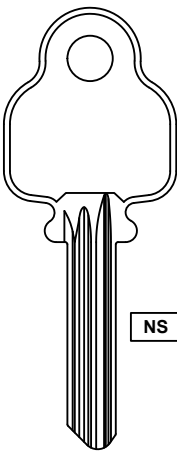
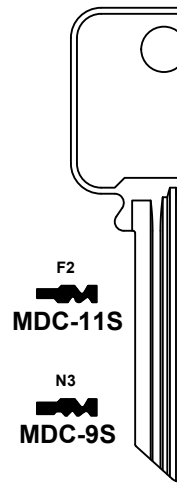
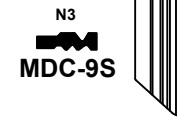

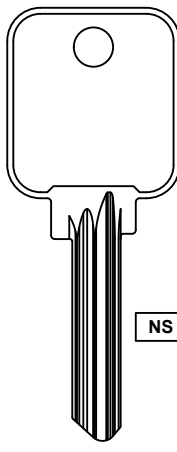
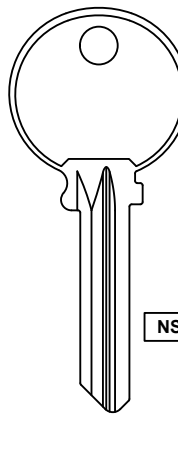
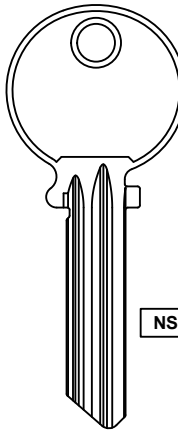
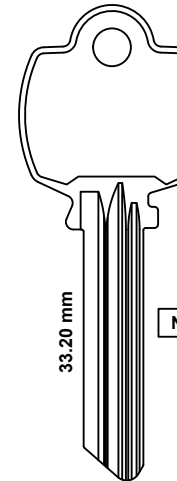
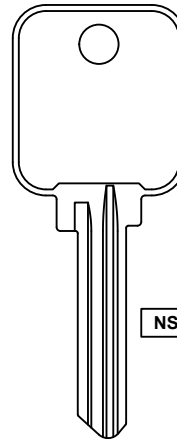
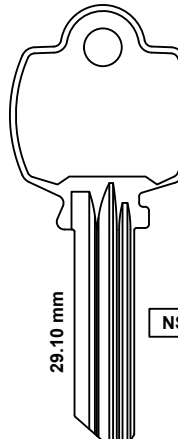
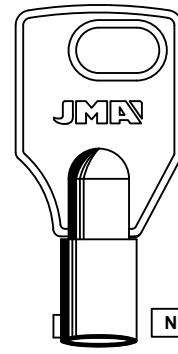
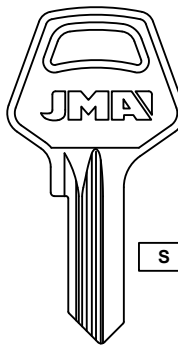
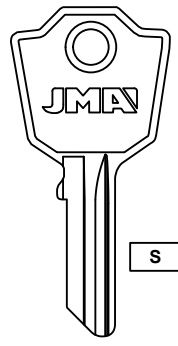
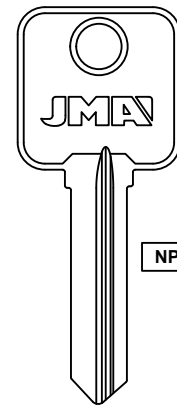
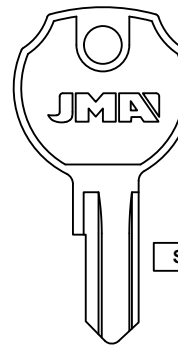
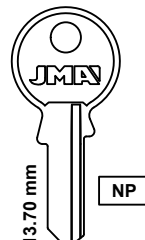
Z ZAMAK NS N. SILVER / ALPACA S STEEL / ACERO NE NEON NP NICKEL PLATED / LATON NIQUELADO CM FUN COLOR CK CRISTAL KEYS / PLASTICO COLOR A ALUMINUM / ALUMINIO B BRASS / LATON	FOR: MASTER®  MAS-40D M28  MAS-41 M24		FOR: MCM®  MCM-1 MCM1  MCM-6 MM2  MCM-12D		
	FOR: MCM®  MCM-13D  MCM-24C		FOR: MECO®  MEC-5D ME11	FOR: MEDECO®  MDC-1S 1517  MDC-2S A1517	
	FOR: MEDECO®  MDC-3DS A1515  MDC-13DS  MDC-16S  MDC-16DS  MDC-17S  MDC-18DS  MDC-19S  MDC-5S 1638				

Z ZAMAK NS N. SILVER / ALPACA S STEEL / ACERO NE NEON NP NICKEL PLATED / LATON NIQUELADO CM FUN COLOR CK CRISTAL KEYS / PLASTICO COLOR A ALUMINUM / ALUMINIO B BRASS / LATON	FOR: MEDECO®  MDC-6S 1655  MDC-7S 1543  MDC-11S  MDC-9S  MDC-8DS  MDC-10S 1518  MDC-12DS 1542				
	FOR: MEDECO®  MDC-14DS 1515  MDC-15S  MDC-20DS  MDC-21S				FOR: MERONI®  MER-3T Ø EXTERIOR. : 9.50 MM Ø INTERIOR. : 7.90 MM
	FOR: MERONI®  MER-16D ME2  MER-17 ME3		FOR: METAL ROUSSEAU®  MTR-1D MR1	FOR: METEOR®  MTO-1 MO1	FOR: MG®  MGG-1  MGG-1D

Concerning the marks and commercial denominations see note in index.

Concerniente a las marcas y denominaciones comerciales ver nota en indice.

Concernant les marques et denominations commerciales voir la note dans l'index.



Concerning the marks and commercial denominations see note in index.

Concerniente a las marcas y denominaciones comerciales ver nota en indice.

Concernant les marques et denominations commerciales voir la note dans l'index.



Z ZAMAK NS N.SILVER / ALPACA S STEEL / ACERO NE NEON NP NICKEL PLATED / LATON NIQUELADO CM FUN COLOR CK CRISTAL KEYS / PLASTICO COLOR A ALUMINUM / ALUMINIO B BRASS / LATON	FOR: ODIS®				
	19.20 mm				
	OD-8D	OD-9D	OD-10D	OD-14D	OD-15D
	FOR: ODIS®		FOR: OJMAR®		
	OD-18D	OD-19D	OJ-6I	OJ-9D	OJ-13
	FOR: OJMAR®	FOR: P & CI®	FOR: PADO®		
	OJ-14	PCI-1T	PAD-4	PAD-4D	PAD-5
			PAD-6		

Z ZAMAK NS N.SILVER / ALPACA S STEEL / ACERO NE NEON NP NICKEL PLATED / LATON NIQUELADO CM FUN COLOR CK CRISTAL KEYS / PLASTICO COLOR A ALUMINUM / ALUMINIO B BRASS / LATON	FOR: PAPAIZ®				
	PAP-13	PAP-13D	PAP-14	PAP-14D	PAP-15
	FOR: PAPAIZ®				
	PAP-1	PAP-2	PAP-3	PAP-4	PAP-5
	FOR: PAPAIZ®				
	PAP-8	PAP-9	PAP-11	PAP-12	PAP-15D
	FOR: PHILLIPS®				
	PHI-1D	PHI-2D	PHI-4	PHI-4D	PHI-6
				PHI-10	



Concerning the marks and commercial denominations see note in index.

Concerniente a las marcas y denominaciones comerciales ver nota en indice.

Concernant les marques et denominations commerciales voir la note dans l'index.



Concerning the marks and commercial denominations see note in index.

Concerniente a las marcas y denominaciones comerciales ver nota en indice.

Concernant les marques et denominations commerciales voir la note dans l'index.



Z ZAMAK	FOR: PHILLIPS®				
	NP	18.50 mm CM NP	28.70 mm NP	NP	27 mm A CK CM NE NP
	PHI-16	PHI-32 PH32	PHI-32L	PHI-39	PHI-52 PHA1
NS N. SILVER / ALPACA S STEEL / ACERO	FOR: PHILLIPS®				
	51 mm A CM NE NP	NP	NP	S	S
	PHI-52L PHA2	PLI-1D	PLI-2D	PR-1 SR9P	PR-1D S9P
					PR-4I PR91NS
NE NEON NP NICKEL PLATED / LATON NIQUELADO	FOR: POLI®		FOR: PREFER®		
	NP	S	NP	NP	NP
	PR-7 PR91C	PR-6	PUN-1D 1866-10	PUN-2D 1866-13	PUN-3D PU3
A ALUMINUM / ALUMINIO B BRASS / LATON	FOR: PREFER®		FOR: PUNDRÁ®		
	S	S	S	S	S
	RO-10I R61JD	RO-10D 61JD	RO-12I R15	RO-16I HVR61	RO-16D HV61
CM FUN COLOR CK CRISTAL KEYS / PLASTICO COLOR	FOR: RONE®				
	NP	NP	NP	NP	S
	RON-3D	RON-4D	RON-5D	RON-7D	RO-7I VR61S
					RO-7D Ri6
FM RO-25I LN3	FOR: RONIS®				
	NP	NP	NP	NP	S
	RO-24I RN4	RO-24D RN4R	RO-25I LN3	RO-26I LN1	RO-24D RN4R

Z ZAMAK	FOR: RABBIT®		FOR: REGAL®		FOR: RICOUARD®		FOR: RONE®	
	NP	S	S	NP	NP			
	RAB-1	REG-1D RG1	RIO-1D RC1	RON-1D	RON-2D			
NS N. SILVER / ALPACA S STEEL / ACERO	FOR: RONE®					FOR: RONIS®		
	NP	NP	NP	NP	NP	NP	S	
	RON-8D	RO-10I R61JD	RO-10D 61JD	RO-12I R15	RO-16I HVR61	RO-16D HV61	RO-24I RN4	
							RO-24D RN4R	
NE NEON NP NICKEL PLATED / LATON NIQUELADO	FOR: RONE®					FOR: RONIS®		
	NP	NP	NP	NP	NP	NP	S	
	RO-25I LN3	RO-26I LN1	RO-24I RN4	RO-24D RN4R	RO-25I LN3	RO-26I LN1	RO-24D RN4R	
A ALUMINUM / ALUMINIO B BRASS / LATON	FOR: RONE®					FOR: RONIS®		
	NP	NP	NP	NP	NP	NP	S	
	RO-25I LN3	RO-26I LN1	RO-24I RN4	RO-24D RN4R	RO-25I LN3	RO-26I LN1	RO-24D RN4R	

Concerning the marks and commercial denominations see note in index.
Concerniente a las marcas y denominaciones comerciales ver nota en indice.
Concernant les marques et denominations commerciales voir la note dans l'index.

Concerning the marks and commercial denominations see note in index.
Concerniente a las marcas y denominaciones comerciales ver nota en indice.
Concernant les marques et denominations commerciales voir la note dans l'index.

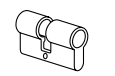
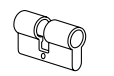

Z ZAMAK NS N.SILVER / ALPACA S STEEL / ACERO NE NEON NP NICKEL PLATED / LATON NIQUELADO CM FUN COLOR CK CRISTAL KEYS / PLASTICO COLOR A ALUMINUM / ALUMINIO B BRASS / LATON	FOR: RUKO®	FOR: RUSSWIN®
	FOR: RUSSWIN®	FOR: RUSSWIN®
NS NICKEL PLATED / LATON NIQUELADO NE NEON NP NICKEL PLATED / LATON NIQUELADO CM FUN COLOR CK CRISTAL KEYS / PLASTICO COLOR A ALUMINUM / ALUMINIO B BRASS / LATON	FOR: RUSSWIN®	FOR: RUSSWIN®
	FOR: RUSSWIN®	FOR: RUSSWIN®
NS NICKEL PLATED / LATON NIQUELADO NE NEON NP NICKEL PLATED / LATON NIQUELADO CM FUN COLOR CK CRISTAL KEYS / PLASTICO COLOR A ALUMINUM / ALUMINIO B BRASS / LATON	FOR: RUSSWIN®	FOR: RUSSWIN®
	FOR: RUSSWIN®	FOR: RUSSWIN®

Z ZAMAK NS N.SILVER / ALPACA S STEEL / ACERO NE NEON NP NICKEL PLATED / LATON NIQUELADO CM FUN COLOR CK CRISTAL KEYS / PLASTICO COLOR A ALUMINUM / ALUMINIO B BRASS / LATON	FOR: RUSSWIN®	FOR: RUSSWIN®
	FOR: RUSSWIN®	FOR: RUSSWIN®
Z ZAMAK NS NICKEL PLATED / ALPACA S STEEL / ACERO NE NEON NP NICKEL PLATED / LATON NIQUELADO CM FUN COLOR CK CRISTAL KEYS / PLASTICO COLOR A ALUMINUM / ALUMINIO B BRASS / LATON	FOR: RUSSWIN®	FOR: RUSSWIN®
	FOR: RUSSWIN®	FOR: RUSSWIN®



Concerning the marks and commercial denominations see note in index.

Concerniente a las marcas y denominaciones comerciales ver nota en indice.

Concernant les marques et denominations commerciales voir la note dans l'index.



Concerning the marks and commercial denominations see note in index.

Concerniente a las marcas y denominaciones comerciales ver nota en indice.

Concernant les marques et denominations commerciales voir la note dans l'index.



Z ZAMAK	NS N.SILVER / ALPACA S STEEL / ACERO	FOR: RUSSWIN®								
		RUS-27 A1011-26N	RUS-28 A1011-27N	RUS-29 A1011-28N	RUS-27D A1011-12N	RUS-28D A1011-13N	RUS-29D A1011-14N			
		RUS-24 A1011-23N	RUS-25 A1011-24N	RUS-26 A1011-25N	RUS-24D A1011-9N	RUS-25D A1011-10N	RUS-26D A1011-11N			
		RUS-21 A1011-20N	RUS-22 A1011-21N	RUS-23 A1011-22N	RUS-21D A1011-6N	RUS-22D A1011-7N	RUS-23D A1011-8N			
		RUS-18 A1011-17N	RUS-19 A1011-18N	RUS-20 A1011-19N	RUS-18D A1011-3N	RUS-19D A1011-4N	RUS-20D A1011-5N			
NS N.SILVER / ALPACA S STEEL / ACERO	S	RUS-11 A1011PZR	RUS-16 A1011-15N	RUS-17 A1011-16N	RUS-11D A1011PZ	RUS-16D A1011-1N	RUS-17D A1011-2N			
NE NEON NP NICKEL PLATED / LATON NIQUELADO	NE NEON NP NICKEL PLATED / LATON NIQUELADO	FOR: RUSSWIN®								
		RUS-44D A1011H8	RUS-42D A1011H6	RUS-43D A1011H7	RUS-73D 1011K13	RUS-70D 1011K10	RUS-71D 1011K11	RUS-72D 1011K12		
		RUS-40D A1011H3	RUS-41D A1011H5	RUS-67D 1011K7	RUS-68D 1011K8	RUS-69D 1011K9	RUS-64D 1011K4	RUS-65D 1011K5	RUS-66D 1011K6	
		RUS-38D A1011H1	RUS-39D A1011H2	RUS-61D 1011K1	RUS-62D 1011K2	RUS-63D 1011K3	RUS-61D 1011K1	RUS-62D 1011K2	RUS-63D 1011K3	
CM FUN COLOR CK CRISTAL KEYS / PLASTICO COLOR	CM FUN COLOR CK CRISTAL KEYS / PLASTICO COLOR	FOR: SAFE®			FOR: SAMSONITE®					
		SAF-1	SAF-1D	SAF-3	SAF-3D	SAF-4	SAF-4D	SA-1 170S	SA-2 80S	
A ALUMINIUM / ALUMINIO B BRASS / LATON	A ALUMINIUM / ALUMINIO B BRASS / LATON	FOR: SARGENT®								
		SAR-8 1007LA	SAR-69 1007LB	SAR-70 1007LC	SAR-71 1007LE	SAR-72 1007LF	SAR-73 1007LG	SAR-74 1007LJ	SAR-75 1007LK	SAR-76 1007LL
		SAR-77 1007LD	SAR-78 1007LH	SAR-79 1007LM	SAR-80 1007LDH	SAR-81 1007LHM	SAR-8 1007LA	SAR-69 1007LB	SAR-70 1007LC	SAR-71 1007LE
		SAR-80 1007LDH	SAR-81 1007LHM	SAR-6 N1007KMB	SAR-8 1007LA	SAR-69 1007LB	SAR-70 1007LC	SAR-71 1007LE	SAR-72 1007LF	SAR-73 1007LG
A ALUMINIUM / ALUMINIO B BRASS / LATON	A ALUMINIUM / ALUMINIO B BRASS / LATON	FOR: SARGENT®								
		SAR-8D 1007RA	SAR-69D 1007RB	SAR-70D 1007RC	SAR-71D 1007RE	SAR-72D 1007RF	SAR-73D 1007RG	SAR-74D 1007RJ	SAR-75D 1007RK	SAR-76D 1007RL
		SAR-77D 1007RD	SAR-78D 1007RH	SAR-79D 1007RM	SAR-80D 1007RDH	SAR-81D 1007RHM	SAR-8D 1007RA	SAR-69D 1007RB	SAR-70D 1007RC	SAR-71D 1007RE
		SAR-80D 1007RDH	SAR-81D 1007RHM	SAR-6D N1007RMB	SAR-8D 1007RA	SAR-69D 1007RB	SAR-70D 1007RC	SAR-71D 1007RE	SAR-72D 1007RF	SAR-73D 1007RG



Concerning the marks and commercial denominations see note in index.

Concerniente a las marcas y denominaciones comerciales ver nota en indice.

Concernant les marques et denominations commerciales voir la note dans l'index.



Concerning the marks and commercial denominations see note in index.

Concerniente a las marcas y denominaciones comerciales ver nota en indice.

Concernant les marques et denominations commerciales voir la note dans l'index.

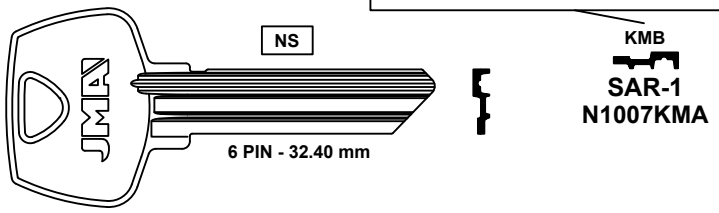
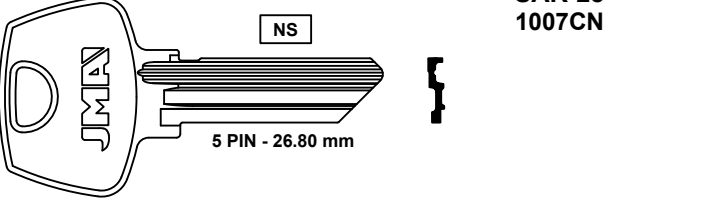
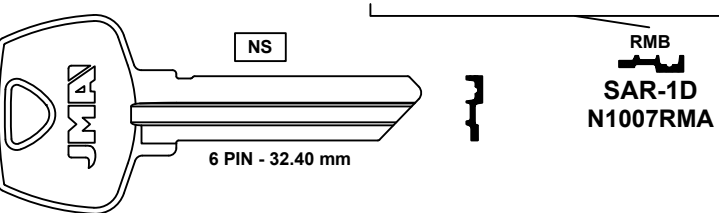
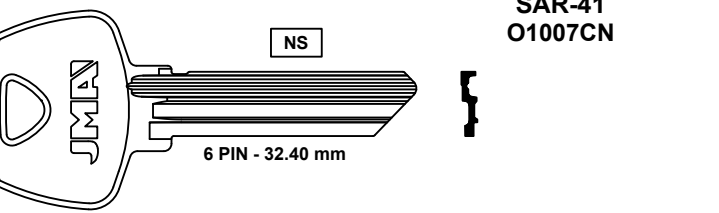
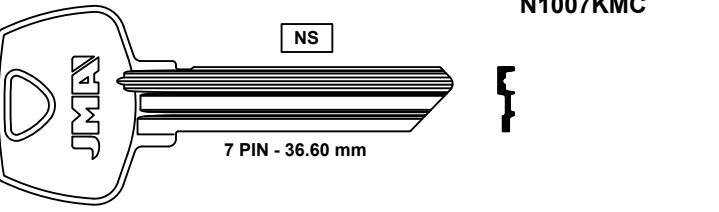
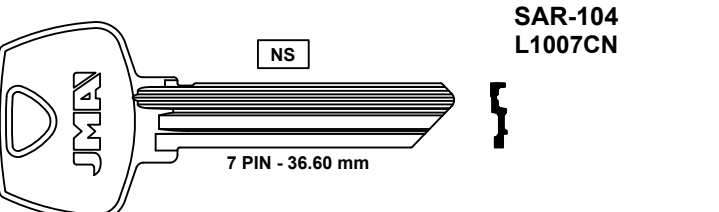

Z ZAMAK	FOR: SARGENT®										Z ZAMAK		
	LA SAR-7 S22	LB SAR-11 O1007LB	LC SAR-12 O1007LC	LE SAR-82 O1007LE	LF SAR-83 O1007LF	LG SAR-84 O1007LG	LJ SAR-13 O1007LJ	LK SAR-85 O1007LK	LL SAR-86 O1007LL				
	LD SAR-87 O1007LD			LH SAR-88 O1007LH				LM SAR-89 O1007LM					
	LDH SAR-90 O1007LDH					LHM SAR-91 O1007LHM							
NS	 <p>NS SAR-1 N1007KMA 6 PIN - 32.40 mm</p>										S		
NS N.SILVER / ALPACA STEEL / ACERO	FOR: SARGENT®										NS N.SILVER / ALPACA STEEL / ACERO		
	CA SAR-16 1007CA	CB SAR-17 1007CB	CC SAR-18 1007CC	CE SAR-19 1007CE	CF SAR-20 1007CF	CG SAR-21 1007CG	CJ SAR-22 1007CJ	CK SAR-23 1007CK	CL SAR-24 1007CL				
	CD SAR-25 1007CD			CH SAR-26 1007CH				CM SAR-27 1007CM					
	CN SAR-28 1007CN												
NS	 <p>NS SAR-28 1007CN 5 PIN - 26.80 mm</p>										S		
NE NEON	FOR: SARGENT®										NE NEON		
	RA SAR-7D O1007RA	RB SAR-11D O1007RB	RC SAR-12D O1007RC	RE SAR-82D O1007RE	RF SAR-83D O1007RF	RG SAR-84D O1007RG	RJ SAR-13D O1007RJ	RK SAR-85D O1007RK	RL SAR-86D O1007RL				
	RD SAR-87D O1007RD			RH SAR-88D O1007RH				RM SAR-89D O1007RM					
	RDH SAR-90D O1007RDH					RHM SAR-91D O1007RHM							
NE NICKEL PLATED / LATON NIQUELADO	 <p>NS SAR-1D N1007RMA 6 PIN - 32.40 mm</p>										S		
NP NICKEL PLATED / LATON NIQUELADO	FOR: SARGENT®										NP NICKEL PLATED / LATON NIQUELADO		
	CA SAR-29 O1007CA	CB SAR-30 O1007CB	CC SAR-31 O1007CC	CE SAR-32 O1007CE	CF SAR-33 O1007CF	CG SAR-34 O1007CG	CJ SAR-35 O1007CJ	CK SAR-36 O1007CK	CL SAR-37 O1007CL				
	CD SAR-38 O1007CD			CH SAR-39 O1007CH				CM SAR-40 O1007CM					
	CN SAR-41 O1007CN												
NE NEON	 <p>NS SAR-41 O1007CN 6 PIN - 32.40 mm</p>										S		
CM FUN COLOR	FOR: SARGENT®										CM FUN COLOR		
	LA SAR-105 L1007LA	LB SAR-106 L1007LB	LC SAR-107 L1007LC	LE SAR-108 L1007LE	LF SAR-109 L1007LF	LG SAR-110 L1007LG	LJ SAR-111 L1007LJ	LK SAR-112 L1007LK	LL SAR-113 L1007LL				
	LD SAR-114 L1007LD			LH SAR-115 L1007LH				LM SAR-116 L1007LM					
	KMC SAR-117 N1007KMC												
CK CRISTAL KEYS / PLASTICO COLOR	 <p>NS SAR-117 N1007KMC 7 PIN - 36.60 mm</p>										S		
A ALUMINIUM / ALUMINIO	FOR: SARGENT®										A ALUMINIUM / ALUMINIO		
	CA SAR-92 L1007CA	CB SAR-93 L1007CB	CC SAR-94 L1007CC	CE SAR-95 L1007CE	CF SAR-96 L1007CF	CG SAR-97 L1007CG	CJ SAR-98 L1007CJ	CK SAR-99 L1007CK	CL SAR-100 L1007CL				
	CD SAR-101 L1007CD			CH SAR-102 L1007CH				CM SAR-103 L1007CM					
	CN SAR-104 L1007CN												
B BRASS / LATON	 <p>NS SAR-104 L1007CN 7 PIN - 36.60 mm</p>										S		

Concerning the marks and commercial denominations see note in index.

Concerniente a las marcas y denominaciones comerciales ver nota en indice.

Concernant les marques et denominations commerciales voir la note dans l'index.



Concerning the marks and commercial denominations see note in index.

Concerniente a las marcas y denominaciones comerciales ver nota en indice.

Concernant les marques et denominations commerciales voir la note dans l'index.



Z ZAMAK	NS N. SILVER / ALPACA S STEEL / ACERO	FOR: SCHLAGE®	
NE NEON NP NICKEL PLATED / LATON NIQUELADO	NS N. SILVER / ALPACA S STEEL / ACERO	FOR: SCHLAGE®	
GM FUN COLOR CK CRISTAL KEYS / PLASTICO COLOR	NS N. SILVER / ALPACA S STEEL / ACERO	FOR: SCHLAGE®	FOR: SCHLENC TENDAHL®

FOR: SCOLTA®		FOR: SCOVILL®	
FOR: SCOVILL®		FOR: SECURITAL®	FOR: SEGAL®
FOR: SELECT®		FOR: SENTRY SAFE®	



Concerning the marks and commercial denominations see note in index.

Concerniente a las marcas y denominaciones comerciales ver nota en índice.

Concernant les marques et dénominations commerciales voir la note dans l'index.











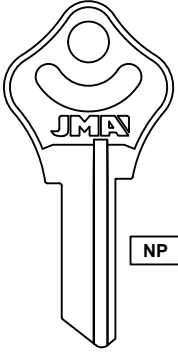
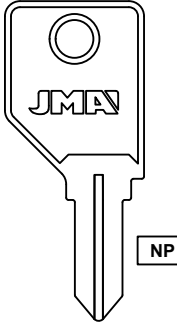
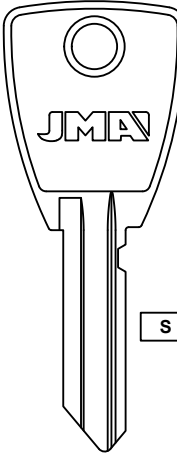
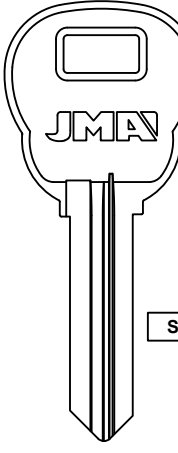
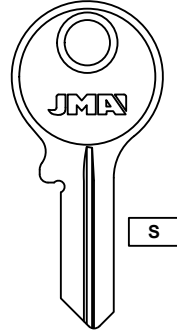
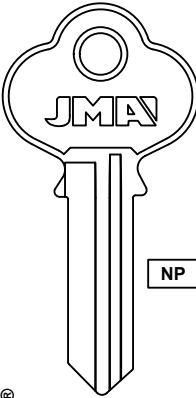
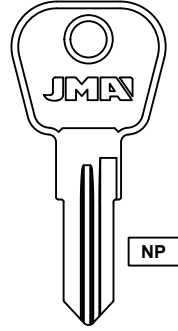
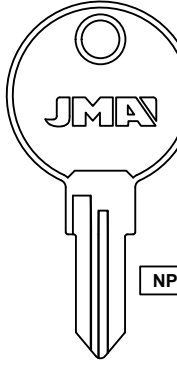
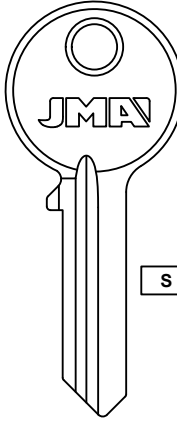
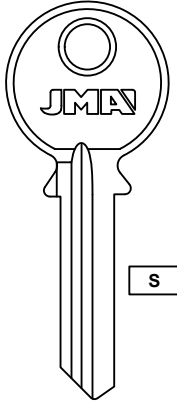
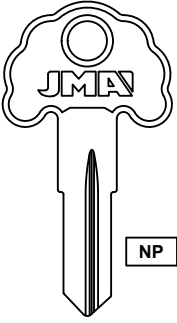
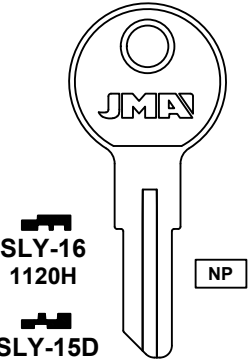
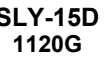
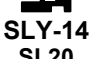
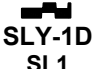

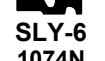
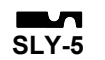

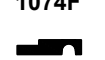

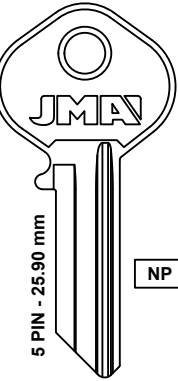

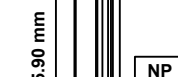
Concerning the marks and commercial denominations see note in index.

Concerniente a las marcas y denominaciones comerciales ver nota en índice.

Concernant les marques et dénominations commerciales voir la note dans l'index.

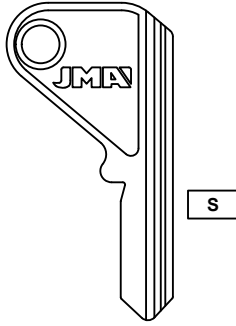
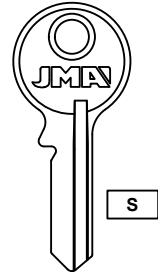
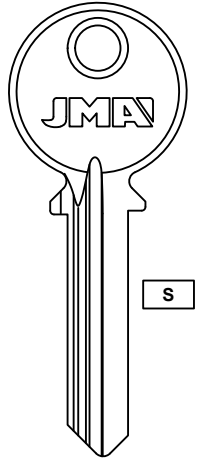
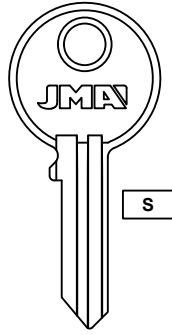
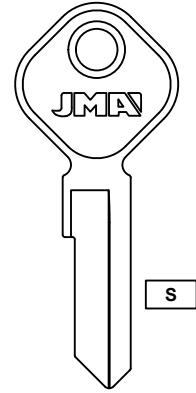
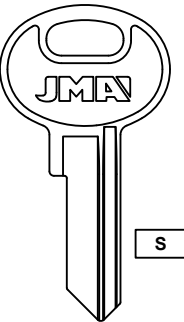
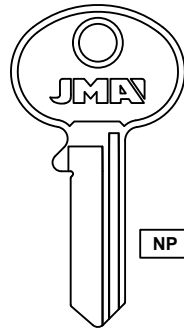

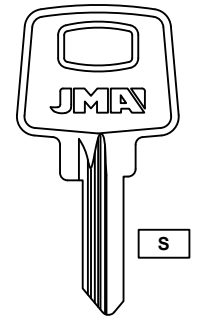
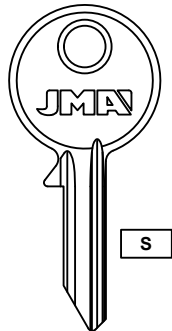
Z ZAMAK NS N.SILVER / ALPACA S STEEL / ACERO	FOR: SHANGAI®  SHA-1	FOR: SHAW WALKER®  SWL-1 1568	FOR: SIMECA®  SM-1 SIM10	 SM-3D SIM9R	FOR: SIS®  SIS-2 1523											
	FOR: SKILMAN®  SKI-1D SK1	FOR: SLAYMAKER®														
	FOR: SOPRANO®  SOP-6	 SOP-7D	 SOS-1D SOS91	 SOS-2D SOS1	FOR: SOUTHERN IMPERIAL®  SOU-1D 1624											
NE NEON NP NICKEL PLATED / LATON NIQUELADO CM FUN COLOR CK CRISTAL KEYS / PLASTICO COLOR A ALUMINUM / ALUMINIO B BRASS / LATON	FOR: CORBIN®  SLY-16 1120H	 SLY-15D 1120G	 SLY-14 SL20	 SLY-1D SL1	 SLY-7D 1074B	 SLY-6 1074N	 SLY-5 1074G	 SLY-4D 1074F	 SLY-3 1074E	 SLY-2 S1073DF	 SLY-13D 1074BM	 SLY-12D A1074B	 SLY-11 A1074G	 SLY-10D A1074F	 SLY-9 A1074E	 SLY-8 1073DF

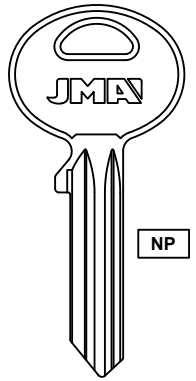
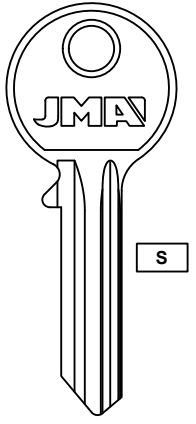
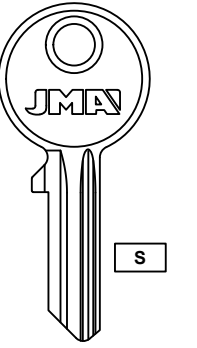
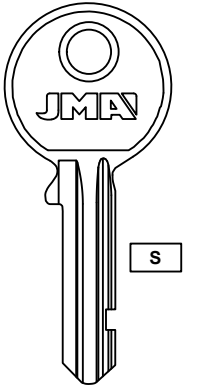
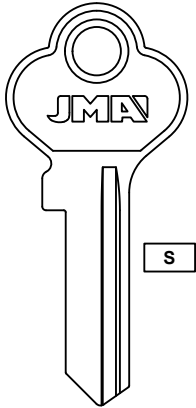
FOR: SQUIRE®  SQ-2 SQ3	 SQ-7 192B	FOR: STA-LOCK®  STL-1D STA1	 STL-2I STA2	FOR: STAR®  STA-1D
FOR: STAR®  STA-2	 STA-6	 STA-6D	FOR: STS®  STS-4D	FOR: STUV®  STUV-3 SV3
 STUV-11 ST91V	 STUV-1D ST91F	FOR: SUN®  SUN-1 1636	FOR: SUREX®  SR-11 SU9L	 SR-2 SX1
 SR-4 SX3	FOR: TAYLOR®  TAY-1			

Concerning the marks and commercial denominations see note in index.

Concerniente a las marcas y denominaciones comerciales ver nota en indice.

Concernant les marques et denominations commerciales voir la note dans l'index.











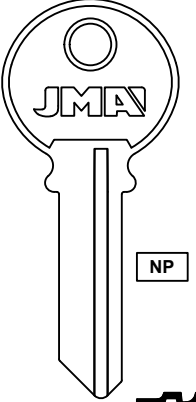
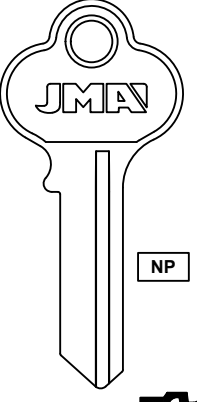
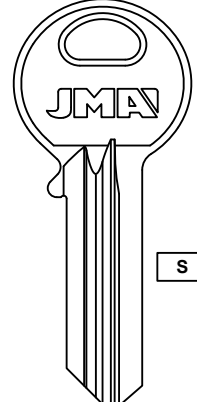
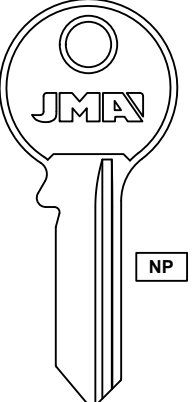
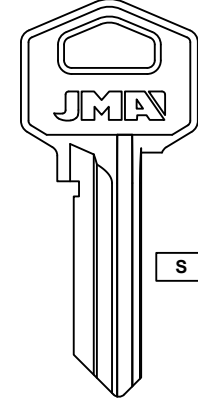
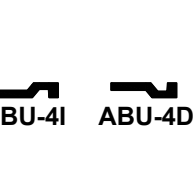
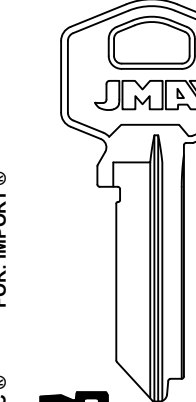
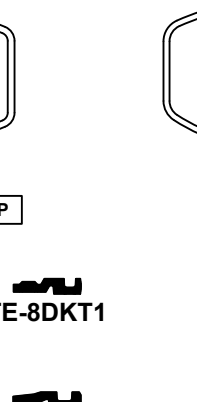

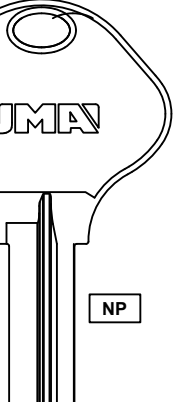
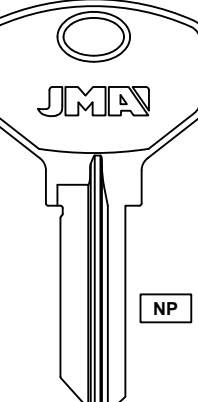
Concerning the marks and commercial denominations see note in index.

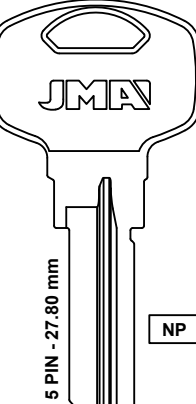
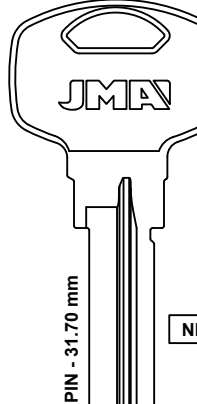
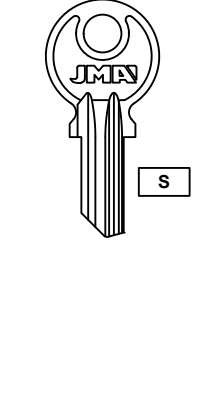
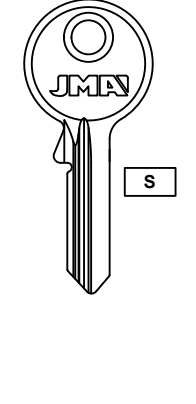
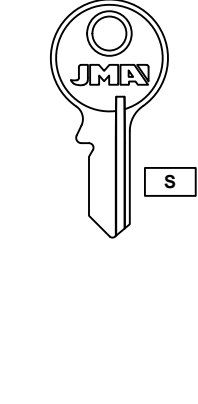
Concerniente a las marcas y denominaciones comerciales ver nota en indice.

Concernant les marques et denominations commerciales voir la note dans l'index.

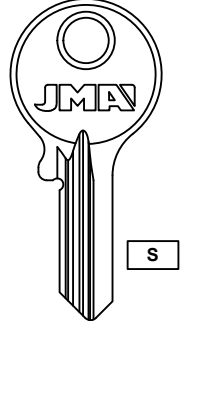
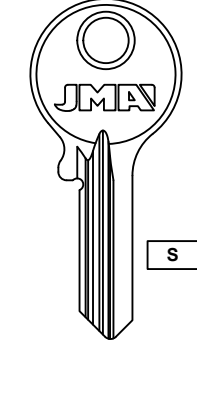
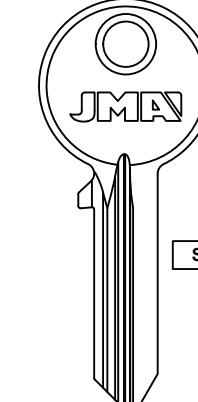
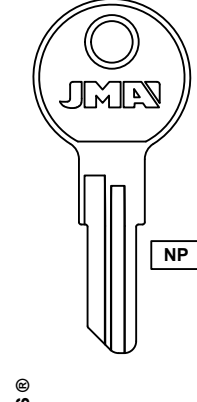
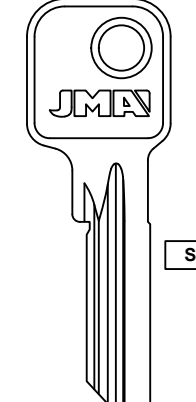
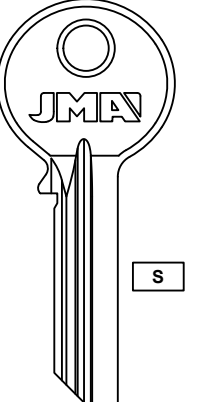

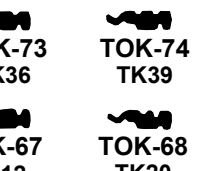
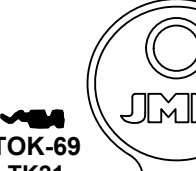
Z ZAMAK	NS N.SILVER / ALPACA S STEEL / ACERO	FOR: TAYLOR®		FOR: TEKA®		FOR: TESA®	
		 NP TAY-5D T1	 NP TAY-4D 1141GS	 S TK-2D TEK1	 NP ABU-4I	 S ABU-4D	 NP TE-1I TE1
NE NEON NP NICKEL PLATED / LATON NIQUELADO	CM FUN COLOR CK CRISTAL KEYS / PLASTICO COLOR	FOR: TESA®					
		 FOR: HARLOC® NP TE-8I TE4	 FOR: IMPORT® NP TE-8DKT1	 FOR: HARLOC® NP TE-8D	 FOR: YALE® NP TE-7D HR2	 FOR: YALE® NP TE-11D Y222	 FOR: YALE® NP TE-15D Y223
A ALUMINUM / ALUMINIO B BRASS / LATON	CM FUN COLOR CK CRISTAL KEYS / PLASTICO COLOR	FOR: TESA®		FOR: TICINO®		FOR: TIFON®	
		 FOR: YALE® NP 5 PIN - 27.80 mm TE-29D	 FOR: YALE® NP 6 PIN - 31.70 mm TE-30D	 S TI-1	 S TI-1D	 FOR: IFAM® S TIF-1D	 FOR: IFAM® S TIF-15/20

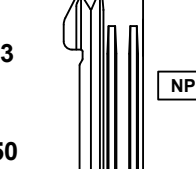
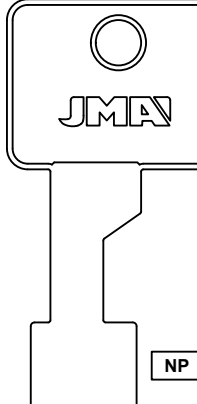
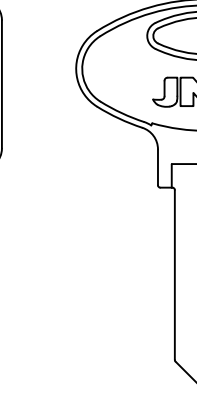
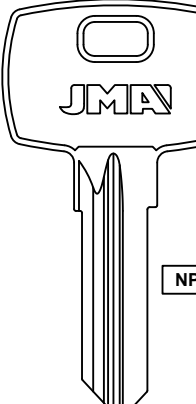
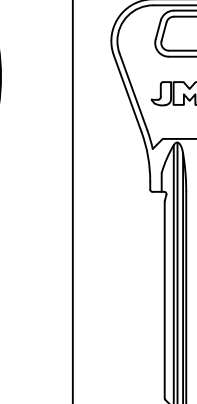
Z ZAMAK	NS N.SILVER / ALPACA S STEEL / ACERO	FOR: TIFON®			FOR: TIMBERLINE®		FOR: TOK WINKHAUS®	
		 FOR: IFAM® S TIF-30D	 FOR: IFAM® S TIF-40D	 FOR: IFAM® S TIF-50/60	 FOR: ILLINOIS® NP TIM-1D IL11	 S TOK-4D TK41		
NE NEON NP NICKEL PLATED / LATON NIQUELADO	CM FUN COLOR CK CRISTAL KEYS / PLASTICO COLOR	FOR: TOK WINKHAUS®						
		 S TOK-5D TO91	 TOK-70 TK25	 TOK-71 TK29	 TOK-72 TK34	 TOK-73 TK36	 TOK-74 TK39	 TOK-69 TK21
A ALUMINUM / ALUMINIO B BRASS / LATON	CM FUN COLOR CK CRISTAL KEYS / PLASTICO COLOR	FOR: TOVER®		FOR: TRAVEX®				
		 NP TOV-1	 NP TOV-3	 NP TRV-1	 NP TRV-1D			

Concerning the marks and commercial denominations see note in index.

Concerniente a las marcas y denominaciones comerciales ver nota en indice.

Concernant les marques et denominations commerciales voir la note dans l'index.











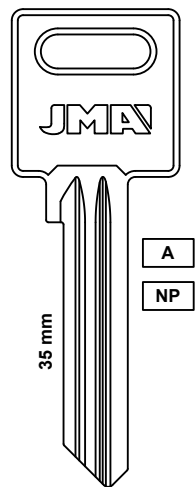
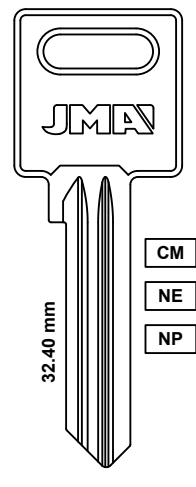

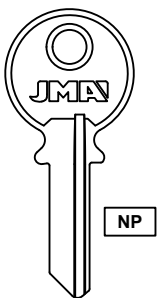
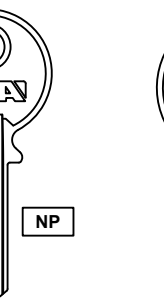

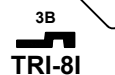





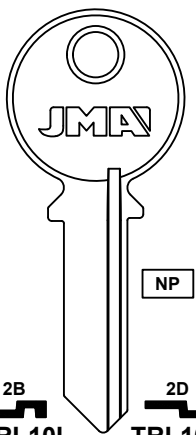

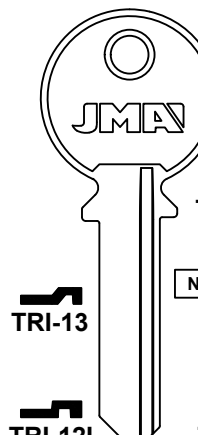



















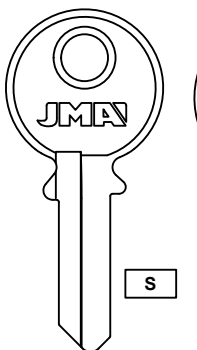
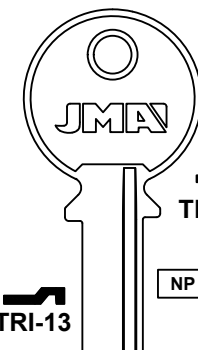

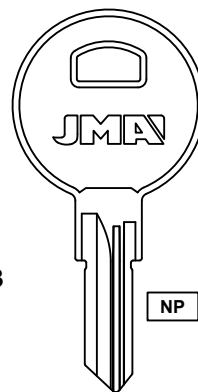









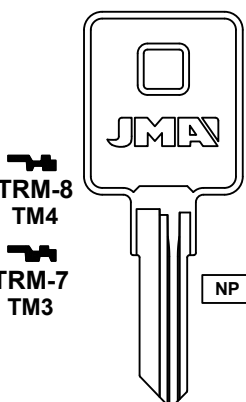
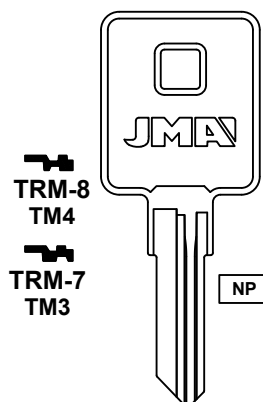
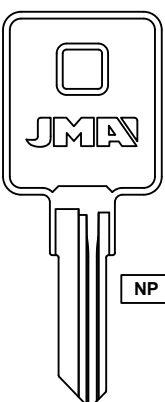





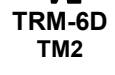

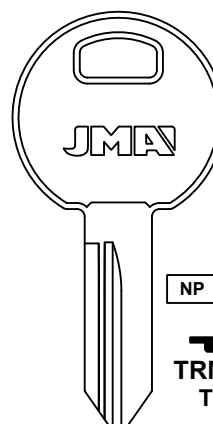
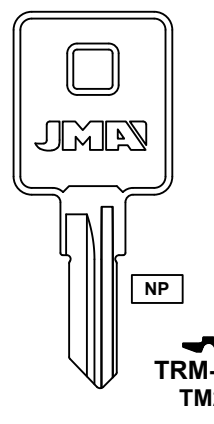





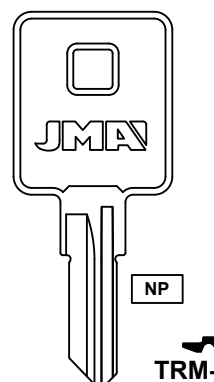



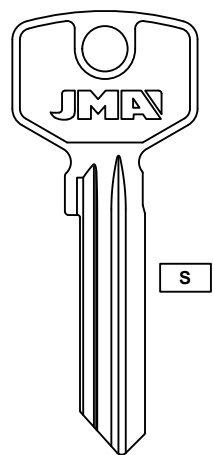
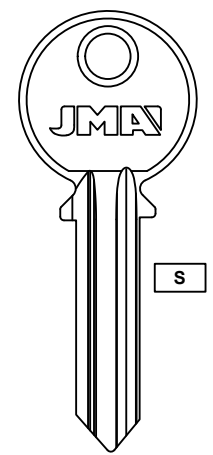
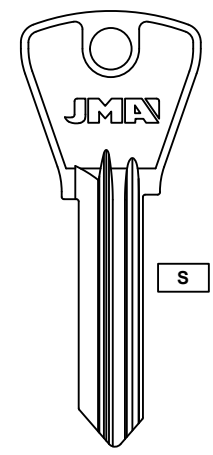
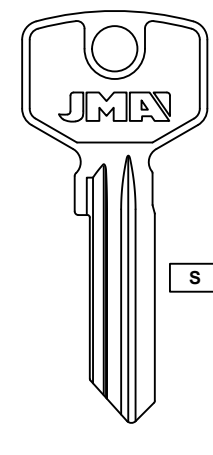



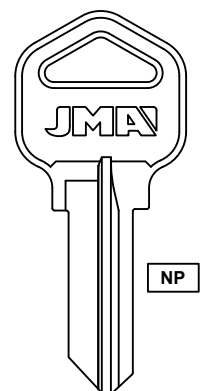

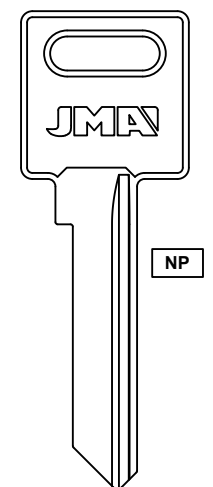
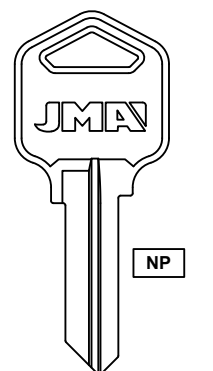
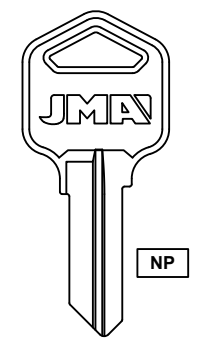

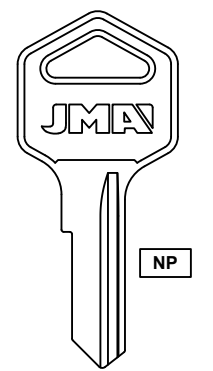
Concerning the marks and commercial denominations see note in index.

Concerniente a las marcas y denominaciones comerciales ver nota en indice.

Concernant les marques et denominations commerciales voir la note dans l'index.

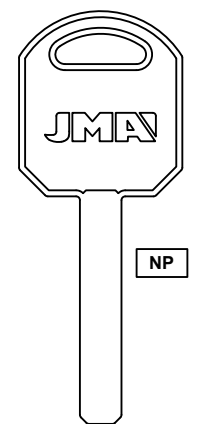

Z ZAMAK NS N. SILVER / ALPACA S STEEL / ACERO NE NEON NP NICKEL PLATED / LATON NIQUELADO CM FUN COLOR CK CRISTAL KEYS / PLASTICO COLOR A ALUMINUM / ALUMINIO B BRASS / LATON	FOR: TRAVEX®  35 mm A NP  32.40 mm CM NE NP  TRV-2D  TRV-3D	FOR: TRI CIRCLE®  NP  NP  TRI-6I  TRI-6D  TRI-8I  TRI-8D  TRI-5I  TRI-5D  TRI-7I  TRI-7D	
	FOR: TRI CIRCLE®  NP  NP  NP  NP  TRI-11I  TRI-11D  TRI-17D  TRI-18  TRI-18D  TRI-19  TRI-19D  TRI-10I  TRI-10D  TRI-12I  TRI-12D  TRI-11I  TRI-11D  TRI-17D  TRI-18  TRI-18D  TRI-19  TRI-19D	FOR: TRI CIRCLE®  NP  NP  TRI-24D  TRI-13	FOR: TRIMARK®  NP  TRM-4  TRM-7  TRM-13  TRM-16  TRM-4  TRM-7  TRM-3D  TRM-1  TRM-3D  TRM-1
	FOR: TRIMARK®  NP  NP  NP  TRM-6D  TRM-5D  TRM-2D  TRM-8  TRM-7  TRM-9D  TRM-6D  TRM-5D  TRM-2D	FOR: TRIMARK®  NP  NP  TRM-10D  TRM-12  TRM-15D  TRM-11D  TRM-10D  TRM-12	FOR: TRIMARK®  NP  NP  TRM-17D  TRM-16D
FOR: TRIO-VING®  S  S  S  S  TV-3D  TV-11  TV-12  TV-15D	FOR: TRUPER®  NP  TRU-1D		
FOR: TRUPER®  NP  NP  NP  NP  NP  TRU-2  TRU-3D  TRU-4D  TRU-11  TRU-6	FOR: TRUPER®  NP  TRU-7 2.90 mm		

Z ZAMAK
NS N. SILVER / ALPACA
S STEEL / ACERO
NE NEON
NP NICKEL PLATED / LATON NIQUELADO
CM FUN COLOR
CK CRISTAL KEYS / PLASTICO COLOR
A ALUMINUM / ALUMINIO
B BRASS / LATON



Concerning the marks and commercial denominations see note in index.

Concerniente a las marcas y denominaciones comerciales ver nota en índice.

Concernant les marques et dénominations commerciales voir la note dans l'index.



Concerning the marks and commercial denominations see note in index.

Concerniente a las marcas y denominaciones comerciales ver nota en índice.

Concernant les marques et dénominations commerciales voir la note dans l'index.











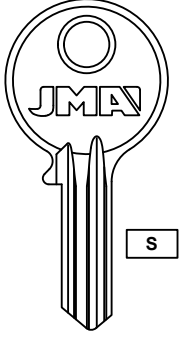
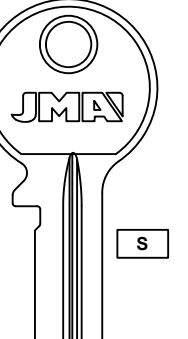
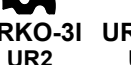
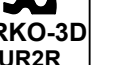
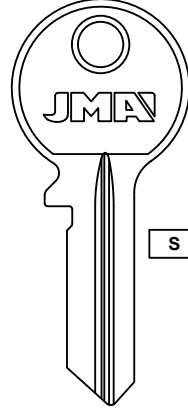
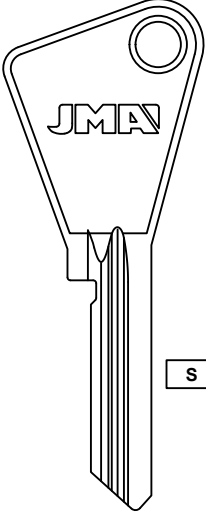
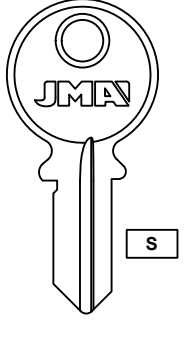
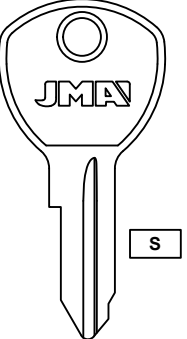

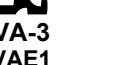

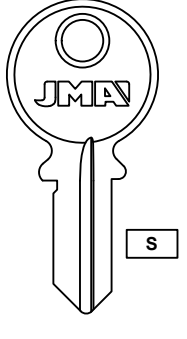
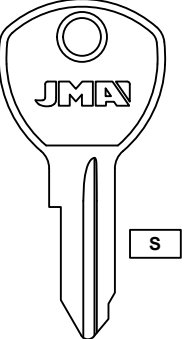
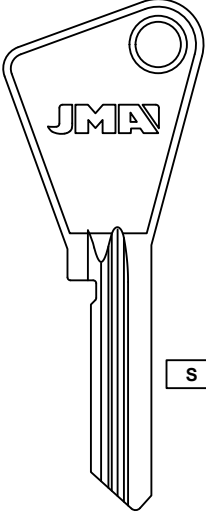

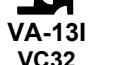

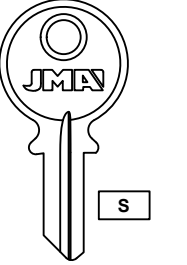
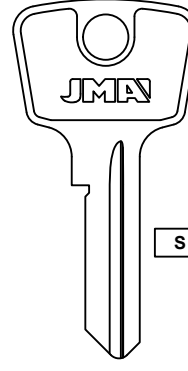
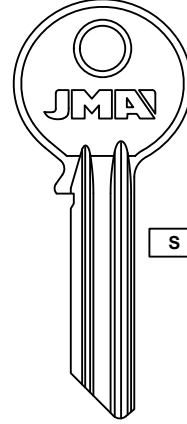
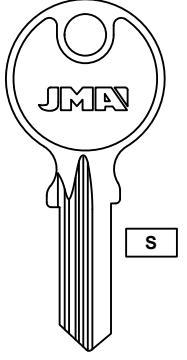
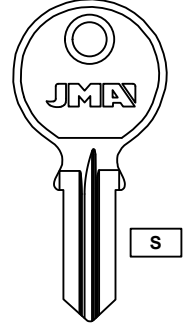
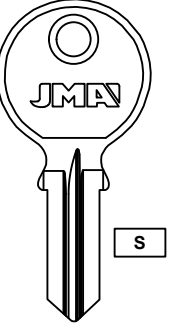

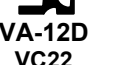



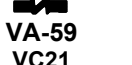
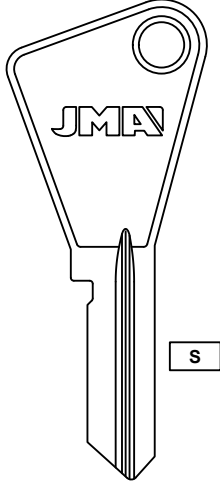
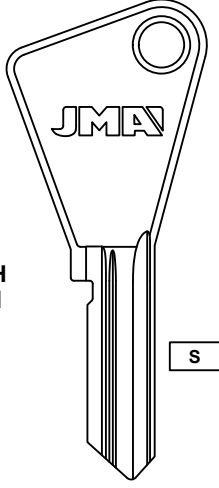



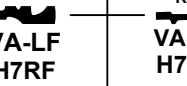

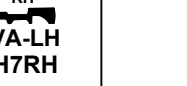

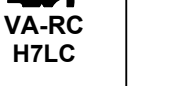
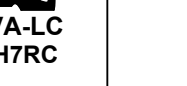
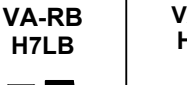
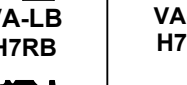
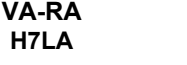
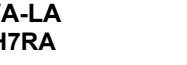
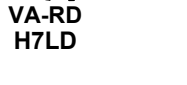
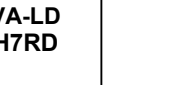
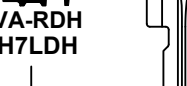

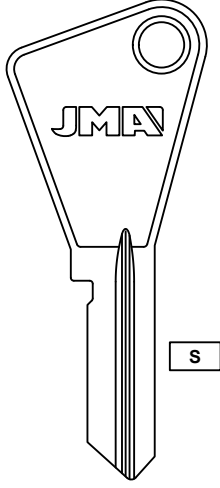

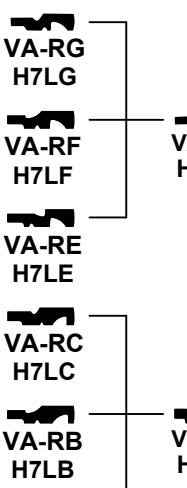
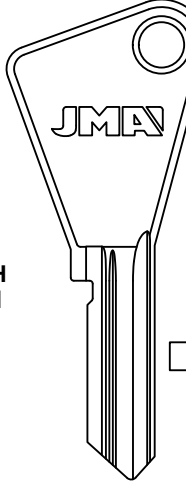

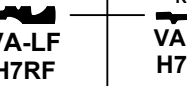

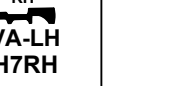

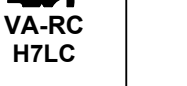
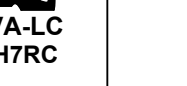
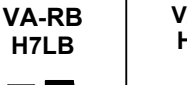
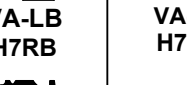
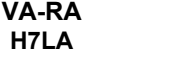
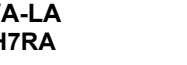
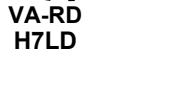
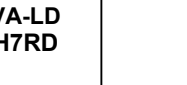
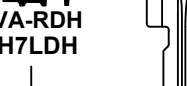

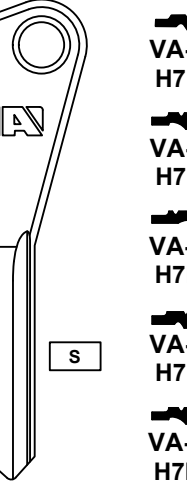
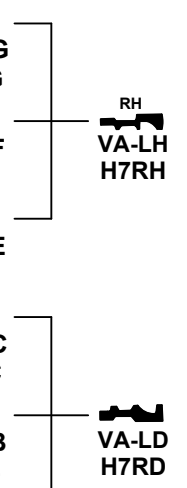
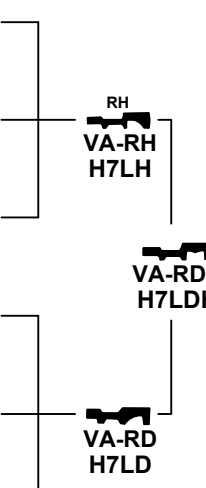

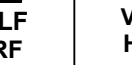
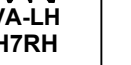
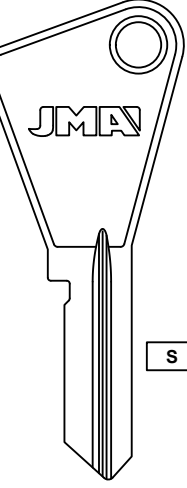
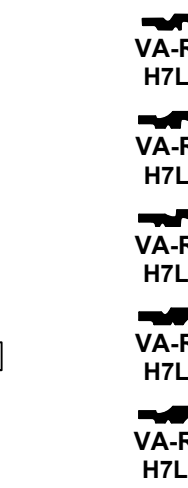
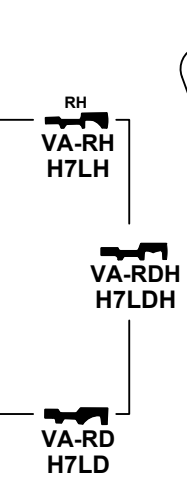
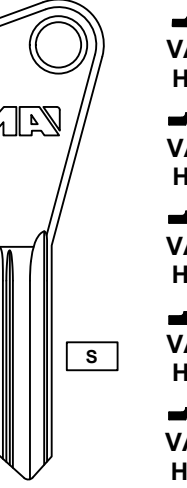
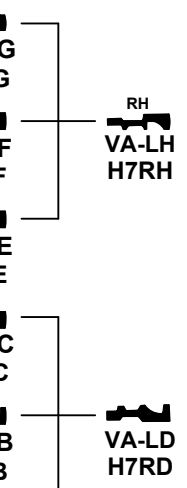
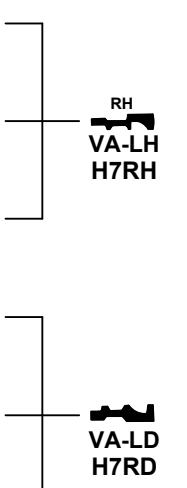





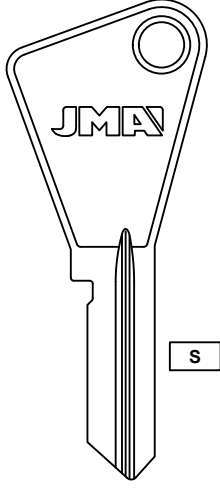
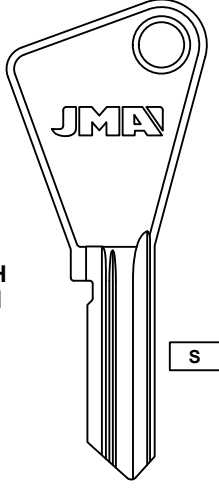

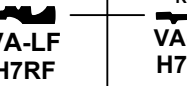

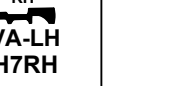

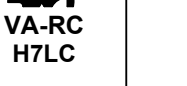
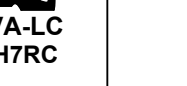
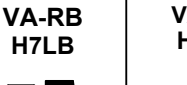
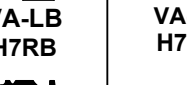
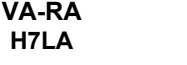
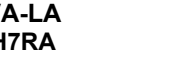
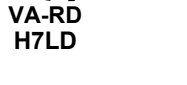
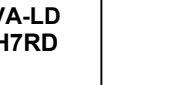
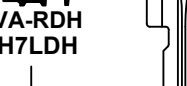

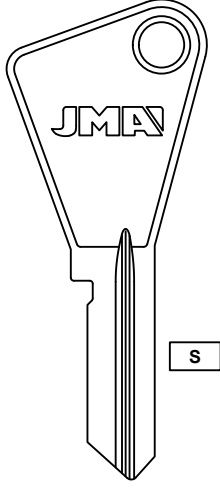

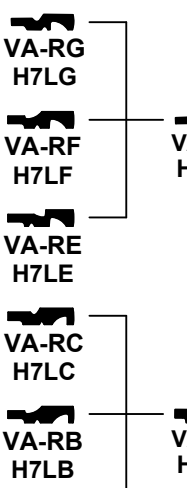
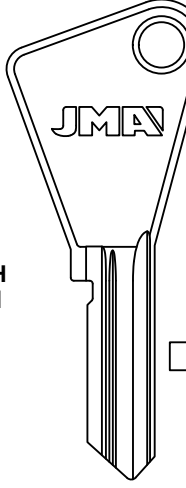

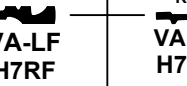

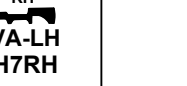

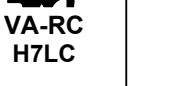
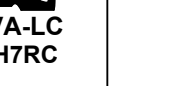
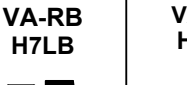
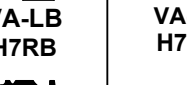
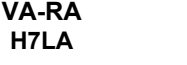
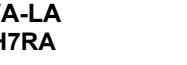
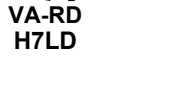
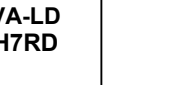
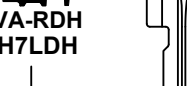

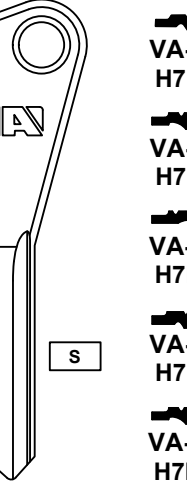
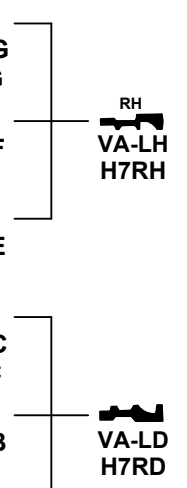
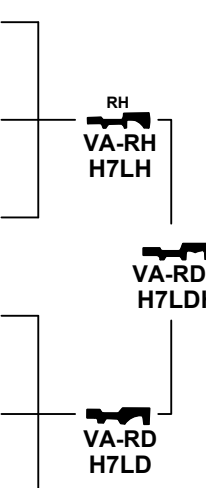

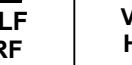
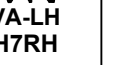
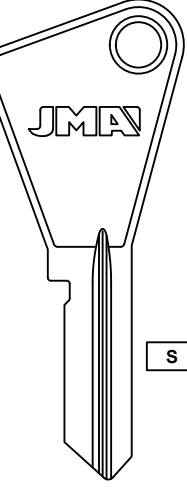
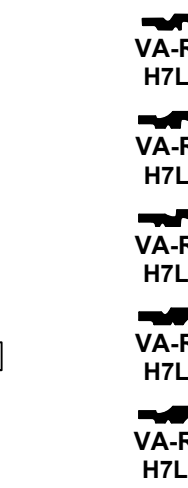
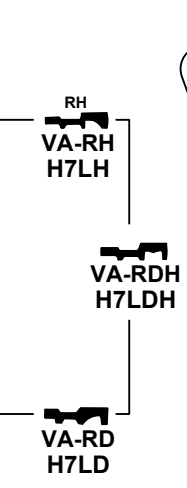
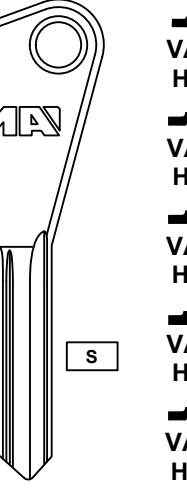
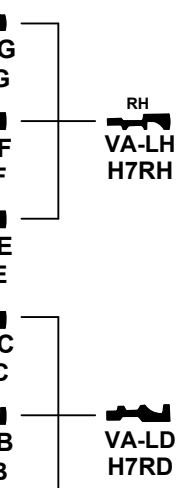
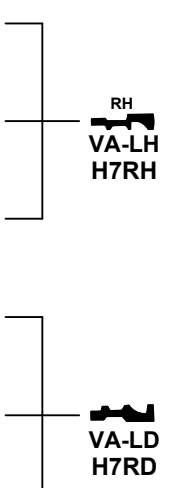





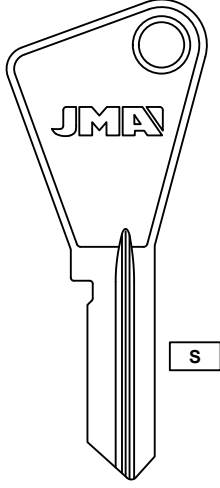
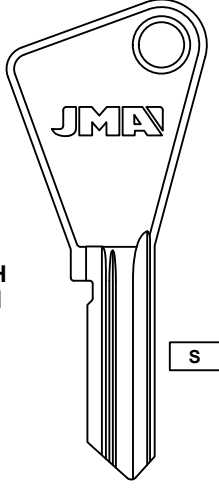

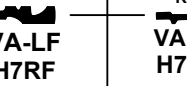

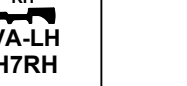

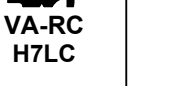
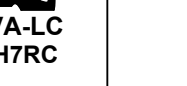
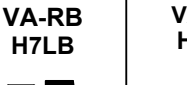
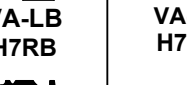
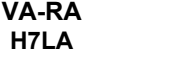
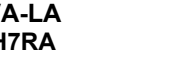
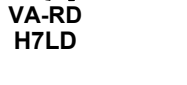
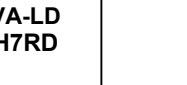
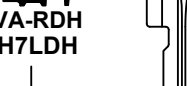

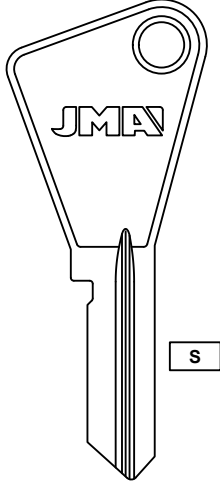

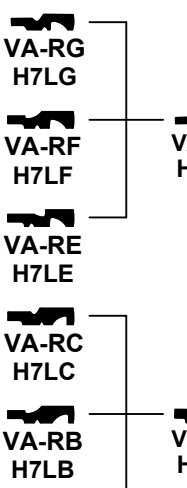
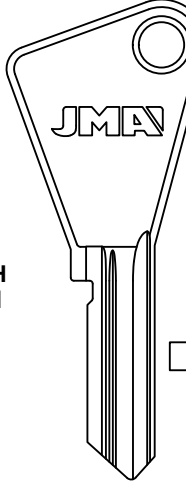

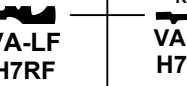

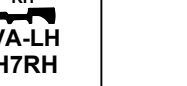

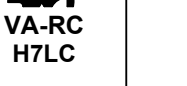
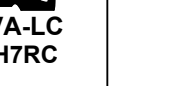
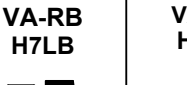
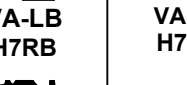
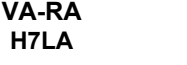
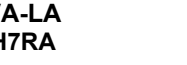
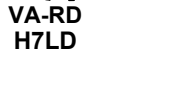
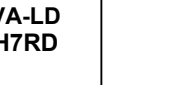
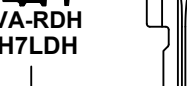

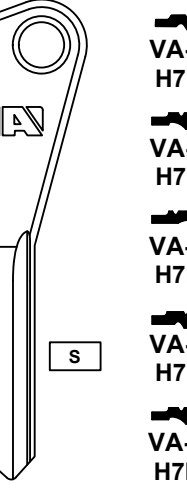
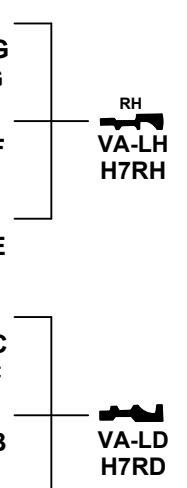
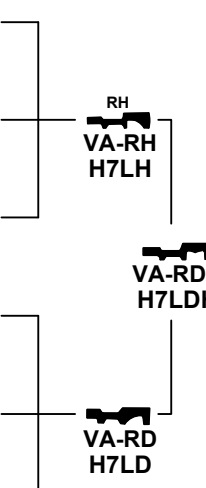

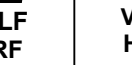
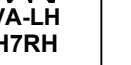
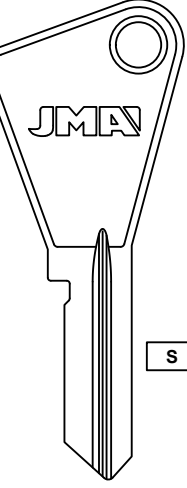
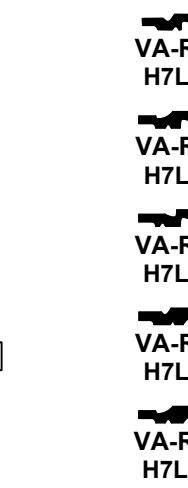
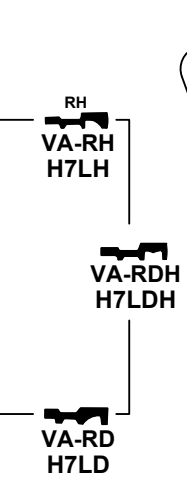
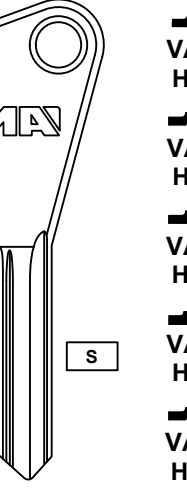
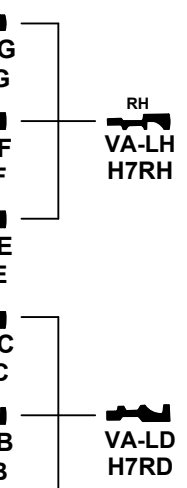
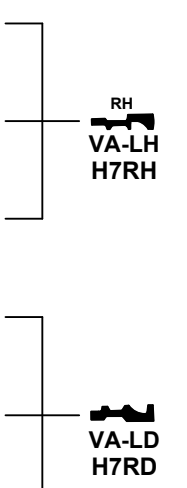





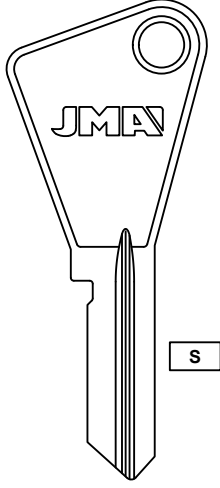
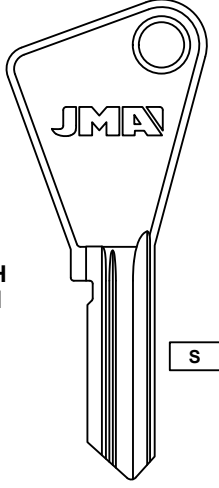

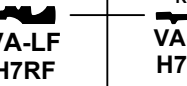

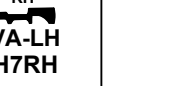

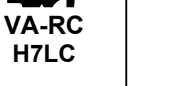
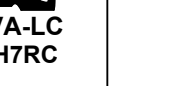
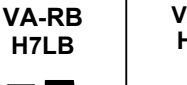
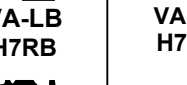
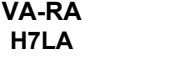
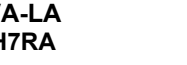
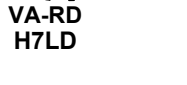
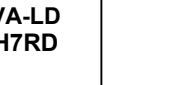
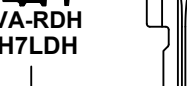

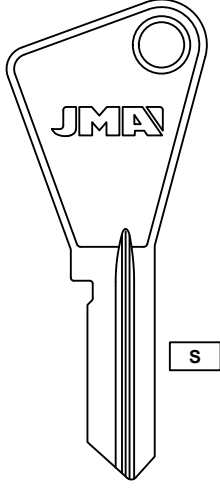

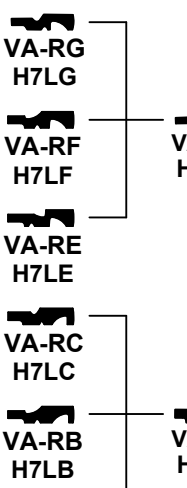
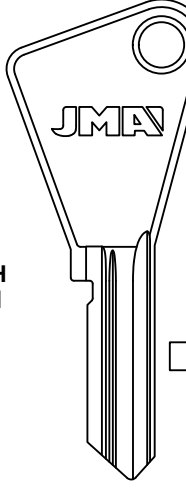

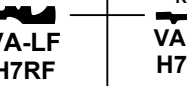

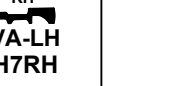

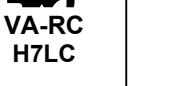
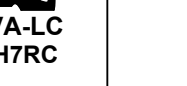
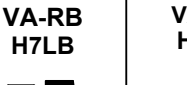
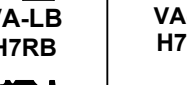
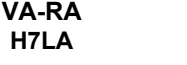
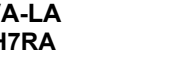
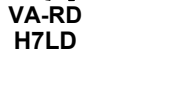
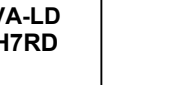
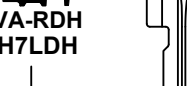

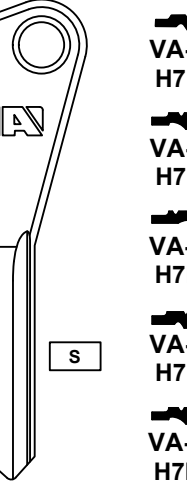
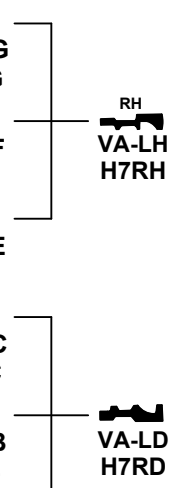
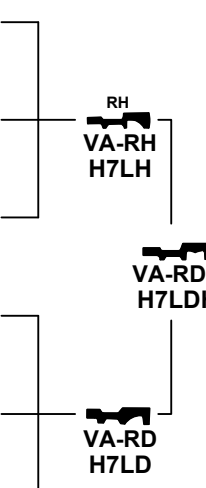

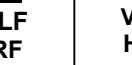
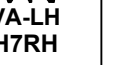
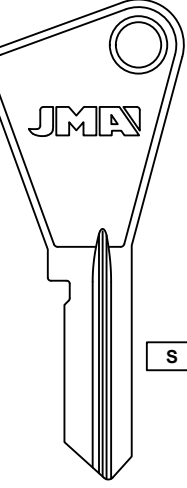
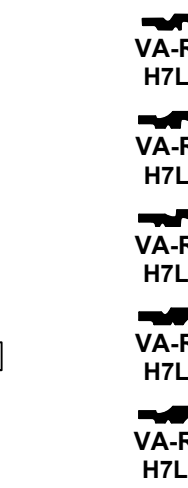
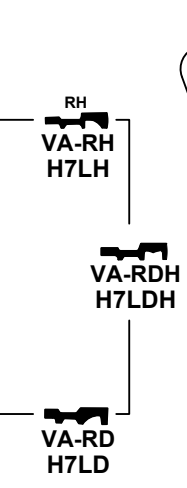
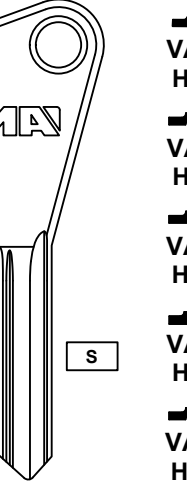
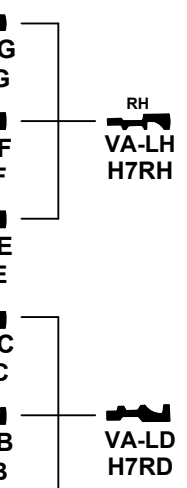
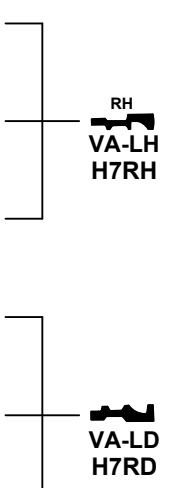





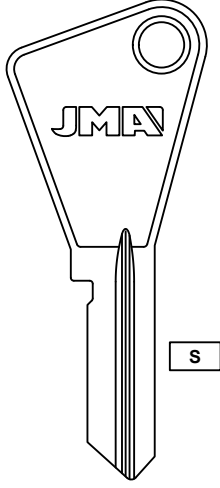
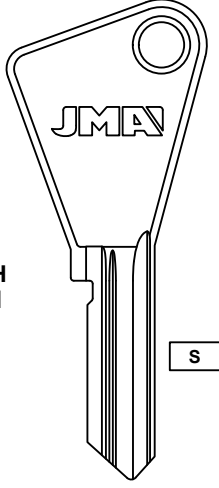

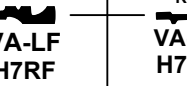

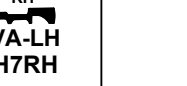

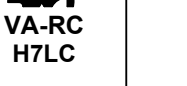
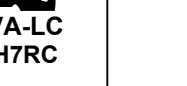
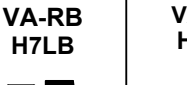
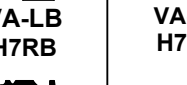
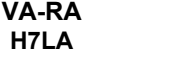
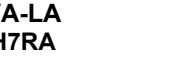
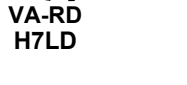
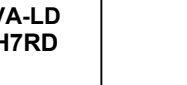
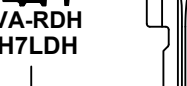

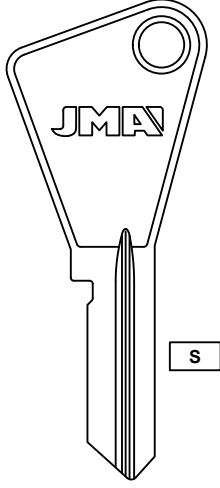

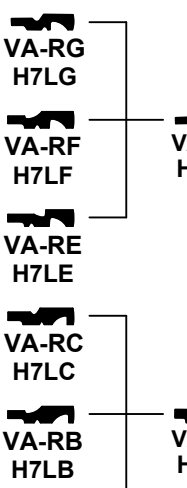
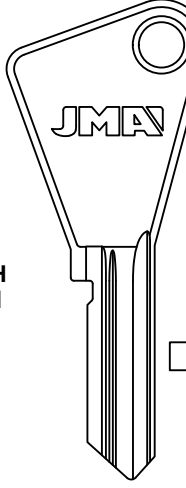

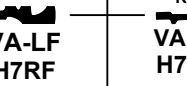

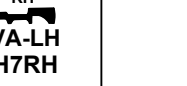

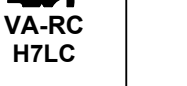
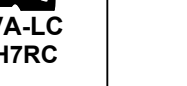
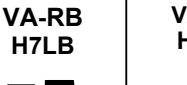
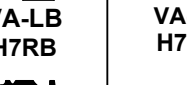
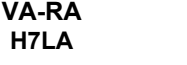
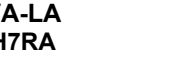
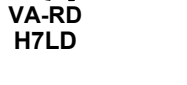
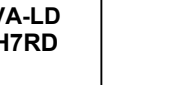
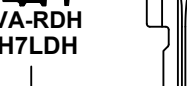

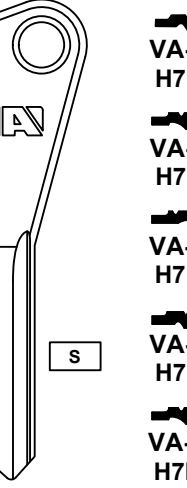
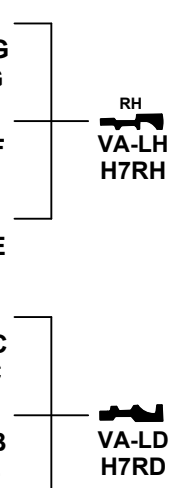
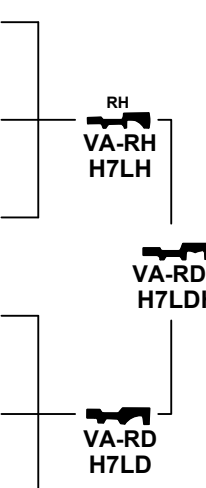
Z ZAMAK	NS N. SILVER / ALPACA S STEEL / ACERO	FOR: TRUPER®			FOR: UCEM®	FOR: UNION®	
		TRU-8.P	TRU-9D	TRU-10.P	UCEM-12	UN-1FS 62DS	
NE NEON NP NICKEL PLATED / LATON NIQUELADO	CM FUN COLOR CK CRISTAL KEYS / PLASTICO COLOR	FOR: UNION®					
		UN-5D UN5	UN-6D U180G	UN-11 1033N	UN-13I UN80	UN-14I UN81	UN-17I UN83
A ALUMINIUM / ALUMINIO B BRASS / LATON	CM FUN COLOR CK CRISTAL KEYS / PLASTICO COLOR	FOR: UNION®					
		UN-19D UN51	UN-20D UN52	UN-21D UN50	UN-22D UN58	UN-23D UN53	UN-25D UN57
A ALUMINIUM / ALUMINIO B BRASS / LATON	CM FUN COLOR CK CRISTAL KEYS / PLASTICO COLOR	FOR: UNION®					
		UN-27D UN59	UN-25D UN57	UN-23D UN53	UN-21D UN50	UN-19D UN51	UN-17I UN83

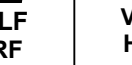
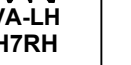
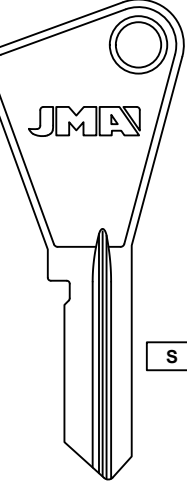
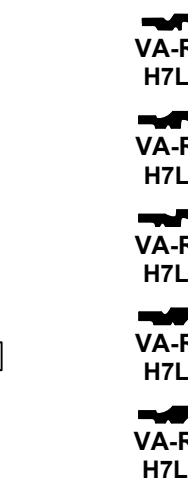
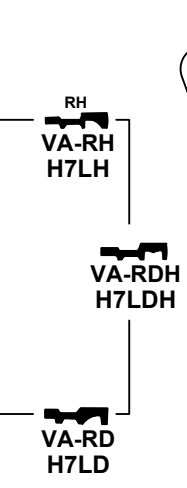
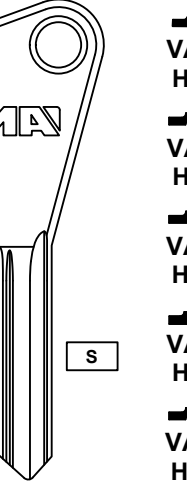
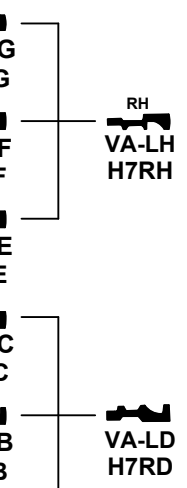
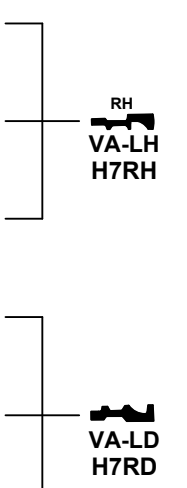
Z ZAMAK	NS N. SILVER / ALPACA S STEEL / ACERO	FOR: UNION®			FOR: UNIVERSAL®		
		UN-43D UN57L	UN-41D UN59L	UN-39D UN53L	UN-37D UN50L	UN-35D UN51L	UN-42D UN56L
NE NEON NP NICKEL PLATED / LATON NIQUELADO	CM FUN COLOR CK CRISTAL KEYS / PLASTICO COLOR	FOR: UNIVERSAL®					
		TX-6	TX-7	TX-8	TX-9	TX-10	TX-11
A ALUMINIUM / ALUMINIO B BRASS / LATON	CM FUN COLOR CK CRISTAL KEYS / PLASTICO COLOR	FOR: UNIVERSAL®			FOR: URKO®		
		U-28YD	U-29D	U-30D	URKO-11 UR1	URKO-1D UR1R	URKO-1D UR1R

Concerning the marks and commercial denominations see note in index.
Concerniente a las marcas y denominaciones comerciales ver nota en indice.
Concernant les marques et denominations commerciales voir la note dans l'index.

Concerning the marks and commercial denominations see note in index.
Concerniente a las marcas y denominaciones comerciales ver nota en indice.
Concernant les marques et denominations commerciales voir la note dans l'index.

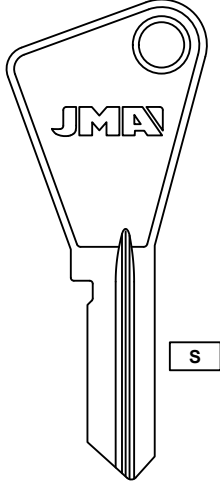
<p>Z ZAMAK</p> <p>NS N. SILVER / ALPACA</p> <p>S STEEL / ACERO</p> <p>NE NEON</p> <p>NP NICKEL PLATED / LATON NIQUELADO</p> <p>FUN COLOR</p> <p>CM CRISTAL KEYS / PLASTICO COLOR</p> <p>ALUMINUM / ALUMINIO</p> <p>B BRASS / LATON</p>	<p>FOR: URKO®</p>  <p>S</p>  <p>S</p>  <p>URKO-3I UR2</p>  <p>URKO-3D UR2R</p>	<p>FOR: VACHETTE®</p>  <p>S</p>  <p>S</p>  <p>S</p>  <p>S</p>  <p>VA-1 V91N</p>  <p>VA-2 H62KB</p>  <p>VA-3 VAE1</p>  <p>VA-4D VC34</p>	<p>FOR: VACHETTE®</p>  <p>S</p>  <p>S</p>  <p>S</p>  <p>VA-5 VAT1</p>  <p>VA-13I VC32</p>  <p>VA-13D VC33</p>	<p>FOR: VACHETTE®</p>  <p>S</p>  <p>S</p>  <p>S</p>  <p>S</p>  <p>S</p>  <p>S</p>  <p>VA-9D V1S</p>  <p>VA-12D VC22</p>  <p>VA-24I VCA1R</p>  <p>VA-24D VCA1</p>  <p>VA-33D V91E</p>  <p>VA-59 VC21</p>	<p>FOR: VACHETTE®</p>  <p>S</p>  <p>S</p>  <p>VA-RG H7LG</p>  <p>VA-LG H7RG</p>                	<p>FOR: VACHETTE®</p>  <p>S</p>  <p>VA-8D H10F</p>	<p>FOR: VACHETTE®</p> 																							
																														
               	<p>FOR: VACHETTE®</p>     <p>VA-5 VAT1</p>  <p>VA-13I VC32</p>  <p>VA-13D VC33</p>	<p>FOR: VACHETTE®</p>        <p>VA-9D V1S</p>  <p>VA-12D VC22</p>  <p>VA-24I VCA1R</p>  <p>VA-24D VCA1</p>  <p>VA-33D V91E</p>  <p>VA-59 VC21</p>	<p>FOR: VACHETTE®</p>                  	<p>FOR: VACHETTE®</p>   <p>VA-8D H10F</p>	<p>FOR: VACHETTE®</p>  																									
																														
              	<p>FOR: VACHETTE®</p>     <p>VA-5 VAT1</p>  <p>VA-13I VC32</p>  <p>VA-13D VC33</p>	<p>FOR: VACHETTE®</p>        <p>VA-9D V1S</p>  <p>VA-12D VC22</p>  <p>VA-24I VCA1R</p>  <p>VA-24D VCA1</p>  <p>VA-33D V91E</p>  <p>VA-59 VC21</p>	<p>FOR: VACHETTE®</p>                  	<p>FOR: VACHETTE®</p>   <p>VA-8D H10F</p>	<p>FOR: VACHETTE®</p>   																									
																														
             	<p>FOR: VACHETTE®</p>     <p>VA-5 VAT1</p>  <p>VA-13I VC32</p>  <p>VA-13D VC33</p>	<p>FOR: VACHETTE®</p>        <p>VA-9D V1S</p>  <p>VA-12D VC22</p>  <p>VA-24I VCA1R</p>  <p>VA-24D VCA1</p>  <p>VA-33D V91E</p>  <p>VA-59 VC21</p>	<p>FOR: VACHETTE®</p>                  	<p>FOR: VACHETTE®</p>   <p>VA-8D H10F</p>	<p>FOR: VACHETTE®</p>    																									
																														
            	<p>FOR: VACHETTE®</p>     <p>VA-5 VAT1</p>  <p>VA-13I VC32</p>  <p>VA-13D VC33</p>	<p>FOR: VACHETTE®</p>        <p>VA-9D V1S</p>  <p>VA-12D VC22</p>  <p>VA-24I VCA1R</p>  <p>VA-24D VCA1</p>  <p>VA-33D V91E</p>  <p>VA-59 VC21</p>	<p>FOR: VACHETTE®</p>                  	<p>FOR: VACHETTE®</p>   <p>VA-8D H10F</p>	<p>FOR: VACHETTE®</p>     																									
																														
           	<p>FOR: VACHETTE®</p>     <p>VA-5 VAT1</p>  <p>VA-13I VC32</p>  <p>VA-13D VC33</p>	<p>FOR: VACHETTE®</p>        <p>VA-9D V1S</p>  <p>VA-12D VC22</p>  <p>VA-24I VCA1R</p>  <p>VA-24D VCA1</p>  <p>VA-33D V91E</p>  <p>VA-59 VC21</p>	<p>FOR: VACHETTE®</p> 																											
--	---	---	---	--	--	---	--	--	---	--	--	--	--	---	--	--	--	--	---	--	--	--	--	---	--	--	--	--	---	--

<p>CM ALUMINUM / ALUMINIO CK BRASS / LATON</p> <p>FUN COLOR CRISTAL KEYS / PLASTICO COLOR</p> <p>NE NEON NP NICKEL PLATED / LATON NIQUELADO</p> <p>NS N.SILVER / ALPACA S STEEL / ACERO</p> <p>Z ZAMAK</p>	FOR: WEISER®					FOR: WILSON BOHANNON®		FOR: WIND®	FOR: WINKHAUS®		
	 WEI-2 WR4					 WIB-4 1071M		 WND-1 WN1	 WIN-5		
	 WEI-3 WR5					 WIB-8 1071BM					
	 WEI-3C DNDWR3 / DNDWR5					 WIB-3 1071E					
	 WEI-4 FA1					 WIB-7 1071BE					
	 WEI-5 FA2					 WIB-2 1071D					
	FOR: WEISER®					FOR: WRIGHT PRODUCTS®		FOR: YALE®			
	 WEI-8					 WRI-1D WTP1		 U-1D			
	 WEI-11 L1054WB					 XL-1 XL7		 U-2D			
	 WEI-12					 U-3I					
	 WEI-17D WR2										
	 WEI-18D WR6										
FOR: WELCH®		FOR: WESLOCK®		FOR: WILKA®			FOR: YALE®				
 WLC-1D WE1		 WES-1D WK2		 WIL-1D W91C			 U-17D				
		 WES-3D WK1		 WIL-3D WK3			 YA-2D				
							 YA-11 H999R				
							 YA-1D H999				
							 YA-24I				

Concerning the marks and commercial denominations see note in index.

Concerniente a las marcas y denominaciones comerciales ver nota en indice.

Concernant les marques et denominations commerciales voir la note dans l'index.

Concerning the marks and commercial denominations see note in index.

Concerniente a las marcas y denominaciones comerciales ver nota en indice.

Concernant les marques et denominations commerciales voir la note dans l'index.

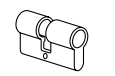
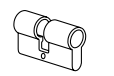

Z ZAMAK
NS N. SILVER / ALPACA
S STEEL / ACERO
NE NEON
NP NICKEL PLATED / LATON NIQUELADO
CM FUN COLOR
CK CRISTAL KEYS / PLASTICO COLOR
A ALUMINUM / ALUMINIO
B BRASS / LATON

Z ZAMAK
NS N. SILVER / ALPACA
S STEEL / ACERO
NE NEON
NP NICKEL PLATED / LATON NIQUELADO
CM FUN COLOR
CK CRISTAL KEYS / PLASTICO COLOR
A ALUMINUM / ALUMINIO
B BRASS / LATON

FOR: YALE®

 5 PIN - 27.40 mm A B CM NE NP YA-24D	FOR: CISA® FOR: AZBE® FOR: PREFER® 5 PIN - 27.40 mm NP YA-41 999R	FOR: ADAMS RITE® FOR: CISA® FOR: PREFER® 5 PIN - 27.40 mm B CK CM NP YA-41D Y1	 DO NOT DUPLICATE 5 PIN - 27.40 mm B YA-41DC DNDY1	 5 PIN - 27.60 mm NP YA-69	 5 PIN - 27.60 mm A NP YA-69D
---	--	--	--	--	--

FOR: YALE®

 5 PIN - 27.40 mm A NP YA-77D	 5 PIN - 28 mm NP YA-78	 5 PIN - 27.20 mm A NP YA-78D	 5 PIN - 27.20 mm NP U-5AD	 5 PIN - 27.20 mm A NP U-5CI	 5 PIN - 27.20 mm A NP U-5CD	 5 PIN - 27.20 mm NP U-5DD
--	---	--	--	---	---	--

FOR: YALE®

 5 PIN - 27.30 mm A NP U-5JD	 6 PIN - 31.40 mm NP YA-221	 6 PIN - 31.40 mm A CK CM NE NP YA-22D	 6 PIN - 32.40 mm NP YA-70	 6 PIN - 32.40 mm A NP YA-70D	 6 PIN - 31.90 mm NP YA-137	 6 PIN - 31.90 mm NP YA-137D
---	---	--	--	--	---	--

FOR: YALE®

 6 PIN - 32.40 mm NP YA-138	 6 PIN - 32.40 mm A NP YA-138D	 6 PIN - 31.90 mm NP YA-171	 6 PIN - 31.90 mm Y2 YA-17D	 6 PIN - 33.40 mm NP YA-139	 6 PIN - 33.40 mm NP YA-139D	 7 PIN - 35 mm NP YA-275	 7 PIN - 35 mm NP YA-275D	 7 PIN - 35 mm NP YA-276	 7 PIN - 35 mm NP YA-276D
---	---	---	---	---	--	--	---	--	---

FOR: YALE®

 VH YA-267 999VH	 VE YA-265 999VE	 VC YA-263 999VC	 VA YA-261 999VA	 VG YA-266 999VG	 VD YA-264 999VD	 VB YA-262 999VB	 GST YA-238D A998GST	 GC YA-237D S998GC	 GB YA-236D S998GB	 GA YA-235D S998GA	 LK YA-214D 999LK	 LG YA-212D 999LG	 LH YA-213D 999LH	 LE YA-210D 999LE	 LF YA-211D 999LF	 LC YA-208D 999LC	 LD YA-209D 999LD	 LA YA-206D 999LA	 LB YA-207D 999LB
----------------------------------	----------------------------------	----------------------------------	----------------------------------	----------------------------------	----------------------------------	----------------------------------	--------------------------------------	------------------------------------	------------------------------------	------------------------------------	-----------------------------------	-----------------------------------	-----------------------------------	-----------------------------------	-----------------------------------	-----------------------------------	-----------------------------------	-----------------------------------	-----------------------------------

FOR: YALE®

 GA YA-186D 999GA	 GB YA-187D 999GB	 GC YA-188D 999GC	 GD YA-189D 999GD	 GE YA-190D 999GE	 GF YA-191D 999GF	 GG YA-192D 999GG	 GH YA-193D 999GH	 GK YA-194D 999GK
-----------------------------------	-----------------------------------	-----------------------------------	-----------------------------------	-----------------------------------	-----------------------------------	-----------------------------------	-----------------------------------	-----------------------------------

YA-195D
998S

 NP YA-195D 998S	 YA-195D 998S
----------------------------------	----------------------------

Concerning the marks and commercial denominations see note in index.

Concerniente a las marcas y denominaciones comerciales ver nota en indice.

Concernant les marques et denominations commerciales voir la note dans l'index.

Concerning the marks and commercial denominations see note in index.

Concerniente a las marcas y denominaciones comerciales ver nota en indice.

Concernant les marques et denominations commerciales voir la note dans l'index.

FOR: YALE®

VA YA-57 998VA	VB YA-58 998VB	VC YA-59 998VC	VD YA-91 998VD	VE YA-92 998VE	VF YA-93 998VF	VG YA-94 998VG	VH YA-95 998VH	VK YA-96 998VK
----------------------	----------------------	----------------------	----------------------	----------------------	----------------------	----------------------	----------------------	----------------------

YA-80
998R

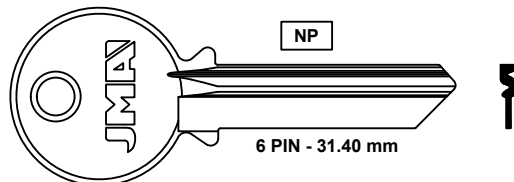

FOR: YALE®

GA YA-57D Y78	GB YA-58D 998GB	GC YA-59D 998GC	GD YA-91D 998GD	GE YA-92D 998GE	GF YA-93D 998GF	GG YA-94D 998GG	GH YA-95D 998GH	GK YA-96D 998GK
---------------------	-----------------------	-----------------------	-----------------------	-----------------------	-----------------------	-----------------------	-----------------------	-----------------------

YA-80D
Y4

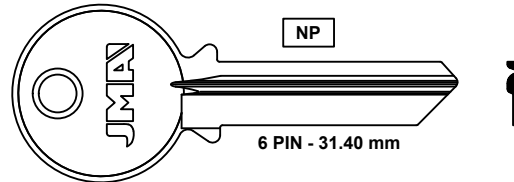

FOR: YALE®

GA YA-196D D998GA	GB YA-197D D998GB	GC YA-198D D998GC	GD YA-199D D998GD	GE YA-200D D998GE	GF YA-201D D998GF	GG YA-202D D998GG	GH YA-203D D998GH	GK YA-204D D998GK
-------------------------	-------------------------	-------------------------	-------------------------	-------------------------	-------------------------	-------------------------	-------------------------	-------------------------

YA-205D
998A

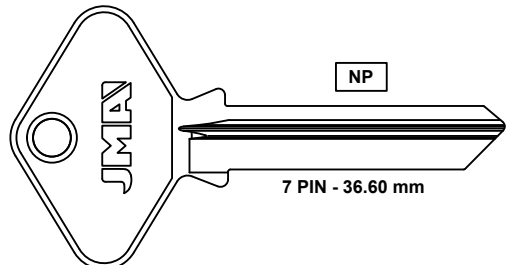

Z ZAMAK

NS N.SILVER / ALPACA
S STEEL / ACERO

NE NEON

NP NICKEL PLATED / LATON NIQUELADO

FM FUN COLOR

GM CRISTAL KEYS / PLASTICO COLOR

A ALUMINUM / ALUMINIO
B BRASS / LATON

Z ZAMAK

NS N.SILVER / ALPACA
S STEEL / ACERO

NE NEON

NP NICKEL PLATED / LATON NIQUELADO

FM FUN COLOR

GM CRISTAL KEYS / PLASTICO COLOR

A ALUMINUM / ALUMINIO
B BRASS / LATON

FOR: YALE®

VA YA-156 H998VA	VB YA-157 H998VB	VC YA-158 H998VC	VD YA-159 H998VD	VE YA-160 H998VE	VF YA-161 H998VF	VG YA-162 H998VG	VH YA-163 H998VH	VK YA-164 H998VK
------------------------	------------------------	------------------------	------------------------	------------------------	------------------------	------------------------	------------------------	------------------------

YA-165
H998R

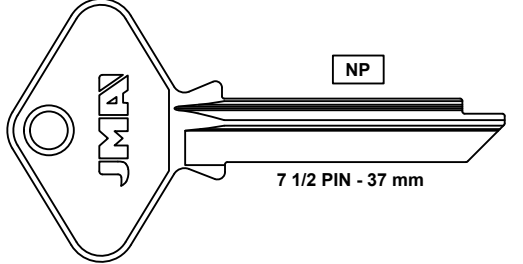

FOR: YALE®

GA YA-156D H998GA	GB YA-157D H998GB	GC YA-158D H998GC	GD YA-159D H998GD	GE YA-160D H998GE	GF YA-161D H998GF	GG YA-162D H998GG	GH YA-163D H998GH	GK YA-164D H998GK
-------------------------	-------------------------	-------------------------	-------------------------	-------------------------	-------------------------	-------------------------	-------------------------	-------------------------

YA-165D
H998

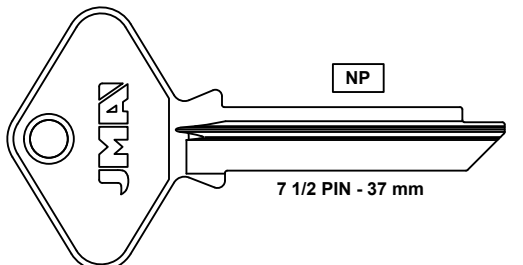

FOR: YALE®

LA YA-97D 998LA	LB YA-98D 998LB	LC YA-99D 998LC	LD YA-100D 998LD	LE YA-101D 998LE	LF YA-102D 998LF	LG YA-103D 998LG	LH YA-104D 998LH	LK YA-105D 998LK
-----------------------	-----------------------	-----------------------	------------------------	------------------------	------------------------	------------------------	------------------------	------------------------

YA-106D
998GL

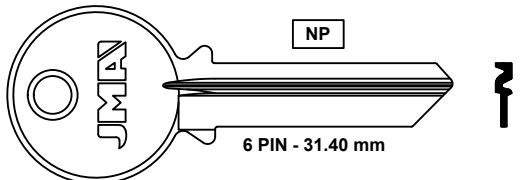

Z ZAMAK

NS N.SILVER / ALPACA
S STEEL / ACERO

NE NEON

NP NICKEL PLATED / LATON NIQUELADO

FM FUN COLOR

GM CRISTAL KEYS / PLASTICO COLOR

A ALUMINUM / ALUMINIO
B BRASS / LATON

Z ZAMAK

NS N.SILVER / ALPACA
S STEEL / ACERO

NE NEON

NP NICKEL PLATED / LATON NIQUELADO

FM FUN COLOR

GM CRISTAL KEYS / PLASTICO COLOR

A ALUMINUM / ALUMINIO
B BRASS / LATON



Concerning the marks and commercial denominations see note in index.

Concerniente a las marcas y denominaciones comerciales ver nota en indice.

Concernant les marques et denominations commerciales voir la note dans l'index.



Concerning the marks and commercial denominations see note in index.

Concerniente a las marcas y denominaciones comerciales ver nota en indice.

Concernant les marques et denominations commerciales voir la note dans l'index.

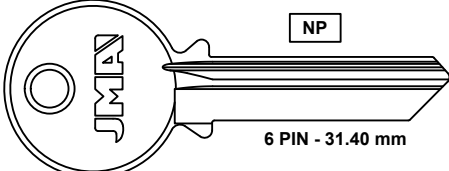
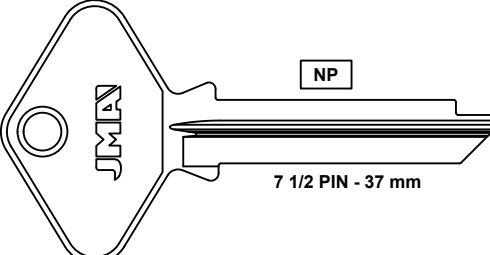
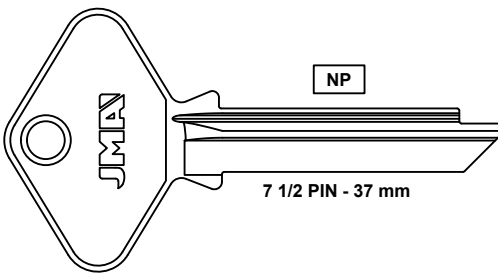
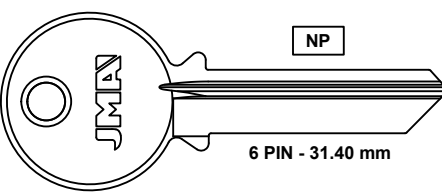
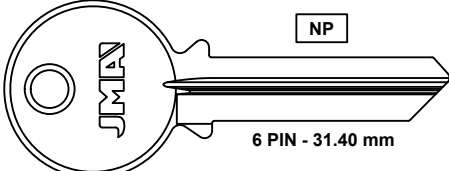
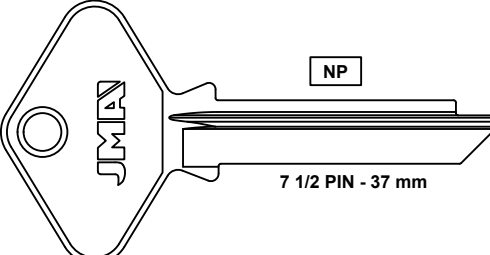

Z ZAMAK	FOR: YALE®									
	YA YA-107 998YA	YB YA-108 998YB	YC YA-109 998YC	YD YA-110 998YD	YE YA-111 998YE	YF YA-112 998YF	YG YA-113 998YG	YH YA-114 998YH	YK YA-115 998YK	
						YMK YA-116 998YMK				
NS S										
S STEEL / ACERO	FOR: YALE®									
	SA YA-176D H998SA	SB YA-177D H998SB	SC YA-178D H998SC	SD YA-179D H998SD	SE YA-180D H998SE	SF YA-181D H998SF	SG YA-182D H998SG	SH YA-183D H998SH	SK YA-184D H998SK	
						SMK YA-185D H998SMK				
NS S										
Z ZAMAK	FOR: YALE®									
	YA YA-146 H998YA	YB YA-147 H998YB	YC YA-148 H998YC	YD YA-149 H998YD	YE YA-150 H998YE	YF YA-151 H998YF	YG YA-152 H998YG	YH YA-153 H998YH	YK YA-154 H998YK	
						YMK YA-155 H998YMK				
NS S										
S STEEL / ACERO	FOR: YALE®									
	TA YA-127D 998TA	TB YA-128D 998TB	TC YA-129D 998TC	TD YA-130D 998TD	TE YA-131D 998TE	TF YA-132D 998TF	TG YA-133D 998TG	TH YA-134D 998TH	TK YA-135D 998TK	
						TMK YA-136D 998TMK				
NS S										
Z ZAMAK	FOR: YALE®									
	SA YA-117D 998SA	SB YA-118D 998SB	SC YA-119D 998SC	SD YA-120D 998SD	SE YA-121D 998SE	SF YA-122D 998SF	SG YA-123D 998SG	SH YA-124D 998SH	SK YA-125D 998SK	
						SMK YA-126D 998SMK				
NS S										
S STEEL / ACERO	FOR: YALE®									
	TA YA-166D H998TA	TB YA-167D H998TB	TC YA-168D H998TC	TD YA-169D H998TD	TE YA-170D H998TE	TF YA-171D H998TF	TG YA-172D H998TG	TH YA-173D H998TH	TK YA-174D H998TK	
						TMK YA-175D H998TMK				
NS S										



Concerning the marks and commercial denominations see note in index.

Concerniente a las marcas y denominaciones comerciales ver nota en índice.

Concernant les marques et dénominations commerciales voir la note dans l'index.



Concerning the marks and commercial denominations see note in index.

Concerniente a las marcas y denominaciones comerciales ver nota en índice.

Concernant les marques et dénominations commerciales voir la note dans l'index.











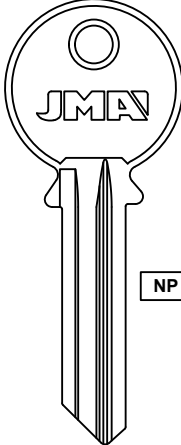

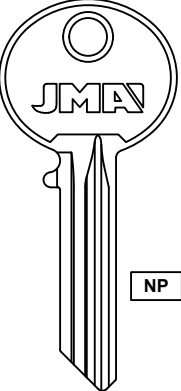

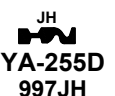



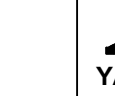

Z ZAMAK
 NS N.SILVER / ALPACA S STEEL / ACERO
 NE NEON NP NICKEL PLATED / LATON NIQUELADO
 CM FUN COLOR CK CRISTAL KEYS / PLASTICO COLOR
 A ALUMINUM / ALUMINIO B BRASS / LATON





Z ZAMAK
 NS N.SILVER / ALPACA S STEEL / ACERO
 NE NEON NP NICKEL PLATED / LATON NIQUELADO
 CM FUN COLOR CK CRISTAL KEYS / PLASTICO COLOR
 A ALUMINUM / ALUMINIO B BRASS / LATON

FOR: YALE®

FOR: YALE®

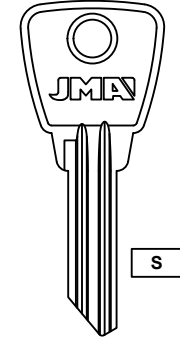
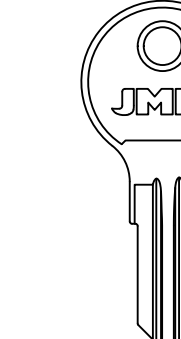

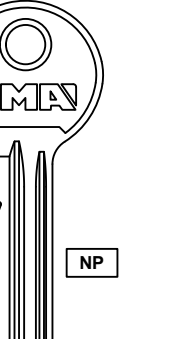
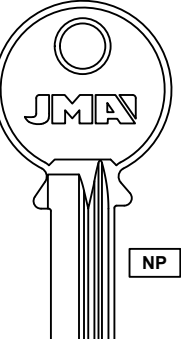
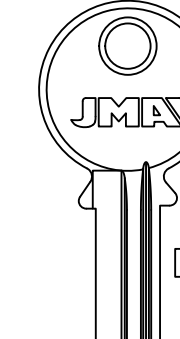
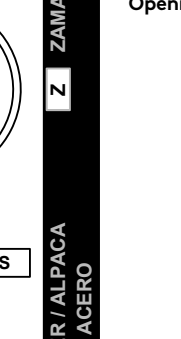

 PK YA-247D 998PK	 PG YA-245D 998PG	 PH YA-246D 998PH	 JK YA-256D 997JK	 JG YA-254D 997JG	 JH YA-255D 997JH	 ZG YA-260 998ZG	 ZC YA-259 998ZC	 ZB YA-258 998ZB	 ZA YA-257 998ZA
 PE YA-243D 998PE	 PF YA-244D 998PF	 PC YA-241D 998PC	 PD YA-242D 998PD	 JE YA-252D 997JE	 JF YA-253D 997JF	 JC YA-250D 997JC	 JD YA-251D 997JD	 JA YA-248D 997JA	 JB YA-249D 997JB

6 PIN - 31,40 mm

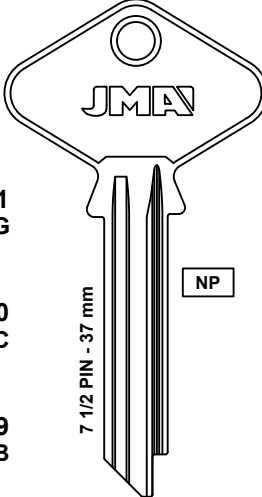
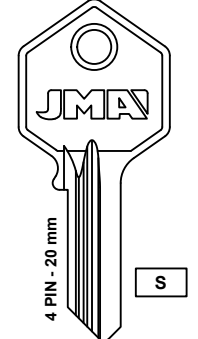
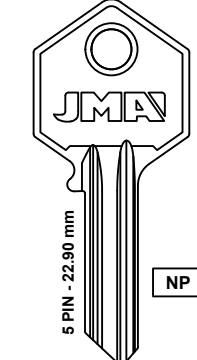
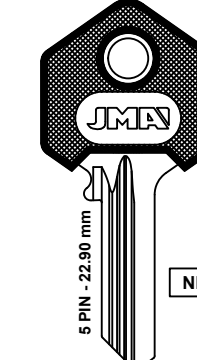

										
YA-10	YA-10D E1122A	YA-11I	YA-11D	YA-12I	YA-13I 997ER	YA-13D Y52	YA-14I	YA-14D	YA-15I	YA-15D

FOR: YALE®

FOR: YALE®

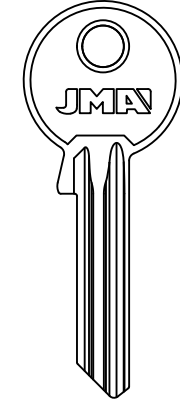
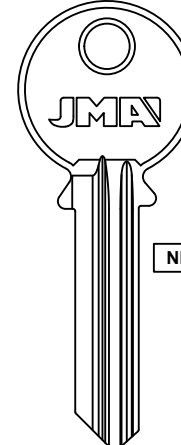
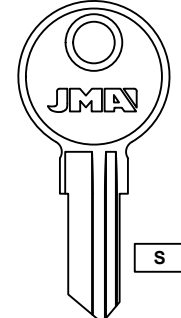
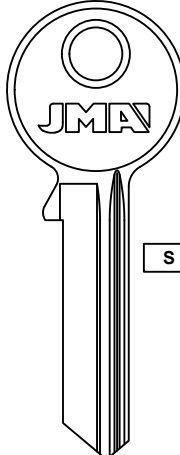
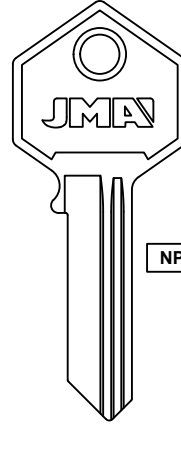

 ZG YA-271 H998ZG	 ZC YA-270 H998ZC	 ZB YA-269 H998ZB	 ZA YA-268 H998ZA	 YA-33D H997EB	 YA-3I H997ER	 YA-3D H997E	 YA-3D.P
--	--	---	--	---	---	---	--

7 1/2 PIN - 37 mm
4 PIN - 20 mm
5 PIN - 22,90 mm
5 PIN - 22,90 mm

						
YA-25I O997ER	YA-25D Y54	YA-26I	YA-27	YA-27D	YA-28	YA-32D

FOR: YALE®

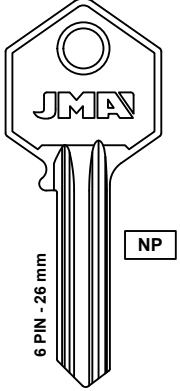
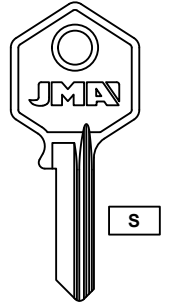
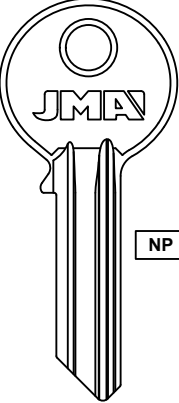
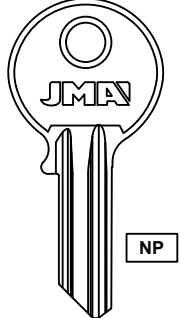
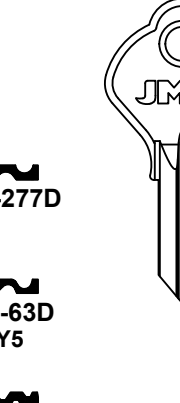
FOR: YALE®

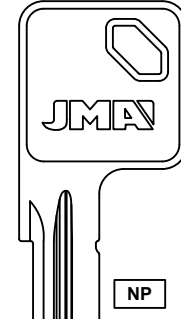
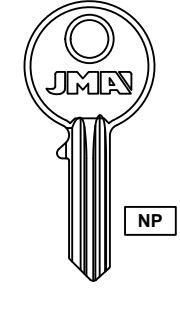
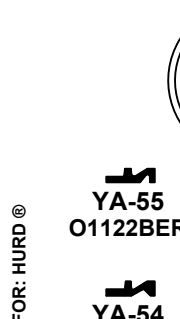
								
YA-43	YA-43D	YA-5I HR1132	YA-5D H1132	YA-6I X999R	YA-6D X999	YA-7I R997EB	YA-7D 997B	YA-8D F1122A

6 PIN - 26 mm

YA-277D
YA-63D
Y5
YA-16D
YL5

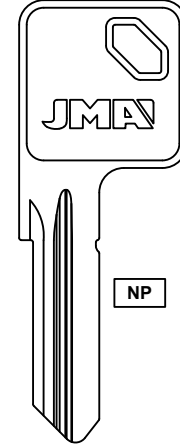
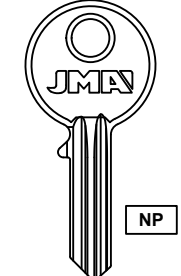
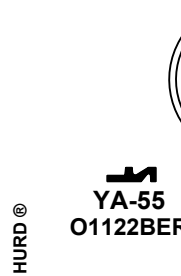
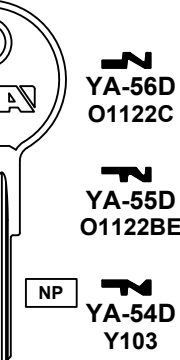
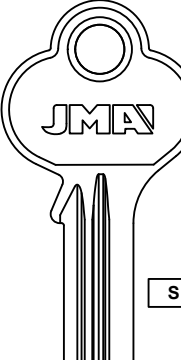
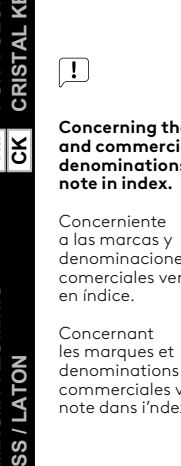
					
YA-34D Y1E	YA-42	YA-42D	YA-44 Y13	YA-44D Y11	YA-46D

FOR: HUDSON®
FOR: SECURITY®

YA-55
O1122BER

YA-54
O1122BR

YA-56D
O1122C

YA-55D
O1122BE

YA-54D
Y103

YA-45
Y14

YA-45D
Y12

Concerning the marks and commercial denominations see note in index.

Concerniente a las marcas y denominaciones comerciales ver nota en indice.

Concernant les marques et denominations commerciales voir la note dans l'index.

Concerning the marks and commercial denominations see note in index.

Concerniente a las marcas y denominaciones comerciales ver nota en indice.

Concernant les marques et denominations commerciales voir la note dans l'index.

Z ZAMAK NS N.SILVER / ALPACA S STEEL / ACERO NE NEON NP NICKEL PLATED / LATON NIQUELADO NE NEON NP NICKEL PLATED / LATON NIQUELADO FUN COLOR CM CRISTAL KEYS / PLASTICO COLOR CK CRISTAL KEYS / PLASTICO COLOR A ALUMINUM / ALUMINIO B BRASS / LATON	FOR: YALE [®]					FOR: YALE [®]					FOR: YALE [®]													
	FOR: ABUS [®] YA-60D Y220	YA-64D 998GST	YA-71	YA-72	YA-73	YA-73D	YA-75D	YA-82D Y6	YA-85	YA-85D	YA-272	YA-272D	YA-90	YA-279D	YA-279D	YA-302	YA-302D	YA-279D	YA-279D	YA-279D	YA-279D			
FOR: YETI [®]					FOR: YETI [®]					FOR: YETI [®]					FOR: YETI [®]									
YET-7	YET-7D	YET-8	YET-8D	YET-9	YET-9D	YET-10	YET-10D	YET-11	YET-11D	YET-1	YET-1D	YET-2	YET-2D	YET-5	YET-5D	YET-6D	YET-6D	YET-6D	YET-6D	YET-6D	YET-6D			
FOR: ZEISS IKON [®]					FOR: ZEISS IKON [®]					FOR: ZEISS IKON [®]					FOR: ZENI [®]									
ZE-5I ZKN1R	ZE-5D ZKN1	ZE-K6 S60R	ZE-K5 S60	ZEN-1D ZN1	ZE-5I ZKN1R	ZE-5D ZKN1	ZE-K6 S60R	ZE-K5 S60	ZEN-1D ZN1	ZE-5I ZKN1R	ZE-5D ZKN1	ZE-K6 S60R	ZE-K5 S60	ZEN-1D ZN1	ZE-5I ZKN1R	ZE-5D ZKN1	ZE-K6 S60R	ZE-K5 S60	ZEN-1D ZN1	ZE-5I ZKN1R	ZE-5D ZKN1	ZE-K6 S60R	ZE-K5 S60	ZEN-1D ZN1

Z ZAMAK
NS N.SILVER / ALPACA
S STEEL / ACERO
NE NEON
NP NICKEL PLATED / LATON NIQUELADO
FUN COLOR
CM CRISTAL KEYS / PLASTICO COLOR
CK CRISTAL KEYS / PLASTICO COLOR
A ALUMINUM / ALUMINIO
B BRASS / LATON



Concerning the marks and commercial denominations see note in index.

Concerniente a las marcas y denominaciones comerciales ver nota en indice.

Concernant les marques et denominations commerciales voir la note dans l'index.



Concerning the marks and commercial denominations see note in index.

Concerniente a las marcas y denominaciones comerciales ver nota en indice.











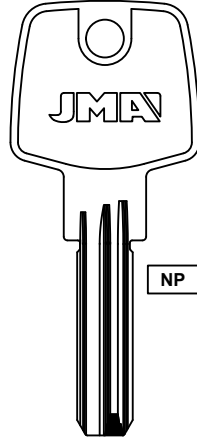
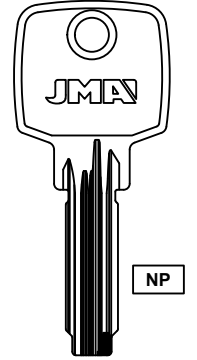
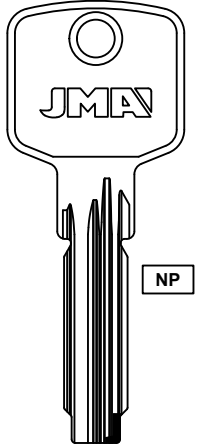
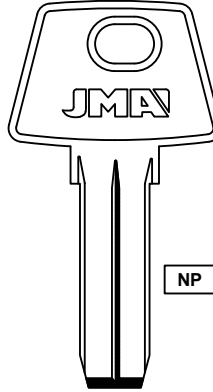
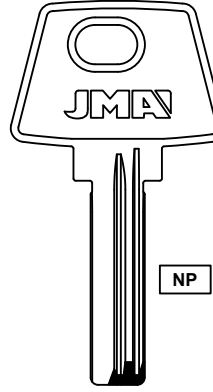





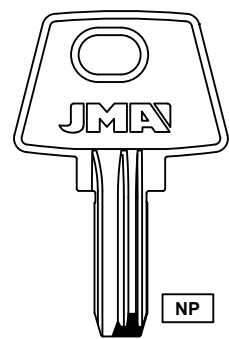
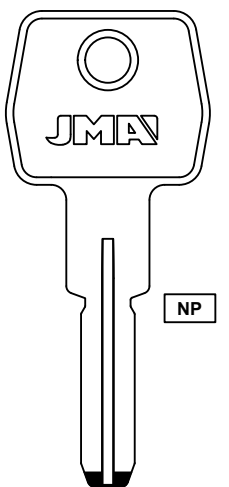
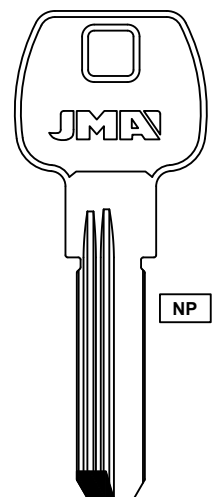
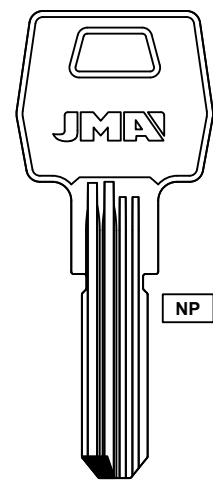
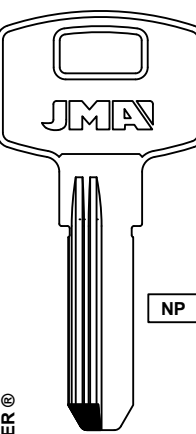

Concernant les marques et denominations commerciales voir la note dans l'index.



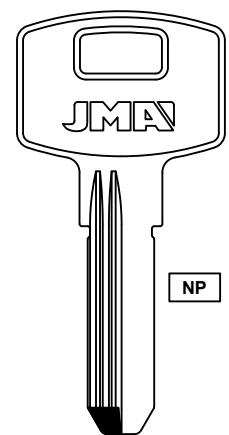
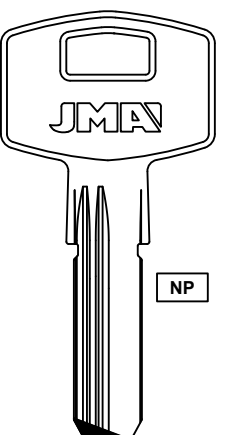
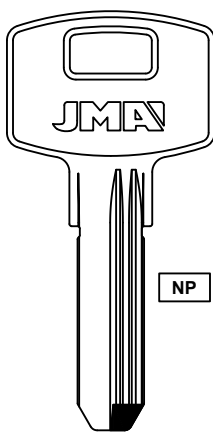
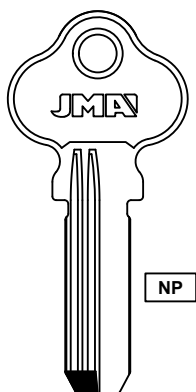
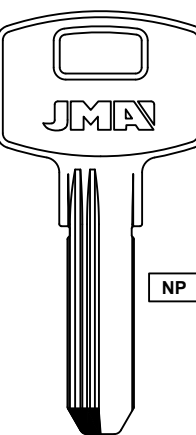

DIMPLE KEYS

Llaves de puntos
Clés à points

FOR: ABUS®			FOR: AGA®	
				
 ABU-16	 ABU-34	 ABU-81	 AGA-12	 AGA-38
FOR: AGA®	FOR: AGB®	FOR: AKI®		FOR: ALFA®
				
 AGA-50	 AGB-2	 AKI-1D	 AKI-2D	 ALF-39D
FOR: AMIG®			FOR: ANDESLOCK®	FOR: APECS®
				
 AMG-8D	 AMG-9D	 AMG-10	 AND-1D	 AP-1D

Z ZAMAK
NS N. SILVER / ALPACA
S STEEL / ACERO
NE NEON
NP NICKEL PLATED / LATON NIQUELADO
FUN FUN COLOR
CK CRISTAL KEYS / PLASTICO COLOR
A ALUMINUM / ALUMINIO
B BRASS / LATON

! Concerning the marks and commercial denominations see note in index.

Concerniente a las marcas y denominaciones comerciales ver nota en indice.

Concernant les marques et denominations commerciales voir la note dans l'index.

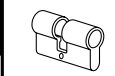

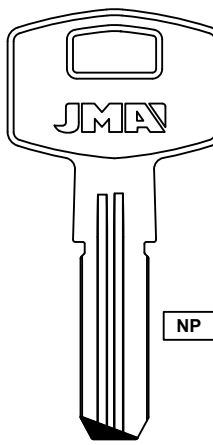
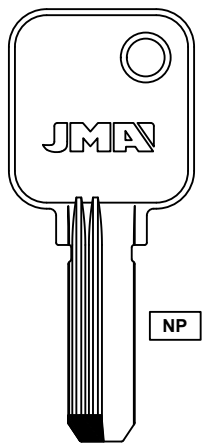
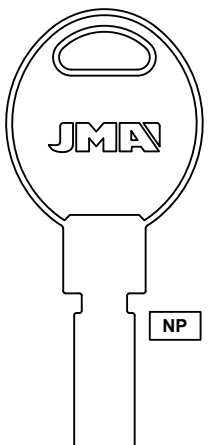
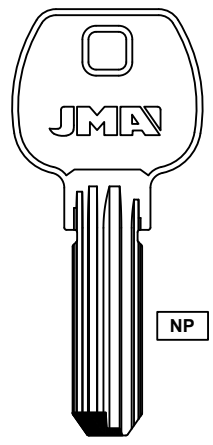
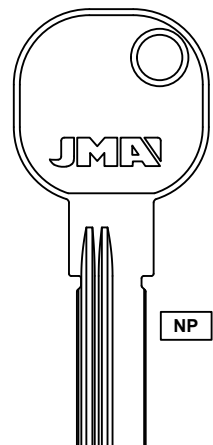
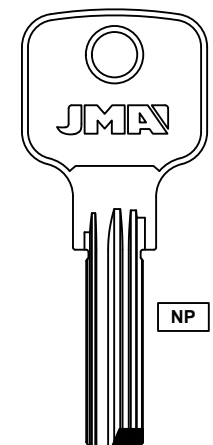
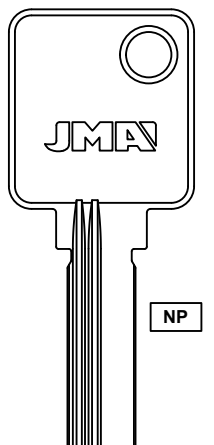
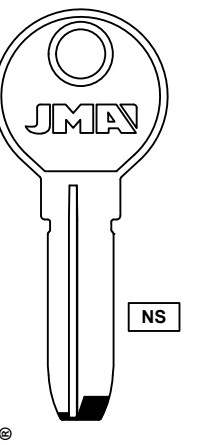
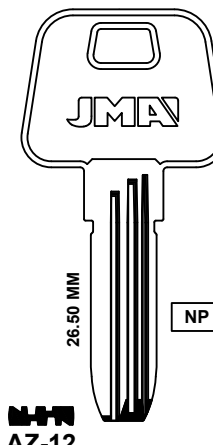
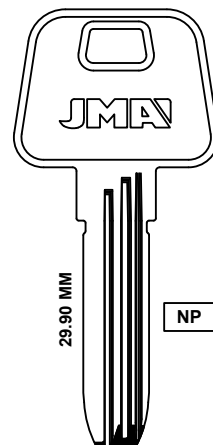
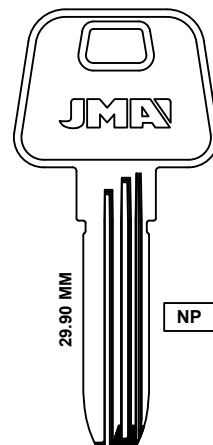
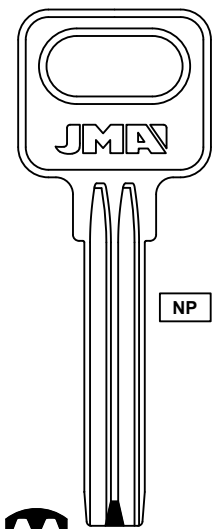
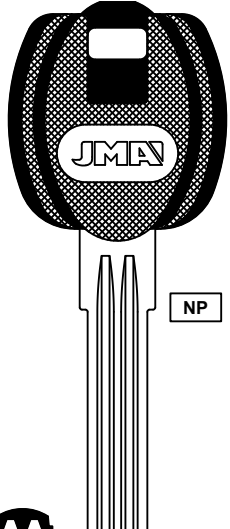
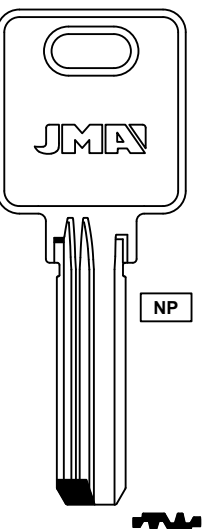
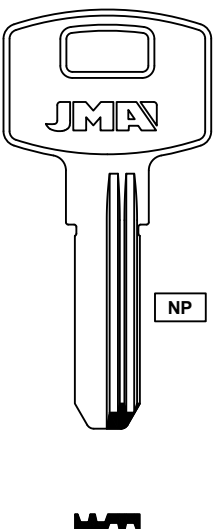
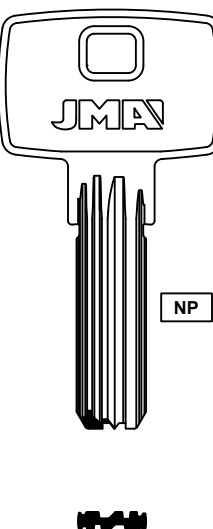
<p>CM CK</p> <p>FUN COLOR CRISTAL KEYS / PLASTICO COLOR</p> <p>NE NP</p> <p>NEON NICKEL PLATED / LATON NIQUELADO</p> <p>NS S</p> <p>N.SILVER / ALPACA STEEL / ACERO</p> <p>Z ZAMAK</p>	FOR: ASHICO®				
					
	ASH-2	ASH-3D	ASH-5 3 mm	ASH-6D	ASH-7D
FOR: ASHICO®		FOR: AZBE®			
					
ASH-8	ASH-9D	AZ-8D	AZ-9 26.50 MM	AZ-9D 29.90 MM	AZ-14
		FOR: IFAM®			FOR: ASHICO®
FOR: BAODEAN®		FOR: BEY®	FOR: BIMETAL®	FOR: BULAT®	
					
BDA-1	BDA-2.P	BEY-2D	BIM-1	BUL-1	

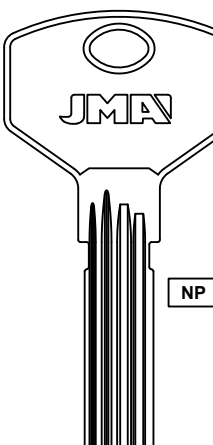
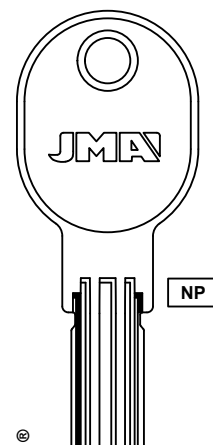
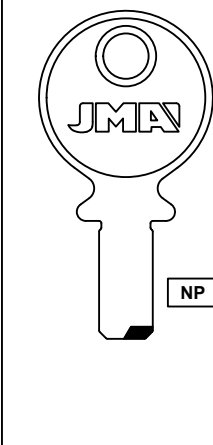
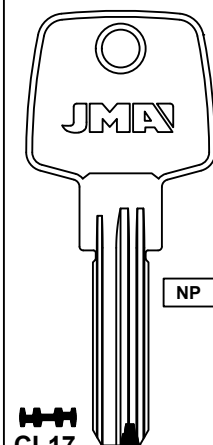
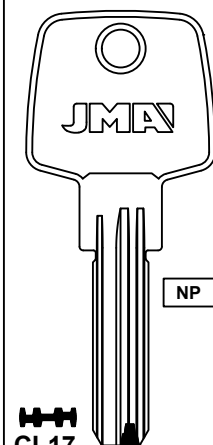
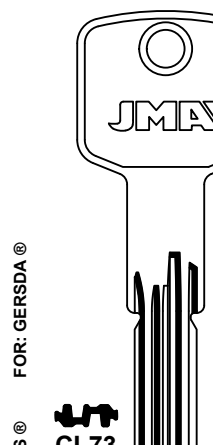
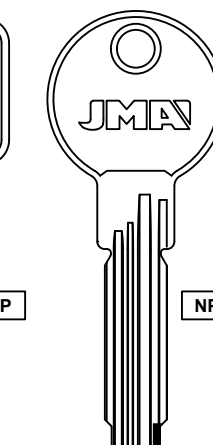
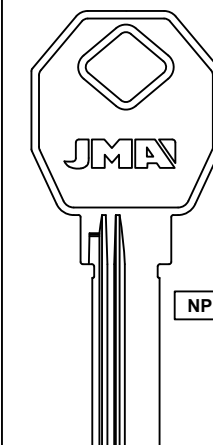
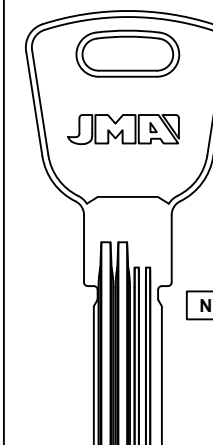
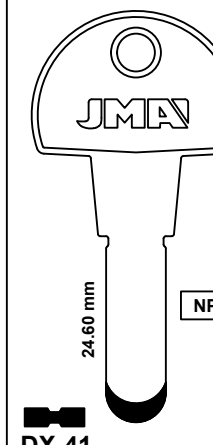
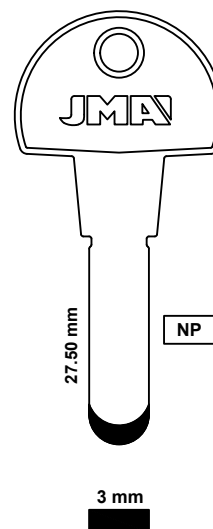
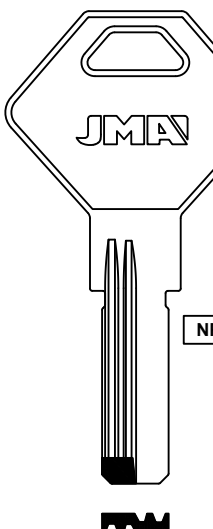
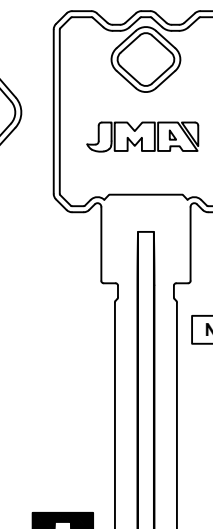
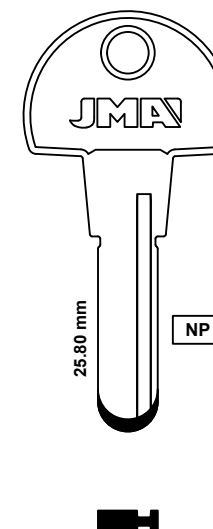
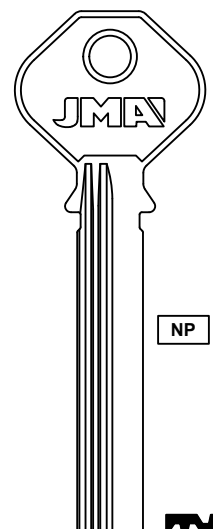
FOR: CANTOL®	FOR: CAYS®	FOR: CES®	FOR: CISA®	
				
CTO-4D	CAY-2	CE-114	CI-14	CI-17
FOR: CISA®		FOR: CVL®	FOR: DAF®	FOR: DEXTER®
				
CI-48	CI-57	CVL-9D	DAF-5D	DX-8 3 mm
FOR: DEXTER®		FOR: DEXTER®		
				
DX-9 27.50 mm 3 mm	DX-11D	DX-39	DX-40 25.80 mm	DX-42D

Concerning the marks and commercial denominations see note in index.

Concerniente a las marcas y denominaciones comerciales ver nota en indice.

Concernant les marques et denominations commerciales voir la note dans l'index.











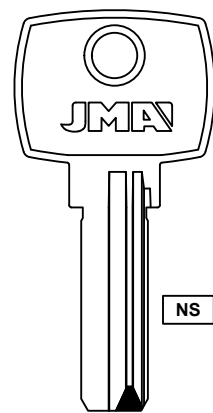
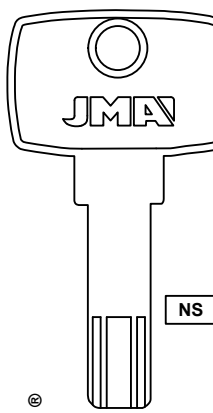
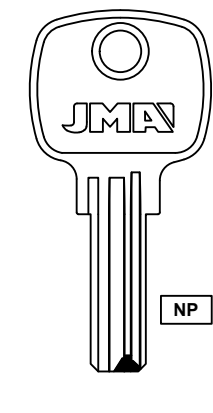
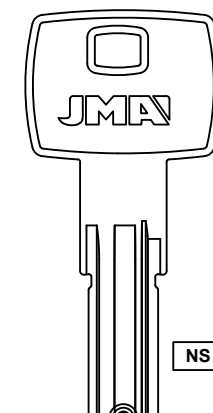
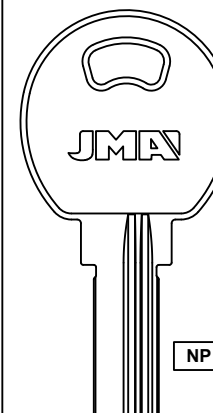



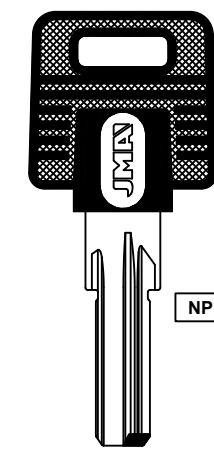
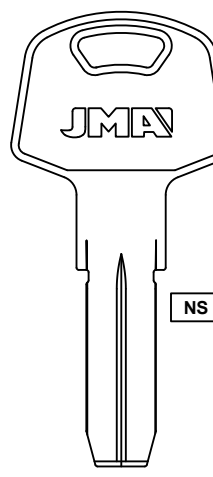
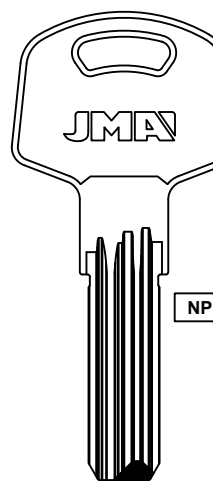
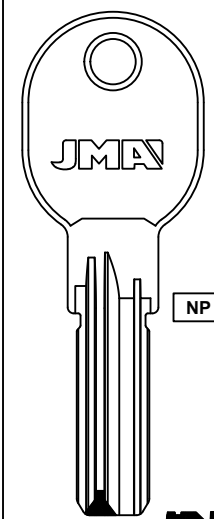
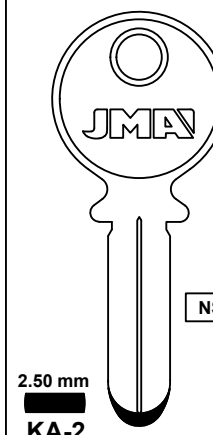
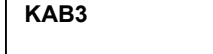
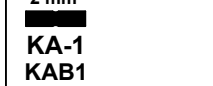
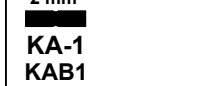
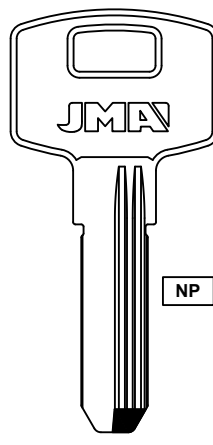

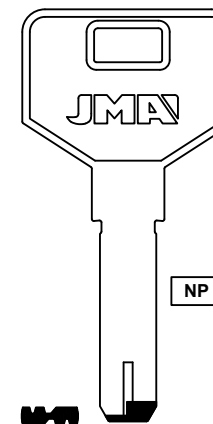

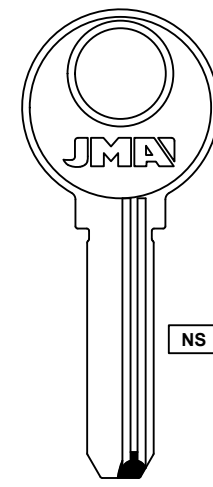

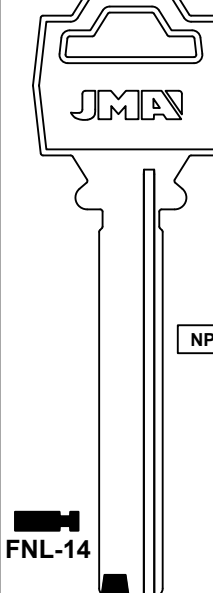

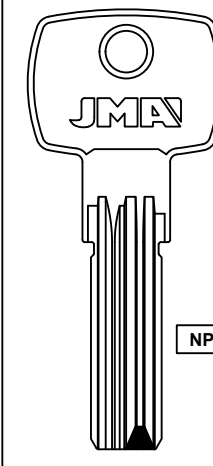

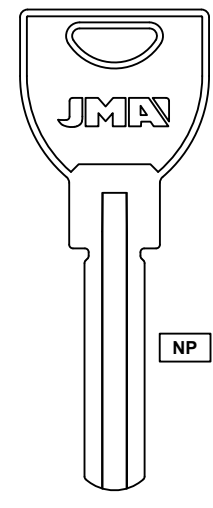
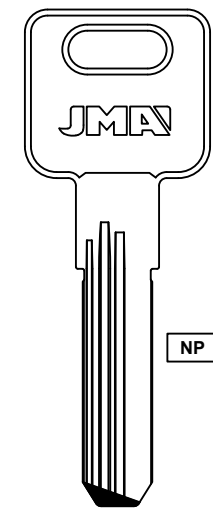
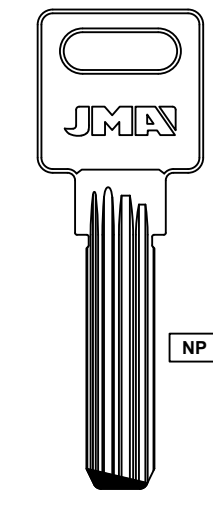
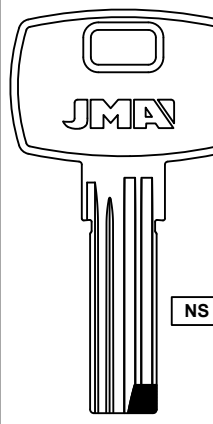

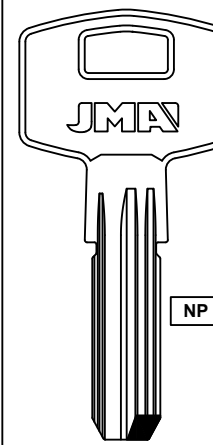



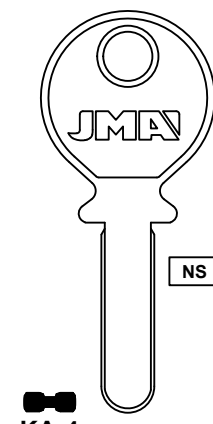
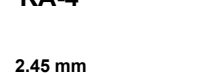

Concerning the marks and commercial denominations see note in index.

Concerniente a las marcas y denominaciones comerciales ver nota en indice.

Concernant les marques et denominations commerciales voir la note dans l'index.

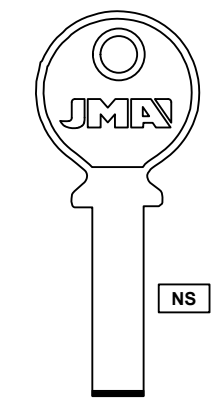

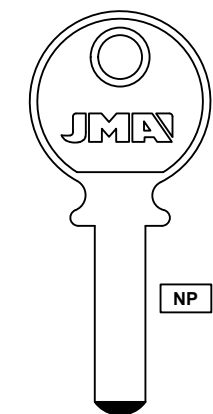
Z ZAMAK NS N. SILVER / ALPACA S STEEL / ACERO NE NEON NP NICKEL PLATED / LATON NIQUELADO NE NEON NP NICKEL PLATED / LATON NIQUELADO CM FUN COLOR CK CRISTAL KEYS / PLASTICO COLOR A ALUMINUM / ALUMINIO B BRASS / LATON	FOR: DOM®  NS  NS  NP  NS  NP  NP				FOR: EUROLATON®  NP  NP
	FOR: HERMEX®  NP FOR: IFAM®  NS  NP FOR: ISEO®  NP FOR: KABA®  NS  2.50 mm  2 mm  NP				
	FOR: EUROLATON®  NP  NP	FOR: EZCURRA®  NP  NP	FOR: FAC®  NS  NP	FOR: FANAL®  NP  NP	FOR: FERMAX®  NP  NP
	FOR: FORTE®  NP  NP  NP		FOR: FTH®  NS  NP	FOR: GATO®  NP  NP	

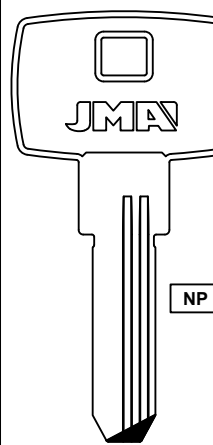
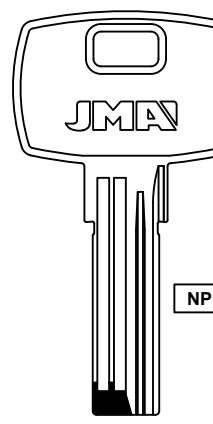
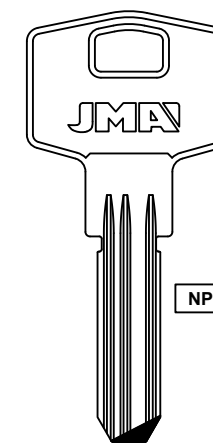
FOR: KABA®  NS  NP  2.45 mm  NP  1.45 mm  2 mm  2 mm  NP  2.45 mm  NP				
FOR: KABA®  NS  2 mm  NP  2 mm		FOR: KALE®  NP  NP  NP		



Concerning the marks and commercial denominations see note in index.

Concerniente a las marcas y denominaciones comerciales ver nota en indice.

Concernant les marques et denominations commerciales voir la note dans l'index.



Concerning the marks and commercial denominations see note in index.

Concerniente a las marcas y denominaciones comerciales ver nota en indice.

Concernant les marques et denominations commerciales voir la note dans l'index.



Z ZAMAK	FOR: KALE®		FOR: KESO®				
	 NP KAE-12D	 NP KAE-11D	 NS KE-1	 NP 2 mm KE3 KE3	 NS 2.45 mm KE-4	 NS 2.45 mm KE-6	
	FOR: LINCE®		FOR: LOCK®		FOR: LOTUS®		
NS N.SILVER / ALPACA S STEEL / ACERO	 NP LIN-13	 NP LIN-19	 NP LIN-19D	 NP FOR: PRUREB® LOC-8	 NP LOC-9	 NP LOT-1	 NP LOT-1D
NE NEON NP NICKEL PLATED / LATON NIQUELADO	FOR: LOTUS®		FOR: MAGNUN®	FOR: MASTER®	FOR: MASTER LOCK®	FOR: MCM®	
GM FUN COLOR CK CRISTAL KEYS / PLASTICO COLOR	 NP LOT-2.P	 NP MAG-4D	 NP MAG-1D	 NP MAS-15.P	 NP MASL-1	 NS 2.30 mm MCM-4SS	
A ALUMINUM / ALUMINIO B BRASS / LATON	FOR: LOTUS®		FOR: MAGNUN®		FOR: MASTER®	FOR: MASTER LOCK®	FOR: MCM®

FOR: MCM®		FOR: MHA®	FOR: MULT.LOCK®	
 NP 4SE MCM-10	 NP E8 MCM-16	 NP MHA-1	 NP JUNIOR NS MU-11.P1	 NP 64 MU-8.P1
FOR: MULT.LOCK®		FOR: ODIS®		
 NS 76 MU-10.P	 NP MU-12	 NP MU-12D	 NP OD-1	 NP 23.40 mm OD-2
FOR: ODIS®		FOR: ODIS®		
 NP 30.40 mm OD-4	 NP OD-5D	 NP C60 OD-12 2P-70 OD-11	 NP OD-13D	 NP OD-16D
FOR: ODIS®		FOR: ODIS®		

Z
ZAMAK
NS
N.SILVER / ALPACA
S
STEEL / ACERO
NE
NEON
NP
NICKEL PLATED / LATON NIQUELADO
GM
FUN COLOR
CK
CRISTAL KEYS / PLASTICO COLOR
A
ALUMINUM / ALUMINIO
B
BRASS / LATON

! Concerning the marks and commercial denominations see note in index.
Concerniente a las marcas y denominaciones comerciales ver nota en indice.
Concernant les marques et denominations commerciales voir la note dans l'index.

! Concerning the marks and commercial denominations see note in index.
Concerniente a las marcas y denominaciones comerciales ver nota en indice.
Concernant les marques et denominations commerciales voir la note dans l'index.

Z ZAMAK	NS N. SILVER / ALPACA S STEEL / ACERO	FOR: ODIS® NP OD-17D	FOR: PAPAIZ® NP PAP-10.P	FOR: PHILLIPS® NP 25.50 mm 1.90 mm FOR: BORKEY® BKY-1			 NP 21.50 mm 1.90 mm FOR: BORKEY® BKY-2	 NP 35.40 mm PHI-5D				
		FOR: PHILLIPS® NP PHI-12							 NP PHI-13	 NP 27.20 mm PHI-14D	 NP 30 mm AS3000 PHI-15D	 NP 29.90 mm A2000 PHI-17D
		GM FUN COLOR CK CRISTAL KEYS / PLASTICO COLOR	FOR: POLI® NP PLI-3D	FOR: SCANAVINI® NP SCA-6D	FOR: SCHLAGE® NP SLG-41D	FOR: SCOVILL® NP S1 SCO-14			FOR: YALE®			
A ALUMINUM / ALUMINIO B BRASS / LATON												

FOR: SEA® NS 2.2 mm SEA-1		 NP 2.2 mm SEA-2	FOR: SECUREMME® NP SEC-3		 NP SEC-3D	FOR: SICUREZZA® NP SCZ-1D		 NP SCZ-2D		
FOR: SOPRANO® NP 26 mm SOP-3D					 NP 29 mm SOP-4D	 NP SOP-5	 NP SOP-5D	 NP SOP-8D	FOR: STS® NS 2.3 mm STS-T14	
FOR: STS® NP 5 PIN-19.40 mm STS-X5		 NP 6 PIN-23 mm STS-X6	FOR: TESA® NP TE-34D			 NP TE-T10	 NP TE-T60			
A ALUMINUM / ALUMINIO B BRASS / LATON										



Concerning the marks and commercial denominations see note in index.

Concerniente a las marcas y denominaciones comerciales ver nota en indice.

Concernant les marques et denominations commerciales voir la note dans l'index.



Concerning the marks and commercial denominations see note in index.

Concerniente a las marcas y denominaciones comerciales ver nota en indice.

Concernant les marques et denominations commerciales voir la note dans l'index.



Z ZAMAK NS N.SILVER / ALPACA S STEEL / ACERO	FOR: TESA®		FOR: TOVER®		
	TE-T62	TE-T80	TOV-2	TOV-4	TOV-5
NE NEON NP NICKEL PLATED / LATON NIQUELADO	FOR: TOVER®		FOR: TRAVEX®		
	TOV-6	TOV-7	TOV-9D	TOV-11	TRV-4D
CM FUN COLOR CK CRISTAL KEYS / PLASTICO COLOR	FOR: TRUPER®		FOR: UCEM®		
	TRU-5	TRU-5D	TRU-12	TRU-13D	UCEM-8D
A ALUMINUM / ALUMINIO B BRASS / LATON			UCEM-13D 26.50 mm		

Z ZAMAK NS N.SILVER / ALPACA S STEEL / ACERO	FOR: UNIVERSAL®		FOR: URBIS®	FOR: VIRO®	FOR: YALE®
	TX-4D	TX-23D	URB-3D	VI-14	YA-65
NE NEON NP NICKEL PLATED / LATON NIQUELADO	FOR: YALE®		FOR: YARDENI®		
	YA-84	YA-84D	YAR-1	YAR-2	YAR-3
CM FUN COLOR CK CRISTAL KEYS / PLASTICO COLOR	FOR: YARDENI®				
	YAR-5D				

! Concerning the marks and commercial denominations see note in index.

Concerniente a las marcas y denominaciones comerciales ver nota en indice.

Concernant les marques et denominations commerciales voir la note dans l'index.



! Concerning the marks and commercial denominations see note in index.

Concerniente a las marcas y denominaciones comerciales ver nota en indice.

Concernant les marques et denominations commerciales voir la note dans l'index.





FLAT & LOCKER KEYS

Llaves para casillas
Clés pour casiers

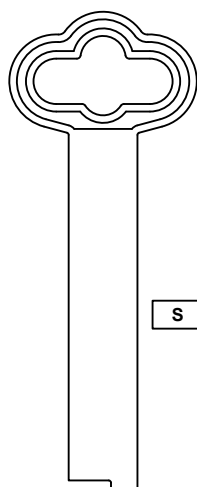
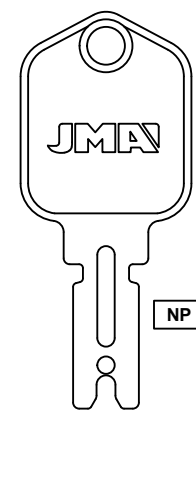
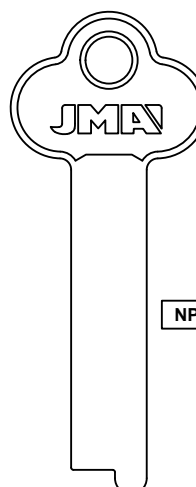
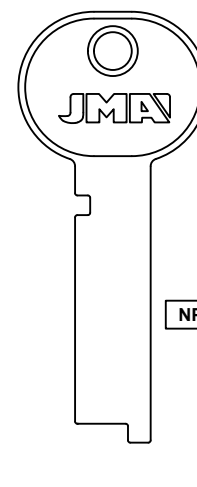
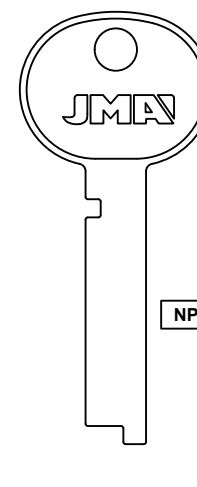
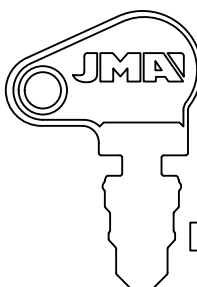
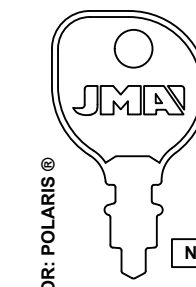
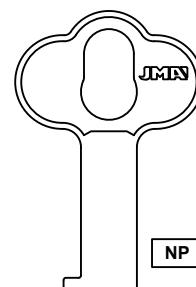
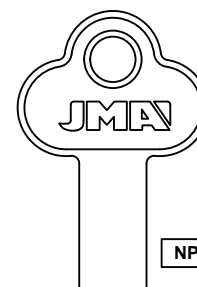
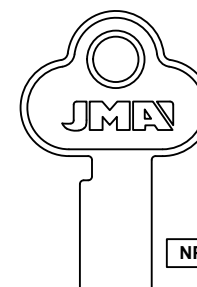
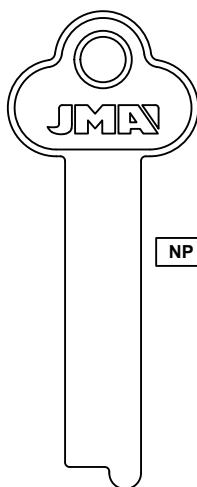
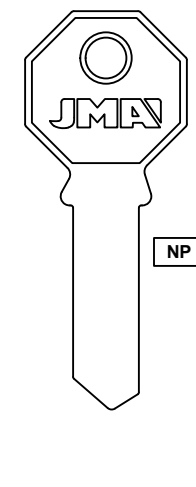
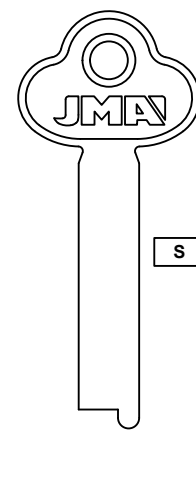
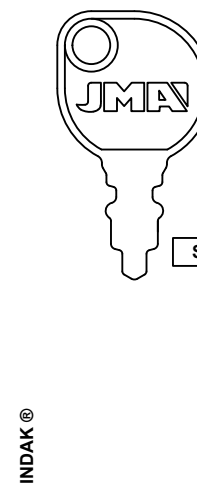
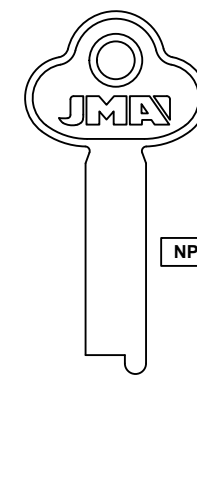
		FOR: CLARK FORK LIFT®	FOR: DIEBOLD®	FOR: MILES®	
					
	1.20 mm AC-12	NP CLF-1 1430	NP DIE-1 1.5 mm	NP MIL-1 1.2 mm	NP MIL-2 MN3 1.2 mm
FOR: MISCELLANEOUS®			FOR: MOSLER®		
					
	FOR: COLE HERSEE® FOR: GOLF CART® FOR: YARD TRACTOR® 2 mm MIS-1 1147	FOR: POLARIS® FOR: INDAK® FOR: YARD TRACTOR® 1.60 mm MIS-2 1148	1.30 mm MIS-3 1028DC	1.5 mm MSL-1 4015	FOR: ILCO® FOR: KABA MAS® 1.5 mm MSL-2 1335S
FOR: MOSLER®	FOR: PHILLIPS®	FOR: RIL®	FOR: TECUMSEH®	FOR: YALE®	
					
1.5 mm MSL-3	NP PHI-11 1.8 mm	NP 26-M 1.2 mm	FOR: INDAK® TEU-1	NP YA-30 37D 1.7 mm	

Z ZAMAK
 NS N. SILVER / ALPACA
 S STEEL / ACERO
 NE NEON
 NP NICKEL PLATED / LATON NIQUELADO
 FUN COLOR
 CM CRISTAL KEYS / PLASTICO COLOR
 A ALUMINUM / ALUMINIO
 B BRASS / LATON

! Concerning the marks and commercial denominations see note in index.

Concerniente a las marcas y denominaciones comerciales ver nota en indice.

Concernant les marques et denominations commerciales voir la note dans l'index.

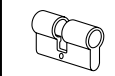



BIT AND BARREL KEYS

Llaves de Gorja
Clés à gorge

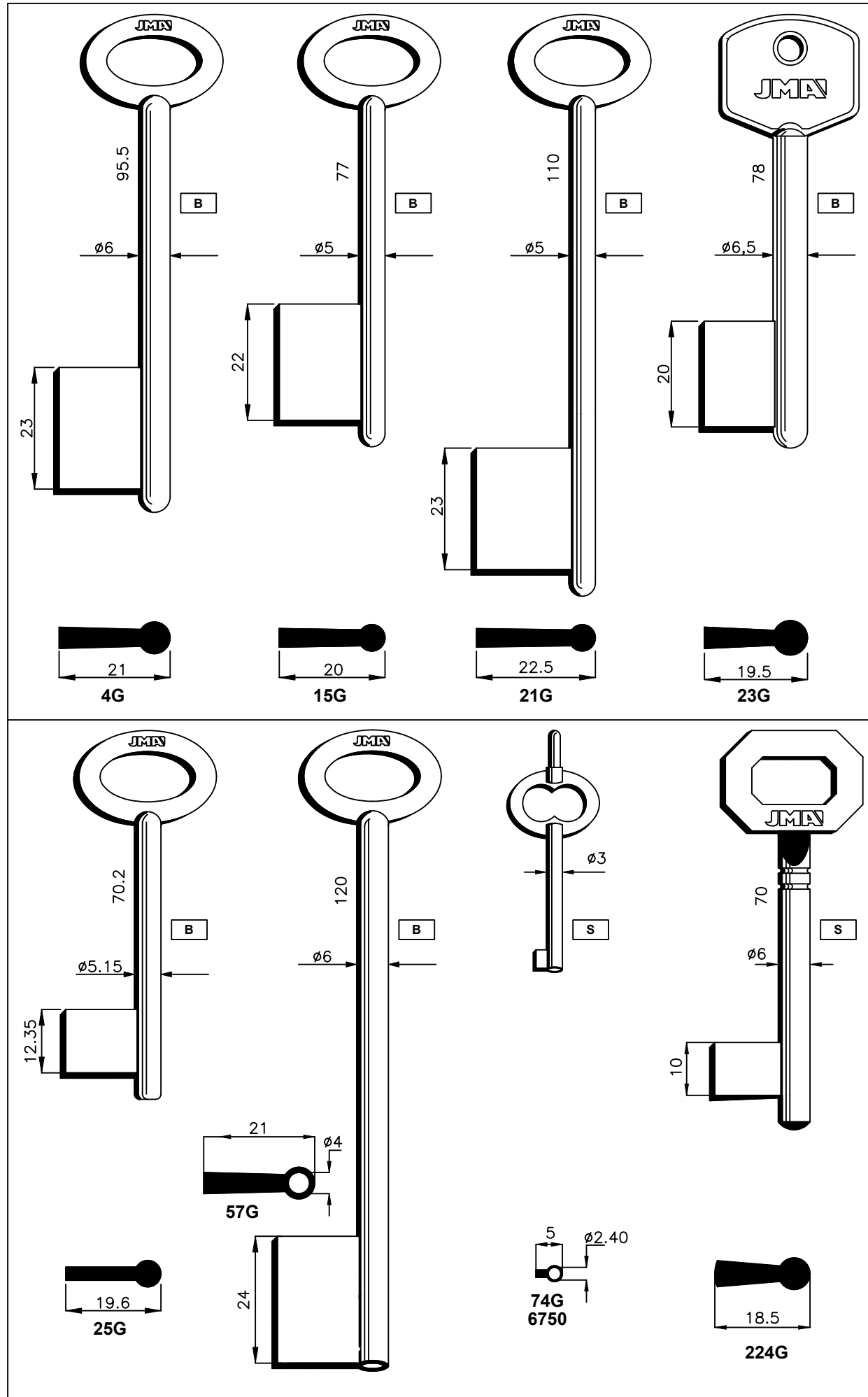

A	ALUMINUM / ALUMINIO	CM	FUN COLOR	NE	NEON	Z	ZAMAK
B	BRASS / LATON	CK	CRISTAL KEYS / PLASTICO COLOR	NP	NICKEL PLATED / LATON NIQUELADO	S	STEEL / ACERO
				NS	N.SILVER / ALPACA		

! Concerning the marks and commercial denominations see note in index.

Concerniente a las marcas y denominaciones comerciales ver nota en indice.

Concernant les marques et denominations commerciales voir la note dans l'index.

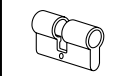

<p>Z ZAMAK</p> <p>NS N.SILVER / ALPACA S STEEL / ACERO</p> <p>NE NEON NP NICKEL PLATED / LATON NIQUELADO</p> <p>CM FUN COLOR CK CRISTAL KEYS / PLASTICO COLOR</p> <p>A ALUMINUM / ALUMINIO B BRASS / LATON</p>		<p>FOR: 126®</p>	<p>FOR: AGA®</p>	<p>FOR: CERUTTI®</p>	<p>FOR: CISA®</p>	<p>FOR: CISA®</p>	<p>FOR: CISA®</p>	<p>NE NEON NP NICKEL PLATED / LATON NIQUELADO</p> <p>CM FUN COLOR CK CRISTAL KEYS / PLASTICO COLOR</p> <p>A ALUMINUM / ALUMINIO B BRASS / LATON</p>
		<p>FOR: ATRA®</p>	<p>FOR: BETA®</p>	<p>FOR: CISA®</p>	<p>FOR: CISA®</p>	<p>FOR: CR®</p>	<p>FOR: CR®</p>	

Concerning the marks and commercial denominations see note in index.

Concerniente a las marcas y denominaciones comerciales ver nota en indice.

Concernant les marques et denominations commerciales voir la note dans l'index.

Concerning the marks and commercial denominations see note in index.

Concerniente a las marcas y denominaciones comerciales ver nota en indice.

Concernant les marques et denominations commerciales voir la note dans l'index.

<p>A ALUMINUM / ALUMINIO B BRASS / LATON</p>	<p>CM FUN COLOR CK CRISTAL KEYS / PLASTICO COLOR</p>	<p>NE NEON NP NICKEL PLATED / LATON NIQUELADO</p>	<p>NS N.SILVER / ALPACA S STEEL / ACERO</p>	<p>Z ZAMAK</p>	<p>FOR: CR®</p> <p>CR-4G CR-14G</p>	<p>FOR: EZCURRA®</p> <p>EZ-1G</p>	<p>FOR: FAC®</p> <p>FAC-2G</p>	
					<p>FOR: FIAM®</p> <p>FM-16G</p>	<p>FOR: ISEO®</p> <p>IS-1G</p>	<p>FOR: ITAL®</p> <p>IT-1G</p>	<p>FOR: KALE®</p> <p>KAE-1G</p>

<p>A ALUMINUM / ALUMINIO B BRASS / LATON</p>	<p>CM FUN COLOR CK CRISTAL KEYS / PLASTICO COLOR</p>	<p>NE NEON NP NICKEL PLATED / LATON NIQUELADO</p>	<p>NS N.SILVER / ALPACA S STEEL / ACERO</p>	<p>Z ZAMAK</p>	<p>FOR: LAR®</p> <p>LAR-2G LAR-3G</p>	<p>FOR: MOTTURA®</p> <p>MT-3G MT-6.PG</p>
					<p>FOR: SECUREMME®</p> <p>SEC-2G SEC-7G</p>	<p>FOR: SERRALLER®</p> <p>SER-1G</p>



Concerning the marks and commercial denominations see note in index.

Concerniente a las marcas y denominaciones comerciales ver nota en indice.

Concernant les marques et denominations commerciales voir la note dans l'index.



Concerning the marks and commercial denominations see note in index.

Concerniente a las marcas y denominaciones comerciales ver nota en indice.

Concernant les marques et denominations commerciales voir la note dans l'index.

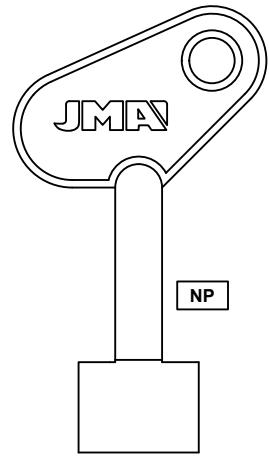
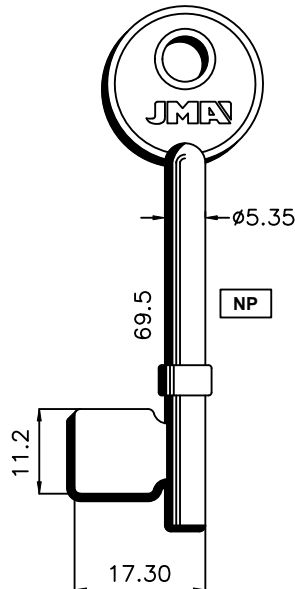
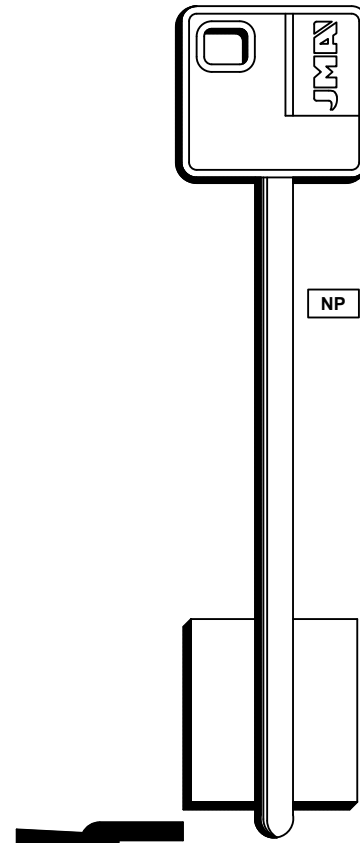
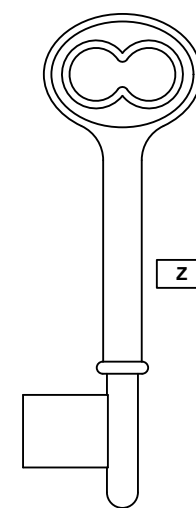
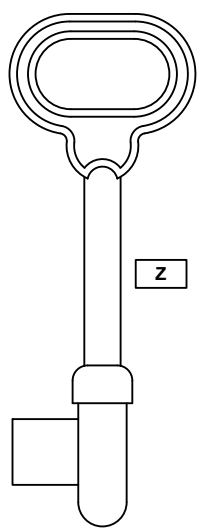

Z ZAMAK	FOR: TOVER®		FOR: UNION®		FOR: YALE®	
						
NS N. SILVER / ALPACA	TOV-1G		UN-1G		YA-4G	
S STEEL / ACERO						
NE NEON	FOR: LOCK®		FOR: PHILLIPS®			
NP NICKEL PLATED / LATON NIQUELADO						
CM FUN COLOR	LOC-3Z		PHI-5Z			
CK CRISTAL KEYS / PLASTICO COLOR	LOC-2Z		PHI-3Z			
A ALUMINUM / ALUMINIO	LOC-1Z		PHI-1Z			
B BRASS / LATON	LOC-4Z		PHI-2Z			
	LOC-6Z		PHI-4Z			
	LOC-5Z		PHI-6Z			

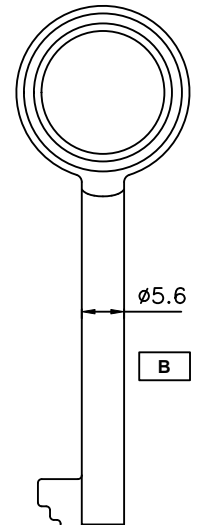
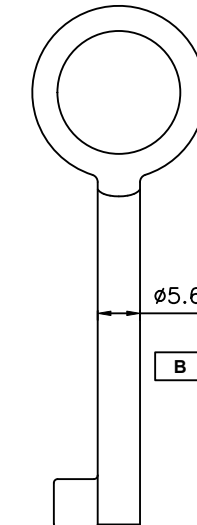
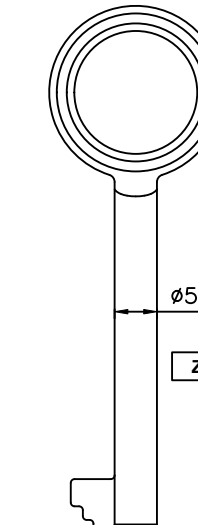
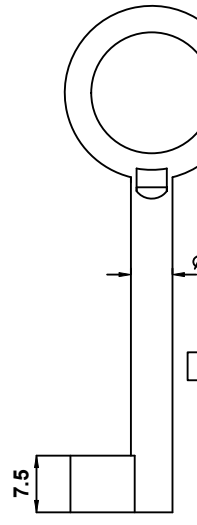
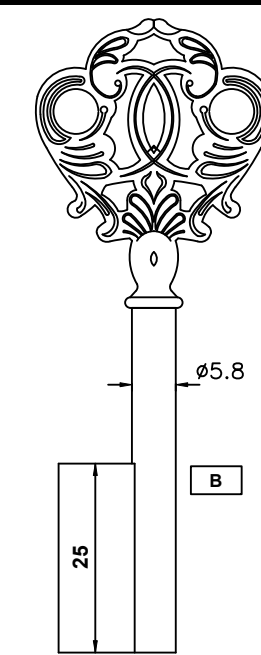
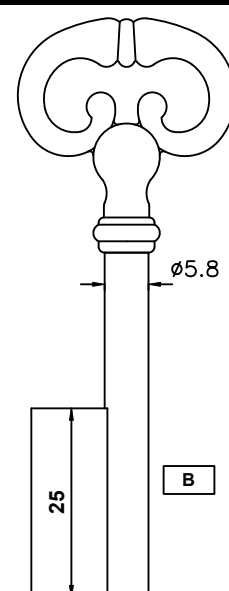
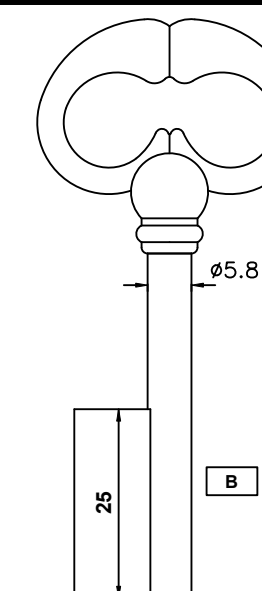
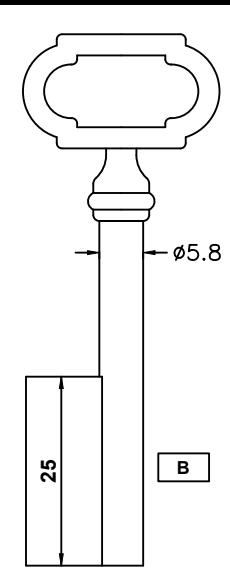
FOR: ROPERO®				FOR: ROPEROS ARTISTICOS®			
							
R-1G		R-2G		R-1Z		A-1G	
FOR: ROPEROS ARTISTICOS®				FOR: ROPEROS ARTISTICOS®			
							
E-3G		J-3G		L-3G		V-3G	



Concerning the marks and commercial denominations see note in index.

Concerniente a las marcas y denominaciones comerciales ver nota en indice.

Concernant les marques et denominations commerciales voir la note dans l'index.



Concerning the marks and commercial denominations see note in index.

Concerniente a las marcas y denominaciones comerciales ver nota en indice.

Concernant les marques et denominations commerciales voir la note dans l'index.





CROSS - SHAPED KEYS

Llaves de cruz
Clés cruciformes

FOR: AUSTRAL [®]		FOR: BURG [®]		FOR: CIFIAL [®]		FOR: DIXON [®]	
FOR: DIXON [®]		FOR: FIAM [®]		FOR: GUARD [®]		FOR: PAPAIZ [®]	

Z ZAMAK
NS N: SILVER / ALPACA
S STEEL / ACERO
NE NEON
NP NICKEL PLATED / LATON NIQUELADO
CM FUN COLOR
CK CRISTAL KEYS / PLASTICO COLOR
A ALUMINIUM / ALUMINIO
B BRASS / LATON

! Concerning the marks and commercial denominations see note in index.

Concerniente a las marcas y denominaciones comerciales ver nota en indice.

Concernant les marques et denominations commerciales voir la note dans l'index.



Z ZAMAK
NS N.SILVER / ALPACA
S STEEL / ACERO
NE NEON
NP NICKEL PLATED / LATON NIQUELADO
CM FUN COLOR
CK CRISTAL KEYS / PLASTICO COLOR
A ALUMINIUM / ALUMINIO
B BRASS / LATON

Z ZAMAK
NS N.SILVER / ALPACA
S STEEL / ACERO
NE NEON
NP NICKEL PLATED / LATON NIQUELADO
CM FUN COLOR
CK CRISTAL KEYS / PLASTICO COLOR
A ALUMINIUM / ALUMINIO
B BRASS / LATON

FOR: PAPAIZ®

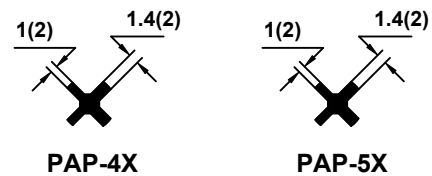
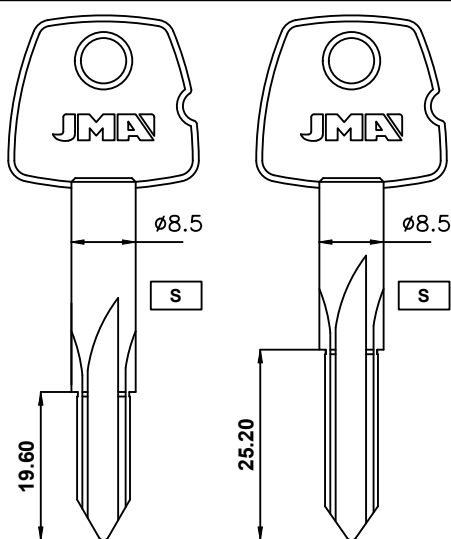

FOR: PHILLIPS®

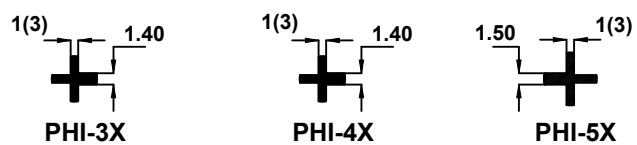
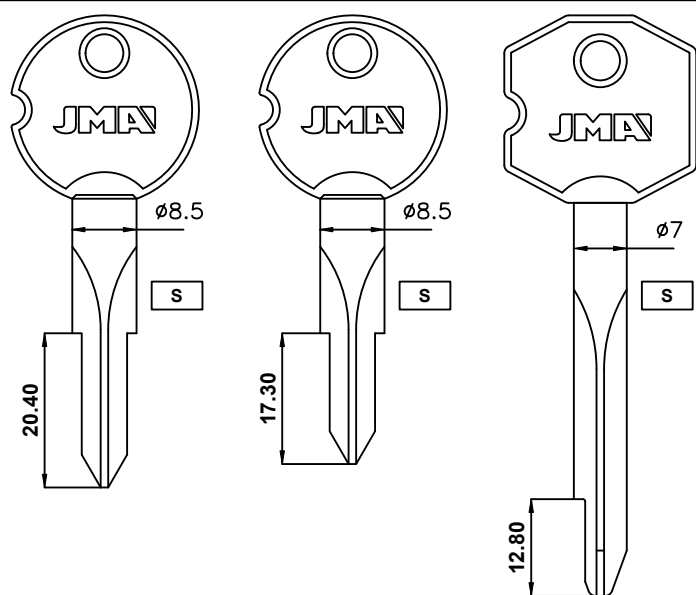

FOR: PHILLIPS®

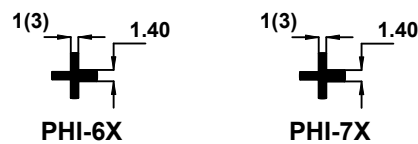
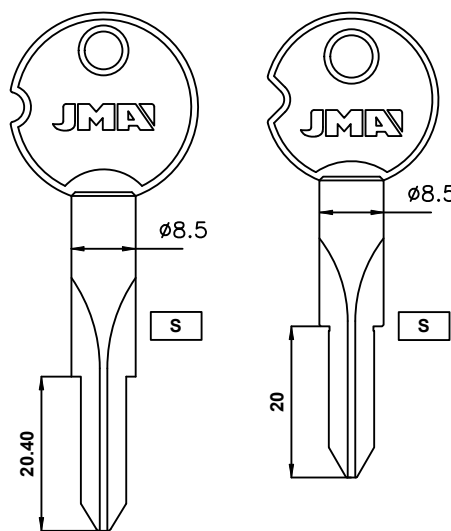

FOR: YALE BKS®

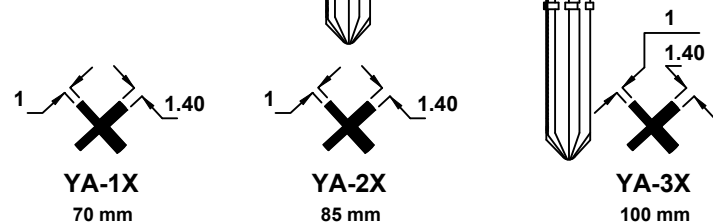
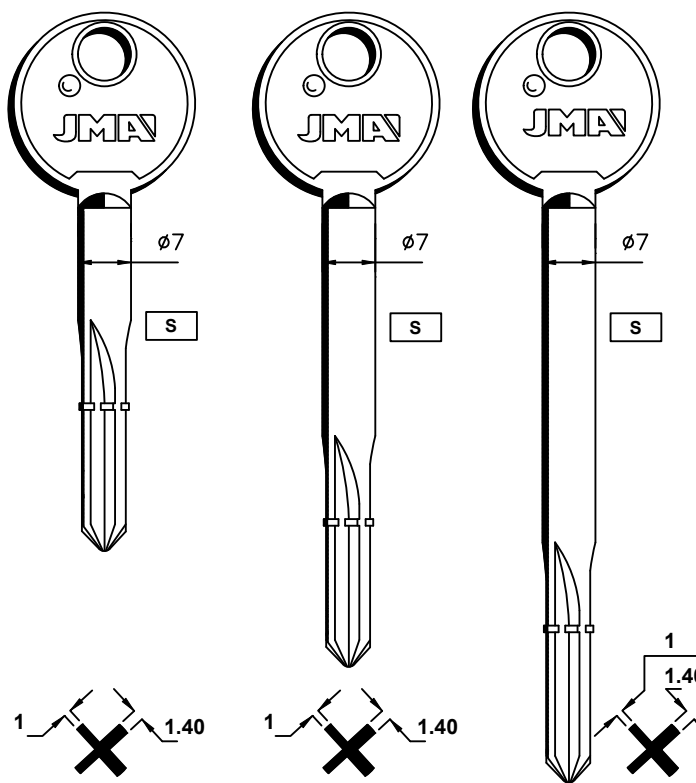

FOR: ZEISS IKON®

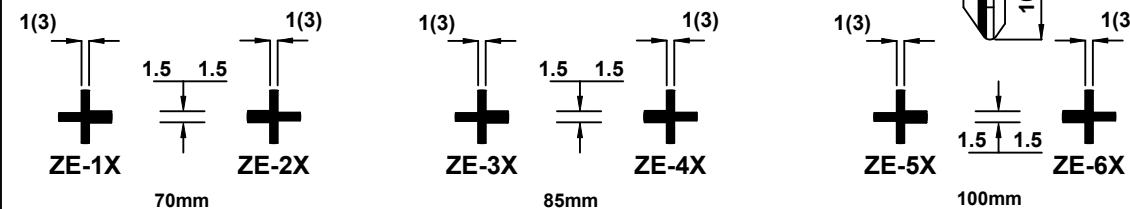
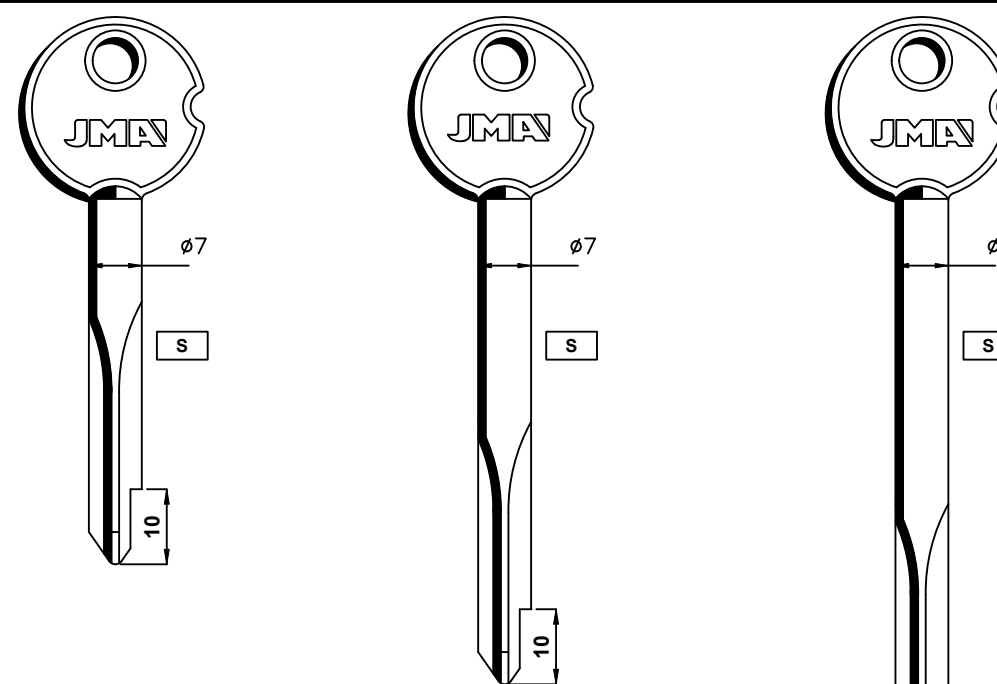

Concerning the marks and commercial denominations see note in index.

Concerniente a las marcas y denominaciones comerciales ver nota en indice.

Concernant les marques et denominations commerciales voir la note dans l'index.



Concerning the marks and commercial denominations see note in index.

Concerniente a las marcas y denominaciones comerciales ver nota en indice.

Concernant les marques et denominations commerciales voir la note dans l'index.





QUICK BLANK LINES

Llaves quick blank
Clés quick blank

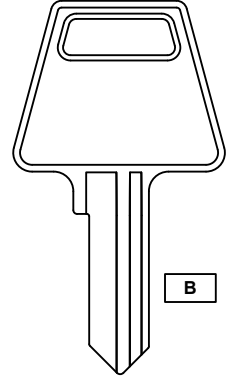
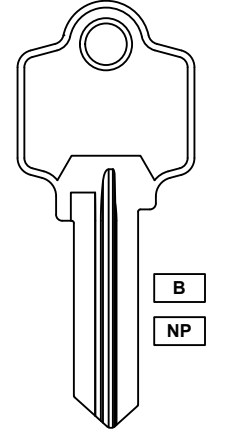
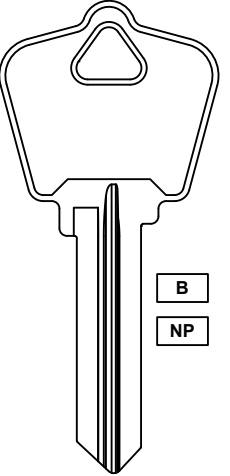
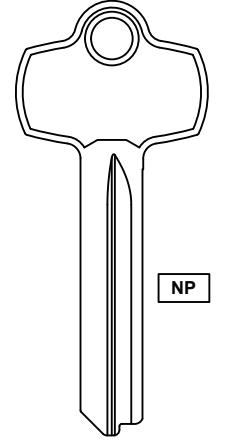
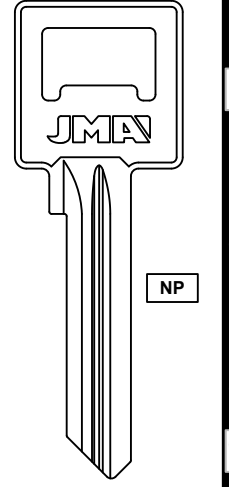
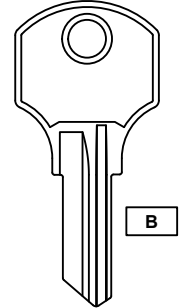
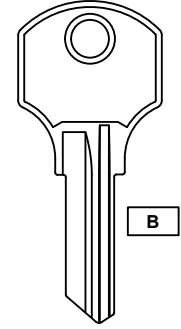
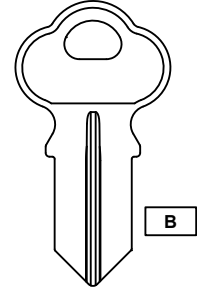
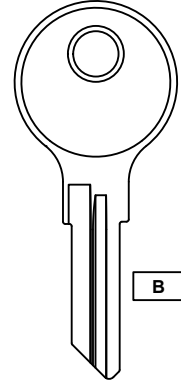
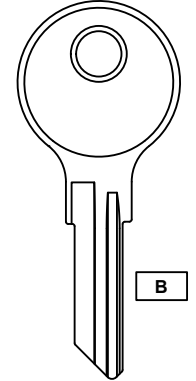
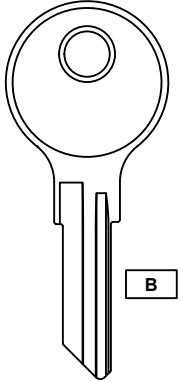
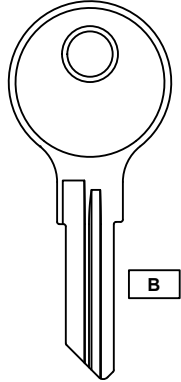
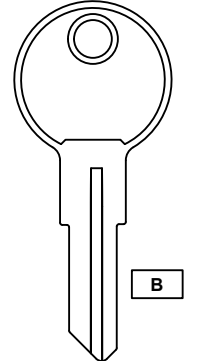
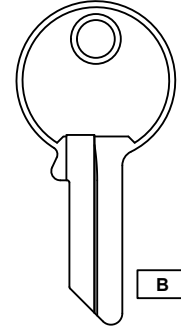
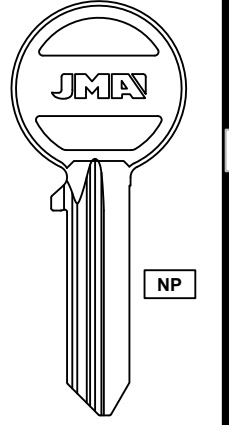
FOR: AMERICAN LOCK [®]		FOR: ARROW [®]		FOR: BEST [®]	FOR: CANTOL [®]
					
AME-1E AM3		ARR-4DE AR1	ARR-5DE AR4	BES-1DE BE2	CTO-3DE
FOR: CCL [®]			FOR: CHICAGO [®]		
					
CCL-11E CO68	CCL-12E CO26	CHI-2E CG1	CHI-7DE AP4	CHI-8DE AP3	
FOR: CHICAGO [®]				FOR: CISA [®]	
					
CHI-9DE AP1	CHI-10DE AP2	CHI-12DE CG16	CHI-13DE CG17	CI-1LE	CI-DLE

Z ZAMAK
 NS N. SILVER / ALPACA
 S STEEL / ACERO
 NE NEON
 NP NICKEL PLATED / LATON NIQUELADO
 FUN COLOR
 CM CRISTAL KEYS / PLASTICO COLOR
 ALUMINUM / ALUMINIO
 BRASS / LATON

! Concerning the marks and commercial denominations see note in index.

Concerniente a las marcas y denominaciones comerciales ver nota en indice.

Concernant les marques et denominations commerciales voir la note dans l'index.



<p>CM CK</p> <p>FUN COLOR CRISTAL KEYS / PLASTICO COLOR</p> <p>NE NP</p> <p>NEON NICKEL PLATED / LATON NIQUELADO</p> <p>NS S</p> <p>N.SILVER / ALPACA STEEL / ACERO</p> <p>Z ZAMAK</p>	FOR: CORBIN®					FOR: ILCO®		FOR: KWIKSET®						
	<p>COR-8E CO87</p> <p>COR-9E CO88</p> <p>COR-56E CO89</p> <p>COR-62E CO7</p> <p>COR-63E CO91</p>					<p>ILC-4DE IN3</p> <p>ILC-7DE IN8</p>		<p>KWI-1KE KW1</p> <p>KWI-2DE KW10</p> <p>KWI-5DE KW11</p>						
	FOR: DEXTER®		FOR: FALCON®		FOR: FANAL®	FOR: FORT®	FOR: FORTE®		FOR: LOCKWOOD®		FOR: LSDA®	FOR: MASTER®		
	<p>DX-5DE DE6</p>		<p>FAL-1DE FA3</p>		<p>FNL-1DE</p>	<p>FR-11DE FR2</p>	<p>FTE-2E</p> <p>FTE-1E</p> <p>FTE-2DE</p> <p>FTE-1DE</p>		<p>LWO-4DE L1</p>		<p>LSD-1DE EZ1</p>	<p>MAS-2DE M21</p> <p>MAS-3DE M12</p> <p>MAS-5DE M11</p>		
	FOR: FORTE®		FOR: HARLOC®		FOR: HUDSON®		FOR: ILCO®		FOR: MASTER®					
	<p>FTE-3E</p> <p>FTE-3DE</p>		<p>HAR-11E EA27</p>		<p>HUD-3E CO106</p> <p>HUD-3DE BO1</p>		<p>ILC-2DE IN33</p>		<p>MAS-7E M2</p> <p>MAS-9E M10</p> <p>MAS-9DE M16</p> <p>MAS-10E M1</p> <p>MAS-13DE M13</p>					
	<p>A B</p> <p>ALUMINUM / ALUMINIO BRASS / LATON</p>		<p>A B</p> <p>ALUMINUM / ALUMINIO BRASS / LATON</p>		<p>A B</p> <p>ALUMINUM / ALUMINIO BRASS / LATON</p>		<p>A B</p> <p>ALUMINUM / ALUMINIO BRASS / LATON</p>		<p>A B</p> <p>ALUMINUM / ALUMINIO BRASS / LATON</p>					

! Concerning the marks and commercial denominations see note in index.

Concerniente a las marcas y denominaciones comerciales ver nota en indice.

Concernant les marques et denominations commerciales voir la note dans l'index.

! Concerning the marks and commercial denominations see note in index.

Concerniente a las marcas y denominaciones comerciales ver nota en indice.

Concernant les marques et denominations commerciales voir la note dans l'index.



Concerning the marks and commercial denominations see note in index.

Concerniente a las marcas y denominaciones comerciales ver nota en indice.

Concernant les marques et denominations commerciales voir la note dans l'index.



Concerning the marks and commercial denominations see note in index.

Concerniente a las marcas y denominaciones comerciales ver nota en indice.

Concernant les marques et denominations commerciales voir la note dans l'index.



Z ZAMAK NS N.SILVER / ALPACA S STEEL / ACERO NE NEON NP NICKEL PLATED / LATON NIQUELADO FUN COLOR CM ALUMINUM / ALUMINIO CK CRISTAL KEYS / PLASTICO COLOR A ALUMINUM / ALUMINIO B BRASS / LATON	FOR: MASTER® MAS-16DE MD17 MAS-18DE M20 MAS-19E M19			FOR: NATIONAL CABINET® NTC-1DE NA14 NTC-7DE RO7		FOR: SCHLAGE® SLG-3E SC1 SLG-4E SC4 SLG-5E SC9 SLG-11E SC8				FOR: SEGAL® SEG-1DE SE1	
	FOR: NATIONAL CABINET® NTC-10DE RO3	FOR: NATIONAL LOCK® NTL-1DE NA25	FOR: NATIONAL ROCKFORD® NTR-2DE NA12	FOR: PAPAIZ® PAP-1E PZ1	FOR: PHILLIPS® PHI-52E	FOR: SKILLMAN® SKI-1DE SK1	FOR: TAYLOR® TAY-3E T7	FOR: TESA® TE-7DE HR2 TE-8IE		FOR: TIMBERLINE® TIM-1DE IL11	
	FOR: RUSSWIN® RUS-4E RU45 RUS-5E RU46		FOR: SARGENT® SAR-2DE S68 SAR-7E S22		FOR: SCHLAGE® SLG-1E SC6	FOR: TRAVEX® TRV-1E TRV-1DE		FOR: VIRO® VI-2IE VR7 VI-13E VI-13DE		FOR: WEISER® WEI-1E WR3 WEI-2E WR4	

Z ZAMAK	NS N.SILVER / ALPACA S STEEL / ACERO	FOR: AMERICAN MOTORS®		FOR: BRITISH LEYLAND®		FOR: CHRYSLER®															
		AMM-3E RA4	AMM-4E B5	BS-10E B1	CHR-8E Y152	CHR-9E Y154	CHR-10E Y155	CHR-12E Y149													
NE NEON NP NICKEL PLATED / LATON NIQUELADO	CM FUN COLOR CK CRISTAL KEYS / PLASTICO COLOR	FOR: CHRYSLER®					FOR: FORD®														
		CHR-14E Y157	CHR-15E Y159	CHR-18E Y153	FO-8DE H67	FO-11DE H60	FO-15DE H75	FO-19E H50	FO-20DE H54	FO-15DE H75	FO-19E H50	FO-20DE H54									
A ALUMINUM / ALUMINIO B BRASS / LATON	CM FUN COLOR CK CRISTAL KEYS / PLASTICO COLOR	FOR: FORD®					FOR: GENERAL MOTORS®					FOR: HONDA®					FOR: MAZDA®				
		B GM-10E B49	D GM-11E B51	H GM-12E B45	GM-14E B86	GM-30E B89	GM-34E B91	GM-36E B92	HOND-10E HD90	HOND-16DE HD103	MAZ-13DE MZ27	B GM-10E B49	D GM-11E B51	H GM-12E B45	GM-14E B86	GM-30E B89	GM-34E B91	GM-36E B92	HOND-10E HD90	HOND-16DE HD103	MAZ-13DE MZ27

Concerning the marks and commercial denominations see note in index.

Concerniente a las marcas y denominaciones comerciales ver nota en indice.

Concernant les marques et denominations commerciales voir la note dans l'index.



Concerning the marks and commercial denominations see note in index.

Concerniente a las marcas y denominaciones comerciales ver nota en indice.

Concernant les marques et denominations commerciales voir la note dans l'index.



Z ZAMAK

NS N SILVER / ALPACA
S STEEL / ACERO

NE NEON
NP NICKEL PLATED / LATON NIQUELADO

FUN COLOR
CM CRISTAL KEYS / PLASTICO COLOR

CM CK

A ALUMINUM / ALUMINIO
B BRASS / LATON

FOR: MITSUBISHI[®]

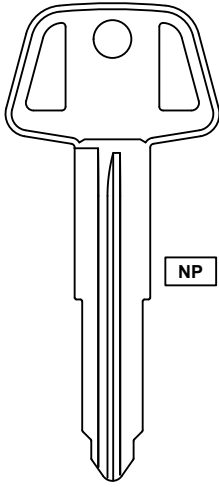

NP

MIT-14DE
MIT3

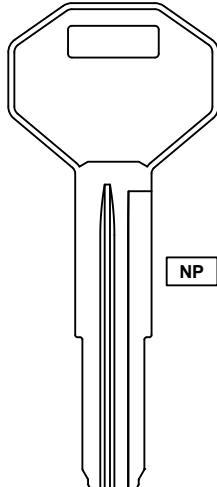

NP

MIT-16E
MIT1

FOR: OPEL[®]

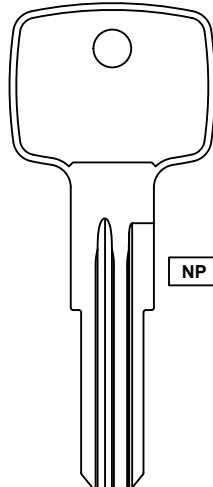

NP

OP-SE
B61

OP-DE

FOR: TOYOTA[®]

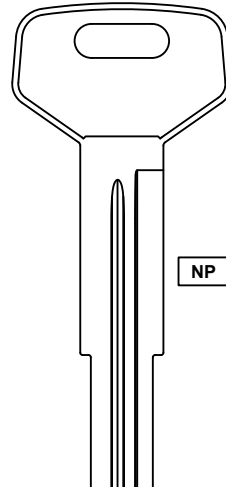

NP

TOYO-10E
TR39

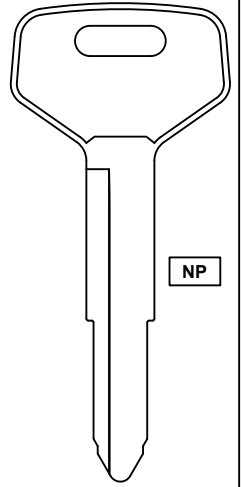

NP

TOYO-12E
TR33

FOR: TOYOTA[®]

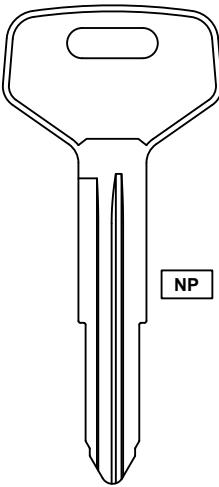

NP

TOYO-13E
TR37

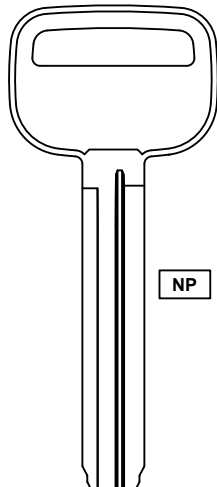

NP

TOYO-15E
TR47

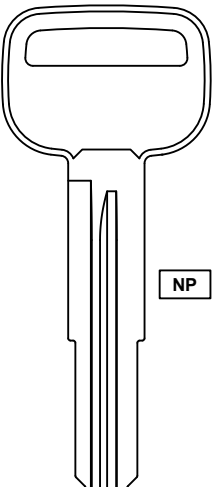

NP

TOYO-17E
TR53

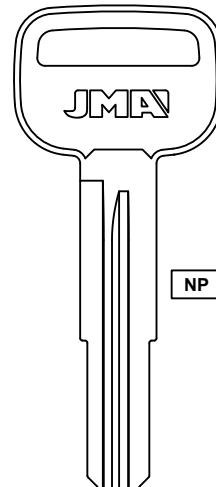

NP

TOYO-17E1
TR53

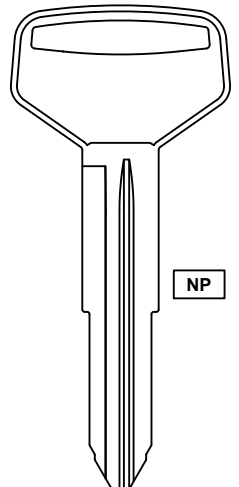

NP

TOYO-20DE
TR40



Concerning the marks and commercial denominations see note in index.

Concerniente a las marcas y denominaciones comerciales ver nota en índice.

Concernant les marques et dénominations commerciales voir la note dans l'index.



Guide

**USER GUIDE FOR THIS CATALOGUE.
BRAND INDEX**

Guía de uso de este catálogo.
índice de marcas

Guía de uso de este catálogo.
índice de marcas

Legal warning

Aviso legal Mentions Legales IMPRESSUM



GENERAL CATALOGUE MX C.13

The keys that appear in this catalogue are JMA parts manufactured by Alejandro ALTUNA S.A. or one of its subcontractors. They are designed for cylinders and locks made by the manufacturers whose trademarks are indicated in this catalogue. In accordance with legal requirements relating to industrial property rights, the trademarks or trade names indicated in this catalogue are the exclusive property of the manufacturers of the cylinders and locks, as well as automobile manufacturers, other constructors, distributors and users. The aforementioned trademarks or trade names are indicated simply for information purposes so that the lock to which our parts correspond can be recognised quickly and easily.

This catalogue is for the exclusive use of professional key copiers who use JMA parts. Data referring to the products in this catalogue are indicative in nature. Although the basic characteristics are maintained at all times, we reserve the right to make, without previous notice, any technical, aesthetic or other types of changes involved in the development of the products in question. Some of the keys in this new catalogue could be received either with the JMA reference and trademark or with another trademark from the ALTUNA group.

CATÁLOGO GENERAL MX C.13

Las llaves que aparecen en este catálogo son piezas JMA fabricadas por Alejandro ALTUNA S.A. o un subcontratista de éste. Están diseñadas para cilindros y cerraduras de los fabricantes cuyas marcas se indican en este catálogo. Conforme a las disposiciones legales vigentes relativas a la propiedad industrial, las marcas o nombres comerciales indicados en este catálogo son propiedad exclusiva de los fabricantes de cilindros y cerraduras, así como de los fabricantes de automóviles, otros constructores, distribuidores y usuarios. Dichas marcas o nombres comerciales se indican en calidad simplemente informativa con el fin de reconocer con rapidez la cerradura a la que corresponden nuestras piezas.

Este catálogo está reservado exclusivamente a profesionales de la reproducción de llaves que utilizan piezas JMA. Los datos referentes a los productos de este catálogo tienen carácter indicativo. Manteniendo siempre las características básicas, nos reservamos el derecho de realizar, sin previo aviso, modificaciones técnicas, estéticas o de otro tipo, por razones de evolución de los productos en cuestión. Algunos modelos que están en este nuevo catálogo podrán recibirlos tanto con la marca y la referencia JMA como con otra marca del grupo ALTUNA.

CATALOGUE GENERALE MX C.13

Les ébauches de clés reportées sur ce catalogue sont des ébauches JMA fabriquées par Alejandro ALTUNA S.A. ou un de ses sous-traitants. Elles sont destinées aux cylindres et serrures des fabricants dont les marques sont indiquées dans ce catalogue. Conformément aux dispositions légales en vigueur relatives à la propriété industrielle, les marques ou les dénominations commerciales citées dans ce catalogue sont la propriété exclusive des fabricants de cylindres et de serrures ainsi que des constructeurs de voitures, autres constructeurs, distributeurs et utilisateurs. Ces marques ou dénominations commerciales sont indiquées à titre de simple information afin de connaître rapidement à quelle serrure nos ébauches sont destinées.

Ce catalogue est exclusivement réservé aux professionnels de la reproduction de clés, utilisant des ébauches JMA. Les renseignements sur les produits de ce catalogue sont donnés à titre indicatif. Tout en gardant les caractéristiques de base, nous nous réservons le droit d'apporter, sans préavis, des modifications techniques, esthétiques ou autres, dues à l'évolution des produits en question. Des ébauches de ce catalogue pourront être livrées soit avec la marque et référence JMA soit avec une autre marque du groupe ALTUNA.

IDENTIFICACIÓN DE LLAVES POR APARIENCIA

All the keys in this catalogue are 1:1 scale; both the silhouette outline and profile, to facilitate a precise search.

Steps to follow for identifying the key:

1. IDENTIFICATION OF THE SILHOUETTE
2. IDENTIFICATION OF THE PROFILE

Make sure the profile of the catalogue has the same shape and dimension, by placing the physical key over the image in the catalogue.

IDENTIFICACIÓN DE LLAVES POR APARIENCIA

Todas las llaves del catálogo están en escala 1:1; tanto la silueta como el perfil, para hacer una búsqueda más fácil y precisa.

Pasos a seguir para la identificación de la llave:

1. IDENTIFICACIÓN DE LA SILUETA
2. IDENTIFICACIÓN DEL PERFIL

Cerciorar que el perfil del catálogo tiene la misma forma y dimensión, colocando la llave física sobre la imagen del catálogo.

IDENTIFICACIÓN DE LLAVES POR APARIENCIA

Toutes les clés du catalogue sont à l'échelle 1:1; aussi bien la silhouette que le profil, afin de permettre une recherche plus simple et précise.

Étapes à suivre pour l'identification de la clé :

1. IDENTIFICATION DE LA SILHOUETTE
2. IDENTIFICATION DU PROFIL

S'assurer que le profil du catalogue a la même forme et les mêmes dimensions, en plaçant la clé physique sur l'image du catalogue.

User Manual

Manual de uso Manuel d'utilisation

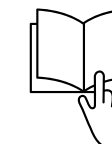

1. IDENTIFICATION OF THE SILHOUETTE

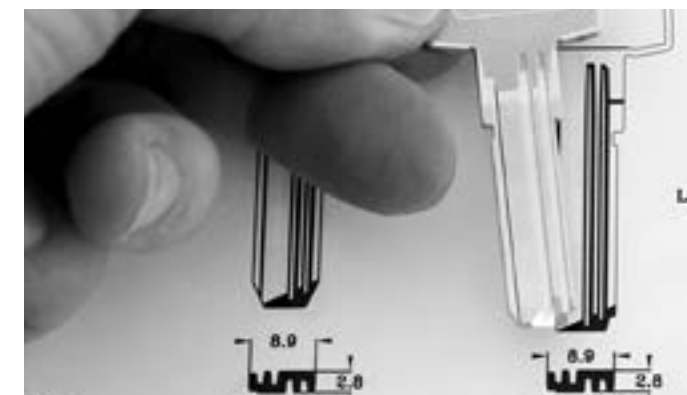

2. IDENTIFICATION OF THE PROFILE



Description

Descripción
Description

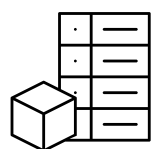

TERMINOLOGY

1. MAIN BRAND
2. HEAD
3. NECK
4. SHOULDER
5. BLADE
6. TIP
7. USE
8. ORIGINAL PROFILE
9. LEFT PROFILE
10. RIGHT PROFILE
11. REFERENCE
12. SECONDARY BRAND
13. SERIES
14. MAIN BRAND AND NATIONALITY
15. SECONDARY BRANDS OF THE MAIN ONE (ABSA)

TERMINOLOGÍA

1. MARCA PRINCIPAL
2. CABEZA
3. CUELLO
4. TOPE
5. PALETÓN
6. PUNTA
7. UTILIZACIÓN
8. NOMENCLATURA DE PERFIL ORIGINAL
9. PERFIL IZQUIERDO
10. PERFIL DERECHO
11. REFERENCIA
12. MARCAS SECUNDARIAS
13. SERIES
14. MARCA PRINCIPAL
15. MARCAS SECUNDARIAS DE LA PRINCIPAL (ABSA)

TERMINOLOGIE

1. MARQUE PRINCIPALE
2. TÊTE
3. COU
4. ARRÊT
5. CANON
6. POINTE
7. UTILISATION
8. PROFIL ORIGINAL
9. PROFIL GAUCHE
10. PROFIL DROIT
11. RÉFÉRENCE MARQUE
12. SECONDAIRE
13. CODE
14. MARQUE PRINCIPALE ET NATIONALITÉ
15. MARQUES SECONDAIRES DE LA PRINCIPALE (ABSA)

(NS)

Key available in nickel silver
Llave fabricada en alpaca
Clé fabriquée en maillechort

(B).

Key also available in brass
Llave disponible también en latón
Clé aussi disponible en laiton

(CM).

Available with Funcolor
Disponible con Funcolor
Disponible avec Funcolor

(A).

Key also available in aluminium
Llave disponible también en aluminio
Clé aussi disponible en aluminium

(NP).

Key available in nickel plated
Llave disponible en latón niquelado
Clé aussi disponible en laitonnickele

(CK).

Key also available in coloured plastic
Llave disponible en plástico de color
Clé aussi disponible en plastique

(S).

Key available in steel
Llave disponible en acero
Clé fabriquée en acier

(Z).

Key available in zamak
Llave disponible en zamak
Clé fabriquée en zamak

(NE)

Available with Neón
Disponible con Neón
Disponible avec Neón

Symbol and codes

Símbolos y códigos
Symboles et codes

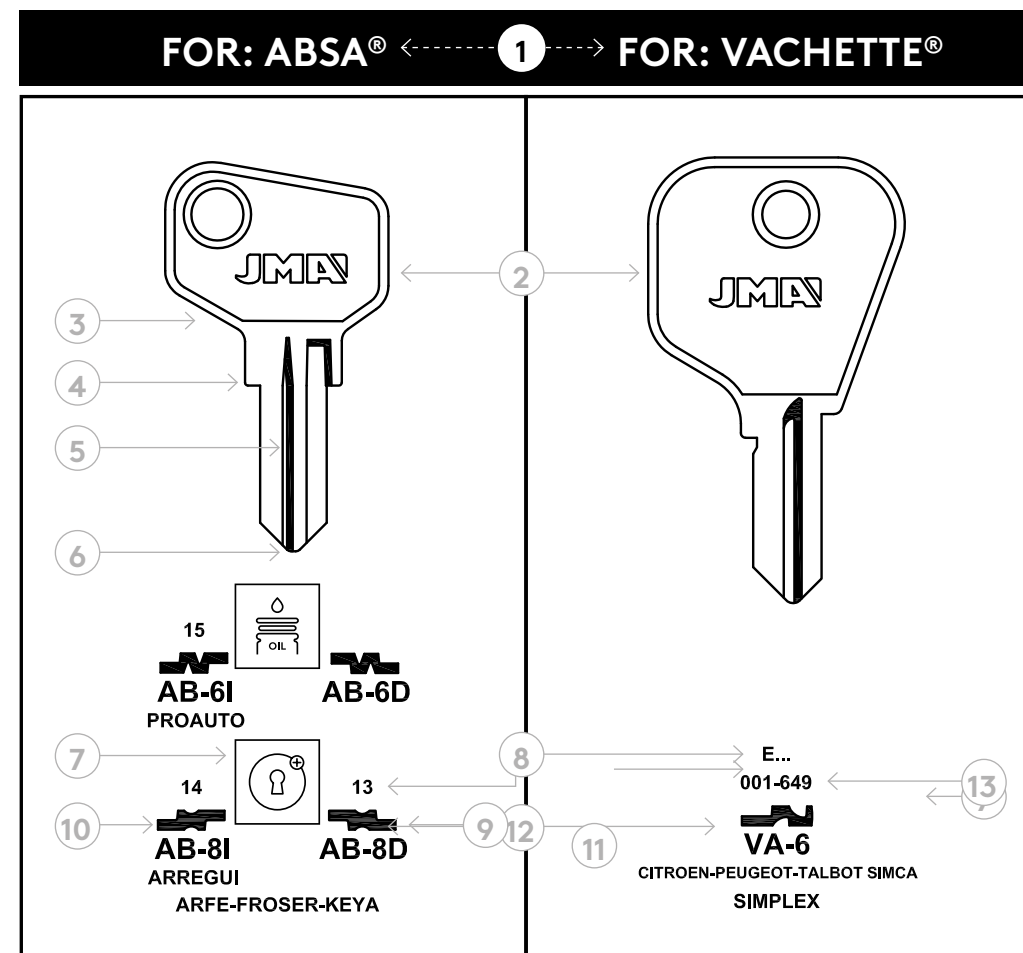

Guide

BENCHMARK INDEX

Índice de referencias

Index des références

Índice de referencias
Index des références

REF.	PAG.	REF.	PAG.	REF.	PAG.	REF.	PAG.	REF.	PAG.
4G	189	ACA-6D	88	AME-4	87	AS-22	90	AS-P7	90
15G	189	ACA-7D	89	AME-5	88	AS-24D	51	AS-RC7	90
21G	189	AF-1D	52	AME-6	87	AS-A5	89	AS-S7	90
23G	189	AF-1I	52	AME-7	87	AS-A7	90	AS-T5	90
25G	189	AF-4D	1	AME-8	87	AS-AK5	90	AS-T7	90
26-M	185	AF-4I	1--42	AME-9	88	AS-AK7	90	AS-U5	90
57G	189	AF-5D	1	AMG-8D	171	AS-AL5	90	AS-U7	90
74G	189	AF-5I	1	AMG-9D	171	AS-AL7	90	AS-V5	90
224G	189	AF-6D	1	AMG-10	171	AS-AM5	90	AS-V7	90
225G	190	AF-6I	1	AMG-10D	171	AS-AM7	90	AS-W5	90
1252G	190	AF-7I	12	AMM-1	19	AS-B5	89	AS-W7	90
126H-60G	190	AF-13	1	AMM-2	2	AS-B7	90	AS-X7	90
A		AF-14.P	1	AMM-3	2	AS-BK5	90	AS-Z7	90
A-1G	195	AG-8D	87	AMM-3E	212	AS-BK7	90	ASH-1	89
AB-1D	85	AG-8I	87	AMM-4	2-32-117	AS-BL7	90	ASH-2	172
AB-6I	85	AG-10D	87	AMM-4E	212	AS-BM7	90	ASH-3D	172
ABL-1	85	AG-10I	87	ANA-1	88	AS-D7	90	ASH-4	89
ABL-2	85	AG-11	87	AND-1D	171	AS-DD7	90	ASH-5	172
ABL-3	85	AG-11D	87	ANK-1	88	AS-DK5	90	ASH-6D	172
ABL-4	85	AGA-1T	86	ANK-2	88	AS-DK7	90	ASH-7D	172
ABL-5	85	AGA-2T	86	ANK-3	88	AS-DL5	90	ASH-8	172
ABU-1	85	AGA-4D	86	ANK-4	88	AS-DL7	90	ASH-9D	172
ABU-1D	85	AGA-5D	86	ANV-1D	88	AS-DM5	90	ASI-1	89
ABU-2D	85	AGA-5I	86	ANV-2	88	AS-DM7	90	ATR-2G	190
ABU-2I	85	AGA-6D	86	ANV-3D	88	AS-E5	89	AU-1	3
ABU-3	123	AGA-6G	190	ANV-4D	88	AS-E7	90	AU-AH	3
ABU-4D	148	AGA-6I	86	ANV-5	88	AS-EK5	90	AU-AH.P	3
ABU-4I	148	AGA-9I	86	ANV-6D	88	AS-EK7	90	AU-AH.P1	4
ABU-12I	85	AGA-10	86	AP-1D	171	AS-EL5	90	AU-AN	58
ABU-14	85	AGA-11	86	ARO-1D	89	AS-EL7	90	AU-C	4
ABU-16	171	AGA-12	171	ARO-2	89	AS-EM5	90	AU-HV	4
ABU-20	85	AGA-18D	86	ARR-1	108	AS-EM7	90	AU-HV.P1	4
ABU-22D	85	AGA-18I	86	ARR-2	108--112	AS-F5	89	AU-W	4
ABU-23D	85	AGA-19D	86	ARR-3	89	AS-F7	90	AUS-1	90
ABU-27D	85	AGA-19I	86	ARR-4D	89	AS-FK5	90	AUS-1X	199
ABU-28	85	AGA-38	171	ARR-4DE	205	AS-FK7	90	AUS-2	90
ABU-29.P	85	AGA-50	171	ARR-5D	89	AS-FL7	90	AUS-2X	199
ABU-34	171	AGB-1	87	ARR-5DE	205	AS-FM7	90	AUS-3	90
ABU-40	85	AGB-1D	87	ARR-6D	89	AS-G5	89	AUS-4	90
ABU-42	85	AGB-2	171	ARR-7D	89	AS-G7	90	AUS-5	91
ABU-42D	85	AGE-2D	87	ARR-9D	89	AS-GK5	90	AUS-6	91
ABU-50	86	AKI-1D	171	ARR-10	89	AS-GK7	90	AUS-6D	91
ABU-51D	86	AKI-2D	171	ARR-11	89	AS-GL5	90	AUS-7D	91
ABU-56	86	ALC-1D	87	ARR-12	89	AS-GL7	90	AUS-8	91
ABU-60	86	ALC-2D	87	ARR-13	89	AS-GM5	90	AUT-1D	91
ABU-81	171	ALF-39D	171	ARR-14	89	AS-GM7	90	AVC-1T	91
ABU-90	86	ALI-1	99	ARR-15	89	AS-H7	90	AZ-3D	91
ABU-95	86	ALP-3	87	ARR-16	89	AS-HH7	90	AZ-3I	91
ABU-97	86	ALP-5D	87	ARR-17	89	AS-K7	90	AZ-8D	172
ABU-98	86	ALS-1	87	ARR-18	89	AS-L7	90	AZ-9	172
AC-12	185	AMC-1	87	ARR-19	89	AS-M5	89	AZ-9D	172
ACA-1D	88	AMC-1D	87	ARR-20	89	AS-M7	90	AZ-12	172
ACA-2D	88	AME-1	87	ARR-21	89	AS-N5	89	AZ-14	172
ACA-3D	88	AME-1E	205	ARR-22	89	AS-N7	90	AZ-17D	91
ACA-4D	88	AME-2	87	ARR-23	89	AS-NN7	90	B	
ACA-5D	88	AME-3	87	AS-1D	51	AS-P5	89	BAJ-1	69

REF.	PAG.	REF.	PAG.	REF.	PAG.	REF.	PAG.	REF.	PAG.
BAJ-1.P	69	BH-4	6	BS-10	6--19	CCL-19	96	CE-101D	97
BAJ-2.P	69	BH-5	6	BS-10E	212	CCL-20	96	CE-110	97
BAJ-2.P2	69	BIL-1T	93	BS-11	6	CCL-21	96	CE-114	173
BAJ-2.P3	69	BIM-1	172	BS-12	6	CCL-22	96	CE-131D	98
BAJ-2D.P	69	BK-1D	93	BU-1D	94	CCL-23	96	CE-134	98
BAJ-3.P	69	BK-19/10	93	BU-1I	94	CCL-24	96	CEM-BP	57
BAJ-3.P1	69	BK-19/11	93	BUE-1	91	CCL-25	96	CEM-JC	6
BAJ-4.P	69	BK-19/12	93	BUE-1D	91	CCL-26	95	CENT-1D	97
BAJ-5.P	69	BK-19/13	93	BUE-2	92	CCL-26D	95	CENT-1I	97
BAL-1	91	BK-19/15	93	BUE-3	92	CCL-27	95	CENT-2D	97
BAL-2	91	BK-19/16	93	BUE-4.P	92	CCL-28D	95	CENT-3D	97
BAS-2I	8	BK-19/19	93	BUL-1	172	CCL-29	95	CF-1D	99
BAST-1I	91	BK-19/20	93	BUR-1D	93	CCL-29D	95	CF-1I	99
BDA-1	172	BK-19/21	93	BUR-1I	93	CCL-30D	95	CHI-1	12--98
BDA-2.P	172	BK-19/23	93	BUR-2D	93	CCL-31D	95	CHI-1T	7-69-70-98-112
BE-4D	92	BK-19/25	93	BUR-2I	93	CCL-32	95	CHI-2	12--98
BE-4I	92	BK-19/26	93	BUR-4X	199	CCL-32D	95	CHI-2E	205
BE-5D	92	BK-19/27	93	BUR-8D	93	CCL-33D	95	CHI-3	48--98
BE-5G	190	BK-19/31	93	BUR-12	94	CCL-34D	95--117	CHI-4	48--98
BE-5I	92	BK-19/32	93	BUR-13D	94	CCL-35D	95	CHI-5	98
BEL-1	92	BKY-1	178	BUR-28	94	CCL-36	96	CHI-7D	98
BES-1DE	205	BKY-2	178	BUR-29D	94	CCL-37	96	CHI-7DE	205
BES-1DS	92	BL-1D	11--44	C		CCL-38	96	CHI-8D	98
BES-2DS	92	BL-1I	11--44	CA-1I	95	CCL-39	96	CHI-8DE	205
BES-3DS	92	BM-2	4	CA-2I	95	CCL-40	96	CHI-9D	98
BES-4DS	92	BM-2.P	4	CA-3I	95	CCL-41	96	CHI-9DE	205
BES-5DS	92	BM-3	4	CA-4D	95	CCL-42	96	CHI-10D	98
BES-6DS	92	BM-4	5	CA-4I	95	CE-1D	97	CHI-10DE	205
BES-7DS	92	BM-5.P	5	CA-5I	95	CE-1I	97	CHI-11	98
BES-8DS	92	BM-6.P	5	CA-15I	95	CE-2D	97	CHI-12	98
BES-9DS	92	BM-B	5	CAM-1D	76	CE-2I	97	CHI-12D	19--98--117
BES-10DS	92	BM-HB	5--69	CAT-1D	7	CE-3D	97	CHI-12DE	205
BES-11DS	92	BM-HB.P	5--69	CAT-1.P1S	7	CE-3I	97	CHI-13D	98
BES-12DS	92	BM-NB.P1	5	CAT-2	7	CE-4D	97	CHI-13DE	205
BES-13DS	92	BM-NB	5	CAT-3	7	CE-5	97	CHI-14	98
BES-14DS	92	BM-NB.P	5	CAY-2	173	CE-5D	97	CHI-15D	98
BES-15DS	92	BM-W	5	CCL-1	95	CE-6D	97	CHI-16D	98
BES-16DS	92	BOB-1D	5	CCL-1D	95	CE-6I	97	CHI-17D	98
BES-17DS	92	BRE-1	93	CCL-2	95	CE-50	97	CHI-18	98
BES-19DS	92	BRE-1D	93	CCL-2D	95	CE-55	97	CHI-19D	98
BES-21DS	92	BRE-2	93	CCL-3	95--131	CE-56	97	CHI-20	98
BES-22DS	92	BRG-1	91	CCL-3D	95	CE-57	97	CHI-21	98
BES-23DS	92	BRG-2D	91	CCL-5D	95	CE-77	97	CHI-21D	98
BES-24DS	92	BRG-3	91	CCL-10	96	CE-78	97	CHI-22	98
BES-26DS	92	BRG-4D	91	CCL-11	95--117	CE-79	97	CHI-22D	98
BES-27DS	92	BRG-5D	91	CCL-11D	95	CE-80	97	CHI-23	98
BES-28DS	92	BRI-1D	93	CCL-11E	205	CE-81	97	CHI-24	98
BES-29S	92	BRS-2	93	CCL-12	95	CE-82	97	CHI-25	98
BES-30S	92	BRU-1D	93	CCL-12D	95	CE-83	97	CHI-25D	98
BES-31DS	92	BS-1I	2	CCL-12E	205	CE-84	97	CHI-26	98
BES-32DS	92	BS-7	39	CCL-13D	95	CE-85	97	CHI-26D	98
BES-33DS	92	BS-7D	39	CCL-14	96	CE-86	97	CHI-27	98
BEY-2D	172	BS-8	39	CCL-15	96	CE-87	97	CHI-29	99
BH-1	6	BS-8D	39	CCL-16	96	CE-88	97	CHI-30	99
BH-2	6	BS-9	39	CCL-17	96	CE-99D	97	CHI-30D	99
BH-3	52	BS-9D	39	CCL-18	96	CE-100D	97	CHI-31	99

Índice de referencias
Index des références

REF.	PAG.	REF.	PAG.	REF.	PAG.	REF.	PAG.	REF.	PAG.
CHI-31D	99	CI-14	173	CMX-10D	97	COR-61	102	COR-134D	104
CHI-32D	99	CI-17	173	CN-1D	8	COR-62	102	COR-135D	104
CHI-33D	99	CI-20	99	CN-2D	8	COR-62E	206	COR-136D	104
CHI-34	99	CI-21	173	CNP-1	94	COR-63	102	COR-137D	104
CHI-35	48-98	CI-22D	99	CNP-2D	94	COR-63E	206	COR-138D	100
CHL-1	98	CI-24	99	CNP-3	94	COR-81	102	COR-139	103
CHL-2	98	CI-25	173	CNP-4	94	COR-82	102	COR-140	103
CHL-3	98	CI-26	173	CNP-4D	94	COR-83	102	COR-141	103
CHL-4	98	CI-28	99	CNP-5	94	COR-84	101	COR-142	103
CHL-5	98	CI-28D	99	CNP-6D	94	COR-85	101	COR-143	103
CHL-6	98	CI-40	99	CO-1D	104	COR-86	102	COR-144	103
CHL-7	98	CI-48	173	CO-M	104	COR-87	102	COR-145	103
CHL-8	98	CI-57	173	COR-1D	100	COR-88	102	COR-146	103
CHL-9	98	CI-59	173	COR-1I	100	COR-89	102	COR-147	103
CHL-10	98	CI-73	173	COR-3	100	COR-90	102	COR-148	103
CHR-3	52	CI-DEL	205	COR-7	100	COR-91	102	COR-149	103
CHR-4D	10	CI-DL	99	COR-8	100	COR-92	102	COR-150	103
CHR-7	8	CI-IL	99	COR-8E	206	COR-93	102	COR-151	103
CHR-7.P	8	CI-ILE	205	COR-8S	100	COR-94	102	COR-152	103
CHR-8	8	CI-IX	199	COR-9	100	COR-95	102	COR-153	103
CHR-8.P	8	CL-5D	12	COR-9D	100	COR-96	102	COR-154D	100
CHR-8E	212	CLB-1	11	COR-9E	206	COR-97	102	COR-155D	100
CHR-9	8	CLB-1D	11	COR-9S	100	COR-98	102	COR-156	101
CHR-9.P	8	CLB-2	11	COR-10	100	COR-99	102	COR-157D	101
CHR-9E	212	CLB-2D	11	COR-11	100	COR-100	102	COR-158	101
CHR-10	8	CLB-3	11	COR-11D	100	COR-101	102	COR-159D	101
CHR-10.P	8	CLB-3D	11	COR-12	100	COR-102	102	COR-160	101
CHR-10E	212	CLB-4	11	COR-13	100	COR-103	102	COR-161D	101
CHR-11	8	CLB-4D	11	COR-15D	100	COR-104	102	COR-162	101
CHR-12	8	CLB-5	11	COR-16D	100	COR-105	102	COR-163	101
CHR-12E	212	CLB-5D	11	COR-17D	100	COR-106	102	COR-164	101
CHR-13D	8	CLB-6	11	COR-20	100	COR-107	102	COR-165D	101
CHR-14	9	CLB-7	11	COR-20D	100	COR-108	102	COR-166D	101
CHR-14.P	9	CLB-7D	11	COR-25I	100	COR-109	102	COR-167D	101
CHR-14E	212	CLB-8	11	COR-27D	100	COR-110	102	COR-168	101
CHR-15	9	CLB-8D	11	COR-29D	101	COR-111D	101	COR-169	101
CHR-15.P	9	CLB-9	11	COR-30	101	COR-112	101	COR-170	101
CHR-15E	212	CLB-9D	11	COR-32	101	COR-113	101	COR-171D	101
CHR-16	9	CLF-1	185	COR-33	101	COR-116S	102	COR-172D	101
CHR-17	9-39	CLI-1D	19	COR-34	101	COR-117S	102	COR-173D	101
CHR-18	9	CLN-1	100	COR-40	101	COR-118S	102	COR-174	101
CHR-18E	212	CLU-1I	11	COR-41D	101	COR-119S	102	COR-175	102
CHU-1D	99	CLU-2	11	COR-42	101	COR-120S	102	COR-176D	102
CI-1D	99	CLU-3	11	COR-43D	101	COR-121S	102	COR-177D	102
CI-1G	191	CLU-4	11	COR-44	101	COR-122S	102	COR-178D	102
CI-2G	191	CLU-5	11	COR-45	101	COR-123S	102	COR-179	103
CI-3G	191	CML-1	94	COR-46	101	COR-124D	103	COR-180	103
CI-4D	99	CMX-1D	96	COR-47	101	COR-125D	103	COR-181	103
CI-4DP	99	CMX-2D	96	COR-50/60	101	COR-126D	103	COR-182	103
CI-4I	99	CMX-3D	96	COR-55D	101	COR-127D	103	COR-183	103
CI-4IP	99	CMX-4D	96	COR-56	102	COR-128D	103	COR-184	103
CI-5.PG	191	CMX-5D	96	COR-56E	206	COR-129D	103	COR-185	103
CI-5DP	99	CMX-6D	96	COR-57	102	COR-130D	103	COR-186	103
CI-5IP	99	CMX-7D	96	COR-58	102	COR-131D	104	COR-187	103
CI-6.PG	191	CMX-8D	97	COR-59	102	COR-132D	104	COR-188	103
CI-6G	191	CMX-9D	97	COR-60	102	COR-133D	104	COR-189	103

REF.	PAG.	REF.	PAG.	REF.	PAG.	REF.	PAG.	REF.	PAG.
COR-190	103	DAE-2D	11	DAT-21D	44	DX-5	105	ENG-1	109
COR-191	103	DAE-2D.P	11	DAT-22	44	DX-5D	105	ER-1D	109
COR-192	103	DAE-3.P2	12	DAT-22.P	44	DX-5DE	206	ESP-1	109
COR-193	103	DAE-3.P4	12	DAT-23	44	DX-5DS	105	ESP-2D	109
COR-194	103	DAE-3D	11	DAT-24	44	DX-6	105	ESP-3D	109
COR-195	103	DAE-3D.P1	11	DAV-1	34	DX-6D	105	EU-1	109
COR-196	103	DAE-3D.P2	12	DEK-13	105	DX-7D	105	EUB-2D	109
COR-197	103	DAE-3D.P4	12	DIA-1	106	DX-8	173	EUL-1	174
COR-198	103	DAE-4.P1	11	DIA-4	106	DX-9	173	EUL-1D	174
COR-199	103	DAE-4D.P1	11	DIE-1	185	DX-10	105	EUL-2	174
COR-200	103	DAE-5.P	12	DIM-1D	106	DX-11D	173	EV-1	110
COR-201	104	DAF-1	105	DIX-1D	106	DX-12D	105	EV-2	110
COR-202	104	DAF-1D	105	DIX-1X	199	DX-13	105	EV-3D	110
COR-203	104	DAF-5D	173	DIX-2X	199	DX-14	106	EV-3I	110
COR-204	104	DAI-1.P	20	DIX-4	106	DX-15	106	EVE-6	109
COR-205	104	DAI-2D	12	DIX-5D	107	DX-16	106	EVE-7	109
COR-206	104	DAT-1D.P	42	DIX-6D	107	DX-17	106	EVE-8	109
COR-207	104	DAT-1I.P	42	DIX-7D	107	DX-18	106	EV-13D	110
COR-208	104	DAT-2D	42	DOB-1D	57	DX-19	106	EZ-1G	192
COR-209	104	DAT-2I	42--53	DOB-2	57	DX-20	106	EZ-DS15	174
COR-210	104	DAT-2I.P	42--53	DOB-2D	57	DX-21	106	EZ-DS15R	174
COR-211	104	DAT-3D	42	DOI-1	108	DX-22	106	EZS-1	110
COR-212	104	DAT-3I	42	DOI-4	108	DX-23	106	F	
COR-213	104	DAT-4D	42	DOI-5	108	DX-24	106	FAC-2D	110
COR-214	104	DAT-4I	42	DOI-6	108	DX-25	106	FAC-2G	192
COR-215	104	DAT-5D	35--42	DOI-7	108	DX-26	106	FAC-14D	110
COR-216	104	DAT-6	42--53	DOM-1D	107	DX-27	106	FAC-19	174
COR-217	104	DAT-6.P	42--53	DOM-1I	107	DX-28	106	FAL-1D	110
COR-218	104	DAT-6.P1	42	DOM-2D	107	DX-29	106	FAL-1DE	206
COR-219	104	DAT-6D	42	DOM-3D	107	DX-30	106	FAL-2D	110
COR-220	101	DAT-6D.P	42	DOM-3I	107	DX-31	106	FAL-3D	110
COR-220D	101	DAT-6D.P1	42	DOM-5D	107	DX-32	106	FAL-4D	110
COR-221D	102	DAT-7	42	DOM-6I	107	DX-33	106	FAL-5D	110
COR-222	104	DAT-8	42	DOM-7D	107	DX-34	106	FAL-6D	110
CR-1G	191	DAT-8I	42	DOM-9D	107	DX-35	106	FAL-7D	110
CR-3G	191	DAT-10	42	DOM-12	107	DX-36	106	FAL-8D	110
CR-4G	192	DAT-10.P	42	DOM-12D	107	DX-37	105	FAL-9D	110
CR-14G	192	DAT-11	43	DOM-17I	174	DX-38	105	FAL-10D	110
CRT-1G	191	DAT-11D	35--43	DOM-18D	107	DX-39	173	FAL-11D	110
CSB-2D	94	DAT-12	43	DOM-25D	107	DX-40	173	FAL-12D	110
CTO-1	94	DAT-13	43	DOM-26D	107	DX-41	173	FAL-13D	110
CTO-2	94	DAT-13.P	43	DOM-27D/11	107	DX-42D	173	FAL-14D	110
CTO-3D	94	DAT-14	43	DOM-27D/17	107	E		FAL-15D	110
CTO-3DE	205	DAT-14.P	43	DOM-27D/20	107	E-3G	195	FAL-16D	110
CTO-4D	173	DAT-15	43	DOM-29	108	EAG-1D	108	FAL-17D	110
CVL-1D	104	DAT-15.P	43	DOM-32	174	EAG-2D	108	FAL-18D	110
CVL-1I	104	DAT-16	43	DOM-36	108	EAG-4D	108	FAL-19D	110
CVL-5D	104	DAT-16.P	43	DOM-36D	108	EAG-5D	108	FAL-20D	110
CVL-5I	104	DAT-17	43	DOM-37D	108	EAG-6	108	FAL-21D	110
CVL-9D	173	DAT-17D	43	DOM-43	174	EAR-1D	109	FAL-22D	111
D		DAT-18	43	DOM-55D	108	EBE-1D	109	FAL-23D	111
DAD-1D	105	DAT-19	43	DOM-B1	174	ELG-1	109	FAL-24D	111
DAD-1I	105	DAT-19.P	43	DU-1	45	ELG-2	109	FAL-25D	111
DAD-2D	105	DAT-20	44	DUR-1D	108	ELG-3	109	FAL-26D	111
DAD-2I	105	DAT-20.P	44	DX-1D	105	ELP-1	109	FAL-27D	111
DAE-1.P	11	DAT-21	44--53	DX-4	105	EMK-1	109	FAL-28D	111

Índice de referencias
Index des références

REF.	PAG.	REF.	PAG.	REF.	PAG.	REF.	PAG.	REF.	PAG.
FAL-29D	111	FO-3D	17	FO-39D	17	GAT-1	113	GLO-6D	115
FAL-30D	111	FO-4.P	17	FO-40D	17	GAT-2D	113	GLO-7	115
FAL-31D	111	FO-6.P	17	FO-41D.P	17	GAT-3D	113	GLO-7D	115
FAM-1	111	FO-7.P	17	FO-42D	19	GAT-4	114	GLO-9D	116
FAM-1D	111	FO-8	14	FO-44D	17	GAT-4D	114	GLO-10	116
FB-17	110	FO-8D	14	FO-E/TC	18	GAT-5	174	GLO-13D	116
FB-19	52	FO-8D.P	14	FO-E/TC.P	18	GE-1D	114	GLO-14	116
FCS-1D	112	FO-8D.P1	14	FO-FK	6-13-18-44-46	GE-21D	114	GLO-15	116
FCS-2D	112	FO-8DE	212	FO-FR	3-6-13-44	GEN-1D	114	GLO-16	116
FCS-2D.P	112	FO-9D	14	FO-FR.P	13	GEN-2D	114	GLO-16D	116
FEC-4D	112	FO-9D.P	14	FO-OA	58	GEN-3D	114	GLO-17	116
FEC-5	112	FO-10.P	14	FO-OL	18	GEN-4D	114	GLO-17D	116
FEC-6D	112	FO-11	14	FO-OR	18	GEN-5D	114	GLO-18	116
FEM-1D	2	FO-11D	14	FO-PN	16	GEN-6D	114--115	GLO-19	116
FEM-1I	2	FO-11DE	212	FO-PRL	18	GEN-7D	114--115	GLO-19D	116
FEM-2D	2--26	FO-12	15	FO-PRR	18	GEN-8D	114	GLO-20	116
FEM-2I	2	FO-12.P	15	FO-TC	6	GEN-9D	114--115	GLO-21	116
FEM-4D	112	FO-13D.P	15	FO-TX	3-18-50	GEN-10D	114	GM-1	21
FF-3	110	FO-15D	15	FO-TX.P	3--18	GEN-11D	114	GM-1.P	21
FF-12D	110	FO-15D.P	15	FO-TX1	18	GEN-12D	114	GM-2	21
FI-3	12	FO-15DE	212	FO-TX2	18	GEN-13D	114	GM-4	21
FI-3D	12	FO-18D	15	FO-XL	18	GEN-14D	114	GM-4.P	21
FI-3D.P	12	FO-19	15	FO-XR	18	GEN-15D	115	GM-4.P1	21
FI-3D.P1	12	FO-19E	212	FR-11D	113	GEN-16D	114--115	GM-4D	21
FI-3D.P3	13	FO-20D	15	FR-11DE	206	GEN-17D	115	GM-4E	213
FI-6I.P1	13	FO-20DE	212	FR-12D	113	GEN-18D	115	GM-5	21
FI-8I	13	FO-21D	15	FR-13	113	GEN-19D	114	GM-5.P	21
FI-11	13	FO-21DE	213	FR-14D	113	GEN-20D	114	GM-5.P1	21
FI-11.P	13	FO-23D	14	FRE-1	19	GEN-21D	114	GM-5D	21
FI-13	13	FO-23D.P	14	FRE-1.P	19	GEN-22D	115	GM-5D.P	21
FI-13.P	13	FO-24	15	FRM-1	174	GEN-23D	115	GM-5D.P1	21
FI-13.P1	13	FO-24C1	63	FRP-1D	112	GEN-24D	114	GM-6	21
FIC-2	112	FO-24C3	63	FTE-1	113	GEN-25D	114	GM-6.P	21
FIC-7	112	FO-24C4	63	FTE-1D	113	GEN-26D	114--115	GM-6E	213
FLD-1D	112	FO-24C5	63	FTE-1DE	206	GEN-27D	114	GM-7	21
FLD-2D	112	FO-24C6	63	FTE-1E	206	GEN-28D	114	GM-7.P	21
FLD-3	112	FO-24C7	63	FTE-2	113	GEN-29D	115	GM-7E	213
FLT-1	113	FO-24C9	63	FTE-2D	113	GH-GX	54	GM-8	21
FLT-1D	113	FO-26D	15	FTE-2DE	206	GH-HX	54	GM-8.P	21
FM-3X	199	FO-27D	15	FTE-2E	206	GIB-1D	115	GM-8E	213
FM-16G	192	FO-27D.P	16	FTE-3	113	GIOB-1D	34	GM-9	2--21
FNL-1D	111	FO-28D	16	FTE-3D	113	GIOB-2I	34	GM-9.P	2--21
FNL-1DE	206	FO-29D	16	FTE-3DE	206	GIU-1	115	GM-10	22
FNL-2D	111	FO-29D.P	16	FTE-3E	206	GIV-1.P	70	GM-10.P	22
FNL-3D	111	FO-29D.P1	16	FTE-5	174	GIV-2D.P	70	GM-10E	213
FNL-4D	111	FO-30D	16	FTE-6D	174	GLD-1	116	GM-11	22
FNL-5D	111	FO-30D.P1	16	FTE-7D	174	GLO-1D	115	GM-11.P	22
FNL-6	111	FO-31	16	G		GLO-1I	115	GM-11E	213
FNL-7D	111	FO-32D	16	GAS-1	19	GLO-2	115	GM-12	22
FNL-8D	111	FO-33D	16	GAS-1D	19	GLO-2D	115	GM-12.P	22
FNL-10D	111	FO-34D	16	GAS-1S	20	GLO-3	115	GM-12E	213
FNL-11D	111	FO-34D.P	16	GAS-2	20	GLO-3D	115	GM-13	22
FNL-12	111	FO-35	19	GAS-2D	20	GLO-4D	115	GM-13.P	22
FNL-13D	111	FO-36	19	GAS-3	20--21	GLO-4I	115	GM-14	22
FNL-14	174	FO-37	17	GAS-4	20	GLO-5I	115	GM-14.P	22
FO-3	17	FO-38D	17	GAS-4D	20	GLO-6	115	GM-14E	213

REF.	PAG.	REF.	PAG.	REF.	PAG.	REF.	PAG.	REF.	PAG.
GM-15D	26--28	GOC-1D	26--100	HOND-6D	71	HOND-43D.P	72	HY-4.P3	29
GM-15D.P	26--28	GOC-2D	26	HOND-6I	71	HOND-47D.P	73	HY-5	29
GM-16	22	GR-1D	116	HOND-7D	71	HOND-48.P	73	HY-5.P	29
GM-16.P	22	GR-1I	116	HOND-7I	71	HOND-48D.P	73	HY-6D	29
GM-17	22	GR-2D	116	HOND-8I	71	HOND-50	73	HY-6D.P	29
GM-17.P	22	GR-2I	116	HOND-10	27	HOND-51	73--75	HY-9.P2	29
GM-18	22	GR-3D	116	HOND-10.P	27	HOND-52	73	HY-10	29
GM-18.P	22	GR-3I	116	HOND-10E	213	HOND-52D	73	HY-10.P	29
GM-19	22	GRS-1	116	HOND-11	27	HOND-57.P	73	HY-11	29
GM-19.P	22	GUA-1X	199	HOND-11.P	27	HOND-57D.P	73	HY-11.P3	29
GM-20	22	H		HOND-12	27	HOND-58.P	73	HY-11D	29
GM-20.P	22	HAF-2	117	HOND-12.P	27	HOND-58.P1	73	HY-11D.P3	29
GM-21	22	HAF-2D	117	HOND-13	27	HOND-58D.P	73	HY-12	30
GM-21.P	22	HAF-7	117	HOND-13.P	27	HOND-58D.P1	73	HY-12.P3	30
GM-22	22	HAO-1D	117	HOND-14	27	HOND-59.P	73	HY-13D	30
GM-22.P	22	HAR-1I	117	HOND-14.P	27	HOND-59D.P	73	HY-13D.P3	30
GM-23	22	HAR-1IE	206	HOND-15	27	HOND-59D.P	73	HY-14	30
GM-23.P	22	HAR-2D	117	HOND-15.P	27	HOND-60D.P	73	HY-15D	30--39
GM-24	23	HAW-1D	117	HOND-16D	27	HRD-1	118	HY-16	30
GM-24.P	23	HAW-2D	117	HOND-16D.P	27	HRD-1D	20--118	HY-17	30
GM-25	23	HAW-3D	117	HOND-16D.P1	1	HRD-2	54--118	HY-18	30
GM-25.P	23	HAW-4D	117	HOND-16DE	213	HRD-2D	54--118	HY-18.P	30
GM-26	23	HD-1	70	HOND-17.P	27	HU-2.P	28	HY-18.P3	30
GM-26D	23	HD-1D	70	HOND-19	71	HUD-3	96--117	HY-19.P3	30
GM-27	23	HD-2	70	HOND-19.P	72	HUD-3D	117	HY-19.P5	31
GM-29	23	HD-2D	70	HOND-19D	71	HUD-3DE	206	HY-19D.P3	30
GM-29D	23	HD-3	70	HOND-19D.P	72	HUD-3E	206	HY-20.P	31
GM-30	23	HD-3D	70	HOND-20	72	HUD-4	25--117	HY-21.P3	31
GM-30.P	23	HD-4D	71--75	HOND-20.P	72	HUD-5D	118	I	
GM-30E	213	HD-5	71	HOND-20D	72	HUD-6	6--118	IF-1I	118
GM-31	23	HD-5D	71	HOND-20D.P	72	HUD-7	118	IF-3.P	118
GM-32	23	HD-6	71	HOND-24.P	72	HUD-8D	118	IF-4	175
GM-33	23	HD-6D	71	HOND-28.P	72	HUD-9	118	IF-5	118
GM-34	24	HD-7D	71	HOND-28D.P	72	HUD-10	118	IF-6	175
GM-34.P	24	HEN-1	117	HOND-29.P	72	HU-DF.P1	59	IF-7	118
GM-34E	213	HER-1	117	HOND-29D.P	72	HU-DH.P	59	IF-15	118
GM-35	24	HER-2D	117	HOND-31	28	HU-DN.P	59	IF-35	118
GM-35.P	24	HER-3	117	HOND-32D	28	HU-HAA.P1	58	IF-45/55	119
GM-36	24	HIN-1	26	HOND-33	72	HU-HAAC2	65	IF-60/70	119
GM-36.P	24	HIN-1.P	26	HOND-34	26	HU-HAAC4	65	IF-D20	118
GM-36E	213	HMS-1.P	175	HOND-36.P	72	HU-HAAC5	65	IF-D25	118
GM-37	24	HOND-1	26	HOND-36.P1	72	HU-MN	4	IF-D25	118
GM-37.P	24	HOND-1.P	27	HOND-36D.P	72	HU-P	5	IF-120	118
GM-38	24	HOND-2	26	HOND-36D.P1	72	HU-SC	44	IF-125	118
GM-38.P	24	HOND-2.P	27	HOND-36D.P4	72	HU-SX	5	IF-130	118
GM-39	24	HOND-3D	71	HOND-37D	1	HUW-N	118	IF-140	118
GM-39.P	24	HOND-3I	71	HOND-37D	1	HY-1	28	IF-151	119
GM-40	24	HOND-4D	71	HOND-37D.P	1	HY-2	28	IF-160/70	119
GM-40.P	24	HOND-4D.P	71	HOND-38D	1	HY-3	28	IL-1D	119
GM-41	25	HOND-4D.P1	71	HOND-39D	1	HY-3.P2	28	ILC-1D	119
GM-42D	25	HOND-4D.P2	71	HOND-40D	1	HY-3.P3	28	ILC-2D	119
GM-43	25	HOND-4I	71--75	HOND-40D	1	HY-3D	28--39	ILC-2DE	206
GM-44D	25	HOND-4I.P	71	HOND-40D.P	1	HY-3D.P	28	ILC-3	119
GM-45D	25	HOND-4I.P1	71--75	HOND-41D	1	HY-3D.P1	28--39	ILC-3	119
GM-46D	25	HOND-5D	71	HOND-42.P	72	HY-4	29	ILC-4D	119
GM-47D	25--31	HOND-5I	71	HOND-42D.P	72	HY-4.P	29	ILC-4DE	207
				HOND-43.P	72			ILC-5D	119

Índice de referencias
Index des références

REF.	PAG.	REF.	PAG.	REF.	PAG.	REF.	PAG.	REF.	PAG.
ILC-6D	119	JD-2	32	KAW-15D	75	KRCVA-34	64	LF-2	125
ILC-7D	119	JD-3D	32	KE-1	176	KUB-1D	34	LF-4I	125
ILC-7DE	207	JD-4D	32	KE-3	176	KUB-2D	34	LF-5	125
ILC-8D	119	JEN-1	120	KE-4	176	KWI-1	121	LF-7	125
ILC-9D	119	JIS-2I	120	KE-6	176	KWI-1DL	121	LF-7D	125
ILC-10D	119	JU-1	87	KEI-1	121	KWI-1IK	121	LF-8	125
ILC-11	119	JU-2	88	KEI-2	121	KWI-1K	121	LF-15	125
ILC-11D	119	JUNI-2D	120	KEN-1	32	KWI-1KE	207	LF-20	125
ILC-12	119	JWL-2D	120	KEN-1.P	32	KWI-1KS	121	LF-21	125
ILC-12D	119	JWL-6	120	KEN-2D	32	KWI-2D	121	LF-24	125
ILC-13	119	K		KEN-2D.P	33	KWI-2DC	121	LF-25	125
ILC-13D	119	KA-1	175	KEN-3	32	KWI-2DE	207	LF-27	125
ILC-14	119	KA-2	175	KEN-4	33	KWI-2DS	121	LF-40	125
ILC-14D	119	KA-3	175	KFV-1	121	KWI-3D	121	LF-42	125
ILC-16	119	KA-4	175	KI-10D.P3	34	KWI-4D	121	LF-RO	7--50
ILL-1	120	KA-5	175	KI-1D	33	KWI-5D	122	LIN-1D	122
ILL-2	120	KA-6	175	KI-1D.P	33	KWI-5DE	207	LIN-1I	122
ILL-2D	39-120	KA-7	175	KI-1D.P1	33	KWI-9D	122	LIN-3D	123
ILL-3	120	KA-8	175	KI-2D	33	KWI-10D	122	LIN-3I	123
ILL-4	120	KA-10	175	KI-3D	33	KYM-1.P	76	LIN-5D	123
ILL-5	120	KA-11	175	KI-3D.P	33	KYM-1D.P	76	LIN-5I	123
ILL-6	120	KAE-1	175	KI-4D	33	KYM-2	76	LIN-6D	123
ILL-7	120	KAE-1G	192	KI-4D.P	33	KYM-2.P	76	LIN-7D	123
ILL-8	120	KAE-2	175	KI-5	33	KYM-2D	76	LIN-10I	123
ILL-9	120	KAE-3D	120	KI-5.P	34	KYM-2D.P	76	LIN-13	176
ILL-10	120	KAE-4	175	KI-5D	33	KYM-3.P	76	LIN-15D	123
ILL-11D	120	KAE-5	120	KI-5D.P	34	KYM-3D.P	76	LIN-15I	123
ILL-12	120	KAE-8	121	KI-6	34	L		LIN-19	176
IMP-1	120	KAE-8D	121	KI-6.P	34	L-3G	195	LIN-19D	176
IMP-1D	120	KAE-9	121	KIB-1	121	LAP-1	122	LIO-1	123
IMP-2	120	KAE-11D	176	KMB-1	121	LAR-2G	193	LIP-2	123
IMS-3	2	KAE-12D	176	KMB-2	121	LAR-3G	193	LIP-2D	123
IMS-5	2	KAW-1D	74	KMB-3	121	LAS-1D	122	LIP-33	123
IN-1	3--6--50	KAW-1I	74	KOM-1	34	LAS-4	122	LIT-1I	123
IN-4	6	KAW-2D	74	KRCCHR-15	63	LAS-5	20--37--46	LIT-5D	123
IN-5	6	KAW-2I	74	KRCDAC-6D	63	LAS-5D	13--20--46	LIT-5I	123
IS-1G	192	KAW-3	74	KRCDAT-15	64	LAS-6D	122	LMP-1	48
IS-6D	175	KAW-4	74	KRCFI-13	63	LASB-1	122	LMP-2	46
ISU-1	31	KAW-5	74	KRCFO-15D	63	LASB-1D	122	LMP-4	46
ISU-1D	31	KAW-5.P	74	KRCFO-24	63	LASB-2	122	LMP-5	46
ISU-2	31	KAW-6.P	74	KRCFO-30D	63	LASB-2D	122	LOC-1D	123
ISU-3D.P	31	KAW-6D.P	74	KRCGM-37	63	LASB-3D	122	LOC-1T	123
ISU-4	31	KAW-7	74	KRCHOND-31	63	LAS-FH	122	LOC-1Z	194
ISU-5	31	KAW-7.P	74	KRCHU-HAA	65	LAS-KT	122	LOC-2D	123
ISU-5.P	31	KAW-9	74	KRCHY-18	64	LAS-P	20	LOC-2Z	194
IT-1G	192	KAW-9.P	75	KRCHY-20	64	LAS-R	46	LOC-3D	123
ITA-1	73	KAW-10.P	75	KRCMAZ-11D	64	LAS-SX	20	LOC-3Z	194
ITA-1.P	74	KAW-10D.P	75	KRCMIT-8D	64	LAS-TX	122	LOC-4D	124
ITA-1D	73	KAW-11	75	KRCNE-36	64	LAS-U	46	LOC-4Z	194
ITA-1D.P	74	KAW-11D	75	KRCOP-D	64	LAS-V	46	LOC-5D	124
ITA-2.P	74	KAW-12D	75	KRCOP-S	64	LAS-X	46	LOC-5Z	194
ITA-3.P	74	KAW-13	70--75--77--79	KRCSUZU-14	65	LAS-XS	20	LOC-6D	124
J		KAW-13D	75	KRCTOYO-15	65	LAS-XY	122	LOC-6Z	194
J-3G	195	KAW-14	75	KRCTOYO-19	65	LAS-Y	20--46	LOC-7D	123
JAU-1.P	18	KAW-14D	75	KRCTOYO-20D	65	LEG-1D	122	LOC-8	176
JD-1	32	KAW-15	75			LF-1I	125	LOC-9	176

REF.	PAG.	REF.	PAG.	REF.	PAG.	REF.	PAG.	REF.	PAG.
LOR-1	125	MAS-2DE	207	MAS-4I	128	MDC-15S	129	MHA-1	177
LOR-2D	125	MAS-3D	126	MASL-1	176	MDC-16DS	128	MHN-1.P	34
LOT-1	176	MAS-3DE	207	MAZ-1D	35	MDC-16S	128	MIL-1	185
LOT-1D	176	MAS-4D	126	MAZ-1I	35	MDC-17S	128	MIL-2	185
LOT-2.P	176	MAS-5D	126	MAZ-2D	35	MDC-18DS	128	MIL-1D	130
LPO-1	122	MAS-5DE	207	MAZ-2I	35	MDC-19S	128	MIS-1	185
LPO-2	122	MAS-6	126	MAZ-2I.P	35	MDC-20DS	129	MIS-2	185
LRD-1	122	MAS-7	126	MAZ-3D	35	MDC-21S	129	MIS-3	185
LRD-1D	122	MAS-7D	126	MAZ-3D.P	35	ME-1	37	MIT-1D	39
LSD-1D	126	MAS-7E	207	MAZ-3I	35	ME-1.P	37	MIT-1D.P	39
LSD-1DE	207	MAS-8	126	MAZ-3I.P	35	ME-2.P	37	MIT-1I	39
LWO-1	124	MAS-9	126	MAZ-4	35	ME-3.P	37	MIT-1I.P	39
LWO-1D	124	MAS-9D	126	MAZ-5D	35	ME-4.P	37	MIT-2D	39
LWO-2D	124	MAS-9DE	207	MAZ-7D	35	ME-5.P	37	MIT-2D.P	40
LWO-3	124	MAS-9DS	126	MAZ-7D.P	35	ME-6.P	37	MIT-2I	9--25--31--32--39
LWO-3D	124	MAS-9E	207	MAZ-8D	35	ME-7.P	37	MIT-2I.P	9--25--31--32--40
LWO-4	124	MAS-9S	126	MAZ-8D.P	36	ME-8.P	37	MIT-3	40
LWO-4D	124	MAS-10	126	MAZ-11D	36	ME-9	37	MIT-3.P	40
LWO-4DE	207	MAS-10C	126	MAZ-11D.P1	36	ME-9.P	38	MIT-4	40
LWO-5	124	MAS-10D	126	MAZ-13D	36	ME-10.P	38	MIT-4.P	40
LWO-5D	124	MAS-10DS	126	MAZ-13D.P	36	ME-11.P	38	MIT-6	40
LWO-8	124	MAS-10E	207	MAZ-13D.P1	36	ME-12.P	38	MIT-7	40
LWO-10	124	MAS-10S	126	MAZ-13DE	213	ME-14.P	38	MIT-7.P	40
LWO-10D	124	MAS-11	126	MAZ-14D	36	ME-15	38	MIT-8D	40
LWO-11	124	MAS-11D	126	MAZ-17D	36	ME-15D	38	MIT-8D.P	40
LWO-11D	124	MAS-12D	126	MAZ-17D.P	36	ME-HD	38	MIT-9	40
LWO-12	124	MAS-13D	126	MAZ-18D	36	ME-HD.P	38	MIT-10	40
LWO-12D	124	MAS-13DE	207	MAZ-19D	36	ME-HF	38	MIT-11D	41
LWO-13	124	MAS-14	127	MAZ-20D	36	ME-HF.P	38	MIT-12	41
LWO-13D	124	MAS-15.P	176	MAZ-20D.P	37	ME-HM	38	MIT-13D	41
LWO-14	124	MAS-16D	127	MAZ-21D.P1	37	ME-HM.P	38	MIT-14D	41
LWO-14D	124	MAS-16DE	208	MBL-1	130	ME-HML.P	38	MIT-14DE	214
LWO-15	124	MAS-17	127	MBL-1D	130	ME-HU	38	MIT-15.P	41
LWO-15D	124	MAS-17D	127	MCM-1	128	ME-HU.P	38	MIT-16	41
LWO-16	124	MAS-18D	127	MCM-4SS	176	ME-HY	38	MIT-16.P	41
LWO-16D	124	MAS-18DE	208	MCM-6	128	ME-HY.P	38	MIT-16E	214
LWO-17	124	MAS-19	127	MCM-10	177	ME-HZ	38	MIT-17	41
LWO-17D	124	MAS-19E	208	MCM-12D	128	ME-HZ.P	38	MIT-18	41
LWO-18	124	MAS-21D	127	MCM-13D	128	ME-L	39	MIT-18.P	41
LWO-18D	124	MAS-23	127	MCM-16	177	ME-NU.P	38	MIT-18D	41
LWO-19	124	MAS-24D	126	MCM-24C	128	ME-NY	38	MIT-18D.P	41
LWO-19D	124	MAS-25D	127	MCP-1	130	ME-NY.P	38	MIW-2	130
LWO-20	124	MAS-26	127	MDC-1S	128	MEC-5D	128	MLM-5	130
LWO-20D	124	MAS-26D	127	MDC-2S	128	MER-3T	129	MNG-1	130
LWO-21	124	MAS-27D	127	MDC-3DS	128	MER-16D	129	MNO-1D	130
LWO-21D	124	MAS-28	127	MDC-4S	128	MER-17	129	MOT-1.P	76
LWO-22D	124	MAS-29D	127	MDC-5S	128	MGA-1	130	MSL-1	185
LWO-23D	124	MAS-31D	127	MDC-6S	129	MGA-1D	130	MSL-2	185
LWO-24D	124	MAS-32	127	MDC-7S	129	MGG-1	129	MSL-3	185
LWO-25D	124	MAS-33	127	MDC-8DS	129	MGG-1D	129	MT-3G	193
M		MAS-33D	127	MDC-9S	129	MGG-2	130	MT-6.PG	193
MAG-1D	176	MAS-34D	127	MDC-10S	129	MGG-2D	130	MT-EG	130
MAG-3D	126	MAS-35	127	MDC-11S	129	MGG-3	130	MTO-1	129
MAG-4D	176	MAS-36D	127	MDC-12DS	129	MGG-3D	130	MTR-1D	129
MAK-1	34	MAS-39D	127	MDC-13DS	128	MGG-4	130		
MAS-2D	126	MAS-40D	128	MDC-14DS	129	MGG-4D	130		

Índice de referencias
Index des références

REF.	PAG.	REF.	PAG.	REF.	PAG.	REF.	PAG.	REF.	PAG.
MU-2.P1	177	NE-29.P	47	OD-2	177	PAD-4	132	PHI-52	134
MU-3.P1	177	NE-32	20	OD-3	177	PAD-4D	132	PHI-52E	208
MU-4.P1	177	NE-34.P	47	OD-4	177	PAD-5	132	PHI-52L	134
MU-5.P1	177	NE-35	51	OD-5D	177	PAD-6	132	PJ-1	20--47
MU-7.P1	177	NE-35.P	51	OD-6D	131	PAP-1	133	PJ-2	58
MU-8.P1	177	NE-35.P2	51--76	OD-7D	131	PAP-1E	208	PLI-1D	134
MU-10.P	177	NE-36	49	OD-8D	132	PAP-1X	199	PLI-2D	134
MU-11.P1	177	NE-36.P	49	OD-9D	132	PAP-2	133	PLI-3D	178
MU-12	177	NE-36.P1	49	OD-10D	132	PAP-2X	199	PLL-1	12
MU-12D	177	NE-37	14	OD-11	177	PAP-3	133	PR-1	134
MZ-1	130	NE-38	49	OD-12	177	PAP-4	133	PR-1D	134
N		NE-38.P1	49	OD-13D	177	PAP-4X	200	PR-4D	134
NCE-1D	131	NE-40	60	OD-14D	132	PAP-5	133	PR-4I	134
NCR-1D	131	NE-40.P	60	OD-15D	132	PAP-5X	200	PR-5D	134
NCR-2D	131	NE-41.P	60	OD-16D	177	PAP-8	133	PR-5I	134
NCR-3	131	NE-45.P	76	OD-17D	178	PAP-9	133	PR-6	134
NCR-4D	131	NE-47	14	OD-18D	132	PAP-10,P	178	PR-7	134
NCR-5D	131	NE-51.P2	47	OD-19D	132	PAP-11	133	PR-10	134
NCR-6D	131	NE-52	51	OJ-6I	132	PAP-12	133	PR-16	134
NCR-7	131	NE-52.P	51	OJ-9D	132	PAP-13	133	PUN-1D	134
NCR-8	131	NE-56	47	OJ-13	132	PAP-13D	133	PUN-2D	134
NCR-9D	131	NE-60C1	64	OJ-14	132	PAP-14	133	PUN-3D	134
NE-1	4	NTC-1	130	OP-6	44	PAP-14D	133	R	
NE-3	48	NTC-1D	130	OP-7	44	PAP-15D	133	R-1G	195
NE-3.P	48	NTC-1DE	208	OP-8	44	PCI-IT	132	R-1Z	195
NE-3.P1	46	NTC-6	130	OP-9	44	PER-1	46	R-2G	195
NE-4	10--46	NTC-7D	130	OP-11	44	PEU-1C1	64	RAB-1	135
NE-4.P	10--46	NTC-7DE	208	OP-11C1	64	PEU-2C1	64	REG-1D	135
NE-4D	10--46	NTC-8D	130	OP-AB	45	PHI-1D	133	RIO-1D	135
NE-5	48	NTC-9D	130	OP-BA	45	PHI-1Z	194	RO-1D	52
NE-6	70--77	NTC-10D	130	OP-BA.P	45	PHI-2D	133	RO-1DS	52
NE-8	5	NTC-10DE	208	OP-BB	25--45	PHI-2Z	194	RO-1I	52
NE-9	59	NTC-11D	131	OP-CC	25--45	PHI-3X	200	RO-1IS	18-52
NE-10	50--59	NTC-12D	131	OP-D	45	PHI-3Z	194	RO-2D	10--47--49--52
NE-11	17--33--50	NTC-13D	131	OP-D.P	45	PHI-4	133	RO-2I	10--47--49--52
NE-11.P	50	NTC-14	131	OP-DD	45	PHI-4D	133	RO-3	52
NE-12	60	NTC-14D	131	OP-DE	214	PHI-4X	200	RO-4D	10--52
NE-12.P	60	NTC-15D	131	OP-EE	45	PHI-4Z	194	RO-4I	10--34--52
NE-13	11	NTC-16D	131	OP-FF	45	PHI-5D	178	RO-5D	10
NE-15D	48	NTC-17D	131	OP-HA	45	PHI-5X	200	RO-6D	10--49--52
NE-15D.P	48	NTC-18D	131	OP-HB	45	PHI-5Z	194	RO-6I	10--49--52
NE-15I	14	NTC-19D	131	OP-HG	45	PHI-6	133	RO-7D	135
NE-16	2	NTC-20D	131	OP-HH	45	PHI-6X	200	RO-7I	47--135
NE-18	60	NTC-21D	131	OP-J	45	PHI-6Z	194	RO-10D	135
NE-18.P	60	NTC-22D	131	OP-J.P	45	PHI-7X	200	RO-10I	135
NE-19	48	NTC-23D	79--131	OP-NA	45	PHI-10	133	RO-11D	47
NE-19.P	48	NTC-24D	131	OP-NB	45	PHI-11	185	RO-11I	47
NE-19.P1	48	NTL-1D	131	OP-R	45	PHI-12	178	RO-12I	135
NE-20	2--9--46	NTL-1DE	208	OP-S	25--45	PHI-13	178	RO-15	49
NE-20.P	47	NTL-2	131	OP-S.P	25--45	PHI-14D	178	RO-16D	49--52--135
NE-20.P2	47	NTL-2D	131	OP-S.P1	12	PHI-15D	178	RO-16I	49--52--135
NE-20.P3	10	NTR-1D	131	OP-SE	214	PHI-16	134	RO-24D	135
NE-22.P	2--47	NTR-2D	131	OP-WH.P	45	PHI-17D	178	RO-24I	135
NE-25	7--39--51	NTR-2DE	208	OP-WHCI	64	PHI-32	134	RO-25I	135
NE-28	3--9	O		OP-WY.P	45	PHI-32L	134	RO-26I	135
NE-29	47	OD-1	177	P		PHI-39	134	RON-1D	135

REF.	PAG.	REF.	PAG.	REF.	PAG.	REF.	PAG.	REF.	PAG.
RON-2D	135	RUS-26	138	RUS-70D	138	SAR-22	141	SAR-73D	139
RON-3D	135	RUS-26D	138	RUS-71D	138	SAR-23	141	SAR-74	139
RON-4D	135	RUS-27	138	RUS-72D	138	SAR-24	141	SAR-74D	139
RON-5D	135	RUS-27D	138	RUS-73D	138	SAR-25	141	SAR-75	139
RON-6D	135	RUS-28	138	RUS-74D	137	SAR-26	141	SAR-75D	139
RON-7D	135	RUS-28D	138	RUS-75D	137	SAR-27	141	SAR-76	139
RON-8D	135	RUS-29	138	RUS-76D	137	SAR-28	141	SAR-76D	139
RU-1D	136	RUS-29D	138	S		SAR-29	141	SAR-77	139
RU-2D	136	RUS-30	136	SA-1	138	SAR-30	141	SAR-77D	139
RU-2I	136	RUS-30D	136	SA-2	138	SAR-31	141	SAR-78	139
RU-5D	136	RUS-31	136	SA-3D	139	SAR-32	141	SAR-78D	139
RU-9I	136	RUS-31D	136	SA-3I	139	SAR-33	141	SAR-79	139
RUS-1	136	RUS-32	136	SA-4	139	SAR-34	141	SAR-79D	139
RUS-2	136	RUS-32D	136	SAA-1.P1	51	SAR-35	141	SAR-80	139
RUS-3	136	RUS-33	136	SAA-AC	51	SAR-36	141	SAR-80D	139
RUS-4	136	RUS-33D	136	SAA-AC.P	51	SAR-37	141	SAR-81	139
RUS-4D	136	RUS-34	136	SAF-1	138	SAR-38	141	SAR-81D	139
RUS-4E	208	RUS-34D	136	SAF-1D	138	SAR-39	141	SAR-82	140
RUS-4S	137	RUS-35	136	SAF-3	138	SAR-40	141	SAR-82D	140
RUS-5	136	RUS-35D	136	SAF-3D	138	SAR-41	141	SAR-83	140
RUS-5D	136	RUS-36	136	SAF-4	138	SAR-42	142	SAR-83D	140
RUS-5E	208	RUS-36D	136	SAF-4D	138	SAR-43	142	SAR-84	140
RUS-5S	137	RUS-37	136	SAR-1	140	SAR-44	142	SAR-84D	140
RUS-6	137	RUS-37D	136	SAR-1D	140	SAR-45	142	SAR-85	140
RUS-7	137	RUS-38D	138	SAR-2D	139	SAR-46	142	SAR-85D	140
RUS-8	136	RUS-39D	138	SAR-2DE	208	SAR-47	142	SAR-86	140
RUS-8D	136	RUS-40D	138	SAR-2DS	139	SAR-48	142	SAR-86D	140
RUS-9	136	RUS-41D	138	SAR-3D	139	SAR-49	142	SAR-87	140
RUS-9D	136	RUS-42D	138	SAR-4	139	SAR-50	142	SAR-87D	140
RUS-10	136	RUS-43D	138	SAR-4D	139	SAR-51	142	SAR-88	140
RUS-11	138	RUS-44D	138	SAR-5D	142	SAR-52	142	SAR-88D	140
RUS-11D	138	RUS-45	137	SAR-6	139	SAR-53	142	SAR-89	140
RUS-12	137	RUS-46	137	SAR-6D	139	SAR-54	142	SAR-89D	140
RUS-13D	136	RUS-47	137	SAR-7	140	SAR-55	142	SAR-90	140
RUS-14D	136	RUS-48	137	SAR-7D	140	SAR-56	142	SAR-90D	140
RUS-15	137	RUS-49	137	SAR-7E	208	SAR-57	142	SAR-91	140
RUS-16	138	RUS-50	137	SAR-7S	139	SAR-58	142	SAR-91D	140
RUS-16D	138	RUS-51	137	SAR-8	139	SAR-59	142	SAR-92	141
RUS-17	138	RUS-52	137	SAR-8D	139	SAR-60	142	SAR-93	141
RUS-17D	138	RUS-53	137	SAR-8S	139	SAR-61	142	SAR-94	141
RUS-18	138	RUS-54	137	SAR-9D	142	SAR-62	142	SAR-95	141
RUS-18D	138	RUS-55	137	SAR-10	142	SAR-63	142	SAR-96	141
RUS-19	138	RUS-56	137	SAR-11	140	SAR-64	142	SAR-97	141
RUS-19D	138	RUS-57	137	SAR-11D	140	SAR-65	142	SAR-98	141
RUS-20	138	RUS-58D	137	SAR-12	140	SAR-66	142	SAR-99	141
RUS-20D	138	RUS-59D	137	SAR-12D	140	SAR-67	142	SAR-100	141
RUS-21	138	RUS-60D	137	SAR-13	140	SAR-68	142	SAR-101	141
RUS-21D	138	RUS-61D	138	SAR-13D	140	SAR-69	139	SAR-102	141
RUS-22	138	RUS-62D	138	SAR-14D	142	SAR-69D	139	SAR-103	141
RUS-22D	138	RUS-63D	138	SAR-15	142	SAR-70	139	SAR-104	141
RUS-23	138	RUS-64D	138	SAR-16	141	SAR-70D	139	SAR-105	140
RUS-23D	138	RUS-65D	138	SAR-17	141	SAR-71	139	SAR-106	140
RUS-24	138	RUS-66D	138	SAR-18	141	SAR-71D	139	SAR-107	140
RUS-24D	138	RUS-67D	138	SAR-19	141	SAR-72	139	SAR-108	140
RUS-25	138	RUS-68D	138	SAR-20	141	SAR-72D	139	SAR-109	140
RUS-25D	138	RUS-69D	138	SAR-21	141	SAR-73	139	SAR-110	140

Índice de referencias
Index des références

REF.	PAG.	REF.	PAG.	REF.	PAG.	REF.	PAG.	REF.	PAG.
SAR-111	140	SKI-1D	146	SLG-37	144	SUB-1.P	53	TE-8IE	209
SAR-112	140	SKI-1DE	209	SLG-38	144	SUB-3	53	TE-11D	148
SAR-113	140	SKO-2	77	SLG-39	144	SUN-1	147	TE-15D	148
SAR-114	140	SKO-3I	52	SLG-40	144	SUZU-1D	77	TE-17D	148
SAR-115	140	SKO-3I.P	52	SLG-41D	178	SUZU-1I	77	TE-29D	148
SAR-116	140	SKO-5.P	52	SLG-42DS	144	SUZU-2D	77	TE-30D	148
SAR-117	140	SLG-1	143	SLG-43DS	144	SUZU-2I	77	TE-34D	179
SAR-118	142	SLG-1E	208	SLY-1D	146	SUZU-5	77	TE-T10	179
SAR-119D	142	SLG-2	143	SLY-2	146	SUZU-5.P	77	TE-T60	179
SCA-1	142	SLG-3	143	SLY-3	146	SUZU-6	77	TE-T62	180
SCA-2D	143	SLG-3C	143	SLY-4D	146	SUZU-7	53	TE-T80	180
SCA-3D	143	SLG-3E	209	SLY-5	146	SUZU-8	53	TE-T80SC	180
SCA-4D	143	SLG-3S	143	SLY-6	146	SUZU-8.P	53	TEU-1	185
SCA-5	143	SLG-4	144	SLY-7D	146	SUZU-10	53	TI-1	148
SCA-6D	178	SLG-4C	143	SLY-8	146	SUZU-10.P	54	TI-1D	148
SCH-1D	144	SLG-4E	209	SLY-9	146	SUZU-10D	53	TIF-1D	148
SCL-1D	145	SLG-4S	143	SLY-10D	146	SUZU-11D	77	TIF-15/20	148
SCO-1	145	SLG-5	144	SLY-11	146	SUZU-11D.P	77	TIF-30D	149
SCO-2	145	SLG-5C	143	SLY-12D	146	SUZU-12	77	TIF-40D	149
SCO-3	145	SLG-5E	209	SLY-13D	146	SUZU-12.P	77	TIF-50/60	149
SCO-4	145	SLG-5S	143	SLY-14	146	SUZU-12D	77	TIM-1D	149
SCO-5	145	SLG-6	144	SLY-15D	146	SUZU-12D.P	77	TIM-1DE	209
SCO-6	145	SLG-6L	144	SLY-16	146	SUZU-14.P2	78	TIT-7D	54
SCO-11	145	SLG-8	144	SM-1	146	SUZU-16	78	TK-2D	148
SCO-12	145	SLG-8S	143	SM-3D	146	SUZU-16.P	78	TOK-4D	149
SCO-14	178	SLG-9	144	SOP-3D	179	SUZU-16D	78	TOK-5D	149
SCO-15	145	SLG-9S	143	SOP-4D	179	SUZU-16D.P	78	TOK-8	149
SCO-16	145	SLG-10	144	SOP-5	179	SUZU-18	78	TOK-21	149
SCR-1	145	SLG-10S	143	SOP-5D	179	SUZU-18.P	78	TOK-22	149
SCZ-1D	179	SLG-11	143	SOP-6	146	SUZU-18.P1	78	TOK-24	149
SCZ-2D	179	SLG-11E	209	SOP-7D	146	SUZU-18D	78	TOK-37	149
SEA-1	179	SLG-11S	144	SOP-8D	179	SUZU-18D.P	78	TOK-38	149
SEA-2	179	SLG-12	143	SOS-1D	146	SUZU-18D.P1	78	TOK-39	149
SEC-2G	193	SLG-13	143	SOS-2D	146	SUZU-19D.P	47	TOK-40	149
SEC-3	179	SLG-14	143	SOU-1D	146	SUZU-22.P	78	TOK-41	149
SEC-3D	179	SLG-14L	144	SQ-2	147	SUZU-23.P	78	TOK-42	149
SEC-7G	193	SLG-15	143	SQ-7	147	SWL-1	146	TOK-43	149
SEG-1D	145	SLG-16	144	SR-1I	147	T		TOK-44	149
SEG-1DE	209	SLG-17	144	SR-2	147	TAY-1	147	TOK-45	149
SEG-1DL	145	SLG-18	144	SR-4	147	TAY-2	148	TOK-46	149
SEG-2D	145	SLG-19	144	SSA-1	52	TAY-3	148	TOK-47	149
SEG-3	145	SLG-20	144	SSA-1.P1	52	TAY-3E	209	TOK-48	149
SEL-1D	145	SLG-21	143	STA-1D	147	TAY-4D	148	TOK-49	149
SEL-1I	145	SLG-22	143	STA-2	147	TAY-5D	148	TOK-50	149
SEL-2D	145	SLG-23	143	STA-6	147	TD-1	113	TOK-51	149
SEL-2I	145	SLG-24	143	STA-6D	147	TD-3	113	TOK-52	149
SEL-4D	145	SLG-25	143	STL-1D	147	TD-4	113	TOK-53	149
SEN-1D	145	SLG-26	144	STL-2I	147	TD-7	174	TOK-54	149
SEN-2D	145	SLG-29	144	STS-4D	147	TD-15	113	TOK-55	149
SER-1G	193	SLG-30	144	STS-T14	179	TE-1D	148	TOK-63	149
SHA-1	146	SLG-31	144	STS-X5	179	TE-1I	148	TOK-64	149
SIS-2	146	SLG-32	144	STS-X6	179	TE-7D	148	TOK-65	149
SIX-3.P	10	SLG-33	144	STUV-1D	147	TE-7DE	209	TOK-66	149
SIX-3.P1	10	SLG-34	144	STUV-1I	147	TE-8D	148	TOK-67	149
SIX-3.P2	10	SLG-35	144	STUV-3	147	TE-8DKT1	148	TOK-68	149
SIX-5.P	11	SLG-36	144	SUB-1	53	TE-8I	148	TOK-69	149

REF.	PAG.	REF.	PAG.	REF.	PAG.	REF.	PAG.	REF.	PAG.
TOK-70	149	TOYO-16D	56	TRM-1	150	TX-9D	153	UN-36I	152
TOK-71	149	TOYO-17	56	TRM-2D	151	TX-10	153	UN-37D	153
TOK-72	149	TOYO-17.P	56	TRM-3D	150	TX-11	153	UN-37I	152
TOK-73	149	TOYO-17E	214	TRM-4	150	TX-15	153	UN-38D	153
TOK-74	149	TOYO-17E1	214	TRM-5D	151	TX-23D	181	UN-38I	152
TOO-1D	54	TOYO-18.P	56	TRM-6D	151	U		UN-39D	153
TOO-2	54	TOYO-19.P	56	TRM-7	151	U-1D	157	UN-39I	152
TOV-1	149	TOYO-20	56	TRM-8	151	U-2D	157	UN-40D	153
TOV-1G	194	TOYO-20D	56	TRM-9D	151	U-3I	157	UN-40I	152
TOV-2	180	TOYO-20DE	214	TRM-10D	151	U-5AD	158	UN-41D	153
TOV-3	149	TOYO-22	57	TRM-11D	151	U-5CD	158	UN-41I	152
TOV-4	180	TOYO-22D	57	TRM-12	151	U-5CI	158	UN-42D	153
TOV-5	180	TOYO-24	10	TRM-13	150	U-5DD	158	UN-42I	152
TOV-6	180	TOYO-25	57	TRM-14D	151	U-5JD	158	UN-43D	153
TOV-7	180	TOYO-27	57	TRM-15D	151	U-17D	157	UN-43I	152
TOV-8D	180	TOYO-28.P	57	TRM-16D	151	U-28YD	153	UN-44	2-7-51-60
TOV-9D	180	TOYO-29	57	TRM-17D	151	U-29D	153	UN-44D	2
TOV-10D	149	TOYO-30.P1	57	TRP-1D	76--79	U-30D	153	UN-46D	153
TOV-11	180	TOYO-33D	57	TRU-1D	151	UCEM-8D	180	UN-47	153
TOYO-2	54	TOYO-34	57	TRU-2	151	UCEM-12	152	UN-FFE	7
TOYO-3	54	TOYO-35D	57	TRU-3D	151	UCEM-13D	180	UN-FP	3--50
TOYO-4	54	TOYO-39	57	TRU-4D	151	UN-1FS	7--152	UN-FR	7
TOYO-4.P	55	TOYO-40	57	TRU-5	180	UN-1G	194	UN-FS	3--79
TOYO-5.P	55	TOYO-40D	57	TRU-5D	180	UN-3	7--51--79	UN-FT	3--17-19
TOYO-6	55	TOYO-K1	54	TRU-6	151	UN-4	7	UN-MRN	7--51
TOYO-8	55	TOYO-K1.P	55	TRU-7	151	UN-5D	152	UN-NC	7
TOYO-8.P	55	TRI-3D	150	TRU-8.P	152	UN-6D	152	UN-NH	7
TOYO-8I.P	55	TRI-3I	150	TRU-9D	152	UN-11	152	URB-3D	181
TOYO-9	55	TRI-5D	150	TRU-10.P	152	UN-13I	152	URKO-1D	153
TOYO-9.P	55	TRI-5I	150	TRU-11	151	UN-14I	152	URKO-1I	153
TOYO-9.P1	55	TRI-6D	150	TRU-12	180	UN-17I	152	URKO-3D	154
TOYO-10	55	TRI-6I	150	TRU-13D	180	UN-19D	152	URKO-3I	154
TOYO-10.P	55	TRI-7D	150	TRV-1	149	UN-19I	152	V	
TOYO-10.P1	55	TRI-7I	150	TRV-1D	149	UN-20D	152	V-3G	195
TOYO-10E	214	TRI-8D	150	TRV-1DE	209	UN-20I	152	VA-1	154
TOYO-11	55	TRI-8I	150	TRV-1E	209	UN-21D	152	VA-2	154
TOYO-11.P	55	TRI-9D	150	TRV-2D	150	UN-21I	152	VA-3	154
TOYO-12	26--55	TRI-9I	150	TRV-3D	150	UN-22D	152	VA-4D	154
TOYO-12.P	26--56	TRI-10D	150	TRV-4D	180	UN-22I	152	VA-5	154
TOYO-12.P1	56	TRI-10I	150	TV-3D	151	UN-23D	152	VA-6	48
TOYO-12D	55	TRI-11D	150	TV-1I	151	UN-23I	152	VA-7	49
TOYO-12D.P	56	TRI-11I	150	TV-12	151	UN-24D	152	VA-8D	154
TOYO-12D.P1	56	TRI-12D	150	TV-15D	151	UN-24I	152	VA-9D	154
TOYO-12E	214	TRI-12I	150	TVS-1.P	79	UN-25D	152	VA-10	3--10
TOYO-13	55	TRI-13	150	TVS-1.P1	79	UN-25I	152	VA-12D	154
TOYO-13.P1	56	TRI-17D	150	TVS-1D.P	79	UN-26D	152	VA-13D	154
TOYO-13E	214	TRI-18	150	TVS-2D.P	79	UN-26I	152	VA-13I	154
TOYO-14	9-26-32-41-54	TRI-18D	150	TVS-3.P	79	UN-27D	152	VA-17.P	49
TOYO-14.P	10-26-32-41-54	TRI-19	150	TX-4D	181	UN-27I	152	VA-19	154
TOYO-15	56	TRI-19D	150	TX-5D	153	UN-29I	152	VA-21	154
TOYO-15.P	56	TRI-22	150	TX-6	153	UN-30I	152	VA-22	154
TOYO-15D.P	56	TRI-22D	150	TX-7	153	UN-31I	152	VA-24D	154
TOYO-15E	214	TRI-23	150	TX-7D	153	UN-33I	152	VA-24I	154
TOYO-16	56	TRI-23D	150	TX-8	153	UN-35D	153	VA-33D	154
TOYO-16.P	56	TRI-24D	150	TX-8D	153	UN-35I	152	VA-34	49
TOYO-16.P1	56	TRI-25D	150	TX-9	153	UN-36D	153	VA-34.P	49

Índice de referencias
Index des références

REF.	PAG.	REF.	PAG.	REF.	PAG.	REF.	PAG.	REF.	PAG.
VA-34.P1	50	VO-13	59	WIB-6	157	YA-24I	157	YA-73D	166
VA-59	154	VO-AH	58	WIB-7	157	YA-25D	165	YA-75D	166
VA-61C1	64	VO-AH.P	58	WIB-8	157	YA-25I	165	YA-77D	158
VA-LA	154	VO-FH.P1	59	WIL-1D	156	YA-26I	165	YA-78	158
VA-LB	154	VO-HV	4--58	WIL-3D	156	YA-27	165	YA-78D	158
VA-LC	154	VO-HV.P	4--58	WIN-5	157	YA-27D	165	YA-80	160
VA-LD	154	VO-K	59	WLC-1D	156	YA-28	165	YA-80D	160
VA-LE	154	VO-K.P	59	WND-1	157	YA-30	185	YA-82D	166
VA-LF	154	VO-L	59	WRI-1D	157	YA-32D	165	YA-82DE	211
VA-LG	154	VO-L.P	59	X		YA-33D	164	YA-84	181
VA-LH	154	VO-M	59	XL-1	157	YA-34D	165	YA-84D	181
VA-RA	154	VO-N	58	XL-1E	210	YA-34DE	210	YA-85	166
VA-RB	154	VO-N.P	58	Y		YA-41	158	YA-85D	166
VA-RC	154	VO-R	59	YA-1D	157	YA-41D	158	YA-90	166
VA-RD	154	VO-VA	59	YA-1DE	210	YA-41DC	158	YA-91	160
VA-RDH	154	VO-VB	58	YA-1I	157	YA-41DE	210	YA-91D	160
VA-RE	154	VO-VB.P	58	YA-1X	200	YA-42	165	YA-92	160
VA-RF	154	VO-VB.P1	59	YA-2D	157	YA-42D	165	YA-92D	160
VA-RG	154	VO-VBD	58	YA-2X	200	YA-43	164	YA-93	160
VA-RH	154	VO-VBD.P	58	YA-3D	164	YA-43D	164	YA-93D	160
VE-1D	155	W		YA-3D.P	164	YA-44	165	YA-94	160
VER-1	155	WA-4D	155	YA-3I	164	YA-44D	8-165	YA-94D	160
VER-1D	155	WA-4I	155	YA-3X	200	YA-44DE	210	YA-95	160
VER-2D	155	WA-5D	155	YA-4G	194	YA-44E	210	YA-95D	160
VI-1D	155	WA-5DP	155	YA-5D	164	YA-45	39--165	YA-96	160
VI-1I	155	WA-5I	155	YA-5I	164	YA-45D	8-19-165	YA-96D	160
VI-2D	155	WAH-1	155	YA-6D	164	YA-45DE	210	YA-97D	161
VI-2I	155	WAH-1D	155	YA-6I	164	YA-45E	210	YA-98D	161
VI-2IE	209	WAS-1	20	YA-7D	164	YA-46D	165	YA-99D	161
VI-4D	155	WAS-7D	14	YA-7I	164	YA-54	165	YA-100D	161
VI-4DP	155	WAS-7I	14	YA-8D	164	YA-54D	165	YA-101D	161
VI-4I	155	WAS-9	14	YA-10	165	YA-54DE	210	YA-102D	161
VI-4IP	155	WAS-9D	14	YA-10D	165	YA-55	165	YA-103D	161
VI-6D	155	WEI-1	155	YA-11D	165	YA-55D	165	YA-104D	161
VI-7	155	WEI-1E	209	YA-11I	165	YA-56D	165	YA-105D	161
VI-12	155	WEI-2	156	YA-12I	165	YA-57	160	YA-106D	161
VI-13	155	WEI-2E	209	YA-13D	165	YA-57D	160	YA-107	162
VI-13D	155	WEI-3	156	YA-13DE	210	YA-58	160	YA-108	162
VI-13DE	209	WEI-3C	156	YA-13I	165	YA-58D	160	YA-109	162
VI-13E	209	WEI-3E	210	YA-14D	165	YA-59	160	YA-110	162
VI-14	181	WEI-4	156	YA-14I	165	YA-59D	160	YA-111	162
VO-1	58	WEI-5	156	YA-15D	165	YA-60D	166	YA-112	162
VO-2	58	WEI-6	155	YA-15I	165	YA-63D	164	YA-113	162
VO-2.P	58	WEI-8	156	YA-16D	50--164	YA-64D	166	YA-114	162
VO-2.P1	58	WEI-11	156	YA-17D	159	YA-65	181	YA-115	162
VO-2D.P	58	WEI-12	156	YA-17DE	210	YA-69	158	YA-116	162
VO-2D.P1	58	WEI-17D	156	YA-17I	159	YA-69D	158	YA-117D	162
VO-5.P	58	WEI-18D	156	YA-18D	50	YA-69DE	211	YA-118D	162
VO-8	58	WES-1D	156	YA-20D	50	YA-69E	211	YA-119D	162
VO-8.P	58	WES-1DE	210	YA-20I	50	YA-70	158	YA-120D	162
VO-8.P1	58	WES-3D	156	YA-21I	50	YA-70D	158	YA-121D	162
VO-8D.P1	58	WIB-1	157	YA-22D	158	YA-70DE	211	YA-122D	162
VO-9D	58	WIB-2	157	YA-22DE	210	YA-70E	211	YA-123D	162
VO-10D	58	WIB-3	157	YA-22I	158	YA-71	166	YA-124D	162
VO-11	59	WIB-4	157	YA-24D	158	YA-72	166	YA-125D	162
VO-12	59	WIB-5	157	YA-24DE	210	YA-73	166	YA-126D	162

REF.	PAG.	REF.	PAG.	REF.	PAG.	REF.	PAG.	REF.	PAG.
YA-127D	163	YA-174D	163	YA-250D	164	YAMA-16D	80	YET-8D	167
YA-128D	163	YA-175D	163	YA-251D	164	YAMA-16I	80	YET-9	167
YA-129D	163	YA-176D	163	YA-252D	164	YAMA-17D	80	YET-9D	167
YA-130D	163	YA-177D	163	YA-253D	164	YAMA-17I	80	YET-10	167
YA-131D	163	YA-178D	163	YA-254D	164	YAMA-18D	75-78-80	YET-10D	167
YA-132D	163	YA-179D	163	YA-255D	164	YAMA-18D.P	81	YET-11	167
YA-133D	163	YA-180D	163	YA-256D	164	YAMA-18I	75-80	YET-11D	167
YA-134D	163	YA-181D	163	YA-257	164	YAMA-18I.P	81	YU-ID	60
YA-135D	163	YA-182D	163	YA-258	164	YAMA-19D	75-78-81	Z	
YA-136D	163	YA-183D	163	YA-259	164	YAMA-19D.P	81	ZA-1.P	70
YA-137	158	YA-184D	163	YA-260	164	YAMA-19I	75-78-81	ZA-2.P	48
YA-137D	158	YA-185D	163	YA-261	159	YAMA-19I.P	81	ZA-4D.P	70-76-79-82
YA-138	159	YA-186D	159	YA-262	159	YAMA-20D	78--80	ZA-6D.P	70
YA-138D	159	YA-187D	159	YA-263	159	YAMA-20D.P	81	ZA-6D.P1	69
YA-138DE	211	YA-188D	159	YA-264	159	YAMA-20I	78--80	ZA-7D.P	70-77
YA-138E	211	YA-189D	159	YA-265	159	YAMA-20I.P	81	ZA-8.P	70
YA-139	159	YA-190D	159	YA-266	159	YAMA-21I	81	ZA-9.P	70
YA-139D	159	YA-191D	159	YA-267	159	YAMA-21I.P	81	ZA-9.P1	70-73-76-79-82
YA-146	162	YA-192D	159	YA-268	164	YAMA-22D.P	81	ZA-12	75-76-79
YA-147	162	YA-193D	159	YA-269	164	YAMA-22I.P	81	ZE-1X	201
YA-148	162	YA-194D	159	YA-270	164	YAMA-23D.P	78--81	ZE-2X	201
YA-149	162	YA-195D	159	YA-271	164	YAMA-23I.P	78--81	ZE-3X	201
YA-150	162	YA-196D	160	YA-272	166	YAMA-24D.P	81	ZE-4X	201
YA-151	162	YA-197D	160	YA-272D	166	YAMA-24I.P	81	ZE-5D	167
YA-152	162	YA-198D	160	YA-275	159	YAMA-25D.P	81	ZE-5I	167
YA-153	162	YA-199D	160	YA-275D	159	YAMA-26	81	ZE-5X	201
YA-154	162	YA-200D	160	YA-276	159	YAMA-26.P	81	ZE-6X	201
YA-155	162	YA-201D	160	YA-276D	159	YAMA-26D	81	ZE-K5	167
YA-156	161	YA-202D	160	YA-277D	164	YAMA-26D.P	81	ZE-K6	167
YA-156D	161	YA-203D	160	YA-278D	166	YAMA-27	81	ZEN-ID	167
YA-157	161	YA-204D	160	YA-279D	166	YAMA-27.P	81		
YA-157D	161	YA-205D	160	YA-284D	158	YAMA-27D	81		
YA-158	161	YA-206D	159	YA-285D	158	YAMA-27D.P	81		
YA-158D	161	YA-207D	159	YA-302	166	YAMA-28.P	81		
YA-159	161	YA-208D	159	YA-302D	166	YAMA-29.P	81		
YA-159D	161	YA-209D	159	YAMA-1D	80	YAMA-30.P	81		
YA-160	161	YA-210D	159	YAMA-1I	80	YAMA-31D.P	82		
YA-160D	161	YA-211D	159	YAMA-2D	80	YAMA-32D.P	82		
YA-161	161	YA-212D	159	YAMA-2I	80	YAMA-34D	60		
YA-161D	161	YA-213D	159	YAMA-3D	80	YAMA-35D.P2	82		
YA-162	161	YA-214D	159	YAMA-3I	80	YAMA-36D.P	82		
YA-162D	161	YA-235D	159	YAMA-4D	80	YAMA-37D	82		
YA-163	161	YA-236D	159	YAMA-5D	80	YAR-1	181		
YA-163D	161	YA-237D	159	YAMA-5I	80	YAR-2	181		
YA-164	161	YA-238D	159	YAMA-6D	80	YAR-3	181		
YA-164D	161	YA-239D	164	YAMA-6I	80	YAR-5D	181		
YA-165	161	YA-240D	164	YAMA-7D	80	YET-1	166		
YA-165D	161	YA-241D	164	YAMA-7I	80	YET-1D	166		
YA-166D	163	YA-242D	164	YAMA-12D	80	YET-2	166		
YA-167D	163	YA-243D	164	YAMA-12I	80	YET-2D	166		
YA-168D	163	YA-244D	164	YAMA-13D	80	YET-5	166		
YA-169D	163	YA-245D	164	YAMA-13I	80	YET-5D	166		
YA-170D	163	YA-246D	164	YAMA-14D	80	YET-6D	166		
YA-171D	163	YA-247D	164	YAMA-14I	80	YET-7	167		
YA-172D	163	YA-248D	164	YAMA-15D	80	YET-7D	167		
YA-173D	163	YA-249D	164	YAMA-15I	80	YET-8	167		

Índice de marcas
Index des marques

FOR:	PAG.
126 ®	190
ABLOY ®	85
ABSA ®	85
ABUS ®	85, 86, 166, 171, 173
ACURA ®	1
ADAMS RITE ®	105, 119, 155, 158
AGA ®	86, 171, 190
AGB ®	87, 171
AGE ®	87
AGUIA ®	87
AKI ®	171
ALFA ®	171
ALFA ROMEO ®	1, 2, 12
ALIANCA ®	87
ALISON ®	87
ALMET ®	89
ALPHA ®	87
AMC ®	87
AMERICAN LOCK ®	87, 88, 205
AMERICAN MOTORS ®	2, 3, 212
AMEROCK ®	131
AMIG ®	171
ANDESLOCK ®	171
ANKER ®	88
ANTAR ®	88
ANVER ®	88
APECS ®	171
APRILIA ®	69, 70, 79
ARCA ®	88, 89
AROUCA ®	89
ARROW ®	89, 205
ARTIC CAT ®	80
ASHICO ®	89, 172
ASIA ®	89
ASSA ®	89, 90
ASTON MARTIN ®	3
ATALA ®	70
ATRA ®	190
AUDI ®	3, 4
AUGUSTA ®	199
AUSTRAL ®	90, 91
AUT FLORENCE ®	91
AUTOBIANCHI ®	1, 2, 12
AVCE ®	91
AZBE ®	91, 158, 172
BAJAJ ®	69
BALDWIN ®	91
BAODEAN ®	172
BARGMAN ®	91, 119
BASTA ®	91
BAUER ®	91, 92
BELLEVILLE ®	92
BEDFORD ®	3, 4, 50
BENTLEY ®	50
BEST ®	92, 205
BETA ®	70, 190

FOR:	PAG.
BEY ®	92, 172
BILMA ®	93
BIMETAL ®	172
BIMOTA ®	69, 70
BKS ®	93
BMW ®	4, 5
BMW MOTORCYCLE ®	69, 70, 79
BOMBARDIER ®	5, 75, 80
BOMMER ®	117
BORGWARD ®	5, 6
BORKEY ®	178
BOSCH ®	6
BOXER ®	69
BRASIL ®	93
BREVETTO ®	93
BRICARD ®	93
BRIGGS & STRATTON ®	2, 6, 25, 32
BRITISH LEYLAND ®	3, 4, 6, 7, 50, 212
BRUMME ®	93
BUELL ®	7, 79
BULAT ®	172
BURG ®	93, 94, 199
BUVA ®	94
CAGIVA ®	70, 74, 79
CAM LOCK ®	94
CAN AM ®	75, 80
CANADA POST ®	94, 108
CANTOL ®	94, 173, 205
CASH BOX ®	94
CATERPILLAR ®	7
CAVERS ®	95
CAYS ®	173
CCL ®	95, 96, 205
CEMEX ®	96, 97
CENTURY ®	97
CERUTTI ®	191
CES ®	97, 98, 173
CESSNA ®	8
CHALLENGER ®	98
CHICAGO ®	98, 99, 205
CHRYSLER ®	8, 9, 10, 40, 41, 63, 212
CHUBB ®	99
CIEF ®	99
CIFIAL ®	199
CINA ®	99
CISA ®	99, 158, 173, 191, 205
CITROEN ®	10, 11
CLARK FORK LIFT ®	185
CLINTON ®	100
THE CLUB ®	11
CLUB CAR ®	100
CLUM IMBOARD MOTORS ®	11
CORBIN ®	100, 101, 102, 103, 104, 146, 174, 206
CORONA ®	104
CR ®	191, 192
CVL ®	104, 173

FOR:	PAG.
D.A.F ®	3, 45
D.K.W ®	5, 7, 11, 44
DAD ®	105
DACIA ®	63
DAEWOO ®	11, 12
DAF ®	105, 173
DAIHATSU ®	11, 12, 56
DEKABA ®	105
DERBI ®	70, 79
DEXTER ®	105, 106, 127, 171, 173, 206
DIAMOND ®	106
DIEBOLD ®	185
DIMSA ®	106
DISCOVERY ®	69
DIXON ®	106, 107, 199
DOM ®	107, 108, 174
DOMINION LOCK ®	108, 113
DONNER ®	121
DUCATI ®	74, 75
DURALOCK ®	108
EAGLE LOCK ®	108, 117
EARLE ®	109
EBERHARD ®	109
ELEPHANT ®	109
ELGIN ®	109
ELITE ®	73
EMKA ®	109
ENGELSDA ®	109
ERA ®	109
ESP ®	109
EURO BOX ®	109
EURO LOCKS ®	109
EUROLATON ®	174
EVINRUDE MOTORS ®	12
EVERGOOD ®	109
EVVA ®	110
EZCURRA ®	174, 192
EZ SET ®	110, 126
F.F ®	110
FAB ®	110
FAC ®	110, 174, 192
FALCON ®	110, 111, 155, 156, 206
FAMA ®	111
FANAL ®	111, 174, 206
FAZER ®	82
FECHADURA ®	112
FEMSA ®	112
FERMAX ®	174
FERP ®	112
FERRARI ®	1, 2, 7, 34
FIAM ®	192, 199
FIAT ®	1, 2, 12, 13, 14, 63
FIC ®	112
FICHET ®	112
FLOOD ®	112
FORD ®	3, 14, 15, 16, 17, 18, 35, 63, 212, 213

FOR:	PAG.
FORD INTERNATIONAL ®	6, 7, 11, 17, 18, 19, 45, 58
FORD TRACTOR ®	19
FORD TRUCK COVER ®	19
FORT ®	112, 113, 206
FORTE ®	113, 174, 206
FREIGHTLINER ®	6, 19
FTH ®	113, 174
FULTON HITCH ®	113
FZ ®	82
GAS ®	19, 20
GATO ®	113, 114, 174
GE-GE ®	114
GENERAL ®	114, 115
GENERAL MOTORS ®	20, 21, 22, 23, 24, 25, 26, 63, 213
GEO ®	21, 23
GERSDA ®	173
GIBBONS ®	115
GILERA ®	70
GIUSSANI ®	115
GIVI ®	70
GLOBE ®	115, 116
GOLD ®	116
GOLF CART ®	26
GUARD ®	199
GUARD SECURITY ®	116
GUERVILLE ®	116
HAFELE ®	117
HALO ®	117
HARLEY DAVIDSON ®	70, 71
HARLOC ®	117, 148, 206
HAYWORTH ®	117
HENDERSON ®	117
HERD ®	117
HERMEX ®	175
HERO ®	73
HINO ®	26
HONDA ®	4, 26, 27, 28, 63, 213
HONDA MOTORCYCLE ®	71, 72, 73
HORNET ®	72
HUDSON ®	117, 118, 165, 206
HUF ®	28
HURD ®	118, 165
HUWIL ®	118
HYUNDAI ®	21, 28, 29, 30, 31, 64
IFAM ®	118, 119, 148, 149, 172, 175
ILARGI ®	119
ILCO ®	119, 206, 207
ILLINOIS ®	120, 149
IMPORT ®	120, 125, 148
INDAK ®	32
INDIAN ®	19
INFINITI ®	43, 44
ISEO ®	173, 175, 192
ISUZU ®	21, 28, 31, 32, 70, 79
ITAL ®	192
ITALIKA ®	60, 73, 74



Índice de marcas
Index des marques

FOR:	PAG.
ITALJET ®	70, 81
IVECO ®	2, 7
JAGUAR ®	3, 4, 6, 7, 13, 18, 19
JEEP ®	2, 3
JEN-WEI ®	120
JIS ®	120
JOHN DEERE ®	32
JOHNSTON MOTORS ®	12
JOWIL ®	120
JUNIE ®	120
KABA ®	175
KALE ®	120, 121, 175, 176, 192
KAWASAKI ®	74, 75, 77
KEIL ®	121
KENWORTH ®	32, 33
KESO ®	176
KFV ®	121
KIA ®	30, 33, 34
KIMBALL ®	121
KIMBERLEY CLA. ®	121
KOMATSU ®	34
KUBOTA ®	34
KWIKSET ®	121, 122, 207
KYMCO ®	75, 76
L.K.W ®	5, 6
LAMBORGHINI ®	1, 2
LAMBRETTA ®	76
LANCIA ®	34
LAPERCHE ®	122
LAPORTE ®	122
LAR ®	193
LARSON DOOR ®	122
LAS ®	122
LASBOLAGET ®	122
LAVERDA ®	70
LEGGI ®	122
LEXUS ®	56
LIBERO ®	82
LINCE ®	122, 123, 176
LION ®	123
LIPS ®	123
LITTO ®	123
LLOYD ®	52
LOCK ®	123, 124, 176, 194
LOCKWOOD ®	124, 207
LORI ®	125
LOTUS ®	176
LOWE & FLETCHER ®	125
LSDA ®	126, 207
LLOYD ®	52
LOTUS ®	176
MACK ®	6, 23, 34
MAGIRUS DEUTZ ®	6, 34
MAGNUN ®	126, 176
MAHINDRA ®	34
MALAGUTI ®	70, 76, 79, 81

FOR:	PAG.
MARINER OUTBOARDS ®	11, 17, 39
MASERATI ®	1, 7, 34
MASTER ®	126, 127, 128, 176, 207, 208
MASTER LOCK ®	176
MATRA ®	10, 46, 47, 48, 52
MAUER ®	105
MAZDA ®	15, 21, 35, 36, 37, 56, 64, 70, 76, 213
MBK ®	81
MCM ®	128, 176, 177
MECO ®	128
MEDECO ®	128, 129
MERCEDES BENZ ®	37, 38, 39, 44
MERCURY ®	11, 17, 39
MERONI ®	129
METAL ROUSSEAU ®	129
METEOR ®	129
MG ®	129, 130
MG (MONTI) ®	130
MHA ®	177
MILES ®	185
MINCRAFT PADLOCK ®	130
MINGO ®	130
MING-TAY ®	130
MIS. SWITCHES ®	6, 8, 39
MISCELLANEOUS ®	185
MITSUBISHI ®	39, 40, 41, 64, 214
MIWA ®	130
MLM ®	130
MOB ®	3
MOBELLA ®	130
MONOBLOC ®	130
MORETTI ®	42
MOSLER ®	185
MOTO GUZZI ®	70, 75, 76
MOTOMEL ®	76
MOTTURA ®	130, 193
MULT.LOCK ®	177
MV ®	75
MZ ®	76, 130
NATIONAL CABINET ®	130, 131, 208
NATIONAL CASH REGISTER ®	131
NATIONAL LOCK ®	131, 208
NATIONAL ROCKFORD ®	131, 208
NAVI ®	72
N.S.U ®	5
NICE ®	131
NISSAN ®	42, 43, 44, 64
NORTON ®	3, 7
ODA ®	88
ODIS ®	131, 132, 177, 178
OJMAR ®	132
OMC ®	12
OPEL ®	4, 5, 18, 44, 45, 64, 214
OSTER ®	153
P & CI ®	132
PADO ®	132

FOR:	PAG.
PANHARD ®	45, 49
PANTERA ®	2, 18
PAPAIZ ®	133, 178, 199, 200, 208
PETCO ®	121
PETERBILT ®	32, 33, 46
PEUGEOT ®	10, 46, 47, 48, 64
PEUGEOT MOTORCYCLE ®	76
PHILLIPS ®	133, 134, 178, 185, 194, 200, 208
PIAGGIO ®	76, 77
PIPER AIRCRAFT ®	8
POLARIS ®	39, 40, 48, 70, 75, 80
POLI ®	134, 178
PORSCHE ®	4, 48
PREFER ®	134, 158
PRUREB ®	176
PUNDRÁ ®	134
PULSAR ®	69, 72
RABBIT ®	135
RAD ®	119
REGAL ®	135
RENAULT ®	2, 3, 14, 34, 46, 47, 48, 49, 50, 64
RIZZATO ®	70
RICOUARD ®	135
RIL ®	185
RILEY ®	50
ROLLS ROYCE ®	50
RONE ®	135
RONIS ®	135
ROOTES GROUP ®	7, 50
ROPERO ®	195
ROPERO ARTISTICAS ®	195
ROVER ®	18, 50, 51
RTR ®	79
RUKO ®	136
RUSSWIN ®	104, 136, 137, 138, 208
SAAB ®	51
SAFE ®	138
SAMSONITE ®	138, 139
SARGENT ®	139, 140, 141, 142, 208
SATURN ®	24
SCANAVINI ®	142, 143, 178
SCHALAGE ®	143, 144, 178, 208, 209
SCHLECTENDAHL ®	144
SCOLTA ®	145
SCOVILL ®	145, 178
SEA ®	179
SEAT ®	10, 12, 52
SECUREMME ®	179, 193
SECURITAL ®	145
SECURITY ®	165
SEGAL ®	145, 209
SELECT ®	145
SENTRY SAFE ®	145
SERRALLER ®	193
SHANGAI ®	146
SHAW WALKER ®	146

FOR:	PAG.
SHINE ®	72
SICUREZZA ®	179
SIMCA ®	10, 46, 47, 48, 52
SIMECA ®	146
SIS ®	146
SKILMAN ®	146, 209
SKODA ®	52
SKODA MOTORBIKE ®	77
SLAYMAKER ®	146
SOPRANO ®	146, 179
SOS ®	146
SPORT ®	79
SOUTHERN IMPERIAL ®	146
SQUIRE ®	147
SSANGYONG ®	52
STA-LOCK ®	147
STAR ®	147
STERLING TRUCK ®	50
STS ®	147, 179
STUDEBAKER ®	8, 39
STUV ®	147
SUBARU ®	43, 44, 53
SUN ®	147
SUNBEAM ®	42
SUREX ®	147
SUZUKI ®	53, 54, 65
SUZUKI MOTORCYCLE ®	69, 72, 77, 78, 79, 80
SWEDISH CAMP CAR ®	54
TALBOT ®	10, 46, 47, 48, 52
TAYLOR ®	147, 148, 209
TECUMSEH ®	185
TEKA ®	148
TESA ®	148, 179, 180, 209
TICINO ®	148
TIFON ®	148, 149
TIMBERLINE ®	149, 209
TITAN ®	54, 121
TOK WINKHAUS ®	149
TOOL BOX ®	54
TOVER ®	149, 180, 194
TOYOTA ®	25, 54, 55, 56, 57, 65, 214
TRABANT ®	57
TRAVEX ®	149, 150, 180, 209
TRI CIRCLE ®	150
TRIMARK ®	150, 151
TRIO-VING ®	151
TRIUMPH MOTORCYCLE ®	79
TRUPER ®	151, 152, 180
TVS ®	69, 79
UCEM ®	152
UNION ®	152, 153, 180, 194
UNIVERSAL ®	153, 181
URBIS ®	181
URKO ®	153, 154
VACHETTE ®	154
VAN GUARD ®	6, 50



Índice de marcas
Index des marques

FOR:	PAG.
VAUXHALL ®	6, 7, 45, 50, 51, 57
VEGA ®	155
VERA ®	155
VESPA ®	81
VESPER ®	47
VICTORY ®	70, 79
VIKING ®	4, 52
VIRO ®	155, 181, 209
VOLKSWAGEN ®	4, 5, 44, 51, 58, 59, 65
VOLVO ®	3, 7, 50, 59, 60
WAH TUNG ®	155
WALLY ®	155
WEISER ®	155, 156, 209, 210
WELCH ®	156
WESLOCK ®	156, 210
WILKA ®	156
WILSON BOHANNON ®	157
WIND ®	157
WINKHAUS ®	157
WOLSLEY ®	50
WRIGHT PRODUCTS ®	157
XL LETTER BOX ®	157, 210
YALE ®	145, 148, 157, 158, 159, 160, 161, 162, 163, 164, 165, 166, 178, 181, 185, 194, 210, 211
YALE BKS ®	200
YAMAHA ®	79, 80, 81, 82
YAMAHA OUTBOARD ®	60
YARD TRACTOR ®	32
YARDENI ®	181
YETI ®	166, 167
YUGO ®	2, 60
ZEISS IKON ®	167, 201
ZENI ®	167

CROSS REF.	REF.	PAG.	CROSS REF.	REF.	PAG.	CROSS REF.	REF.	PAG.	CROSS REF.	REF.	PAG.
ALBA ®			A81DP	CHR-14.P	9	CM3	MGG-3D	130	E124	JEN-1	120
73VB	PHI-3X	200	A81E	CHR-15	9	CM4	MGG-4D	130	EC5	TE-T10	179
A24	GAS-1D	19	A81EP	CHR-15.P	9	CS01	SOP-4D	179	EU1	EUL-1D	174
A24	GM-26	23	A81P	CHR-9.P	8	CVL3R	CVL-5I	104	EX3A	SAA-AC	51
A24R	GAS-1	19	A82	GM-22	22	E1A	COR-62	102	EX5	BM-W	5
A24R	GAS-1S	20	A82A	GM-23	22	E1L	COR-34	101	EX6	NE-9	59
A46	NE-4D	10--46	A82AP	GM-23.P	22	E1LL	COR-32	101	EX6B	NE-10	50--59
A46C	NE-4	10--46	A82P	GM-22.P	22	E2L	COR-174	101	EX8A	ME-HZ	38
A46R	NE-15I	14	A83	DAT-14	43	E2LL	COR-33	101	EX8B	ME-HD	38
A52	ME-15D	38	A83P	DAT-14.P	43	E4A	SAR-5D	142	EX8C	ME-HF	38
A52C	ME-15	38	A84P	ME-HD.P	38	E4B	SAR-3D	139	EX9	IMS-3	2
A61B	DAT-3D	42	A85	ME-1	37	E8	RUS-7	137	EX9A	IMS-5	2
A61D	TOYO-25	57	A85P	ME-1.P	37	E10	CHI-4	48--98	EX12	HOND-3D	71
A61N	DAT-21	44--53	A86	OP-S	25--45	E19	CHI-5	98	EX12C	HOND-3I	71
A61NC	DAT-21D	44	A86C	OP-D	45	E21LL	COR-85	101	EX13	TOYO-8	55
A61NCP	DAT-6D.P	42	A86CP	OP-D.P	45	E22LL	COR-46	101	EX14	MAZ-2I	35
A61NP	DAT-6.P	42--53	A86P	OP-S.P	25--45	E27	CHI-3	48--98	EX14A	MAZ-2D	35
A63	OP-7	44	A87	DAT-22	44	E38	COR-41D	101	EX20	HOND-34	26
A64	GM-6	21	A87P	DAT-22.P	44	E38A	COR-42	101	EX21	MAZ-3D	35
A64A	AMM-1	19	A88	GM-29D	23	E38B	COR-43D	101	EX21C	MAZ-3I	35
A64N	GM-16	22	A88A	GM-15D	26--28	E38C	CCL-1D	95	EX21CP	MAZ-3I.P	35
A64P	GM-6.P	21	A88B	GM-4	21	E38D	TRI-7I	150	EX21L	MAZ-13D	36
A65	GM-10	22	A88C	GM-29	23	E41L	GLO-4I	115	EX21P	MAZ-3D.P	35
A65P	GM-10.P	22	A88D	TOYO-9	55	E42A	CMX-2D	96	EX22	TOYO-20D	56
A66	GM-7	21	A89	GM-14	22	E42AN	CMX-1D	96	EX22C	TOYO-20	56
A66NP	GM-19.P	22	A89P	GM-14.P	22	E42D	CMX-3D	96	EX23A	MAZ-17D	36
A66P	GM-7.P	21	A89S	GM-25	23	E42DN	CMX-10D	97	EX23L	MAZ-4	35
A67	GM-11	22	A89SP	GM-25.P	23	E42H	CMX-9D	97	EX24	TOYO-34	57
A67P	GM-11.P	22	A90	CLB-1D	11	E42K	CMX-8D	97	EX24A	TOYO-15	56
A68	CHR-8	8	A90C	CLB-1	11	E52	SAR-4D	139	EX24AP	TOYO-15.P	56
A68P	CHR-8.P	8	A91	DAT-16	43	E53	SAR-4	139	EX24B	TOYO-16	56
A69	CHR-12	8	A91A	DAT-20	44	E79D	EAG-1D	108	EX24C	TOYO-2	54
A69B	GM-27	23	A91AP	DAT-20.P	44	E96G	BRE-2	93	EX24D	TOYO-33D	57
A70	GM-8	21	A92	DAT-19	43	E97A	BRE-1	93	EX25A	KEN-2D	32
A70P	GM-8.P	21	A92P	DAT-19.P	43	E97B	BRE-1D	93	EX25AP	KEN-2D.P	33
A71	AMM-2	2	A93	GM-2	21	E99	RON-6D	135	EX26	HY-2	28
A72	GM-9	2--21	A120	RO-4I	10--34-52	E99E	RON-2D	135	EX28	HY-4	29
A72P	GM-9.P	2--21	A121	NE-20	2--9--46	E99N	RON-8D	135	EX28B	HY-6D	29
A73	GM-12	22	A125	RO-11I	47	E101	RON-7D	135	EX28P	HY-5.P	29
A73P	GM-12.P	22	A1145HONSS5	SCO-11	145	E101E	RON-4D	135	EX29A	HY-3D	28--39
A74	TOYO-K1	54	A1145HONSS9	SCO-12	145	E108N	WES-1D	156	EX31	GM-47D	25--31
A74C	TOYO-14	9-26-32-41-54	AA2	AU-W	4	E109A	KWI-1KS	121	EX32	HOND-39D	1
A74L	TOYO-12	26--55	ABS43P	TOV-1G	194	E109A	KWI-1K	121	EX32	HOND-14	27
A74LC	TOYO-12D	55	ASSA5	PHI-5D	178	E109L	DX-12D	105	EX33	HOND-16D	27
A78	GM-13	22	ASSA5S	PHI-14D	178	E110	DX-4	105	EX33A	HOND-15	27
A78P	GM-13.P	22	AZ6R	AZ-9D	172	E112	RON-3D	135	EX34	HOND-10	27
A79	DAT-17D	43	AZ7	AZ-14	172	E113	RON-1D	135	EX34	HOND-40D	1
A79C	DAT-17	43	BN4	KAE-1	175	E114	RON-5D	135	EX36	MIT-8D	40
A80	DAT-18	43	BN6	KAE-4	175	E117	CMX-6D	96	EX36A	MIT-16	41
A81	CHR-9	8	C28	R-1G	195	E118	CMX-5D	96	EX36B	MIT-7	40
A81A	CHR-10	8	C28	R-1Z	195	E119	HUD-3	96--117	EX37	ISU-1	31
A81AP	CHR-10.P	8	CAS1	ASH-3D	172	E119C	HUD-3D	117	EX38	FI-3	12
A81B	CHR-16	9	CE6	SAR-15	142	E120	COR-1D	100	EX38C	FI-3D	12
A81D	CHR-14	9	CM1	MGG-1D	129	E120A	ARR-1	108	EX38E	MAZ-1I	35
			CM2	MGG-2D	130	E120S	COR-27D	100	EX39	BM-2	4



COMPETITOR CROSS REFERENCE

Índice comparativo
Index comparatif

CROSS REF.	REF.	PAG.	CROSS REF.	REF.	PAG.	CROSS REF.	REF.	PAG.	CROSS REF.	REF.	PAG.	CROSS REF.	REF.	PAG.	CROSS REF.	REF.	PAG.	CROSS REF.	REF.	PAG.			
BN1	BRG-1	91	HL1	HAO-1D	117	SE1	SEG-1DL	145	BMW2P	BM-HB.P	5--69	PZ2	PAP-2	133	HN3	HIN-1	26	CR4RP	ME-1.P	37	AG5	AGE-2D	87
BO1	HUD-3D	117	HO1	CHL-1	98	SK1	SKI-1D	146	BT2	BE-4D	92	RA2	BS-1I	2	HU3	HUW-N	118	DE4	DX-4	105	ALP5	ALP-5D	87
BO1	HUD-3DE	206	HR1	HAR-2D	117	SK1	SKI-1DE	209	BU2	BL-1D	11--44	SE2	SEG-2D	145	HY3	HY-16	30	DNDSC4	SLG-4C	143	AP5	CHI-1I	98
BR1	BRU-1D	93	IG1	IL-1D	119	SL1	SLY-1D	146	BV2	BU-1I	94	SIM2	GIU-1	115	IF3L	IF-45/55	119	DT4	DAT-3D	42	B5	AMM-4	2-32-217
BT1	BE-5D	92	IG1R	IL-1I	119	SOS1	SOS-2D	146	BW2	BAL-2	91	STA2	STL-2I	147	IF3S	IF-35	118	DW04RAP	DAE-3D.P4	12	B5	AMM-4E	212
BU1	BL-1I	11--44	IL1	ILL-1	120	STA1	STL-1D	147	CB2	COR-40	101	SUB2	SUB-3	53	IN3	ILC-4D	119	DXB4	DX-33	106	BKS5	BK-19/13	93
BUR1	BUR-12	94	IN1	ILC-16	119	SUB1	SUB-1	53	CC2	GOC-2D	26	SUZ2	SUZU-1I	77	IN3	ILC-4DE	207	DXC4	DX-34	106	CLB5	CLB-3D	11
BV1	BU-1D	94	J1I	JIS-2I	120	SUB1P	SUB-1.P	53	CE2	CEM-BP	57	TE2	TE-1D	148	KAB3	KA-2	175	DXD4	DX-35	106	CN5	CO-M	104
CB1	COR-30	101	K1	KEI-1	121	SUZ1	SUZU-1D	77	CF2	CF-1I	99	TM2	TRM-6D	151	KB3	KMB-2	121	EV4	EV-13D	110	CO5	COR-83	102
CC1	GOC-1D	26--100	KAB1	KA-1	175	SXI	SR-2	147	CG2	CHI-1	12--98	TO2	TV-1I	151	KE3	KE-3	176	FH4	FIC-7	112	DNDWR5	WEI-3C	156
CE1	CENT-1D	97	KB1	KMB-1	121	TI	TAY-5D	148	CLB2	CLB-1	11	UR2	URKO-3I	154	KK3	KI-3D	33	FL4	FAL-25D	111	DW05AP	DAE-4.P1	11
CF1	CF-1D	99	KFV1	KFV-1	121	TE1	TE-1I	148	CNA2	CAT-3	7	UR2R	URKO-3D	154	KK3P	KI-3D.P	33	FTH4	TD-15	113	DW05RAP	DAE-4D.P1	11
CG1	CHI-2	12--98	KK1	KI-1D	33	TEK1	TK-2D	148	CO2	COR-44	101	VG2	VE-1D	155	KM3	PJ-1	20--47	GB4	GLO-10	116	DXG5	DX-36	106
CG1	CHI-2E	205	KK1P	KI-1D.P1	33	TM1	TRM-5D	151	CT2	CENT-3D	97	VR2	VI-1I	155	L3TX	LAS-TX	122	GU4	GR-1I	116	ER5	ER-1D	109
CL1	CLN-1	100	KW1	KWI-1K	121	TMC1	TRP-1D	76--79	DB2	DOB-2	57	WK2	WES-1D	156	L3XY	LAS-XY	122	GU4R	GR-1D	116	FL5	FAL-26D	111
CLB1	CLB-1D	11	KW1	KWI-1DL	121	TO1	TV-12	151	DE2	DX-7D	105	WK2	WES-1DE	210	LC3	LIN-7D	123	HAW4	HAW-2D	117	FL5G	WEI-6	155
CLP1	IMP-2	120	KW1	KWI-1KE	207	TT1	TIT-7D	54	DXB2	DX-25	106	WR2	WEI-17D	156	LN3	RO-25I	135	HO4	CHL-7	98	FTH5	TD-3	113
CNI	CO-1D	104	KW1	KWI-1KS	121	UR1	URKO-1I	153	DXC2	DX-28	106	WS2	WAS-7D	14	LT3	LIT-1I	123	HY4	HY-17	30	GE5	GE-1D	114
CO1	COR-82	102	KYM1P	KYM-1.P	76	UR1R	URKO-1D	153	DXD2	DX-31	106	Y2	YA-17D	159	M3	MAS-7D	126	HY4P	HY-3.P2	28	HY5	HY-3D	28--39
CT1	CENT-2D	97	KYM1RP	KYM-1D.P	76	VIS	VA-9D	154	EZ2	EZS-1	110	Y2	YA-17DE	210	ME3	MER-17	129	IN4	ILC-6D	119	HY5P	HY-3D.P1	28--39
CVL1	CVL-1I	104	L1	LWO-4D	124	VAE1	VA-3	154	FA2	WEI-5	156	YS2	FO-XR	18	MIT3	MIT-14D	41	KK4	KI-4D	33	KA5	KA-3	175
CVL1R	CVL-1D	104	L1	LWO-4DE	207	VAT1	VA-5	154	FL2	FAL-23D	111	AK3	ANK-3	88	MIT3	MIT-14DE	214	KK4P	KI-4D.P	33	KK5	KI-6	34
D1A	DAD-2I	105	LAP1	LPO-2	122	VCA1	VA-24D	154	FR2	FR-11D	113	AM3	AME-1	87	MN3	MIL-2	185	L4	LWO-5D	124	KK5P	KI-6.P	34
D1K	DAD-2D	105	LC1	LIN-1I	122	VCA1R	VA-24I	154	FR2	FR-11DE	206	AM3	AME-1E	205	PU3	PUN-3D	134	L4A1	LAS-6D	122	KM5	LAS-XS	20
D1T	DAD-1I	105	LD1	LRD-1D	122	VR1	VI-12	155	FU2	MIT-11D	41	AM3L	AME-8	87	PZ3	PAP-3	133	L4RM	LAS-KT	122	KW5	KWI-9D	122
D1V	DAD-1D	105	LF1	LF-1I	125	W1	WIB-1	157	GH2	GH-HX	54	AP3	CHI-8D	98	RA3	AMM-2	2	LC4	LIN-6D	123	LC5	LIN-5D	123
DB1	DOB-2D	57	LNI	RO-26I	135	WE1	WLC-1D	156	HAW2	HAW-3D	117	AP3	CHI-8DE	205	RK3	RU-2I	136	M4	MAS-12D	126	LC5R	LIN-5I	123
DC1	TOYO-14	9-26-32-41-54	LO1	LOR-1	125	WK1	WES-3D	156	HN2	HEN-1	117	AR3	ARR-6D	89	RO3	NTC-10D	130	MIT4	MIT-7	40	M5	MAS-11D	126
DC1P	TOYO-14.P	10-26-32-41-54	LT1	LIT-5D	123	WNI	WND-1	157	HR2	TE-7D	148	AS3	AS-M5	89	RO3	NTC-10DE	208	MIT4P	MIT-7.P	40	MIT5	MIT-13D	41
DNDM1	MAS-10C	126	M1	MAS-10	126	WS1	WAS-9	14	HR2	TE-7DE	209	AU3	AG-10D	87	SE3C	AF-1I	52	MZ4	MAZ-1I	35	MZ5	MAZ-1D	35
DNDSC1	SLG-3C	143	M1	MAS-10E	207	WTP1	WRI-1D	157	HY2	HY-15D	30--39	BAU3	BUE-3	92	SQ3	SQ-2	147	RA4	AMM-3	2	PA5	AU-W	4
DNDY1	YA-41DC	158	M1	MAS-10S	126	X1	DAT-5D	35--42	IF2	IF-125	118	BKS3	BK-19/11	93	SUZ3	SUZU-2I	77	RA4	AMM-3E	212	RI5	RO-12I	135
DO1M	DOM-6I	107	MB1	MNO-1D	130	Y1	YA-41D	158	IF2R	IF-D25	118	BMW3	BM-2	4	SV3	STUV-3	147	RN4	RO-24I	135	RO5	NTC-9D	130
DO1SR	DOM-3D	107	MCM1	MCM-1	128	Y1	YA-41DE	210	JN2	JUNI-2D	120	BMW3P	BM-2.P	4	SX3	SR-4	147	RN4R	RO-24D	135	SS5	SEN-1D	145
DXB1	DX-24	106	MG1	UN-NH	7	Y1E	YA-34D	165	K2	KEI-2	121	BT3	BE-5I	92	TE3	TE-7D	148	RU4	RUS-3	136	SZ5P	SUZU-5.P	77
DXC1	DX-27	106	MIT1	MIT-16	41	Y1E	YA-34DE	210	KAB2	KA-7	175	CB3	COR-50/60	101	TM3	TRM-7	151	RV4	NE-52	51	TK5	TOK-45	149
DXD1	DX-30	106	MIT1	MIT-16E	214	YS1	FO-XL	18	KB2	KMB-3	121	CLB3	CLB-2D	11	WK3	WIL-3D	156	RV4P	NE-52.P	51	TO5	TV-15D	151
EA1	EAG-6	108	MITIP	MIT-16.P	41	YU1	YU-1D	60	KK2	KI-2D	33	CO3	COR-81	102	WR3	WEI-1	155	S4	SAR-5D	142	UN5	UN-5D	152
EL1	ELG-3	109	MO1	MTO-1	129	ZKN1	ZE-5D	167	KM2	LAS-Y	20--46	DC3	MIT-2I	9--25--31--32--39	WR3	WEI-1E	209	SC4	SLG-4	144	WR5	WEI-3	156
ER1	EAR-1D	109	MR1	MTR-1D	129	ZKN1R	ZE-5I	167	KYM2	KYM-2	76	DC3P	MIT-2I.P	9--25--31--32--40	WS3	WAS-9D	14	SC4	SLG-4E	209	WR5	WEI-3E	210
EVA1R	EV-2	110	PHA1	PHI-52	134	ZN1	ZEN-1D	167	L2EX	LAS-1D	122	ALP4	ALP-3	87	WT3	BM-B	5	SC4	SLG-4S	143	X5	MAZ-1D	35
EZ1	LSD-1D	126	PZ1	PAP-1	133	AA2	NE-1	4	LAP2	LPO-1	122	AM4	AME-4	87	ALP4	ALP-3	87	SE4C	AF-1D	52	Y5	YA-63D	164
EZ1	LSD-1DE	207	PZ1	PAP-1E	208	AK2	ANK-2	88	LC2	LIN-1D	122	AM4	AME-4	87	AM4	AME-4	87	SS4	SEN-2D	145	YL5	YA-16D	50--164
FA1	WEI-4	156	RC1	RIO-1D	135	AP2	CHI-10D	98	LD2	LRD-1	122	AP4	CHI-7D	98	AP4	CHI-7D	98	SUZ4	SUZU-2D	77	AK6	ANK-4	88
FIC1	FCS-1D	112	RG1	REG-1D	135	AP2	CHI-10DE	205	LT2	LIT-5I	123	AP4	CHI-7DE	205	AP4	CHI-7DE	205	SZ4	SUZU-16	78	AS6	AS-K7	90
FL1	FAL-22D	111	RK1	RU-1D	136	AS2	AS-G7	90	M2	MAS-7	126	AR4	ARR-5D	89	AR4	ARR-5D	89	SZ4P	SUZU-16.P	78	6D1R	RUS-5S	137
FT1	TD-1	113	RO1	HUD-5D	118	AU2	AG-11	87	M2	MAS-7E	207	AR4	ARR-5DE	205	AS4	AS-M7	90	SZ4RP	SUZU-16D.P	78	BL6	CEM-JC	6
GB1	GLO-14	116	RU1	RUS-7	137	AZ2	AZ-3I	91	ME2	MER-16D	129	AS4	AS-M7	90	AU4	AG-10I	87	TE4	TE-8I	148	BUR6	BUR-8D	93
GH1	GH-GX	54	SAA1	SAA-AC	51	AZ2R	AZ-3D	91	MIT2	CHR-17	9--39	AU4	AG-10I	87	B4	BS-1I	6	TK4	TOK-44	149	CE6	FO-TC	6
GT1	GIOB-2I	34	SAA1P	SAA-AC.P	51	B2	GM-33	23	MIW2	MIW-2	130	B4	BS-1I	6	BAU4P	BUE-4.P	92	TM4	TRM-8	151	CLB6	CLB-3	11
HANPKW1	KWI-4D	121	SC1	SLG-3	143	BAU2	BUE-2	92	MM2	MCM-6	128	BAU4P	BUE-4.P	92	BKS4	BK-19/12	93	WR4	WEI-2	156	CO6	COR-84	101
HANPSC1	SLG-26	144	SC1	SLG-3E	209	BC2	BRI-1D	93	MTK2P	MU-2.P1	177	BKS4	BK-19/12	93	WR4	WEI-2E	209	WR4	WEI-2E	209	DE6	DX-5D	105
HO01SVC	HOND-3I	28	SC1	SLG-3S	143	BE2	BES-1DS	92	N2M	NE-6	70--77	BT4	BE-4I	92	WS4	WAS-7I	14	WS4	WAS-7I	14	DE6	DX-5DE	206
HAW1	HAW-1D	117	SCH1	SCH-1D	144	BE2	BES-1DE	205	NE2	NE-13	11	CLB4	CLB-2	11	X4	MAZ-1I	35	CO4	COR-174	101	DE6	DX-5DS	105
			SE1	SEG-1D	145	BKS2	BK-19/10	93	PHA2	PHI-52L	134	CO4	COR-174	101	Y4	YA-80D	160	CR4R	ME-1	37	DO6	DOI-4	108
			SE1	SEG-1DE	209	BMW2	BM-HB	5--69	PN2	NE-32	20	HL3	HUD-10	118	5D1R	RUS-4S	137				DT6	DAT-3I	42



COMPETITOR CROSS REFERENCE

Índice comparativo
Index comparatif

CROSS REF.	REF.	PAG.	CROSS REF.	REF.	PAG.	CROSS REF.	REF.	PAG.	CROSS REF.	REF.	PAG.	CROSS REF.	REF.	PAG.	CROSS REF.	REF.	PAG.	CROSS REF.	REF.	PAG.			
EV6	EV-1	110	H7LH	VA-RH	154	VL8	NE-18	60	H10F	VA-8D	154	CLB12	CLB-7	11	NA14	NTC-1DE	208	HY17P	HY-11.P3	29	M20	MAS-18DE	208
FL6	FAL-27D	111	H7RA	VA-LA	154	VL8P	NE-18.P	60	HD10	HOND-5D	71	CO12	CCL-32	95	SZ14RAP	SUZU-12D.P	77	HYD17	HD-5	71	NE20	NE-3	48
FT6	FO-FK	6-13-18-44-46	H7RB	VA-LB	154	YM8	OP-8	44	KK10P	HY-18.P3	30	CS12	CE-1D	97	TK14	TOK-38	149	LF17	LF-RO	7--50	SC20	SLG-6	144
FT6R	FO-FR	3-6-13-44	H7RC	VA-LC	154	X8	VO-VA	59	KW10	KWI-2D	121	CU12	BS-9D	39	TM14	TRM-10D	151	M17	MAS-21D	127	SC20	SLG-6L	144
FT6R	FO-FR	3-6-13-44	H7RD	VA.LD	154	9CS	CI-DL	99	KW10	KWI-2DE	207	HD12	HOND-5I	71	Y14	YA-45	39--165	MB17	ME-HM	38	SL20	SLY-14	146
FT6R	FO-FR	3-6-13-44	H7RE	VA-LE	154	9CX	CI-28D	99	KW10	KWI-2DS	121	HY12	HY-6D	29	Y14	YA-45E	210	MD17	MAS-16D	127	SUZ20P	SUZU-19D.P	47
FT6R	FO-FR	3-6-13-44	H7RF	VA-LF	154	9D	DOM-5D	107	LF10	LF-27	125	HY12P	HY-6D.P	29	ZD14RP	ZA-2.P	48	MD17	MAS-16DE	208	TK20	TOK-68	149
FT6R	FO-FR	3-6-13-44	H7RG	VA-LG	154	AS9	AS-T5	90	LS10	LASB-2	122	KW12	KAW-5	74	15K	MAS-9S	126	MZ17	MAZ-19D	36	TM20	TRM-17D	151
FT6R	FO-FR	3-6-13-44	H7RH	VA-LH	154	BR9	UN-4	7	M10	MAS-9	126	LF12	VO-1	58	AB15	ABU-40	85	SUZ17	SUZU-8	53	VW20	VO-VA	59
FT6R	FO-FR	3-6-13-44	H7RH	VA-LH	154	BUR9	BUR-28	94	M10	MAS-9E	207	M12	MAS-3D	126	AS15	AS-AL5	90	SUZ17P	SUZU-8.P	53	YH20	YAMA-1I	80
FT6R	FO-FR	3-6-13-44	H7RH	VA-LH	154	CLB9	CLB-5	11	M10	MAS-9S	126	MZ12	DAT-5D	35--42	AU15	HU-MN	4	TK17	TOK-40	149	AB21	ABU-2I	85
FT6R	FO-FR	3-6-13-44	H7RH	VA-LH	154	CO9	CCL-35D	95	MZ10	MAZ-2I	35	NAI2	NTR-2D	131	BKS15	BK-19/23	93	TM17	TRM-12	151	AS21	AS-EM5	90
FT6R	FO-FR	3-6-13-44	H7RH	VA-LH	154	CU9	BS-8D	39	NE10	BH-1	6	NAI2	NTR-2DE	208	BUR15	BUR-29D	94	ZD17RAP	ZA-7D.P	70--77	AS21	AS-EM5	90
FT6R	FO-FR	3-6-13-44	H7RH	VA-LH	154	DE9	DX-37	105	OM10	PLL-1	12	SUZ12	SUZU-11D	77	CLB15	CLB-8D	11	AB18	ABU-2D	85	HF21	OP-FF	45
FT6R	FO-FR	3-6-13-44	H7RH	VA-LH	154	DNDS9	SLG-5C	143	S10	SAR-4D	139	TK12	TOK-67	149	HF15	ME-15D	38	AS18	AS-EK7	90	M21	MAS-2D	126
FT6R	FO-FR	3-6-13-44	H7RH	VA-LH	154	ES9	ESP-1	109	SC10	SLG-9	144	Y12	YA-45D	8-19-165	HY15	HY-13D	30	BKS18	BK-19/26	93	M21	MAS-2DE	207
FT6R	FO-FR	3-6-13-44	H7RH	VA-LH	154	FC9	FO-TX2	18	SC10	SLG-9S	143	Y12	YA-45DE	210	HY15P	HY-13D.P3	30	BR18R	IN-5	6	TK21	TOK-69	149
FT6R	FO-FR	3-6-13-44	H7RH	VA-LH	154	FL9	FAL-30D	111	SIM10	SM-1	146	AB13	ABU-50	86	DX18R	DX-23	106	DX18R	DX-23	106	VC21	VA-59	154
FT6R	FO-FR	3-6-13-44	H7RH	VA-LH	154	IL9	ILL-2D	39--120	SZ10RP	SUZU-11D.P	77	AS13	AS-EL5	90	HYD15	HD-6	71	HY18P	HY-19D.P3	30	X21	FO-XL	18
FT6R	FO-FR	3-6-13-44	H7RH	VA-LH	154	KM9	LAS-V	46	TK10	TOK-37	149	BKS13	BK-19/21	93	KA15	KAW-1D	74	HY18RP	HY-19.P3	30	YM21	OP-HA	45
FT6R	FO-FR	3-6-13-44	H7RH	VA-LH	154	KW9	KWI-3D	121	TM10	TRM-9D	151	BUR13	BUR-13D	94	KW15BP	KAW-7.P	74	HYD18	HD-5D	71	ZD21P	ZA-8.P	70
FT6R	FO-FR	3-6-13-44	H7RH	VA-LH	154	LF9	LF-24	125	X10	DAT-8	42	CLB13	CLB-7D	11	MB15	ME-HD	38	LS18	LASB-1	122	AS22	AS-EM7	90
FT6R	FO-FR	3-6-13-44	H7RH	VA-LH	154	MZ9	MAZ-2D	35	AS11	AS-V5	90	CS13	CE-II	97	MB15P	ME-HD.P	38	M18	MAS-31D	127	CG22	CHI-14	98
FT6R	FO-FR	3-6-13-44	H7RH	VA-LH	154	NE9	NE-37	14	B11	GM-31	23	EA13	EAG-5D	108	RO15	NTC-15D	131	MB18	ME-HZ	38	DM22TVP	DOM-32	174
FT6R	FO-FR	3-6-13-44	H7RH	VA-LH	154	NS9CS	CI-4D	99	BKS11	BK-19/19	93	HD13	HOND-7D	71	SC15	SLG-16	144	MB18P	ME-HZ.P	38	HF22	FO-OR	18
FT6R	FO-FR	3-6-13-44	H7RH	VA-LH	154	NSR9CS	CI-4I	99	BUR11	BUR-1D	93	HY13	HY-5	29	SUZ15	SUZU-10	53	NE18	NE-4	10--46	RU22	RUS-50	137
FT6R	FO-FR	3-6-13-44	H7RH	VA-LH	154	R9CS	CI-IL	99	CLB11	CLB-6	11	HY13P	HY-5.P	29	SUZ15P	SUZU-10.P	54	SUZ18	SUZU-12D	77	S22	SAR-7	140
FT6R	FO-FR	3-6-13-44	H7RH	VA-LH	154	S9P	PR-1D	134	CS11	CE-2I	97	HYD13	HD-4D	71--75	TK15	TOK-39	149	SUZ18P	SUZU-12D.P	77	S22	SAR-7E	208
FT6R	FO-FR	3-6-13-44	H7RH	VA-LH	154	SC9	SLG-5	144	DM11	DOM-18D	107	KA13	KAW-4	74	TM15	TRM-14D	151	TK18	TOK-49	149	S22	SAR-7S	139
FT6R	FO-FR	3-6-13-44	H7RH	VA-LH	154	SC9	SLG-5E	209	EL11	ELG-2	109	LA13	CAM-1D	76	AB16	ABU-27D	85	TM18	TRM-15D	151	SC22	SLG-2	143
FT6R	FO-FR	3-6-13-44	H7RH	VA-LH	154	SC9	SLG-5S	143	HD11	HOND-6I	71	M13	MAS-13D	126	AS16	AS-AL7	90	AB19	ABU-1D	85	TK22	TOK-50	149
FT6R	FO-FR	3-6-13-44	H7RH	VA-LH	154	SIM9R	SM-3D	146	HF11	OP-DD	45	CG16	CHI-12D	19--98--117	CG16	CHI-12DE	205	AS19	AS-AK5	90	VC22	VA-12D	154
FT6R	FO-FR	3-6-13-44	H7RH	VA-LH	154	SM9C	RO-3	52	IL11	TIM-1D	149	HY16	HY-12	30	CG16	CHI-12DE	205	BKS19	BK-19/27	93	X22	FO-XR	18
FT6R	FO-FR	3-6-13-44	H7RH	VA-LH	154	SR9P	PR-1	134	IL11	TIM-1DE	209	HY16P	HY-12.P3	30	HY16	HY-12	30	CO19	CCL-3D	95	YM22	OP-HB	45
FT6R	FO-FR	3-6-13-44	H7RH	VA-LH	154	SU9L	SR-II	147	KA11	KAW-II	74	HYD16	HD-6D	71	CO19	CCL-3D	95	CO19	CCL-3D	95	ZD22RBP	ZA-6D.P1	69
FT6R	FO-FR	3-6-13-44	H7RH	VA-LH	154	TM9	TRM-1	150	KW11	KWI-5D	122	LF16	LF-4I	125	HYD16	HD-6D	71	HYD19	HD-7D	71	AB23	ABU-51D	86
FT6R	FO-FR	3-6-13-44	H7RH	VA-LH	154	X9	VO-HV	4--58	KW11	KWI-5DE	207	M16	MAS-9D	126	LF19	LF-5	125	LS19	LASB-1D	122	BKS23	BK-19/31	93
FT6R	FO-FR	3-6-13-44	H7RH	VA-LH	154	YH9	YAMA-2I	80	LS11	LASB-2D	122	NE13	NE-15I	14	M16	MAS-9D	207	M19	MAS-19	127	DA23	DAT-2I	42--53
FT6R	FO-FR	3-6-13-44	H7RH	VA-LH	154	YM9	OP-9	44	M11	MAS-5D	126	RO13	NTC-6	130	M16	MAS-9DS	126	M19	MAS-19E	208	DA23P	DAT-2I.P	42--53
FT6R	FO-FR	3-6-13-44	H7RH	VA-LH	154	ZD9P	ZA-1.P	70	ME11	MAS-5DE	207	TK13	TOK-48	149	MB16	ME-HF	38	M19	MAS-19E	208	DM23	DOM-29	108
FT6R	FO-FR	3-6-13-44	H7RH	VA-LH	154	AS10	AS-T7	90	MZ11	MAZ-14D	36	TM13	TRM-11D	151	MZ16	MAZ-20D	36	MZ19	MAZ-17D	36	HF23	FO-OL	18
FT6R	FO-FR	3-6-13-44	H7RH	VA-LH	154	B10	GM-32	23	OP11	OP-CC	25--45	Y13	YA-44	165	MZ16P	MAZ-20D.P	37	MZ19P	MAZ-17D.P	36	LF23	LF-8	125
FT6R	FO-FR	3-6-13-44	H7RH	VA-LH	154	CLB10	CLB-5D	11	RO11	NTC-8D	130	Y13	YA-44E	210	RU16	RUS-6	137	RT19	LMP-2	46	TA23	TOYO-6	55
FT6R	FO-FR	3-6-13-44	H7RH	VA-LH	154	CO10	CCL-1D	95	SB11	AS-1D	51	Y13	YA-44E	210	TK16	TOK-8	149	SC19	SLG-14	143	TK23	TOK-42	149
FT6R	FO-FR	3-6-13-44	H7RH	VA-LH	154	CS10	CE-2D	97	SUZ11	SUZU-5	77	Y13	YA-44E	210	TM16	TRM-13	150	SC19	SLG-14L	144	YM23	OP-NA	45
FT6R	FO-FR	3-6-13-44	H7RH	VA-LH	154	CU10	BS-8	39	TK11	TOK-63	149	Y13	YA-44E	210	UN16	UN-FR	7	SUZ19	SUZU-18	78	ZD23RCP	ZA-9.P	70
FT6R	FO-FR	3-6-13-44	H7RH	VA-LH	154	DAV10	DAV-1	34	TL11	TRI-18D	150	Y13	YA-44E	210	YH16	YAMA-1D	80	TK19	TOK-41	149	24B-AUS	LWO-8	124
FT6R	FO-FR	3-6-13-44	H7RH	VA-LH	154	DM10	DOM-1D	107	TL11R	TRI-18	150	Y13	YA-44E	210	YM16	ME-L	39	TM19	TRM-16D	151	AS24	AS-S7	90
FT6R	FO-FR	3-6-13-44	H7RH	VA-LH	154	DNK10	KWI-2DC	121	WS11	WAS-1	20	Y13	YA-44E	210	ZD16RP	ZA-4D.P	70-76-79-82	AB20	ABU-1	85	BKS24	BK-19/32	93
FT6R	FO-FR	3-6-13-44	H7RH	VA-LH	154	DXB10	DX-14	106	Y11	YA-44D	8-165	Y13	YA-44E	210	AS17	AS-EK5	90	AS20	AS-AK7	90	DA24	DAT-2D	42
FT6R	FO-FR	3-6-13-44	H7RH	VA-LH	154	DXC10	DX-17	106	Y11	YA-44DE	210	Y13	YA-44E	210	AS17	AS-EK5	90	DA20	DAT-11D	35--43	IN24	ILC-9D	119
FT6R	FO-FR	3-6-13-44	H7RH	VA-LH	154	DXD10	DX-20	106	Y11	YA-44DE	210	Y13	YA-44E	210	BKS17	BK-19/25	93	DXB20	DX-15	106	M24	MAS-41	128
FT6R	FO-FR	3-6-13-44	H7RH	VA-LH	154	EL10	ELG-1	109	AS12	AS-V7	90	Y13	YA-44E	210	CG17	CHI-13D	98	DXC20	DX-18	106	NA24	NTR-1D	131
FT6R	FO-FR	3-6-13-44	H7RH	VA-LH	154	FL10	FAL-31D	111	BH12	BH-5	6	Y13	YA-44E	210	CG17	CHI-13DE	205	DXD20	DX-21	106	LF24	LF-42	125
FT6R	FO-FR	3-6-13-44	H7RH	VA-LH	154	FT10	FO-PRL	18	BKS12	BK-19/20	93	Y13	YA-44E	210	CO17	CCL-2D	95	LF20	LF-25	125	RN24P	NE-22.P	2--47
FT6R	FO-FR	3-6-13-44	H7RH	VA-LH	154	FT10R	FO-PRR	18	BUR12	BUR-1I	93	Y13	YA-44E	210	HY17	HY-11	29	LF20S	LF-40	125	TK24	TOK-22	149
FT6R	FO-FR	3-6-13-44	H7RH	VA-LH	154							Y13	YA-44E	210				M20	MAS-18D	127	YH24	YAMA-7D	80



COMPETITOR CROSS REFERENCE

Índice comparativo
Index comparatif

CROSS REF.	REF.	PAG.	CROSS REF.	REF.	PAG.	CROSS REF.	REF.	PAG.	CROSS REF.	REF.	PAG.	CROSS REF.	REF.	PAG.	CROSS REF.	REF.	PAG.	CROSS REF.	REF.	PAG.	CROSS REF.	REF.	PAG.
YM24	OP-NB	45	LP29R	LIP-2D	123	DM32	DOM-36	108	YH37	YAMA-12I	80	RU45	RUS-4E	208	CS51	CE-57	97	YM56	YAMA-16I	80	HVR61	RO-16I	49--52-135
ZD24RDP	ZA-9.P1	70-73-76-79-82	M29	MAS-36D	127	HON32P	HOND-1.P	27	AS38	AS-BK7	90	RU45	RUS-4S	137	H51	FO-2ID	15	B57	ISU-2	31	R61G	AF-4I	1--42
CS25	CE-3I	97	MZ29	MAZ-18D	36	PH32	PHI-32	134	DA38	DAT-10	42	YH45	YAMA-13I	80	H51	FO-2IDE	213	CS57	CE-86	97	R61JD	RO-10I	135
DA25	DAT-12	43	RN29	VA-10	3--10	S32FJP	JAU-1.P	18	DA38P	DAT-10.P	42	AS46	AS-BL7	90	UN51	UN-19D	152	NE57	FI-1I	13	R61P	RO-1DS	52
DA25P	DAT-6.P	42--53	TK29	TOK-7I	149	TK32	TOK-64	149	FT38	IMS-3	2	B46	GM-9	2--21	UN51L	UN-35D	153	UN57	UN-25D	152	R61Q	AS-F5	89
DM25	DOM-55D	108	VC29	VA-7	49	VC32	VA-13I	154	HF38	OP-R	45	B46P	GM-9.P	2--21	X51	NE-1	4	UN57L	UN-43D	153	R61T	AS-B5	89
M25	MAS-25D	127	X29	NE-10	50--59	YH32	YAMA-15I	80	HON38RP	HOND-13.P	27	CR46	COR-215	104	YH51	YAMA-20D	78--80	CS58	CE-87	97	R61W	AS-P5	89
MZ25	MAZ-8D	35	YH29	YAMA-7I	80	HON33P	HOND-2.P	27	TK38	TOK-65	149	CS46	CE-78	97	AS52	AS-DM7	90	S58HFP	ME-12.P	38	SR61N	NE-6	70--77
MZ25P	MAZ-8D.P	36	YH29BP	YAMA-19D.P	81	IN33	ILC-2D	119	YH38	YAMA-12D	80	RU46	RUS-5	136	B52	GAS-3	20--21	UN58	UN-22D	152	T61B	TOYO-39	57
NA25	NTL-ID	131	YH29P	YAMA-23D.P	78--81	IN33	ILC-2DE	206	DA39	DAT-23	44	RU46	RUS-5E	208	CS52	CE-8I	97	UN58L	UN-38D	153	T61C	TOYO-K1	54
NA25	NTL-IDE	208	YH29RBP	YAMA-19I.P	81	LS33	LASB-3D	122	HON39P	HOND-19D.P	72	TR46	TOYO-34	57	H52	FO-37	17	B59	GM-44D	25	T61CP	TOYO-K1.P	55
RN25	NE-16	2	YH29RP	YAMA-23I.P	78--81	NE33	VA-17.P	49	MB39	ME-HY	38	TR46P	TOYO-10.P1	55	RU52	RUS-12	137	CS59	CE-88	97	T61F	TOYO-2	54
SP25AP	AF-14.P	1	YM29	OP-AB	45	S33FDP	FO-4.P	17	MB39P	ME-HY.P	38	YH46	YAMA-18I	75--80	UN52	UN-20D	152	H59	FO-28D	16	UN6I	UN-19I	152
TK25	TOK-70	149	AS30	AS-DK7	77	S33P	UN-47	153	TK39	TOK-74	149	AS47	AS-GL5	90	UN52L	UN-36D	153	HF59R	OP-D	45	UN61L	UN-35I	152
TR25	TOYO-35D	57	CS30	CE-100D	97	TK33	TOK-66	149	TR39	TOYO-10	55	B47	GM-13	22	X52	SAA-AC	51	UN59	UN-27D	152	VR61S	RO-7I	47-135
YM25	OP-HG	45	DA30	DAT-14	43	TR33	TOYO-12	26--55	TR39	TOYO-10E	214	B47P	GM-13.P	22	Y52	YA-13D	165	UN59L	UN-41D	153	X6I	NE-5	48
CO26	CCL-12	95	DA30P	DAT-14.P	43	TR33	TOYO-12E	214	YH39	YAMA-3I	80	CS47	CE-79	97	Y52	YA-13DE	210	X59	BM-HB	5--69	62DC	UN-MRN	7--51
CO26	CCL-12E	205	DXB30	DX-16	106	TR33P	TOYO-12.P	26--55	AS40	AS-BM7	90	NE47	LMP-4	46	YH52	YAMA-34D	60	Z1-59A1-6	COR-116S	102	62DG	UN-44	2-7-51-60
CS26	CE-3D	97	DXC30	DX-19	106	V33	VO-N	58	HF40	BM-NB	5	TR47	TOYO-15	56	AS53	AS-GM5	90	Z1-59A2-6	COR-117S	102	62DJ	UN-NC	7
H26	FO-44D	17	DXD30	DX-22	106	VC33	VA-13D	154	NE40	NE-5	48	TR47	TOYO-40	57	B53	GM-2	21	Z1-59B1-6	COR-118S	102	62DM	UN-FFE	7
M26	MAS-24D	126	KA30	KAW-7	74	YH33	YAMA-17I	80	TR40	TOYO-20D	49	TR47	TOYO-15E	214	CS53	CE-82	97	Z1-59B2-6	COR-119S	102	62DP	UN-FP	3--50
TK26	TOK-51	149	RN30	NE-20	2--9--46	AS34	AS-Z7	90	TR40	TOYO-20DE	206	TR47	TOYO-15E	214	H53	FO-38D	17	Z1-59C1-6	COR-120S	102	62DS	UN-1FS	7--152
X26	MAZ-2D	35	S30FDP	FO-6.P	17	DA34	DAT-16	43	TR40P	TOYO-9.P	55	TR47P	TOYO-15.P	56	RU53	RUS-1	136	Z1-59C2-6	COR-121S	102	62DT	DAT-21	44--53
AS27	AS-GK5	90	TK30	TOK-53	149	DA34P	DAT-16.P	43	YH40	YAMA-3D	80	YH47	YAMA-18D	75-78-80	S53HFP	ME-6.P	37	Z1-59D1-6	COR-122S	102	62DU	DAT-21D	44
DM27	DOM-1I	107	X30	NE-9	59	NE34	CHR-3	52	AS48	AS-GL7	90	AS48	AS-GL7	90	TR53	TOYO-17	56	Z1-59D2-6	COR-123S	102	62DV	DAT-8	42
EA27	HAR-1I	117	YH30	YAMA-15D	80	S34YSP	ME-10.P	38	B48	GM-6	21	B48	GM-6	213	DM60	DOM-12D	107	DM60	DOM-12D	107	62EV	EV-3D	110
EA27	HAR-1IE	206	YH30BP	YAMA-20D.P	81	TK34	TOK-72	149	B48P	GM-6.P	21	CS48	CE-80	97	H60	FO-11D	14	H60	FO-11D	14	62FS	UN-FS	3--79
H27	FO-32D	16	YH30RP	YAMA-24D.P	81	VC34	VA-4D	154	CS48	CE-80	97	FT48	AF-13	1	H60	FO-11DE	212	S60	ZE-K5	167	62FT	UN-FT	3--17-19
M27	MAS-39D	127	YH30RBP	YAMA-20I.P	81	YH34	YAMA-17D	80	FT48	AF-13	1	NE48	NE-1I	17--33--50	S60HFP	HU-DH.P	59	S60HFP	HU-DH.P	59	62HD	YA-18D	50
MZ27	MAZ-13D	36	YH30RP	YAMA-24I.P	81	YH34P	YAMA-27.P	81	NE48	NE-1I	17--33--50	S48HFP	ME-2.P	37	AS54	AS-GM7	90	S60	ZE-K6	167	62HE	YA-20D	50
MZ27P	MAZ-13D.P1	36	YH30RP	YAMA-24I.P	81	YH34RP	YAMA-27D.P	81	CS43	CE-134D	98	X48	YAMA-4D	80	B54	GM-47D	25--31	UN60	UN-21I	152	62HF	YA-21I	50
TK27	TOK-43	149	YH30RP	YAMA-24I.P	81	AS35	AS-FK5	90	HF43	OP-J	45	YH48	YAMA-19I	75-78-81	CS54	CE-83	97	UN60L	UN-37I	152	62HG	YA-20I	50
V27	VO-K	59	YM30	OP-BA	45	CO35	COR-168	101	HU43P	OP-WH.P	45	AS49	AS-DL5	90	F54	CL-5D	12	ZI-60-5	COR-8S	100	62LG	LEG-ID	122
X27	MAZ-2I	35	CS31	CE-101D	97	DA35	DAT-15	43	AS44	AS-FL7	90	B49	GM-10	22	H54	FO-20D	15	ZI-60-6	COR-9S	100	62R	RO-6I	10--49--52
YH27	YAMA-5D	80	DA31	DAT-22	44	IN35	ILC-8D	119	B44	GM-8	21	B49	GM-10E	213	H54	FO-20DE	212	61B	BRE-2	93	62U	RO-6D	10--49--52
YM27	OP-HI	45	DA31P	DAT-22.P	44	TK35	TOK-24	149	B44	GM-8E	213	B49P	GM-10.P	22	N54G	FR-14D	113	61G	AF-4D	1	62UC	RO-4D	10--52
AS28	AS-GK7	90	DM31	DOM-36D	108	V35P	AU-AH.P	3	B44P	GM-8.P	21	CS49	CE-55	97	NE54	FI-3D	12	61J	RO-10D	135	62VG	HU-P	5
DA28	DAT-18	43	HON31CP	HOND-4I.P1	71--75	YH35	YAMA-14I	80	CS44	CE-77	97	S49HFP	ME-3.P	37	P54F	DOI-5	108	61P	RO-11S	18-52	62Z	RO-2D	10--47--49--52
IN28	ILC-5D	119	HON31P	HOND-4I.P	71	YH35RBP	YAMA-26D.P	81	F44	AF-7I	12	YH49	YAMA-19D	75-78-81	S54F	DOI-1	108	61Q	AS-E5	89	A62VN	HU-SC	44
M28	MAS-40D	128	HON31RBP	HOND-4D.P2	71	AS36	AS-FK7	90	HO44	HOND-3D	71	AS50	AS-DL7	90	UN54	UN-24D	152	61T	AS-A5	89	AB62C	ABU-42D	85
TK28	TOK-52	149	HON31RBP	HOND-4D.P2	71	CO36	COR-45	101	NE44	NE-56	47	B50	GM-7	21	UN54L	UN-40D	153	61W	AS-N5	89	AB62CR	ABU-42	85
TR28	TOYO-4	54	HON31RCP	HOND-4D.P1	71	TK36	TOK-73	149	B50	GM-7E	213	B50	GM-7E	213	X54	TOYO-14	9-26-32-41-54	61X	AS-22	90	AB62E	CI-5DP	99
TR28P	TOYO-4.P	55	HON31RCP	HOND-4D.P1	71	X36	MAZ-14D	36	B50P	GM-7.P	21	B50	GM-7E	213	Y54	YA-25D	165	A61Q	AS-E7	90	AB62ER	CI-5IP	99
YH28	YAMA-5I	80	HON31RP	HOND-4D.P	71	YH36	YAMA-14D	80	CS50	CE-56	85	B50P	GM-7.P	21	AS55	AS-AM5	90	A61T	AS-A7	90	B62	GM-16	22
YH28BP	YAMA-18D.P	81	HON31RP	HOND-4D.P	71	37D	YA-30	185	H50	FO-19	15	CS50	CE-56	85	B55	GM-45D	25	A61W	AS-N7	90	B62B	BRE-1D	93
YH28P	YAMA-22D.P	81	KA31	KAW-9	74	AS37	AS-BK5	90	H50	FO-19E	212	CS55	CE-84	97	AR61Q	AS-F7	90	AR61T	AS-B7	90	B62P	GM-16.P	22
YH28RBP	YAMA-18I.P	81	MZ31	MAZ-11D	36	CB37	COR-175	102	S50HFP	ME-4.P	37	H55	FO-26D	15	AR61W	AS-P7	90	AR61W	AS-P7	90	CO62	COR-55D	101
YH28RP	YAMA-22I.P	81	RN31	NE-28	3--9	DA37	DAT-20	44	UN50	UN-21D	152	YM55	YAMA-16D	80	B61	OP-S	25--45	B61	OP-S	25--45	H62	FO-29D	16
ZD28RFP	ZA-6D.P	70	TK31	TOK-54	149	DA37P	DAT-20.P	44	UN50L	UN-37D	153	AS56	AS-AM7	90	B61	OP-SE	214	B61	OP-SE	214	H62BM	VA-19	154
AS29	AS-DK5	90	YH31R	YAMA-21I	81	FT37	IMS-5	2	YH50	YAMA-20I	78--80	B56	GM-46D	25	B61Y	WA-5DP	155	B61Y	WA-5DP	155	H62CM	VA-21	154
CS29	CE-110	97	YH31RAP	YAMA-21I.P	81	TK37	TOK-55	149	AS51	AS-DM5	90	CS56	CE-85	97	DM61	DOM-7D	107	DM61	DOM-7D	107	H62DM	VA-22	154
IN29	ILC-3	119	AS32	AS-X7	90	TR37	TOYO-13	55	B51	GM-11	22	H56	FO-33D	16	H61V	ANA-1	88	H61V	ANA-1	88	H62DP	IN-1	3--6--50
LP29	LIP-2	123	CS32	CE-99D	97	TR37	TOYO-13E	214	B51	GM-11E	213	NE56	FI-8I	13	H61VR	NE-25	7--39--51	H61VR	NE-25	7--39--51	H62DR	IN-4	6
			DA32	DAT-19	43	V37P	VO-AH.P	58	B51P	GM-11.P	22	UN56	UN-26D	152	HV61	RO-16D	49--52-135	HV61	RO-16D	49--52-135	H62FD	FO-OA	58
			DA32P	DAT-19.P	43	X37	TOYO-4	54	RU45	RUS-4	136	UN56L	UN-42D	153							H62KB	VA-2	154



COMPETITOR CROSS REFERENCE

Índice comparativo
Index comparatif

CROSS REF.	REF.	PAG.	CROSS REF.	REF.	PAG.	CROSS REF.	REF.	PAG.	CROSS REF.	REF.	PAG.	CROSS REF.	REF.	PAG.	CROSS REF.	REF.	PAG.	CROSS REF.	REF.	PAG.			
H62P	FO-29D.P	16	B65	GM-4E	213	NE71RDP	NE-35.P2	51--76	X82	ME-HU	38	F91E	FEM-1D	2	B93	GM-35	24	CO106	HUD-3	96--117	Y155	CHR-10	8
HR62FD	FO-PN	16	B65P	GM-4.P	21	VW71	VO-M	59	UN83	UN-17I	152	F91F	FEM-1I	2	B93P	GM-35.P	24	CO106	HUD-3E	206	Y155	CHR-10E	212
L62DM	UN-46D	153	B65P	GM-4.P1	21	VW71A	VO-R	59	UN83L	UN-33I	152	F91G	FEM-2D	2--26	CO94	COR-60	102	X106	KAW-1D	74	Y155P	CHR-10.P	8
L62UC	RO-5D	10	DM65-11	DOM-27D/11	107	X71	HOND-34	26	X83	ME-HY	38	F91H	FEM-2I	2	CR94	COR-181	103	CO107	COR-59	102	X157	LF-RO	7--50
L62US	CE-6D	97	DM65-17	DOM-27D/17	107	AS72	AS-D7	90	AS84	AS-NN7	90	GU91B	GR-3D	116	X94	HD-1D	70	X107	YAMA-13I	80	Y157	CHR-14	9
LR62US	CE-6I	97	DM65-20	DOM-27D/20	107	B72P	DAI-1.P	20	B84	GM-23	22	GU91F	GR-2I	116	CO95	COR-57	102	CO108	COR-103	102	Y157	CHR-14E	212
R62B	BRE-1	93	H65	FO-9D	14	X72	YAMA-14D	80	B84P	GM-23.P	22	GU91G	GR-2D	116	CR95	COR-182	103	HD108	HOND-52D	73	Y157P	CHR-14.P	9
R62CA	CENT-1I	97	H65P	FO-9D.P	14	73VB	VO-HV	4--58	X84	HOND-51	73--75	HD91	HOND-15	27	X95	HD-1	70	HD109	HOND-50	73	X158	ISU-2	31
R62DG	UN-44D	2	P65A	DU-1	45	73VBP	VO-HV.P	4--58	B85	GM-41	25	HD91P	HOND-15.P	27	B96	GM-40	24	B110	GM-38	24	X159	TOYO-13	55
R62DM	UN-3	7--51--79	R65F	SEL-II	145	VO73	NE-10	50--59	B86	GM-14	22	JO91C	JWL-6	120	B96P	GM-40.P	24	B110P	GM-38.P	24	Y159	CHR-15	9
R62EV	EV-3I	110	YH65	YAMA-37D	82	VO73S	NE-9	59	B86	GM-14E	213	KS91C	BK-1D	93	HD96	HOND-39D	1	DM110	DOM-37D	108	Y159P	CHR-15.P	9
R62UC	RO-4I	10--34--52	H66	FO-39D	17	X73	YAMA-14I	80	B86P	GM-14.P	22	MG91C	MGA-1D	130	X96	HD-2	70	X110	VO-N	58	X160	HY-15D	30--39
R62US	CE-5	97	H66P	FO-8D.P1	14	AS74	AS-H7	90	H86	FO-27D	15	MG91N	MGA-1	130	CO97	COR-7	102	X111	YAMA-16D	80	X161	HY-16	30
R62X	JWL-2D	120	HU66P	HU-HAA.P1	58	B74	GM-15D	26--28	H86P	FO-27D.P	16	PR91A	PR-5I	134	HD97	HOND-41D	1	X112	YAMA-16I	80	X162	GM-44D	25
R62Z	RO-2I	10--47--49--52	NE66GTS	NE-40	60	B74P	GM-15D.P	26--28	X86	FO-TX	3-18-50	PR91C	PR-7	134	X97	HD-3	70	B113	ISU-5	31	X166	AF-13	1
S62US	CE-4D	97	S66NNP	NE-40.P	60	HD74	HOND-51	73--75	CO87	COR-8	100	PR91CS	PR-10	134	CO98	COR-58	102	HD114	HOND-33	72	X168	OP-5	25--45
U62VP	OP-BB	25--45	UN66	UN-26I	152	NE74P	NE-45.P	76	CO87	COR-8E	206	PR91N	PR-5D	134	X98	HD-3D	70	X114	DAT-2D	42	I70S	SA-1	138
UN62	UN-20I	152	UN66L	UN-42I	152	X74	YAMA-17D	80	CR87	COR-218	104	PR91NS	PR-4I	134	HD99	HOND-38D	1	X115	DAT-2I	42--53	X170	NE-11	17--33--50
UN62L	UN-36I	152	67	DX-5DS	105	AS75	AS-U5	90	X87	SUZU-5	77	PR91SA	PR-4D	134	HD99P	HOND-16D.P1	1	X117	YAMA-19I	75-78-81	X171	NE-28	3--9
UR62VP	OP-EE	45	67U	RU-2D	136	H75	FO-15D	15	B88	GM-21	22	SE91L	SEL-1D	145	100AM	CHI-11	98	X118	YAMA-19D	75-78-81	X174	TOYO-20D	56
X62	YAMA-13D	80	H75P	FO-15D.P	15	H75	FO-15DE	212	B88P	GM-21.P	22	SEL91R	SEL-2D	145	100C	SLG-3S	143	X119	YAMA-18D	75-78-80	X176	MIT-16	41
63H	LAS-5	20--37--46	HD75	HOND-4I	71--75	CO88	COR-9	100	CO88	COR-9	100	SES91	SEL-4D	145	100E	SLG-11S	144	X120	YAMA-18I	75-80	X178	MAZ-20D	36
63P	RO-11D	47	HD75P	HOND-4I.P	71	CR88	COR-216	104	CR88	COR-216	104	SOS91	SOS-1D	146	HUI100	OP-11	44	X121	MIT-2I	9--25--31--32--39	X179	SUZU-11D	77
63PX	VA-6	48	X75	YAMA-17I	80	X88	AU-HV	4	X88	AU-HV	4	ST91A	CE-5D	97	101AM	CHI-9D	98	X122	VA-10	3--10	U180G	UN-6D	152
63Y	HU-SX	5	AS76	AS-U7	90	B89	GM-30	23	B89	GM-30	23	ST91F	STUV-1D	147	101AM	CHI-9D	98	C123	SLG-42DS	144	X180	GM-29D	23
B63	GM-17	22	H76	FO-23D	14	B89	GM-30E	213	B89	GM-30E	213	ST91V	STUV-1I	147	101C	SLG-4S	143	X123	DAT-12	43	X181	HOND-10	27
B63P	GM-17.P	22	H76G	HOND-7I	71	B89P	GM-30.P	23	B89P	GM-30.P	23	TO91	TOK-5D	149	101CE	SLG-8S	143	X124	DAT-18	43	X182	HOND-15	27
CO63	CCL-5D	95	H76P	FO-23D.P	14	CO89	COR-56	102	CO89	COR-56	102	V91E	VA-33D	154	101E	SLG-5S	143	X129	HOND-12	27	X183	HOND-40D	1
DM63	DOM-12	107	X76	YAMA-15D	80	CO89	COR-56E	206	CO89	COR-56E	206	V91N	VA-1	154	101EF	SLG-10S	143	X130	HOND-13	27	X184	GM-4	21
H63	FO-40D	17	AS77	AS-W5	90	X89	LAS-V	46	X89	LAS-V	46	VR91	VI-1I	155	101F	SLG-9S	143	X131	MAZ-3D	35	X185	SUZU-10	53
HD63	HOND-4D	71	B77	GM-18	22	HD90	HOND-10	27	HD90	HOND-10	27	VR91A	VI-2D	155	B101	HOND-32D	28	X132	VO-9D	58	X186	SUZU-8	53
HD63P	HOND-4D.P	71	B77P	GM-18.P	22	HD90P	HOND-10.P	27	HD90P	HOND-10.P	27	VR91AR	VI-2I	155	HD101	HOND-37D	1	X137	TOYO-12	26--55	X187	HY-17	30
N63G	LAS-U	46	X77	YAMA-12D	80	LXP90	HY-18	30	LXP90	HY-18	30	VR91B	VI-4IP	155	HD101P	HOND-37D.P	1	138	BH-3	52	X188	MAZ-19D	36
NR63G	LAS-X	46	AS78	AS-W7	90	LXP90P	TOYO-18.P	56	LXP90P	TOYO-18.P	56	VR91BR	VI-4DP	155	HUI101	FO-24	15	X138	HOND-4I	71--75	G190	GEN-24D	114
R63	FNL-1D	111	B78	GM-20	22	X90	KAW-2D	74	B78	GM-20	22	VR91C	VI-6D	155	RUI101	RUS-14D	136	X140	NE-18	60	G190A	GEN-26D	114--115
R63H	LAS-5D	13--20--46	B78P	GM-20.P	22	B91	GM-34	24	B78P	GM-20.P	22	VR91R	VI-1D	155	102AM	CHI-10D	98	X143	GM-2	21	G190B	GEN-5D	114
UN63	UN-23I	152	H78	FO-30D	16	B91	GM-34E	213	H78	FO-30D	16	VR91S	VI-4I	155	X144	BM-2	4	X144	BM-2	4	G190BA	GEN-10D	114
UN63L	UN-39I	152	H78P	FO-30D.P1	16	B91P	GM-34.P	24	H78P	FO-30D.P1	16	W91C	WIL-1D	156	C145	SLG-43DS	144	X145	GM-45D	25	G190C	GEN-14D	114
X63	YAMA-15I	80	Y78	YA-57D	160	CA91	CA-1I	95	Y78	YA-57D	160	WA91	WA-4I	155	X145	GM-45D	25	X145	GM-45D	25	G190CA	GEN-17D	115
YM63	YAMA-26D	81	B79	GM-43	25	CA91A	CA-15I	95	B79	GM-43	25	WA91L	WA-5I	155	X146	GM-46D	25	X146	GM-46D	25	G190D	GEN-21D	114
B64	GM-19	22	80S	SA-2	138	CA91B	CA-2I	95	80S	SA-2	138	WA91W	WA-4D	155	X147	NE-20	2--9--46	103AM	CHI-8D	98	G190DA	GEN-22D	115
B64P	GM-19.P	22	AS80	AS-DD7	90	CA91D	CA-5I	95	AS80	AS-DD7	90	WA91WL	WA-5D	155	HD103	HOND-16D	27	CO102	COR-102	102	G190E	GEN-25D	114
D64	DOM-2D	107	B80	GM-24	23	CAV91	CA-3I	95	B80	GM-24	23	X91	KAW-2I	74	HD103	HOND-16DE	213	103AM	CHI-8D	98	G190EA	GEN-27D	114
HON64BP	HOND-43.P	72	B80P	GM-24.P	23	CO91	COR-63	102	B80P	GM-24.P	23	ZE91C	CA-4D	95	HD103P	HOND-16D.P	27	HD103	HOND-16D	27	G190F	GEN-28D	114
HON64RBP	HOND-43D.P	72	UN80	UN-13I	152	CO91	COR-63E	206	UN80	UN-13I	152	ZE91CR	CA-4I	95	X103	KAW-3	74	X147	NE-20	2--9--46	G190FA	GEN-29D	114
HU64P	ME-7.P	37	UN80L	UN-29I	152	CR91	COR-217	104	UN80L	UN-29I	152	B92	GM-36	24	Y103	YA-54D	165	Y149	CHR-12	8	G190M	GEN-18D	115
R64	FNL-2D	111	X80	NE-12	60	CS91	CI-20	99	X80	NE-12	60	B92P	GM-36.P	24	Y103	YA-54DE	210	Y149	CHR-12E	212	G190MA	GEN-23D	115
UN64	UN-24I	152	F81E	FO-FR	3-6-13-44	CS91C	CI-4IP	99	F81E	FO-FR	3-6-13-44	CO92	COR-101	102	Y103	YA-54DE	210	Y149	CHR-12E	212	G191	GEN-1D	114
UN64L	UN-40I	152	UN81	UN-14I	152	CS91CR	CI-4DP	99	UN81	UN-14I	152	CR92	COR-180	103	104AM	CHI-7D	98	Y153	CHR-18	9	G191A	GEN-6D	114--115
YM64	YAMA-26	81	UN81L	UN-30I	152	CS91FR	CI-22D	99	UN81L	UN-30I	152	HD92	HOND-40D	1	X104	KAW-4	74	Y153P	CHR-18E	212	SR191A	VI-4D	155
65CE	FB-19	52	AS82	AS-HH7	90	F91C	AF-5D	1	AS82	AS-HH7	90	HD92P	HOND-40D.P	1	X104	KAW-4	74	X154	GM-47D	25--31	I92B	SQ-7	147
B65	GM-4	21	HD82	HOND-12	27	F91C2	AF-6I	1	HD82	HOND-12	27	HU92RP	BM-6.P	5	HD105	HOND-52	73	Y154	CHR-9	8	G192	GEN-2D	114
			HD82P	HOND-12.P	27	F91C8	AF-6D	1	HD82P	HOND-12.P	27	X105	KAW-1I	74	X106	GM-37	24	Y154	CHR-9E	212	G192A	GEN-7D	114--114
			UN82L	UN-31I	152	F91CR	AF-5I	1	UN82L	UN-31I	152	B106P	GM-37.P	24	B106P	GM-37.P	24	Y154P	CHR-9E	8	G193	GEN-3D	114
												X92	NE-16	2							G193A	GEN-8D	114



COMPETITOR CROSS REFERENCE

Índice comparativo
Index comparatif

CROSS REF.	REF.	PAG.	CROSS REF.	REF.	PAG.	CROSS REF.	REF.	PAG.	CROSS REF.	REF.	PAG.	CROSS REF.	REF.	PAG.	CROSS REF.	REF.	PAG.	CROSS REF.	REF.	PAG.	CROSS REF.	REF.	PAG.
X193	HOND-39D	1	X245	MIT-7	40	997JE	YA-252D	164	998TB	YA-128D	163	H998SD	YA-179D	163	999K2	TE-11D	148	1001ABM	COR-98	102	A1001MJR	COR-172D	101
G194	GEN-4D	114	X246	HOND-52	73	997JF	YA-253D	164	998TC	YA-129D	163	H998SE	YA-180D	163	999K3	TE-15D	148	1001AH	COR-86	102	B1001EJ	COR-113	101
G194A	GEN-9D	114--115	X248	YAMA-26D	81	997JG	YA-254D	164	998TD	YA-130D	163	H998SF	YA-181D	163	999LA	YA-206D	159	1001AM	COR-94	102	L1001ABM	COR-151	103
X194	HOND-41D	1	X249	MAZ-11D	36	997JH	YA-255D	164	998TE	YA-131D	163	H998SG	YA-182D	163	999LB	YA-207D	159	1001BH	COR-88	102	L1001AH	COR-139	103
G195	GEN-11D	114	X250	HOND-32D	28	997JK	YA-256D	164	998TF	YA-132D	163	H998SH	YA-183D	163	999LC	YA-208D	159	1001BM	COR-95	102	L1001AM	COR-147	103
G195A	GEN-15D	115	X251	SUB-1	53	997X	YA-82D	166	998TG	YA-133D	163	H998SK	YA-184D	163	999LD	YA-209D	159	1001C1	COR-90	102	L1001BH	COR-141	103
G196	GEN-12D	114	X252	HOND-52D	73	H997E	YA-3D	164	998TH	YA-134D	163	H998SMK	YA-185D	163	999LE	YA-210D	159	1001C2	COR-91	102	L1001BM	COR-148	103
G196A	GEN-16D	114--115	X253	KI-3D	33	H997EB	YA-33D	164	998TK	YA-135D	163	H998TA	YA-166D	163	999LF	YA-211D	159	1001CDM	COR-99	102	L1001C1	COR-143	103
X196	HY-3D	28--39	X254	KAW-15D	75	H997ER	YA-3I	164	998TMK	YA-136D	163	H998TB	YA-167D	163	999LG	YA-212D	159	1001CM	COR-96	102	L1001C2	COR-144	103
G197	GEN-13D	114	X255	KAW-15	75	O997E	YA-25D	165	998VA	YA-57	160	H998TC	YA-168D	163	999LH	YA-213D	159	1001D1	COR-92	102	L1001CDM	COR-152	103
X197	DAT-14	43	X256	KAW-14D	75	O997ER	YA-25I	165	998VB	YA-58	160	H998TD	YA-169D	163	999LK	YA-214D	159	1001D2	COR-93	102	L1001CM	COR-149	103
G198	GEN-19D	114	X257	KAW-14	75	R997EB	YA-7I	164	998VC	YA-59	160	H998TE	YA-170D	163	999N	YA-34D	165	1001DH	COR-89	102	L1001D1	COR-145	103
X198	GM-15D	26--28	X258	KAW-13D	75	998	YA-80D	160	998VD	YA-91	160	H998TF	YA-171D	163	999R	YA-41	158	1001DM	COR-97	102	L1001D2	COR-146	103
G199	GEN-20D	114	X259	KAW-13	70--75--77--79	998A	YA-205D	160	998VE	YA-92	160	H998TG	YA-172D	163	999VA	YA-261	159	1001E	COR-156	101	L1001DH	COR-142	103
X201	MAZ-17D	36	X260	KAW-11D	75	998GA	YA-57D	160	998VF	YA-93	160	H998TH	YA-173D	163	999VB	YA-262	159	1001EA	COR-174	101	L1001DM	COR-150	103
X202	FO-28D	16	X261	KAW-11	75	998GB	YA-58D	160	998VG	YA-94	160	H998TK	YA-174D	163	999VC	YA-263	159	1001EB	COR-81	102	L1001EH	COR-222	104
X204	HOND-38D	1	X262	KAW-12D	75	998GC	YA-59D	160	998VH	YA-95	160	H998TMK	YA-175D	163	999VD	YA-264	159	1001EG	COR-45	101	L1001FH	COR-140	103
X206	MAZ-8D	35	X263	MIT-18	41	998GD	YA-91D	160	998VK	YA-96	160	H998VA	YA-156	161	999VE	YA-265	159	1001EN	COR-62	102	L1001GRM	COR-153	103
X207	FO-40D	17	X264	MIT-17	41	998GE	YA-92D	160	998YA	YA-107	162	H998VB	YA-157	161	999VG	YA-266	159	1001FH	COR-87	102	O1001E	COR-10	100
X208	HOND-37D	1	X265	HOND-50	73	998GF	YA-93D	160	998YB	YA-108	162	H998VC	YA-158	161	999VH	YA-267	159	1001EH	COR-8	100	R1001CEM	COR-176D	102
C209	LF-20	125	X266	MIT-17	41	998GG	YA-94D	160	998YC	YA-109	162	H998VD	YA-159	161	H999	YA-ID	157	1001EJ	COR-157D	101	R1001ED	COR-167D	101
X210	DAT-22	44	X267	HOND-50	73	998GH	YA-95D	160	998YD	YA-110	162	H998VE	YA-160	161	H999R	YA-1I	157	1001EL	COR-47	101	R1001EE	COR-168	101
X211	TOYO-33D	57	X268	KI-4D	33	998GL	YA-96D	160	998YE	YA-111	162	H998VF	YA-161	161	X999	YA-6D	164	1001ES	COR-110	102	R1001EF	COR-175	102
X212	TOYO-34	57	X269	DAT-23	44	998GL	YA-106D	161	998YF	YA-112	162	H998VG	YA-162	161	X999R	YA-6I	164	1001GA	COR-220D	101	R1001EG	COR-55D	101
X213	CHR-17	9--39	X270	KI-6	34	998GST	YA-64D	166	998YG	YA-113	162	H998VH	YA-163	161	1000	COR-82	102	1001GB	COR-221D	102	R1001EK	COR-169	101
X214	HOND-16D	27	X271	TRP-1D	76--79	998LA	YA-97D	161	998YH	YA-114	162	H998VK	YA-164	161	1000A	COR-46	101	1001GH	COR-7	100	R1001EL	COR-161D	101
X216	HY-4	29	X272	SUB-3	53	998LB	YA-98D	161	998YK	YA-115	162	H998YA	YA-146	162	1000AB	COR-44	101	1001GRM	COR-100	102	R1001EM	COR-171D	101
X217	TOYO-15	56	X273	SUZU-18	78	998LC	YA-99D	161	998YMK	YA-116	162	H998YB	YA-147	162	1000FX	CCL-13D	95	1001MA	COR-162	101	R1001EN	SKI-ID	146
Y220	YO-60D	166	X274	HIN-1	26	998LD	YA-100D	161	998ZA	YA-257	164	H998YC	YA-148	162	1000KC	CCL-35D	95	1001MB	COR-163	101	R1001EP	COR-170	101
X221	FO-9D	14	X275	ISU-5	31	998LE	YA-101D	161	998ZB	YA-258	164	H998YD	YA-149	162	1000P	CCL-33D	95	1001MC	COR-164	101	R1001ES	COR-178D	102
Y221	TE-17D	148	275LA	SAR-8S	139	998LF	YA-102D	161	998ZC	YA-259	164	H998YE	YA-150	162	1000T	CCL-32	95	1001MD	COR-165D	101	R1001ET	COR-173D	101
X222	MAZ-13D	36	275S	SAR-2DS	139	998LG	YA-103D	161	998ZG	YA-260	164	H998YF	YA-151	162	1000V	CCL-12	95	1001MG	COR-166D	101	R1001GA	COR-220	101
Y222	TE-11D	148	X277	YAMA-26	81	998LH	YA-104D	161	A998GST	YA-238D	159	H998YG	YA-152	162	1000X	CCL-5D	95	1001MJ	COR-109	102	R1001MJ	COR-177D	102
X223	TOYO-17	56	X280	HY-13D	30	998LK	YA-105D	161	D998GA	YA-196D	160	H998YH	YA-153	162	1000XK	CCL-34D	95-117	1001MK	COR-138D	100	S1001JB	CCL-30D	95
Y223	TE-15D	148	X281	HY-12	30	998PA	YA-239D	164	D998GB	YA-197D	160	H998YK	YA-154	162	R1000T	CCL-32D	95	A1001AH	COR-63	102	1003A	CCL-14	96
X224	MIT-14D	41	X282	HY-11	29	998PB	YA-240D	164	D998GC	YA-198D	160	H998YMK	YA-155	162	R1000V	CCL-12D	95	A1001AM	COR-104	102	1003AB	CCL-18	96
X225	GM-24	23	X283	HD-6D	71	998PC	YA-241D	164	D998GD	YA-199D	160	H998ZA	YA-268	164	S1000T	CCL-29	95	A1001ABM	COR-56	102	1003B	CCL-15	96
X227	DAT-19	43	X284	HD-5	71	998PD	YA-242D	164	D998GE	YA-200D	160	H998ZB	YA-269	164	S1000V	CCL-11	95-117	A1001BH	COR-60	102	1003C	CCL-16	96
X229	MIT-13D	41	X285	HD-5D	71	998PE	YA-243D	164	D998GF	YA-201D	160	H998ZC	YA-270	164	S1000X	CCL-28D	95	A1001BM	COR-105	102	1003CD	CCL-19	96
X230	MAZ-18D	36	X286	HD-7D	71	998PF	YA-244D	164	D998GG	YA-202D	160	H998ZG	YA-271	164	S1000XK	CCL-31D	95	A1001C1	COR-58	102	1003D	CCL-17	96
X231	FO-12	15	X290	YAMA-37D	82	998PG	YA-245D	164	D998GH	YA-203D	160	S998GA	YA-235D	159	SR1000T	CCL-29D	95	A1001C2	COR-102	102	1003M	HUD-3	96--117
X232	HY-6D	29	755	ARR-1	108	998PH	YA-246D	164	D998GK	YA-204D	160	S998GB	YA-236D	159	SX1000V	CCL-11D	95	A1001CDM	COR-108	102	L1003A	CCL-20	96
X233	KI-1D	33	755U	ARR-3	89	998PK	YA-247D	164	H998	YA-165D	161	S998GC	YA-237D	159	1001	CCL-2D	95	A1001CM	COR-106	102	L1003AB	CCL-24	96
X234	HD-4D	71--75	757	ARR-2	108-112	998R	YA-80	160	H998GA	YA-156D	161	999	YA-41D	158	SX1000FR	CCL-2	95	A1001D1	COR-59	102	L1003B	CCL-21	96
X235	HY-5	29	760	DOI-6	108	998S	YA-195D	159	H998GB	YA-157D	161	999A	YA-17D	159	XI000F	CCL-3D	95	A1001D2	COR-103	102	L1003C	CCL-22	96
X236	HY-10	29	765	DOI-7	108	998SA	YA-117D	162	H998GC	YA-158D	161	999B	YO-60D	166	XI000FR	CCL-3	95--131	A1001DH	COR-57	102	L1003CD	CCL-25	96
X237	DAT-16	43	775	FR-13	113	998SB	YA-118D	162	H998GD	YA-159D	161	999GA	YA-186D	159	XI000G	CCL-1D	95	A1001DM	COR-107	102	L1003D	CCL-23	96
X238	DAT-15	43	997B	YA-7D	164	998SC	YA-119D	157	H998GE	YA-160D	161	999GB	YA-187D	159	XI000GR	CCL-1	95	A1001EH	COR-9	100	L1003M	CCL-10	96
X239	NE-52	51	997E	YA-13D	165	998SD	YA-120D	162	H998GF	YA-161D	161	999GC	YA-188D	159	XO1000F	CCL-26D	95	A1001EHR	COR-9D	100	R1003M	HUD-3D	117
X240	KI-2D	33	997EB	YA-63D	164	998SE	YA-121D	162	H998GG	YA-162D	161	999GD	YA-189D	159	XO1000FR	CCL-26	95	A1001FH	COR-101	102	S1003A	CCL-36	96
X241	SUZU-12D	77	997ER	YA-13I	165	998SF	YA-122D	162	H998GH	YA-163D	161	999GE	YA-190D	159	XO1000GR	CCL-27	95	A1001GRM	COR-61	102	S1003AB	CCL-40	96
X242	DAT-20	44	997JA	YA-248D	164	998SG	YA-123D	162	H998GK	YA-164D	161	999GF	YA-191D	159	1001	COR-83	102	A1001HP	COR-111D	101	S1003B	CCL-37	96
X243	DAT-10	42	997JB	YA-249D	164	998SH	YA-124D	162	H998R	YA-165	161	999GG	YA-192D	159	1001A	COR-85	101	A1001MA	COR-158	101	S1003C	CCL-38	96
X244	FO-23D	14	997JC	YA-250D	164	998SK	YA-125D	162	H998SA	YA-176D	163	999GH	YA-193D	159	1001A1	COR-154D	100	A1001MB	COR-159D	101	S1003CD	CCL-41	96
			997JD	YA-251D	164	998SMK	YA-126D	162	H998SB	YA-177D	163	999GK	YA-194D	159									

COMPETITOR CROSS REFERENCE

Índice comparativo
Index comparatif

CROSS REF.	REF.	PAG.	CROSS REF.	REF.	PAG.	CROSS REF.	REF.	PAG.	CROSS REF.	REF.	PAG.	CROSS REF.	REF.	PAG.	CROSS REF.	REF.	PAG.	CROSS REF.	REF.	PAG.			
1004	LWO-4D	124	1007RE	SAR-71D	139	O1007HDH	SAR-68	142	1011K2	RUS-62D	138	A1011-13N	RUS-28D	138	A1012-H2	COR-126D	103	A1015X	LWO-20D	124	SC1041TR	CHI-22D	98
1004A	LWO-5D	124	1007RF	SAR-72D	139	O1007HE	SAR-59	142	1011K3	RUS-63D	138	A1011-14N	RUS-29D	138	A1012-H3	COR-128D	103	A1015XR	LWO-20	124	SC1041YR	CHI-23	98
1004AR	LWO-5	124	1007RG	SAR-73D	139	O1007HF	SAR-60	142	1011K4	RUS-64D	138	A1011-15N	RUS-16	138	A1012-H5	COR-125D	103	A1015Y	LWO-21D	124	1042A	ILL-5	120
1004AX	LWO-22D	124	1007RH	SAR-78D	139	O1007HG	SAR-61	142	1011K5	RUS-65D	138	A1011-16N	RUS-17	138	A1012-H6	COR-127D	103	A1015YR	LWO-21	124	1042B	ILL-6	120
1004AXA	LWO-24D	124	1007RHM	SAR-81D	139	O1007HH	SAR-66	142	1011K6	RUS-66D	138	A1011-17N	RUS-18	138	A1012-H7	COR-129D	103	1022	SEG-1D	145	1042Z	ILL-9	120
1004AXM	LWO-25D	124	1007RJ	SAR-74D	139	O1007HJ	SAR-62	142	1011K7	RUS-67D	138	A1011-18N	RUS-19	138	A1012-H8	COR-130D	103	1022L	SEG-3	145	S1042Z	ILL-3	120
1004K	LWO-1D	124	1007RK	SAR-75D	139	O1007HK	SAR-63	142	1011K8	RUS-68D	138	A1011-19N	RUS-20	138	A1012-59A	COR-187	103	O1022	SEG-2D	145	S1042ZM	ILL-4	120
1004R	LWO-4	124	1007RL	SAR-76D	139	O1007HL	SAR-64	142	1011K9	RUS-69D	138	A1011-20N	RUS-21	138	A1012-59A1	COR-179	103	1023	CLN-1	100	S1042ZP	ILL-8	120
1004XM	LWO-23D	124	1007RM	SAR-79D	139	O1007HM	SAR-67	142	1011K10	RUS-70D	138	A1011-21N	RUS-22	138	A1012-59A2	COR-180	103	1028DC	MIS-3	185	S1042ZS	ILL-10	120
1007	SAR-118	142	L1007CA	SAR-92	141	O1007HN	SAR-10	142	1011K11	RUS-71D	138	A1011-22N	RUS-23	138	A1012-59AB	COR-191	103	1033G	GIB-1D	115	1043B	ILL-2D	39-120
1007CA	SAR-16	141	L1007CB	SAR-93	141	O1007LA	SAR-7	140	1011K12	RUS-72D	138	A1011-23N	RUS-24	138	A1012-59AD	COR-193	103	1033N	UN-11	152	1043C	ILL-2	120
1007CB	SAR-17	141	L1007CC	SAR-94	141	O1007LB	SAR-11	140	1011K13	RUS-73D	138	A1011-24N	RUS-25	138	A1012-59B	COR-188	103	1036S	BEL-1	92	1043D	ILL-7	120
1007CC	SAR-18	141	L1007CD	SAR-101	141	O1007LC	SAR-12	140	1011MK	RUS-74D	137	A1011-25N	RUS-26	138	A1012-59B1	COR-181	103	1040A	CLU-1I	11	1043E	ILL-11D	120
1007CD	SAR-25	141	L1007CE	SAR-95	141	O1007LD	SAR-87	140	1011P	RUS-3	136	A1011-26N	RUS-27	138	A1012-59B2	COR-182	103	1040C	CLU-3	11	1043G	ILL-12	120
1007CE	SAR-19	141	L1007CF	SAR-96	141	O1007LDH	SAR-90	140	1011PH	RUS-59D	137	A1011-27N	RUS-28	138	A1012-59C	COR-189	103	1040E	CLU-5	11	1043J	TIM-1D	149
1007CF	SAR-20	141	L1007CG	SAR-97	141	O1007LE	SAR-82	140	1011PM	RUS-60D	137	A1011-28N	RUS-29	138	A1012-59C1	COR-183	103	1040U	BS-9	39	1045	AME-1	87
1007CG	SAR-21	141	L1007CH	SAR-102	141	O1007LF	SAR-83	140	1011PZ	RUS-58D	137	A1011-L1	RUS-5D	136	A1012-59C2	COR-184	103	R1040C	CLU-2	11	A1045	AME-2	87
1007CH	SAR-26	141	L1007CJ	SAR-98	141	O1007LG	SAR-84	140	1011-L1	RUS-4D	136	A1011-L2	RUS-8D	136	A1012-59CD	COR-192	103	1040E	CLU-4	11	A1045L	AME-9	88
1007CJ	SAR-22	141	L1007CK	SAR-99	141	O1007LH	SAR-88	140	1011-L2	RUS-30D	136	A1011-L3	RUS-9D	136	A1012-59D	COR-190	103	1041C	AME-3	87	1045L	AME-8	87
1007CK	SAR-23	141	L1007CL	SAR-100	141	O1007LHM	SAR-91	140	1011-L3	RUS-31D	136	A1011-L4	RUS-14D	136	A1012-59D1	COR-185	103	1041CE	AME-6	87	1046	JU-1	87
1007CL	SAR-24	141	L1007CM	SAR-103	141	O1007LJ	SAR-13	140	1011-L4	RUS-32D	136	A1011-L12	RUS-36D	136	A1012-59D2	COR-186	103	1041CK	AME-7	87	1046A	JU-2	88
1007CM	SAR-27	141	L1007CN	SAR-104	141	O1007LK	SAR-85	140	1011-L12	RUS-33D	136	A1011-L34	RUS-37D	136	L1012-D1	COR-208	104	1041DB	CHI-29	99	1054DL	ILC-8D	119
1007CN	SAR-28	141	L1007LA	SAR-105	140	O1007LL	SAR-86	140	1011-L34	RUS-34D	136	A1011-L41	RUS-13D	136	L1012-D2	COR-209	104	1041DC	CHI-30	99	1054F	ILC-16	119
1007HA	SAR-42	142	L1007LB	SAR-106	140	O1007LM	SAR-89	140	1011-L41	RUS-35D	136	B1011D1	RUS-51	137	L1012-D3	COR-210	104	1041DE	CHI-32D	99	1054FN	ILC-5D	119
1007HB	SAR-43	142	L1007LC	SAR-107	140	O1007RA	SAR-7D	140	A1011D1	RUS-5	136	B1011D2	RUS-52	137	L1012-D4	COR-211	104	1041DH	CHI-33D	99	1054G	FR-12D	113
1007HC	SAR-44	142	L1007LD	SAR-114	140	O1007RB	SAR-11D	140	A1011D2	RUS-8	136	B1011D3	RUS-53	137	L1012-D12	COR-212	104	1041DV	CHI-31D	99	1054K	ILC-1D	119
1007HD	SAR-51	142	L1007LE	SAR-108	140	O1007RC	SAR-12D	140	A1011D3	RUS-9	136	B1011D4	RUS-54	137	L1012-D34	COR-213	104	1041E	CHI-14	98	1054LB	ILC-6D	119
1007HDH	SAR-54	142	L1007LF	SAR-109	140	O1007RD	SAR-87D	140	A1011D4	RUS-10	136	B1011D12	RUS-55	137	L1012-D41	COR-214	104	1041G	CHI-2	12--98	1054MT	ILC-2D	119
1007HE	SAR-45	142	L1007LG	SAR-110	140	O1007RDH	SAR-90D	140	A1011D12	RUS-36	136	B1011D34	RUS-56	137	1014	EAG-6	108	1041GA	CHI-1	12--98	1054UN	ILC-3	119
1007HF	SAR-46	142	L1007LH	SAR-115	140	O1007RE	SAR-82D	140	A1011D34	RUS-37	136	B1011D41	RUS-57	137	1014C	HAR-2D	117	1041GB	CHI-4	48--98	1054WB	WEI-1	155
1007HG	SAR-47	142	L1007LJ	SAR-111	140	O1007RF	SAR-83D	140	A1011D41	RUS-1	136	L1011-L1	COR-131D	104	1014DX	EAG-5D	109	1041GR	CHI-3	48--98	1054WC	WEI-4	FA1
1007HH	SAR-52	142	L1007LK	SAR-112	140	O1007RG	SAR-84D	140	A1011H1	RUS-38D	138	L1011-L2	COR-132D	104	O1014JS	EAG-2D	108	1041H	ILL-1	120	1054WD	FAL-13D	110
1007HJ	SAR-48	142	L1007LL	SAR-113	140	O1007RH	SAR-88D	140	A1011H2	RUS-39D	138	L1011-L3	COR-133D	104	X1014F	HAR-1I	117	1041K	CHI-35	48--98	1054WF	FAL-19D	110
1007HK	SAR-49	142	L1007LM	SAR-116	140	O1007RHM	SAR-91D	140	A1011H3	RUS-40D	138	L1011-L4	COR-134D	104	X1014L	LOR-1	125	1041N	CHI-5	98	1054WH	FAL-14D	110
1007HL	SAR-50	142	N1007KMA	SAR-1	140	O1007RJ	SAR-13D	140	A1011H5	RUS-41D	138	L1011-L12	COR-135D	104	A1015L	LWO-10D	124	1041T	CHI-12D	19--98--117	1054WJ	FAL-20D	110
1007HM	SAR-53	142	N1007KMB	SAR-6	139	O1007RK	SAR-85D	140	A1011H6	RUS-42D	138	L1011-L34	COR-136D	104	A1015LR	LWO-10	124	1041TR	CHI-12	98	1054WK	FAK-15D	110
1007HN	SAR-55	142	N1007KMC	SAR-117	140	O1007RL	SAR-86D	140	A1011H7	RUS-43D	138	L1011-L41	COR-137D	104	A1015M	LWO-3D	124	1041Y	CHI-13D	98	1054WL	FAL-16D	110
1007LA	SAR-8	139	N1007RMA	SAR-1D	140	O1007RM	SAR-89D	140	A1011H8	RUS-44D	138	N1011M	RUS-47	137	A1015MR	LWO-3	124	A1041U	AME-5	88	1054WN	FAL-17D	110
1007LB	SAR-69	139	N1007RMB	SAR-6D	139	1010B	SAR-4D	139	A1011H8	RUS-44D	138	N1011P	RUS-12	137	A1015NR	LWO-11D	124	C1041DN	CHI-34	99	1054WP	FAL-18D	110
1007LC	SAR-70	139	O1007CA	SAR-29	141	1010M	SAR-119D	142	A1011H5	RUS-41D	138	N1011S	RUS-45	137	A1015P	LWO-11	124	C1041J	CHI-17D	98	1054WR	FAL-21D	110
1007LD	SAR-77	139	O1007CB	SAR-30	141	1010N	SAR-2D	139	A1011H6	RUS-42D	138	N1011T	RUS-46	137	A1015PR	LWO-12D	124	C1041JB	CHI-25	98	A1054WB	WEI-2	156
1007LDH	SAR-80	139	O1007CC	SAR-31	141	A1010U	SAR-14D	142	A1011H7	RUS-43D	138	1012-D1	COR-194	103	A1015PR	LWO-12	124	C1041L	CHI-18	98	A1054WC	WEI-5	156
1007LE	SAR-71	139	O1007CD	SAR-38	141	L1010N	SAR-9D	142	A1011H8	RUS-44D	138	1012-D2	COR-195	103	A1015Q	LWO-13D	124	C1041N	CHI-19D	98	A1054WD	FAL-1D	110
1007LF	SAR-72	139	O1007CE	SAR-32	141	O1010	SAR-5D	142	A1011H8	RUS-44D	138	1012-D3	COR-196	103	A1015QR	LWO-13	124	C1041P	CHI-15D	98	A1054WF	FAL-8D	110
1007LG	SAR-73	139	O1007CF	SAR-33	141	S1010B	SAR-4	139	A1011H8	RUS-44D	138	1012-D4	COR-197	103	A1015R	LWO-14D	124	C1041R	CHI-24	98	A1054WH	FAL-3D	110
1007LH	SAR-78	139	O1007CG	SAR-34	141	1011	RUS-7	137	A1011H8	RUS-44D	138	1012-D12	COR-198	103	A1015RR	LWO-14	124	C1041SR	CHI-25D	98	A1054WJ	FAL-9D	110
1007LHM	SAR-81	139	O1007CH	SAR-39	141	1011D1	RUS-4	136	A1011H8	RUS-44D	138	1012-D34	COR-199	103	A1015S	LWO-15D	124	C1041S	CHI-26	98	A1054WK	FAL-4D	110
1007LJ	SAR-74	139	O1007CJ	SAR-35	141	1011D2	RUS-30	136	A1011H8	RUS-44D	138	1012-D41	COR-200	103	A1015SR	LWO-15	124	C1041TR	CHI-26D	98	A1054WL	FAL-5D	110
1007LK	SAR-75	139	O1007CK	SAR-36	141	1011D3	RUS-31	136	A1011H8	RUS-44D	138	A1012-D1	COR-201	104	A1015T	LWO-16D	124	C1041YR	CHI-27	98	A1054WN	FAL-6D	110
1007LL	SAR-76	139	O1007CL	SAR-37	141	1011D4	RUS-32	136	A1011H8	RUS-44D	138	A1012-D2	COR-202	104	A1015TR	LWO-16	124	R1041DC	CHI-30D	99	A1054WP	FAL-7D	110
1007LM	SAR-79	139	O1007CM	SAR-40	141	1011D12	RUS-33	136	A1011H8	RUS-44D	138	A1012-D3	COR-203	104	A1015U	LWO-17D	124	R1041DV	CHI-31	99	A1054WR	FAL-2D	110
1007RA	SAR-8D	139	O1007CN	SAR-41	141	1011D34	RUS-34	136	A1011H8	RUS-44D	138	A1012-D4	COR-204	104	A1015UR	LWO-17	124	S1041JA	CHI-16D	98	C1054B	CN-1D	8
1007RB	SAR-69D	139	O1007HA	SAR-56	142	1011D41	RUS-35	136	A1011H8	RUS-44D	138	A1012-D12	COR-205	104	A1015V	LWO-18D	124	SC1041R	CHI-20	98	D10		

COMPETITOR CROSS REFERENCE

Índice comparativo
Index comparatif

CROSS REF.	REF.	PAG.	CROSS REF.	REF.	PAG.	CROSS REF.	REF.	PAG.	CROSS REF.	REF.	PAG.	CROSS REF.	REF.	PAG.	CROSS REF.	REF.	PAG.	CROSS REF.	REF.	PAG.			
L1054B	ILC-7D	119	1074F	SLY-4D	146	D1098JD	JD-2	32	1120G	SLY-15D	146	1170BD	CHL-3	98	1307W	SLG-2	143	1584	AMM-1	19	1649	KMB-1	121
L1054G	FR-11D	113	1074G	SLY-5	146	D1098X	DX-4	105	1120H	SLY-16	146	1170C	CHL-2	98	1335S	MSL-2	185	1585	LOC-1D	123	1650	TRM-13	150
L1054M	BRG-2D	91	1074N	SLY-6	146	E1098JD	JD-3D	32	E1122A	YA-10D	165	1170CJ	CHL-4	98	SC1345	SLG-32	144	1588	FRE-1	19	1651	TRM-12	151
L1054WC	FAL-10D	110	A1074B	SLY-12D	146	F1098JD	JD-4D	32	F1122A	YA-8D	164	1170E	CHL-5	98	SC1347	SLG-33	144	1589I	CLB-5	11	1652	AUT-1D	91
L1054WB	WEI-11	156	A1074E	SLY-9	146	H1098LA	GM-32	23	K1122B	BRG-5D	91	1170M	CHL-6	98	SC1348	SLG-34	144	1589J	CLB-5D	11	1653	AME-4	87
L1054WD	FAL-11D	110	A1074F	SLY-10D	146	H1098M	GM-33	23	K1122C	BRG-4D	91	A1170B	CHL-7	98	SC1368	SLG-35	144	1590K	CLB-6	11	1654	KMB-3	121
L1054WH	FAL-12D	110	A1074G	SLY-11	146	H1098NR	BS-11	2	K1122D	BRG-1	91	A1170C	CHL-8	98	SC1400	SLG-36	144	1591L	CLB-7	11	1655	MDC-6S	129
MD1054K	MAS-16D	127	1079	KEI-1	121	O1098LA	GM-31	23	K1122N	BRG-3	91	A1170CB	CHL-9	98	1430	CLF-1	185	1591M	CLB-7D	11	1656	KEN-1	32
N1054WB	WEI-3	156	1079B	KEI-2	121	P1098A	GM-6	21	O1122	YA-44D	8-165	A1170D	CHL-10	98	SC1456	SLG-37	144	1591N	CLB-8	11	1657	KEN-4	33
X1054K	ILC-4D	119	1083J	NCR-1D	131	P1098AV	GM-16	22	O1122A	YA-45D	8-19-165	1175	WES-3D	156	SC1460	SLG-38	144	1591P	CLB-8D	11	1659	CNP-4	94
X1054KF	ILC-12D	119	1083K	NCR-2D	131	P1098C	GM-7	21	O1122AR	YA-45	39--165	1175N	WES-1D	156	SC1467	SLG-39	144	1594	CNP-2D	94	1659R	CNP-4D	94
X1054KR	ILC-12	119	1083L	NCR-3	131	P1098CV	GM-17	22	O1122B	YA-54D	165	1176	KWI-1K	121	SC1468	SLG-40	144	1595	BS-12	6	1660	FO-42D	19
X1054LF	ILC-11D	119	1083M	NCR-4D	131	P1098E	GM-8	21	O1122BE	YA-55D	165	A1176	KWI-9D	122	1502	ESP-3D	109	1597	HAW-1D	117	1661	CNP-6D	94
X1054LR	ILC-11	119	1083N	NCR-5D	131	P1098EV	GM-18	22	O1122BER	YA-55	165	A1176KT	KWI-5D	122	1502M	ESP-2D	109	1598	HAW-3D	117	1663	KMB-2	121
X1054WA	WEI-17D	156	1083P	NCR-6D	131	P1098J	GM-9	2-21	O1122BR	YA-54	165	A1176ST	KWI-2D	121	1503	ESP-1	109	1599	HAW-4D	117	1664	CN-2D	8
X1055GA	ILC-13D	119	1083R	NCR-7	131	P1098WC	GM-19	22	O1122C	YA-56D	165	A1176T	KWI-3D	121	1510	BAL-2	91	1600	HAW-2D	117	1665	TRM-15D	151
X1055GB	ILC-13	119	1083S	NCR-8	131	P1098WE	GM-20	22	O1122R	YA-44	165	N1176	WEI-18D	158	1511	BAL-1	91	1601	TRM-5D	151	1666	TRM-16D	151
X1055JK	ILC-14D	119	1083T	NCR-9D	131	S1098B	GM-10	22	1123	WLC-1D	156	1179	ARR-4D	89	1515	MDC-14DS	129	1602	TRM-6D	151	1667	TRM-17D	151
X1055JR	ILC-14	119	1092	MAS-10	126	S1098D	GM-11	22	1127DP	FO-32D	16	1179A	ARR-5D	89	A1515	MDC-3DS	128	1603	TRM-7	151	1669	CNP-5	94
1063KW	KWI-1KS	121	1092B	MAS-7	126	S1098H	GM-12	22	1127ES	FO-44D	17	A1179E	ARR-10	89	1516	CHU-1D	99	1604	TRM-8	151	1670	HAF-2D	117
1064D	NTL-2	131	1092C	MAS-21D	127	S1098K	GM-13	22	S1127C	FO-3	17	A1179F	ARR-11	89	1517	MDC-1S	128	1605	TOO-1D	54	1672	GRS-1	116
R1064D	NTL-2D	131	1092D	MAS-3D	126	S1098WD	GM-42D	25	H1132	YA-5D	164	A1179G	ARR-12	89	A1517	MDC-2S	128	1606	TRM-2D	151	1676	BUE-3	92
R1064E	NTL-1D	131	1092DD	MAS-33D	127	S1098WH	GM-43	25	HR1132	YA-5I	164	A1179H	ARR-13	89	1518	MDC-10S	129	1607	TRM-4	150	1678	EBE-1D	109
1069	HUD-5D	118	1092DS	MAS-13D	126	P1099	GM-22	22	1137B	CHI-IT	7-69-70-98-112	A1179I	ARR-14	89	1519	KOM-1	34	1608	TRM-3D	150	1681	FCS-2D	112
1069F	NTC-16D	131	1092E	MAS-33	127	P1101	GM-23	22	1141	TAY-5D	148	A1179J	ARR-15	89	1522	LSD-1D	126	1609	TRM-1	150	S1767CH	CHR-13D	8
1069G	NTC-7D	130	1092F	MAS-39D	127	S1105	GM-41	25	1141E	TAY-2	148	A1179K	ARR-16	89	1523	SIS-2	146	1610	TRM-9D	151	1770CH	CHR-11	8
1069H	NTC-8D	130	1092H	MAS-5D	126	P1106	GM-14	22	1141GE	TAY-3	148	A1179L	ARR-17	89	1528	IMP-1D	120	1611	GAS-4	20	P1770U	CHR-8	8
1069L	NTC-1D	130	1092J	MAS-8	126	P1107	GM-30	23	1141GS	TAY-4D	148	A1179N	ARR-18	89	1528R	IMP-1	120	1611R	GAS-4D	20	S1770U	CHR-12	8
1069LB	NTR-2D	131	1092K	MAS-40D	128	P1108	GM-21	22	1141GS	TAY-4D	148	A1179P	ARR-19	89	1536	HRD-2D	54--118	1614	LOR-2D	125	P1786	CHR-18	9
1069LC	NTR-1D	131	1092M	MAS-36D	127	P1109	GM-36	24	1145	SLG-3	143	A1179R	ARR-20	89	1536R	HRD-2	54--118	1616	WRI-1D	157	P1789	CHR-9	8
1069M	NTC-9D	130	1092N	MAS-9	126	P1110	GM-40	24	1145A	SLG-4	144	A1179S	ARR-21	89	1537	IMP-2	120	1617	FCS-1D	112	1793V	CHR-16	9
1069N	NTC-10D	130	1092NR	MAS-9D	126	P1111	GM-34	24	1145CE	SLG-13	143	A1179T	ARR-22	89	1540	KUB-2D	34	1618	BUE-1	91	P1793	CHR-10	8
1069T	NTC-20D	131	1092R	MAS-10D	126	P1112	GM-35	24	1145E	SLG-11	143	A1179V	ARR-23	89	1542	MDC-12DS	129	1618R	BUE-1D	91	P1794	CHR-14	9
M1069C	NTC-22D	131	1092V	MAS-12D	126	P1113	GM-39	24	1145EF	SLG-15	143	B1179-1C	ARR-9D	89	1543	MDC-7S	129	1620	TOO-2	54	P1795	CHR-15	9
M1069L	NTC-23D	79--131	1092VM	MAS-11D	126	A1114A	BES-1DS	92	1145F	SLG-12	143	B1179-1D	ARR-7D	89	1546	CLI-1D	19	1621	TRM-11D	151	1866-10	PUN-1D	134
N1069B	NTC-6	130	1092VR	MAS-7D	126	A1114B	BES-14DS	92	1145FG	SLG-21	143	N1179A	ARR-6D	89	1548	CMX-10D	97	1622	TRM-10D	151	1866-13	PUN-2D	134
N1069G	NTC-24D	131	1092-40	MAS-31D	127	A1114C	BES-2DS	92	1145G	SLG-22	143	1180S	XL-1	157	1550	CMX-4D	96	1623	TRM-14D	151	1970AM	AMM-3	2
N1069N	NTC-15D	131	1092-600A	MAS-41	128	A1114D	BES-3DS	92	1145H	SLG-23	143	1181FD	FO-38D	17	1558	CNP-3	94	1624	SOU-1D	146	S1970AM	AMM-2	2
R1069L	NTC-1	130	1092-900	MAS-19	127	A1114DD	BES-4DS	92	1145J	SLG-24	143	S1181FD	FO-37	17	1560	CAT-2	7	1626	SEN-2D	145	K1994	KEN-2D	32
S1069G	NTC-17D	131	1092-6000	MAS-18D	127	A1114E	BES-5DS	92	1145K	SLG-25	143	1184FD	FO-20D	15	1561	HUD-6	6--118	1629P	FRE-1.P	19	4015	MSL-1	185
S1069H	NTC-18D	131	1092-6000B	MAS-25D	127	A1114F	BES-16DS	92	1145L	SLG-14	143	1185FD	FO-26D	15	1562	HUD-7	118	1631	CML-1	94	6275LA	SAR-7S	139
S1069M	NTC-19D	131	1092-7000	MAS-2D	126	A1114FM	BES-15DS	92	A1145CE	SLG-8	144	1185TP	FO-41D.P	17	1563	HUD-8D	118	1632	CNP-1	94	6750	74G	189
S1069T	NTC-21D	131	1092-7000B	MAS-24D	126	A1114G	BES-6DS	92	A1145E	SLG-5	144	1186TS	FO-33D	16	1564	HUD-9	118	1634	WND-1	157	08260KW	KWI-2DS	121
1071	WIB-1	157	1096C	ELG-3	109	A1114H	BES-7DS	92	A1145EF	SLG-10	144	1186TSP	FO-29D.PI	16	1568	SWL-1	146	1636	SUN-1	147			
1071B	WIB-5	157	1096G	NTC-7D	130	A1114J	BES-8DS	92	A1145F	SLG-9	144	1190LN	FO-11D	14	1569	FO-35	19	1637	SEN-1D	145			
1071BD	WIB-6	157	C1096CN	ELG-1	109	A1114K	BES-9DS	92	A1145FG	SLG-19	144	1191ET	FO-29D	16	1570	FO-36	19	1638	MDC-5S	128	1000	YA-41D	158
1071BE	WIB-7	157	C1096LN	ELG-2	109	A1114L	BES-10DS	92	A1145G	SLG-18	144	1193FD	FO-8D	14	1573A	CLB-1D	11	A1638	MDC-4S	128	1000R	YA-41	158
1071BM	WIB-8	157	S1096G	LIN-3D	123	A1114M	BES-11DS	92	A1145H	SLG-16	144	1193MU	FO-39D	17	1573B	CLB-1	11	1639	LRD-1D	122	1000RS	YA-6I	164
1071D	WIB-2	157	1098DB	AMM-4	2-32-217	A1114Q	BES-12DS	92	A1145J	SLG-17	144	1195FD	FO-34D	16	1573C	CLB-2D	11	1640	LRD-1	122	1000RSH	YA-1I	157
1071E	WIB-3	157	1098GX	GAS-3	20--21	A1114R	BES-13DS	92	A1145K	SLG-20	144	1196CM	FO-30D	16	1573D	CLB-2	11	1643	MCP-1	130	1000S	YA-6D	164
1071M	WIB-4	157	1098M	BS-10	6--19	A1114TB	BES-17DS	92	A1145L	SLG-6	144	1196FD	FO-15D	15	1573E	CLB-3D	11	1645	FLT-1	113	1000SH	YA-1D	157
1073DF	SLY-8	146	1098PB	PER-1	46	P1114	GM-38	24	DS1145	DX-37	105	X1199B	BAS-2I	8	1573F	CLB-3	11	1645R	FLT-1D	113	1001RSC	CI-IL	99
S1073DF	SLY-2	146	1098X	HUD-4	25--117	P1115	GM-37	24	1147	MIS-1	185	SC1246	SLG-29	144	1574	HRD-1D	20--118	1646	NTC-14D	131	1001SC	CI-DL	99
1074B	SLY-7D	146	1098XL	BS-11	6	1119	EAR-1D	109	1148	MIS-2	185	SC1247	SLG-30	144	1574R	HRD-1	118	1646R	NTC-14	131	1002RS	CI-4I	99
1074BM	SLY-13D	146	C1098JD	JD-1	32	1120D	SLY-1D	146	1167FD	FO-21D	15	SC1248	SLG-31	144	1581G	CLB-4D	11	1647	EZS-1	110	1002S	CI-4D	99
1074E	SLY-3	146	D1098B	DX-7D																			

COMPETITOR CROSS REFERENCE

Índice comparativo
Index comparatif

CROSS REF.	REF.	PAG.	CROSS REF.	REF.	PAG.	CROSS REF.	REF.	PAG.	CROSS REF.	REF.	PAG.	CROSS REF.	REF.	PAG.	CROSS REF.	REF.	PAG.	CROSS REF.	REF.	PAG.	CROSS REF.	REF.	PAG.
1003S	VER-1D	155	1560	CAT-2	7	4500E	GM-8	21	HY14P	HY-10.P	29	VW71	VO-M	59	11A	SLG-3	143	101C	SLG-4S	143	B51P	GM-11.P	22
1005	YA-22D	158	1560	TE-8I	148	4500H	GM-12	22	IL1090	ILC-4D	119	WE1850C	WEI-3	156	11A	SLG-3S	143	101CE	SLG-8	144	B52	GAS-3	20--21
1005R	YA-22I	158	1570	COR-1D	100	4500J	GM-9	2--21	K1994	KEN-2D	32	WE1850T	WEI-1	155	11B	SLG-4	144	101CE	SLG-8S	143	B53	GM-2	21
1007	YA-80D	160	1570R	COR-1I	100	4500K	GM-13	22	KK1	KI-1D	33	Y149	CHR-12	8	14H	BRS-2	93	101E	SLG-5S	143	B61	OP-S	25--45
1007R	YA-80	160	2000	MAS-10	126	B53	GM-2	21	KK1P	KI-1D.P1	33	Y152	CHR-8	8	14H1	TX-8	153	101EF	SLG-10	144	B62	GM-16	22
1009	PR-6	134	2000	MAS-10S	126	B61P	OP-S.P	25--45	MIT1	MIT-16	41	Y154	CHR-9	8	14H2	TX-8D	153	101EF	SLG-10S	143	B63	GM-17	22
1010	KEI-1	121	2000R	MAS-10D	126	B63	GM-17	22	MIT1P	MIT-16.P	41	Y154P	CHR-9.P	8	15H1	TX-7	153	101F	SLG-9S	143	B64	GM-19	22
1016	SAF-4D	138	2001	MAS-17	127	B63P	GM-17.P	22	MIT3	MIT-14D	41	Y155	CHR-10	8	15H2	TX-7D	153	101FG	SLG-19	144	B65	GM-4	21
1016R	SAF-4	138	2001R	MAS-17D	127	B68	GM-22	22	MS13	TOYO-24	10	Y155P	CHR-10.P	8	19B	DIM-1D	106	101G	SLG-18	144	B67	GM-42D	22
1020	KEI-2	121	2002	GLO-19	116	B68P	GM-22.P	22	MZ9	MAZ-2D	35	Y157	CHR-14	9	22	SLG-1	143	101H	SLG-16	144	B68	GM-22	25
1021	GAT-1	113	2002R	GLO-19D	116	B74	GM-15D	26--28	MZ10	MAZ-2I	35	Y157P	CHR-14.P	9	E2	YA-284D	158	137B	CHI-IT	7-69-70-98-112	B77	GM-18	22
1040	LWO-5D	124	2004	JU-1	87	B74P	GM-15D.P	26--28	MZ13	MAZ-3D	35	Y159	CHR-15	9	G	OD-9D	132	1620	TOO-2	54	B78	GM-20	22
1042	LWO-4D	124	2005	CCL-3	95--131	B80	GM-24	23	MZ13P	MAZ-3D.P	35	YH47	YAMA-18D	75-78-80	X15	YA-285D	158	191	VI-2I	155	B79	GM-43	25
1045	PHI-52	134	2005R	CCL-3D	95	B86P	GM-14.P	22	MZ13R	MAZ-3I	35	YM29	OP-BA	45				191B	VI-4IP	155	B80	GM-24	23
1047	FNL-1D	111	2020	CCL-12	95	B106	GM-37	24	MZ17	MAZ-19D	36							6275LB	SAR-11	140	B84	GM-23	22
1050	RUS-3	136	2022	GAT-3D	113	B1113	ISU-5	31	MZ19	MAZ-17D	36							6275LC	SAR-12	140	B85	GM-41	25
1051	RUS-15	137	2023	VER-2D	155	BMW2	BM-HB	5--69	MZ19P	MAZ-17D.P	36							6275LJ	SAR-13	140	B86	GM-14	22
1052	SEG-ID	145	2030	CI-5DP	99	BMW2P	BM-HB.P	5--69	MZ25	MAZ-8D	35							6275RA	SAR-7D	140	B86P	GM-14.P	22
1052	SEG-1DL	145	2030R	CI-5IP	99	BMW3P	BM-2.P	4	MZ27	MAZ-13D	36							6275RB	SAR-11D	140	B88	GM-21	22
1060	HAR-1I	117	2031	YA-42D	165	DA25	DAT-12	43	MZ27P	MAZ-13D.P1	36							6275RC	SAR-12D	140	B89	GM-30	23
1064	VI-2I	155	2031R	YA-42	165	DA25P	DAT-6.P	42--53	MZ31	MAZ-11D	36							AB1	CI-4DP	99	B89P	GM-30.P	23
1064R	VI-2D	155	2032	YA-7D	164	DA28	DAT-18	43	NE20	NE-3	48							AB2	CI-4IP	99	B91	GM-34	24
1065	VI-1I	155	2032R	YA-7I	164	DA30	DAT-14	43	NE57P	FI-11.P	13							1A1FM1	BES-15DS	92	B91P	GM-34.P	24
1065R	VI-1D	155	2040	YA-25D	165	DA30P	DAT-14.P	43	NN41QP	NE-11.P	50							1A1G1	BES-6DS	92	B92	GM-36	24
1066	VI-13	155	2040R	YA-25I	165	DA31	DAT-22	44	NN70LP	NE-35.P2	51--76							1A1H1	BES-7DS	92	B92	GM-35	24
1066R	VI-13D	155	2042	SAF-3D	138	DA31P	DAT-22.P	44	PA8	AU-HV	4							1A1J1	BES-8DS	92	AM1	AME-3	87
1071	COR-8I	102	2042R	SAF-3	138	DA34	DAT-16	43	PA8P	AU-HV.P1	4							1A1K1	BES-9DS	92	AM3	JU-1	87
1072	COR-62	102	2050	CHI-2	12--98	DC1P	TOYO-14.P	10-26-32-41-54	RA3	AMM-2	2							1A1L1	BES-10DS	92	AM6	AME-1	87
1075	COR-46	101	2060	CHI-5	98	DC3	MIT-2I	9--25--31-32--39	RA4	AMM-3	2							1A1M1	BES-11DS	92	AM6L	AME-4	87
1076	COR-9	100	2070	ILL-1	120	DC3P	MIT-2I.P	9--25--31-32--40	RN24P	NE-22.P	2--47							1A1Q1	BES-12DS	92	AM7	AME-2	87
1076R	COR-9D	100	2502	FO-32D	16	DC3P	MIT-2I.P	9--25--31-32--40	RN29	VA-10	3--10							1A1R1	BES-13DS	92	AR1	ARR-4D	89
1077R	GLO-17D	116	2504	FO-21D	15	F14	FI-13	13	RN30	NE-20	2--9--46							1A1TB1	BES-17DS	92	AR1C	ARR-9D	89
1078	SAF-1	138	2504R	FO-19	15	FT37	IMS-5	2	RN31	NE-28	3--9							1A1TD1	BES-23DS	92	AR1D	ARR-7D	89
1078R	SAF-1D	138	2506	FO-20D	15	FT38	IMS-3	2	S7BWP	BM-5.P	5							1A1TE1	BES-24DS	92	AR3	ARR-6D	89
1079S	GLO-18	116	2506T	FO-33D	16	H60	FO-11D	14	S34YSP	ME-10.P	38							11GA	YA-57D	160	AR4	ARR-5D	89
1080	GLO-5I	115	2510	YA-44D	8-165	H75	FO-15D	15	S48HFP	ME-2.P	37							11GB	YA-58D	160	AUT1	GAS-4D	20
1081	GLO-16	116	2520	YA-45D	8-19-165	HD70U	HOND-34	26	S50HFP	ME-4.P	37							11GC	YA-59D	160	B1	BS-10	6--19
1081R	GLO-16D	116	2520R	YA-45	39--165	HD90P	HOND-10.P	27	S66NNP	NE-40.P	60							11GD	YA-91D	160	B2	GM-33	23
1083	PAP-1	133	2540	GM-33	23	HD91	HOND-15	27	SAA1P	SAA-AC.P	51							11GE	YA-92D	160	B4	BS-11	6
1084	PAP-2	133	2550	GM-32	23	HD103	HOND-16D	27	SK30LP	SKO-3I.P	52							11GF	YA-93D	160	B5	AMM-4	2-32-117
1086	PAP-3	133	2585	NE-4	10--46	HD103P	HOND-16D.P	27	SUZ15	SUZU-10	53							11GG	YA-94D	160	B10	GM-32	23
1090	KWI-2DS	121	2586	NE-15I	14	HF40	BM-NB	5	SUZ15P	SUZU-10.P	54							11GH	YA-95D	160	B11	GM-31	23
1090	KWI-2D	121	3000	SLG-1	143	HF43	OP-J	45	SUZ17	SUZU-8	53							11GK	YA-96D	160	B44	GM-8	21
1090DE	DX-5DS	105	3005	SLG-2	143	HF59	OP-S	25--45	T61CP	TOYO-K1.P	55							11SA	YA-117D	162	B44P	GM-8.P	21
1090DE	DX-5D	105	4010	TOYO-K1	54	HF59R	OP-D	45	T61F	TOYO-2	54							11SB	YA-118D	162	B45	GM-12	22
1090H	KWI-1K	121	4031	DAT-21	44--53	HY2	HY-15D	30--39	TO40P	TOYO-9.P	55							11SC	YA-119D	162	B45P	GM-12.P	22
1090H	KWI-1KS	121	4032	DAT-21D	44	HY4P	HY-3.P2	28	TR33	TOYO-12	26--55							11SD	YA-120D	162	B46	GM-9	2--21
1092J	MAS-8	126	4050	TOYO-14	9-26-32-41-54	HY5P	HY-3D.P1	28--39	TR33P	TOYO-12.P	26--56							11SE	YA-121D	162	B46P	GM-9.P	2--21
1098DB	AMM-4	2-32-117				HY6	HY-4	29	TR39	TOYO-10	55							11SF	YA-122D	162	B47	GM-13	22
1100	FRP-1D	112	4070	MAZ-1D	35	HY6P	HY-4.P	29	TR40	TOYO-20D	56							11SG	YA-123D	162	B47P	GM-13.P	22
1137B	CHI-IT	7-69-70-98-112	4071	MAZ-1I	35	HY11P	HY-5.P	29	TR47	TOYO-15	56							11SH	YA-124D	162	B48	GM-6	21
1500X	SLG-3S	143	4310	VA-7	49	HY12	HY-6D	29	V37P	VO-AH.P	58							11SMK	YA-126D	162	B48P	GM-6.P	21
1500X	SLG-3	143	4321	NE-16	2	HY12P	HY-6D.P	29	VA87CP	VA-34.P1	50							54G	FR-12D	113	B49	GM-10	22
1501	SLG-12	143	4500A	GM-6	21	HY13	HY-5	29	VL6	NE-12	60							059AD-6	COR-6I	102	B49P	GM-10.P	22
1501	SLG-12	143	4500B	GM-10	22				VW27P	VO-FH.P1	59							100F	SLG-12	143	B50	GM-7	21
1502	SLG-11	143	4500C	GM-7	21				VW67	VO-K	59							100L	SLG-14	143	B50P	GM-7.P	21
1502	SLG-11S	144	4500D	GM-11	22																B51	GM-11	22

FLOOD®

JET®

1	YA-24D	158	1A1A1	BES-1DS	92
1A	SCA-2D	143	1A1B1	BES-14DS	92
1AX	SCA-4D	143	1A1C1	BES-2DS	92
1G	GLD-1	116	1A1D1	BES-3DS	92
1PX	PLI-2D	134	1A1DD1	BES-4DS	92
1S	SCA-1	142	1A1E1	BES-5DS	92
1S1	SCA-3D	143	1A1F1	BES-16DS	92
1SX	SCA-5	143	1A1FM1	BES-15DS	92
2	FLD-1D	112	1A1G1	BES-6DS	92
2A	TRI-23D	150	1A1H1	BES-7DS	92
2B	TRI-23	150	1A1J1	BES-8DS	92
2O	OD-10D	132	1A1K1	BES-9DS	92
2T	TE-8I	148	1A1L1	BES-10DS	92
3	YA-24I	157	1A1M1	BES-11DS	92
4G	ANV-2	88	1A1Q1	BES-12DS	92
4H	ANV-3D	88	1A1R1	BES-13DS	92
4R	TX-9D	153	1A1TB1	BES-17DS	92
4T	TX-9	153	1A1TD1	BES-23DS	92
5B	ANV-4D	88	1A1TE1	BES-24DS	92
5C	ANV-5	88	11GA	YA-57D	160
5D	ANV-1D	88	11GB	YA-58D	160
5DI	ANV-6D	88	11GC		

COMPETITOR CROSS REFERENCE

Índice comparativo
Index comparatif

CROSS REF.	REF.	PAG.	CROSS REF.	REF.	PAG.	CROSS REF.	REF.	PAG.	CROSS REF.	REF.	PAG.	CROSS REF.	REF.	PAG.	CROSS REF.	REF.	PAG.	CROSS REF.	REF.	PAG.	CROSS REF.	REF.	PAG.
CG1	CHI-2	12--98	DA37	DAT-20	44	HK1	HAW-1D	117	KK3	KI-3D	33	MIT6P	MIT-18.P	41	S68	SAR-2DS	139	WK2	WES-1D	156	AMC2	AMC-1D	87
CG2	CHI-1	12--98	DA37P	DAT-20.P	44	HK2	HAW-3D	117	KK4	KI-4D	33	MZ9	MAZ-2D	35	S69	SAR-9D	142	WR3	WEI-1	155	AML2	JU-1	87
CG4	CHI-3	48--98	DC3	TOYO-12D	55	HK3	HAW-4D	117	KK5	KI-6	34	MZ13	MAZ-3D	35	SAAI	SAAC-AC	51	WR5	WEI-3	156	AO12	ARO-2	89
CG16	CHI-12D	19--98--117	DE6	DX-5DS	105	HK4	HAW-2D	117	KP1	CHI-13D	98	MZ13P	MAZ-3D.P	35	SC1	SLG-3S	143	WR6	WEI-8	156	AO4	ARO-1D	89
CG22	CHI-14	98	DE6	DX-5D	105	HL1	HUD-3	96--117	KP9	CHI-16D	98	MZ16	MAZ-20D	36	SC1	SLG-3	143	XL7	XL-1	157	ARIEU	ARR-4D	89
CO1	COR-82	102	DE8	DX-6D	105	HL2	HUD-3D	117	KW1	KWI-1KS	121	MZ17	MAZ-19D	36	SC4	SLG-4	144	Y1	YA-41D	158	AR4	ARR-5D	89
CO2	COR-44	101	DM47R	DAE-4D.P1	11	HR1	HAR-2D	117	KW1	KWI-1K	121	MZ19	MAZ-17D	36	SC6	SLG-1	143	Y1E	YA-34D	165	BM1	BM-HB	5--69
CO2L	COR-46	101	DO6	DOI-4	108	HR2	TE-7D	148	KW5	KWI-9D	122	MZ19P	MAZ-17D.P	36	SC8	SLG-11S	144	Y1K	TE-17D	148	BM1P	BM-HB.P	5--69
CO3	COR-81	102	DW47	DAE-4.P1	11	HU66VWP	HU-HAA.P1	58	KW9	KWI-3D	121	MZ27	MAZ-13D	36	SC8	SLG-11	143	Y1R	YA-41	158	BM2	BM-NB	5
CO4	COR-174	101	EA27	HAR-1I	117	HY2	HY-15D	30--39	KW10	KWI-2DS	121	MZ27P	MAZ-13D.P1	36	SC9	SLG-5	144	Y2	YA-17D	159	BM2P	BM-NB.P	5
CO5	COR-83	102	EA47	EAG-2D	108	HY5	HY-3D	28--39	KW10	KWI-2D	121	MZ31	MAZ-11D	36	SC10	SLG-9	144	Y4	YA-80D	160	BO1	HUD-3D	117
CO6	COR-84	101	ES8	ESP-3D	109	HY6	HY-4	29	KW11	KWI-5D	122	NA6	NTL-1D	131	SC20	SLG-6	144	Y5	YA-63D	164	CA1	CTO-2	94
CO7	COR-62	102	ES8M	ESP-2D	109	HY12	HY-6D	29	L1	LWO-4D	124	NA12	NTR-2D	131	SE1	SEG-IDL	145	Y6	YA-82D	166	CA3	CTO-1	94
CO10	CCL-1D	95	ES9	ESP-1	109	HY12P	HY-6D.P	29	L1-6	RUS-5D	136	NA14	NTC-1D	130	SE1	SEG-1D	145	Y11	YA-44D	8-165	CA7K	CTO-3D	94
CO17	CCL-2D	95	EZ1	LSD-1D	126	HY13	HY-5	29	L2-6	RUS-8D	136	NA24	NTR-1D	131	SK1	SKI-1D	146	Y12	YA-45D	8-19-165	CAT1	CAT-2	7
CO19	CCL-3D	95	FA1	WEI-4	156	HY13P	HY-5.P	29	L3-6	RUS-9D	136	NE48	NE-11	17--33--50	SL1	SLY-1D	146	Y13	YA-44	165	CAT1P	CAT-1.P	7
CO26	CCL-12	95	FA2	WEI-5	156	HY14	HY-10	29	L4	LWO-5D	124	O4KA	LWO-2D	124	SR8	SUB-1	53	Y14	YA-45	39--165	CATK7	CTO-3DE	205
CO36	COR-45	101	FA3	FAL-1D	110	HY14P	HY-10.P	29	L6M	LWO-3D	124	P54F	DOI-5	108	SR8P	SUB-1.P	53	Y52	YA-13D	165	CHV4	GM-37	24
CO37	COR-47	101	FC7	FO-TX	3-18-50	HY15	HY-13D	30	L6MR	LWO-3	124	PR7	PR-7	134	SUZ11	SUZU-5	77	Y54	YA-25D	165	CK1	CLI-1D	19
CO51	COR-59	102	FT37	IMS-5	2	HY15PH	HY-13D.P3	30	L7M	BRG-2D	91	PU1	PUN-2D	134	SUZ17	SUZU-8	53	Y103	YA-54D	165	CO5	COR-62	102
CO52	COR-103	102	FT38	IMS-3	2	HY16	HY-12	30	L12-6	RUS-36D	136	PZ1	PAP-1	133	T3	TAY-2	148	Y149	CHR-12	8	CO6	COR-45	101
CO54 .1/2	CCL-3	95--131	H50	FO-19	15	HY16PH	HY-12.P3	30	L34-6	RUS-37D	136	R52	PHI-52	134	T7	TAY-3	148	Y152	CHR-8	8	CO14	HUD-3	96--117
CO62	COR-55D	101	H51	FO-21D	15	HY17	HY-11	29	L54G	FR-11D	113	R52L	PHI-52L	134	T32	PHI-32	134	Y153	CHR-18	9	CO33	CCL-1D	95
CO68	CCL-11	95--117	H54	FO-20D	15	HY17PH	HY-11.P3	29	L191A	VI-1I	155	R55	FNL-1D	111	TM100	TRM-7	151	Y153P	CHR-8.P	8	CO34	CCL-1	95
CO87	COR-8	100	H55	FO-26D	15	HYD15	HD-6	71	LR191A	VI-1D	155	R59	TE-8I	148	TM110	TRM-9D	151	Y154	CHR-9	8	CO36	COR-55D	101
CO88	COR-9	100	H56	FO-33D	16	HYD16	HD-6D	71	LXP90P	TOYO-18.P	56	RA3	AMM-2	2	TM130	TRM-3D	150	Y154P	CHR-9.P	8	CO37	COR-40	101
CO89	COR-56	102	H56P	FO-29D.P1	16	HYD17	HD-5	71	M1	MAS-10S	126	RA4	AMM-3	2	TM150	TRM-1	150	Y155	CHR-10	8	CO38	COR-1D	100
CO91	COR-63	102	H59	FO-28D	16	HYD18	HD-5D	71	M1	MAS-10	126	RN24	CHR-3	52	TM180	TRM-4	150	Y155P	CHR-10.P	8	CO40	COR-17D	100
CO92	COR-101	102	H60	FO-11D	14	HYD19	HD-7D	71	M1-RV	MAS-10D	126	RN30	NE-20	2--9--46	TM200	TRM-8	151	Y155V	CHR-16	9	CO51	COR-34	101
CO94	COR-60	102	H62	FO-29D	16	IL1	ILL-1	120	M2	MAS-7	126	RO1	HUD-5D	118	TM300	TRM-5D	151	Y157	CHR-14	9	CR1	CHR-8	8
CO95	COR-57	102	H62P	FO-29D.P	16	IL210	ILL-3	120	M3	MAS-7D	126	RU1	RUS-7	137	TM400	TRM-6D	151	Y157P	CHR-14.P	9	CR2	CHR-12	8
CO97	COR-7	100	H65	FO-9D	14	IL210M	ILL-4	120	M4	MAS-12D	126	RU4	RUS-12	137	TM700	TRM-2D	151	Y159	CHR-15	9	CR7	CHR-15	9
CO98	COR-58	102	H65P	FO-9D.P	14	IL260	ILL-7	120	M5	MAS-11D	126	RU4	RUS-3	136	TR20	TOYO-K1	54	Y159P	CHR-15.P	9	CS1	CI-4D	99
CO102	COR-102	102	H66NP	FO-39D	17	IL360	ILL-2D	39-120	M10	MAS-9S	126	RU16	RUS-6	137	TR23	TOYO-2	54	Y220	YA-60D	166	CS2	CI-4I	99
CR45	COR-194	103	H67	FO-8D	14	IL510	ILL-5	120	M10	MAS-9	126	RU19	RUS-35	136	TR25	TOYO-35D	57	Y227	YA-64D	166	CS3	CI-DL	99
CR46	COR-201	104	H67P	FO-8D.P	14	IL610	ILL-6	120	M11	MAS-5D	126	RU20	RUS-1	136	TR33	TOYO-12	26--55	YH38	YAMA-12D	80	CS4	CI-IL	99
CRL4-5	RUS-32D	136	H70	FO-12	15	IN1	ILC-16	119	M12	MAS-3D	126	RU21	RUS-47	137	TR33P	TOYO-12.P	26--56	YH46	YAMA-18I	75-80	CU1Q	KE-3	176
CRL4-6	RUS-14D	136	H71	FO-34D	16	IN3	ILC-4D	119	M13	MAS-13D	126	RU22	RUS-50	137	TR37	TOYO-13	55	YH47	YAMA-18D	75-78-80	CU3	CI-5DP	99
CRL41-6	RUS-13D	136	H75	FO-15D	15	IN8	ILC-7D	119	M19	MAS-8	126	RU45	RUS-4S	137	TR39	TOYO-10	55	YH48	YAMA-19I	75-78-81	CU3C	CI-4DP	99
D4300	NTC-14D	131	H75P	FO-15D.P	15	IN20	ILC-1D	119	M27	MAS-9D	126	RU45	RUS-4	136	TR40	TOYO-9	55	YH49	YAMA-19D	75-78-81	CU4	CI-5IP	99
D4301	NTC-14	131	H76	FO-23D	14	IN28	ILC-5D	119	M27	MAS-9DS	126	RU46	RUS-5S	137	TR40P	TOYO-9.P	55	YH65	YAMA-37D	82	CU4C	CI-4IP	99
D8783	NTC-7D	130	H76P	FO-23D.P	14	IN29	ILC-3	119	M900	MAS-19	127	RU46	RUS-5	136	TR47	TOYO-40	57	YU1	YU-1D	60	CV1C	GLO-1D	115
D8784	NTC-9D	130	H78	FO-30D	16	IN33	ILC-2D	119	M6000	MAS-18D	127	S4	SAR-5D	142	TR47P	TOYO-15.P	56				CV2C	GLO-1I	115
D8785	NTC-10D	130	HD71	HOND-34	26	IN35	ILC-8D	119	M6000B	MAS-25D	127	S6	SAR-1	140	TR53	TOYO-17	56				DE6	DX-5DS	105
D8787	NTC-11D	131	HD75	HOND-4I	71--75	K1	KEI-1	121	M7000	MAS-2D	126	S7BWP	BM-5.P	5	V26K	VO-K	59				DE6	DX-5D	105
D8788	NTC-12D	131	HD82	HOND-12	27	K2	KEI-2	121	M7000B	MAS-24D	126	S16	SAR-6	139	V28M	VO-M	59				DN1	DAT-21	44--53
D8789	NTC-13D	131	HD90	HOND-10	27	K100M	CHI-11	98	MA3	MAS-23	127	S22 1/2	SAR-8S	139	V29R	VO-R	59				DN1P	DAT-6.P1	42
DA21	DAT-21D	44	HD90P	HOND-10.P	27	K101	CHI-9D	98	MB16	ME-HF	38	S22 1/2	SAR-8	139	V30	VO-VB	58				DN3	DAT-21D	44
DA22	DAT-21	44--53	HD91	HOND-15	27	K102	CHI-10D	98	MB41	ME-HU	38	S31	SAR-1D	140	V30P	VO-VB.P	58				DN3P	DAT-6D.P1	42
DA23	DAT-21	42--53	HD91PH	HOND-15.P	27	K103	CHI-8D	98	MD17	MAS-16D	127	S32	SAR-6D	139	V37P	VO-AH.P	58				DN4P	DAT-11.P	42
DA24	DAT-2D	42	HD96	HOND-39D	1	K104	CHI-7D	98	MIT1	TOYO-20	56	S34YSP	ME-10.P	38	VL4	NE-9	59				DN5P	DAT-1D.P	42
DA25	DAT-12	43	HD103	HOND-16D	27	KA14	KAW-3	74	MIT1PH	MIT-16.P	41	S48HFP	ME-2.P	37	VL6	NE-12	60				DN6	DAT-24	44
DA28	DAT-18	43	HD103P	HOND-16D.P	27	KA30	KAW-7	74	MIT3	MIT-14D	41	S50HFP	ME-4.P	37	VL8	NE-18	60				DN6P	DAT-6.P	42--53
DA31	DAT-22	44	HD109	HOND-50	73	KA31	KAW-9	74	MIT4	MIT-7	40	S54F	DOI-1	108	WB1A	WIB-1	157				DN7	DAT-17D	43
DA34	DAT-16	43	HD114	HOND-33	72	KK1	KI-1D	33	MIT4P	MIT-7.P	40	S66NNP	NE-40.P	60	WB2B	WIB-2	157				DN7P	DAT-6D.P	42
DA34P	DAT-16.P	43				KK2	KI-2D	33	MIT6	MIT-18	41	S68	SAR-2D	139	WB2C	WIB-3	157				DN8	DAT-14	43

KLAUS®



COMPETITOR CROSS REFERENCE

Índice comparativo
Index comparatif

CROSS REF.	REF.	PAG.	CROSS REF.	REF.	PAG.	CROSS REF.	REF.	PAG.	CROSS REF.	REF.	PAG.	CROSS REF.	REF.	PAG.	CROSS REF.	REF.	PAG.	CROSS REF.	REF.	PAG.			
DN8P	DAT-14.P	43	GM6P	GM-8.P	21	HY10P	HY-12.P3	30	OP7P	OP-S.P	25--45	SZ8P	SUZU-12D.P	77	VI9	YET-9D	167	YA30	TRV-1	149	ASH2	ASH-2	172
DN9	DAT-16	43	GM7	GM-12	22	IN33	ILC-2D	119	OP8	OP-D	45	SZ10P	SUZU-19D.P	47	VI10	YET-9	167	YA33	FTE-3	113	ASH3	ASH-3D	172
DN9P	DAT-16.P	43	GM7P	GM-12.P	22	ISU1	ISU-1	31	OP8P	OP-D.P	45	T60	TE-T60	179	VI13	VI-13D	155	YA34	FTE-3D	113	ASH4	ASH-9D	172
DU1	DUR-1D	108	GM8	GM-9	2--21	ISU1P	MIT-2I.P	9--25--31-32--40	PA1	PAP-13	133	TE2	TE-7D	148	VI14	VI-13	155	YA35	YA-69D	158	ASH5	ASH-6D	172
DW2	DAE-2D	11	GM8P	GM-9.P	2--21	ISU2P	MIT-2D.P	40	PA2	PAP-14	133	TE5	TE-8I	148	VI15	YET-1	166	YA36	YA-69	158	AU10	AUS-1	90
DW2P	DAE-2D.P	11	GM9	GM-13	22	ISU3	ISU-5	31	PA3	PAP-3	133	TG1	ABU-3	123	VI16	YET-1D	166	YA37	YA-3D	164	AU17L	AUS-5	91
DW5P	DAE-3.P2	12	GM9P	GM-13.P	22	KAL1	KAE-8D	121	PA5	PAP-13D	133	TK1	GAS-2D	20	VITK13	VI-13DE	209	YA38	YA-3I	164	AU20P	AUS-7D	91
EA1	HAR-1I	117	GM11	GM-33	23	KAL2D	KAE-11D	176	PA6	PAP-14D	133	TK2	GAS-2	20	VITK14	VI-13E	209	YA43	YA-78D	158	AU21	AUS-6	91
EVG1	EVE-6	109	GM12	BS-11	6	KI1	KEI-2	121	PA7	PAP-8	133	TK2003I	FTE-2E	206	VO1	NE-12	60	YA44	YA-78	158	AU21C	AUS-6D	91
F2	AC-12	185	GM15P	GM-4.P	21	KI1P	KI-5.P	34	PA9	PAP-5	133	TO1	TOYO-K1	54	VW1	VO-K	59	YA57	YA-77D	158	AU22P	AUS-8	91
F3	26-M	185	GM17	GM-4	21	KI2P	KI-5D.P	34	PA11	PAP-9	133	TO1P	TOYO-K1.P	55	VW2	VO-M	59	YA66	YA-69E	211	AU24	BKY-1	178
F4	YA-30	185	GM17P	GM-4.P1	21	KI4P	KI-3D.P	33	PA13	PAP-4	133	TO2	TOYO-14	9-26-32-41-54	VW3	VO-13	59	YATK7	YA-138DE	211	AU24S	BKY-2	178
FA5K	FAM-1D	111	GM18	GM-4D	21	KW1	KWI-1K	121	PA15	PAP-2	133	TO2P	TOYO-14.P	10-26-32-41-54	VW3P	VO-VB.P	58	YATK8	YA-138E	211	AU3A	DIX-6D	107
FI1	NE-3	48	GM25	GM-5	21	KW1	KWI-1KS	121	PD1	PAD-4D	132	TO3	TOYO-2	54	VW5	VO-R	59	YATK11	YA-1DE	210	AU3AL	DIX-5D	107
FI2	FI-11	13	GM-25P	GM-5.P1	21	KW2	KWI-1IK	121	PD2	PAD-4	132	TO4	TOYO-24	10	VW9	VO-L	59	YATK27	YA-70DE	211	AU6X	AUS-1X	199
FI2P	FI-11.P	13	GM26	GM-5D	21	KW7	KWI-10D	122	PD8	PAD-5	132	TO5	TOYO-12D	55	VW11P	VO-HV.P	4--58	YATK28	YA-70E	211	AU6X	PHI-5X	200
FI4P	FI-13.P	13	GM26P	GM-5D.P1	21	LO1	LOT-1D	176	PD9	PAD-6	132	TO6	TOYO-12	26--55	VW15P	VO-2D.P	58	YATK29	TRV-1DE	209	AU9	AUS-2	90
FI5P	FI-3D.P1	12	GM29	GM-1	21	LOC1D	LOC-1D	123	PE1	NE-20	2--9--46	TO6P	TOYO-12.P	26--56	VW16P	VO-2.P	58	YATK30	TRV-1E	209	AZB14	AZ-14	172
FI7P	NE-15D.P	48	GM29P	GM-1.P	21	LOC2D	LOC-2D	123	PE1P	NE-36.P1	49	TO8	TOYO-16	56	W107R	YA-276D	159	YATK33	FTE-3E	206	CE3NR	CMX-4D	96
FO1	FO-19	15	GM30	GM-24	23	MA1	MAS-10	126	PE3	NE-47	14	TO8P	TOYO-16.P	56	W107TK	FTE-1DE	206	YATK34	FTE-3DE	206	CE42A	CMX-2D	96
FO2	FO-21D	15	GM30P	GM-24.P	23	MA1	MAS-10S	126	PE3P	NE-22.P	2--47	TO9	TOYO-10	55	W108R	YA-276	159	YH1	YAMA-7D	80	CE42AN	CMX-1D	96
FO7	FO-11D	14	GM33	GM-25	23	MA2	MAS-10D	126	PE7P	NE-3.P	48	TO9P	TOYO-10.P1	55	W2003TK	FTE-2DE	206	YH2	YAMA-7I	80	CE42DN	CMX-10D	97
FO10	FO-TX	3-18-50	GM33P	GM-25.P	23	MA10	MAS-9	126	PE9P	NE-4.P	10--46	TO10	TOYO-16D	56	W108TK	YA-276	159	YH3	YAMA-18D	75-78-80	CE42H	CMX-9D	97
FO10P	FO-TX.P	3--18	GO1	COR-82	102	MA10	MAS-9S	126	PH32	PHI-32	134	TO11	TOYO-15	56	W108TK	FTE-1E	206	YH3P	YAMA-18D.P	81	CE42K	CMX-8D	97
FO15P	FO-8D.P	14	GO2	COR-44	101	MA21	MAS-21D	127	PH55	PHI-52	134	TO11P	TOYO-40	57	W2003TK	FTE-2DE	206	YH4	YAMA-18I	75-80	CHI100	CHI-11	98
FO17	FO-11	14	GT5K	GAT-3D	113	MC1P	ME-9.P	38	PH55L	PHI-52L	134	TO12	TOYO-40D	57	WA1	WAH-1D	155	YH4P	YAMA-18I.P	81	CHI101	CHI-9D	98
FO25	FO-15D	15	GT7K	GAT-4	114	MG1	YA-84D	181	PR1	PR-6	134	TO12P	GM-38.P	24	WA2	WAH-1	155	YH5	YAMA-19D	75-78-81	CHI102	CHI-10D	98
FO25P	FO-15D.P	15	GT8K	GAT-2D	113	MG2	YA-84	181	PUP1P	BAJ-1.P	69	TO13	TOYO-17E	214	WE1	WEI-2	156	YH5P	YAMA-19D.P	81	CHI103	CHI-8D	98
FO27P	ME-HML.P	38	GT8K	GAT-4D	114	MG5	MU-12D	177	PUP2P	BAJ-3.P	69	TO13P	TOYO-17E1	214	WE2	WEI-1	155	YH6	YAMA-19I	75-78-81	CHI104	CHI-7D	98
FRP1	FRP-1D	112	HO2	HOND-15	27	MG6	MU-12	177	RE1	NE-36	49	TO19P	TOYO-19.P	56	WES1	WES-1D	156	YH6P	YAMA-19I.P	81	CHR68	CHR-8	8
FX1021	GAT-1	113	HO2P	HOND-15.P	27	MG7	UCEM-8D	180	RE3	NE-4	10--46	TR3	TRV-3D	150	YA1	YA-13D	165	YH9P	YAMA-20D.P	81	CHR69	CHR-12	8
FX1078	SAF-1	138	HO5P	HOND-4D.P2	71	MI1	MIT-2I	9--25--31-32--39	RE4	NE-4D	10--46	TRU1D	TRU-1D	151	YA2	YA-13I	165	YH10P	YAMA-20I.P	81	CHR81	CHR-9	8
FX1078R	SAF-1D	138	HO9P	HOND-4I.P1	71--75	MI2	MIT-4	40	RO1	RO-7D	135	TRU4D	TRU-4D	151	YA3	YA-7I	164	YH11P	YAMA-26.P	81	CHR81A	CHR-10	8
FX2040	YA-25D	165	HO10P	HOND-4D.P1	71	MI2P	MIT-4.P	40	RU3	RUS-3	136	TT50	PAP-1X	199	YA4	YA-80D	160	YH12P	YAMA-26D.P	81	CHR81AP	CHR-10.P	8
FX2040R	YA-25I	165	HO11	HOND-16D	27	MI3	MIT-11D	41	SA1	SAR-5D	142	TT60	PHI-3X	200	YA5	YA-80	160	YH14	YAMA-26	81	CHR81D	CHR-14	9
FX2042	SAF-3D	138	HO11P	HOND-16D.P	27	MI4	MIT-2D	39	SA2	SAR-14D	142	TT70	PHI-5X	200	YA6	YA-24D	158	YNT1	TE-17D	148	CHR81DP	CHR-14.P	9
FX2042R	SAF-3	138	HO12P	HOND-24.P	72	MI13	MIT-1I	39	SC1	SLG-3S	143	U1	UN-1I	152	YA6E	YA-41D	158	ZD1P	ZA-2.P	48	CHR81E	CHR-15	9
GA1	GAS-3	20--21	HO13	HOND-20D	72	MO38L	DIE-1	185	SC1	SLG-3	143	VAC1	VA-7	49	YA6S5	TE-29D	148	AB25P	ABU-29.P	85	CHR81EP	CHR-15.P	9
GB1	GLO-17	116	HO13P	HOND-20D.P	72	MR1	MER-16D	129	SC20	SLG-6	144	VAC2P	VA-34.P	49	YA6TK	YA-69DE	211	AB25P	TRU-10.P	152	CHR81P	CHR-9.P	8
GB2	GLO-17D	116	HO14	HOND-20	72	MT1P	MIT-1I.P	39	SC26	SLG-1	143	VE3	VER-2D	155	YA7	YA-138D	159	AB30	ABL-4	85	CO1A	COR-62	102
GB3	GLO-19D	116	HO14P	HOND-20.P	72	MZ1	MAZ-3D	35	SC27	SLG-2	143	VE1000K	VER-1D	155	YA8	YA-138	159	AC5	CHI-IT	7-69-70-98-112	CO1LL	COR-32	101
GB4	GLO-19	116	HY2	HY-15D	30--39	MZ1P	MAZ-3D.P	35	SC7	SLG-4S	143	VE1000RK	VER-1	155	YA8	YA-17I	159	AM64A	AMM-1	19	CO2LL	COR-33	101
GB5	GLO-3D	115	HY3	HY-3D	28--39	MZ2P	MAZ-3I.P	35	SE1	SEG-1D	145	VI1	VI-1D	155	YA9	YA-34D	165	AB25P	AMM-2	2	CO38	COR-41D	101
GB7	GLO-21	116	HY3P	HY-3D.P1	28--39	MZ2P	MAZ-3I.P	35	SE1	SEG-1DL	145	VI2	VI-1I	155	YA10	YA-24I	157	AB28	ABL-2	85	CO38A	COR-42	101
GB9	GLO-14	116	HY4	HY-3	28	MZ3	MAZ-8D	35	SKD1P	SKO-3I.P	52	VI3	VI-2D	155	YA107	FTE-1D	113	AB30	ABL-4	85	CO38B	COR-43D	101
GB11	GLO-20	116	HY4P	HY-3.P2	28	MZ3P	MAZ-8D.P	36	SZ1	SUZU-10.P	54	VI4	VI-2I	155	YA108	FTE-1	113	DEX10	DX-10	105	DEX10	DX-10	105
GM1	GM-32	23	HY5	HY-5	29	MZ5	MAZ-11D	36	SZ2	SUZU-10D	53	VI7	VI-4IP	155	YA11	YA-1D	157	DEX11	DX-11D	173	DEX11	DX-11D	173
GM2	GM-6	21	HY5P	HY-5.P	29	MZ6P	MAZ-11D.P1	36	SZ3	SUZU-16	78	VI8	VI-4DP	155	YA12	YA-1I	157	DEX47L	DX-6D	105	DEX47L	DX-6D	105
GM2P	GM-6.P	21	HY8P	HY-11D.P3	29	NE12P	NE-12.P	60	SZ3P	SUZU-16.P	78	VI9	YET-9D	167	YA14	YA-44D	8-165	AM64A	AMM-1	19	DEX47N	DX-5D	105
GM3	GM-10	22	HY9P	HY-11.P3	29	OJ3	OJ-9D	132	SZ4	SUZU-16D	78	VI10	YET-9	167	YA15	YA-45D	8-19-165	AM71	AMM-2	2	DEX47N	DX-5DS	105
GM3P	GM-10.P	22	OP1	OP-BA	45	OP1	OP-BA	45	SZ4P	SUZU-16D.P	78	VI13	YET-1	166	YA20	YA-44	165	AME61	AME-1	87	DEX9	DX-9	173
GM4	GM-7	21	OP1P	OP-BA.P	45	OP1P	OP-BA.P	45	SZ7	SUZU-8	53	VI15	YET-1D	166	YA21	YA-60D	166	AME61L	AME-2	87	DOI00	DOM-B1	174
GM4P	GM-7.P	21	OP3	OP-J	45	OP3P	OP-J.P	45	OP7	OP-S	25--45	VI16	YET-1D	166	YA23	YA-64D	166	AMI1	AMG-9D	171	DWO2P	DAE-5.P	12
GM5	GM-11	22	OP3P	OP-J.P	45	OP3P	OP-J.P	45	OP8	OP-D	45	VI17	YET-1D	166	YA27	YA-70D	158	ARI5	ACA-2D	88	ES29	74G	189
GM5P	GM-11.P	22	OP7	OP-S	25--45	OP7	OP-S	25--45	OP8P	OP-D.P	45	VI18	YET-1D	166	YA28	YA-70	158	AR49	ACA-1D	88	EZ1	EZ-DS15	174
GM6	GM-8	21	OP8	OP-D	45	OP8P	OP-D.P	45	OP9	PAP-5	133	VI9	YET-9D	167	YA29	TRV-1D	149	ASH1	ASH-1	89	EZ2	EZ-DS15R	174



COMPETITOR CROSS REFERENCE

Índice comparativo
Index comparatif

CROSS REF.	REF.	PAG.	CROSS REF.	REF.	PAG.	CROSS REF.	REF.	PAG.	CROSS REF.	REF.	PAG.	CROSS REF.	REF.	PAG.	CROSS REF.	REF.	PAG.	CROSS REF.	REF.	PAG.	CROSS REF.	REF.	PAG.
FAN1	FNL-12	111	HA1	HAW-1D	117	MA15	MAS-9	126	PH3	PHI-3Z	194	TOY24AP	TOYO-15.P	56	YA4	YA-45	39--165	AB19	ABU-51D	86	AM2R	FI-8I	13
FAN3	FNL-14	174	HA2	HAW-3D	117	MA15	MAS-9S	126	PH32	PHI-32	134	TOY24D	TOYO-33D	57	YA41P	YAMA-231.P	78--81	AB32	ABU-3	123	AMG2R	AMG-9D	171
FAN55	FNL-1D	111	HA3	HAW-2D	117	MA15A	MAS-5D	126	PH32L	PHI-32L	134	TOY24DP	TOYO-8.P	55	YA4C	YA-44D	8-165	AB38P	ABU-29.P	85	AMG3R	AMG-10D	171
FAN55A	FNL-11D	111	HA4	HAW-4D	117	MA15B	MAS-12D	126	PH4	PHI-4Z	194	TOY74	TOYO-K1	54	YA5	YA-43D	164	AB40	ABU-16	171	AML2R	AME-2	87
FAN55L	FNL-3D	111	HO103	HOND-16D	27	MA15C	MAS-11D	126	PH5	PHI-5Z	194	TOY74C	TOYO-14	9-26-32-41-54	YA5Y	SCO-4	145	AB43R	ABU-28	85	AML3R	AME-1	87
FAN57	FNL-2D	111	HO10P	HOND-16D.P	27	MA18	MAS-3D	126	PH50	PHI-5D	178	TOY74L	TOYO-12	26--55	YA6	YA-43	164	AB48	CI-48	173	AN1	ANA-1	88
FAN57D	FNL-6	111	HO112	HOND-31	28	MA1C	MAS-10D	126	PH52	PHI-52	134	TOY74LC	TOYO-12D	55	YA6Y	SCO-1	145	AB50	ABU-23D	85	APK2R	AP-1D	171
FIA10P	FI-11.P	13	HO33	HOND-15	27	MA2	MAS-7	126	PH52L	PHI-52L	134	TOY74LCP	TOYO-12D.P	56	YA8L	YA-17D	159	AB51	ABU-22D	85	AS1	ASI-1	89
FO20P	FO-6.P	17	HO33P	HOND-15.P	27	MA20	STA-6	147	PH57	PHI-13	178	TOY74LP	TOYO-12.P	26--56	YA8LH	YA-22D	158	AB52	ABU-20	85	ASC1R	ASH-6D	172
FO2A	FO-19	15	HO34	SUZU-16D	78	MA21	MAS-24D	126	PH6	PHI-6Z	194	TRI40C	TRI-3I	150	YA9L	YA-17I	159	AB54	ABU-14	85	ASS1R	AS-1D	51
FO2B	FO-21D	15	HO34C	SUZU-16	78	MA2C	MAS-7D	126	PH72X	PHI-6X	200	TRI50C	TRI-5I	150	YE32	YET-7	166	AB62	ABU-34	171	ASS2	AS-N5	89
FO2E	FO-8D	14	HO34C	SUZU-16	78	MA6	ABU-4I	148	RE25P	NE-36.P1	49	TRI60C	TRI-22	150	YE32C	YET-7D	166	AB74	CI-26	173	ASS2R	AS-P5	89
FO2EP	FO-8D.P	14	HO35P	HOND-16D.P1	1	MA6C	ABU-4D	148	RE34P	VA-34.P	49	TRU1	TRU-5	180	YE33	YET-11	167	AB84	ABU-81	171	ASS3	AS-A7	90
FO2H	FO-27D	15	HO36	HOND-19	71	MAZ21	MAZ-3D	35	RO101E	RON-4D	135	TRU109S	TRU-1D	151	YE33C	YET-11D	167	ABS2	AB-6I	85	ASS3R	AS-B7	90
FO2HP	FO-27D.P	16	HO36C	HOND-19D	71	MAZ21C	MAZ-3I	35	RO113	RON-1D	135	TRU109S	TRU-1D	151	YE34	YET-8	167	AF1A	AF-1I	52	ASS4	AS-D7	90
FO2L	FO-20D	15	HO36CP	HOND-19D.P	72	MAZ21L	MAZ-13D	36	RO114	RON-5D	135	TRU1C	TRU-5D	180	YE34C	YET-8D	167	AF1B	AF-1D	52	ASS4R	AS-H7	90
FO2LL	FO-11D	14	HO36P	HOND-19.P	72	MAZ21P	MAZ-3D.P	35	RO99E	RON-2D	135	TRU2	TRU-12	180	YH41	YAMA-19I	75-78-81	AF3A	AF-4I	1--42	ASS7	AS-U5	90
FO2LP	FO-29D.P1	16	HO37	HOND-10	27	MB41LP	ME-9.P	38	ROP28	R-1G	195	TRU3	TRU-3D	151	YH41P	YAMA-19I.P	81	AF3B	AF-4D	1	ASS7R	AS-W5	90
FO2X	FO-18D	15	HO50	HOND-50	73	MCM10	MCM-10	177	ROP28	R-1Z	195	TRU4	TRU-13D	180	ZD17RAP	ZA-7D.P	70-77	AF4A	AF-6I	1	ASS8	AS-U7	90
FO32	FO-TX	3-18-50	HO50P	HOND-24.P	72	MEC1	MEC-5D	128	SA4A	SAR-5D	142	TRU6L	TRU-2	151	2UN2	UN-1G	194	AF4B	AF-6D	1	ASS8R	AS-W7	90
FO32P	FO-TX.P	3--18	HON42	HOND-20	72	MG17X	DIX-2X	199	SA52	SAR-4D	139	TRU8P	TRU-8.P	152	3F1640	E-3G	195	AF4C	AF-5I	1	ASS9	AS-A5	89
FO54A	FO-23D	14	HY28D	HY-5	29	MG20	IF-120	118	SAR4B	SAR-3D	139	TT3X	PHI-3X	200	3F3042Q	L-3G	195	AF4D	AF-5D	1	ASS98	AS-24D	51
GAS24R	GAS-1	19	HY28DP	HY-5.P	29	MG20	MGG-1D	129	SC1	SLG-1	143	UC8	UCEM-8D	180	VAR3	SOP-3D	179	AF5A	FEM-1D	2	ASS9R	AS-B5	89
GAS24R	GAS-1S	20	IK1	MAG-1D	176	MG25/30	MGG-2D	130	SC14	SLG-8	144	VAR5	SOP-5D	179	VAR5	SOP-5D	179	AF5B	FEM-1I	2	ASS11	AS-G5	89
GAS31	FEM-4D	112	IKE2	MAG-4D	176	MG40	MGG-3D	130	SC14	SLG-8S	143	VAR5C	SOP-5	179	3FA00	A-1G	195	AF5C	FEM-2D	2--26	ASS11R	AS-M5	89
GAS43	GAS-3	20--21	IL26	ILC-1D	119	MG50	MGG-4D	130	SC15	SLG-6	144	VO33P	HU-DH.P	59	5602	224G	189	AF5D	FEM-2I	2	ASS12	AS-G7	90
GB40	GLO-19D	116	ILC3	ILC-5D	119	MG50	TRI-9D	150	SC5	SLG-4	144	VO73P	VO-8.P	58	5AT1	ATR-2G	190	AF7A	IMS-5	2	ASS12R	AS-M7	90
GB40C	GLO-19	116	ILL40	ILL-2D	39-120	MG60	TRI-22D	150	SC5	SLG-4S	143	VVW27P	HU-HAA.P1	58	5CS10P	CI-5.PG	191	AF7C	IMS-3	2	ASS13	AS-AL5	90
GGM39	GM-39	24	ISE15	IS-6D	175	MIT22	TOYO-20	56	SC6	SLG-3	143	VVW35	VO-M	59	5CS2	CI-6G	191	AG2	AG-8D	87	ASS13R	AS-EL5	90
GGM39P	GM-39.P	24	JE124	JEN-1	120	MIT22C	TOYO-20D	56	SC9	SLG-5	144	VVW35C	VO-K	59	5CS2P	CI-6.PG	191	AG2R	AG-8I	87	ASS14	AS-AL7	90
GGM64	GM-6	21	KA41P	KAW-7.P	74	MO38L	MSL-3	185	SC9	SLG-5S	143	VVW36	VO-L	59	5E2I	EZ-1G	192	AG3	AG-10D	87	ASS14R	AS-EL7	90
GGM65	GM-10	22	KAB30	KA-1	175	MU14CP	MU-4.P1	177	SU41CP	YAMA-23D.P	78--81	VVW36C	VO-R	59	5FAC3	FAC-2G	192	AG3R	AG-10I	87	ASS15	AS-AK5	90
GGM66	GM-7	21	KAB31	KA-7	175	MU14PS/F	MU-2.P1	177	SZ39	SUZU-5	77	VVW41	VO-VB	58	5IE5	IS-1G	192	AG4	AG-11D	87	ASS15R	AS-EK5	90
GGM67	GM-11	22	KC1	KIB-1	121	MZ10C	MZ-1	130	SZ40CP	SUZU-16D.P	78	VVW41C	VO-VBD	58	5IT8	IT-1G	192	AG4R	AG-11	87	ASS16	AS-AK7	90
GGM70	GM-8	21	KE25A	KEN-2D	32	NA66	NTR-2D	131	SZ40P	SUZU-16.P	78	VVW41CP	VO-VBD.P	58	5MT5	MT-3G	193	AGA1	AGA-5I	86	ASS16R	AS-EK7	90
GGM72	GM-9	2--21	KE25AP	KEN-2D.P	33	NI37	DAT-11D	35--43	SZ41C	YAMA-19D	75-78-81	VVW41P	VO-VB.P	58	5R14	CR-14G	192	AGA1R	AGA-5D	86	ASS17	AS-AM5	90
GGM73	GM-12	22	KE62	KEN-1	32	NI39P	DAT-15	43	SZ41CP	YAMA-19D.P	81	VVW44	VO-9D	58	5R16	CR-4G	192	AGA2	AGA-6I	86	ASS17R	AS-EM5	90
GGM78	GM-13	22	KE81P	FRE-1.P	19	NI39P	DAT-15.P	43	TE10	TE-T10	179	VVW45	CLI-1D	19	5SCM10	SEC-2G	193	AGA2R	AGA-6D	86	ASS18	AS-AM7	90
GGM86	OP-S	25--45	KE81P	FRE-1.P	19	NI61N	DAT-21	44--53	TE59	TE-8I	148	VVW50	VO-HV	4--58	5SCM8	SEC-7G	193	AGA3	AGA-9I	86	ASS18R	AS-EM7	90
GGM86C	OP-D	45	KI43	KAE-12D	176	NI61NC	DAT-21D	44	TE59C	TE-8D	148	VVW50P	VO-HV.P	4--58	5TV1	TOV-1G	194	AGA4	AGA-19D	86	ASS20	AS-BL7	90
GGM86CP	OP-D.P	45	KL41	KAE-4	175	NI79	DAT-17D	43	TE60	TE-T60	179	VVW51	VO-AH	58	5YA8	YA-4G	194	AGA4R	AGA-19I	86	ASS20R	AS-FL7	90
GGM86P	OP-S.P	25--45	KL42	KAE-2	175	NI79C	DAT-17	43	TE80	TE-T80	180	VVW51C	VO-10D	58	6750	74G	189	AGA5	AGA-18D	86	ASS21	AS-BK5	90
GGM88	GM-29D	23	KL8	KAE-8D	121	NI80	DAT-18	43	TL2R	TRI-10I	150	VVW51CP	VO-2D.P1	58	6LAR1	LAR-3G	193	AGA5R	AGA-18I	86	ASS21R	AS-FK5	90
GGM88BP	GM-5.P	21	KWI109	KWI-1K	121	NI87	DAT-22	44	TO10	TOV-1	149	VVW51NP	VO-2.P	58	AB2	ABU-42D	85	AGA7	AGA-12	171	ASS22	AS-BK7	90
GGM88C	GM-29	23	KWI109B	KWI-1KS	121	NI87NP	DAT-10.P	42	TO10T	TOV-1G	194	VVW51P	VO-2.P1	58	AB2R	ABU-42	85	AGA25R	AGA-4D	86	ASS22R	AS-FK7	90
GGM89	GM-14	22	KWI109B	KWI-2D	121	NI87P	DAT-22.P	44	TO21	TOV-5	180	VVW52	VO-8	58	AB8	ABU-1D	85	AGB1	AGB-1D	87	ASS24	AS-BM7	90
GGM89P	GM-14.P	22	LIN1	LIN-19	176	NI91	DAT-16	43	TO21A	TOV-2	180	VVW52P	VO-8.P1	58	AB8R	ABU-1	85	AGB1R	AGB-1	87	ASS24R	AS-FM7	90
GGM89S	GM-30	23	LIN1	LIN-19D	176	NI91P	DAT-16.P	43	TO22	SCO-14	178	VVW52P	VO-8.P1	58	AB10	ABU-2D	85	AGB5	AGB-2	171	ASS25	AS-DK5	90
GGM89SP	GM-30.P	23	LO20A	LOC-2D	123	PA1	PAP-1	133	TO35	TOV-4	180	VVWH2	HU-HAAC2	65	AB10R	ABU-2I	85	AGE1	AGE-2D	87	ASS25R	AS-GK5	90
GGM91GC	GM-35	24	LO20C	LOC-3D	123	PA2	PAP-2	133	TO5	TOV-8D	180	WR5	WEI-3	156	AB13	ABU-12I	85	AK2	AU-C	4	ASS26	AS-DK7	90
GGM91GCP	GM-35.P	24	LO20L	LOC-4D	124	PA7SX	PAP-1X	199	TOY22	TOYO-9	55	YA1	YA-41D	158	AB14	ABU-4I	148	AKR1	ANK-1	88	ASS26R	AS-GK7	90
GGM92	GM-27	23	LO20N	LOC-1D	123	PA7X	PAP-2X	199	TOY22P	TOYO-9.P	55	YA1D	YA-34D	165	AB14R	ABU-4D	148	AKR2	ANK-2	88	ASS27	AS-DL5	90
GGM93	GM-37	24	LO23	ABU-3	123	PE5P	NE-20.P2	47	TOY24	TOYO-10	55	YAIH	YA-1D	157	AB15R	ABU-27D	85	AKR3	ANK-3	88	ASS27R	AS-GL5	90
GGM94	GM-38	24	LO58	LOC-5D	124	PH1	PHI-1Z	194	TOY24A	TOYO-15	56	YA2	YA-41	158	AB16R	ABU-40	85	AKR4	ANK-4	88	ASS28	AS-DL7	90
GGM94P	GM-38.P	24	MA1	MAS-10	126	PH10	PHI-4D	133				YA3	YA-45D	8-19-165	AB17	ABU-60	86	ALP1	ALP-3	87	ASS28R	AS-GL7	90
GM12R	GM-45D	25				PH2	PHI-2Z	194				YA3H	YA-3D	164	AB17R	ABU-50	86	ALP2	ALP-5D	87	ASS29	AS-DM5	90

SILCA®



COMPETITOR CROSS REFERENCE

Índice comparativo
Index comparatif

CROSS REF.	REF.	PAG.	CROSS REF.	REF.	PAG.	CROSS REF.	REF.	PAG.	CROSS REF.	REF.	PAG.	CROSS REF.	REF.	PAG.	CROSS REF.	REF.	PAG.	CROSS REF.	REF.	PAG.	CROSS REF.	REF.	PAG.
ASS29R	AS-GM5	90	BK5-11	BK-19/11	93	CB11R	COR-62	102	CE131	CE-114	173	CS500	CI-20	99	DD1	DAD-1D	105	DX8R	DX-27	106	FO10	FO-E/TC	18
ASS30	AS-DM7	90	BK5-12	BK-19/12	93	CB15	COR-27D	100	CEM1	CEM-BP	57	CS501	CI-24	99	DD2	DAD-1I	105	DX9R	DX-28	106	FO10AP	FO-TX.P	3--18
ASS30R	AS-GM7	90	BK5-13	BK-19/13	93	CB23R	COR-61	102	CEM3	CEM-JC	6	CSC	CI-2G	191	DD3	DAD-2D	105	DX10R	DX-29	106	FO10P	FO-E/TC.P	18
ASS31	AS-E5	89	BK5-15	BK-19/15	93	CB26R	COR-9	100	CEN1	CENT-1D	97	CTR1R	CAT-2	7	DD4	DAD-2I	105	DX11R	DX-30	106	FO11X	FO-TX1	18
ASS31R	AS-F5	89	BK5-16	BK-19/16	93	CB27R	COR-8	100	CEN1R	CENT-1I	97	CVL1	CVL-1D	104	DF3	DAF-1D	105	DX12R	DX-31	106	FO12X	FO-TX2	18
ASS32	AS-K7	90	BK5-19	BK-19/19	93	CB29	COR-25I	100	CEN2	CENT-2D	97	CVL1R	CVL-1I	104	DF3R	DAF-1	105	DX13R	DX-32	106	FO14R	FO-19	15
ASS32R	AS-L7	90	BK5-20	BK-19/20	93	CB29R	COR-55D	101	CEN3	CENT-3D	97	CVL3	CVL-5D	104	DH3R	DAI-2D	12	DX14R	DX-33	106	FO17P	FO-3D	17
ASS34	AS-T7	90	BK5-21	BK-19/21	93	CB29R	COR-45	101	CH1	CHI-2	12--98	CVL3R	CVL-5I	104	DH4RP	DAI-1.P	20	DX15R	DX-34	106	FO17R	FO-3	17
ASS34R	AS-V7	90	BK5-23	BK-19/23	93	CB30R	COR-13	100	CH2	CHI-1	12--98	CVL5R	CVL-9D	173	DM1	FO-FK	6-13-18-44-46	DX16R	DX-35	106	FO18	FO-20D	15
ASS35	AS-T5	90	BK5-25	BK-19/25	93	CB33R-A1	COR-116S	102	CH3	CHI-4	48--98	CY7	CHR-7	8	DM1R	FO-FR	3-6-13-44	DX17R	DX-36	106	FO19P	FO-4.P	17
ASS35R	AS-V5	90	BK5-26	BK-19/26	93	CB33R-A2	COR-117S	102	CH4	CHI-3	48--98	CY8	CHR-11	8	DM1RP	FO-FR.P	13	DX18R	DX-23	106	FO21P	FO-6.P	17
ASS36	AS-Z7	90	BK5-27	BK-19/27	93	CB33R-B1	COR-118S	102	CH8	CHI-5	98	CY10	CHR-8	8	DM2	DOM-9D	107	DX21R	DX-14	106	FO22R	FO-28D	16
ASS36R	AS-X7	90	BK5-31	BK-19/31	93	CB33R-B2	COR-119S	102	CH9T	CHI-1T	7-69-70-98-112	CY11	CHR-13D	8	DM3	DOM-5D	107	DX22R	DX-16	106	FO23RP	FO-7.P	17
ASS38	AS-N7	90	BK5-32	BK-19/32	93	CB33R-C1	COR-120S	102	CH11	CHI-7D	98	CY12	BS-7D	39	DM4R	DOM-6I	107	DX23R	DX-17	106	FO24	FO-33D	16
ASS38R	AS-P7	90	BRG1R	BRG-1	91	CB33R-C2	COR-121S	102	CH12	CHI-9D	98	CY12R	BS-7	39	DM6	DOM-3D	107	DX24R	DX-18	106	FO26	FO-11D	14
ASS40	AS-E7	90	BRG3	BRG-5D	91	CB33R-D1	COR-122S	102	CH13	CHI-10D	98	CY13	BS-8	39	DM6R	DOM-3I	107	DX25R	DX-19	106	FO27	FO-29D	16
ASS40R	AS-F7	90	BRG4	BRG-4D	91	CB33R-D2	COR-123S	102	CH14	CHI-8D	98	CY13R	BS-8D	39	DM8	DOM-1D	107	DX26R	DX-20	106	FO27P	FO-29D.P	16
ASS42	AS-S7	90	BRG5	BRG-3	91	CB36R	COR-44	101	CH15	CHI-11	98	CY14	BS-9D	39	DM8R	DOM-1I	107	DX27R	DX-21	106	FO28R	FO-40D	17
ASS45	AS-NN7	90	BRG6	BRG-2D	91	CB39R	COR-81	102	CH24R	CHI-20	98	CY14R	BS-9	39	DM10	DOM-36D	108	DX28R	DX-22	106	FO29	FO-39D	17
ASS52	AS-DD7	90	BRM1	BRU-1D	93	CB45R	COR-82	102	CH25R	CHI-21	98	CY15RP	CHR-8.P	8	DM10R	DOM-36	108	DX29R	DX-4	105	FO29BP	FO-8D.P1	14
ASS52R	AS-HH7	90	BT1	BL-1D	11--44	CB52R	COR-56	102	CHU6	CHU-1D	99	CY16	CHR-9	8	DM11	DOM-18D	107	EC5	TE-T10	179	FO30	FO-8D	14
ASS136R	AS-RC7	90	BT1R	BL-1I	11--44	CB54R	COR-83	102	CL1	CLU-1I	11	CY16P	CHR-9.P	8	DM17	DOM-12D	107	ED2	EVE-8	109	FO30BP	FO-8D.P	14
ASS149	AS-22	90	BUR1	BUR-1D	93	CB70	COR-17D	100	CL3	CLU-3	11	CY18	CHR-17	9--39	DM17R	DOM-12	107	ED4	EVE-6	109	FO31R	FO-9D	14
AUC1	ARO-1D	89	BUR1R	BUR-1I	93	CB73	RUS-10	136	CL4	CLU-4	11	CY19	CHR-10	8	DM22TVPX	DOM-32	174	EG1	HAR-1I	117	FO31RAP	FO-9D.P	14
AUC6	ARO-2	89	BUR2	BUR-2D	93	CB86	COR-15D	100	CL5	CLU-5	11	CY19P	CHR-10.P	8	DM25	DOM-7D	107	EG2R	EAG-2D	108	FO33AP	FO-10.P	14
AW1	ARR-1	108	BUR2R	BUR-2I	93	CE1	CE-6D	97	CLB4R	CLB-4D	11	CY20	CHR-16	9	DM26	DOM-55D	108	ELG3R	ELG-2	109	FO34	FO-12	15
AW2	ARR-2	108--112	BUR3R	BUR-29D	94	CE1R	CE-6I	97	CLU1	CLB-1	11	CY22	CHR-14	9	DM34	DOM-37D	108	ELG6R	ELG-1	109	FO34AP	FO-12.P	15
AW3	ARR-3	89	BUR6	BUR-8D	93	CE2	CE-5D	97	CLU1R	CLB-1D	11	CY22P	CHR-14.P	9	DM39R	DOM-29	108	ELG8R	ELG-3	109	FO35	FO-26D	15
AW5	ARR-5D	89	BUR7	BUR-28	94	CE2R	CE-5	97	CLU2	CLB-2	11	CY24	CHR-15	9	DM63	DOM-26D	107	EMK1	EMK-1	109	FO37R	FO-37	17
AW7	ARR-4D	89	BUR10R	BUR-12	94	CE4	CE-2D	97	CLU2R	CLB-2D	11	CY24BP	CHR-15.P	9	DM65-11	DOM-27D/11	107	ER1	ER-1D	109	FO39	FO-34D	16
AY1	ABL-1	85	BUR25	BUR-13D	94	CE4R	CE-2I	97	CLU3	CLB-3	11	DAT1	DAT-3D	42	DM65-20	DOM-27D/20	107	ERL1	EAR-1D	109	FO39CP	FO-34D.P	16
AY2	ABL-2	85	BUT1R	BUL-1	172	CE6	CE-3D	97	CLU3R	CLB-3D	11	DAT1R	DAT-3I	42	DM102	DOM-25D	107	ESPIR	ESP-1	109	FO40R	FO-15D	15
AY3	ABL-4	85	BVA1	BU-1D	94	CE6R	CE-3I	97	CLU5	CLB-5D	11	DAT4	DAT-4D	42	DM122	DOM-17I	174	EU1R	EU-1	109	FO40RBP	FO-15D.P	15
AY10P	ABL-5	85	BVA1R	BU-1I	94	CE8	CE-110	97	CLU5R	CLB-5	11	DAT4R	DAT-4I	42	DM138	DOM-43	174	EV2	EV-13D	110	FOT3	FO-OA	58
AY14	ABL-3	85	BW4	BM-B	5	CE13	CE-131D	98	CNI	CN-1D	8	DAT5	DAT-11D	35--43	DM139	DOM-B1	174	EV3	EV-2	110	FOT3R	FO-PN	16
AZ1	AZ-3D	91	BW6	BM-W	5	CE18	CE-1D	97	COR1	CO-1D	104	DAT5R	DAT-11	43	DO1	ILC-6D	119	EV4	EV-3D	110	FOT4	FO-OL	18
AZ1R	AZ-3I	91	BW7	BM-HB	5--69	CE18R	CE-1I	97	CR4R	ME-1	37	DAT6BP	DAT-1I.P	42	DO1R	DOI-1	108	EV4R	EV-3I	110	FOT4R	FO-OR	18
AZ6R	AZ-9D	172	BW7BP	BM-HB.P1	5	CE22-15	CE-77	97	CR4RP	ME-1.P	37	DAT6RBP	DAT-1D.P	42	DO2R	DOI-4	108	EV10	EV-1	110	FOT5	FO-PRL	18
AZ7	AZ-14	172	BW7P	BM-HB.P	5--69	CE22-16	CE-50	97	CS	CI-1G	191	DAT7	DAT-8	42	DU1	DU-1	45	EZ5X	EZ-DS15R	174	FOT5R	FO-PRR	18
AZ8	AZ-12	172	BW8	BM-NB	5	CE22-17	CE-78	97	CS6R	CI-4IP	99	DAT7R	DAT-8I	42	DV1	DAV-1	34	EZ6X	EZ-DS15	174	FO5R	FO-PRR	18
AZ10	AZ-17D	91	BW8P	BM-NB.P	5	CE22-18	CE-79	97	CS7	CI-5DP	99	DAT9	DAT-2I	42--53	DW05AP	DAE-4.P1	11	FAC6	FAC-2D	110	FO6	FO-XR	18
BA3	BAS-2I	8	CA1	CA-3I	95	CE22-25	CE-80	97	CS6R	CI-4IP	99	DAT9BP	DAT-2I.P	42--53	DW05RAP	DAE-4D.P1	11	FAC14	FAC-14D	110	FOT6R	FO-XL	18
BA8R	KEN-1	32	CA2	CA-4I	95	CE22-26	CE-55	97	CS7R	CI-5IP	99	DAT9R	DAT-2D	42	DW04R	DAE-3D	11	FAC15	FAC-19	174	FRT1	FR-11D	113
BAE1	BDA-1	172	CA2R	CA-4D	95	CE22-27	CE-56	97	CS8	CI-22D	99	DAT10	DAT-2I	44--53	DW04RAP	DAE-3D.P1	11	FAM5	FAM-1	111	FT4C	FIC-7	112
BAS1	BAST-1I	91	CA3	CA-2I	95	CE22-28	CE-57	97	CS10	CI-28D	99	DAT12	DAT-6	42--53	DW04RBP	DAE-3D.P1	11	FAM5	FAM-1	111	FT500	FIC-2	112
BE200	BE-4D	92	CA4	CA-15I	95	CE22-35	CE-81	97	CS17	CI-1D	99	DAT12BP	DAT-6.P1	42	DW07BP	OP-S.P1	12	FB6R	FB-19	52	GE1	GE-1D	114
BE201	BE-4I	92	CA5	CA-1I	95	CE22-36	CE-82	97	CS204	CI-4D	99	DAT12R	DAT-6D	42	DX1	DX-5D	105	FC9	FO-TC	6	GE4R	GE-21D	114
BE202	BE-5D	92	CA7	CA-5I	95	CE22-37	CE-83	97	CS205	CI-4I	99	DAT12RBP	DAT-6D.P1	42	DX1R	DX-5	105	FEB2	CF-1D	99	GHE1	GH-HX	54
BE203	BE-5I	92	CAX2R	CSB-2D	94	CE22-38	CE-84	97	CS206	CI-DL	99	DAT12RBP	DAT-6D.P	42	DX3R	DX-6	105	FEB2R	CF-1I	99	GHE2	GH-GX	54
BES20	ARR-9D	89	CB1	COR-50/60	101	CE22-45	CE-85	97	CS207	CI-IL	99	DAT13	DAT-12	43	DX4R	DX-24	106	FF15	FF-3	110	GL11R	GLO-5I	115
BES21	ARR-7D	89	CB3	COR-40	101	CE22-46	CE-86	97				DAT13P	DAT-6.P	42--53	DX5R	DX-25	106	FH2	TD-15	113	GL17R	GLO-9D	116
BH11	BH-2	6	CB4	COR-30	101	CE22-47	CE-87	97				DAT14	DAT-7	42	DX6R	DX-15	106	FH4	TD-1	113	GL3	GLO-7D	115
BH12	BH-5	6	CB5	COR-29D	101	CE22-48	CE-88	97				DAT15	DAT-14	43	DX7R	DX-26	106	FH6	TD-3	113	GL3R	GLO-7	115
BH4	BH-1	6	CB6	COR-1D	100	CE34	CE-99D	97				DAT15DP	DAT-14.P	43	DX8R	DX-26	106	FH7	TD-4	113	GL6	GLO-6	115
BILIT	BIL-1T	93	CB6R	COR-1I	100	CE35	CE-100D	97				DAT16	DAT-13	43	DX9R	DX-28	106	FH12	TD-7	174	GL6R	GLO-6D	115
BK1	BK-1D	93	CB11	SKI-1D	146	CE36	CE-101D	97				DAT16DP	DAT-13.P	43	DX10R	DX-29	106	FN1	FAL-1D	110	GL7	GLO-2	115
												DX7R	DX-26	106	DX11R	DX-30	106	FO6-OR	FO-21D	15	GL7R	GLO-2D	115



Índice comparativo
Index comparatif

CROSS REF.	REF.	PAG.	CROSS REF.	REF.	PAG.	CROSS REF.	REF.	PAG.	CROSS REF.	REF.	PAG.	CROSS REF.	REF.	PAG.	CROSS REF.	REF.	PAG.	CROSS REF.	REF.	PAG.	CROSS REF.	REF.	PAG.
GL8	GLO-3	115	GT10	FI-11	13	HON32P	HOND-1.P	27	HU9	HU-SX	5	JD1	JD-2	32	KW8R	KAW-2I	74	LP2R	LIP-2	123			
GL9	GLO-4D	115	GT10P	FI-11.P	13	HON33	HOND-2	26	HU17P	HU-2.P	28	JOW1	JWL-2D	120	KW9	KAW-1D	74	LP3	LIP-33	123			
GL9R	GLO-4I	115	GT12A	GIOB-1D	34	HON33P	HOND-2.P	27	HU20	OP-BB	25--45	JOW4R	JWL-6	120	KW9R	KAW-1I	74	LR1R	LOR-1	125			
GM1CP	GM-6.P	21	GT13A	GIOB-2I	34	HON34	HOND-8I	71	HU20R	OP-EE	45	JS3R	JIS-2I	120	KW11	KAW-4	74	LS1	LAS-R	46			
GM1-OR	GM-6	21	GT15R	FI-13	13	HON37	HOND-10	27	HU21	OP-CC	25--45	JU2	JUNI-2D	120	KW12P	KAW-5.P	74	LS1R	LAS-V	46			
GM2CP	GM-7.P	21	GT15RBP	FI-13.P1	13	HON37P	HOND-10.P	27	HU21R	OP-DD	45	K1	KEI-1	121	KW14AP	KAW-6.P	74	LS9	LAS-6D	122			
GM2-OR	GM-7	21	GT15RP	FI-13.P	13	HON37R	HOND-11	27	HU22	ME-HZ	38	KA1	KA-1	175	KW14RAP	KAW-6D.P	74	LS11	LAS-KT	122			
GM3DP	GM-10.P	22	GT16AP	AF-14.P	1	HON37RP	HOND-11.P	27	HU22P	ME-HZ.P	38	KA2	KA-2	175	KW15BP	KAW-7.P	74	LS13	LAS-FH	122			
GM3-OR	GM-10	22	GYA	YA-186D	159	HON38	HOND-12	27	HU23	ME-HD	38	KA3	KA-10	175	KW16CP	KAW-9.P	75	LS14	LAS-4	122			
GM4DP	GM-11.P	22	GYA6	YA-57D	160	HON38P	HOND-12.P	27	HU23P	ME-HD.P	38	KA4	KA-11	175	KW18DP	KAW-10.P	75	LT1	LIT-5D	123			
GM4-OR	GM-11	22	GYA7	YA-156D	161	HON38R	HOND-13	27	HU24	OP-FF	45	KA5	KA-3	175	KYM1P	KYM-1.P	76	LT2	LIT-1I	123			
GM5CP	GM-8.P	21	GYB	YA-187D	159	HON38RP	HOND-13.P	27	HU25	OP-HG	45	KA6	KA-6	175	KYM1RP	KYM-1D.P	76	LW4	LWO-1D	124			
GM5-OR	GM-8	21	GYB6	YA-58D	160	HON39	HOND-19	71	HU25R	OP-HH	45	KA7	KA-8	175	KYM2	KYM-2	76	LW4R	LWO-1	124			
GM6DP	GM-12.P	22	GYB7	YA-157D	161	HON39P	HOND-19.P	72	HU27	HU-P	5	KA8	KA-5	175	KYM2P	KYM-2.P	76	LW5	LWO-2D	124			
GM6-OR	GM-12	22	GYC	YA-188D	159	HON39R	HOND-19D	71	HU32	HU-MN	4	KA9	KA-4	175	KYM2RP	KYM-2D.P	76	LW12R	LWO-8	124			
GM7CP	GM-9.P	2--21	GYC6	YA-59D	160	HON39RP	HOND-19D.P	72	HU35	OP-J	45	KE1	KE-1	176	KYM4AP	KYM-3.P	76	LW20	LWO-4D	124			
GM7-OR	GM-9	2--21	GYC7	YA-158D	161	HON41P	HOND-28.P	72	HU35P	OP-J.P	45	KE3	KE-3	176	KYM4RAP	KYM-3D.P	76	LW20R	LWO-4	124			
GM8DP	GM-13.P	22	GYD	YA-189D	159	HON42	HOND-20	72	HU36	ME-HU	38	KE13	KE-4	176	LA13	CAM-1D	76	LW23	LWO-5D	124			
GM8-OR	GM-13	22	GYD6	YA-91D	160	HON42AP	HOND-20.P	72	HU36P	ME-HU.P	38	KF1	KFV-1	121	LAP2	LPO-1	122	LW25	LWO-3D	124			
GM11	GM-2	21	GYD7	YA-159D	161	HON42R	HOND-20D	72	HU37P	ME-NU.P	38	KI3	PJ-1	20--47	LAP3	LPO-2	122	LYA	YA-206D	159			
GM13R	GM-46D	25	GYE6	YA-92D	160	HON42RAP	HOND-20D.P	72	HU38P	HU-DF.P1	59	KI4	LAS-X	46	LB10	LASB-2D	122	LYA6	YA-97D	161			
GM14RP	GM-16.P	22	GYE7	YA-160D	161	HON43	HOND-14	27	HU39P	ME-2.P	37	KI4R	LAS-U	46	LB18	LASB-1	122	LYB	YA-207D	159			
GM15	GM-4	21	GYF	YA-191D	159	HON43RP	HOND-14.P	27	HU40P	ME-3.P	37	KI5	LAS-XS	20	LB19	LASB-1D	122	LYB6	YA-98D	161			
GM15P	GM-4.P	21	GYF6	YA-93D	160	HON44R	HOND-15	27	HU41AP	ME-5.P	37	KI5R	LAS-SX	20	LB28	LASB-2	122	LYC	YA-208D	159			
GM15P	GM-4.P1	21	GYF7	YA-161D	161	HON45R	HOND-15.P	27	HU41P	ME-4.P	37	KI6	LAS-TX	122	LB33	LASB-3D	122	LYC6	YA-99D	161			
GM16R	GM-42D	25	GYG	YA-192D	159	HON45RP	HOND-15.P	27	HU43P	OP-WH.P	45	KI7	LAS-XY	122	LC1	LIN-1I	122	LYD6	YA-100D	161			
GM17RP	GM-19.P	22	GYG6	YA-94D	160	HON49	HOND-34	26	HU43TA	OP-WHC1	64	KI10	LAS-Y	20--46	LC1R	LIN-1D	122	LYE	YA-210D	159			
GM19	GM-5	21	GYG7	YA-162D	161	HON51R	HOND-39D	1	HU44AP	ME-6.P	37	KI12	LAS-5	20--37-46	LC2	LIN-3D	123	LYE6	YA-101D	161			
GM19P	GM-5.P	21	GYH	YA-193D	159	HON52R	HOND-41D	1	HU46	OP-S	25--45	KI12R	LAS-5D	13--20-46	LC2R	LIN-3I	123	LYF	YA-211D	159			
GM21RP	GM-17.P	22	GYH6	YA-95D	160	HON53	HOND-40D	1	HU46P	OP-S.P	25--45	KI13	LAS-P	20	LC3	LIN-5D	123	LYF6	YA-102D	161			
GM23P	GM-1.P	21	GYH7	YA-163D	161	HON53AP	HOND-37D.P	1	HU48	AU-AN	58	KI16	LAS-1D	122	LC3R	LIN-5I	123	LYG	YA-212D	159			
GM24R	GM-15D	26--28	GYK	YA-194D	159	HON55	HOND-40D	1	HU49	AU-AH	3	KI17	LAS-1D	122	LC4	LIN-6D	123	LYG6	YA-103D	161			
GM24RP	GM-15D.P	26--28	GYK6	YA-96D	160	HON56R	HOND-38D	1	HU49	VO-2	58	KI17	PJ-2	58	LC5	LIN-7D	123	LYH	YA-213D	159			
GM25R	GM-21	22	GYK7	YA-164D	161	HON58R	HOND-16D	27	HU49BP	AU-AH.P	3	KI17	PJ-2	58	LC7R	LIN-10I	123	LYH6	YA-104D	161			
GM25RP	GM-21.P	22	GYP7R	YA-165	161	HON58RDP	HOND-16D.P	27	HU49CP	VO-2.P	58	KIA1R	KI-1D	33	LC11	LIN-15D	123	LYK	YA-214D	159			
GM26RP	GM-18.P	22	HD2	HUD-3D	117	HON58REP	HOND-16D.P1	1	HU49EP	VO-2.P1	58	KIA1RAP	KI-1D.P1	33	LC14R	LIN-19D	176	LYK6	YA-105D	161			
GM27RP	GM-20	22	HD2R	HUD-3	96--117	HON60AP	HOND-17.P	27	HU49P	VO-AH.P	58	KIA1RP	KI-1D.P	33	LEG1	LEG-1D	122	MAU1R	DEK-13	105			
GM28R	GM-43	25	HEN1	HEN-1	117	HON63FP	HOND-24.P	72	HU49RCP	VO-2D.P	58	KIA2R	KI-2D	33	LF2	LF-2	125	MAZ1	MAZ-1I	35			
GM29	GM-22	22	HF75	HAF-2	117	HON64BP	HOND-43.P	72	HU49REP	VO-2D.P1	58	KIA3R	KI-3D	33	LF4	LF-15	125	MAZ1R	MAZ-1D	35			
GM29P	GM-22.P	22	HF75R	HAF-2D	117	HON64RBP	HOND-43D.P	72	HU50	BM-2	4	KIA3RAP	KI-3D.P	33	LF6R	LF-1I	125	MAZ2	MAZ-2D	35			
GM30	GM-24	23	HMC1	HY-1	28	HON68BP	HOND-29.P	72	HU50AP	BM-2.P	4	KLE1	KAE-1	175	LF10	LF-RO	7--50	MAZ2R	MAZ-2I	35			
GM30AP	GM-24.P	23	HOL1R	CHL-1	98	HON68RBP	HOND-29D.P	72	HU55P	ME-10.P	38	KLE2R	KAE-2	175	LF11	LF-5	125	MAZ2RP	MAZ-2I.P	35			
GM31	GM-23	22	HON5	HOND-7D	71	HON72P	HOND-42.P	72	HU56RP	HU-DH.P	59	KLE3R	KAE-5	120	LF15R	LF-4I	125	MAZ3	MAZ-14D	36			
GM31P	GM-23.P	22	HON5R	HOND-7I	71	HR1	OJ-9D	132	HU57RP	HU-DN.P	59	KLE4	KAE-4	175	LF17	LF-27	125	MAZ7	MAZ-3D	35			
GM37	GM-14	22	HON23	HOND-3I	71	HRC1	HAR-2D	117	HU58AP	BM-5.P	5	KLE6RX	KAE-9	121	LF22	LF-8	125	MAZ7AP	MAZ-3D.P	35			
GM37EP	GM-14.P	22	HON23R	HOND-3D	71	HRD1R	HRD-1	118	HU59	BM-4	5	KLE7RX	KAE-8	121	LF24	LF-25	125	MAZ7R	MAZ-3I	35			
GM40	GM-25	23	HON31	HOND-4I	71--75				HU61AP	ME-12.P	38	KLE7X	KAE-8D	121	LF25	LF-40	125	MAZ7RAP	MAZ-3I.P	35			
GM40EP	GM-25.P	23	HON31CP	HOND-4I.P1	71--75				HU61P	ME-11.P	38	KLE9R	KAE-11D	176	LF26	LF-24	125	MAZ13	MAZ-17D	36			
GM41	GM-41	25	HON31P	HOND-4I.P	71				HU64P	ME-7.P	37	KLE10R	KAE-12D	176	LF27	LF-20	125	MAZ13DP	MAZ-17D.P	36			
GN1	GIB-1D	115	HON31R	HOND-4D	71				HU65AP	ME-8.P	37	KOM1	KOM-1	34	LF45R	LF-21	125	MAZ15	MAZ-4	35			
GS4R	DX-7D	105	HON31RBP	HOND-4D.P2	71				HU66P	HU-HAA.P1	58	KS1	KWI-1K	121	LH1	LAP-1	122	MAZ16BP	MAZ-7D.P	35			
GT5	FI-3D	12	HON31RBP	HOND-4D.P2	71				HU70EP	VO-8.P1	58	KS2	KWI-9D	122	LMP1	LMP-1	48	MAZ17	MAZ-20D	36			
GT5BP	FI-3D.P3	13	HON31RCP	HOND-4D.P1	71				HU72RP	ME-HML.P	38	KUB1R	KUB-2D	34	LMP2	LMP-2	46	MAZ17AP	MAZ-20D.P	37			
GT5FP	FI-3D.P1	12	HON31RP	HOND-4D.P	71				HU92RP	BM-6.P	5	KUB2R	KUB-1D	34	LMP4	LMP-4	46	MAZ19	MAZ-8D	35			
GT5P	FI-3D.P	12	HON32	HOND-1	26				HU100T	OP-11C1	64	KW7	KAW-3	74	LMP5	LMP-5	46	MAZ19FP	MAZ-8D.P	36			
GT6RFP	FI-6I.P1	13							HU101T	FO-24C1	63	KW8	KAW-2D	74	LP2	LIP-2D	123	MAZ20R	MAZ-13D	36			



COMPETITOR CROSS REFERENCE

Índice comparativo
Index comparatif

CROSS REF.	REF.	PAG.	CROSS REF.	REF.	PAG.	CROSS REF.	REF.	PAG.	CROSS REF.	REF.	PAG.	CROSS REF.	REF.	PAG.	CROSS REF.	REF.	PAG.	CROSS REF.	REF.	PAG.			
MAZ20REP	MAZ-13D.P	36	MS10	MAS-13D	126	NE55DP	NE-19.P1	48	RC2	CAT-3	7	RW7R	RUS-7	137	SAR9	SAR-71D	139	SE5	SEL-1D	145	SS10	SIS-2	146
MAZ20RGP	MAZ-13D.P1	36	MS11	MAS-11	126	NE55P	NE-19.P	48	RC3R	ALI-1	99	RW8R	RUS-3	136	SAR9R	SAR-71	139	SE5R	SEL-1I	145	SSY3	SSA-1	52
MAZ21R	MAZ-7D	35	MS11R	MAS-11D	126	NE57	NE-20	2--9--46	RG1	REG-1D	135	RW8R	RUS-15	137	SAR10	SAR-72D	139	SE7	SEL-2D	145	ST1	SCH-1D	144
MAZ21R	MAZ-18D	36	MS13R	MAS-5D	126	NE63	NE-28	3--9	RIC1	RIO-1D	135	RW9R	RUS-6	137	SAR10R	SAR-72	139	SE7R	SEL-2I	145	STA4	STA-1D	147
MAZ24REP	MAZ-11D.P1	36	MS17	MAS-2D	126	NE66	NE-40	60	RIQ1	GR-1I	116	RW10R	RUS-12	137	SAR11	SAR-73D	139	SEA3	CL-5D	12	STS3	STS-4D	147
MAZ25R	MAZ-11D	36	MS19	MAS-4D	126	NE66P	NE-40.P	60	RIQ1R	GR-1D	116	RW11	RUS-16D	138	SAR11R	SAR-73	139	SEA3	CL-5D	12	STS3	STS-4D	147
MBL1	MBL-1	130	MS20P	MAS-15.P	176	NE67AP	NE-41.P	60	RIQ2	GR-2I	116	RW11R	RUS-16	138	SAR12	SAR-78D	139	SEB2	SEA-2	179	STS5	STS-X5	179
MBL1R	MBL-1D	130	MS24	MAS-27D	127	NE70P	NE-34.P	47	RIQ3	GR-2D	116	RW12	RUS-17D	138	SAR12R	SAR-78	139	SEB3	SEA-1	179	STS6	STS-X6	179
MC1R	MCM-1	128	MSL1	MASL-1	176	NE71R	NE-35	51	RIQ4	GR-3D	116	RW12R	RUS-17D	138	SAR13	SAR-74D	139	SF6R	SAF-1	138	SV1	STUV-1D	147
MC3	MCM-6	128	MTK3P	MU-2.P1	177	NE71RDP	NE-35.P2	51--76	RIQ4R	GR-3I	116	RW14	RUS-19D	138	SAR13R	SAR-74	139	SG808	SHA-1	146	SV1R	STUV-1I	147
MC9X	MCM-4SS	176	MTK4P	MU-4.P1	177	NE72	NE-36	49	RIQ9R	BRI-1D	93	RW14R	RUS-19	138	SAR14	SAR-75D	139	SH1	SLG-1	143	SV2	STUV-3	147
MC10R	MCM-10	177	MTK8RP	MU-8.P1	177	NE72DP	NE-36.P1	49	RL1	26-M	185	RW15	RUS-20D	138	SAR14R	SAR-75	139	SH2	SLG-2	143	SWL1	SWL-1	146
MC11	MCM-12D	128	MTK9RP	MU-5.P1	177	NE72GP	NE-36.P	49	RO1	RO-2D	10--47--49--52	RW15R	RUS-20	138	SAR15	SAR-76D	139	SH3	SLG-3	143	SX10BP	SIX-5.P	11
MC12	MCM-13D	128	MTK10RP	MU-7.P1	177	NE72KP	NE-20.P2	47	RO1R	RO-2I	10--47--49--52	RW16	RUS-21D	138	SAR15R	SAR-76	139	SH3	SLG-3S	143	SX9AP	SIX-3.P	10
MC15R	MCM-16	177	MTK12RP	MU-11.P1	177	NE72LP	NE-20.P3	10	RO2	RO-1IS	18-52	RW16R	RUS-21	138	SAR16	SAR-79D	139	SH4	SLG-6	144	SX9CP	SIX-3.P1	10
MC19R	MCM-24C	128	MTK13RAP	MU-10.P	177	NE73	NE-38	49	RO2R	RO-1DS	52	RW17	RUS-22D	138	SAR16R	SAR-79	139	SH5	SLG-4	144	SX9GP	SIX-3.P2	10
MD4	MDC-3DS	128	MTNP	MT-6.PG	193	NE73AI	NE-60C1	64	RO4	RO-7D	135	RW17R	RUS-22	138	SAR17	SAR-6D	139	SH5	SLG-4S	143	SY1	SLY-1D	146
MD9R	MDC-2S	128	MTR1	MTR-1D	129	NE73DP	NE-38.P1	49	RO4R	RO-7I	47--135	RW18	RUS-23D	138	SAR17R	SAR-6	139	SH6	SLG-10	144	SZ1	SUZU-1I	77
MER1	MER-16D	129	MTY1	MIN-1D	130	NE74P	NE-45.P	76	RO5	RO-4D	10--52	RW18R	RUS-23	138	SAR18	SAR-80D	139	SH6	SLG-10S	143	SZ1R	SUZU-1D	77
MER4	MER-17	129	NCR2	HUD-5D	118	NE75EP	NE-52.P	51	RO5R	RO-4I	10--34--52	RW19	RUS-24D	138	SAR18R	SAR-80	139	SH7	SLG-9	144	SZ2	SUZU-2I	77
MET1	MTO-1	129	NCR4	NTL-1D	131	NE78P	NE-51.P2	47	RO6	RO-3	52	RW19R	RUS-24	138	SAR20	SAR-81D	139	SH7	SLG-9S	143	SZ2R	SUZU-2D	77
MG1	MGA-1D	130	NCR6	NTC-10D	130	NSN11	DAT-10	42	RO8	RO-10D	135	RW20	RUS-25D	138	SAR20R	SAR-81	139	SH8	SLG-15	143	SZ4	SUZU-16	78
MG1R	MGA-1	130	NCR7	NTR-2D	131	NSN11	DAT-22	44	RO8R	RO-10I	135	RW20R	RUS-25	138	SAR21	SAR-7D	140	SH9	SLG-12	143	SZ4P	SUZU-16.P	78
MHN2P	MHN-1.P	34	NCR8	NTC-16D	131	NSN11BP	DAT-10.P	42	RO9	RO-24D	135	RW21	RUS-26D	138	SAR21R	SAR-7	140	SH10	SLG-5	144	SZ4R	SUZU-16D	78
MIS1	MIL-1	185	NCR11R	NTC-6	130	NSN11BP	DAT-22.P	44	RO9R	RO-24I	135	RW21R	RUS-26	138	SAR21R	SAR-7S	139	SH10	SLG-5S	143	SZ4RP	SUZU-16D.P	78
MIS2	MIL-2	185	NE4	NE-4	10--46	NSN12	DAT-19	43	RO10	RO-5D	10	RW22	RUS-27D	138	SAR22	SAR-11D	140	SH11	SLG-11	143	SZ5	SUZU-5	77
MIT1	MIT-1D	39	NE5	NE-6	70--77	NSN12BP	DAT-19.P	43	RO10R	RO-5I	10	RW22R	RUS-27	138	SAR22R	SAR-11	140	SH11	SLG-11S	144	SZ5P	SUZU-5.P	77
MIT1R	MIT-1I	39	NE7	NE-37	14	NSN14	DAT-15	43	RO11	RO-6D	10--49--52	RW23	RUS-28D	138	SAR23	SAR-12D	140	SH12	SLG-22	143	SZ7	SUZU-6	77
MIT2	MIT-2D	39	NE9	NE-13	11	NSN14CP	DAT-15.P	43	RO11R	RO-6I	10--49--52	RW23R	RUS-28	138	SAR23R	SAR-12	140	SH13	SLG-23	143	SZ7R	SUZU-7	53
MIT2P	MIT-2D.P	40	NE9A	NE-25	7--39--51	NSN16R	DAT-20	44	RO12	RO-11D	47	RW26R	RUS-8	136	SAR24	SAR-87D	140	SH14	SLG-24	143	SZ10R	SUZU-11D	77
MIT2R	MIT-2I	9--25--31--32--39	NE10	NE-56	47	NSN16RBP	DAT-20.P	44	RO12R	RO-11I	47	RW30R	RUS-4	136	SAR24R	SAR-87	140	SH15	SLG-25	143	SZ10RP	SUZU-11D.P	77
MIT2RP	MIT-2I.P	9--25--31--32--40	NE17	NE-15I	14	NSN19	SUB-1	53	RO15	RO-1I	52	RW30R	RUS-4S	137	SAR25	SAR-82D	140	SH16	SLG-14	143	SZ11R	SUZU-8	53
MIT3R	MIT-3	40	NE17R	NE-15D	48	NW1	NTL-2D	131	RO15R	RO-1I	52	RW31R	RUS-30	136	SAR25R	SAR-82	140	SH17	SLG-13	143	SZ11RP	SUZU-8.P	53
MIT3RP	MIT-3.P	40	NE19	NE-1	4	OJ4R	OJ-6I	132	RO21	RO-16D	49--52--135	RW32R	RUS-31	136	SAR26	SAR-83D	140	SH18	SLG-21	143	SZ12	SUZU-10	53
MIT4R	MIT-4	40	NE20	NE-3	48	OJ10R	OJ-13	132	RO21R	RO-16I	49--52--135	RW33R	RUS-32	136	SAR26R	SAR-83	140	SH19	SLG-18	144	SZ12P	SUZU-10.P	54
MIT4RP	MIT-4.P	40	NE20AP	NE-3.P	48	OJ12R	OJ-14	132	RO23	RO-26I	135	RW34R	RUS-33	136	SAR27	SAR-84D	140	SH20	SLG-16	144	SZ14AP	SUZU-12.P	77
MIT4RP	MIT-4.P	40	NE20P	NE-3.P1	46	OM1	BH-4	6	RO27	RO-25I	135	RW35R	RUS-34	136	SAR27R	SAR-84	140	SH21	SLG-17	144	SZ14RAP	SUZU-12D.P	77
MIT6P	MIT-18.P	41	NE21AP	NE-4.P	10--46	PDO18	PAD-5	132	RO28	RO-15	49	RW36R	RUS-35	136	SAR28	SAR-88D	140	SH22	SLG-20	144	T7004	BAJ-1.P	69
MIT6R	MIT-6	40	NE23	CHR-3	52	PDO21	PAD-6	132	RO34	RO-12I	135	SA1	SA-1	138	SAR28R	SAR-88	140	SH23	SLG-8	144	T7023	BAJ-4.P	69
MIT7	MIT-9	40	NE23DP	NE-22.P	2--47	PF073	PR-16	134	RR6	YA-18D	50	SA4	SA-4	139	SAR29	SAR-13D	140	SH24	SLG-8S	143	T7074	TVS-2D.P	79
MIT8	MIT-7	40	NE26	NE-9	59	PF092	PR-7	134	RR6	YA-190D	159	SA5	SA-3I	139	SAR29R	SAR-13	140	SH25	SLG-19	144	T7095	HOND-58.P	73
MIT8AP	MIT-7.P	40	NE27	NE-10	50--59	PF092S	PR-6	134	RR7R	YA-21I	50	SA5R	SA-3D	139	SAR30	SAR-85D	140	SIP2	AF-7I	12	T7096	HOND-58D.P	73
MIT9R	MIT-11D	41	NE28	NE-5	48	PF208	PR-1D	134	RR10R	YA-20I	50	SAR1	SAR-2D	139	SAR30R	SAR-85	140	SK18	SKO-2	77	T7098	BAJ-3.P	69
MIT10	MIT-10	40	NE38	NE-11	17--33--50	PF209	PR-1	134	RU1	RU-1D	136	SAR1	SAR-2DS	139	SAR31	SAR-86D	140	SK20R	SKO-3I	52	T7099	TVS-3.P	79
MIT11R	MIT-14D	41	NE38AP	NE-11.P	50	PF210	PR-5D	134	RU5	RU-2D	136	SAR2	SAR-9D	142	SAR31R	SAR-86	140	SK20RP	SKO-3I.P	52	T7107	HOND-36D.P	72
MIT11RAP	MIT-8D.P	40	NE40	NE-12	60	PF211	PR-5I	134	RU5R	RU-2I	136	SAR3	SAR-1D	140	SAR32	SAR-89D	140	SK22RBP	SKO-5.P	52	T7108	HOND-36.P1	72
MIT12R	MIT-13D	41	NE40P	NE-12.P	60	PF212	PR-4D	134	RW1R	RUS-9	136	SAR3R	SAR-1	140	SAR32R	SAR-89	140	SL1	SEG-1D	145	T7109	HOND-36.P	72
MIT15AP	MIT-15.P	41	NE42	NE-16	2	PF213	PR-4I	134	RW2R	RUS-5	136	SAR5	SAR-8D	139	SAR33	SAR-90D	140	SL2	SEG-2D	145	T7120	YAMA-36D.P	82
MIW2	MIW-2	130	NE43	NE-32	20	PF2S	PR-10	134	RW2R	RUS-5S	137	SAR5R	SAR-8	139	SAR33R	SAR-90	140	SM1	GIU-1	115	T7121	TVS-ID.P	79
MS1	MAS-10	126	NE44	NE-8	5	PHL3R	PHI-15D	178	RW3	RUS-11D	138	SAR5R	SAR-8S	139	SAR35	SAR-91D	140	SM16	SM-1	146	T7133	HOND-36.P	72
MS3	MAS-6	126	NE51	NE-18	60	PK1	PLL-1	12	RW3R	RUS-11	138	SAR6	SAR-69D	139	SAR35R	SAR-91	140	SM9R	SM-3D	146	T7134	HOND-36D.P1	72
MS3R	MAS-9D	126	NE51P	NE-18.P	60	PZ1	PAP-1	133	RW4	RUS-18D	138	SAR6R	SAR-69	139	SC1	STL-1D	147	SO4	SOS-1D	146			
MS4R	MAS-12D	126	NE54	NE-29	47	PZ2	PAP-2	133	RW4R	RUS-18	138	SAR7	SAR-70D	139	SC2	STL-2I	147	SO6	SOS-2D	146			
MS6	MAS-3D	126	NE54BP	NE-29.P	47	PZ3	PAP-3	133	RW4R	RUS-18	138	SAR7R	SAR-70	139	SCM3RDZ	SEC-3	179	SR2	SR-2	147			
MS7	MAS-7	126	NE55	NE-19	48	PZ6	PAP-5	133	RW4R	RUS-18	138	SAR8	SAR-77D	139	SCU1	SCR-1	145	SR4	SR-1I	147			
MS8	MAS-8	126	NE55AP	NE-20.P	47	RB1	BS-1I	2	RW5R	RUS-1	136	SAR8R	SAR-77	139	SE3	SEL-4D	145	SR6	SR-4	147			



COMPETITOR CROSS REFERENCE

Índice comparativo
Index comparatif

CROSS REF.	REF.	PAG.	CROSS REF.	REF.	PAG.	CROSS REF.	REF.	PAG.	CROSS REF.	REF.	PAG.	CROSS REF.	REF.	PAG.	CROSS REF.	REF.	PAG.	CROSS REF.	REF.	PAG.			
T7136	HOND-47D.P	73	TO8X10	TOK-48	149	TOY36AP	TOYO-16.P1	56	UNI19	UN-NH	7	VAC15R	VA-RA	154	VO14R	CLI-1D	19	XZ1A	ZE-1X	201	YH1	YAMA-1D	80
T7152	HOND-58D.P1	73	TO8X11	TOK-38	149	TOY36P	TOYO-16.P	56	UNI20	UN-FR	7	VAC16	VA-LB	154	VYA6	YA-57	160	XZ1B	ZE-3X	201	YH1R	YAMA-1I	80
T7157	HOND-36D.P4	72	TO8X12	TOK-39	149	TOY37P	TOYO-5.P	55	UNI25	UN-NC	7	VAC16R	VA-RB	154	VYA7	YA-156	161	XZ1C	ZE-5X	201	YH2	YAMA-2I	80
T7164	BAJ-2.P3	69	TO8X14	TOK-40	149	TOY38R	TOYO-20D	56	UNI27	UN-5D	152	VAC17	VA-LC	154	VYB6	YA-58	160	XZ2A	ZE-2X	201	YH2R	YAMA-2D	80
TB1	DOB-1D	57	TO8X15	TOK-49	149	TOY38RAP	TOYO-9.P1	55	UNI28	UN-6D	152	VAC17R	VA-RC	154	VYB7	YA-157	161	XZ2B	ZE-4X	201	YH3	YAMA-3I	80
TB2	DOB-2D	57	TO8X16	TOK-41	149	TOY38RP	TOYO-9.P	55	UNI29	UN-46D	153	VAC18	VA-LD	154	VYC6	YA-59	160	XZ2C	ZE-6X	201	YH3R	YAMA-3D	80
TB2R	DOB-2	57	TO8X17	TOK-68	149	TOY40P	TOYO-18.P	56	UNI30	UN-47	153	VAC18R	VA-RD	154	VYC7	YA-158	161	YA1	YA-6D	164	YH4	YAMA-4D	80
TBE1P	JAU-1.P	18	TO8X18	TOK-69	149	TOY41R	TOYO-33D	57	UNI33	UN-19D	152	VAC19N	VA-LE	154	VYD6	YA-91	160	YA1E	YA-24D	158	YH6	YAMA-6I	80
TC1	TI-1D	148	TO9Y1	TOK-50	149	TOY42P	TOYO-10.P1	55	UNI33R	UN-19I	152	VAC19RN	VA-RE	154	VYD7	YA-159	161	YA1ER	YA-24I	157	YH6R	YAMA-6D	80
TE1	TE-1I	148	TO9Y2	TOK-42	149	TOY43	TOYO-15E	214	UNI34	UN-20D	152	VAC20N	VA-LF	154	VYE6	YA-92	160	YA1R	YA-6I	164	YH7	YAMA-7I	80
TE1R	TE-1D	148	TO9Y3	TOK-22	149	TOY43P	TOYO-40	57	UNI34R	UN-20I	152	VAC20RN	VA-RF	154	VYE7	YA-160	161	YA2	YA-80D	160	YH7R	YAMA-7D	80
TE2	TE-8I	148	TO9Y4	TOK-70	149	TOY43R	TOYO-15.P	56	UNI35	UN-21D	152	VAC21	VA-LG	154	VYF6	YA-93	160	YA2R	YA-28	165	YH8	YAMA-13I	80
TE2R	TE-8D	148	TO9Y5	TOK-51	149	TOY43RP	TOYO-40D	57	UNI35R	UN-21I	152	VAC21RN	VA-RG	154	VYF7	YA-161	161	YA2R	YA-80	160	YH8R	YAMA-13D	80
TE3	TE-7D	148	TO9Y6	TOK-43	149	TOY43RP	ISU-3D.P	31	UNI36	UN-22D	152	VAC22N	VA-LH	154	VYG6	YA-94	160	YA3	YA-13D	165	YH10	YAMA-12D	80
TE5	TE-T80	180	TO9Y7	TOK-52	149	TOY43RP	TOYO-15D.P	56	UNI36R	UN-22I	152	VAC22RN	VA-RH	154	VYG7	YA-162	161	YA3R	YA-13I	165	YH14	YAMA-15I	80
TE6	TE-8DKT1	148	TO9Y8	TOK-71	149	TOY46R	TOYO-17	56	UNI37	UN-23D	152	VAC23R	VA-RDH	154	VYH6	YA-95	160	YA4	YA-11D	165	YH14R	YAMA-15D	80
TE7	TE-T60	179	TO9Y9	TOK-53	149	TOY46RP	TOYO-17.P	56	UNI37R	UN-23I	152	VAC25R	VA-4D	154	VYH7	YA-163	161	YA4R	YA-11I	165	YH16	YAMA-12I	80
TE9	TE-T80SC	180	TO9Y10	TOK-54	149	TOY47BP	TOYO-19.P	56	UNI38	UN-24D	152	VAC29	VA-1	154	VYK6	YA-96	160	YA5	YA-17D	165	YH17	YAMA-14I	80
TE19	TE-T62	180	TO9Y11	TOK-64	149	TOY48P	TOYO-30.P1	57	UNI38R	UN-24I	152	VAC30	VA-24D	154	VYK7	YA-164	161	YA5R	YA-17I	159	YH17R	YAMA-14D	80
TFN2	TIF-1D	148	TO9Y12	TOK-66	149	TR1	TV-12	151	UNI39	UN-25D	152	VAC30R	VA-24I	154	WA1	WA-5D	155	YA6	YA-2D	157	YH19	YAMA-5I	80
TH1	TEU-1	185	TO9Y13	TOK-72	149	TR2	TV-11	151	UNI39R	UN-25I	152	VAC33	VA-13I	154	WA1R	WA-5I	155	YA7	YA-3D	164	YH19R	YAMA-5D	80
TK1	TK-2D	148	TO9Y14	TOK-24	149	TR3	TV-15D	151	UNI40	UN-26D	152	VAC33R	VA-13D	154	WA2	WA-4D	155	YA7R	YA-3I	164	YH25	YAMA-16I	80
TL1	TRI-7D	150	TO9Y15	TOK-73	149	TR4	TV-3D	151	UNI40R	UN-26I	152	VAC35	VA-7	49	WA2R	WA-4I	155	YA8	YA-7D	164	YH25R	YAMA-16D	80
TL1R	TRI-7I	150	TO9Y16	TOK-55	149	TV2	TOV-4	180	UNI41	UN-27D	152	VAC47	VA-19	154	WA3	WA-5DP	155	YA8R	YA-7I	164	YH26	YAMA-17I	80
TL2	TRI-10D	150	TO9Y17	TOK-65	149	TV3	TOV-5	180	UNI41R	UN-27I	152	VAC57	VA-21	154	WAS2	WAS-7D	14	YA13	YA-33D	164	YH26R	YAMA-17D	80
TL3	TRI-11D	150	TO9Y18	TOK-74	149	TV4	TOV-7	180	UNI44	UN-35D	153	VAC58	VA-22	154	WAS2R	WAS-7I	14	YA14	YA-5I	164	YH28	YAMA-18D	75-78-80
TL3R	TRI-11I	150	TOX13	TOK-8	149	TV5	TOV-1	149	UNI44R	UN-35I	152	VAC59	VA-10	3--10	WAS3	WAS-9D	14	YA14R	YA-5D	164	YH28BP	YAMA-18D.P	81
TL4	TRI-8D	150	TOY3R	TOYO-25	57	TY1	TAY-3	148	UNI45	UN-36D	153	VAC64SP	VA-17.P	49	WAS3R	WAS-9	14	YA15	YA-16D	50--164	YH28P	YAMA-22D.P	81
TL4R	TRI-8I	150	TOY4	TOYO-K1	54	TY2	TAY-5D	148	UNI45R	UN-36I	152	VAC102-AI	VA-61C1	64	WAS5	WAS-1	20	YA17	YA-8D	164	YH28P	YAMA-22D.P	81
TL5	TRI-9D	150	TOY4BP	TOYO-K1.P	55	UB3	URB-3D	181	UNI46	UN-37D	153	VAC102DP	VA-34.P	49	WAS6	DAT-5D	35--42	YA18	YA-27D	165	YH28R	YAMA-18I	75-80
TL5R	TRI-9I	150	TOY4R	TOYO-14	9-26-32-41-54	UC4R	UCEM-13D	180	UNI46R	UN-37I	152	VAC102GP	VA-34.P1	50	WEI1	WEI-1	155	YA18R	YA-27	165	YH28RBP	YAMA-18I.P	81
TL6	TRI-5D	150	TOY4RAP	TOYO-14.P	10-26-32-41-54	UC5R	UCEM-8D	180	UNI47	UN-38D	153	VEG1	VE-1D	155	WEI2	WEI-2	156	YA19	YA-10D	165	YH28RP	YAMA-22I.P	81
TL6R	TRI-5I	150	TOY5	TOYO-2	54	UC6R	UCEM-12	152	UNI47R	UN-38I	152	VII1R	VI-12	155	WEI4	WEI-5	156	YA19R	YA-10	165	YH29	YAMA-19D	75-78-81
TL7	TRI-6D	150	TOY11	TOYO-4	54	UL050E	U-5JD	158	UNI48	UN-39D	153	VII3	VI-7	155	WEI5	WEI-3	156	YA27R	YA-26I	165	YH29BP	YAMA-19D.P	81
TL7R	TRI-6I	150	TOY11BP	TOYO-4.P	55	UL050G	U-5CD	158	UNI48R	UN-39I	152	VII9	VI-14	181	WEI8	WEI-6	155	YA30R	YA-12I	165	YH29P	YAMA-23D.P	78--81
TL8	TRI-12D	150	TOY15	TOYO-6	55	UL050L	U-5DD	158	UNI49	UN-40D	153	VI080	VI-1I	155	WEI10	WEI-17D	156	YA31	YA-22D	158	YH29P	YAMA-23D.P	78--81
TL8R	TRI-12I	150	TOY19	TOYO-24	10	UL050M	U-5AD	158	UNI49R	UN-40I	152	VI081	VI-1D	155	WEL1	WLC-1D	156	YA31R	YA-22I	158	YH29R	YAMA-19I	75-78-81
TL9	TRI-3D	150	TOY23R	TOYO-27	57	UL051G	U-5CI	158	UNI50	UN-41D	153	VI082	VI-4I	155	WK1	WIL-1D	156	YA32	YA-25D	165	YH29RBP	YAMA-19I.P	81
TL9R	TRI-3I	150	TOY24	TOYO-8	55	UL051M	U-5AD	158	UNI50R	UN-41I	152	VI083	VI-4D	155	WK3	WIL-3D	156	YA32R	YA-25I	165	YH29RBP	YAMA-28.P	81
TL11	TRI-18D	150	TOY24P	TOYO-8.P	55	UL056	U-1D	157	UNI51	UN-42D	153	VI084	VI-4IP	155	WS1	WES-1D	156	YA35	YA-34D	165	YH29RBP	YAMA-23I.P	78--81
TL11R	TRI-18I	150	TOY25	TOYO-3	54	UL059	U-3I	157	UNI51R	UN-42I	152	VI085	VI-4DP	155	WS3	WES-3D	156	YA63	YA-32D	165	YH30RBP	YAMA-23I.P	78--81
TL15	TRI-17D	150	TOY26	TOYO-13	55	UL060	U-2D	157	UNI52	UN-43D	153	VI086	VI-2I	155	WT4	AU-W	4	YA70	YA-106D	161	YH30BP	YAMA-20D.P	81
TN3	TIT-7D	54	TOY26P	TOYO-13.P1	56	UNI1	UN-MRN	7-51	UNI52R	UN-43I	152	VI087	VI-2D	155	WT7	AU-HV	4	YA70R	YA-116	162	YH30BP	YAMA-20D.P	81
TO1	TOK-5D	149	TOY27	TOYO-12D	55	UNI2	UN-44	2-7-51-60	UR2	URKO-3D	154	VI089	VI-6D	155	WT7AP	VO-HV.P	4--58	YA84	YA-14D	165	YH30P	YAMA-24D.P	81
TO10	TOK-4D	149	TOY27R	TOYO-12	26--55	UNI2R	UN-44D	2	UR2R	URKO-3I	154	VO4R	VO-K	59	WT7BP	AU-HV.P1	4	YA84R	YA-14I	165	YH30P	YAMA-24D.P	81
TO30	WIN-5	157	TOY27RP	TOYO-12.P	26--56	UNI3	UN-11	152	VA7T	PEU-1C1	64	VO4RP	VO-K.P	59	WT10	VO-AH	58	YA88	YA-46D	165	YH30R	YAMA-20I	78--80
TO8X1	TOK-44	149	TOY28P	TOYO-28.P	57	UNI4	UN-FFE	7	VAC1	VA-3	154	VO5P	VO-L	59	WT10P	AU-AH.P1	4	YA89	YA-272D	166	YH30RBP	YAMA-20I.P	81
TO8X2	TOK-45	149	TOY29	TOYO-22	57	UNI4R	UN-3	7-51-79	VAC2	VA-8D	154	VO7	VO-VA	59	WT11	AU-1	3	YA91	YA-85D	166	YH30RBP	YAMA-20I.P	81
TO8X3	TOK-46	149	TOY29R	TOYO-22D	57	UNI6	UN-4	7	VAC3	VA-2	154	VO9	VO-VB	58	XBW4	BUR-4X	199	YA99R	YA-84D	181	YH30RBP	YAMA-29.P	81
TO8X4	TOK-21	149	TOY30	TOYO-10	55	UNI7	IN-1	3--6--50	VAC5	VA-5	154	VO9BP	VO-VB.P1	59	XCCF3	CIF-1X	199	YA1007	YA-30	185	YH30RP	YAMA-24I.P	81
TO8X5	TOK-47	149	TOY30P	TOYO-10.P	55	UNI8	UN-FT	3--17-19	VAC8	VA-33D	154	VO9DP	VO-VB.P	58	XOM1	BH-3	52	YA226	YA-1D	157	YH31R	YAMA-21I	81
TO8X7	TOK-37	149	TOY31	TOYO-11	55	UNI10	UN-FP	3--50	VAC10	VA-59	154	VO10	VO-M	59	XPZ1	PAP-1X	199	YA227	YA-1I	157	YH31RAP	YAMA-21I.P	81
TO8X8	TOK-63	149	TOY31P	TOYO-11.P	55	UNI11A	UN-FS	3--79	VAC11	VA-9D	154	VO11	VO-R	59	XPZ2	PAP-2X	199	YD6R	YAR-1	181	YH33RP	YAMA-25D.P	81
TO8X9	TOK-67	149	TOY32R	TOYO-29	57	UNI13	UN-1FS	7--152	VAC12	VA-6	48	VO12	VO-1	58	XY1	YA-1X	200	YD7R	YAR-2	181	YH34P	YAMA-27.P	81
			TOY36	TOYO-16	56	UNI16	IN-4	6	VAC14	VA-12D	154	VO13	VO-N	58	XY2	YA-2X	200	YD13R	YAR-3	181			
						UNI16R	IN-5	6	VAC15	VA-LA	154	VO13P	VO-N.P	58	XY3	YA-3X	200	YG1R	YU-1D	60			



COMPETITOR CROSS REFERENCE

Índice comparativo
Index comparatif

CROSS REF.	REF.	PAG.	CROSS REF.	REF.	PAG.
YH34RP	YAMA-27D.P	81	YYD6	YA-110	162
YH35	YAMA-26	81	YYD7	YA-149	162
YH35BP	YAMA-26.P	81	YYE6	YA-111	162
YH35R	YAMA-26D	81	YYE7	YA-150	162
YH35RBP	YAMA-26D.P	81	YYF6	YA-112	162
YH36P	YAMA-30.P	81	YYF7	YA-151	162
YH37RBP	YAMA-32D.P	82	YYG6	YA-113	162
YM9	OP-6	44	YYG7	YA-152	162
YM10	OP-7	44	YYH6	YA-114	162
YM10R	OP-8	44	YYH7	YA-153	162
YM11	OP-9	44	YYK6	YA-115	162
YM12	ME-HF	38	YYK7	YA-154	162
YM12P	ME-HF.P	38	YYP7R	YA-155	162
YM13	ME-L	39	ZD7	ZA-12	75-76-79
YM15	ME-HM	38	ZD9P	ZA-1.P	70
YM15P	ME-HM.P	38	ZD10P	ZA-2.P	48
YM16	OP-HA	45	ZD16RP	ZA-4D.P	70-76-79-82
YM16R	OP-HB	45	ZD21P	ZA-8.P	70
YM17	OP-NA	45	ZD22RBP	ZA-6D.P1	69
YM17R	OP-NB	45	ZD23RCP	ZA-9.P	70
YM20	OP-R	45	ZD24RDP	ZA-9.P1	70-73-76-79-82
YM21	OP-BA	45	ZD28RFP	ZA-6D.P	70
YM21P	OP-BA.P	45	ZE1	ZE-5D	167
YM21R	OP-AB	45	ZE1R	ZE-5I	167
YM22	SAA-AC	51	ZE5	ZE-K5	167
YM22AP	SAA-AC.P	51	ZE5R	ZE-K6	167
YM23	ME-HY	38	ZN1	ZEN-1D	167
YM23P	ME-HY.P	38			
YM24	ME-NY	38			
YM24P	ME-NY.P	38			
YM27P	OP-WY.P	45			
YM28	OP-D	45			
YM28P	OP-D.P	45			
YM30BP	SAA-1.P1	51			
YM31	AF-13	1			
YT1R	YET-6D	166			
YT2	YET-11	167			
YT2R	YET-11D	167			
YT3	YET-5	166			
YT3R	YET-5D	166			
YT6	YET-2	166			
YT6R	YET-2D	166			
YT8	YET-1	166			
YT8R	YET-1D	166			
YT10	YET-9	167			
YT10R	YET-9D	167			
YT11	YET-10	167			
YT11R	YET-10D	167			
YYA6	YA-107	162			
YYA7	YA-146	162			
YYB6	YA-108	162			
YYB7	YA-147	162			
YYC6	YA-109	162			
YYC7	YA-148	162			



JMA\Headquarter

ALEJANDRO ALTUNA, S.A.
Bidekurtzeta 6, P.O.Box 70, 20500
Arrasate-Mondragon, Gipuzkoa. Spain

www.jma.es
ventas@jma.es
+34 123 456 789

JMA\France

Technoparc
13, rue Edouard Jeanneret
F- 78306 Poissy Cedex

www.jmafrance.fr
service.commercial@jmafrance.fr
+33 01 39 22 42 10

JMA\Maroc

JMA MAROC S.A.R.L.
83,85 Bd Oued ZIZ, El Oulfa
Casablanca
Marruecos

www.jma.ma
jma@jma.ma
+0520 150 535

JMA\Mexico

LLAVES ALTUNA DE MEXICO S.A de C.V
Av. Aviación No. 5520
Col. San Juan de Ocotán
C.P. 45019 Zapopan, Jalisco

www.jma.com.mx
ventas@jma.com.mx
+52 33 3777 1600

JMA\Colombia

IFAM - JMA Colombia, S.A.S.Av. Aviación
Diagonal 115A - 70B - 45 Local 1
Bogotá

www.jmacolombia.com
info@jmacolombia.com
+57 1 53333246

JMA\Perú

JMA Perú S.A.C.
Av. Los Paracas 130, Urbanización
Salamanca,
Distrito Ate, Lima

www.jma-peru.com
info@jma-peru.com
+51 639 9300

JMA\Polska

JMA POLSKA Sp. z o.o.
91-342 Łódź, ul. Zbąszczyńska 3

www.jmapolska.pl
biuro@jmapolska.pl
+48 42 635 12 80

JMA\Portugal

ALTUNA PORTUGAL
COMERCIO DE CHAVES UNIPessoal, LDA.
Urbanização dos Areeiros, Lote 67 C/v
2695-733 São Joao da Talha

www.jmaportugal.com
comercial@jmaportugal.com
+351 219 947 470

JMA\Uk

SKS LTD
Unit 2, Canalside Northbridge Road
Berkhamsted
Herts HP4 1EG

www.jmakeys.co.uk
sales@skskkeys.co.uk
+44 144 229 1400

JMA\USA

ALTUNA GROUP USA INC.
1513 Greenview Drive
75050 Grand Prairie, Texas

www.jmausa.com
ventas@jma.com.mx
+52 33 3777 1600



JMA E-training



JMA E-shop

Member of
Altuna Group



JMA[®]