

ORTHOPAEDIC TRAUMA



PLUSCAREMED
MEDICAL DEVICES



3,5 mm Clavicle Locking Compression Plate



TI	SS	Hole	Side	Length (mm)
M201 350706	M101 350706	6	Left	70
M201 350707	M101 350707	7	Left	84
M201 350708	M101 350708	8	Left	98
M201 350709	M101 350709	9	Left	112
M201 350806	M101 350806	6	Right	70
M201 350807	M101 350807	7	Right	84
M201 350808	M101 350808	8	Right	98
M201 350809	M101 350809	9	Right	112

TI	SS	Hole	Side	Length (mm)
M202 350706	M102 350706	6	Left	94
M202 350707	M102 350707	7	Left	107
M202 350708	M102 350708	8	Left	120
M202 350709	M102 350709	9	Left	133
M202 350806	M102 350806	6	Right	94
M202 350807	M102 350807	7	Right	107
M202 350808	M102 350808	8	Right	120
M202 350809	M102 350809	9	Right	133

3,5 mm Clavicle Rec. Locking Compression Plate



3,5 mm Clavicle Hook Locking Compression Plate



TI	SS	Hole	Side	Length (mm)
M203 350704	M103 350704	4	Left	63
M203 350705	M103 350705	5	Left	75
M203 350706	M103 350706	6	Left	86
M203 350707	M103 350707	7	Left	98
M203 350708	M103 350708	8	Left	112
M203 350804	M103 350804	4	Right	63
M203 350805	M103 350805	5	Right	75
M203 350806	M103 350806	6	Right	86
M203 350807	M103 350807	7	Right	98
M203 350808	M103 350808	8	Right	112

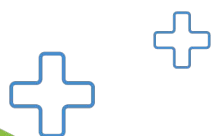

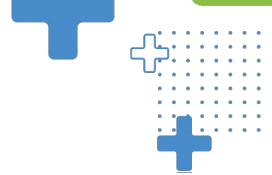

3,5 mm Distal Clavicle Locking Compression Plate



TI	SS	Hole	Side	Length (mm)
M204 350703	M104 350703	3	Left	66
M204 350704	M104 350704	4	Left	78
M204 350705	M104 350705	5	Left	90
M204 350706	M104 350706	6	Left	102
M204 350707	M104 350707	7	Left	114
M204 350708	M104 350803	8	Left	66
M204 350803	M104 350804	3	Right	78
M204 350804	M104 350805	4	Right	90
M204 350805	M104 350806	5	Right	102
M204 350806	M104 350807	6	Right	114
M204 350807	M104 350703	7	Right	66
M204 350808	M104 350704	8	Right	78

TI	SS	Hole	Length (mm)
M206 3503	M106 3503	3	61
M206 3504	M106 3504	4	73
M206 3505	M106 3505	5	85
M206 3506	M106 3506	6	97
M206 3507	M106 3507	7	109
M206 3508	M106 3508	8	121
M206 3509	M106 3509	9	133

3,5 mm Proximal Humerus Locking Compression Plate-1



3,5 mm Proximal Humerus Locking Compression Plate-2



TI	SS	Hole	Length (mm)
M207 3503	M107 3503	3	87
M207 3504	M107 3504	4	99
M207 3505	M107 3505	5	111
M207 3506	M107 3506	6	123
M207 3507	M107 3507	7	135
M207 3508	M107 3508	8	147
M207 3509	M107 3509	9	159
M207 3510	M107 3503	10	87

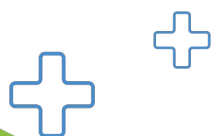

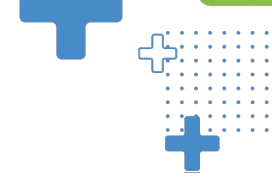

3,5 mm Proximal Humerus Locking Compression Plate-3



TI	SS	Hole	Length (mm)
M208 3503	M108 3503	3	122
M208 3504	M108 3504	4	140
M208 3505	M108 3505	5	158
M208 3506	M108 3506	6	176
M208 3507	M108 3507	7	194
M208 3508	M108 3508	8	212
M208 3509	M108 3509	9	230
M208 3510	M108 3510	10	248
M208 3512	M108 3512	12	284

TI	SS	Hole	Side	Length (mm)
M209 350703	M109 350703	3	Left	56
M209 350705	M109 350705	5	Left	84
M209 350707	M109 350707	7	Left	112
M209 350709	M109 350709	9	Left	140
M209 350711	M109 350711	11	Left	168
M209 350803	M109 350803	3	Right	56
M209 350805	M109 350805	5	Right	84
M209 350807	M109 350807	7	Right	112
M209 350809	M109 350809	9	Right	140
M209 350811	M109 350811	11	Right	168

3,5 mm Distal Lateral Humerus Locking Plate 1



3,5 mm Distal Lateral Humerus Locking Plate 2



TI	SS	Hole	Side	Length (mm)
M210 350703	M110 350703	3	Left	81
M210 350705	M110 350705	5	Left	104
M210 350707	M110 350707	7	Left	127
M210 350709	M110 350709	9	Left	150
M210 350711	M110 350711	11	Left	173
M210 350803	M110 350803	3	Right	81
M210 350805	M110 350805	5	Right	104
M210 350807	M110 350807	7	Right	127
M210 350809	M110 350809	9	Right	150
M210 350811	M110 350811	11	Right	173

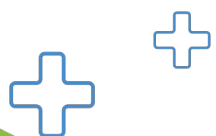



3,5 mm Midshaft Volar Radius Plates



TI	SS	Hole	Side	Length (mm)
		3	Left	69
		5	Left	78
		7	Left	87
		9	Left	96
		11	Left	105
		3	Right	69
		5	Right	78
		7	Right	87
		9	Right	96
		11	Right	105

TI	SS	Hole	Length (mm)
M211 350703	M111 350703	3	81
M211 350705	M111 350705	5	104
M211 350707	M111 350707	7	127
M211 350709	M111 350709	9	150
M211 350711	M111 350711	11	173
M211 350813	M111 350713	13	196
M211 350815	M111 350715	15	219

3,5 mm Distal Medial Humerus Locking Plate 1



3,5 mm Distal Medial Humerus Locking Plate 2



TI	SS	Hole	Side	Length (mm)
M212 350703	M112 350703	3	Left	81
M212 350705	M112 350705	5	Left	104
M212 350707	M112 350707	7	Left	127
M212 350709	M112 350709	9	Left	150
M212 350711	M112 350711	11	Left	173
M212 350803	M112 350803	3	Right	81
M212 350805	M112 350805	5	Right	104
M212 350807	M112 350807	7	Right	127
M212 350809	M112 350809	9	Right	150
M212 350811	M112 350811	11	Right	173

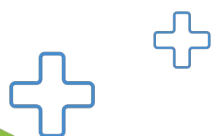



3,5 mm Y-Distal Humerus Locking Plate



TI	SS	Hole	Side	Length (mm)
M213 350703	M113 350703	3	Left	91
M213 350705	M113 350705	5	Left	106
M213 350707	M113 350707	7	Left	121
M213 350709	M113 350709	9	Left	136
M213 350711	M113 350711	11	Left	151
M213 350803	M113 350803	3	Right	91
M213 350805	M113 350805	5	Right	106
M213 350807	M113 350807	7	Right	121
M213 350809	M113 350809	9	Right	136
M213 350811	M113 350811	11	Right	151

TI	SS	Hole	Side	Length (mm)
M214 350704	M114 350704	4	Left	128
M214 350706	M114 350706	6	Left	153
M214 350708	M114 350708	8	Left	178
M214 350710	M114 350710	10	Left	203
M214 350804	M114 350804	4	Right	128
M214 350806	M114 350806	6	Right	153
M214 350808	M114 350808	8	Right	178
M214 350810	M114 350810	10	Right	203

3,5 mm Olecranon Locking Compression Plate 1



3,5 mm Olecranon Locking Compression Plate 2



TI	SS	Hole	Length (mm)
M215 3503	M115 3503	3	67
M215 3504	M115 3504	4	79
M215 3505	M115 3505	5	91
M215 3506	M115 3506	6	103
M215 3507	M115 3507	7	115
M215 3508	M115 3508	8	127

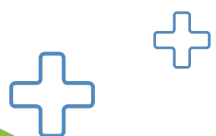



3,5 mm Metaphysis Locking Compression Plate



TI	SS	Hole	Length (mm)
M216 3506	M116 3506	6	86
M216 3507	M116 3507	7	99
M216 3508	M116 3508	8	112
M216 3509	M116 3509	9	125
M216 3510	M116 3510	10	138
M216 3511	M116 3511	11	151
M216 3512	M116 3512	12	164
M216 3513	M116 3513	13	177

TI	SS	Hole	Length (mm)
M217 3505	M117 3505	5	64
M217 3506	M117 3506	6	73
M217 3507	M117 3507	7	82
M217 3508	M117 3508	8	91
M217 3509	M117 3509	9	100
M217 3510	M117 3510	10	109
M217 3511	M117 3511	11	118
M217 3512	M117 3512	12	127

3,5 mm Locking Compression Hook Plate



3,5 mm Locking Compression Plate



TI	SS	Hole	Length (mm)
M218 3504	M118 3504	4	58
M218 3505	M118 3505	5	72
M218 3506	M118 3506	6	86
M218 3507	M118 3507	7	100
M218 3508	M118 3508	8	114
M218 3509	M118 3509	9	128
M218 3510	M118 3510	10	142
M218 3511	M118 3511	11	156
M218 3512	M118 3512	12	170

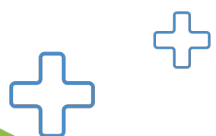



1/3 Tubular Locking Plate

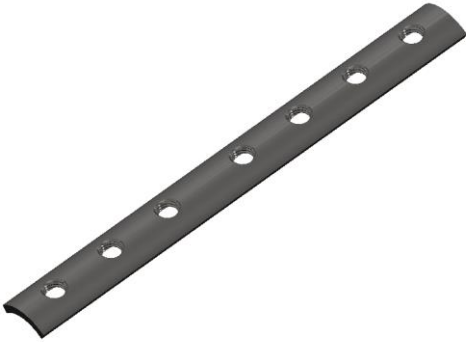

TI	SS	Hole	Length (mm)
M219 3504	M119 3504	4	54
M219 3505	M119 3505	5	66
M219 3506	M119 3506	6	78
M219 3507	M119 3507	7	90
M219 3508	M119 3508	8	102
M219 3509	M119 3509	9	114
M219 3510	M119 3510	10	126
M219 3511	M119 3511	11	138
M219 3512	M119 3512	12	150
M219 3513	M119 3513	13	162

TI	SS	Hole	Length (mm)
M220 3504	M120 3504	4	48
M220 3505	M120 3505	5	60
M220 3506	M120 3506	6	72
M220 3507	M120 3507	7	84
M220 3508	M120 3508	8	96
M220 3509	M120 3509	9	108
M220 3510	M120 3510	10	120
M220 3511	M120 3511	11	132
M220 3512	M120 3512	12	144
M220 3513	M120 3513	13	156

3,5 mm Reconstruction Locking Plate

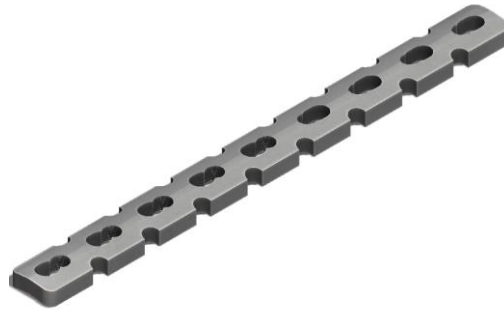

3,5 mm Ulna/Radius Anatomic Locking Plate



TI	SS	Hole	Side	Length (mm)
M221 3506	M121 3506	6		69
M221 3507	M121 3507	7		82
M221 3508	M121 3508	8		95
M221 3509	M121 3509	9		108
M221 3510	M121 3510	10		121

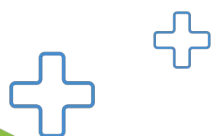



3,5 mm Curved Reconstruction Locking Plate



TI	SS	Hole	Length (mm)
M222 3504	M122 3504	4	61
M222 3505	M122 3505	5	77
M222 3506	M122 3506	6	93
M222 3507	M122 3507	7	109
M222 3508	M122 3508	8	125
M222 3509	M122 3509	9	141
M222 3510	M122 3510	10	157
M222 3512	M122 3512	12	189
M222 3514	M122 3514	14	221
M222 3516	M122 3516	16	253
M222 3518	M122 3518	18	285

TI	SS	Hole	Side	Length (mm)
M223 350702	M123 350702	2	Left	54
M223 350703	M123 350703	3	Left	62
M223 350704	M123 350704	4	Left	70
M223 350705	M123 350705	5	Left	78
M223 350706	M123 350706	6	Left	86
M223 350802	M123 350802	2	Right	54
M223 350803	M123 350803	3	Right	62
M223 350804	M123 350804	4	Right	70
M223 350805	M123 350805	5	Right	78
M223 350806	M123 350806	6	Right	86

2,7/3,5 mm Distal Radius Locking Plate 1



2,7/3,5 mm Distal Radius Locking Plate 2



TI	SS	Hole	Side	Length (mm)
M224 350702	M124 350702	2	Left	63
M224 350703	M124 350703	3	Left	71
M224 350704	M124 350704	4	Left	79
M224 350705	M124 350705	5	Left	87
M224 350706	M124 350706	6	Left	95
M224 350707	M124 350707	7	Left	103
M224 350802	M124 350802	2	Right	63
M224 350803	M124 350803	3	Right	71
M224 350804	M124 350804	4	Right	79
M224 350805	M124 350805	5	Right	87
M224 350806	M124 350806	6	Right	95
M224 350807	M124 350807	7	Right	103

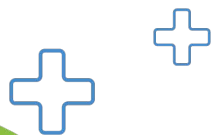



3,5 mm Locking Compression T-Plate, (Head 4 hole)



TI	SS	Hole	Length (mm)
M225 3503	M125 3503	3	45
M225 3504	M125 3504	4	61
M225 3505	M125 3505	5	77
M225 3506	M125 3506	6	93

TI	SS	Hole	Length (mm)
M226 3503	M126 3503	3	45
M226 3504	M126 3504	4	61
M226 3505	M126 3505	5	77
M226 3506	M126 3506	6	93

3,5 mm Locking Compression T-Plate,(Head 3 hole)



3,5 mm Locking Compression T-Plate Oblique-Angled



TI	SS	Hole	Side	Length (mm)
M227 350703	M127 350703	3	Left	53
M227 350704	M127 350704	4	Left	66
M227 350705	M127 350705	5	Left	79
M227 350706	M127 350706	6	Left	92
M227 350707	M127 350707	7	Left	105
M227 350803	M127 350803	3	Right	53
M227 350804	M127 350804	4	Right	66
M227 350805	M127 350805	5	Right	79
M227 350806	M127 350806	6	Right	92
M227 350807	M127 350807	7	Right	105

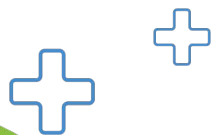

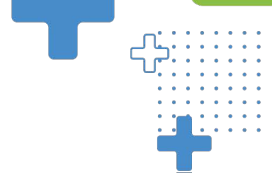

2,7 mm Radius Head Locking Plate



TI	SS	Hole	Length (mm)
M228 2703	M128 2703	3	31
M228 2704	M128 2704	4	39
M228 2705	M128 2705	5	47

TI	SS	Hole	Side	Length (mm)
M229 270703	M129 270703	2	Left 90°	33
M229 270704	M129 270704	3	Left 90°	35
M229 270705	M129 270705	4	Left 90°	37
M229 270803	M129 270803	2	Right 90°	33
M229 270804	M129 270804	3	Right 90°	35
M229 270805	M129 270805	4	Right 90°	37
M229 270703	M129 270703	2	Left 110°	33
M229 270704	M129 270704	3	Left 110°	35
M229 270705	M129 270705	4	Left 110°	37
M229 270803	M129 270803	2	Right 110°	33
M229 270804	M129 270804	3	Right 110°	35
M229 270805	M129 270805	4	Right 110°	37

2,7 mm Hallux-Valgus Locking Plate



4,5/5,0 mm Proximal Femur Locking Compression Plate 1



TI	SS	Hole	Side	Length (mm)
M250 450703	M150 450703	3	Left	91
M250 450705	M150 450705	5	Left	127
M250 450707	M150 450707	7	Left	163
M250 450709	M150 450709	9	Left	199
M250 450711	M150 450711	11	Left	235
M250 450713	M150 450713	13	Left	271
M250 450803	M150 450803	3	Right	91
M250 450805	M150 450805	5	Right	127
M250 450807	M150 450807	7	Right	163
M250 450809	M150 450809	9	Right	199
M250 450811	M150 450811	11	Right	235
M250 450813	M150 450813	13	Right	271

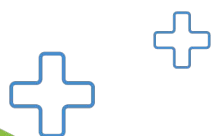



4,5/5,0 mm Proximal Femur Locking Compression Plate 2



TI	SS	Hole	Side	Length (mm)
M251 450702	M151 450702	2	Left	119
M251 450704	M151 450704	4	Left	159
M251 450706	M151 450706	6	Left	199
M251 450708	M151 450708	8	Left	239
M251 450710	M151 450710	10	Left	279
M251 450712	M151 450712	12	Left	319
M251 450802	M151 450802	2	Right	119
M251 450804	M151 450804	4	Right	159
M251 450806	M151 450806	6	Right	199
M251 450808	M151 450808	8	Right	239
M251 450810	M151 450810	10	Right	279
M251 450812	M151 450812	12	Right	319

TI	SS	Hole	Side	Length (mm)
M252 450705	M152 450705	5	Left	146
M252 450707	M152 450707	7	Left	196
M252 450709	M152 450709	9	Left	246
M252 450711	M152 450711	11	Left	296
M252 450713	M152 450713	13	Left	346
M252 450715	M152 450715	15	Left	396
M252 450805	M152 450805	5	Right	146
M252 450807	M152 450807	7	Right	196
M252 450809	M152 450809	9	Right	246
M252 450811	M152 450811	11	Right	296
M252 450813	M152 450813	13	Right	346
M252 450815	M152 450815	15	Right	396

4,5/5,0 mm Distal Lateral Femur Locking Plate 1

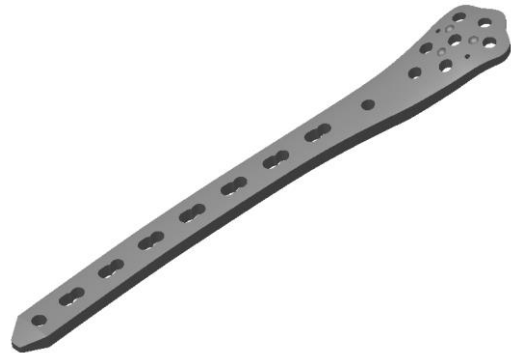

TI	SS	Hole	Length (mm)
M253 4508	M153 4508	8	178
M253 4509	M153 4509	9	195
M253 4510	M153 4510	10	212
M253 4511	M153 4511	11	229
M253 4512	M153 4512	12	246
M253 4513	M153 4513	13	263
M253 4514	M153 4514	14	280
M253 4515	M153 4515	15	297
M253 4516	M153 4516	16	314
M253 4517	M153 4517	17	331
M253 4518	M153 4518	18	348

4,5/5,0 mm Locking Plate Broad Curved

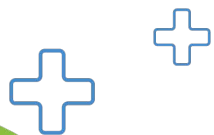



4,5/5,0 mm Distal Lateral Femur Locking Plate 2



TI	SS	Hole	Side	Length (mm)
M254 450706	M154 450706	6	Left	158
M254 450707	M154 450707	7	Left	174
M254 450708	M154 450708	8	Left	190
M254 450709	M154 450709	9	Left	206
M254 450710	M154 450710	10	Left	222
M254 450711	M154 450711	11	Left	238
M254 450806	M154 450806	6	Right	158
M254 450807	M154 450807	7	Right	174
M254 450808	M154 450808	8	Right	190
M254 450809	M154 450809	9	Right	206
M254 450810	M154 450810	10	Right	222
M254 450811	M154 450811	11	Right	238

TI	SS	Hole	Side	Length (mm)
M255 450704	M155 450704	4	Left	115
M255 450706	M155 450706	6	Left	147
M255 450708	M155 450708	8	Left	179
M255 450710	M155 450710	10	Left	211
M255 450804	M155 450804	4	Right	115
M255 450806	M155 450806	6	Right	147
M255 450808	M155 450808	8	Right	179
M255 450810	M155 450810	10	Right	211

4,5/5,0 mm Distal Medial Femur Locking Plate

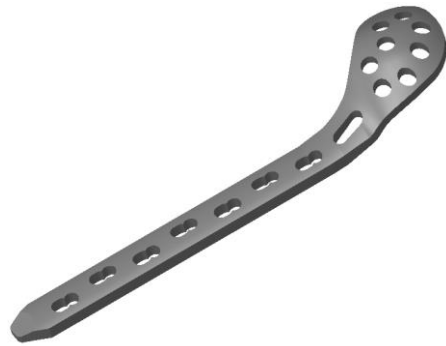

TI	SS	Hole	Side	Length (mm)
M256 450704	M156 450704	4	Left	117
M256 450706	M156 450706	6	Left	149
M256 450708	M156 450708	8	Left	181
M256 450710	M156 450710	10	Left	213
M256 450712	M156 450712	12	Left	245
M256 450804	M156 450804	4	Right	117
M256 450806	M156 450806	6	Right	149
M256 450808	M156 450808	8	Right	181
M256 450810	M156 450810	10	Right	213
M256 450812	M156 450812	12	Right	245

4,5/5,0 mm Condylar Femur Locking Plate

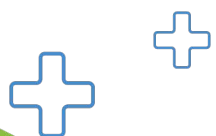

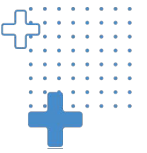

4,5/5,0 mm Proximal Lateral Tibia Locking Plate 1



TI	SS	Hole	Side	Length (mm)
M257 450703	M157 450703	3	Left	103
M257 450705	M157 450705	5	Left	143
M257 450707	M157 450707	7	Left	183
M257 450709	M157 450709	9	Left	223
M257 450711	M157 450711	11	Left	263
M257 450713	M157 450713	13	Left	303
M257 450715	M157 450715	15	Left	343
M257 450803	M157 450803	3	Right	103
M257 450805	M157 450805	5	Right	143
M257 450807	M157 450807	7	Right	183
M257 450809	M157 450809	9	Right	223
M257 450811	M157 450811	11	Right	263
M257 450813	M157 450813	13	Right	303
M257 450815	M157 450815	15	Right	343

TI	SS	Hole	Side	Length (mm)
M258 450705	M158 450705	5	Left	102
M258 450707	M158 450707	7	Left	138
M258 450709	M158 450709	9	Left	174
M258 450711	M158 450711	11	Left	210
M258 450713	M158 450713	13	Left	246
M258 450805	M158 450805	5	Right	102
M258 450807	M158 450807	7	Right	138
M258 450809	M158 450809	9	Right	174
M258 450811	M158 450811	11	Right	210
M258 450813	M158 450813	13	Right	246

4,5/5,0 mm Proximal Lateral Tibia Locking Plate 2



4,5/5,0 mm Proximal Medial Tibia Locking Plate



TI	SS	Hole	Side	Length (mm)
M259 450705	M159 450705	5	Left	122
M259 450707	M159 450707	7	Left	154
M259 450709	M159 450709	9	Left	186
M259 450711	M159 450711	11	Left	218
M259 450713	M159 450713	13	Left	250
M259 450805	M159 450805	5	Right	122
M259 450807	M159 450807	7	Right	154
M259 450809	M159 450809	9	Right	186
M259 450811	M159 450811	11	Right	218
M259 450813	M159 450813	13	Right	250

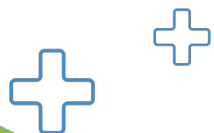



4,5/5,0 mm Locking Compression L-Plate



TI	SS	Hole	Side	Length (mm)
M260 450703	M160 450703	3	Left	65
M260 450704	M160 450704	4	Left	81
M260 450705	M160 450705	5	Left	97
M260 450706	M160 450706	6	Left	113
M260 450707	M160 450707	7	Left	129
M260 450708	M160 450708	8	Left	145
M260 450803	M160 450803	3	Right	65
M260 450804	M160 450804	4	Right	81
M260 450805	M160 450805	5	Right	97
M260 450806	M160 450806	6	Right	113
M260 450807	M160 450807	7	Right	129
M260 450808	M160 450808	8	Right	145

TI	SS	Hole	Length (mm)
M261 4503	M161 4503	3	65
M261 4504	M161 4504	4	81
M261 4505	M161 4505	5	97
M261 4506	M161 4506	6	113
M261 4507	M161 4507	7	129
M261 4508	M161 4508	8	145
M261 4509	M161 4509	9	161
M261 4510	M161 4510	10	177
M261 4511	M161 4511	11	193
M261 4512	M161 4512	12	209

4,5/5,0 mm Locking Compression T-Plate



3,5/4,5/5,0 mm Metaphysis Locking Compression Plate



TI	SS	Hole	Length (mm)
M262 4503	M162 4503	3	118
M262 4504	M162 4504	4	136
M262 4505	M162 4505	5	154
M262 4506	M162 4506	6	172
M262 4507	M162 4507	7	190
M262 4508	M162 4508	8	208
M262 4509	M162 4509	9	226
M262 4510	M162 4510	10	244
M262 4511	M162 4511	11	262

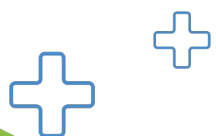



4,5/5,0 mm Narrow Locking Compression Plate



TI	SS	Hole	Length (mm)
M263 4505	M163 4505	5	110
M263 4506	M163 4506	6	128
M263 4507	M163 4507	7	146
M263 4508	M163 4508	8	164
M263 4509	M163 4509	9	182
M263 4510	M163 4510	10	200
M263 4511	M163 4511	11	218
M263 4512	M163 4512	12	236
M263 4513	M163 4513	13	254
M263 4514	M163 4514	14	272
M263 4515	M163 4515	15	290
M263 4516	M163 4516	16	308

TI	SS	Hole	Length (mm)
M263 4505	M163 4505	5	110
M263 4506	M163 4506	6	128
M263 4507	M163 4507	7	146
M263 4508	M163 4508	8	164
M263 4509	M163 4509	9	182
M263 4510	M163 4510	10	200
M263 4511	M163 4511	11	218
M263 4512	M163 4512	12	236
M263 4513	M163 4513	13	254
M263 4514	M163 4514	14	272
M263 4515	M163 4515	15	290
M263 4516	M163 4516	16	308

4,5/5,0 mm Broad Locking Compression Plate



4,5/5,0 mm Distal Tibia Antorateral Locking Plate 1



TI	SS	Hole	Side	Length (mm)
M264 450705	M164 450705	5	Left	100
M264 450707	M164 450707	7	Left	140
M264 450709	M164 450709	9	Left	180
M264 450711	M164 450711	11	Left	220
M264 450713	M164 450713	13	Left	260
M264 450715	M164 450715	15	Left	300
M264 450805	M164 450805	5	Right	100
M264 450807	M164 450807	7	Right	140
M264 450809	M164 450809	9	Right	180
M264 450811	M164 450811	11	Right	220
M264 450813	M164 450813	13	Right	260
M264 450815	M164 450815	15	Right	300

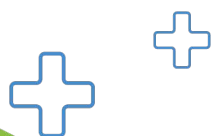

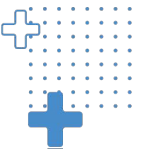

3,5/4,0mm Distal Tibia Antorateral Locking Plate 2

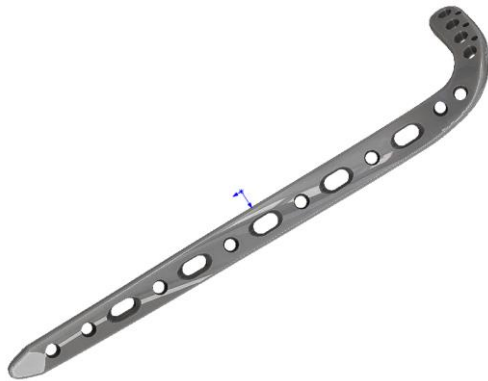

TI	SS	Hole	Side	Length (mm)
M265 350705	M165 350705	5	Left	90
M265 350707	M165 350707	7	Left	120
M265 350709	M165 350709	9	Left	150
M265 350711	M165 350711	11	Left	180
M265 350713	M165 350713	13	Left	210
M265 350715	M165 350715	15	Left	240
M265 350717	M165 350717	17	Left	270
M265 350805	M165 350805	5	Right	90
M265 350807	M165 350807	7	Right	120
M265 350809	M165 350809	9	Right	150
M265 350811	M165 350811	11	Right	180
M265 350813	M165 350813	13	Right	210
M265 350815	M165 350815	15	Right	240
M265 350817	M165 350817	17	Right	270

TI	SS	Hole	Side	Length (mm)
M266 350704	M166 350704	4	Left	116
M266 350706	M166 350706	6	Left	142
M266 350708	M166 350709	8	Left	168
M266 350710	M166 350711	10	Left	194
M266 350712	M166 350713	12	Left	220
M266 350714	M166 350715	14	Left	246
M266 350804	M166 350804	4	Right	116
M266 350806	M166 350806	6	Right	142
M266 350808	M166 350808	8	Right	168
M266 350810	M166 350810	10	Right	194
M266 350812	M166 350812	12	Right	220
M266 350814	M166 350814	14	Right	246

3,5/4,0mm Distal Medial Tibia Locking Plate 1



3,5/4,0mm Distal Medial Tibia Locking Plate 2



TI	SS	Hole	Side	Length (mm)
M267 350704	M167 350704	4	Left	113
M267 350706	M167 350706	6	Left	137
M267 350708	M167 350709	8	Left	161
M267 350710	M167 350711	10	Left	185
M267 350712	M167 350713	12	Left	209
M267 350714	M167 350715	14	Left	233
M267 350804	M167 350804	4	Right	113
M267 350806	M167 350806	6	Right	137
M267 350808	M167 350808	8	Right	161
M267 350810	M167 350810	10	Right	185
M267 350812	M167 350812	12	Right	209
M267 350814	M167 350814	14	Right	233

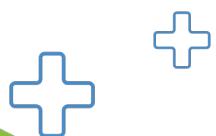

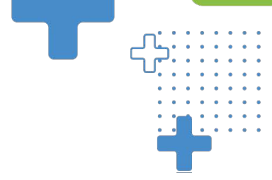

3,5/4,0 mm Distal Tibia Locking Pilon Plate



TI	SS	Hole	Length (mm)
M268 3516	M168 3516	16	111
M268 3518	M168 3518	18	142
M268 3520	M168 3520	20	173
M268 3522	M168 3522	22	204
M268 3524	M168 3524	24	235
M268 3526	M168 3526	26	266
M268 3528	M168 3528	28	297

TI	SS	Hole	Side	Length (mm)
M269 350702	M170 350702	2	Left	63
M269 350703	M170 350703	3	Left	75
M269 350704	M170 350704	4	Left	87
M269 350705	M170 350705	5	Left	99
M269 350706	M170 350706	6	Left	111
M269 350707	M170 350707	7	Left	123
M269 350708	M170 350708	8	Left	135
M269 350709	M170 350709	9	Left	147
M269 350710	M170 350710	10	Left	159
M269 350711	M170 350711	11	Left	171
M269 350712	M170 350712	12	Left	183
M269 350802	M170 350802	2	Right	63
M269 350803	M170 350803	3	Right	75
M269 350804	M170 350804	4	Right	87
M269 350805	M170 350805	5	Right	99
M269 350806	M170 350806	6	Right	111
M269 350807	M170 350807	7	Right	123
M269 350808	M170 350808	8	Right	135
M269 350809	M170 350809	9	Right	147
M269 350810	M170 350810	10	Right	159
M269 350811	M170 350811	11	Right	171
M269 350812	M170 350812	12	Right	183

2,7/3,5 mm Distal Fibula Locking Plate 1

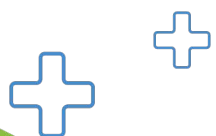
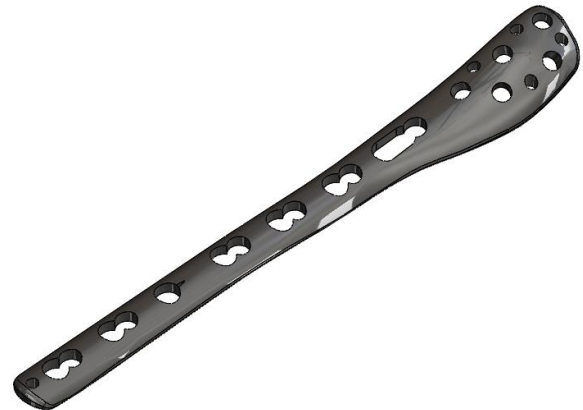



2,7/3,5 mm Distal Fibula Locking Plate 2



TI	SS	Hole	Side	Length (mm)
M270 350702	M170 350702	2	Left	63
M270 350703	M170 350703	3	Left	75
M270 350704	M170 350704	4	Left	87
M270 350705	M170 350705	5	Left	99
M270 350706	M170 350706	6	Left	111
M270 350707	M170 350707	7	Left	123
M270 350708	M170 350708	8	Left	135
M270 350709	M170 350709	9	Left	147
M270 350710	M170 350710	10	Left	159
M270 350711	M170 350711	11	Left	171
M270 350712	M170 350712	12	Left	183
M270 350802	M170 350802	2	Right	63
M270 350803	M170 350803	3	Right	75
M270 350804	M170 350804	4	Right	87
M270 350805	M170 350805	5	Right	99
M270 350806	M170 350806	6	Right	111
M270 350807	M170 350807	7	Right	123
M270 350808	M170 350808	8	Right	135
M270 350809	M170 350809	9	Right	147
M270 350810	M170 350810	10	Right	159
M270 350811	M170 350811	11	Right	171
M270 350812	M170 350812	12	Right	183

TI	SS	Hole	Length (mm)
M271 4506	M171 4506	6	102
M271 4508	M171 4508	8	134
M271 4510	M171 4510	10	166
M271 4512	M171 4512	12	198
M271 4514	M171 4514	14	230
M271 4516	M171 4516	16	262
M271 4518	M171 4518	18	294
M271 4520	M171 4520	20	326
M271 4522	M171 4522	22	358
M271 4524	M171 4524	24	390

4,0/4,5/5,0 mm Reconstruction Locking Compression Plate

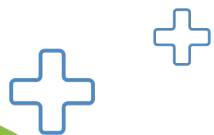

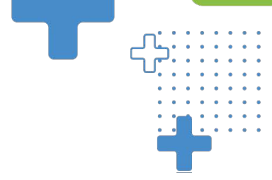

4,0/4,5/5,0 mm Curved Reconstruction Locking Plate

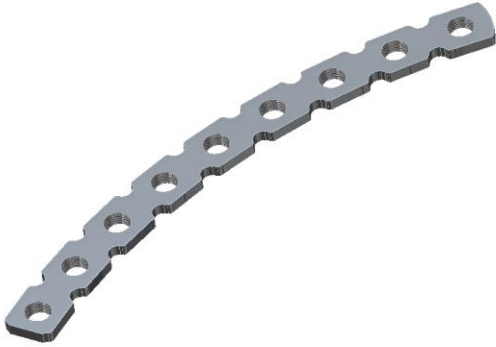

TI	SS	Hole	Length (mm)
M272 4506	M172 4506	6	94
M272 4508	M172 4508	8	125
M272 4510	M172 4510	10	156
M272 4512	M172 4512	12	187
M272 4514	M172 4514	14	218
M272 4516	M172 4516	16	249
M272 4518	M172 4518	18	280
M272 4520	M172 4520	20	311
M272 4522	M172 4522	22	342
M272 4524	M172 4524	24	373

TI	SS	Hole	Side	Length (mm)
M273 3514	M173 35 14	14	Left	62
M273 3614	M173 36 14	14	Right	62

3,5 mm Calcaneal Locking Plate 1



3,5 mm Calcaneal Locking Plate 2



TI	SS	Hole	Side	Length (mm)
M274 37 12	M174 37 12	12	Left	60
M274 38 12	M174 38 12	12	Right	60

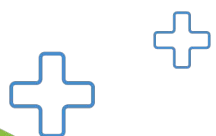

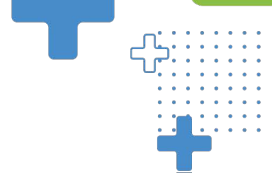

3,5 mm Calcaneal Locking Plate 3



TI	SS	Hole	Side	Length (mm)
M275 39 08	M175 39 08	8	Left	45
M275 40 08	M175 40 08	8	Right	45

TI	SS	Hole	Side	Length (mm)
M276 40 08	M176 40 08	8	Left	65
M276 41 08	M176 41 08	8	Right	65

3,5 mm Calcaneal Locking Plate 4



TI	SS	Hole	Side	Length (mm)
M277 42 12	M177 42 12	12	Left	59
M277 43 13	M177 43 13	12	Right	59

3,5 mm Calcaneal Locking Plate 5



TI	SS	Hole	Side	Length (mm)
M276 40 08	M176 40 08	8	Left	65
M276 41 08	M176 41 08	8	Right	65

3,5 mm Calcaneal Locking Plate 6

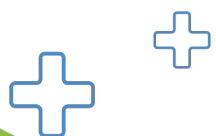

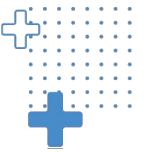

3,5 mm Self-Tapping Locking Screw

TI	SS	Length	TI	SS	Length
M1963510	M1863510	3,5*10	M1963530	M1863530	3,5*30
M1963512	M1863512	3,5*12	M1963535	M1863535	3,5*35
M1963514	M1863514	3,5*14	M1963540	M1863540	3,5*40
M1963516	M1863516	3,5*16	M1963545	M1863545	3,5*45
M1963518	M1863518	3,5*18	M1963550	M1863550	3,5*50
M1963520	M1863520	3,5*20	M1963555	M1863555	3,5*55
M1963522	M1863522	3,5*22	M1963560	M1863560	3,5*60
M1963524	M1863524	3,5*24	M1963565	M1863565	3,5*65
M1963526	M1863526	3,5*26	M1963570	M1863570	3,5*70
M1963528	M1863528	3,5*28			

TI	SS	Length
M21863510	M21963510	3,5*10
M21863512	M21963512	3,5*12
M21863514	M21963514	3,5*14
M21863516	M21963516	3,5*16
M21863518	M21963518	3,5*18
M21863520	M21963520	3,5*20
M21863522	M21963522	3,5*22
M21863524	M21963524	3,5*24
M21863526	M21963526	3,5*26
M21863528	M21963528	3,5*28

TI	SS	Length
M21863530	M21963530	3,5*30
M21863535	M21963535	3,5*35
M21863540	M21963540	3,5*40
M21863545	M21963545	3,5*45
M21863550	M21963550	3,5*50
M21863555	M21963555	3,5*55
M21863560	M21963560	3,5*60
M21863565	M21963565	3,5*65
M21863570	M21963570	3,5*70

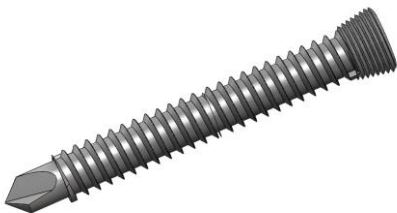
3,5 mm Low-Profile Locking Screw

3,5 mm Self-Drilling Locking Screw

TI	SS	Length
M5863510	M5963510	3,5*10
M5863512	M5963512	3,5*12
M5863514	M5963514	3,5*14
M5863516	M5963516	3,5*16
M5863518	M5963518	3,5*18
M5863520	M5963520	3,5*20
M5863522	M5963522	3,5*22
M5863524	M5963524	3,5*24
M5863526	M5963526	3,5*26
M5863528	M5963528	3,5*28

TI	SS	Length
M5863530	M5963530	3,5*30
M5863535	M5963535	3,5*35
M5863540	M5963540	3,5*40
M5863545	M5963545	3,5*45
M5863550	M5963550	3,5*50
M5863555	M5963555	3,5*55
M5863560	M5963560	3,5*60
M5863565	M5963565	3,5*65
M5863570	M5963570	3,5*70

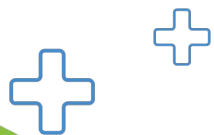

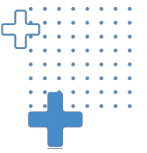

3,5 mm Locking Cancellous Screw Full Threaded

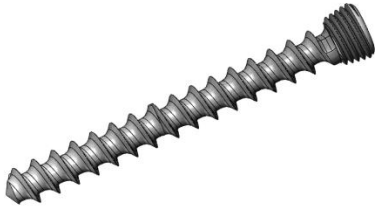

TI	SS	Length
M300 1863510	M300 1963510	3,5*10
M300 1863512	M300 1963512	3,5*12
M300 1863514	M300 1963514	3,5*14
M300 1863516	M300 1963516	3,5*16
M300 1863518	M300 1963518	3,5*18
M300 1863520	M300 1963520	3,5*20
M300 1863522	M300 1963522	3,5*22
M300 1863524	M300 1963524	3,5*24
M300 1863526	M300 1963526	3,5*26
M300 1863528	M300 1963528	3,5*28
M300 1863530	M300 1963530	3,5*30

TI	SS	Length
M300 1863535	M300 1963535	3,5*35
M300 1863540	M300 1963540	3,5*40
M300 1863545	M300 1963545	3,5*45
M300 1863550	M300 1963550	3,5*50
M300 1863555	M300 1963555	3,5*55
M300 1863560	M300 1963560	3,5*60
M300 1863565	M300 1963565	3,5*65
M300 1863570	M300 1963570	3,5*70
M300 1863575	M300 1963575	3,5*75
M300 1863580	M300 1963580	3,5*80

TI	SS	Length
M316 1863520	M316 1963520	3,5*20
M316 1863522	M316 1963522	3,5*22
M316 1863524	M316 1963524	3,5*24
M316 1863526	M316 1963526	3,5*26
M316 1863528	M316 1963528	3,5*28
M316 1863530	M316 1963530	3,5*30
M316 1863535	M316 1963535	3,5*35
M316 1863540	M316 1963540	3,5*40

TI	SS	Length
M316 1863545	M316 1963545	3,5*45
M316 1863550	M316 1963550	3,5*50
M316 1863555	M316 1963555	3,5*55
M316 1863560	M316 1963560	3,5*60
M316 1863565	M316 1963565	3,5*65
M316 1863570	M316 1963570	3,5*70
M316 1863575	M316 1963575	3,5*75
M316 1863580	M316 1963580	3,5*80

3,5 mm Locking Cancellous Screw Partially Threaded



2,4 mm (6 mm)Self-Tapping Locking Screw

TI	SS	Length
M1862410	M1962410	3,5*10
M1862412	M1962412	3,5*12
M1862414	M1962414	3,5*14
M1862416	M1962416	3,5*16
M1862418	M1962418	3,5*18
M1862420	M1962420	3,5*20
M1862422	M1962422	3,5*22
M1862424	M1962424	3,5*24

TI	SS	Length
M1862426	M1962426	3,5*26
M1862428	M1962428	3,5*28
M1862430	M1962430	3,5*30
M1862435	M1962435	3,5*35
M1862440	M1962440	3,5*40
M1862445	M1962445	3,5*45
M1862450	M1962450	3,5*50

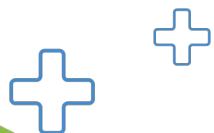



2,7 mm (6 mm)Self-Tapping Locking Screw



TI	SS	Length	TI	SS	Length
M1862710	M1962710	3,5*10	M1862726	M1962726	3,5*26
M1862712	M1962712	3,5*12	M1862728	M1962728	3,5*28
M1862714	M1962714	3,5*14	M1862730	M1962730	3,5*30
M1862716	M1962716	3,5*16	M1862735	M1962735	3,5*35
M1862718	M1962718	3,5*18	M1862740	M1962740	3,5*40
M1862720	M1962720	3,5*20	M1862745	M1962745	3,5*45
M1862722	M1962722	3,5*22	M1862750	M1962750	3,5*50
M1862724	M1962724	3,5*24			

TI	SS	Length
M1832410	M1932410	3,5*10
M1832412	M1932412	3,5*12
M1832414	M1932414	3,5*14
M1832416	M1932416	3,5*16
M1832418	M1932418	3,5*18
M1832420	M1932420	3,5*20
M1832422	M1932422	3,5*22
M1832424	M1932424	3,5*24

TI	SS	Length
M1832426	M1932426	3,5*26
M1832428	M1932428	3,5*28
M1832430	M1932430	3,5*30
M1832435	M1932435	3,5*35
M1832440	M1932440	3,5*40
M1832445	M1932445	3,5*45
M1832450	M1932450	3,5*50

2,4 mm (3,5 mm)Self-Tapping Locking Screw

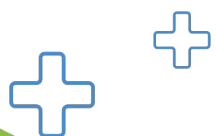

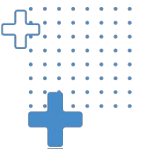

2,7 mm (3,5 mm)Self-Tapping Locking Screw



TI	SS	Length	TI	SS	Length
M1832706	M1932706	3,5*6	M1832724	M1932724	3,5*24
M1832708	M1932708	3,5*8	M1832726	M1932726	3,5*26
M1832710	M1932710	3,5*10	M1832728	M1932728	3,5*28
M1832712	M1932712	3,5*12	M1832730	M1932730	3,5*30
M1832714	M1932714	3,5*14	M1832735	M1932735	3,5*35
M1832716	M1932716	3,5*16	M1832740	M1932740	3,5*40
M1832718	M1932718	3,5*18	M1832745	M1932745	3,5*45
M1832720	M1932720	3,5*20	M1832750	M1932750	3,5*50
M1832722	M1932722	3,5*22			

TI	SS	Length	TI	SS	Length
M1822006	M1922006	3,5*6	M1822020	M1922020	3,5*20
M1822008	M1922008	3,5*8	M1822022	M1922022	3,5*22
M1822010	M1922010	3,5*10	M1822024	M1922024	3,5*24
M1822012	M1922012	3,5*12	M1822026	M1922026	3,5*26
M1822014	M1922014	3,5*14	M1822028	M1922028	3,5*28
M1822016	M1922016	3,5*16	M1822030	M1922030	3,5*30
M1822018	M1922018	3,5*18			

2,0 mm (3,0 mm)Self-Tapping Locking Screw



1,5 mm (3,0 mm)Self-Tapping Locking Screw



TI	SS	Length
M1821506	M1921506	3,5*6
M1821508	M1921508	3,5*8
M1821510	M1921510	3,5*10
M1821512	M1921512	3,5*12
M1821514	M1921514	3,5*14
M1821516	M1921516	3,5*16
M1821518	M1921518	3,5*18
M1821520	M1921520	3,5*20

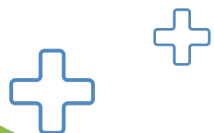



3,5 mm Self-Tapping Cannulated Locking Screw

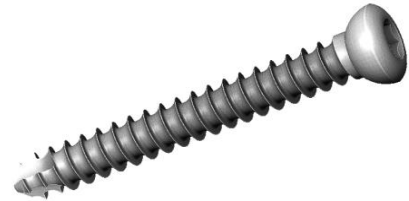
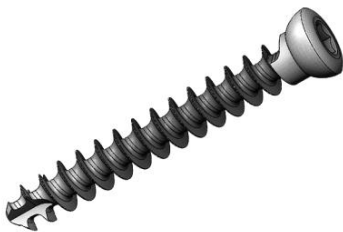

TI	SS	Length	TI	SS	Length
M4863510	M4963510	3,5*10	M4863530	M4963530	3,5*30
M4863512	M4963512	3,5*12	M4863535	M4963535	3,5*35
M4863514	M4963514	3,5*14	M4863540	M4963540	3,5*40
M4863516	M4963516	3,5*16	M4863545	M4963545	3,5*45
M4863518	M4963518	3,5*18	M4863550	M4963550	3,5*50
M4863520	M4963520	3,5*20	M4863555	M4963555	3,5*55
M4863522	M4963522	3,5*22	M4863560	M4963560	3,5*60
M4863524	M4963524	3,5*24	M4863565	M4963565	3,5*65
M4863526	M4963526	3,5*26	M4863570	M4963570	3,5*70
M4863528	M4963528	3,5*28			

TI	SS	Length	TI	SS	Length
M7863510	M7963510	3,5*10	M7863530	M7963530	3,5*30
M7863512	M7963512	3,5*12	M7863535	M7963535	3,5*35
M7863514	M7963514	3,5*14	M7863540	M7963540	3,5*40
M7863516	M7963516	3,5*16	M7863545	M7963545	3,5*45
M7863518	M7963518	3,5*18	M7863550	M7963550	3,5*50
M7863520	M7963520	3,5*20	M7863555	M7963555	3,5*55
M7863522	M7963522	3,5*22	M7863560	M7963560	3,5*60
M7863524	M7963524	3,5*24	M7863565	M7963565	3,5*65
M7863526	M7963526	3,5*26	M7863570	M7963570	3,5*70
M7863528	M7963528	3,5*28			

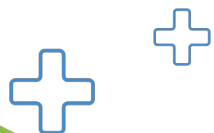
3,5 mm Cortical Screw (Pitch 1,25)mm

3,5 mm Cancellous Bone Screw Full Threaded

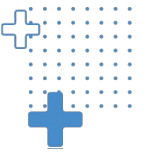
TI	SS	Length	TI	SS	Length
M300 7863510	M300 7963510	3,5*10	M300 7863530	M300 7963530	3,5*30
M300 7863512	M300 7963512	3,5*12	M300 7863535	M300 7963535	3,5*35
M300 7863514	M300 7963514	3,5*14	M300 7863540	M300 7963540	3,5*40
M300 7863516	M300 7963516	3,5*16	M300 7863545	M300 7963545	3,5*45
M300 7863518	M300 7963518	3,5*18	M300 7863550	M300 7963550	3,5*50
M300 7863520	M300 7963520	3,5*20	M300 7863555	M300 7963555	3,5*55
M300 7863522	M300 7963522	3,5*22	M300 7863560	M300 7963560	3,5*60
M300 7863524	M300 7963524	3,5*24	M300 7863565	M300 7963565	3,5*65
M300 7863526	M300 7963526	3,5*26	M300 7863570	M300 7963570	3,5*70
M300 7863528	M300 7963528	3,5*28			





3,5 mm Cancellous Bone Screw Partially Threaded

TI	SS	Length
M316 7863520	M316 7963520	3,5*20
M316 7863522	M316 7963522	3,5*22
M316 7863524	M316 7963524	3,5*24
M316 7863526	M316 7963526	3,5*26
M316 7863528	M316 7963528	3,5*28
M316 7863530	M316 7963530	3,5*30
M316 7863535	M316 7963535	3,5*35
M316 7863540	M316 7963540	3,5*40

TI	SS	Length
M316 7863545	M316 7963545	3,5*45
M316 7863550	M316 7963550	3,5*50
M316 7863555	M316 7963555	3,5*55
M316 7863560	M316 7963560	3,5*60
M316 7863565	M316 7963565	3,5*65
M316 7863570	M316 7963570	3,5*70

TI	SS	Length
M300 7864010	M300 7964010	4,0*10
M300 7864012	M300 7964012	4,0*12
M300 7864014	M300 7964014	4,0*14
M300 7864016	M300 7964016	4,0*16
M300 7864018	M300 7964018	4,0*18
M300 7864020	M300 7964020	4,0*20
M300 7864022	M300 7964022	4,0*22
M300 7864024	M300 7964024	4,0*24
M300 7864026	M300 7964026	4,0*26
M300 7864028	M300 7964028	4,0*28

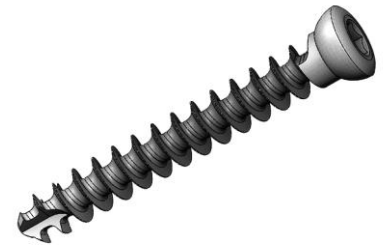
TI	SS	Length
M300 7864030	M300 7964030	4,0*30
M300 7864035	M300 7964035	4,0*35
M300 7864040	M300 7964040	4,0*40
M300 7864045	M300 7964045	4,0*45
M300 7864050	M300 7964050	4,0*50
M300 7864055	M300 7964055	4,0*55
M300 7864060	M300 7964060	4,0*60
M300 7864065	M300 7964065	4,0*65
M300 7864070	M300 7964070	4,0*70

4,0 mm Cancellous Bone Screw Full Threaded

4,0 mm Cancellous Bone Screw Partially Threaded

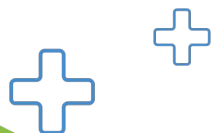

TI	SS	Length
M316 7864020	M316 7964020	4,0*20
M316 7864022	M316 7964022	4,0*22
M316 7864024	M316 7964024	4,0*24
M316 7864026	M316 7964026	4,0*26
M316 7864028	M316 7964028	4,0*28
M316 7864030	M316 7964030	4,0*30
M316 7864035	M316 7964035	4,0*35

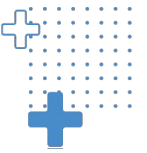
TI	SS	Length
M316 7864040	M316 7964040	4,0*40
M316 7864045	M316 7964045	4,0*45
M316 7864050	M316 7964050	4,0*50
M316 7864055	M316 7964055	4,0*55
M316 7864060	M316 7964060	4,0*60
M316 7864065	M316 7964065	4,0*65
M316 7864070	M316 7964070	4,0*70



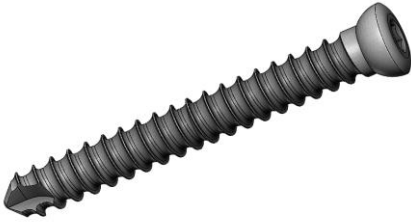

2,7 mm Cortical Screw



TI	SS	Length	TI	SS	Length
M7862710	M7962710	2,7*10	M7862730	M7962730	2,7*30
M7862712	M7962712	2,7*12	M7862735	M7962735	2,7*35
M7862714	M7962714	2,7*14	M7862740	M7962740	2,7*40
M7862716	M7962716	2,7*16	M7862745	M7962745	2,7*45
M7862718	M7962718	2,7*18	M7862750	M7962750	2,7*50
M7862720	M7962720	2,7*20	M7862755	M7962755	2,7*55
M7862722	M7962722	2,7*22	M7862760	M7962760	2,7*60
M7862724	M7962724	2,7*24	M7862765	M7962765	2,7*65
M7862726	M7962726	2,7*26	M7862770	M7962770	2,7*70
M7862728	M7962728	2,7*28			

TI	SS	Length
M7862410	M7962410	2,4*10
M7862412	M7962412	2,4*12
M7862414	M7962414	2,4*14
M7862416	M7962416	2,4*16
M7862418	M7962418	2,4*18
M7862420	M7962420	2,4*20
M7862422	M7962422	2,4*22
M7862424	M7962424	2,4*24
M7862426	M7962426	2,4*26
M7862428	M7962428	2,4*28

TI	SS	Length
M7862430	M7962430	2,4*30
M7862435	M7962435	2,4*35
M7862440	M7962440	2,4*40
M7862445	M7962445	2,4*45
M7862450	M7962450	2,4*50
M7862455	M7962455	2,4*55
M7862460	M7962460	2,4*60
M7862465	M7962465	2,4*65
M7862470	M7962470	2,4*70

2,4 mm Cortical Screw

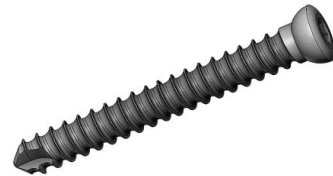

2,7 mm Mini Cortical Screw

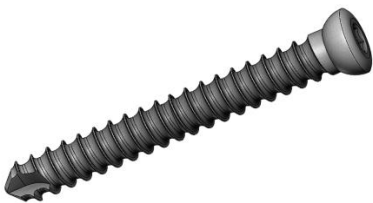

TI	SS	Length
M7832706	M7932706	2,7*6
M7832708	M7932708	2,7*8
M7832710	M7932710	2,7*10
M7832712	M7932712	2,7*12
M7832714	M7932714	2,7*14
M7832716	M7932716	2,7*16
M7832718	M7932718	2,7*18
M7832720	M7932720	2,7*20
M7832722	M7932722	2,7*22

TI	SS	Length
M7832724	M7932724	2,7*24
M7832726	M7932726	2,7*26
M7832728	M7932728	2,7*28
M7832730	M7932730	2,7*30
M7832735	M7932735	2,7*35
M7832740	M7932740	2,7*40
M7832745	M7932745	2,7*45
M7832750	M7932750	2,7*50

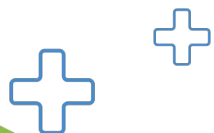

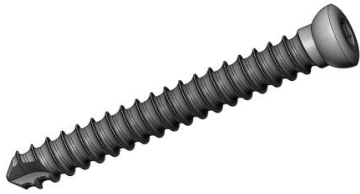
2,4 mm Mini Cortical Screw

TI	SS	Length	TI	SS	Length
M7832406	M7932406	2,4*6	M7832424	M7932424	2,4*24
M7832408	M7932408	2,4*8	M7832426	M7932426	2,4*26
M7832410	M7932410	2,4*10	M7832428	M7932428	2,4*28
M7832412	M7932412	2,4*12	M7832430	M7932430	2,4*30
M7832414	M7932414	2,4*14	M7832435	M7932435	2,4*35
M7832416	M7932416	2,4*16	M7832440	M7932440	2,4*40
M7832418	M7932418	2,4*18	M7832445	M7932445	2,4*45
M7832420	M7932420	2,4*20	M7832450	M7932450	2,4*50
M7832422	M7932422	2,4*22			

TI	SS	Length	TI	SS	Length
M7822006	M7922006	2,0*6	M7822020	M7922020	2,0*20
M7822008	M7922008	2,0*8	M7822022	M7922022	2,0*22
M7822010	M7922010	2,0*10	M7822024	M7922024	2,0*24
M7822012	M7922012	2,0*12	M7822026	M7922026	2,0*26
M7822014	M7922014	2,0*14	M7822028	M7922028	2,0*28
M7822016	M7922016	2,0*16	M7822030	M7922030	2,0*30
M7822018	M7922018	2,0*18			

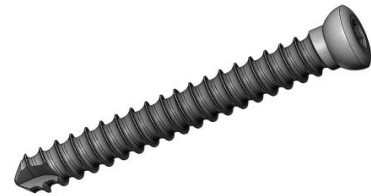
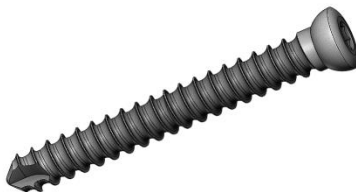
2,0 mm Mini Cortical Screw

1,5 mm Mini Cortical Screw

TI	SS	Length
M7821506	M7921506	1,5*6
M7821508	M7921508	1,5*8
M7821510	M7921510	1,5*10
M7821512	M7921512	1,5*12
M7821514	M7921514	1,5*14
M7821516	M7921516	1,5*16
M7821518	M7921518	1,5*18
M7821520	M7921520	1,5*20

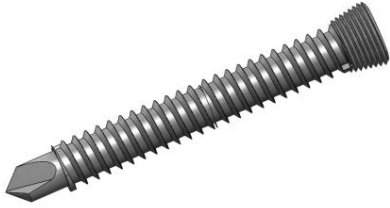

5,0 mm Self-Tapping Locking Screw

TI	SS	Length
M1865014	M1965014	5,0*14
M1865016	M1965016	5,0*16
M1865018	M1965018	5,0*18
M1865020	M1965020	5,0*20
M1865022	M1965022	5,0*22
M1865024	M1965024	5,0*24
M1865026	M1965026	5,0*26
M1865028	M1965028	5,0*28
M1865030	M1965030	5,0*30
M1865032	M1965032	5,0*32
M1865034	M1965034	5,0*34
M1865036	M1965036	5,0*36
M1865038	M1965038	5,0*38
M1865040	M1965040	5,0*40

TI	SS	Length
M1865042	M1965042	5,0*42
M1865044	M1965044	5,0*44
M1865046	M1965046	5,0*46
M1865048	M1965048	5,0*48
M1865050	M1965050	5,0*50
M1865055	M1965055	5,0*55
M1865060	M1965060	5,0*60
M1865065	M1965065	5,0*65
M1865070	M1965070	5,0*70
M1865075	M1965075	5,0*75
M1865080	M1965080	5,0*80
M1865085	M1965085	5,0*85
M1865090	M1965090	5,0*90

TI	SS	Length
M21865014	M21965014	5,0*14
M21865016	M21965016	5,0*16
M21865018	M21965018	5,0*18
M21865020	M21965020	5,0*20
M21865022	M21965022	5,0*22
M21865024	M21965024	5,0*24
M21865026	M21965026	5,0*26
M21865028	M21965028	5,0*28
M21865030	M21965030	5,0*30
M21865035	M21965035	5,0*35
M21865040	M21965040	5,0*40

TI	SS	Length
M21865045	M21965045	5,0*45
M21865050	M21965050	5,0*50
M21865055	M21965055	5,0*55
M21865060	M21965060	5,0*60
M21865065	M21965065	5,0*65
M21865070	M21965070	5,0*70
M21865075	M21965075	5,0*75
M21865080	M21965080	5,0*80
M21865085	M21965085	5,0*85
M21865090	M21965090	5,0*90

5,0 mm Low-Profile Locking Screw

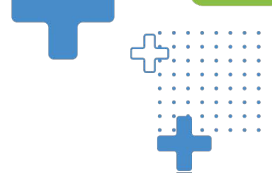



5,0 mm Locking Cancellous Screw Partially Threaded

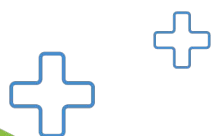

TI	SS	Length
M316 1865030	M316 1965030	5,0*30
M316 1865035	M316 1965035	5,0*35
M316 1865040	M316 1965040	5,0*40
M316 1865045	M316 1965045	5,0*45
M316 1865050	M316 1965050	5,0*50
M316 1865055	M316 1965055	5,0*55
M316 1865060	M316 1965060	5,0*60
M316 1865065	M316 1965065	5,0*65
M316 1865070	M316 1965070	5,0*70
M316 1865075	M316 1965075	5,0*75
M316 1865080	M316 1965080	5,0*80
M316 1865085	M316 1965085	5,0*85
M316 1865090	M316 1965090	5,0*90
M316 1865095	M316 1965095	5,0*95
M316 1863600	M316 1963600	5,0*100
M316 1863605	M316 1963605	5,0*105
M316 1863610	M316 1963610	5,0*110

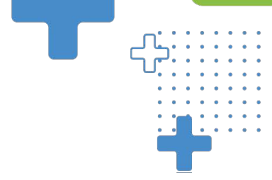



Ti	SS	Length
M51865014	M51965014	5,0*14
M51865016	M51965016	5,0*16
M51865018	M51965018	5,0*18
M51865020	M51965020	5,0*20
M51865022	M51965022	5,0*22
M51865024	M51965024	5,0*24
M51865026	M51965026	5,0*26
M51865028	M51965028	5,0*28
M51865030	M51965030	5,0*30
M51865035	M51965035	5,0*35
M51865040	M51965040	5,0*40
M51865045	M51965045	5,0*45
M51865050	M51965050	5,0*50
M51865055	M51965055	5,0*55
M51865060	M51965060	5,0*60
M51865065	M51965065	5,0*65
M51865070	M51965070	5,0*70
M51865075	M51965075	5,0*75
M51865080	M51965080	5,0*80
M51865085	M51965085	5,0*85
M51865090	M51965090	5,0*90

5,0 mm Self-Drilling Locking Screw

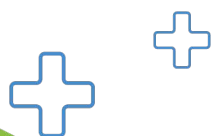
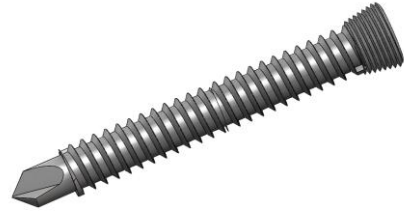

5,0 mm Self-Tapping Cannulated Locking Screw



TI	SS	Length
M4865014	M4965014	5,0*14
M4865016	M4965016	5,0*16
M4865018	M4965018	5,0*18
M4865020	M4965020	5,0*20
M4865022	M4965022	5,0*22
M4865024	M4965024	5,0*24
M4865026	M4965026	5,0*26
M4865028	M4965028	5,0*28
M4865030	M4965030	5,0*30
M4865032	M4965032	5,0*32
M4865034	M4965034	5,0*34
M4865036	M4965036	5,0*36
M4865038	M4965038	5,0*38
M4865040	M4965040	5,0*40
M4865042	M4965042	5,0*42
M4865044	M4965044	5,0*44
M4865046	M4965046	5,0*46
M4865048	M4965048	5,0*48
M4865050	M4965050	5,0*50
M4865055	M4965055	5,0*55
M4865060	M4965060	5,0*60
M4865065	M4965065	5,0*65
M4865070	M4965070	5,0*70
M4865075	M4965075	5,0*75
M4865080	M4965080	5,0*80
M4865085	M4965085	5,0*85
M4865090	M4965090	5,0*90

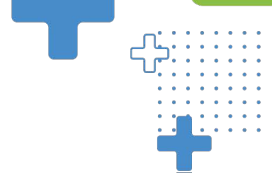

TI	SS	Length
M4897350	M4997350	7,3*50
M4897355	M4997355	7,3*55
M4897360	M4997360	7,3*60
M4897365	M4997365	7,3*65
M4897370	M4997370	7,3*70
M4897375	M4997375	7,3*75
M4897380	M4997380	7,3*80
M4897385	M4997385	7,3*85
M4897390	M4997390	7,3*90
M4897395	M4997395	7,3*95
M4897400	M4997400	7,3*100
M4897405	M4997405	7,3*105
M4897410	M4997410	7,3*110
M4897415	M4997415	7,3*115
M4897420	M4997420	7,3*120

7,3 mm Self-Tapping Cannulated Locking Screw





4,5 mm Cortical Screw

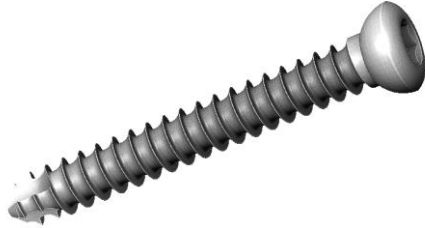

TI	SS	Length
M7884514	M7984514	4,5*14
M7884516	M7984516	4,5*16
M7884518	M7984518	4,5*18
M7884520	M7984520	4,5*20
M7884522	M7984522	4,5*22
M7884524	M7984524	4,5*24
M7884526	M7984526	4,5*26
M7884528	M7984528	4,5*28
M7884530	M7984530	4,5*30
M7884532	M7984532	4,5*32
M7884534	M7984534	4,5*34
M7884536	M7984536	4,5*36
M7884538	M7984538	4,5*38
M7884540	M7984540	4,5*40
M7884542	M7984542	4,5*42
M7884544	M7984544	4,5*44
M7884546	M7984546	4,5*46
M7884548	M7984548	4,5*48
M7884550	M7984550	4,5*50
M7884555	M7984555	4,5*55
M7884560	M7984560	4,5*60
M7884565	M7984565	4,5*65
M7884570	M7984570	4,5*70
M7884575	M7984575	4,5*75
M7884580	M7984580	4,5*80
M7884585	M7984585	4,5*85
M7884590	M7984590	4,5*90

TI	SS	Length
M300 7886530	M300 7986530	6,5*30
M300 7886535	M300 7986535	6,5*35
M300 7886540	M300 7986540	6,5*40
M300 7886545	M300 7986545	6,5*45
M300 7886550	M300 7986550	6,5*50
M300 7886555	M300 7986555	6,5*55
M300 7886560	M300 7986560	6,5*60
M300 7886565	M300 7986565	6,5*65
M300 7886570	M300 7986570	6,5*70
M300 7886575	M300 7986575	6,5*75
M300 7886580	M300 7986580	6,5*80
M300 7886585	M300 7986585	6,5*85
M300 7886590	M300 7986590	6,5*90
M300 7886595	M300 7986595	6,5*95
M300 7886600	M300 7986600	6,5*100
M300 7886605	M300 7986605	6,5*105
M300 7886610	M300 7986610	6,5*110
M300 7886615	M300 7986615	6,5*115
M300 7886620	M300 7986620	6,5*120

6,5 mm Cancellous Bone Screw Full Threaded

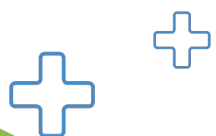
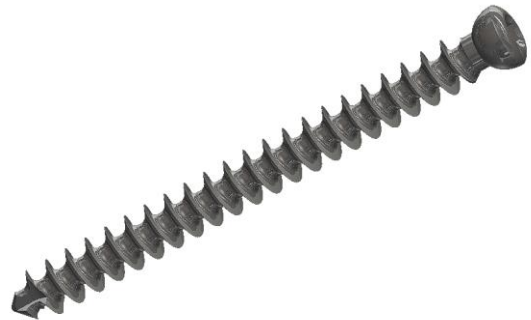



6,5 mm Cancellous Bone Screw 16 mm Threaded



TI	SS	Length
M316 7886530	M316 7986530	6,5*30
M316 7886535	M316 7986535	6,5*35
M316 7886540	M316 7986540	6,5*40
M316 7886545	M316 7986545	6,5*45
M316 7886550	M316 7986550	6,5*50
M316 7886555	M316 7986555	6,5*55
M316 7886560	M316 7986560	6,5*60
M316 7886565	M316 7986565	6,5*65
M316 7886570	M316 7986570	6,5*70
M316 7886575	M316 7986575	6,5*75
M316 7886580	M316 7986580	6,5*80
M316 7886585	M316 7986585	6,5*85
M316 7886590	M316 7986590	6,5*90
M316 7886595	M316 7986595	6,5*95
M316 7886600	M316 7986600	6,5*100
M316 7886605	M316 7986605	6,5*105
M316 7886610	M316 7986610	6,5*110
M316 7886615	M316 7986615	6,5*115
M316 7886620	M316 7986620	6,5*120

TI	SS	Length
M332 7886530	M332 7986530	6,5*30
M332 7886535	M332 7986535	6,5*35
M332 7886540	M332 7986540	6,5*40
M332 7886545	M332 7986545	6,5*45
M332 7886550	M332 7986550	6,5*50
M332 7886555	M332 7986555	6,5*55
M332 7886560	M332 7986560	6,5*60
M332 7886565	M332 7986565	6,5*65
M332 7886570	M332 7986570	6,5*70
M332 7886575	M332 7986575	6,5*75
M332 7886580	M332 7986580	6,5*80
M332 7886585	M332 7986585	6,5*85
M332 7886590	M332 7986590	6,5*90
M332 7886595	M332 7986595	6,5*95
M332 7886600	M332 7986600	6,5*100
M332 7886605	M332 7986605	6,5*105
M332 7886610	M332 7986610	6,5*110
M332 7886615	M332 7986615	6,5*115
M332 7886620	M332 7986620	6,5*120

3,5 mm Cancellous Bone Screw 32 mm Threaded

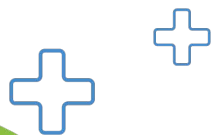



2,7 mm Cannulated Screw Partially Threaded



TI	SS	Length
M907 2716 18	M905 2716 18	2,7*18
M907 2716 20	M905 2716 20	2,7*20
M907 2716 22	M905 2716 22	2,7*22
M907 2716 24	M905 2716 24	2,7*24
M907 2716 26	M905 2716 26	2,7*26
M907 2716 28	M905 2716 28	2,7*28
M907 2716 30	M905 2716 30	2,7*30

3,5 mm Cannulated Screw Partially Threaded



TI	SS	Length
M907 3516 16	M905 3516 16	3,5*16
M907 3516 18	M905 3516 18	3,5*18
M907 3516 20	M905 3516 20	3,5*20
M907 3516 22	M905 3516 22	3,5*22
M907 3516 24	M905 3516 24	3,5*24
M907 3516 26	M905 3516 26	3,5*26
M907 3516 28	M905 3516 28	3,5*28
M907 3516 30	M905 3516 30	3,5*30
M907 3516 32	M905 3516 32	3,5*32
M907 3516 34	M905 3516 34	3,5*34
M907 3516 36	M905 3516 36	3,5*36
M907 3516 38	M905 3516 38	3,5*38
M907 3516 40	M905 3516 40	3,5*40
M907 3516 42	M905 3516 42	3,5*42
M907 3516 44	M905 3516 44	3,5*44
M907 3516 46	M905 3516 46	3,5*46
M907 3516 48	M905 3516 48	3,5*48
M907 3516 50	M905 3516 50	3,5*50

4,0 mm Cannulated Screw Partially Threaded



TI	SS	Length
M907 4016 20	M905 4016 20	4,0*20
M907 4016 22	M905 4016 22	4,0*22
M907 4016 24	M905 4016 24	4,0*24
M907 4016 26	M905 4016 26	4,0*26
M907 4016 28	M905 4016 28	4,0*28
M907 4016 30	M905 4016 30	4,0*30
M907 4016 32	M905 4016 32	4,0*32
M907 4016 34	M905 4016 34	4,0*34
M907 4016 36	M905 4016 36	4,0*36
M907 4016 38	M905 4016 38	4,0*38
M907 4016 40	M905 4016 40	4,0*40
M907 4016 42	M905 4016 42	4,0*42
M907 4016 44	M905 4016 44	4,0*44
M907 4016 46	M905 4016 46	4,0*46
M907 4016 48	M905 4016 48	4,0*48
M907 4016 50	M905 4016 50	4,0*50
M907 4016 52	M905 4016 52	4,0*52
M907 4016 54	M905 4016 54	4,0*54
M907 4016 56	M905 4016 56	4,0*56
M907 4016 58	M905 4016 58	4,0*58
M907 4016 60	M905 4016 60	4,0*60
M907 4016 62	M905 4016 62	4,0*62

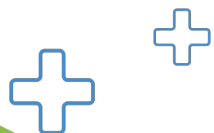

4,0 mm Cannulated Screw Full Threaded



TI	SS	Length	TI	SS	Length
M907 4000 20	M905 4000 20	4,0*20	M907 4000 46	M905 4000 46	4,0*46
M907 4000 22	M905 4000 22	4,0*22	M907 4000 48	M905 4000 48	4,0*48
M907 4000 24	M905 4000 24	4,0*24	M907 4000 50	M905 4000 50	4,0*50
M907 4000 26	M905 4000 26	4,0*26	M907 4000 52	M905 4000 52	4,0*52
M907 4000 28	M905 4000 28	4,0*28	M907 4000 54	M905 4000 54	4,0*54
M907 4000 30	M905 4000 30	4,0*30	M907 4000 56	M905 4000 56	4,0*56
M907 4000 32	M905 4000 32	4,0*32	M907 4000 58	M905 4000 58	4,0*58
M907 4000 34	M905 4000 34	4,0*34	M907 4000 60	M905 4000 60	4,0*60
M907 4000 36	M905 4000 36	4,0*36	M907 4000 62	M905 4000 62	4,0*62
M907 4000 38	M905 4000 38	4,0*38	M907 4000 64	M905 4000 64	4,0*64
M907 4000 40	M905 4000 40	4,0*40	M907 4000 66	M905 4000 66	4,0*66
M907 4000 42	M905 4000 42	4,0*42	M907 4000 68	M905 4000 68	4,0*68
M907 4000 44	M905 4000 44	4,0*44	M907 4000 70	M905 4000 70	4,0*70

TI	SS	Length
M907 4516 20	M905 4516 20	4,5*20
M907 4516 22	M905 4516 22	4,5*22
M907 4516 24	M905 4516 24	4,5*24
M907 4516 26	M905 4516 26	4,5*26
M907 4516 28	M905 4516 28	4,5*28
M907 4516 30	M905 4516 30	4,5*30
M907 4516 32	M905 4516 32	4,5*32
M907 4516 34	M905 4516 34	4,5*34
M907 4516 36	M905 4516 36	4,5*36
M907 4516 38	M905 4516 38	4,5*38
M907 4516 40	M905 4516 40	4,5*40
M907 4516 42	M905 4516 42	4,5*42
M907 4516 44	M905 4516 44	4,5*44

TI	SS	Length
M907 4516 48	M905 4516 48	4,5*48
M907 4516 50	M905 4516 50	4,5*50
M907 4516 52	M905 4516 52	4,5*52
M907 4516 54	M905 4516 54	4,5*54
M907 4516 56	M905 4516 56	4,5*56
M907 4516 58	M905 4516 58	4,5*58
M907 4516 60	M905 4516 60	4,5*60
M907 4516 62	M905 4516 62	4,5*62
M907 4516 64	M905 4516 64	4,5*64
M907 4516 66	M905 4516 66	4,5*66
M907 4516 68	M905 4516 68	4,5*68
M907 4516 70	M905 4516 70	4,5*70

4,5 mm Cannulated Screw Partially Threaded



4,5 mm Cannulated Screw Full Threaded



TI	SS	Length	TI	SS	Length
M907 4500 20	M905 4500 20	4,5*20	M907 4500 46	M905 4500 46	4,5*46
M907 4500 22	M905 4500 22	4,5*22	M907 4500 48	M905 4500 48	4,5*48
M907 4500 24	M905 4500 24	4,5*24	M907 4500 50	M905 4500 50	4,5*50
M907 4500 26	M905 4500 26	4,5*26	M907 4500 52	M905 4500 52	4,5*52
M907 4500 28	M905 4500 28	4,5*28	M907 4500 54	M905 4500 54	4,5*54
M907 4500 30	M905 4500 30	4,5*30	M907 4500 56	M905 4500 56	4,5*56
M907 4500 32	M905 4500 32	4,5*32	M907 4500 58	M905 4500 58	4,5*58
M907 4500 34	M905 4500 34	4,5*34	M907 4500 60	M905 4500 60	4,5*60
M907 4500 36	M905 4500 36	4,5*36	M907 4500 62	M905 4500 62	4,5*62
M907 4500 38	M905 4500 38	4,5*38	M907 4500 64	M905 4500 64	4,5*64
M907 4500 40	M905 4500 40	4,5*40	M907 4500 66	M905 4500 66	4,5*66
M907 4500 42	M905 4500 42	4,5*42	M907 4500 68	M905 4500 68	4,5*68
M907 4500 44	M905 4500 44	4,5*44	M907 4500 70	M905 4500 70	4,5*70

6,5 mm Cannulated Screw 16 mm Threaded



TI	SS	Length
M907 6516 30	M905 6516 30	6,5*30
M907 6516 35	M905 6516 35	6,5*35
M907 6516 40	M905 6516 40	6,5*40
M907 6516 45	M905 6516 45	6,5*45
M907 6516 50	M905 6516 50	6,5*50
M907 6516 55	M905 6516 55	6,5*55
M907 6516 60	M905 6516 60	6,5*60
M907 6516 65	M905 6516 65	6,5*65
M907 6516 70	M905 6516 70	6,5*70
M907 6516 75	M905 6516 75	6,5*75

TI	SS	Length
M907 6516 80	M905 6516 80	6,5*80
M907 6516 85	M905 6516 85	6,5*85
M907 6516 90	M905 6516 90	6,5*90
M907 6516 95	M905 6516 95	6,5*95
M907 6516 100	M905 6516 100	6,5*100
M907 6516 105	M905 6516 105	6,5*105
M907 6516 110	M905 6516 110	6,5*110
M907 6516 115	M905 6516 115	6,5*115
M907 6516 120	M905 6516 120	6,5*120

TI	SS	Length
M907 6532 40	M905 6532 40	6,5*40
M907 6532 45	M905 6532 45	6,5*45
M907 6532 50	M905 6532 50	6,5*50
M907 6532 55	M905 6532 55	6,5*55
M907 6532 60	M905 6532 60	6,5*60
M907 6532 65	M905 6532 65	6,5*65
M907 6532 70	M905 6532 70	6,5*70
M907 6532 75	M905 6532 75	6,5*75
M907 6532 80	M905 6532 80	6,5*80

TI	SS	Length
M907 6532 85	M905 6532 85	6,5*85
M907 6532 90	M905 6532 90	6,5*90
M907 6532 95	M905 6532 95	6,5*95
M907 6532 100	M905 6532 100	6,5*100
M907 6532 105	M905 6532 105	6,5*105
M907 6532 110	M905 6532 110	6,5*110
M907 6532 115	M905 6532 115	6,5*115
M907 6532 120	M905 6532 120	6,5*120

6,5 mm Cannulated Screw 32 mm Threaded



6,5 mm Cannulated Screw Full Threaded



TI	SS	Length
M907 6500 30	M905 6500 30	6,5*30
M907 6500 35	M905 6500 35	6,5*35
M907 6500 40	M905 6500 40	6,5*40
M907 6500 45	M905 6500 45	6,5*45
M907 6500 50	M905 6500 50	6,5*50
M907 6500 55	M905 6500 55	6,5*55
M907 6500 60	M905 6500 60	6,5*60
M907 6500 65	M905 6500 65	6,5*65
M907 6500 70	M905 6500 70	6,5*70
M907 6500 75	M905 6500 75	6,5*75

TI	SS	Length
M907 6500 80	M905 6500 80	6,5*80
M907 6500 85	M905 6500 85	6,5*85
M907 6500 90	M905 6500 90	6,5*90
M907 6500 95	M905 6500 95	6,5*95
M907 6500 100	M905 6500 100	6,5*100
M907 6500 105	M905 6500 105	6,5*105
M907 6500 110	M905 6500 110	6,5*110
M907 6500 115	M905 6500 115	6,5*115
M907 6500 120	M905 6500 120	6,5*120



7,3 mm Cannulated Screw 16 mm Threaded



TI	SS	Length
M907 7316 30	M905 7316 30	7,3*30
M907 7316 35	M905 7316 35	7,3*35
M907 7316 40	M905 7316 40	7,3*40
M907 7316 45	M905 7316 45	7,3*45
M907 7316 50	M905 7316 50	7,3*50
M907 7316 55	M905 7316 55	7,3*55
M907 7316 60	M905 7316 60	7,3*60
M907 7316 65	M905 7316 65	7,3*65
M907 7316 70	M905 7316 70	7,3*70
M907 7316 75	M905 7316 75	7,3*75

TI	SS	Length
M907 7316 80	M905 7316 80	7,3*80
M907 7316 85	M905 7316 85	7,3*85
M907 7316 90	M905 7316 90	7,3*90
M907 7316 95	M905 7316 95	7,3*95
M907 7316 100	M905 7316 100	7,3*100
M907 7316 105	M905 7316 105	7,3*105
M907 7316 110	M905 7316 110	7,3*110
M907 7316 115	M905 7316 115	7,3*115
M907 7316 120	M905 7316 120	7,3*120

TI	SS	Length
M907 7332 40	M905 7332 40	7,3*40
M907 7332 45	M905 7332 45	7,3*45
M907 7332 50	M905 7332 50	7,3*50
M907 7332 55	M905 7332 55	7,3*55
M907 7332 60	M905 7332 60	7,3*60
M907 7332 65	M905 7332 65	7,3*65
M907 7332 70	M905 7332 70	7,3*70
M907 7332 75	M905 7332 75	7,3*75
M907 7332 80	M905 7332 80	7,3*80

TI	SS	Length
M907 7332 85	M905 7332 85	7,3*85
M907 7332 90	M905 7332 90	7,3*90
M907 7332 95	M905 7332 95	7,3*95
M907 7332 100	M905 7332 100	7,3*100
M907 7332 105	M905 7332 105	7,3*105
M907 7332 110	M905 7332 110	7,3*110
M907 7332 115	M905 7332 115	7,3*115
M907 7332 120	M905 7332 120	7,3*120

7,3 mm Cannulated Screw 32 mm Threaded



7,3 mm Cannulated Screw Full Threaded



TI	SS	Length
M907 7300 30	M905 7300 30	7,3*30
M907 7300 35	M905 7300 35	7,3*35
M907 7300 40	M905 7300 40	7,3*40
M907 7300 45	M905 7300 45	7,3*45
M907 7300 50	M905 7300 50	7,3*50
M907 7300 55	M905 7300 55	7,3*55
M907 7300 60	M905 7300 60	7,3*60
M907 7300 65	M905 7300 65	7,3*65
M907 7300 70	M905 7300 70	7,3*70
M907 7300 75	M905 7300 75	7,3*75

TI	SS	Length
M907 7300 80	M905 7300 80	7,3*80
M907 7300 85	M905 7300 85	7,3*85
M907 7300 90	M905 7300 90	7,3*90
M907 7300 95	M905 7300 95	7,3*95
M907 7300 100	M905 7300 100	7,3*100
M907 7300 105	M905 7300 105	7,3*105
M907 7300 110	M905 7300 110	7,3*110
M907 7300 115	M905 7300 115	7,3*115
M907 7300 120	M905 7300 120	7,3*120

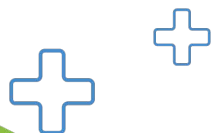

2,4 mm Headless Cannulated Compression Screw



TI	SS	Length
M807 2414	M805 2414	2,4*14
M807 2416	M805 2416	2,4*16
M807 2418	M805 2418	2,4*18
M807 2420	M805 2420	2,4*20
M807 2422	M805 2422	2,4*22
M807 2424	M805 2424	2,4*24
M807 2426	M805 2426	2,4*26
M807 2428	M805 2428	2,4*28
M807 2430	M805 2430	2,4*30

TI	SS	Length
M807 3014	M805 3014	3,0*14
M807 3016	M805 3016	3,0*16
M807 3018	M805 3018	3,0*18
M807 3020	M805 3020	3,0*20
M807 3022	M805 3022	3,0*22
M807 3024	M805 3024	3,0*24
M807 3026	M805 3026	3,0*26
M807 3028	M805 3028	3,0*28
M807 3030	M805 3030	3,0*30
M807 3035	M805 3035	3,0*35
M807 3040	M805 3040	3,0*40
M807 3045	M805 3045	3,0*45

3,0 mm Headless Cannulated Compression Screw



4,0 mm Headless Cannulated Compression Screw



TI	SS	Length
M807 4016	M805 4016	4,0*16
M807 4018	M805 4018	4,0*18
M807 4020	M805 4020	4,0*20
M807 4022	M805 4022	4,0*22
M807 4024	M805 4024	4,0*24
M807 4026	M805 4026	4,0*26
M807 4028	M805 4028	4,0*28
M807 4030	M805 4030	4,0*30
M807 4035	M805 4035	4,0*35
M807 4040	M805 4040	4,0*40
M807 4045	M805 4045	4,0*45
M807 4050	M805 4050	4,0*50
M807 4055	M805 4055	4,0*55
M807 4060	M805 4060	4,0*60
M807 4065	M805 4065	4,0*65
M807 4070	M805 4070	4,0*70

5,0 mm Headless Cannulated Compression Screw



TI	SS	Length
M807 5025	M805 5025	5,0*25
M807 5030	M805 5030	5,0*30
M807 5035	M805 5035	5,0*35
M807 5050	M805 5050	5,0*50
M807 5045	M805 5045	5,0*45
M807 5050	M805 5050	5,0*50
M807 5055	M805 5055	5,0*55
M807 5060	M805 5060	5,0*60
M807 5065	M805 5065	5,0*65
M807 5070	M805 5070	5,0*70
M807 5075	M805 5075	5,0*75
M807 5080	M805 5080	5,0*80

TI	SS	Length
M807 6525	M805 6525	6,5*25
M807 6530	M805 6530	6,5*30
M807 6535	M805 6535	6,5*35
M807 6565	M805 6565	6,5*50
M807 6545	M805 6545	6,5*45
M807 6550	M805 6550	6,5*50
M807 6555	M805 6555	6,5*55
M807 6560	M805 6560	6,5*60
M807 6565	M805 6565	6,5*65
M807 6570	M805 6570	6,5*70
M807 6575	M805 6575	6,5*75
M807 6580	M805 6580	6,5*80
M807 6585	M805 6585	6,5*85
M807 6590	M805 6590	6,5*90

5,0 mm Headless Cannulated Compression Screw



3,0/4,0 mm Herbert Screw



TI	SS	Length
M807 403014	M805 403014	14
M807 403016	M805 403016	16
M807 403018	M805 403018	18
M807 403020	M805 403020	20
M807 403022	M805 403022	22
M807 403024	M805 403024	24
M807 403026	M805 403026	26
M807 403028	M805 403028	28
M807 403030	M805 403030	30

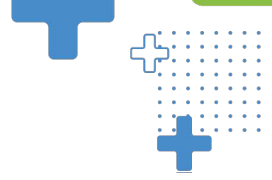

4,0/5,0 mm Herbert Screw



TI	SS	Length
M807 504020	M805 504020	20
M807 504022	M805 504022	22
M807 504024	M805 504024	24
M807 504026	M805 504026	26
M807 504028	M805 504028	28
M807 504030	M805 504030	30
M807 504032	M805 504032	32
M807 504034	M805 504034	34
M807 504036	M805 504036	36
M807 504038	M805 504038	38
M807 504040	M805 504040	40
M807 504042	M805 504042	42
M807 504044	M805 504044	44
M807 504046	M805 504046	46
M807 504048	M805 504048	48
M807 504050	M805 504050	50

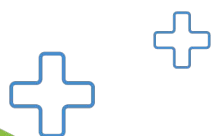



Straight Cable Grip Plate		
Ti	SS	size
	M500 01 0001	Small
	M500 01 0002	Medium
	M500 01 0003	Large
	M500 01 0004	Xlarge



Trochanteric Hook Cable Plate 1		
Ti	SS	size
	M500 01 0005	Small
	M500 01 0006	Medium
	M500 01 0007	Large
	M500 01 0008	Xlarge

Trochanteric Hook Cable Plate 2		
Ti	SS	size
	M500 01 0009	Small
	M500 01 0010	Medium
	M500 01 0011	Large
	M500 01 0012	Xlarge



Trochanteric Hook Cable Plate 3		
Ti	SS	size
	M500 01 0013	Small
	M500 01 0014	Medium
	M500 01 0015	Large
	M500 01 0016	Xlarge

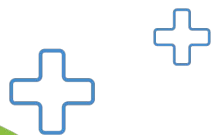



Trochanteric Grip		
Ti	SS	size
	M500 01 0017	Small
	M500 01 0018	Medium
	M500 01 0019	Large



Cable Ø1,5mm		
Ti	SS	CoCr
M500 01 1501	M500 01 1502	M500 01 1503



Cable Ø2,0 mm		
Ti	SS	CoCr
M500 02 1501	M500 02 1502	M500 02 1503

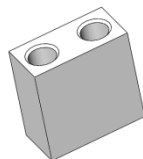

Crimp block 1,5mm	
Ti	SS
M500 01 1504	M500 01 1505

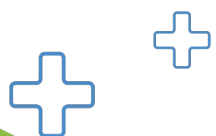

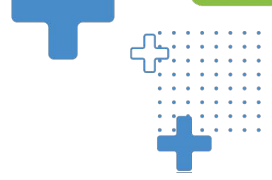

Crimp block 2,0 mm	
Ti	SS
M500 01 2004	M500 01 2005

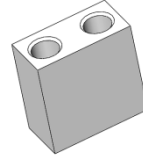
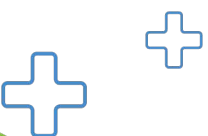
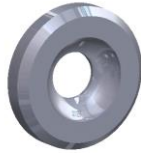
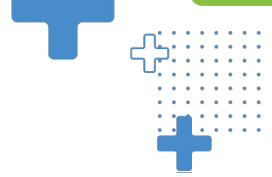

Plate Crimp Block	
Ti	SS
M500 01 2006	M500 01 2007





Plusfix Dynamic Axial External Fixator Femur-Tibia		
Ref.Kodu	Size	Length
MF 100 30 001	Short	230
MF 100 30 002	Medium	250
MF 100 30 003	Long	270



Plusfix Dynamic Axial External Fixator Femur-Tibia T- Clamp		
Ref.Kodu	Size	Length
MF 200 30 001	Short	200
MF 200 30 002	Medium	220
MF 200 30 003	Long	240

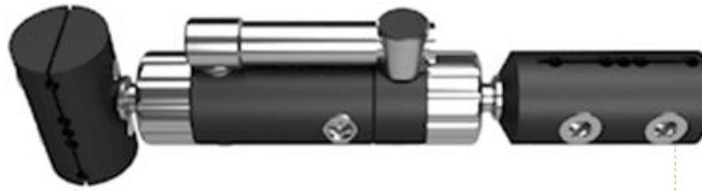

Plusfix Dynamic Axial External Fixator Trochanteric Clamp (135°)		
Ref.Kodu	Size	Length
MF 300 30 001	Short	230
MF 300 30 002	Medium	250
MF 300 30 003	Long	270

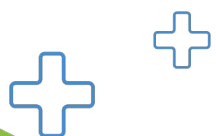

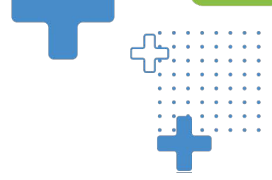

Plusfix Dynamic Axial External Fixator Square Clamp Femur-Tibia

Ref.Kodu	Size	Length
MF 400 30 001	Short	230
MF 400 30 002	Medium	250
MF 400 30 003	Long	270



Plusfix Limb Lengthening External Fixator Femur-Tibia

Ref.Kodu	Size	Length
MF 500 30 001	Short	210
MF 500 30 002	Medium	230
MF 500 30 003	Long	250



Plusfix Dynamic Axial Ankle Fixator

Ref.Kodu	Size	Length
MF 600 30 001	Left Short	235
MF 600 30 002	Left Medium	255
MF 600 30 003	Left Long	275
MF 600 30 004	Right Short	235
MF 600 30 005	Right Medium	255
MF 600 30 006	Right Long	275

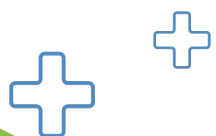

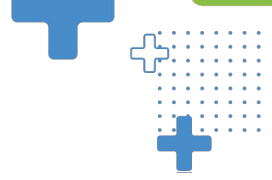

Plusfix Dynamic Axial External Fixator Humerus

Ref.Kodu	Size	Length
MF 100 25 001	Short	195
MF 100 25 002	Medium	215
MF 100 25 003	Long	235



Plusfix Dynamic Axial External Fixator Humerus T-Clamp

Ref.Kodu	Size	Length
MF 200 25 001	Short	167
MF 200 25 002	Medium	187
MF 200 25 003	Long	207



Plusfix Limb Lengthening External Fixator Humerus

Ref.Kodu	Size	Length
MF 500 25 001	Short	175
MF 500 25 002	Medium	195
MF 500 25 003	Long	215

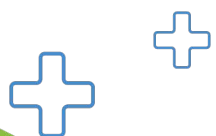

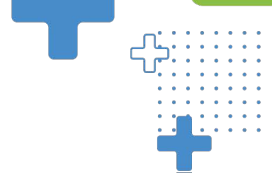

Plusfix Dynamic Axial External Fixator Forearm		
Ref.Kodu	Size	Length
MF 100 20 001	Short	165
MF 100 20 002	Medium	180
MF 100 20 003	Long	200



Plusfix Colles Type Wrist Fixator	
Ref.Kodu	Length
MF 100 16 001	210



Plusfix Wrist Fixator	
Ref.Kodu	Length
MF 100 16 002	210



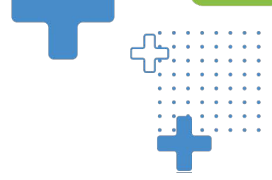

Plusfix Penning Type Wrist Fixator	
Ref.Kodu	Length
MF 100 16 003	210
MF 100 16 004	210



Plusfix Pelvis Fixator	
Ref.Kodu	
MF 700 30 001	
MF 700 30 002	



Plusfix Pediatric Pelvis Fixator	
Ref.Kodu	
MF 700 25 001	
MF 700 25 002	

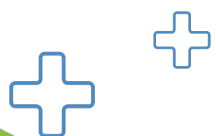

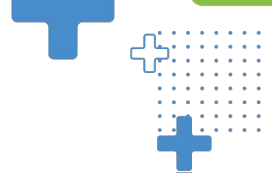

Plusfix Axial Knee Fixator	
Ref.Kodu	
MF 700 30 003	
MF 700 25 003	



Plusfix Limb Reconstruction Fixator Femur-Tibia		
Ref.Kodu	Length	
MF 800 30 001	250	
MF 800 30 002	300	
MF 800 30 003	400	



Plusfix Limb Reconstruction Pediatric Fixator		
Ref.Kodu	Length	
MF 800 25 001	150	
MF 800 25 002	200	
MF 800 25 003	250	



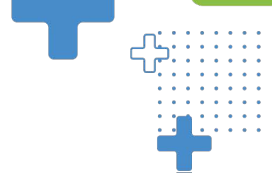

Polyaxial Femur-Tibia External Fixator

Ref.Kodu

MF 900 30 001



Ref.Kodu

MF 900 25 001



Plusfix Pertrochanteric Fixator

Ref.Kodu

MF 700 30 004

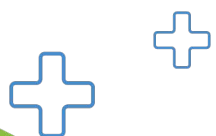

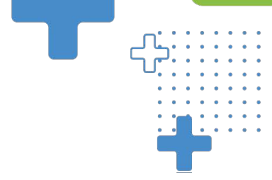

Hybrid External Fixator Femur-Tibia
Ref.Kodu
MF 160 30 001
MF 160 30 002



Hybrid External Fixator Humeral
Ref.Kodu
MF 160 25 001



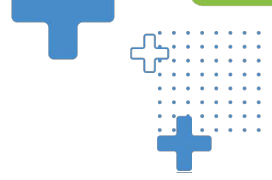

Hybrid External Fixator Wrist
Ref.Kodu
MF 160 20 001



Hybrid External Fixator Finger
Ref.Kodu
MF 160 16 001



Plusfix Finger Fixator
Ref.Kodu
MF 100 16 001
MF 100 16 002
MF 100 16 003



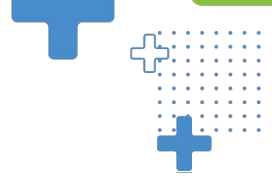

Mini Rail External Fixators	
Ref.Kodu	Size
MF 100 15 001	Mini Rail Fixator Short
MF 100 15 002	Mini Rail Fixator Medium
MF 100 15 003	Mini Rail Fixator Long
MF 100 15 004	Mini Rail Fixator Large
MF 100 15 005	Mini Rail Fixator Vertical Axis
MF 100 15 006	Mini Rail Fixator Horizontal Axis
MF 100 15 007	Mini Rail Fixator Horizontal Axis 90

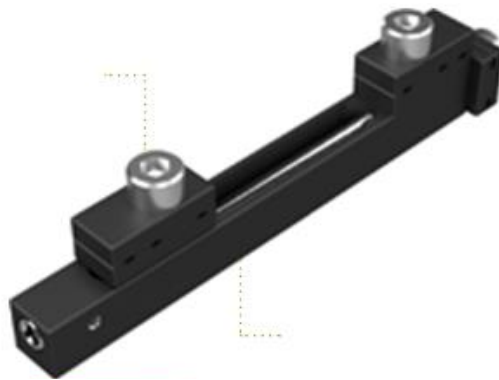

Tubular Fixator Rod-Rod Clamp	
Ref.Kodu	Size
M100 05 0001	5
M100 08 0001	8
M100 10 0001	10
M100 12 0001	12



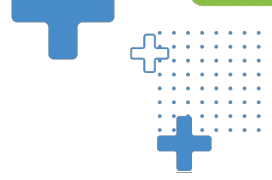

Tubular Fixator Rod-Pin Clamp	
Ref.Kodu	Size
M100 05 0002	5
M100 08 0002	8
M100 10 0002	10
M100 12 0002	12



Tubular Fixator Multiple Pin Clamp	
Ref.Kodu	Size
M100 05 0003	5
M100 08 0003	8
M100 10 0003	10
M100 12 0003	12

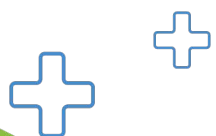

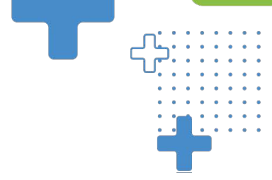

Tubular Fixator Straight Support	
Ref.Kodu	Size
M100 05 0004	5
M100 08 0004	8
M100 10 0004	10
M100 12 0004	12



Tubular Fixator 30° Angled Support	
Ref.Kodu	Size
M100 05 0005	5
M100 08 0005	8
M100 10 0005	10
M100 12 0005	12

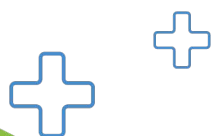

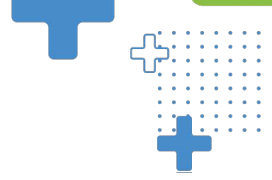

Kirschner Wires with Trocar Point		
Ref.Kodu	Ød	Length
M300 01 10 0529	0,5	290
M300 01 10 0829	0,8	290
M300 01 10 1029	1.0	290
M300 01 10 1229	1,2	290
M300 01 10 1529	1,5	290
M300 01 10 1829	1,8	290
M300 01 10 2029	2.0	290
M300 01 10 2229	2,2	290
M300 01 10 2529	2,5	290
M300 01 10 2829	2,8	290
M300 01 10 3029	3.0	290
M300 01 10 3229	3,2	290
M300 01 10 4029	4.0	290
M300 01 10 5029	5.0	290
M300 01 10 6029	6.0	290

Kirschner Wires with Double Trocar Point		
Ref.Kodu	Ød	Length
M300 01 12 0529	0,5	290
M300 01 12 0829	0,8	290
M300 01 12 1029	1.0	290
M300 01 12 1229	1,2	290
M300 01 12 1529	1,5	290
M300 01 12 1829	1,8	290
M300 01 12 2029	2.0	290
M300 01 12 2229	2,2	290
M300 01 12 2529	2,5	290
M300 01 12 2829	2,8	290
M300 01 12 3029	3.0	290
M300 01 12 3229	3,2	290
M300 01 12 4029	4.0	290
M300 01 12 5029	5.0	290
M300 01 12 6029	6.0	290

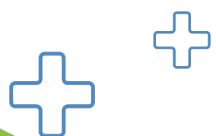

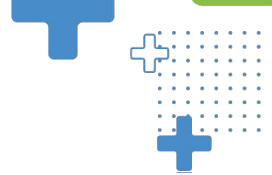

Threaded Kirschner Wires with Trocar Point		
Ref.Kodu	Ød	Length
M300 01 14 1029	1.0	290
M300 01 14 1229	1,2	290
M300 01 14 1529	1,5	290
M300 01 14 1829	1,8	290
M300 01 14 2029	2.0	290
M300 01 14 2529	2,5	290
M300 01 14 3029	3.0	290
M300 01 14 4029	4.0	290
M300 01 14 5029	5.0	290
M300 01 14 6029	6.0	290



Steinmann Pin with Trocar Point		
Ref.Kodu	Ød	Length
M300 01 16 2025	2.0	250
M300 01 16 2525	2,5	250
M300 01 16 3025	3.0	250
M300 01 16 3525	3,5	250
M300 01 16 4025	4.0	250
M300 01 16 4525	4,5	250
M300 01 16 5025	5.0	250
M300 01 16 5525	5,5	250
M300 01 16 6025	6.0	250

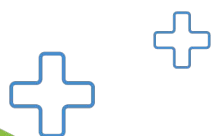



Steinmann Pins with Central Thread		
Ref.Kodu	Ød	Length
M300 01 18 2030	2.0	300
M300 01 18 2530	2,5	300
M300 01 18 3030	3.0	300
M300 01 18 3530	3,5	300
M300 01 18 4030	4.0	300
M300 01 18 4530	4,5	300
M300 01 18 5030	5.0	300
M300 01 18 5530	5,5	300
M300 01 18 6030	6.0	300



Schanz Screw Cancellous		
Ref.Kodu	Ød	Length
M300 02 05 4017	4.0	170
M300 02 05 4019	4.0	190
M300 02 05 5019	5.0	190
M300 02 05 5021	5.0	210
M300 02 05 5023	5.0	230
M300 02 05 5025	5.0	250
M300 02 05 6019	6.0	190
M300 02 05 6021	6.0	210
M300 02 05 6023	6.0	230
M300 02 05 6025	6.0	250

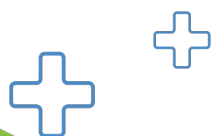



Schanz Screw Cortical		
Ref.Kodu	Ød	Length
M300 02 02 1505	1,5	50
M300 02 02 1507	1,5	70
M300 02 02 1509	1,5	90
M300 02 02 2007	2.0	70
M300 02 02 2009	2.0	90
M300 02 02 2011	2.0	110
M300 02 02 2013	2.0	130
M300 02 02 2507	2,5	70
M300 02 02 2509	2,5	90
M300 02 02 2511	2,5	110
M300 02 02 2513	2,5	130
M300 02 02 3011	3.0	110
M300 02 02 3013	3.0	130
M300 02 02 3015	3.0	150
M300 02 02 3017	3.0	170
M300 02 02 3511	3,5	110
M300 02 02 3513	3,5	130
M300 02 02 3515	3,5	150
M300 02 02 3517	3,5	170
M300 02 02 4011	4.0	110
M300 02 02 4013	4.0	130
M300 02 02 4015	4.0	150
M300 02 02 4017	4.0	170
M300 02 02 4019	4.0	190
M300 02 02 5015	5.0	150
M300 02 02 5017	5.0	170
M300 02 02 5019	5.0	190
M300 02 02 5021	5.0	210
M300 02 02 5023	5.0	230
M300 02 02 5025	5.0	250
M300 02 02 6015	6.0	150
M300 02 02 6017	6.0	170
M300 02 02 6019	6.0	190
M300 02 02 6021	6.0	210
M300 02 02 6023	6.0	230
M300 02 02 6025	6.0	250

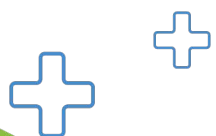

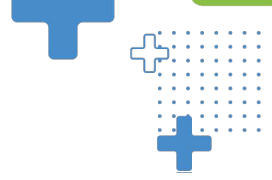

Drill Bit Round		
Ref.Kodu	Length	Helis Length
M500 02 05 1205	50	10
M500 02 05 1207	70	10
M500 02 05 1507	70	10
M500 02 05 1510	100	10
M500 02 05 1810	100	15
M500 02 05 1813	130	15
M500 02 05 2010	100	20
M500 02 05 2013	130	20
M500 02 05 2210	100	20
M500 02 05 2213	130	20
M500 02 05 2510	100	20
M500 02 05 2513	130	20
M500 02 05 2515	150	20
M500 02 05 2713	130	30
M500 02 05 2715	150	30
M500 02 05 2720	200	50
M500 02 05 2725	250	50
M500 02 05 2813	130	30
M500 02 05 2815	150	30
M500 02 05 2820	200	50
M500 02 05 2825	250	50
M500 02 05 3013	130	30
M500 02 05 3015	150	30
M500 02 05 3020	200	50
M500 02 05 3025	250	50
M500 02 05 3030	300	50
M500 02 05 3213	130	30
M500 02 05 3215	150	30
M500 02 05 3220	200	50
M500 02 05 3225	250	50
M500 02 05 3230	300	50
M500 02 05 3513	130	30
M500 02 05 3515	150	30
M500 02 05 3520	200	50
M500 02 05 3525	250	50
M500 02 05 3530	300	50
M500 02 05 3813	130	30
M500 02 05 3815	150	30
M500 02 05 3820	200	50

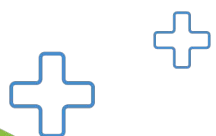



Drill Bit Round		
Ref.Kodu	Length	Helis Length
M500 02 05 3825	250	50
M500 02 05 3830	300	50
M500 02 05 4013	130	30
M500 02 05 4015	150	30
M500 02 05 4020	200	50
M500 02 05 4025	250	50
M500 02 05 4030	300	50
M500 02 05 4113	130	30
M500 02 05 4115	150	30
M500 02 05 4120	200	50
M500 02 05 4125	250	50
M500 02 05 4130	300	50
M500 02 05 4213	130	30
M500 02 05 4215	150	30
M500 02 05 4220	200	50
M500 02 05 4225	250	50
M500 02 05 4230	300	50
M500 02 05 4313	130	30
M500 02 05 4315	150	30
M500 02 05 4320	200	50
M500 02 05 4325	250	50
M500 02 05 4330	300	50
M500 02 05 4513	130	30
M500 02 05 4515	150	30
M500 02 05 4520	200	50
M500 02 05 4525	250	50
M500 02 05 4530	300	50
M500 02 05 4813	130	30
M500 02 05 4815	150	30
M500 02 05 4820	200	50
M500 02 05 4825	250	50
M500 02 05 4830	300	50
M500 02 05 5013	130	30
M500 02 05 5015	150	30
M500 02 05 5020	200	50
M500 02 05 5025	250	50
M500 02 05 5030	300	50

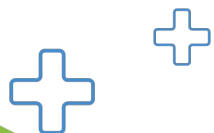

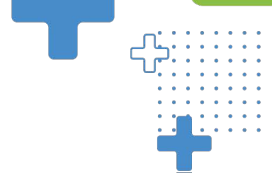

Drill Bit AQ		
Ref.Kodu	Length	Helis Length
M500 02 07 1215	150	12
M500 02 07 1515	150	15
M500 02 07 1815	150	20
M500 02 07 2015	150	20
M500 02 07 2515	150	20
M500 02 07 2715	150	30
M500 02 07 2717	170	30
M500 02 07 2815	150	30
M500 02 07 2817	170	30
M500 02 07 3015	150	30
M500 02 07 3017	170	30
M500 02 07 3215	150	30
M500 02 07 3217	170	30
M500 02 07 3517	170	30
M500 02 07 3520	200	50
M500 02 07 3817	170	30
M500 02 07 3820	200	50
M500 02 07 4017	170	30
M500 02 07 4020	200	50
M500 02 07 4117	170	30
M500 02 07 4120	200	50
M500 02 07 4317	170	30
M500 02 07 4320	200	50
M500 02 07 4517	170	30
M500 02 07 4520	200	50
M500 02 07 5017	170	30
M500 02 07 5020	200	50

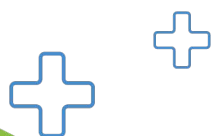

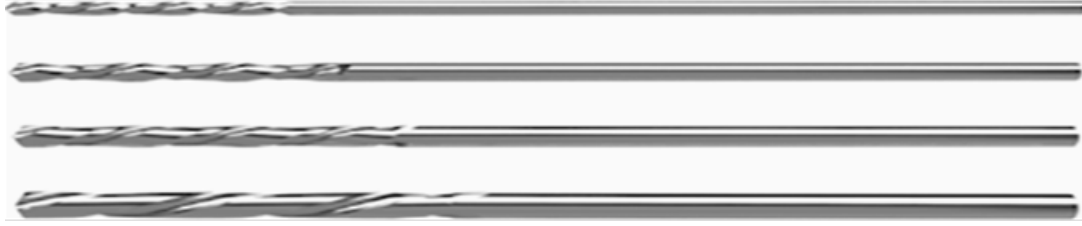

Cannulated Drill Bit		
Ref.Kodu	ØdxLength	Inside Ød
M500 02 09 1810	1,8*100	0,5
M500 02 09 2012	2,0*120	0,8
M500 02 09 2212	2,2*120	0,8
M500 02 09 2512	2,5*120	1
M500 02 09 2713	2,7*130	1,2
M500 02 09 3013	3,0*130	1,5
M500 02 09 3213	3,2*130	1,5
M500 02 09 3215	3,2*150	1,5
M500 02 09 3513	3,5*130	1,5
M500 02 09 3515	3,5*150	1,5
M500 02 09 3813	3,8*130	1,5
M500 02 09 3815	3,8*150	1,5
M500 02 09 3817	3,8*170	1,5
M500 02 09 3820	3,8*200	1,5
M500 02 09 4013	4,0*130	2
M500 02 09 4015	4,0*150	2
M500 02 09 4017	4,0*170	2
M500 02 09 4020	4,0*200	2
M500 02 09 4315	4,3*150	2
M500 02 09 4317	4,3*170	2
M500 02 09 4320	4,3*200	2
M500 02 09 4515	4,5*150	2,5
M500 02 09 4517	4,5*170	2,5
M500 02 09 4520	4,5*200	2,5
M500 02 09 4815	4,8*150	2,5
M500 02 09 4817	4,8*170	2,5
M500 02 09 4820	4,8*200	2,5
M500 02 09 5015	5,0*150	2,5
M500 02 09 5017	5,0*170	2,5
M500 02 09 5020	5,0*200	2,5
M500 02 09 6015	6,0*150	2,5
M500 02 09 6017	6,0*170	2,5
M500 02 09 6020	6,0*200	2,5

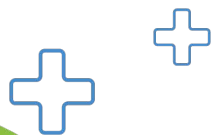



Half Ring		
Al	ss	carbon
M160 30 01 0080	M160 30 01 1080	M160 30 01 2080
M160 30 01 0100	M160 30 01 1100	M160 30 01 2100
M160 30 01 0120	M160 30 01 1120	M160 30 01 2120
M160 30 01 0140	M160 30 01 1140	M160 30 01 2140
M160 30 01 0160	M160 30 01 1160	M160 30 01 2160
M160 30 01 0180	M160 30 01 1180	M160 30 01 2180
M160 30 01 0200	M160 30 01 1200	M160 30 01 2200
M160 30 01 0220	M160 30 01 1220	M160 30 01 2220



5/8 C Ring		
Al	ss	carbon
M160 30 02 0080	M160 30 02 1080	M160 30 02 2080
M160 30 02 0100	M160 30 02 1100	M160 30 02 2100
M160 30 02 0120	M160 30 02 1120	M160 30 02 2120
M160 30 02 0140	M160 30 02 1140	M160 30 02 2140
M160 30 02 0160	M160 30 02 1160	M160 30 02 2160
M160 30 02 0180	M160 30 02 1180	M160 30 02 2180
M160 30 02 0200	M160 30 02 1200	M160 30 02 2200
M160 30 02 0220	M160 30 02 1220	M160 30 02 2220

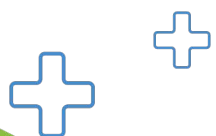



3/4 Foot Ring	
Al	ss
M160 30 03 0080	M160 30 03 1080
M160 30 03 0100	M160 30 03 1100
M160 30 03 0120	M160 30 03 1120
M160 30 03 0140	M160 30 03 1140
M160 30 03 0160	M160 30 03 1160
M160 30 03 0180	M160 30 03 1180



Femur Arch		
Al	ss	
M160 30 04 0160	M160 30 04 1160	90° 160
M160 30 04 0180	M160 30 04 1180	90° 180
M160 30 04 0200	M160 30 04 1200	90° 200
M160 30 05 0160	M160 30 05 1160	120° 160
M160 30 05 0180	M160 30 05 1180	120° 180
M160 30 05 0200	M160 30 05 1200	120° 200

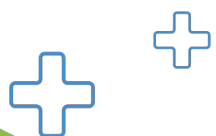

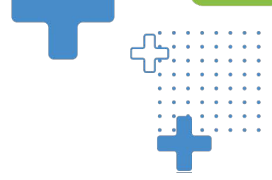

Multiple Pin Fixation Clamp	
Ref.Kodu	
M160 30 06 0001	
M160 30 06 0002	
M160 30 06 0003	
M160 30 06 0004	



Adjustable Clamp	
Ref.Kodu	
M160 30 06 0005	



Oblique Support Connector	
Ref.Kodu	Length
M160 30 07 0030	30
M160 30 07 0050	50
M160 30 07 0082	82



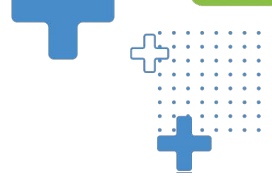

Telescopic Rod	
Ref.Kodu	Length
M160 30 08 0100	100
M160 30 08 0125	125
M160 30 08 0150	150
M160 30 08 0175	175
M160 30 08 0200	200
M160 30 08 0225	225



Threaded Rod	
Ref.Kodu	Length
M160 30 09 0050	50
M160 30 09 0075	75
M160 30 09 0100	100
M160 30 09 0125	125
M160 30 09 0150	150
M160 30 09 0175	175
M160 30 09 0200	200
M160 30 09 0250	250
M160 30 09 0300	300
M160 30 09 0350	350
M160 30 09 0400	400



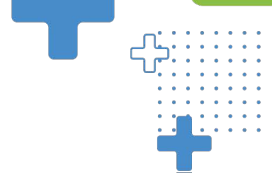

Slotted Rod	
Ref.Kodu	Length
M160 30 10 0050	50
M160 30 10 0075	75
M160 30 10 0100	100
M160 30 10 0125	125
M160 30 10 0150	150
M160 30 10 0175	175
M160 30 10 0200	200
M160 30 10 0250	250
M160 30 10 0300	300
M160 30 10 0350	350
M160 30 10 0400	400



Lengthening Rod	
Ref.Kodu	Length
M160 30 11 0075	75
M160 30 11 0100	100
M160 30 11 0125	125
M160 30 11 0150	150
M160 30 11 0175	175
M160 30 11 0200	200





Double Female Hinge
Ref.Kodu
M160 30 12 0000



Universal Hinge
Ref.Kodu
M160 30 12 0001



Male Half Hinge
Ref.Kodu
M160 30 13 0000



Male Support	
Ref.Kodu	
M160 30 13 0001	1
M160 30 13 0002	2
M160 30 13 0003	3



Female Half Hinge
Ref.Kodu
M160 30 14 0000



Female Support	
Ref.Kodu	
M160 30 14 0001	1
M160 30 14 0002	2
M160 30 14 0003	3



Cannulated Bolt
Ref.Kodu
M160 30 15 0000



Slotted Bolt
Ref.Kodu
M160 30 16 0000

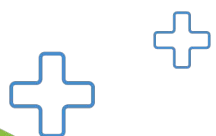

Half Pin Universal Retaining Bolt
Ref.Kodu
M160 30 17 0000



Single Pin Fixation Bolt
Ref.Kodu
M160 30 18 0000



Connection Bolt (M6)	
Ref.Kodu	Length
M160 30 19 0016	16
M160 30 19 0020	20
M160 30 19 0025	25
M160 30 19 0030	30



Connecting Plate		
Ref.Kodu	size	Length
M160 30 20 0002	2	40
M160 30 20 0003	3	50
M160 30 20 0004	4	60
M160 30 20 0005	5	70
M160 30 20 0006	6	80
M160 30 20 0007	7	90
M160 30 20 0008	8	100



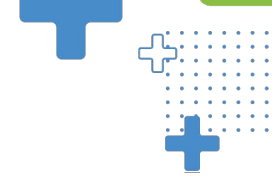

Connecting Plate with Threaded End		
Ref.Kodu	size	Length
M160 30 21 0005	5	125
M160 30 21 0007	7	165
M160 30 21 0009	9	205



90 ° Angled Connection Plate		
Ref.Kodu	size	Length
M160 30 22 0002	2	45
M160 30 22 0003	3	60
M160 30 22 0004	4	75



Twisted Plate		
Ref.Kodu	size	Length
M160 30 23 0002	2	45
M160 30 23 0003	3	60
M160 30 23 0004	4	75



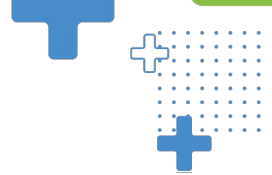

Curved plate	
Al	SS
M160 30 01 0000	M160 30 01 1000



Square socket	
Ref kodu	
M160 30 24 0001	1
M160 30 24 0002	2
M160 30 24 0003	3
M160 30 24 0004	4



Square Socket Centering Sleeve	
Ref kodu	
M160 30 24 0001	1
M160 30 24 0002	2
M160 30 24 0003	3
M160 30 24 0004	4

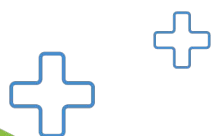

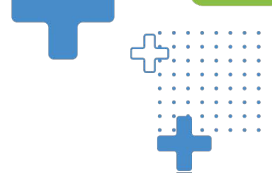

Washer
Ref.Kodu
M160 30 26 0001



Slotted Washer
Ref.Kodu
M160 30 26 0002



Oval Washer
Ref.Kodu
M160 30 26 0003



Conical Washer
Ref.Kodu
M160 30 26 0004



Star Washer
Ref.Kodu
M160 30 26 0005



Nut M6
Ref.Kodu
M160 30 26 0006

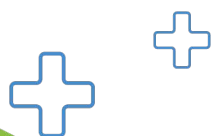

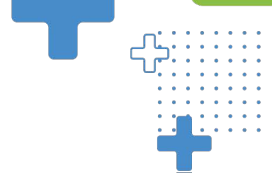

Trocar Pointed Wire	
Ref.Kodu	
M160 30 27 1830	
M160 30 27 1840	
M160 30 27 2030	
M160 30 27 2040	



Bayonet Pointed Wire	
Ref.Kodu	
M160 30 28 1830	
M160 30 28 1840	
M160 30 28 2030	
M160 30 28 2040	



Olive Wire	
Ref.Kodu	
M160 30 29 1830	
M160 30 29 1840	
M160 30 29 2030	
M160 30 29 2040	



Plusfix Hybrid Fixator	
Ref.Kodu	
M160 30 29 1830	medium
M160 30 29 1840	Long

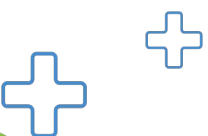

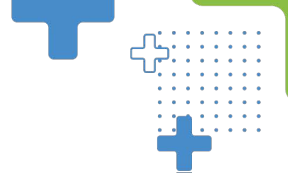

Pediatric Half Ring		
Al	ss	carbon
M160 20 01 0070	M160 20 01 1070	M160 20 01 2070
M160 20 01 0080	M160 20 01 1080	M160 20 01 2080
M160 20 01 0090	M160 20 01 1090	M160 20 01 2090
M160 20 01 0100	M160 20 01 1100	M160 20 01 2100
M160 20 01 0110	M160 20 01 1110	M160 20 01 2110
M160 20 01 0120	M160 20 01 1120	M160 20 01 2120
M160 20 01 0070	M160 20 01 1070	M160 20 01 2070
M160 20 01 0080	M160 20 01 1080	M160 20 01 2080



Pediatric 5/8 C Ring		
Al	ss	carbon
M160 20 02 0070	M160 20 02 1070	M160 20 02 2070
M160 20 02 0080	M160 20 02 1080	M160 20 02 2080
M160 20 02 0090	M160 20 02 1090	M160 20 02 2090
M160 20 02 0100	M160 20 02 1100	M160 20 02 2100
M160 20 02 0110	M160 20 02 1110	M160 20 02 2110
M160 20 02 0120	M160 20 02 1120	M160 20 02 2120
M160 20 02 0070	M160 20 02 1070	M160 20 02 2070
M160 20 02 0080	M160 20 02 1080	M160 20 02 2080

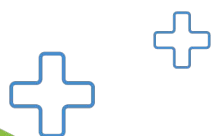

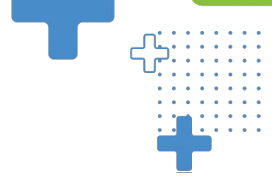

Pediatric 3/4 Foot Ring	
Al	ss
M160 20 03 0070	M160 20 03 1070
M160 20 03 0080	M160 20 03 1080
M160 20 03 0090	M160 20 03 1090
M160 20 03 0100	M160 20 03 1100
M160 20 03 0110	M160 20 03 1110
M160 20 03 0120	M160 20 03 1120



Pediatric Femur Arch		
Al	ss	
M160 20 04 0090	M160 20 04 1090	90° 90
M160 20 04 0110	M160 20 04 1110	90° 110
M160 20 05 0090	M160 20 05 1090	120° 90
M160 20 05 0110	M160 20 05 1110	120° 110



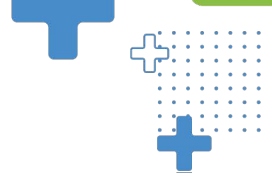

Pediatric Multiple Pin Fixation Clamp

Ref.Kodu

M160 20 06 0001



Pediatric Adjustable Clamp

Ref.Kodu

M160 20 06 0002



Pediatric Oblique Support Connector

Ref.Kodu

Length

M160 20 07 0025

25

M160 20 07 0050

50

M160 20 07 0075

75



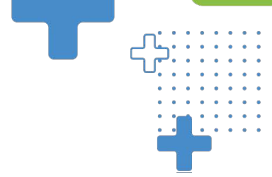

Pediatric Telescopic Rod	
Ref.Kodu	Length
M160 20 08 0080	100
M160 20 08 0100	100



Pediatric Threaded Rod	
Ref.Kodu	Length
M160 20 09 0040	40
M160 20 09 0050	50
M160 20 09 0060	60
M160 20 09 0070	70
M160 20 09 0080	80
M160 20 09 0090	90
M160 20 09 0100	100
M160 20 09 0120	120
M160 20 09 0150	150
M160 20 09 0180	180



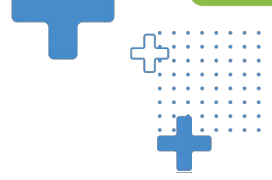

Pediatric Slotted Rod	
Ref.Kodu	Length
M160 20 10 0040	40
M160 20 10 0050	50
M160 20 10 0060	60
M160 20 10 0070	70
M160 20 10 0080	80
M160 20 10 0090	90
M160 20 10 0100	100
M160 20 10 0120	120
M160 20 10 0150	150
M160 20 10 0180	180



Pediatric Lengthening Rod	
Ref.Kodu	Length
M160 20 11 0075	75
M160 20 11 0100	100



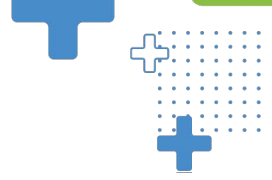

Pediatric Double Female Hinge
Ref.Kodu
M160 20 12 0000



Pediatric Universal Hinge
Ref.Kodu
M160 20 12 0001



Pediatric Male Half Hinge
Ref.Kodu
M160 20 13 0000



Pediatric Male Support	
Ref.Kodu	
M160 20 13 0001	1
M160 20 13 0002	2
M160 20 13 0003	3



Pediatric Female Half Hinge
Ref.Kodu
M160 20 14 0000



Pediatric Female Support	
Ref.Kodu	
M160 20 14 0001	1
M160 20 14 0002	2
M160 20 14 0003	3



Pediatric Cannulated Bolt
Ref.Kodu
M160 20 15 0000



Pediatric Slotted Bolt
Ref.Kodu
M160 20 16 0000

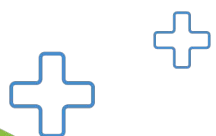

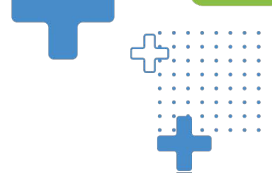

Pediatric Half Pin Universal Retaining Bolt
Ref.Kodu
M160 20 17 0000



Pediatric Single Pin Fixation Bolt
Ref.Kodu
M160 20 18 0000



Pediatric Connection Bolt (M5)	
Ref.Kodu	Length
M160 20 19 0012	12
M160 20 19 0014	14
M160 20 19 0016	16



Pediatric Connecting Plate		
Ref.Kodu	size	Length
M160 20 20 0002	2	25
M160 20 20 0003	3	45
M160 20 20 0004	4	55
M160 20 20 0005	5	65

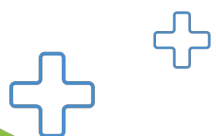

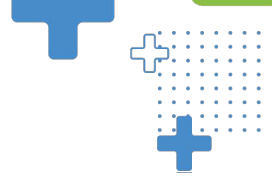

Pediatric Connecting Plate with Threaded End		
Ref.Kodu	size	Length
M160 20 21 0005	5	75
M160 20 21 0007	7	90



Pediatric 90 ° Angled Connection Plate		
Ref.Kodu	size	Length
M160 20 22 0002	2	40
M160 20 22 0003	3	52
M160 20 22 0004	4	65



Pediatric Twisted Plate		
Ref.Kodu	size	Length
M160 20 23 0002	2	45
M160 20 23 0003	3	60
M160 20 23 0004	4	75

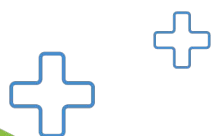



Pediatric Curved plate	
Al	SS
M160 20 01 0000	M160 30 01 1000



Pediatric Square socket	
Ref kodu	
M160 20 24 0001	1
M160 20 24 0002	2
M160 20 24 0003	3
M160 20 24 0004	4



Pediatric Square Socket Centering Sleeve	
Ref kodu	
M160 20 25 0001	2
M160 20 25 0002	2
M160 20 25 0003	3
M160 20 25 0004	4

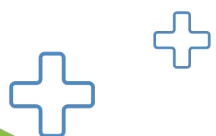

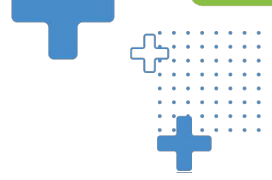

Pediatric Washer
Ref.Kodu
M160 20 26 0001



Pediatric Slotted Washer
Ref.Kodu
M160 20 26 0002



Pediatric Oval Washer
Ref.Kodu
M160 20 26 0003



Pediatric Star Washer
Ref.Kodu
M160 20 26 0004



Pediatric Nut M5
Ref.Kodu
M160 20 26 0006





PLUSCAREMED
MEDICAL DEVICES

YESİLDERE MAHALLESİ 511 SOKAK NO:7/5
ATAKUM, SAMSUN - TURKEY

+905330181284

export@pluscaremed.com

info@pluscaremed.com

www.pluscaremed.com

@pluscaremed

