

# PLUSCAREMED

## Orthopedic Surgery Instrument Sets

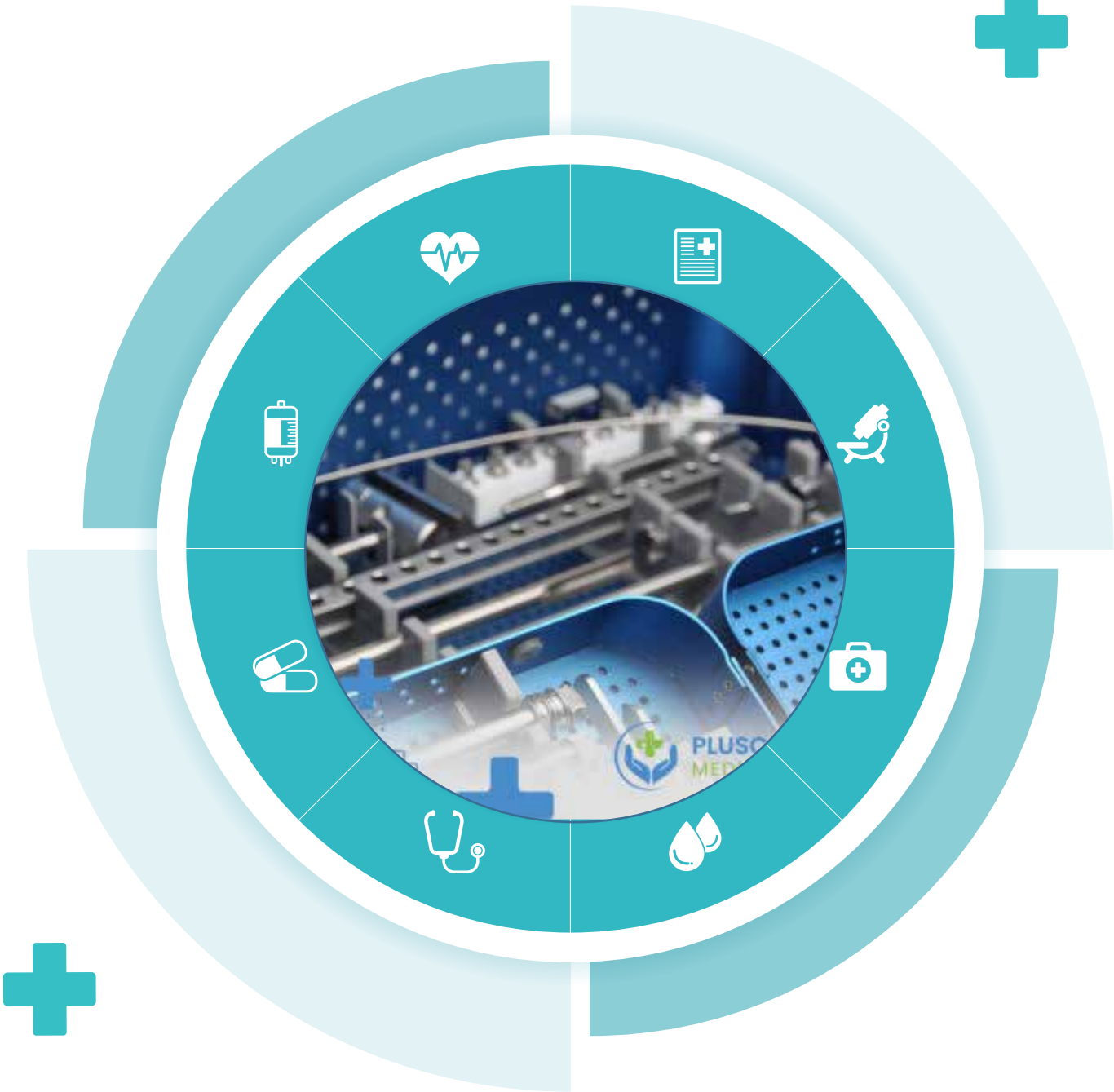

PLUSCAREMED  
MEDICAL DEVICES



PLUSCAREMED  
MEDICAL DEVICES

For more information, visit  
[WWW.PLUSCAREMED.COM](http://WWW.PLUSCAREMED.COM)



**SMALL FRAGMENT LOCKING PLATE INSTRUMENT SET**



NO	REF	DESCRIPTION
1	PC4200-0101	Neutral and Load Drill Guide Ø2.5
2	PC4200-0102	Drill & Tap Guider (Ø2.5/Ø3.5)
3	PC4200-0103	Drill & Tap Guider (Ø3.2/Ø4.0)
4	PC4200-0104	Drill Bit (Ø2.5 115mm)
5	PC4200-0105	Drill Bit (Ø2.5*115mm)
6	PC4200-0106	Drill Bit (Ø3.2 115mm)
7	PC4200-0107	Drill Bit (Ø3.2*115mm)
8	PC4200-0108	Periosteal Elevator 6mm
9	PC4200-0109	Tap Cancellous 4.0mm
10	PC4200-0110	Depth Gauge (0-60mm)
11	PC4200-0111	Extraction Screw Hexagonal 2.5mm Conical
11	PC4200-0112	Countersink
12	PC4200-0113	Periosteal Elevator 12mm
13	PC4200-0114	Hollow Reamer Ø6.0
14	PC4200-0115	Tap Cortex 3.5mm
15	PC4200-0116	Screwdriver Hexagonal 2.5mm Conical
16	PC4200-0117	Self-centering Bone Holding Forcep (190mm)
17	PC4200-0118	Sharp Reduction Forcep (190mm)
18	PC4200-0119	Obilique Reduction Forcep (170mm)
19	PC4200-0120	Bending Iron
20	PC4200-0121	Aluminium Box

**LARGE FRAGMENT LOCKING PLATE INSTRUMENT SET**

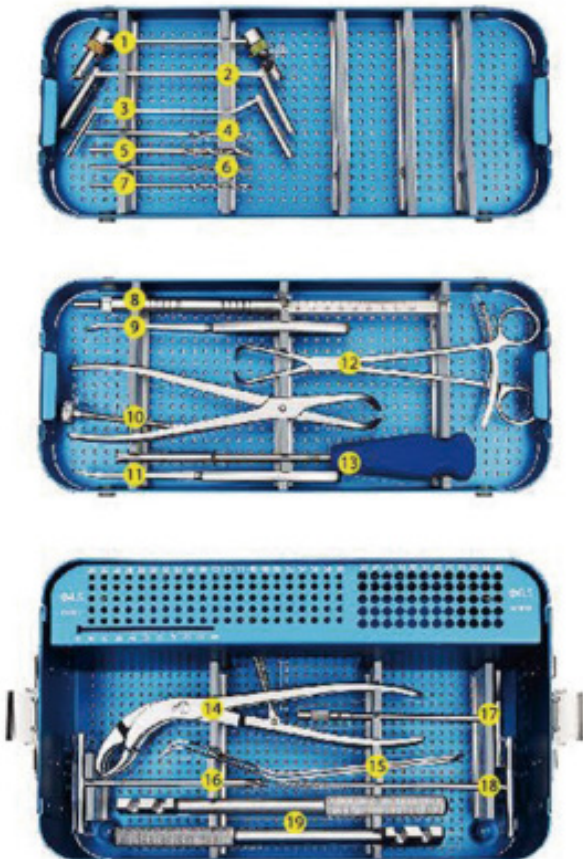

NO	REF	DESCRIPTION
1	PC4200-0201	Neutral and Load Drill Guide Ø3.2
2	PC4200-0202	Drill & Tap Guider (Ø3.2/Ø4.5)
3	PC4200-0203	Drill & Tap Guider (Ø4.5/Ø6.5)
4	PC4200-0204	Drill Bit (Ø4.5*115mm)
5	PC4200-0205	Drill Bit (Ø4.5*115mm)
6	PC4200-0206	Drill Bit (Ø3.2 115mm)
7	PC4200-0207	Drill Bit (Ø3.2 115mm)
8	PC4200-0208	Depth Gauge (0-90mm)
9	PC4200-0209	Periosteal Elevator 15mm
10	PC4200-0210	Obilique Reduction Forcep (230mm)
11	PC4200-0211	Periosteal Elevator 8mm
12	PC4200-0212	Sharp Reduction Forcep (200mm)
13	PC4200-0213	Silicon Handle Screwdriver Hexagonal 3.5mm
14	PC4200-0214	Self-centering Bone Holding Forcep (270mm)
15	PC4200-0215	Retractor Width 18mm
15	PC4200-0216	Retractor Width 40mm
16	PC4200-0217	Countersink Ø8.0
16	PC4200-0218	Extraction Screw Hexagonal 3.5mm Conical
17	PC4200-0219	Hollow Reamer Ø8.0
18	PC4200-0220	Tap Cortex 4.5mm
18	PC4200-0221	Tap Cancellous 6.5mm
19	PC4200-0222	Bending Iron
20	PC4200-0223	Aluminium Box

**MINI FRAGMENT INSTRUMENT SET**

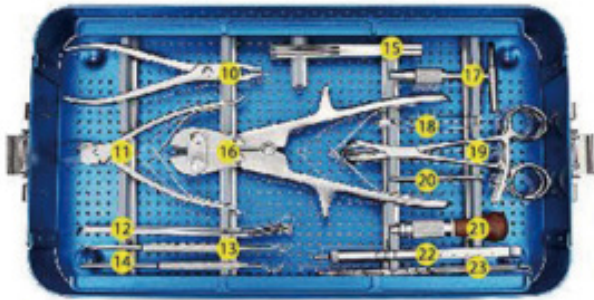
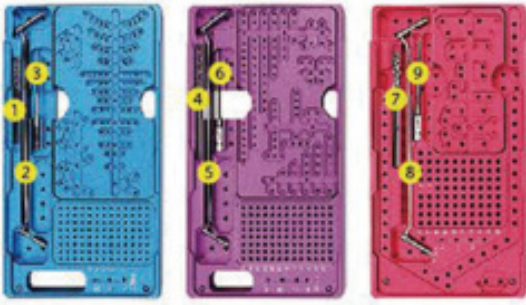

NO	REF	DESCRIPTION
1	PC4200-0401	Drill Bit 1.1 80mm
2	PC4200-0402	Drill Guider 1.1/1.5
3	PC4200-0403	Tap HA1.5
4	PC4200-0404	Drill Bit 1.5*80mm
5	PC4200-0405	Drill Guider 1.5/2.0
6	PC4200-0406	Tap HA2.0
7	PC4200-0407	Drill Bit 2.0*80mm
8	PC4200-0408	Guider 2.0/2.7
9	PC4200-0409	Tap HA2.7
9	PC4200-0410	Plate Bender Forcep
10	PC4200-0411	Plate Cutter Forcep
12	PC4200-0412	Retractors 6mm
12	PC4200-0413	Retractors 8mm
12	PC4200-0414	Retractors 15mm
13	PC4200-0415	Dissector 5mm
13	PC4200-0416	Dissector 3mm
14	PC4200-0417	Sharp Hook
15	PC4200-0418	Bending Iron
16	PC4200-0419	Wire Cutter
17	PC4200-0420	T-handle Quick Coupling
18	PC4200-0421	Screw Forcep
19	PC4200-0422	Pointed-tip Reduction Forceps
19	PC4200-0423	Bent-tip Reduction Forceps
19	PC4200-0424	Plate-hold Forceps
20	PC4200-0425	Quick Coupling Screwdriver Hex (SW2.0)
20	PC4200-0426	Countersink
21	PC4200-0427	Straight Handle Quick Coupling
22	PC4200-0428	Depth Gague 0-40mm
23	PC4200-0429	Skin Retractor (Single Hook)
23	PC4200-0430	Skin Retractor (Double Hook)
24	PC4200-0431	Aluminum Box



**DHS & DCS INSTRUMENT SET**

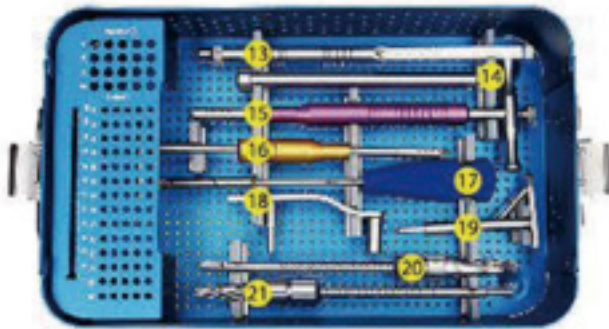
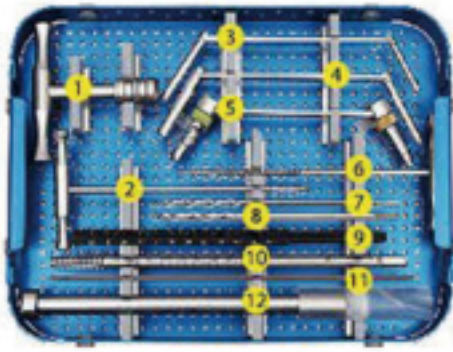

NO	REF	DESCRIPTION
1	PC4200-0501	T-handle Quick Coupling
2	PC4200-0502	Tap Cortical 4.5mm
3	PC4200-0503	Double Drill Sleeve (Ø4.5/Ø6.5)
4	PC4200-0504	Double Drill Sleeve(Ø4.5/Ø3.2)
5	PC4200-0505	Neutral and Load Drill Guide Ø2.5
6	PC4200-0506	Tap Cancellous 6.5mm
7	PC4200-0507	Drill Bit Ø3.2*150mm
8	PC4200-0508	Drill Bit Ø4.5*150mm
9	PC4200-0509	Measuring Device
10	PC4200-0510	Tap Cancellous 12mm
11	PC4200-0511	Threaded K-wire Ø2.5*225mm
12	PC4200-0512	DHS/DCS Impactor Large
13	PC4200-0513	Depth Gauge (0-100mm)
14	PC4200-0514	DHS/DCS Impactor Small
15	PC4200-0515	DHS/DCS Wrench, Purple Sleeve
16	PC4200-0516	DHS/DCS Wrench, Golden Sleeve
17	PC4200-0517	Screwdriver Hexagonal 3.5mm
18	PC4200-0518	DCS Angle Guide 95 Degree
19	PC4200-0519	DHS Angle Guier 135 degree
20	PC4200-0520	DHS Reamer
21	PC4200-0521	DCS Reamer
22	PC4200-0522	Aluminium Box

**6.5 MM CANNULATED SCREW INSTRUMENT SET**

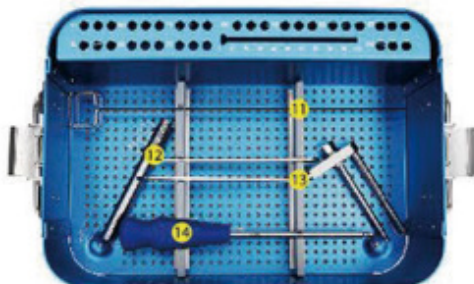
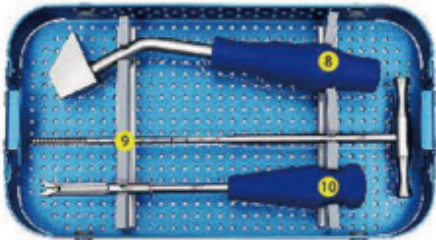
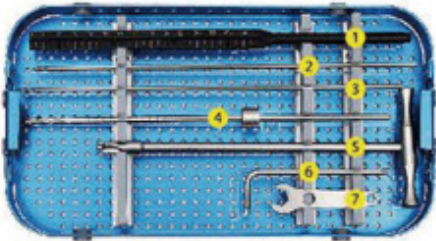

NO	REF	DESCRIPTION
1	PC4200-0701	Depth Gauge(0-120mm)
2	PC4200-0702	Threaded Guider Wire 2.5mm
3	PC4200-0703	Threaded Guider Wire 2.5mm
4	PC4200-0704	Cannulated Drill Bit with Limited Block 4.5mm
5	PC4200-0705	Cannulated Countersink Ø9
6	PC4200-0706	Hex Key
7	PC4200-0707	Wrench for Adjustable Parallel Wire Guider
8	PC4200-0708	Multiple Wire Guider
9	PC4200-0709	Tap Cannulated Screw 6.5mm
10	PC4200-0710	Screwdriver Hexagonal 3.5mm
11	PC4200-0711	Cleaning Stylet 2.5mm
12	PC4200-0712	Drill Sleeve
13	PC4200-0713	Adjustable Parallel Wire Guider
14	PC4200-0714	Cannulated Screwdriver Hexagonal 3.5mm
15	PC4200-0715	Aluminium Box

**PELVIC RECONSTRUCTION PLATE INSTRUMENT SET**

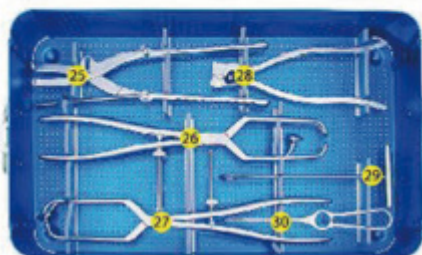
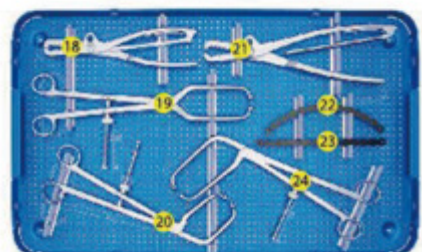
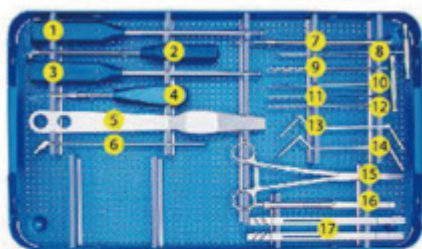

NO	REF	DESCRIPTION
1	PC4200-0801	Straight Ball Spike 300mm
2	PC4200-0802	Universal Hex Screwdriver SW2.5
3	PC4200-0803	Straight Ball Spike 300mm
4	PC4200-0804	Hex Screwdriver SW2.5
5	PC4200-0805	Retractor
6	PC4200-0806	Drill Guider Ø2.5
7	PC4200-0807	Flexible Drill Bit Ø2.5
8	PC4200-0808	Tap Ø3.5
9	PC4200-0809	Drill Bit Ø3.0
10	PC4200-0810	Tap Ø4.0
11	PC4200-0811	Drill Bit Ø2.5
12	PC4200-0812	Drill Bit Ø2.5
13	PC4200-0813	Drill/Tap Guider Ø2.5/3.5
14	PC4200-0814	Drill/Tap Guider Ø3.0/4.0
15	PC4200-0815	Screw Holder Forcep
16	PC4200-0816	Depth Gague 0-60mm
17	PC4200-0817	Bending Iron
18	PC4200-0818	Bone Holding Forcep 200mm
19	PC4200-0819	Reduction Forcep Straight
20	PC4200-0820	Reduction Forcep Curved 250mm
21	PC4200-0821	Bone Holding Forcep 250mm
22	PC4200-0822	Pelvic Mould Plate
23	PC4200-0823	Reconstruction Mould Plate
24	PC4200-0824	Reduction Forcep Curved 280mm
25	PC4200-0825	Pelvic Reconstruction Forcep Large 330mm
26	PC4200-0826	Pelvic Reduction Forcep with 2 Ball-tipped 400mm
27	PC4200-0827	Pelvic Reduction Forcep with 2 High-low Ball-tipped 400mm
27	PC4200-0828	Pelvic Reduction Forcep with 3 Ball-tipped 400mm
28	PC4200-0829	Plate Bender
29	PC4200-0830	Bone Hook
30	PC4200-0831	T-handle Bone Hook
31	PC4200-0832	Aluminium Box

**4.0 MM CANNULATED SCREW INSTRUMENT SET**

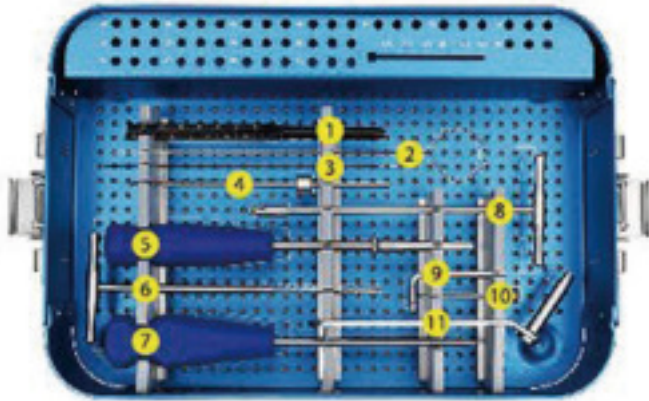

NO	REF	DESCRIPTION
1	PC4200-0601	Depth Gauge (0-80mm)
2	PC4200-0602	Cleaning Stylet 1.2mm
3	PC4200-0603	Threaded Guider Wire 1.2mm
4	PC4200-0604	Cannulated Drill Bit with Limited Block 2.7mm
5	PC4200-0605	Screwdriver Hexagonal 2.5mm with Sleeve
6	PC4200-0606	Cannulated Tap Cannulated Screw 4.0mm
7	PC4200-0607	Cannulated Screwdriver Hexagonal 2.5mm
8	PC4200-0608	Cannulated Countersink Ø6.5
9	PC4200-0609	Hex Key
10	PC4200-0610	Wire Sleeve 1.2mm
11	PC4200-0611	Drill Sleeve
12	PC4200-0612	Aluminium Box

**TITANIUM CABLE INSTRUMENT SET**

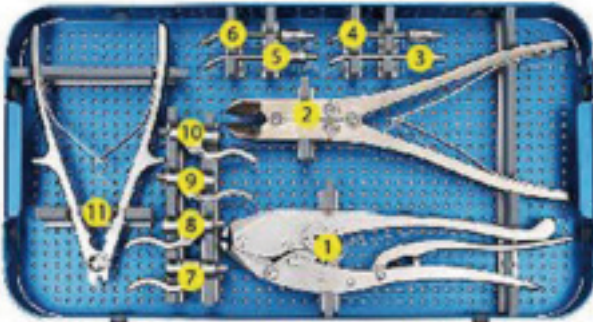

NO	REF	DESCRIPTION
1	PC4200-1301	Cable Crimper
2	PC4200-1302	Cable Cutter Large
3	PC4200-1303	Attachment Bit
4	PC4200-1304	Attachment Bit
5	PC4200-1305	Attachment Bit
6	PC4200-1306	Attachment Bit
7	PC4200-1307	Provisional Tensioning Device
8	PC4200-1308	Provisional Tensioning Device
9	PC4200-1309	Provisional Tensioning Device
10	PC4200-1310	Provisional Tensioning Device
11	PC4200-1311	Cable Cutter Standard
12	PC4200-1312	Medium Cable Passer
13	PC4200-1313	Large Cable Passer
14	PC4200-1314	Medium Cable Passer, curved
15	PC4200-1315	Large Cable Passer, curved
16	PC4200-1316	Cable Tensioner
17	PC4200-1317	Aluminium Box

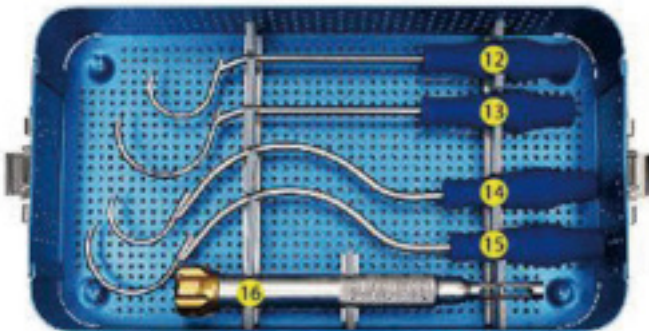

**FEMUR RETRACTOR INSTRUMENT SET**

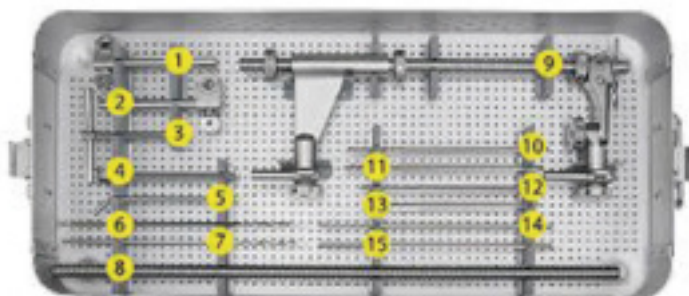

NO	REF	DESCRIPTION
1	PC4200-1501	Connect Rod
2	PC4200-1502	Connect Rod
3	PC4200-1503	T-handle Screwdriver
4	PC4200-1504	Triple Drill Sleeve Ø3.5/Ø3.6/Ø5.1
5	PC4200-1505	L Wrench
6	PC4200-1506	Drill Bit 3.5*200
7	PC4200-1507	Drill Bit 3.5*200
8	PC4200-1508	Lengthening Rod
9	PC4200-1509	Femur Retractor
10	PC4200-1510	Bone Screw 5*150
11	PC4200-1511	Bone Screw 5*150
12	PC4200-1512	Bone Screw 5*170
13	PC4200-1513	Bone Screw 5*170
14	PC4200-1514	Bone Screw 5*200
15	PC4200-1515	Bone Screw 5*200
16	PC4200-1516	Aluminium Box

**SCREW REMOVAL INSTRUMENT SET**

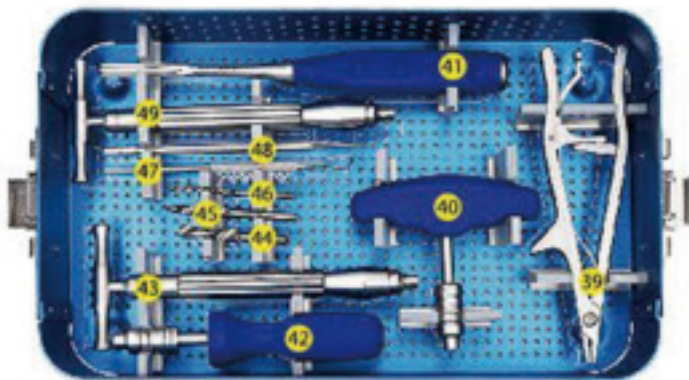
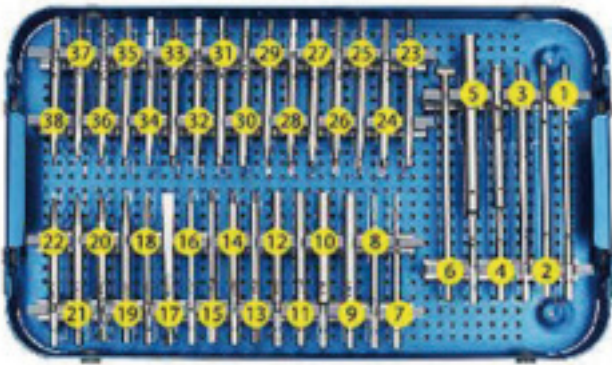

NO	REF	DESCRIPTION
1	PC4200-1001	Hollow Reamer Ø4
2	PC4200-1002	Hollow Reamer Ø5
3	PC4200-1003	Hollow Reamer Ø6.5
4	PC4200-1004	Hollow Reamer Ø8
5	PC4200-1005	Hollow Reamer Ø10
6	PC4200-1006	Spinal Monoaxial Pedicle Screwdriver
7	PC4200-1007	Hollow Reamer Ø3.0
8	PC4200-1008	Hollow Reamer Ø2.7
9	PC4200-1009	Extraction Bolt Ø6.5
10	PC4200-1010	Extraction Bolt Ø6.0
11	PC4200-1011	Extraction Bolt Ø4.5
12	PC4200-1012	Extraction Bolt Ø3.5
13	PC4200-1013	Extraction Screw Hexagonal 4.0mm Conical
14	PC4200-1014	Extraction Screw Hexagonal 3.5mm Conical
15	PC4200-1015	Extraction Screw Hexagonal 2.5mm Conical
16	PC4200-1016	Extraction Screw Hexagonal 2.5*0.5mm Conical
17	PC4200-1017	Slotted Screwdriver Small
18	PC4200-1018	Slotted Screwdriver Large
19	PC4200-1019	Phillips Screwdriver
20	PC4200-1020	Square Screwdriver SW1.5
21	PC4200-1021	Square Screwdriver SW1.2
22	PC4200-1022	Square Screwdriver SW1.1
23	PC4200-1023	Star Screwdriver T5.5
24	PC4200-1024	Star Screwdriver T5.0
25	PC4200-1025	Star Screwdriver T4.4
26	PC4200-1026	Star Screwdriver T3.8
27	PC4200-1027	Star Screwdriver T3.3
28	PC4200-1028	Star Screwdriver T2.7
29	PC4200-1029	Star Screwdriver T2.2
30	PC4200-1030	Hexagonal Screwdriver SWS.S
31	PC4200-1031	Hexagonal Screwdriver SW5.0
32	PC4200-1032	Hexagonal Screwdriver SW4.5
33	PC4200-1033	Hexagonal Screwdriver SW4.0
34	PC4200-1034	Hexagonal Screwdriver SW3.5
35	PC4200-1035	Hexagonal Screwdriver SW3.0
36	PC4200-1036	Hexagonal Screwdriver SW2.5
37	PC4200-1037	Hexagonal Screwdriver SW2.0
38	PC4200-1038	Hexagonal Screwdriver SW1.5
39	PC4200-1039	Pliers for Screw Removal
40	PC4200-1040	T-shaped Handle Quick Coupling
41	PC4200-1041	Round Gouge 8mm
42	PC4200-1042	Straight Handle Quick Coupling
43	PC4200-1043	Screw Extractor Ø4.5
44	PC4200-1044	High Speed Drill Bit Ø8*36*75mm
45	PC4200-1045	High Speed Drill Bit Ø6*36*75mm
46	PC4200-1046	High Speed Drill Bit Ø4*36*75mm
47	PC4200-1047	Sharp Hook
48	PC4200-1048	Tip Screwdriver
49	PC4200-1049	Screw Extractor Ø3.5
50	PC4200-1050	Aluminium Box

**3,0/3,5/4,0/5,0 MM CANNULATED HEADLESS COMPRESSION SCREW INSTRUMENT SET**

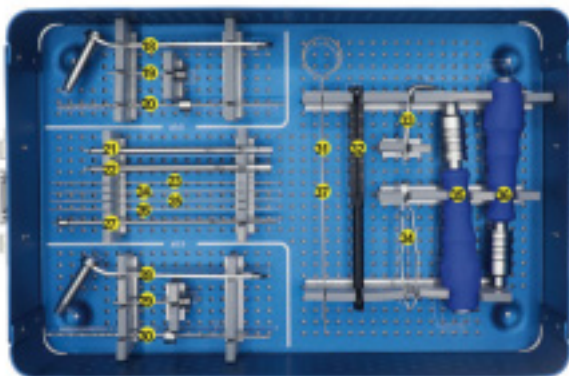
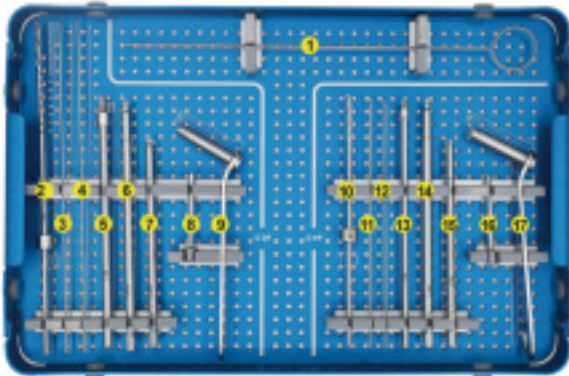

NO	REF	DESCRIPTION
1	PC4200-1901	Cannulated Countersink Ø3.0*Ø1.1*150
2	PC4200-1902	Cannulated Countersink Ø3.5*Ø1.3*150
3	PC4200-1903	Canuated Drill Bit Ø2.8*Ø1.2*150
4	PC4200-1904	Canuated Drill Bit Ø2.5*Ø1.1*150
5	PC4200-1905	Canuated Drill Bit Ø2.0*Ø1.1*150
6	PC4200-1906	Guider Wire 1.0*150
7	PC4200-1907	Guider Wire 1.0*150
8	PC4200-1908	Guider Wire 1.0*150
9	PC4200-1909	Guider Wire 1.0*150
10	PC4200-1910	Guider Wire 1.2*150
11	PC4200-1911	Guider Wire 1.2*150
12	PC4200-1912	Hex Key
13	PC4200-1913	Wire Sleeve Ø1.0*2.0
14	PC4200-1914	Wire Sleeve Ø1.0*2.5
15	PC4200-1915	Wire Sleeve Ø1.2*3.0
16	PC4200-1916	Drill Sleeve \$2.0
17	PC4200-1917	Drill Sleeve Ø2.5
18	PC4200-1918	Drill Sleeve Ø3.0
19	PC4200-1919	Quick Coupling Handle
20	PC4200-1920	Quick Coupling Handle
21	PC4200-1921	Clean Wire Ø1.0
22	PC4200-1922	Screw Holding Forcep
23	PC4200-1923	Cannulated Hex Screwdriver SW2.0
24	PC4200-1924	Hex Screwdriver SW2.0
25	PC4200-1925	Cannulated Hex Screwdriver SW2.0
26	PC4200-1926	Hex Screwdriver SW2.0
27	PC4200-1927	Depth Gague
28	PC4200-1928	Clean Wire Ø1.2
29	PC4200-1929	Clean Wire Ø1.5
30	PC4200-1930	Guider Wire 1.5*200
31	PC4200-1931	Canuated Drill Bit Ø3.5*Ø1.5*200
32	PC4200-1932	Drill Sleeve Ø3.5
33	PC4200-1933	Wire Sleeve Ø1.5
34	PC4200-1934	Cannulated Hex Screwdriver SW3.0
35	PC4200-1935	Cannulated Countersink Ø5.0*Ø1.5*150
36	PC4200-1936	Hex Screwdriver SW3.0
37	PC4200-1937	Aluminium Box

**3,5/4,0/4,5 MM CANNULATED SCREW INSTRUMENT SET**

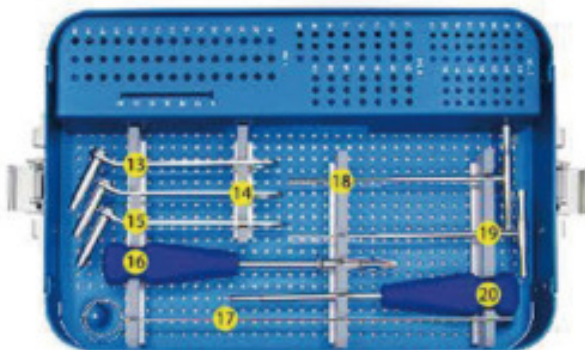
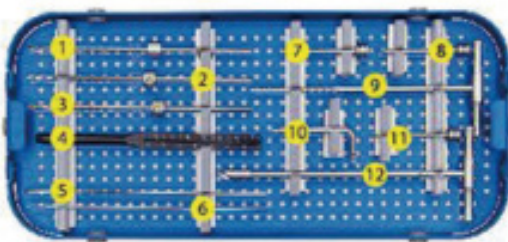

NO	REF	DESCRIPTION
1	PC4200-1601	Cannulated Drill Bit with Limited Block 2.6mm
2	PC4200-1602	Cannulated Drill Bit with Limited Block 2.8mm
3	PC4200-1603	Cannulated Drill Bit with Limited Block 3.2mm
4	PC4200-1604	Depth Gague(0-80mm)
5	PC4200-1605	Threaded K-wire Ø1.2
6	PC4200-1606	Threaded K-wire Ø1.5
7	PC4200-1607	Wire Sleeve Ø1.2/2.6
8	PC4200-1608	Wire Sleeve Ø1.2/2.8
9	PC4200-1609	Ø3.5 Cannulated Tap
10	PC4200-1610	Hex Key
11	PC4200-1611	Wire Sleeve Ø1.5/3.2
12	PC4200-1612	Ø6.5 Cannulated Countersink
13	PC4200-1613	Drill Sleeve Ø2.6
14	PC4200-1614	Drill Sleeve Ø2.8
15	PC4200-1615	Drill Sleeve Ø3.2
16	PC4200-1616	Hexagonal Screwdriver SW2.5
17	PC4200-1617	Cleaning Stylet Ø1.2
17	PC4200-1618	Cleaning Stylet Ø1.5
18	PC4200-1619	Ø4.0 Cannulated Tap
19	PC4200-1620	Ø4.5 Cannulated Tap
20	PC4200-1621	Hexagonal Cannulated Screwdriver SW2.5
21	PC4200-1622	Aluminium Box

**6,5/7,3 MM CANNULATED SCREW INSTRUMENT SET**

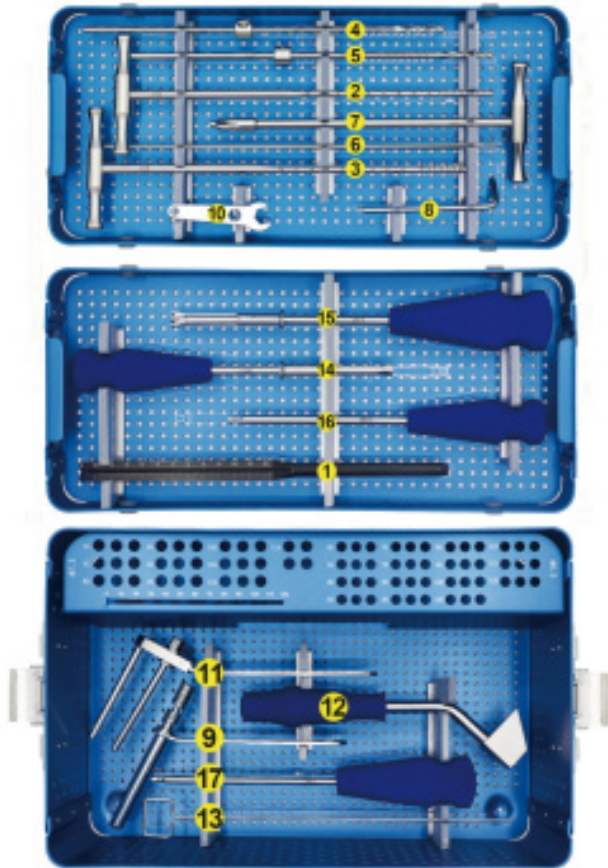

NO	REF	DESCRIPTION
1	PC4200-1701	Depth Gague(o-80mm)
2	PC4200-1702	Ø6.5 Cannulated Tap
3	PC4200-1703	Ø7.3 Cannulated Tap
4	PC4200-1704	Cannulated Drill Bit with Limited Block 4.5mm
5	PC4200-1705	Cannulated Drill Bit with Limited Block 5.0mm
6	PC4200-1706	Threaded K-wire Ø2.5
7	PC4200-1707	Ø9 Cannulated Countersink
8	PC4200-1708	Hex Key
9	PC4200-1709	Protection Sleeve+Drill Sleeve
10	PC4200-1710	Wrench
11	PC4200-1711	Parallel Guide Adustable
12	PC4200-1712	Adjustable Guide
13	PC4200-1713	Cleaning Stylet Ø2.0
14	PC4200-1714	Hexagonal Screwdriver SW3.5
15	PC4200-1715	Hexagonal Screwdriver SW4.0
16	PC4200-1716	Hexagonal Cannulated Screwdriver SW3.5
17	PC4200-1717	Hexagonal Cannulated Screwdriver SW4.0
18	PC4200-1718	Aluminium Box



**HUMERAL INTRAMEDULLARY NAIL INSTRUMENT SET**

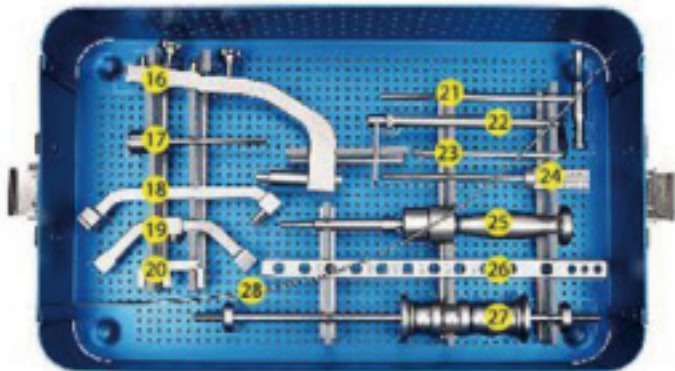
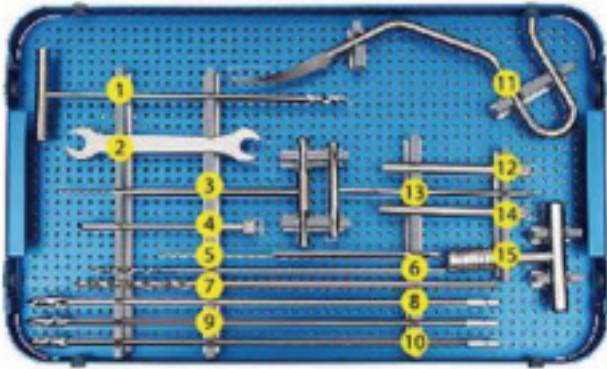

NO	REF	DESCRIPTION
1	PC1200-0101	Drill Bit 5.2mm
2	PC1200-0102	Open Wrench
3	PC1200-0103	Tap 3.5mm
4	PC1200-0104	Distal Positioning Frame
5	PC1200-0105	Depth Gague 0-60mm
6	PC1200-0106	Drill Bit 2.9*250mm
7	PC1200-0107	Drill Bit 5.2*300mm
8	PC1200-0108	Reamer 8.5*340mm
9	PC1200-0109	Reamer 8.0*340mm
10	PC1200-0110	Reamer 7.5*340mm
11	PC1200-0111	AWL
12	PC1200-0112	Sleeve
13	PC1200-0113	Screwdriver SW2.5
14	PC1200-0114	Sleeve
15	PC1200-0115	Quick Coupling T-Handle
16	PC1200-0116	Sighting Device Handle
17	PC1200-0117	Nail Connector
18	PC1200-0118	Distal Guider
19	PC1200-0119	Proximal Guider
20	PC1200-0120	Fixed Connector
21	PC1200-0121	Location Rod
22	PC1200-0122	Drill Sleeve
23	PC1200-0123	Hex Wrench
24	PC1200-0124	Gauge Cannula
25	PC1200-0125	Universal Joint
26	PC1200-0126	Guide Rod
27	PC1200-0127	Hammer
28	PC1200-0128	Guide Wire
29	PC1200-0129	Aluminium Box

**TIBIAL INTRAMEDULLARY NAIL INSTRUMENT SET**

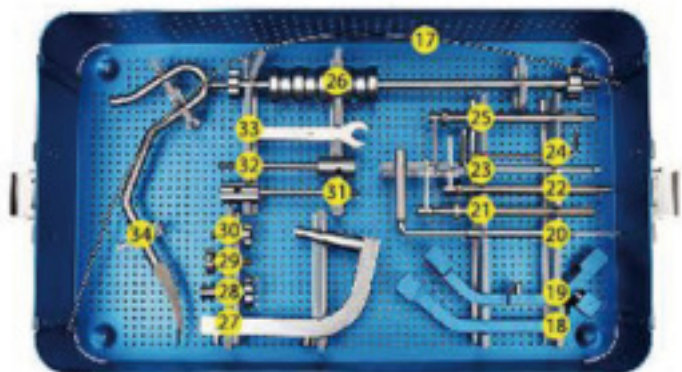
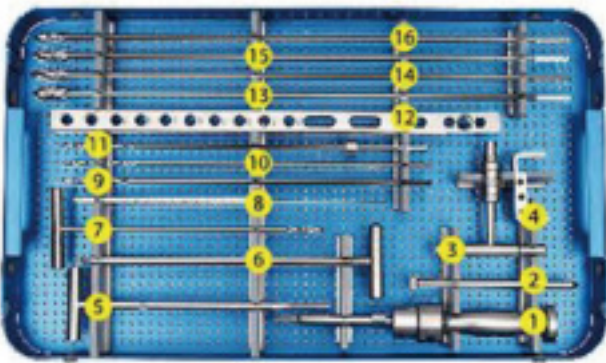

NO	REF	DESCRIPTION
1	PC1200-0201	Universal Joint
2	PC1200-0202	Distal Positioning Frame
3	PC1200-0203	Quick Coupling T-Handle
4	PC1200-0204	Fixed Connector
5	PC1200-0205	Location Rod Screwdriver
6	PC1200-0206	T-handle Drill Bit 5.2mm
7	PC1200-0207	Depth Gague 10-100mm
8	PC1200-0208	Drill Bit 5.2*300mm
9	PC1200-0209	Drill Bit 4.0 300mm
10	PC1200-0210	Drill Bit with Limitator 4.0*30
11	PC1200-0211	Guide Rod
12	PC1200-0212	Reamer 8mm
13	PC1200-0213	Reamer 9mm
14	PC1200-0214	Reamer 10mm
15	PC1200-0215	Reamer 11mm
16	PC1200-0216	Guide Wire
17	PC1200-0217	Distal Guider
18	PC1200-0218	Proximal Guider
19	PC1200-0219	Location Forcep
20	PC1200-0220	Drill Sleeve
21	PC1200-0221	Drill Sleeve
22	PC1200-0222	Hex Wrench
23	PC1200-0223	Hex Wrench
24	PC1200-0224	Drill Sleeve
25	PC1200-0225	Hammer
26	PC1200-0226	Sighting Device Handle
27	PC1200-0227	Bolt
28	PC1200-0228	Bolt
29	PC1200-0229	Bolt
30	PC1200-0230	Nail Connector Solid
31	PC1200-0231	Nail Connector Cannulated
32	PC1200-0232	Open Wrench AWL
33	PC1200-0233	Aluminium Box

FEMORAL INTRAMEDULLARY NAIL INSTRUMENT SET

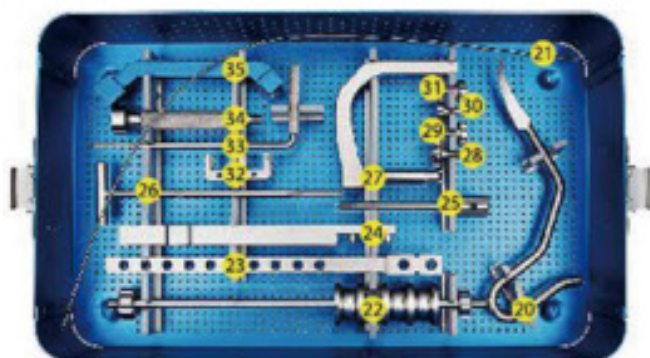
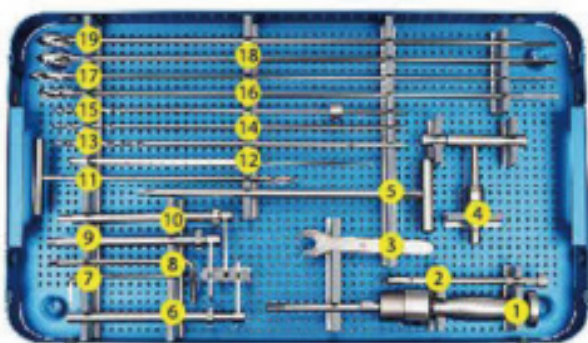

NO	REF	DESCRIPTION
1	PC1200-0301	Universal Joint
2	PC1200-0302	Distal Positioning Frame
3	PC1200-0303	Open Wrench
4	PC1200-0304	Quick Coupling T-Handle
5	PC1200-0305	Screwdriver
6	PC1200-0306	Drill Sleeve
7	PC1200-0307	Hex Wrench
8	PC1200-0308	Hex Wrench
9	PC1200-0309	Drill Sleeve
10	PC1200-0310	Drill Sleeve
11	PC1200-0311	T-handle Drill Bit
12	PC1200-0312	Depth Gague 10-100mm
13	PC1200-0313	Drill Bit 5.2*300mm
14	PC1200-0314	Drill Bit Ø4.0*300
15	PC1200-0315	Drill Bit with Limitor Ø4.0*300
16	PC1200-0316	Reamer 10mm
17	PC1200-0317	Reamer 11mm
18	PC1200-0318	Reamer 12mm
19	PC1200-0319	Reamer 13mm
20	PC1200-0320	AWL
21	PC1200-0321	Guide Wire
22	PC1200-0322	Hammer
23	PC1200-0323	Guide Rod
24	PC1200-0324	Connctor Rod
25	PC1200-0325	Nail Connector
26	PC1200-0326	Location Rod
27	PC1200-0327	Sighting Device Handle
28	PC1200-0328	Bolt
29	PC1200-0329	Bolt
30	PC1200-0330	Bolt
31	PC1200-0331	Bolt
32	PC1200-0332	Fixed Connector
33	PC1200-0333	Location Forcep
34	PC1200-0334	Connector
35	PC1200-0335	Distal Guider
36	PC1200-0336	Aluminium Box

ELASTIC NAIL INSTRUMENT SET

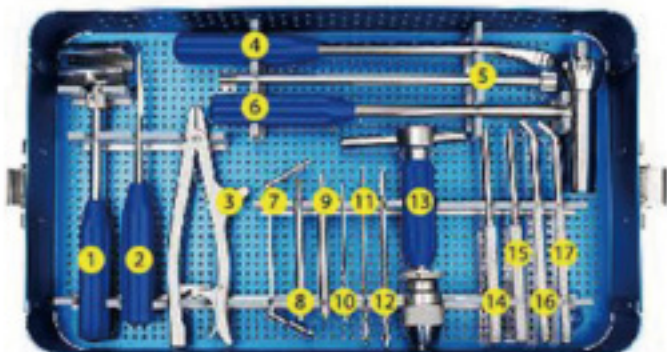
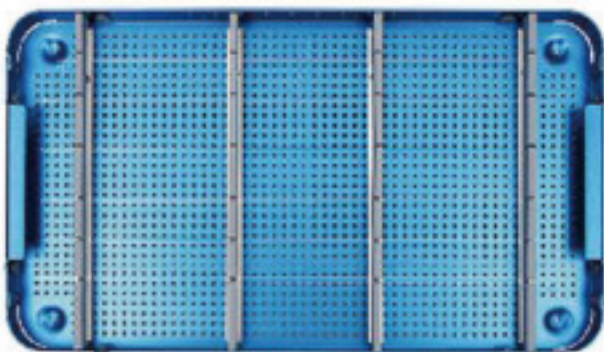

NO	REF	DESCRIPTION
1	PC1200-0601	Hammer
2	PC1200-0602	AWL
3	PC1200-0603	Locking Pliers
4	PC1200-0604	Wrench
5	PC1200-0605	Hammer Guider
6	PC1200-0606	Cutter
7	PC1200-0607	Double Drill Sleeve 3.2/4.5mm
8	PC1200-0608	End Cup Inserter Small
9	PC1200-0609	End Cup Inserter Large
10	PC1200-0610	Drill Bit 42.7*115mm
11	PC1200-0611	Drill Bit 43.2*150mm
12	PC1200-0612	Drill Bit 44.5*150mm
13	PC1200-0613	Elastic Nail Inserter
14	PC1200-0614	Standard Tamp
15	PC1200-0615	Standard Tamp
16	PC1200-0616	Bender
17	PC1200-0617	Bender
18	PC1200-0618	Aluminium Box



**REVERSED FEMORAL & GAMA INTRAMEDULLARY NAIL INSTRUMENT SET**

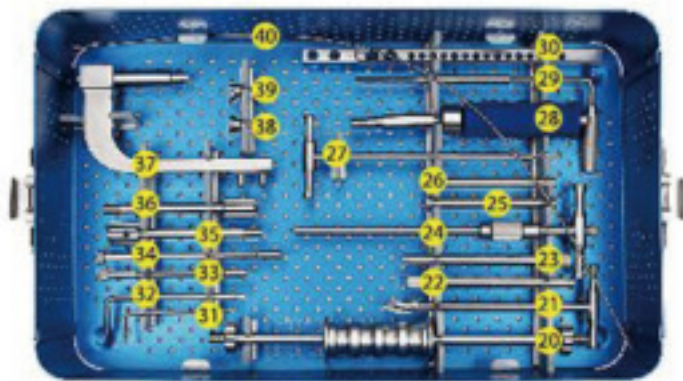
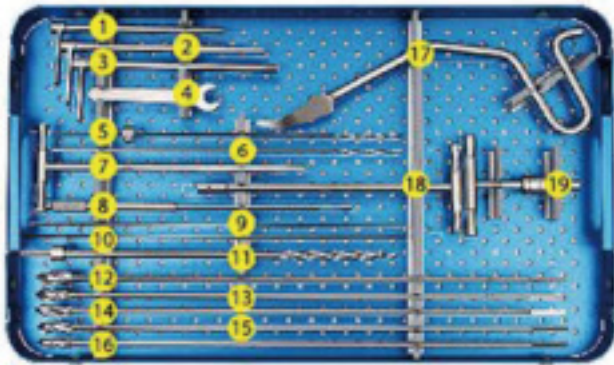

NO	REF	DESCRIPTION
1	PC1200-0401	Drill Sleeve
2	PC1200-0402	Drill Sleeve
3	PC1200-0403	Drill Sleeve
4	PC1200-0404	Open Wrench
5	PC1200-0405	Drill Bit Ø4.5 with Stopper
6	PC1200-0406	Drill Bit Ø4.5
7	PC1200-0407	Hex Screwdriver SW3.5
8	PC1200-0408	Depth Gague 0-90mm
9	PC1200-0409	K-wire
10	PC1200-0410	Threaded K-wire
11	PC1200-0411	Drill Bit
12	PC1200-0412	Solid Reamer Ø9
13	PC1200-0413	Solid Reamer Ø10
14	PC1200-0414	Solid Reamer Ø11
15	PC1200-0415	Solid Reamer Ø12
16	PC1200-0416	Solid Reamer Ø13
17	PC1200-0417	AWL
18	PC1200-0418	Wrench
19	PC1200-0419	Quick Coupling T-handle
20	PC1200-0420	Hammer
21	PC1200-0421	T-handle Solid Reamer
22	PC1200-0422	Sleeve
23	PC1200-0423	Sleeve
24	PC1200-0424	Location Forcep
25	PC1200-0425	Sleeve
26	PC1200-0426	Sleeve
27	PC1200-0427	Tap
28	PC1200-0428	Unversal Joint
29	PC1200-0429	Location Forcep
30	PC1200-0430	Guider Bar
31	PC1200-0431	Hex Key Large
32	PC1200-0432	Hex Key Small
33	PC1200-0433	Forcing Cone Short
34	PC1200-0434	Forcing Cone Long
35	PC1200-0435	Connector
36	PC1200-0436	Connector
37	PC1200-0437	Guider Handle
38	PC1200-0438	Bolt
39	PC1200-0439	Bolt
40	PC1200-0440	Guider Wire
41	PC1200-0441	Aluminium Box

FEMORAL INTRAMEDULLARY NAIL & FEMORAL RECONSTRUCTION INT NAIL INSTRUMENT SET

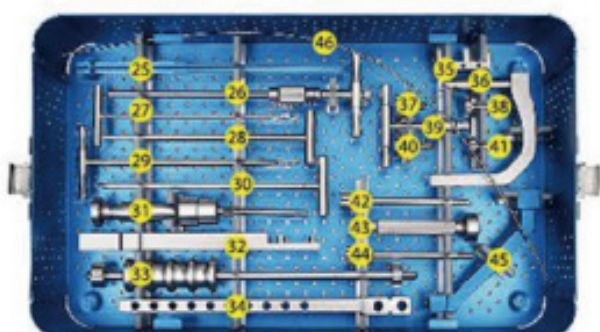
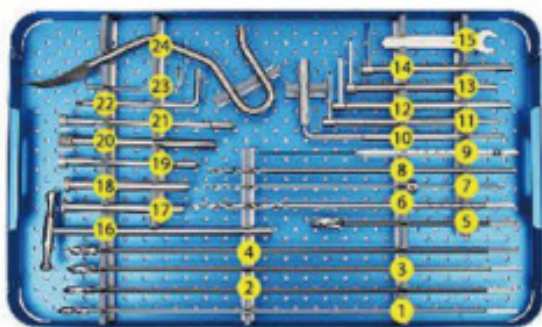

NO	REF	DESCRIPTION
1	PC1200-0501	Solid Reamer Ø11
2	PC1200-0502	Solid Reamer Ø12
3	PC1200-0503	Solid Reamer Ø12.5
4	PC1200-0504	Solid Reamer Ø13
5	PC1200-0505	Solid Reamer Ø10.4
6	PC1200-0506	Drill Bit
7	PC1200-0507	Drill Bit With Liminator
8	PC1200-0508	Drill Bit
9	PC1200-0509	Depth Gauge
10	PC1200-0510	Location Forcep
11	PC1200-0511	Drill Sleeve
12	PC1200-0512	Drill Sleeve
13	PC1200-0513	Drill Sleeve
14	PC1200-0514	Drill Sleeve
15	PC1200-0515	Open Wrench
16	PC1200-0516	T-handle Wrench
17	PC1200-0517	Sleeve
18	PC1200-0518	Sleeve
19	PC1200-0519	Forcing Cone Short
20	PC1200-0520	Sleeve
21	PC1200-0521	Forcing Cone Long
22	PC1200-0522	Hex Key Large
23	PC1200-0523	Hex Key Small
24	PC1200-0524	AWL
25	PC1200-0525	K-wire Depth Gauge
26	PC1200-0526	Location Forcep
27	PC1200-0527	T-handle Drill Bit
28	PC1200-0528	Location Rod
29	PC1200-0529	Tap
30	PC1200-0530	T-handle Screwdriver
31	PC1200-0531	Unversal Joint
32	PC1200-0532	Connctor Rod
33	PC1200-0533	Hammer
34	PC1200-0534	Guider Bar
35	PC1200-0535	Fixed Connector
36	PC1200-0536	Guider Handle
37	PC1200-0537	Bolt
38	PC1200-0538	Bolt
39	PC1200-0539	Quick Coupling T-handle
40	PC1200-0540	Bolt
41	PC1200-0541	Bolt
42	PC1200-0542	Connector
43	PC1200-0543	Connector
44	PC1200-0544	Connector
45	PC1200-0545	Distal Guider
46	PC1200-0546	Guide Wire
47	PC1200-0547	Aluminium Box

**PFNA NAIL INSTRUMENT SET**

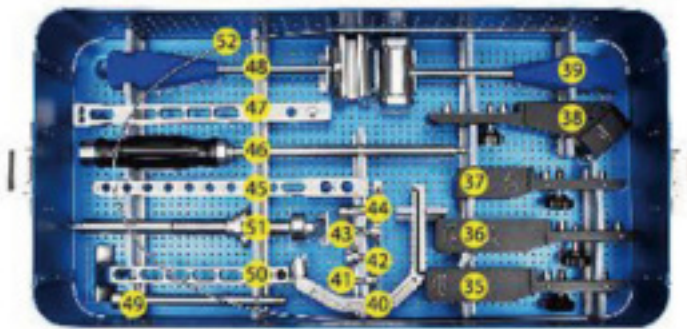
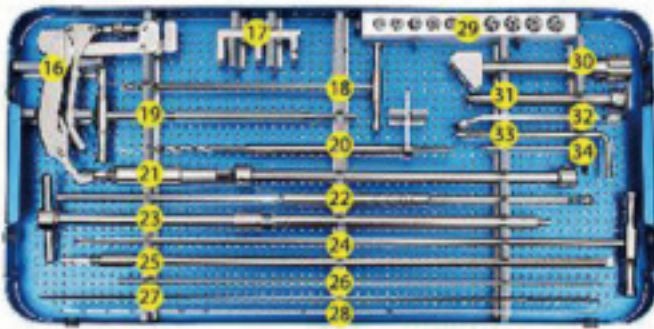
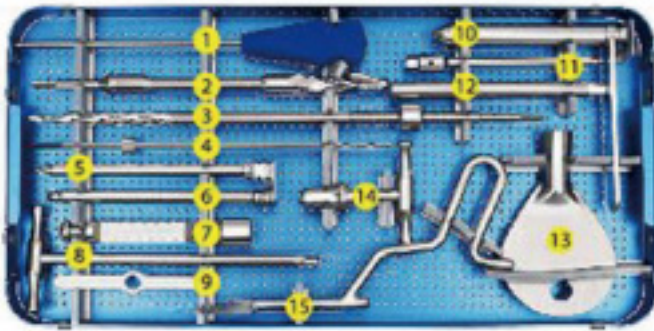

NO	REF	DESCRIPTION
1	PC1200-0701	Screwdriver Hex SW2.5
2	PC1200-0702	Proximal Hollow Drill
3	PC1200-0703	Proximal Hollow Position Stopper
4	PC1200-0704	Drill Bit Ø4.3
5	PC1200-0705	Drill Sleeve
6	PC1200-0706	Drill Sleeve
7	PC1200-0707	Depth Gague 70-120mm
8	PC1200-0708	Nut Screwdriver
9	PC1200-0709	Wrench
10	PC1200-0710	Guider Sleeve
11	PC1200-0711	Cannulated Screwdriver
12	PC1200-0712	Tail Cannulated Screwdriver
13	PC1200-0713	Tissue Protection Plate
14	PC1200-0714	Quick Coupling T-handle
15	PC1200-0715	AWL
16	PC1200-0716	Guider Wire Holder
17	PC1200-0717	Distal Position Lock
18	PC1200-0718	Position Drill
19	PC1200-0719	Position Rod
20	PC1200-0720	Position Drill Bit
21	PC1200-0721	Nail Removal Rod
22	PC1200-0722	Depth Gague 0-100mm
23	PC1200-0723	Blade Screw Device
24	PC1200-0724	Reduction Rod
25	PC1200-0725	Flexible Reamer Bar
26	PC1200-0726	Threaded K-Wire
27	PC1200-0727	End Cap Guider
28	PC1200-0728	Template for Development
29	PC1200-0729	Reamer Head 8.5-13mm
30	PC1200-0730	Main Pin Impactor
31	PC1200-0731	Drill Sleeve
32	PC1200-0732	Open Wrench
33	PC1200-0733	Hex Key Large
34	PC1200-0734	Hex Key Small
35	PC1200-0735	Distal Guider Device 180
36	PC1200-0736	Distal Guider Device 90° 180/240
37	PC1200-0737	Distal Guider Device 240
38	PC1200-0738	Proximal Guider Device
39	PC1200-0739	Hammer
40	PC1200-0740	Handle
41	PC1200-0741	Bolt
42	PC1200-0742	Bolt
43	PC1200-0743	Bolt
44	PC1200-0744	Bolt
45	PC1200-0745	Long Nail Distal Guider Bar
46	PC1200-0746	Saw Blade Screwdriver
47	PC1200-0747	Long Nail Distal Guider Bar
48	PC1200-0748	Slide Hammer
49	PC1200-0749	Connector
50	PC1200-0750	Long Nail Distal Screw Location Device
51	PC1200-0751	Guider Sleeve
52	PC1200-0752	Olive Guide Wire
53	PC1200-0753	Aluminium Box

**FLEXIBLE REAMER STRYKER, FIXED TYPE**

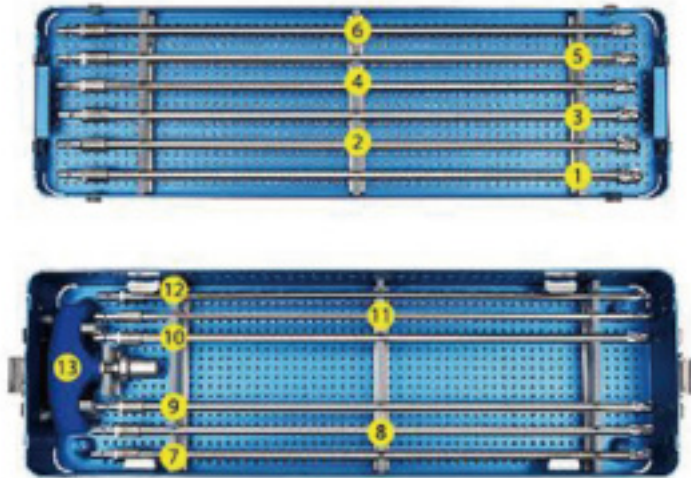

NO	REF	DESCRIPTION
1	PC1200-1101	Reamer Ø7.5
2	PC1200-1102	Reamer Ø8
3	PC1200-1103	Reamer Ø8.5
4	PC1200-1104	Reamer Ø9
5	PC1200-1105	Reamer Ø9.5
6	PC1200-1106	Reamer Ø10
7	PC1200-1107	Reamer Ø10.5
8	PC1200-1108	Reamer Ø11
9	PC1200-1109	Reamer Ø11.5
10	PC1200-1110	Reamer Ø12
11	PC1200-1111	Reamer Ø12.5
12	PC1200-1112	Reamer Ø13
13	PC1200-1113	Quick Coupling T-Handle
14	PC1200-1114	Aluminium Box

**OLIVE GUIDE WIRE**



REF	DESCRIPTION
PC1200-1115	Ø2.5*1 Length

**INTRAMEDULLARY NAIL REMOVAL SET**

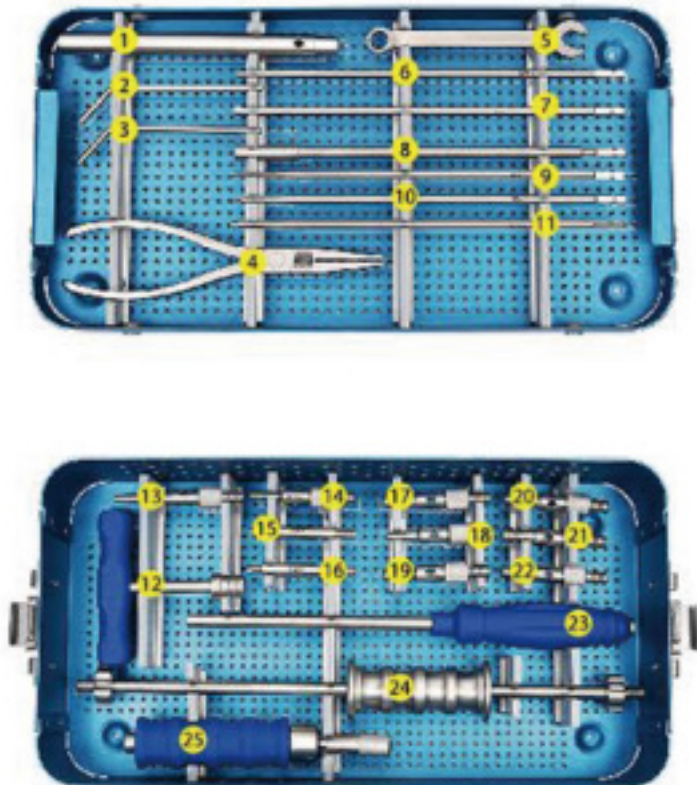

NO	REF	DESCRIPTION
1	PC1200-1201	End Cap Wrench 180mm
2	PC1200-1202	Wrench
3	PC1200-1203	Wrench
4	PC1200-1204	Wire Cutter
5	PC1200-1205	Open Wrench
6	PC1200-1206	Hex Screwdriver SW4.5
7	PC1200-1207	Hex Screwdriver SW5.0
8	PC1200-1208	Locking Screw Extractor 250mm
9	PC1200-1209	Hex Screwdriver SW2.5
10	PC1200-1210	Hex Screwdriver SW3.5
11	PC1200-1211	Hex Screwdriver SW4.0
12	PC1200-1212	Quick Coupling T-handle
13	PC1200-1213	Extractor Chuck Universal Large
14	PC1200-1214	Extractor Chuck M6
15	PC1200-1215	Extractor Chuck SW4.0
16	PC1200-1216	Extractor Chuck SW4.5
17	PC1200-1217	Extractor Chuck M10*1
18	PC1200-1218	Extractor Chuck M8*1
19	PC1200-1219	Extractor Chuck M8
20	PC1200-1220	Extractor Chuck Universal Small
21	PC1200-1221	Extractor Chuck M11
22	PC1200-1222	Extractor Chuck M10
23	PC1200-1223	Saw Blade Screwdriver
24	PC1200-1224	Hammer
25	PC1200-1225	Universal Joint
26	PC1200-1226	Aluminium Box



**SMALL FRAGMENT EXTERNAL FIXATOR INSTRUMENT SET**

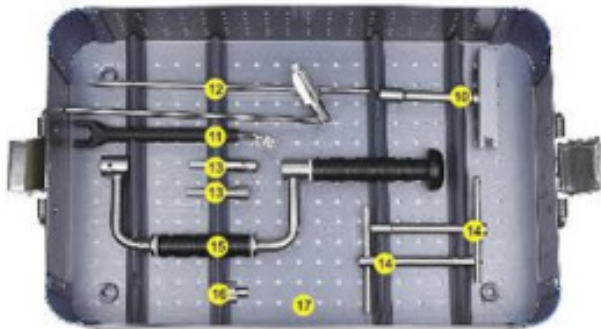

NO	REF	DESCRIPTION	SPECIFICATION
1	PC7100-0101	Rod To Rod Coupling	Φ5/5
2	PC7100-0102	Pin To Rod Coupling	Φ5/3-4
3	PC7100-0103	4-hole Pin Clamp	Φ5/3-4
4	PC7100-0104	Perl-articular Pin Clamp	Φ3/4
5	PC7100-0105	Post	Φ5/0°
6	PC7100-0106	Post	Φ5/30°
7	PC7100-0107	Apex Pin Self-drilling	HA 3.0x80
7	PC7100-0108		HA 3.0x100
7	PC7100-0109		HA 4.0x80
7	PC7100-0110		HA 4.0x100
7	PC7100-0111		HA 4.0x120
8	PC7100-0112	Drill Sleeves	Φ3
8	PC7100-0113		Φ4
9	PC7100-0114	Carbon Fiber Connecting Rod	Φ5x120
9	PC7100-0115		Φ5x150
9	PC7100-0116		Φ5x180
9	PC7100-0117		Φ5x200
10	PC7100-0118	T Wrench	#5
11	PC7100-0119	Stabilization/Reduction Wrench	#5
12	PC7100-0120	Elbow Joint Movement Device	Φ5
13	PC7100-0121	Apex Pin Chuck	Φ3
13	PC7100-0122		Φ4
14	PC7100-0123	T-shaped Pin Wrench	Φ3
14	PC7100-0124	T-shaped Pin Wrench	Φ4
15	PC7100-0125	Hand Drill	
16	PC7100-0126	Thumb Wheel	#5/7
17	PC7100-0127	Aluminum Box	

**LARGE FRAGMENT EXTERNAL FIXATOR INSTRUMENT SET**

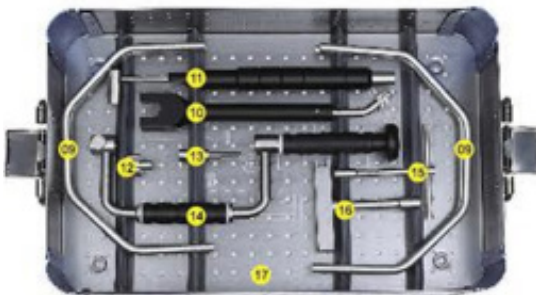

NO	REF	DESCRIPTION	SPECIFICATION
1	PC7100-0201	Rod To Rod Coupling	Φ8/8
2	PC7100-0202	Pin To Rod Coupling	Φ8/5-6
3	PC7100-0203	5-hole Pin Clamp	Φ8/5-6
4	PC7100-0204	Post	08/0
5	PC7100-0205	Post	Φ8/30°
6	PC7100-0206	Apex Pin Self-drilling	HA 5.0x120
6	PC7100-0207		HA 5.0x150
6	PC7100-0208		HA 5.0x180
7	PC7100-0209	Drill Sleeve	Φ5
8	PC7100-0210	Carbon Fiber Connecting Rod	Φ8x200
8	PC7100-0211		Φ8x250
8	PC7100-0212		Φ8x300
9	PC7100-0213	Semi-circular Curved Rod	Φ8 180
9	PC7100-0214		Φ8/ 200
10	PC7100-0215	Stabilization/Reduction Wrench	#7
11	PC7100-0216	Torque Wrench	Φ7
12	PC7100-0217	Thumb Wheel	#5/7
13	PC7100-0218	Apex Pin Chuck	Φ5
14	PC7100-0219	Hand Drill	
15	PC7100-0220	T-shaped Pin Wrench	Φ5
16	PC7100-0221	T Wrench	#7
17	PC7100-0222	Aluminum Box	

YESİLDERE MAHALLESİ 511 SOKAK NO:7/5  
ATAKUM, SAMSUN - TURKEY



+90 533 018 12 84



export@pluscaremed.com



info@pluscaremed.com



SCAN THE QR  
CODE TO VISIT



**PLUSCAREMED**  
MEDICAL DEVICES