



JIGSAW ®  
The kitchen puzzle made simple

# WELCOME TO JIGSAW

*Everything in one place*

A new kitchen is a major investment and isn't something you buy every day. At Jigsaw we place your kitchen and decisions into manageable pieces and will guide you through a vast array of options to make your dream kitchen a reality. Jigsaw helps you connect aspirational design with functional practicality, so take your time and explore a world of options.

---

## PLANNING YOUR KITCHEN

- 9. Consider Your Layout
- 11. Design Ideas
- 13. Cabinet Choices
- 15. Choosing Your Door Design
- 20. The Jigsaw Kitchen Colour Palette
- 22. Paint to Order Colour Palette

---

## CHOOSING YOUR KITCHEN

- 25. Contemporary Kitchens
  - 27. *The Lucente Range*
  - 55. *The Vivo+ Range*
  - 85. *The Vivo+ True Handleless Range*
  - 109. *The Stratto True Handleless Range*
  - 113. *The Linear Range*
  - 121. *The Linear True Handleless Range*
- 123. Classic Contemporary Kitchens
  - 125. *The Ascot Range*
  - 133. *The Newmarket Range*
  - 149. *The Oxford Range*
  - 159. *The Stratto Range*
- 169. Classic Kitchens
  - 171. *The Cartmel Range*
  - 195. *The Cambridge Range*
  - 213. *The Windsor Range*

---

## SMART STORAGE

- 223. Smart Larder
- 225. Waste Storage
- 227. Wirework

---

## FINAL PIECES

- 235. Handles
- 241. Sinks
- 245. Taps
- 249. Lighting
- 251. Cutlery Trays

# JIGSAW, THE BRAND YOU CAN TRUST

We've spent years developing a product range to give you confidence in your choice. From sourcing environmentally responsible timber products, to guarantees and product design here in the UK, you know that every detail of a Jigsaw kitchen has been carefully considered.



## WARRANTY

Jigsaw offers a 10 year guarantee against manufacturing defects so you can be assured of a quality product.



## BRITISH DESIGN

Jigsaw's product range and plethora of combination options is designed in the UK, ensuring our product meets the needs and requirements of our retailers and their consumers.



## OVER 30 YEARS EXPERIENCE

The business behind the Jigsaw brand has been established for over 30 years meaning we're here today and tomorrow.



## QUALITY

Jigsaw is FIRA Gold certified assuring you of product of the highest quality. FIRA is an independent association for furniture product in the UK.



## ETHICAL

Jigsaw product is also FSC certified confirming responsible product sourcing as well as outstanding quality. Don't compromise!





# SEE HOW WE COMPARE TO OTHER MARKET OPTIONS:

	Jigsaw Kitchen Doors	Other Kitchen Doors
DOOR THICKNESS	18-22mm	16-22mm
MAIN MATERIALS USED	MDF or Real Timber	Chipboard / MDF / Real Timber
SOFT CLOSE OPTION	Included as standard	Upgrade option / included as standard
J PULL DRILLING OPTIONS	To suit your door	Double drilled leaving unsightly holes
DOOR FINISHES	Majority Painted	Foil/PVC wrapped, cut & edged or painted
COLOUR MATCHING REVERSE	Included as standard	Only in some ranges

*Avoid peeling & bubbling with painted finishes.*

	Jigsaw Kitchen Cabinets	Other Kitchen Cabinets
BASE UNIT BACK PANEL THICKNESS	Rigid 18mm	Flimsy 3mm-18mm
EDGING	2mm PVC	Nothing / Tape / 0.8mm
CABINET THICKNESS	18mm	15-18mm
CROSS RAIL OPTION	100mm cross rail included	50mm -100mm

*Find out more about what these details mean on page: 167*



FOUND  
YOUR  
DREAM  
COLOUR?  
**WE CAN  
MATCH THAT.**

Know what colour you want but can't find it anywhere?  
**Take advantage of our bespoke colour matching service!**  
Choose any colour you like - available in the majority of our door  
ranges, ask your retailer for more details.



Planning Your

# KITCHEN

Let us show you typical kitchen shapes to guide you, then the rest is up to you. What are your must haves and why are you buying a new kitchen? Take inspiration from our suggestions and ensure you've got everything covered.

# CONSIDER YOUR LAYOUT

Your Jigsaw kitchen will be highly personal as you piece together everything we have to create your own look. The first step though is confirming your layout and understanding which works best for your home. We've illustrated the most common styles for you found within the UK, but if you're lucky enough to have a completely blank canvas then enjoy creating your own!

## LINEAR

Used for compact kitchens, combine with clever storage solutions to maximise the space.

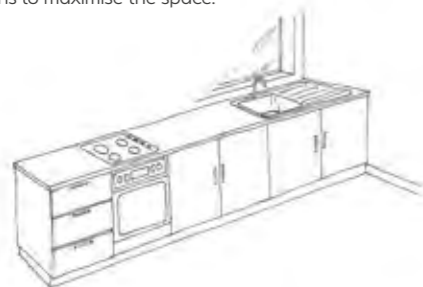

## L-SHAPE

The most common kitchen layout, leaving space to move around and possibly enough space for a dining table.



## GALLEY

Works best for long narrow kitchens with everything within easy reach.



## U-SHAPE

Great for lots of storage space, use pull out corner units for easy access to all your pots and pans.



## G-SHAPE

Get additional storage and worktop space with a G-shaped kitchen, also ideal for creating a social centre point.



## ISLAND

This desirable layout works well with large open plan kitchens, creating a flexible and social working space.



## Room Considerations:

### ROOM DIMENSIONS

- Walls, inc. exterior ones
- Height of room
- Boiler & radiators
- Windows & doors, inc. frame and which way they open

### THE DETAILS

- Location of sockets
- Waste pipes
- Air Vents
- Gas pipes

### APPLIANCES

- Integrated / free standing
- Any existing appliances

# DESIGN IDEAS

*The devil's in the detail!*

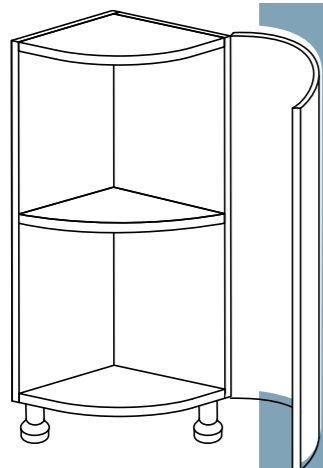

## Consider curves to create a bespoke look.

Curved kitchen design adds a different aesthetic to more traditional straight lines. Tall external curves create a feature area and can now be created in many ranges.

### Available as:

- Base units
- Wall units
- Tall units



## Take full advantage of full height larder doors.

Enhance a minimalist design with the inclusion of full height larder doors. Equally as impressive in either a straight run of larders or in framing ornate design.

### Available in:

- Lucente
- Vivo+
- Linear
- Stratto



*Shhh...*

All of our doors and drawers come with soft close as standard

## Understanding drawers.

Drawers are an increasingly important part of the kitchen offering style and easy access. Jigsaw provides a multitude of sizes and configurations which are easily explained below:

### DRAWER CONFIGURATIONS

What drawer combination you choose might depend on how much space you've got available, what design you're after, or what you want to store in them. For example...

- Cutlery
- Utensils
- Cookware
- Plates and bowls
- Food
- Kitchen towels
- Cleaning products

### POPULAR DRAWER CONFIGURATIONS:

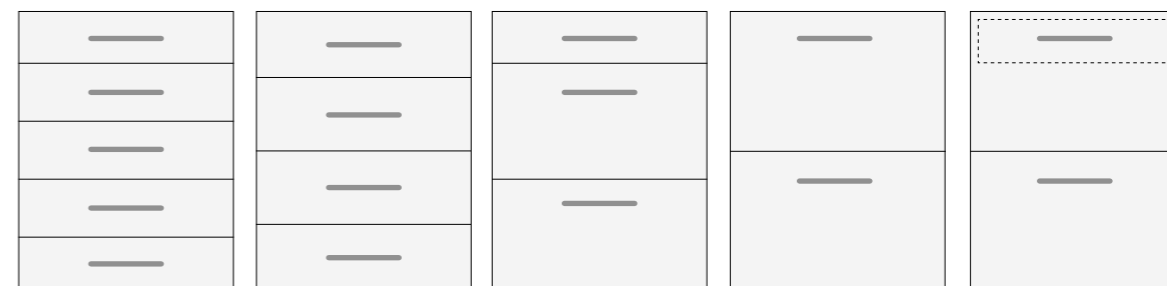

5 shallow drawers

4 shallow drawers

1 shallow + 2 deep drawers

2 deep drawers

1 internal & 2 deep drawers

### INTERNAL DRAWERS

Internal drawers are a great way of achieving a clean and linear look while still providing practical storage and easy access to your cutlery and utensils. The top drawer simply hides inside the deep drawer front, creating an uninterrupted and streamlined kitchen design.





Choose strength and durability for peace of mind.

# CABINET CHOICES

Cabinets are the foundation of a kitchen with multiple sizes and shapes now available to navigate around any room. We have 5 matt colours\* available meaning you can choose to co-ordinate or contrast with your door choice.



\*Oak not available for true handleless



## What makes our cabinets extra special?

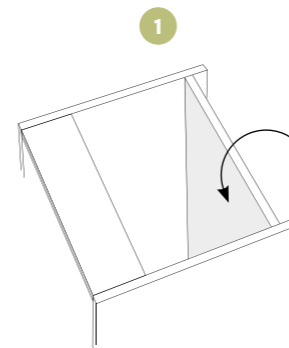

18mm back panel for added rigidity on base units means you don't need to worry about your cookware damaging the backs!

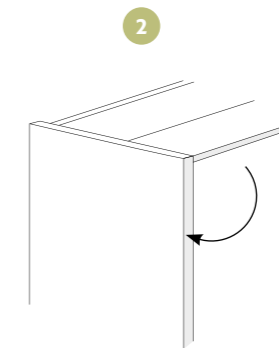

2mm PVC on leading edges prevents moisture from getting into the cabinet structure and causing damage.

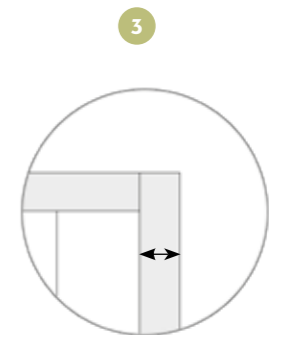

Be assured of lasting quality with our 18mm thick cabinets as standard.

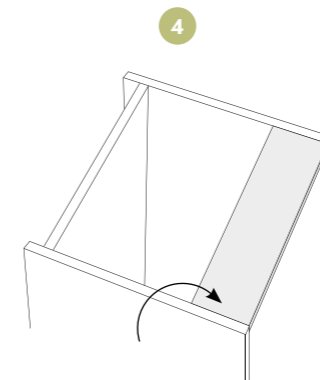

Unlike some other cabinets, our cabinets come with a 100mm cross rail to add further stability.

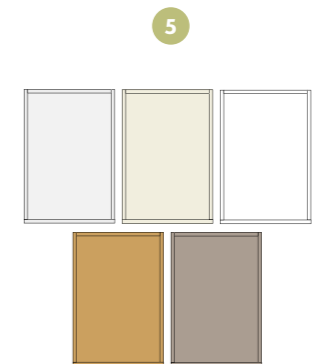

We have 5 colours to choose from to complement our vast array of doors.

# NEED HELP CHOOSING A DOOR DESIGN?

*Paint to order (PTO) lets you choose any colour you like!*

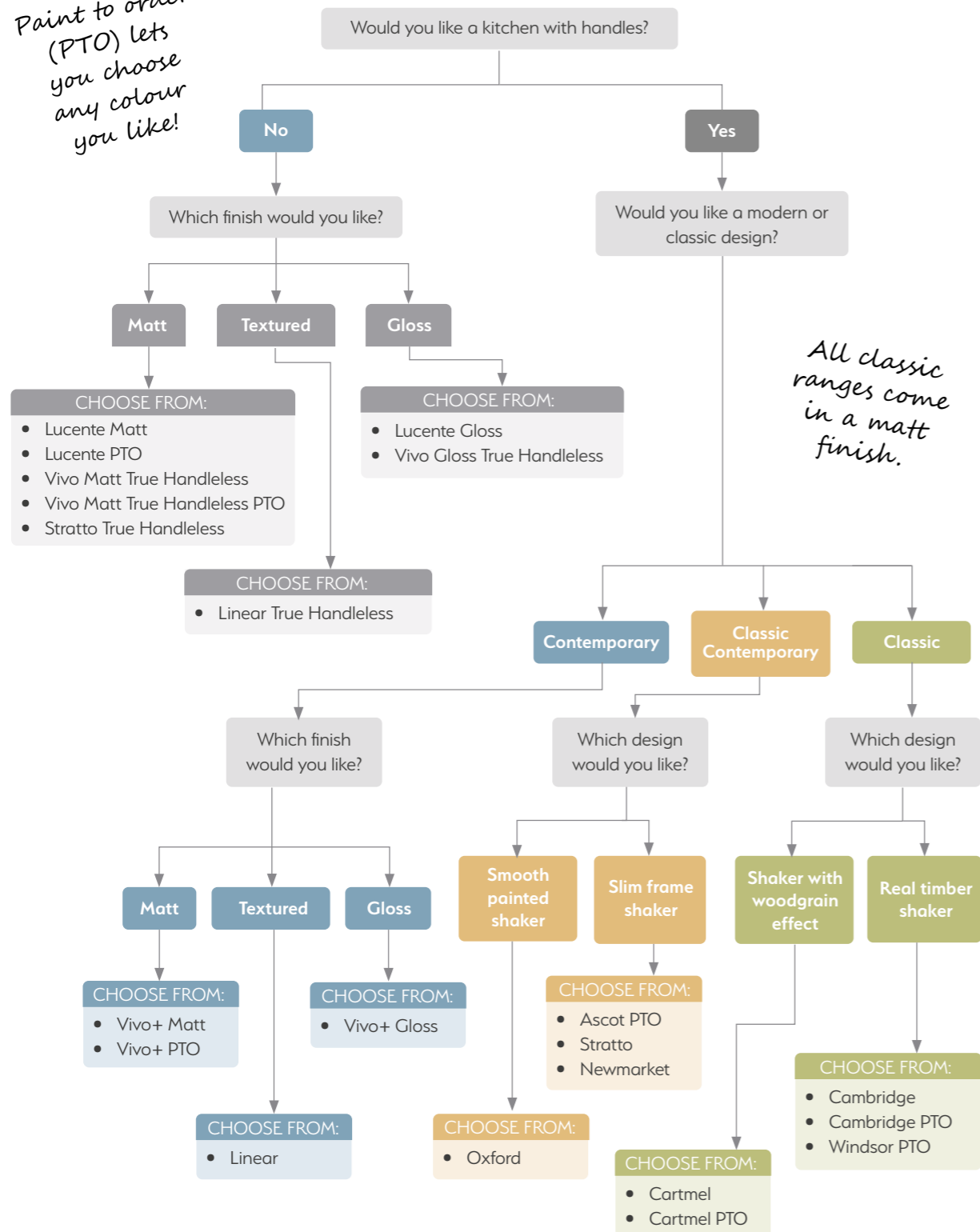

*All classic ranges come in a matt finish.*

*Choose your style and colour, it's that simple!*



## Contemporary Handleless Designs...



### LUCENTE

Lucente's J Pull design is available in a painted smooth finish in both gloss & matt options.

### VIVO TRUE HANDLELESS

Vivo true handleless slab design is available in both gloss and matt finishes, with 3 rail colour options to choose from.

### LINEAR TRUE HANDLELESS

Linear true handleless real feel textured slab design is available in 6 textured decors, with 3 rail colour options to choose from.

### STRATTO TRUE HANDLELESS

Stratto combines matt finish and narrow frame design in 4 colours with 3 rail colour options.

## Contemporary Slab Designs...

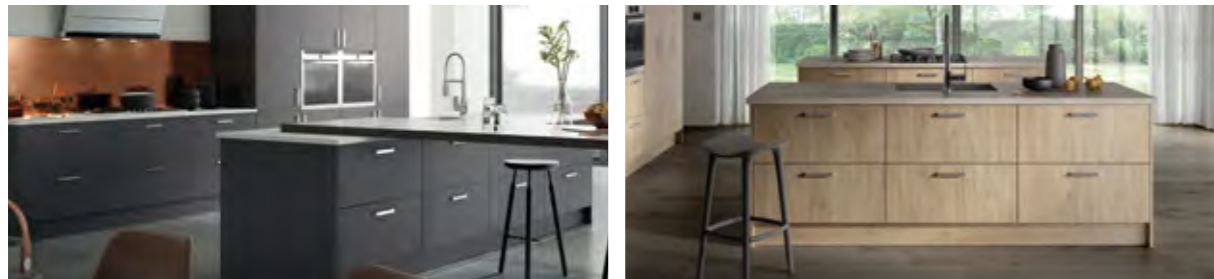

### VIVO+

The Vivo+ slab design is smooth painted and available in gloss and matt finishes.

### LINEAR

The Linear slab design has a real-feel textured finish and is available in 6 options.

## Classic Contemporary Shaker Designs...



### ASCOT

Ascot is our 1 piece slim frame shaker, painted in a matt finish.

### OXFORD

Oxford's eclectic door design bridges the gap between modern and classic. This one piece shaker door is available in a super smooth matt finish.

### STRATTO

Stratto has a smooth matt tactile finish and a narrow frame width to appeal to all ages.

## Classic Contemporary Shaker Designs...



### NEWMARKET

Newmarket offers the natural beauty of real timber with a narrower frame width in 4 painted colours to add fresh perspective on a classic favourite.

## Classic Shaker Designs...



### CARTMEL

Looking for a real alternative to timber? Cartmel is a 5 piece shaker design with woodgrain effect in a matt finish.

### CAMBRIDGE

Cambridge is one of our three real timber options, with a standard frame width and v grooves in a matt painted finish.

### WINDSOR

Windsor is our classic 5 piece real timber shaker with internal beading detail, available as paint to order.

*There's plenty to choose from!*



The Jigsaw Kitchen

# COLOUR PALETTE

*You'll be spoilt for choice!*

	LUCENTE GLOSS	LUCENTE MATT	VIVO TRUE HANDLESS GLOSS	VIVO TRUE HANDLESS MATT	VIVO+ GLOSS	VIVO+ MATT	LINEAR	LINEAR TRUE HANDLESS	OXFORD	ASCOT	STRATTO	STRATTO TRUE HANDLESS	CARTMEL	NEWMARKET	CAMBRIDGE	WINDSOR
White	✓	✓	✓	✓	✓	✓			✓		✓	✓	✓			
Ivory / Cream	✓		✓		✓				✓				✓	✓	✓	
Mussel													✓		✓	
Cashmere	✓	✓	✓	✓	✓	✓							✓			
Sage Green													✓			
Light Grey	✓	✓	✓	✓	✓	✓			✓		✓	✓	✓	✓	✓	
Dust Grey	✓	✓	✓	✓	✓	✓			✓		✓	✓	✓	✓	✓	
Anthracite	✓	✓	✓	✓	✓	✓			✓				✓			
Indigo		✓		✓		✓			✓		✓	✓	✓	✓	✓	
Oak															✓	
6 textured decors (Linear)							✓	✓								
Standard paint to order 23 colours		✓		✓		✓				✓			✓	✓	✓	✓
Bespoke Colours	✓			✓		✓				✓			✓	✓	✓	✓

# PAINT TO ORDER COLOUR CHOICES

We have 23 standard paint to order colours available to choose from, plus our colour matching service - go wild with colour!

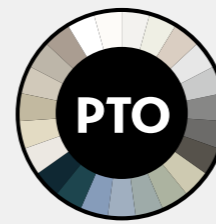

## STANDARD PAINT TO ORDER PALETTE

All of our **MATT FINISH** door ranges excluding the Oxford & Stratto ranges are available as a matt paint to order option, either in one of our standard colours or in any custom colour of your choice. We have categorised our 23 paint to order colours into 4 different tone groups to help you choose the ideal colour for your home:

### Neutral tones:

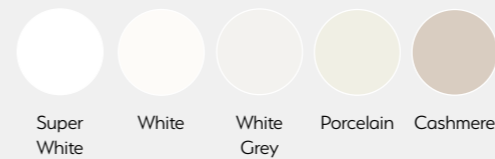

### Grey tones:



### Blue & Green tones:



### Earthy tones:



For a truly unique space choose a custom colour for your kitchen, available in our hand painted ranges. We can match any colour as long as you provide a colour reference to your Jigsaw retailer. The symbol on the right means the door is available in our colour matching service.



PICTURED: CAMBRIDGE FARROW & BALL STUDIO GREEN



## Choosing Your **KITCHEN**

We've placed our vast range of kitchens into 3 categories for you to select from. If you're undecided on which category you fall into, just browse them all!

p.25  
Contemporary

p.123  
Classic  
Contemporary

p.169  
Classic



# CONTEMPORARY KITCHENS

For the latest contemporary kitchens look no further. From the ever popular J pull and slab designs through to true handleless, we've got it covered.

p. 27 Lucente  
p. 55 Vivo+  
p. 85 Vivo True Handleless  
p. 109 Stratto True Handleless  
p. 113 Linear  
p. 121 Linear True Handleless

# THE LUCENTE RANGE



*Minimalist  
styling  
at it's best*



The Lucente style door is hugely popular in the UK but our range for me stands out with all the accessory options. From designer corner posts to 1245mm curves, your Lucente kitchen can stand out from the crowd.

**Gillian Fisher, Head of Product Development**

*Shhh...*  
All of our doors and drawers come  
with soft close as standard





# LUCENTE

## Gloss Handleless

If you want a minimalist, contemporary kitchen with multiple colour choices then you've found it. The Lucente range offers a true 'J' pull handleless door design that results in beautiful clean lines throughout the kitchen. The painted gloss finish, available in 6 colour options provides a consistent sheen and allows door colours to be mixed. Handleless design has been the biggest growing kitchen trend in recent years and we've got it covered!

- ✓ *Painted Gloss finish*
- ✓ *22mm Door Thickness*
- ✓ *Easy grip J pull design*



AVAILABLE COLOURS:



# Lucente Gloss Anthracite

For a strong, bold and striking kitchen, Lucente Gloss Anthracite is an obvious candidate. Minimalist lines across larger banks creates a particularly streamlined look.



*Make a design statement with this bold colour choice*



## Lucente Gloss Light Grey

The cutting edge Lucente door in the highly fashionable tone of light grey makes a kitchen to be proud of. Incorporate simple shelving to create a feature area.

## Lucente Gloss Cream

For a minimalist feel with longevity, look no further than Lucente Gloss Cream. Soften your lines with curved units and use your walls to introduce a feature colour.



### MATRIX BOWL & HALF UNDERMOUNT SINK

The Matrix sink uses the very latest technology to create very precise shapes with almost square radiuses.



*A timeless colour choice for added longevity*

Handleless high gloss



## Lucente Gloss Cashmere

Use curves for a natural sweeping flow to the kitchen. Cashmere is a warmer alternative to white and cream and grows in popularity on an annual basis.

## Lucente Gloss White & Dust Grey

Both White and Dust Grey are highly flexible tones, mixing seamlessly together or equally as adept when used individually. Lucente's designer accessories create flowing lines in a minimalist fashion.



*Our Soldan LED strip lighting helps to make a feature of open shelving.*



Handleless high gloss



# LUCENTE

## Matt Handleless

The handleless matt design will add depth and decadence to any kitchen design. Bring the wow factor to your kitchen with these elegant finishes. Enhanced by its sleek handleless appearance, matt is perfect for any new kitchen design. Choosing this option offers you a high class, superior and sophisticated look that will take you and your guests breath away.

- ✓ *Painted Matt finish*
- ✓ *22mm Door Thickness*
- ✓ *Easy grip J pull design*



AVAILABLE COLOURS:



White

Coshmere

Light Grey

Dust Grey

Anthracite

Indigo



## Lucente Matt White

The simplicity of a matt White finish makes it an ideal choice for Lucente's minimalist design. Maximise your space and practicality with smaller pull out units around your cooking zone.

*Shhh...*

All of our doors and drawers come with soft close as standard

Handleless Matt



## Lucente Matt Cashmere

The growing popularity of Cashmere makes a stunning impact in a matt handleless kitchen. Bi-fold wall units add to the contemporary feeling, providing design lead functionality.



## Lucente Matt Anthracite

The darker tone of Anthracite adds definition to the kitchen with a range of curve sizes adding to the contemporary design.

Handleless Matt



## Lucente Matt Indigo

Blues are in and Indigo takes first place. If you are looking for a super modern option that is the height of fashion then Indigo could be the choice for you. Combine Indigo with white worktops and a Matrix undermount sink to complete the contemporary look.

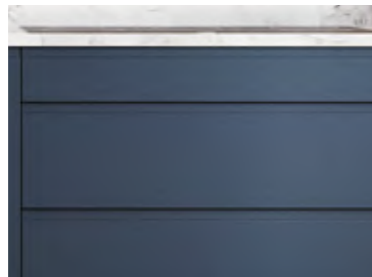

Handleless Matt

# Lucente Matt Dust Grey

Combine the tactile trend of a matt finish with the emerging tone of Dust Grey to create a kitchen very much of the moment. The simplicity of symmetrically designed larders gives an extra added wow factor to this already stunning kitchen.



# Lucente Matt Light Grey

Light Grey is a cool contemporary colour favourite, darker worktops contrast here beautifully for a kitchen with serious impact. Flexible strip lights (pictured left) under cabinets provide ambience and illuminate your worktop for tasks when required.

Handleless Matt



# LUCENTE MATT PAINT TO ORDER

Imagine the minimalist styling of the Lucente door but in any colour you want? That's exactly what you can do with the hand painted range that's shown in our 23 selected colours and our colour match service.



SILVER GREY & LAVA

## STANDARD PAINT TO ORDER PALETTE

Select from a palette of 23 standard colours or choose a colour swatch and let us match it. We have categorised each range into 4 different tone groups, to help you choose the ideal colour for your home:

### Neutral tones:

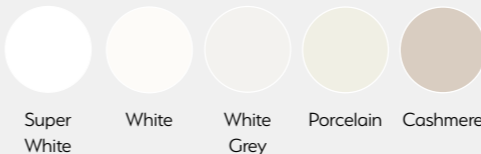

### Grey tones:



### Blue & Green tones:

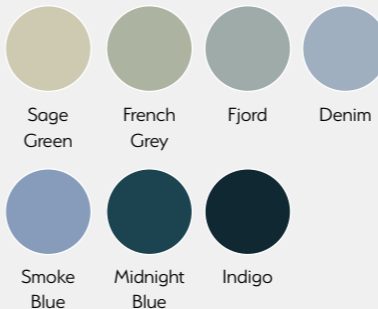

### Earthy tones:



*Be the envy of  
your guests with this  
on trend colour!*

Lucente  
Paint to Order  
Midnight Blue

Midnight blue creates a deep and impactful kitchen that looks wonderfully unique with our tall curved doors.

Handleless Matt



LUCENTE MATT

# BESPOKE COLOURS

If you've got your heart set on a specific colour then Jigsaw is the brand for you. We can colour match to create your dream finish, don't compromise!



# THE VIVO+ RANGE



*Gloss and matt finishes for even more choice*

VIVO MATT INDIGO & ANTIQUE COPPER D LITE HANDLE PICTURED



I love the simplicity of Vivo+ with it's mirror like finish in gloss and tactile finish in matt. The new Indigo tone looks stunning and I'm a big fan of the full height larder doors.

**Emma Money, Range Architect**

*Shhh...*  
All of our doors and drawers come with soft close as standard



# VIVO+

## Gloss Slab Design

What if you could combine a door that was modern, timeless and easy to maintain at the same time? Look no further than the Vivo+ range, one of the most popular in the Jigsaw collection. Choose from a palette of 6 in a painted finish that ensures longevity plays a major part in your new kitchen. Enjoy straight lines, curves or a mixture of both as we've designed across the respective colours shown here.

- ✓ *Painted Gloss finish*
- ✓ *18mm Door Thickness*
- ✓ *High quality materials*



### AVAILABLE COLOURS:

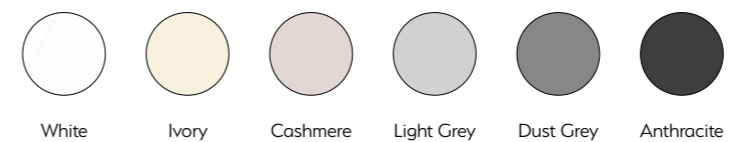

## Vivo+ Gloss White

Clean, crisp and classic, Vivo Gloss White lightens and brightens a kitchen and is almost guaranteed to never date. Bespoke open shelving provides quick access to kitchen essentials and is highly fashionable.

*Shhh...*

All of our doors and drawers come with soft close as standard







*Be unique  
with curves!*



LAPAC HANDLE PICTURED

### Vivo+ Gloss Ivory

Gloss Ivory is a classic colour choice that stands the test of kitchen fashion. It's also ideal for open plan living as you move from the traditional kitchen area to dining and entertainment.

### Vivo+ Gloss Anthracite

Vivo gloss Anthracite provides a darker, more dramatic look that contrasts perfectly with lighter toned rooms. Bi-fold units improve accessibility and functionality.



ROUND END BAR HANDLE PICTURED

Slab High Gloss



## Vivo+ Gloss Cashmere

Increase the feeling of space by designing larger units in a symmetrical fashion with a solid door such as Vivo. Cashmere adds warmth and definition.

HALF MOON BAR HANDLE PICTURED

Slab High Gloss



## Vivo+ Gloss Dust Grey

Dust Grey is the latest shade from the hugely popular grey palette to make it into mainstream kitchens. Choose colour co-ordinated open shelving and cabinets with the Jigsaw stone grey option.

## Vivo+ Gloss Light Grey

Light Grey is without a doubt the colour of the moment and creates a designer aesthetic in the kitchen. Choose contrasting or complementary worktop and wall colours for a unique result.

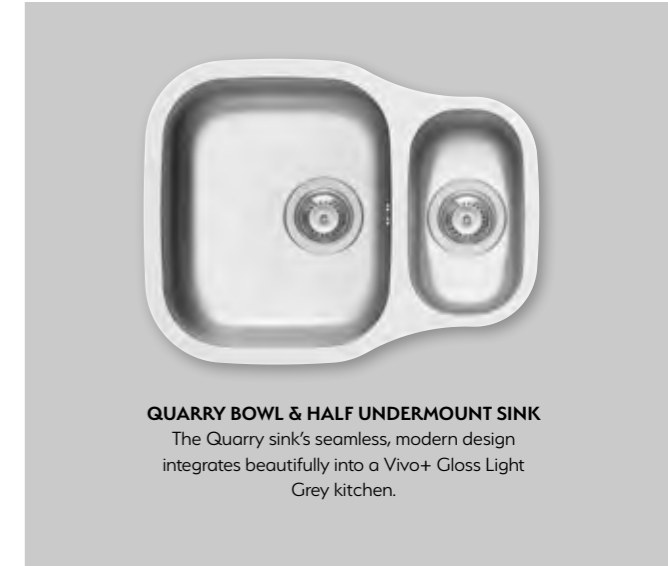

VIVO GLOSS LIGHT GREY & SLIM T BAR HANDLE PICTURED

Slab High Gloss



# VIVO+

## Matt Slab Design

Matt finishes are the flavour of the moment within kitchens and interiors making the Vivo+ Matt collection a natural option for the fashion conscious. The soft matt tone creates a highly tactile door that'll keep you in your kitchen for hours! The colour palette allows the flexibility to mix and match the matt texture with other elements in the kitchen in gloss, woodgrain or metallic finishes, to add design interest or define different zones.

- ✓ *Painted Matt finish*
- ✓ *18mm Door Thickness*
- ✓ *High quality materials*



### AVAILABLE COLOURS:



NEW

*Integrate a  
home work station  
into your kitchen  
design!*

## Vivo+ Matt Indigo

Indigo is ever growing in popularity and pairs beautifully with copper handles. Kitchen furniture is also increasingly being used to create work and social spaces.

D LITE ANTIQUE COPPER HANDLE PICTURED

Slab Smooth Matt

## Vivo+ Matt Light Grey

The subtle tones of Light Grey in a matt finish flow effortlessly around the kitchen. Offsetting different worktops helps to create distinct zones within the kitchen.

*Shhh...*  
All of our doors and drawers come with soft close as standard





WAVE CHROME HANDLE PICTURED

## Vivo+ Matt Cashmere

The growing popularity of Cashmere is also now available in a matt finish, while the tone suits both lighter and darker surrounds. Straight banks of larder and drawer units mirror Germanic styling.

## Vivo+ Matt Dust Grey

Matt Dust Grey oozes contemporary class with the colour of the moment and the smooth tactile nature of the door. Larger cabinet sizes help to create the feeling of increased space.



SLIM BAR HANDLE PICTURED



**BECK CHROME TAP**  
The Beck tap combines flowing curves with twin levers for ease of use. A great complement to the Vivo door.

Slab Smooth Matt

*Shhh...*  
All of our doors and drawers come  
with soft close as standard



## Vivo+ Matt White

White is reinvigorated by a matt finish while the fascia colour can be complemented or contrasted with lighter and darker tones on the floor, wall or with your worktop selection. Use different worktop colours to distinguish different zones in the kitchen.

WAVE CHROME HANDLE PICTURED

Slab Smooth Matt



## Vivo+ Matt Anthracite

Anthracite offers a more striking colour tone in the kitchen which is slightly softened by the smooth matt finish. Large drawers improve access and create the illusion of increased space.



PRECISION HANDLE PICTURED

Slab Smooth Matt



VIVO+ MATT

# PAINT TO ORDER

The Vivo slab door design is hugely popular in the UK and is now available in our paint to order and colour match service. The practicality and longevity of this door style remains but now you can make your kitchen truly unique!



SAGE GREEN & WAVE CHROME HANDLE PICTURED

## STANDARD PAINT TO ORDER PALETTE

Select from a palette of 23 standard colours or choose a colour swatch and let us match it. We have categorised each range into 4 different tone groups, to help you choose the ideal colour for your home:

### Neutral tones:

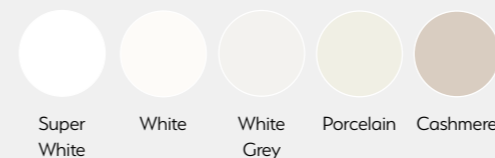

### Grey tones:



### Blue & Green tones:



### Earthy tones:





Vivo+ Matt Onyx Grey  
Paint to Order

Onyx grey creates a kitchen with definition while simple linear design creates a pleasing aesthetic.

D LITE CHROME HANDLE PICTURED

Slab Matt



# VIVO+ MATT BESPOKE COLOURS

If you've got your heart set on a specific colour then Jigsaw is the brand for you.  
We can colour match to create your dream finish, don't compromise!



# THE VIVO+ TRUE HANDLELESS RANGE



I love the new rail colours that add an even more on trend feel to the ultimate contemporary kitchen and if you love straight lines, this is the range for you.

**Andrew Cash, Chief Product Officer**

*Shhh...*

All of our doors and drawers come with soft close as standard

## Vivo+ Gloss True Handleless Anthracite

The dark hue of anthracite contrasts beautifully with the silver rail to create a striking look. Symmetrical design is particularly effective with this range.



- ✓ Painted Gloss finish
- ✓ 18mm Door Thickness
- ✓ High Quality Materials



Vivo+ Gloss True Handleless White

# VIVO+ TRUE HANDLELESS

## Gloss Handleless Slab Design

True handleless kitchens are a growing trend, reflected in the increased choice across the Jigsaw brand. Pair one of 6 gloss doors with 3 of our rail colours and create a minimalist look to be proud of.

### AVAILABLE RAIL COLOURS:

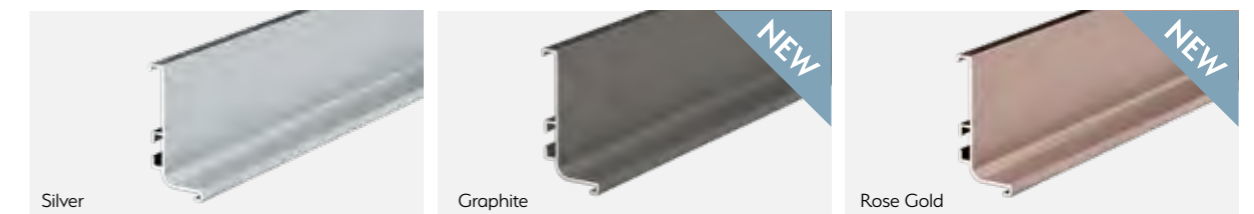

### AVAILABLE DOOR COLOURS:



Vivo+ Gloss  
True Handleless  
Light Grey

Light grey is hugely popular as a contemporary neutral colour and is highly versatile with different floor and wall finishes and textures.

True Handleless Gloss

# Vivo+ Gloss True Handleless White & Cashmere

Why not create a two tone true handleless kitchen as shown here. The new rose gold rail complements both the white and cashmere door beautifully.



True Handleless Gloss





## Vivo+ Gloss True Handleless Ivory

Ivory is a well established colour within the kitchen palette and is an ageless choice for your new kitchen. The classic silver rail is the best foil to the ivory door.

## Vivo+ Gloss True Handleless Dust Grey

The mid tone of dust grey is perfect for those wanting a fascia with definition without domination. An undermount sink within a true handleless kitchen enhances the minimalist aesthetic.

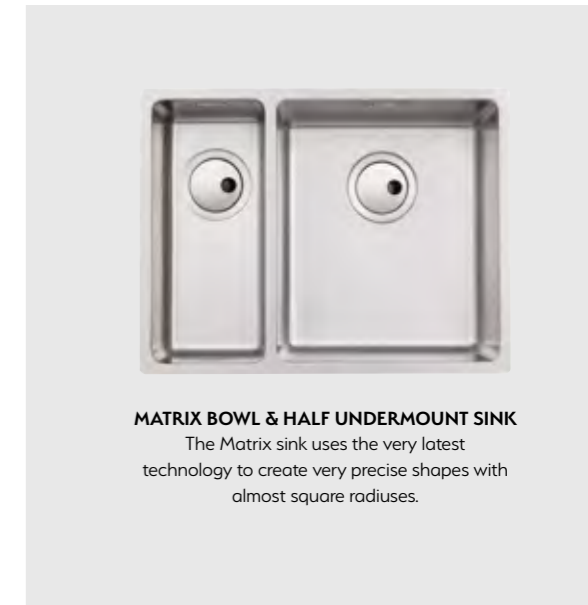

**MATRIX BOWL & HALF UNDERMOUNT SINK**  
The Matrix sink uses the very latest technology to create very precise shapes with almost square radiuses.



True Handleless Gloss

## Vivo+ Matt True Handleless Dust Grey

Dust grey in a tactile smooth matt finish is complemented beautifully by our new darker graphite rail. Create a kitchen that oozes class with this perfect pair.



- ✓ Painted Matt finish
- ✓ 18mm Door Thickness
- ✓ High Quality Materials



Vivo+ Matt True Handleless White

# VIVO+ TRUE HANDLELESS

## Matt Handleless Slab Design

Make the most of two kitchen fashions with a matt finish on a true handleless kitchen. Choose from a palette of 6 colours with indigo the latest addition.

### AVAILABLE RAIL COLOURS:

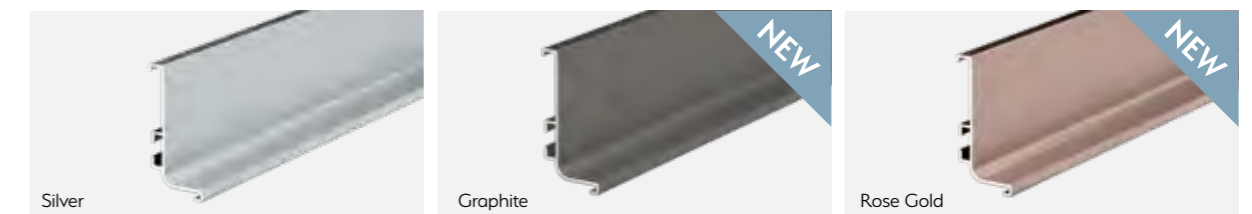

### AVAILABLE DOOR COLOURS:



# Vivo+ Matt True Handleless Light Grey & Anthracite

Combine 2 shades of grey to truly stunning effect with light grey and anthracite. 2 tone can be used to create specific zones or focal points and to create a look that's personal to you.



True Handleless Matt



*Shhh...*  
 All of our doors and drawers come with soft close as standard

### Vivo+ Matt True Handleless Cashmere

Cashmere adds a touch of warmth to the kitchen yet offers flexibility with floor and wall colours. Island units maximise the effect of the handleless aesthetic, turning it into a true focal point.

### Vivo+ Matt True Handleless Indigo

The darker character of indigo is well suited to large spacious kitchens and more neutral wall and floor finishings. Both silver and rose gold make striking rail partners.



*Highlight task areas with effective LED strip lighting.*

True Handleless Matt

NEW



# VIVO+ TRUE HANDLELESS MATT PAINT TO ORDER

The Vivo slab door design is hugely popular in the UK and is now available in our paint to order and colour match service. Create a true handleless kitchen that's as individual as you!



## STANDARD PAINT TO ORDER PALETTE

Select from a palette of 23 standard colours or choose a colour swatch and let us match it. We have categorised each range into 4 different tone groups, to help you choose the ideal colour for your home:

### Neutral tones:

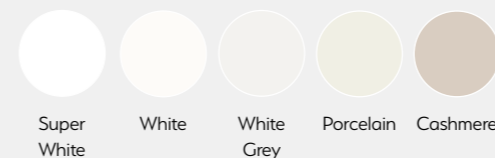

### Grey tones:



### Blue & Green tones:



### Earthy tones:





## Vivo+ Matt True Handleless Midnight Blue Paint to Order

Midnight blue has a very subtle hint of green and can be paired with the rose gold rail for a unique look. Symmetrical planning is shown to great effect here.

True Handleless Matt



# VIVO<sup>+</sup> TRUE HANDLELESS MATT BESPOKE COLOURS

If you've got your heart set on a specific colour then Jigsaw is the brand for you.  
We can colour match to create your dream finish, don't compromise!



Choose Jigsaw for

# QUALITY

*with painted finishes*

## Lucente...

Our Lucente door is made from 22mm MDF, vacuum sealed on exposed edges, primed and then given 2 coats of polyurethane paint. We've even got a colour co-ordinated reverse, but while kitchen doors might look the same, the reality is quite different.

### COMMON PROBLEMS WITH TYPICAL J PULL DOORS:



*Peace of mind with Jigsaw*

## Vivo...

Vivo is manufactured from 18mm MDF and finished in the same process as Lucente. Ensure you know exactly what you're buying and how long you want it to last for.

### COMMON PROBLEMS WITH TYPICAL SLAB DOORS:



Vinyl doors are glued and have the propensity to peel when exposed to the regular steam of a kettle or heat of an oven.



Chipboard can be used as a door substrate but can blow and raise when exposed to water. Not a good combination for a kitchen.



Vinyl doors start to bubble before peeling creating an unsightly look that can't be repaired.



Look out for peeling edges that can flap and irritate you. It's common in kitchens and home and office furniture.

### HOW JIGSAW'S SLAB & J PULL DOORS ARE DIFFERENT:



- Painted finishes ✓
- Edges are sealed and painted ✓
- 18-22mm Door Thickness ✓
- High quality materials ✓



NEW



True handleless has been an ever growing trend but utilising a contemporary shaker door with it creates a new aesthetic that's a personal favourite of mine.

**Terry Butler, Project Strategist**

# THE STRATTO TRUE HANDLELESS RANGE

We've taken the trend for true handleless a step further with the introduction of a shaker option. The narrow frame design and smooth matt finish create a new contemporary look that'll be the envy of your friends!



- ✓ *Matt finish*
- ✓ *18mm Door Thickness*
- ✓ *High Quality Materials*



#### AVAILABLE RAIL COLOURS:



Silver



Graphite

NEW



Rose Gold

NEW

#### AVAILABLE DOOR COLOURS:



White



Light Grey



Dust Grey



Indigo

## Stratto True Handleless Light Grey & Indigo

Use 2 colours to create unique zones within your kitchen and an island unit is the perfect place to start. Trending colours of light grey and indigo mix beautifully together.



True Handleless Super Matt



## Stratto True Handleless White

White never goes out of fashion but is given another dimension with the introduction of our new rose gold rail colour.

# THE LINEAR RANGE

Linear offers a highly fashionable collection of textures and colours and an alternative to solid colours. Use them to create complete kitchens or a distinct zone within your kitchen.

TRUFFLE BROWN DENVER OAK WITH HALF MOON BAR HANDLES

## AVAILABLE COLOURS:



Truffle Brown  
Denver Oak



White Halifax  
Oak



Natural  
Kendal Oak



Natural  
Halifax Oak



Shorewood

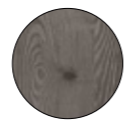

Anthracite  
Mountain Larch



The Linear range adds texture and opens up completely new design possibilities. I love the Scandinavian feel of the oak options.

**Danielle Davis, Brand Manager**

HALF MOON BAR HANDLE PICTURED



*Shhh...*  
All of our doors and drawers come with soft close as standard

## Natural Kendal Oak

The vertical grain of Natural Kendal Oak is a natural partner to kitchens incorporating larger drawers and larger combinations. Simplistic beauty with real feel.

## Shorewood

Shorewood provides a darker tone creating further definition to the kitchen furniture area for a stunning aesthetic.



WAVE CHROME HANDLE PICTURED



### SEVERN MIXER TAP

Severn offers contemporary and simplistic minimalist design making it suitable for any Linear kitchen.



*The Chrome Wave handle complements Shorewood's contemporary feel.*

Textured Slab

# Truffle Brown Denver Oak

Truffle Brown Denver Oak boasts a high level of flexibility, intertwining with cool and warm colours equally.



## Anthracite Mountain Larch

Anthracite Mountain Larch replicates the effect of woodgrain texture and is an ideal design partner to most neutral and light grey colourways.

STRAP BAR HANDLE PICTURED



## White Halifax Oak

White Halifax Oak is both subtle in colour and exquisite in texture. Our simple drawer and bridging unit design highlights the power of symmetrical kitchen design.

## Natural Halifax Oak

Go light and airy with Natural Halifax Oak with intricate groove detail and real feel wooden knots but without the splinters!



STRAP BAR HANDLE PICTURED



Textured Slab



# THE LINEAR TRUE HANDLELESS RANGE



## LINEAR TRUE HANDLELESS

Textured Slab Handleless

Take the Scandinavian feel of the Linear range and combine it with the Germanic influenced rail system for a truly European styled kitchen. You've got 6 doors and 3 rails colours to choose from!

AVAILABLE RAIL COLOURS:



AVAILABLE DOOR TEXTURES:





# CLASSIC CONTEMPORARY KITCHENS

Classic contemporary kitchens are our ranges that offer something for everyone's taste. They marry classic shaker designs with contemporary narrower frame widths and on trend colours to create a new look that spans generations.

p. 125 Ascot  
p. 133 Newmarket  
p. 149 Oxford  
p. 159 Stratto



# THE ASCOT RANGE

## Slim Frame Shaker Design

A one piece door with a shallow router and narrow frame, Ascot provides detail without the dust traps! Simplistic beauty and an ideal choice for linear design.

ASCOT SUPER WHITE WITH VICTORIAN & CHROME KNOB HANDLES PICTURED

NEW

- ✓ One piece slim frame
- ✓ 18mm Door Thickness
- ✓ Painted finish



The narrower frame shaker in Ascot makes this a kitchen for all ages and a perfect choice for multi generational loving.

**Matthew Fog, Creative Director**



# ASCOT PAINT TO ORDER

Choose from one of our 23 strong palette that are helpfully grouped into 4 tones that simplify your choice. Whether it's a classic or contemporary colour, we've got it covered.



LIGHT GREY WITH VICTORIAN & CHROME KNOB HANDLE PICTURED

## STANDARD PAINT TO ORDER PALETTE

Select from a palette of 23 standard colours or choose a colour swatch and let us match it. We have categorised each range into 4 different tone groups, to help you choose the ideal colour for your home:

### Neutral tones:

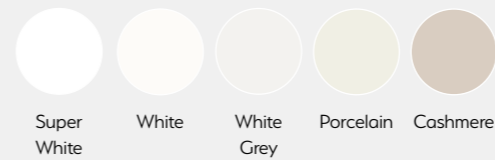

### Grey tones:



### Blue & Green tones:

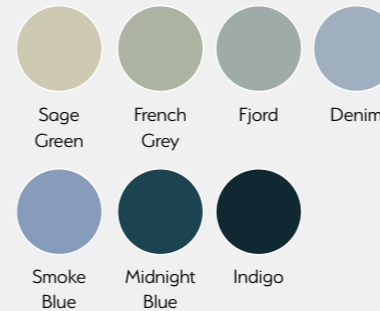

### Earthy tones:





Ascot Matt  
Light Grey & Dust Grey  
Paint to Order

Greys are a natural colour choice for the understated elegance of the Ascot door. An island unit with open shelving creates both an aspirational and functional space.

VICTORIAN & CHROME KNOB HANDLE PICTURED



ASCOT

# BESPOKE COLOURS

If you've got your heart set on a specific colour then Jigsaw is the brand for you.  
We can colour match to create your dream finish, don't compromise!



*Dulux  
2021 colour  
of the year!*

*Bespoke based on:  
Dulux  
Brave Ground*



*Bespoke based on:  
Farrow & Ball  
Paean Black*

VICTORIAN & CHROME KNOB HANDLE PICTURED

# THE NEWMARKET RANGE

NEW



I've always been a fan of the beauty of real timber and Newmarket's sleek design appeals to an even wider audience. Timber for all ages!

**Jane Captin, Marketing Development**

*Style & quality with real timber Newmarket!*



# NEWMARKET

## Narrow Frame Timber Shaker Design

Newmarket is the epitome of classic contemporary kitchens. Combining a classic timber substrate with a fashionable narrow frame width and on trend painted colours, Newmarket is set to take the market by storm!

- ✓ *Grooveless contemporary aesthetic*
- ✓ *20mm Door Thickness*
- ✓ *Real Timber*



AVAILABLE COLOURS:



## Newmarket Dust Grey

Indulge the contemporary nature of Newmarket with the highly on trend tone of Dust Grey. Offset this popular colour with Antique Copper handles and white worktops to stunning effect.

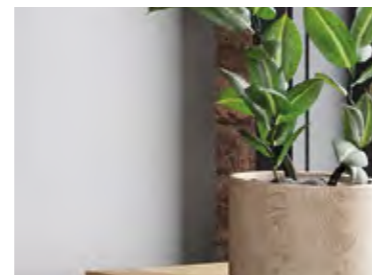
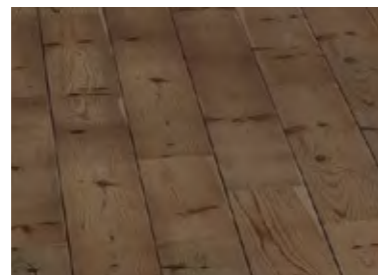
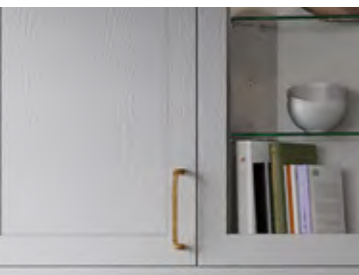

D-LITE ANTIQUE COPPER HANDLE PICTURED

Narrow Frame Timber Shaker

## Newmarket Indigo

Create a kitchen full of trends with an indigo finish, Newmarket's narrow frame and copper handles.



Narrow Frame Timber Shaker



## Newmarket Ivory

Embrace the traditional element of Newmarket with 900mm tall wall units for that vital extra storage space.





## Newmarket Light Grey

Newmarket's flexibility is illustrated here with traditional tongue and groove panels, a Belfast sink and contemporary curves. The light grey finish can be blended with both neutral and darker floor and wall finishings.

ELIPSE CHROME & CUP PLUS HANDLES PICTURED

Narrow Frame Timber Shaker



# NEWMARKET PAINT TO ORDER

Embrace the traditional element of Newmarket with a more classic colour or it's contemporary nature with one of our modern options. The choice is yours.



NEWMARKET PAINT TO ORDER CHALKSTONE & PETWER CUP HANDLE PICTURED

## STANDARD PAINT TO ORDER PALETTE

Select from a palette of 23 standard colours or choose a colour swatch and let us match it. We have categorised each range into 4 different tone groups, to help you choose the ideal colour for your home:

### Neutral tones:

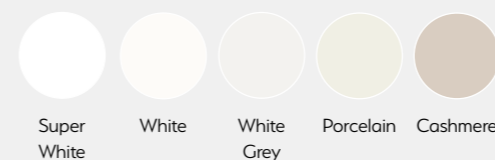

### Grey tones:



### Blue & Green tones:



### Earthy tones:





## Newmarket Paint to Order French Grey

Inject some pastel tones into the kitchen with the choice of French grey. Glazed wall units create a feature area and more light.

D LITE ANTIQUE COPPER HANDLE PICTURED

Narrow Frame Timber Shaker



# NEWMARKET BESPOKE COLOURS

If you've got your heart set on a specific colour then Jigsaw is the brand for you.  
We can colour match to create your dream finish, don't compromise!



ELIPSE CHROME & CUP PLUS HANDLES PICTURED



D LITE ANTIQUE COPPER HANDLE PICTURED

# THE OXFORD RANGE



OXFORD WHITE & IMPERIAL CHROME HANDLE PICTURED



Oxford is a favourite of mine. Highly fashionable and ideal for modern day living, I love the tactile matt finish..

**Dean Wade, Director of Specification**

*Shhh...*

All of our doors and drawers come with soft close as standard



# OXFORD

## Smooth Matt Painted Shaker Design

Oxford reinvestigates the shaker door design with a more contemporary narrower frame width and a simple one piece construction making this range easy on the eye. A tactile painted matt finish adds to the contemporary nature yet Oxford also contains a vast array of traditional accessories. Let your taste define what Oxford means to you.

- ✓ Painted Matt finish
- ✓ 18mm Door Thickness
- ✓ High quality materials



### AVAILABLE COLOURS:



# Oxford Light Grey & Indigo

Indigo is the latest addition to the Oxford colour palette and adds drama and definition to the kitchen. Pair with light grey for 2 tone beauty.

NEW



IMPERIAL CHROME HANDLE PICTURED

Smooth Matt Shaker

NEW



WIDE D HANDLE PICTURED

*Shhh...*  
All of our doors and drawers come with soft close as standard

## Oxford Dust Grey

Use our combination of curved doors to soften straight unit runs and create a unique look. Dust grey is a highly popular choice and is commonly used with more neutral wall and floor finishes.

## Oxford Anthracite

Accentuate the crisp design of Oxford with the colour choice of Anthracite. A vast array of accessories create features throughout the kitchen while darker fascias contrast lighter worktops to great effect.



HALF MOON BAR HANDLE PICTURED



**STEINA DOWNLIGHT LED**  
Use downlights within a glazed unit to create a feature of your glassware.



*Use a plate rack in your island for a sophisticated look!*

Smooth Matt Shaker





## Oxford Ivory

The calming soft hue of Ivory remains a UK favourite and suits both traditional and contemporary design. Combine curved units with open shelving for a highly fashionable design.

WIDE D HANDLE PICTURED

Smooth Matt Shaker

# THE STRATTO RANGE

NEW



Matt has been a growing trend in kitchens and when combined with the narrow frame shaker, it's a must have for today. Look out for the smooth touch.

**Jonathan Stockley, Technical Coordinator**

*Shhh...*

All of our doors and drawers come with soft close as standard



# STRATTO

## Matt Shaker Design

Our new Stratto range is perfectly placed within our classic contemporary choices. Utilising the classic shaker design in a smooth matt finish and narrow frame width, this range will appeal to all generations. Classic white, 2 greys and trending indigo complete a precise colour choice.

- ✓ *Matt finish*
- ✓ *18mm Door Thickness*
- ✓ *Narrow 60mm frame*



AVAILABLE COLOURS:



White

Light Grey

Dust Grey

Indigo

## Stratto Dust Grey & Light Grey

Stratto in grey creates a Scandinavian aesthetic that's perfect for modern living, combine both light and dust grey for the ultimate classic contemporary space. Kitchen furniture is also ideal for creating your own bar area at home!



D LITE CHROME HANDLE PICTURED

Matt Narrow Frame Shaker



*Use curves to soften corners in your kitchen design!*

*Shhh...*

All of our doors and drawers come with soft close as standard

## Stratto White

Stratto white is a perfect choice for practical room sizes while using glazed wall units further creates the feeling of light and space.

## Stratto Indigo

Go bold with Stratto indigo for a kitchen with undeniable character. A square handle choice accentuates the straight lines of the shaker design.



Choose Jigsaw for

# QUALITY CABINETS



A cabinet is the foundation of your kitchen so make sure yours is a solid one that's engineered to last. Don't accept flimsy panels when you have your best crockery in them or bare surfaces that could come into contact with water.



Peace of mind with Jigsaw

- ✓ A solid 18mm back panel on base units means you don't need to worry about damaging the backs from pots and pans
- ✓ 2mm PVC leading edging is extra protection against moisture damage
- ✓ The 18mm thickness assures lasting quality



# CLASSIC KITCHENS

If you're a fan of more classic design and traditional materials then this is the place for you. From painted timbers to traditional oak and grained effects, Jigsaw is the home of traditional kitchen options.

p. 171 Cartmel  
p. 195 Cambridge  
p. 213 Windsor

# THE CARTMEL RANGE

*A real alternative  
to timber*



Cartmel exudes class and quality making it a genuine alternative to timber, there's no compromise!

**Duncan McTaggart,**  
Conceptual Designer

*Shhh...*  
All of our doors and drawers come  
with soft close as standard





# CARTMEL

## Shaker Design

The pastel tones of the Cartmel range combined with the timber grain style detailing create an eclectic kitchen illustrating both modern and traditional influences. The five piece shaker door creates subtle definition while curved doors and co-ordinating cornice provide further flexibility in kitchen design. Generate some kitchen envy among your friends and relatives by choosing Cartmel for your new kitchen.

- ✓ *Woodgrain Effect*
- ✓ *22mm Door Thickness*
- ✓ *High quality materials*



AVAILABLE COLOURS:



White   Ivory   Mussel   Cashmere   Sage Green   Light Grey   Dust Grey   Anthracite   Indigo

CARTMEL INDIGO WITH ELIPSE & IMPERIAL ANTIQUE COPPER HANDLES PICTURED

# Cartmel White

White creates a crisp, chic look when combined with the Cartmel shaker door style and provides longevity in terms of fashion. Use Kea LED lights under wall units to create additional task lighting, ideal for food preparation in particular.



IMPERIAL PEWTER HANDLE PICTURED



Woodgrain Effect Shaker

# Cartmel Cashmere

Cashmere has quickly become a colour favourite across the UK and a shade that appeals to all generations. Cashmere also allows you to use complementary or contrasting room decoration to equal effect.



## Cartmel Indigo

Achieve your dream kitchen with Cartmel Indigo, paired here with our Antique Copper handles for a truly sophisticated look. As one of our most popular up and coming colours, the bold blue tone of Indigo is sure to impress your guests!

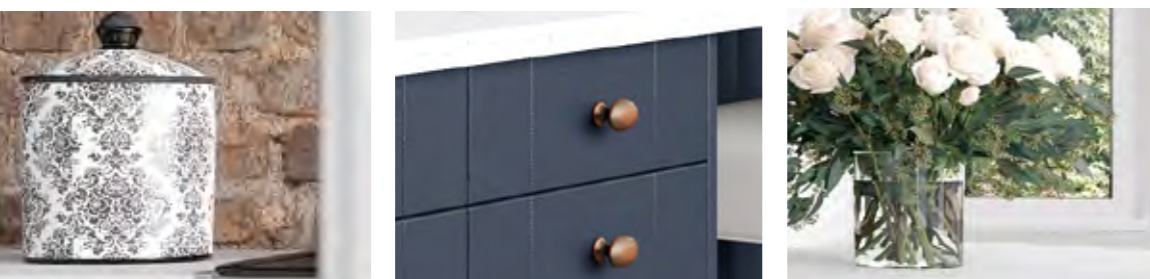

IMPERIAL & ELIPSE ANTIQUE COPPER HANDLES PICTURED

Woodgrain Effect Shaker

# Cartmel Mussel

The more traditional tone of Mussel is ideal to accentuate the traditional element in the Cartmel door design. Oak accents can be integrated from the Cambridge range both in furniture and worktop choices to create specific focal points.



IMPERIAL PEWTER HANDLE PICTURED



### TATTON CERAMIC SINK

Pair the classic colour of Cartmel Mussel with the Tatton ceramic sink for a stunning finished kitchen design. Our Tatton Ceramic sink is hard wearing and hygienic, meaning you can be stylish and practical at the same time.



Woodgrain Effect Shaker

BOW T BAR HANDLE PICTURED



# Cartmel Sage Green

Inject some vibrancy into your new kitchen with the lightness and brightness of Sage Green. Including glazed wall units can heighten this feel, aided by the addition of some clever lighting.

NEW



## Cartmel Anthracite

Anthracite is new to the Cartmel colour palette and creates a highly impactful kitchen. This colour is ideally suited to larger rooms blended with more neutral wall and floor colours.

ELIPSE & IMPERIAL CHROME HANDLES PICTURED

Woodgrain Effect Shaker

BLOCK END BAR HANDLE PICTURED



*Shhh...*  
All of our doors and drawers come with soft close as standard

## Cartmel Dust Grey

Dust Grey is the emerging colour within the kitchen palette and adds depth and definition. This highly fashionable tone illustrates the contemporary aspect of Cartmel and is demonstrated in our linear kitchen design.

## Cartmel Ivory

The enduring tones of soothing Ivory are a natural inclusion in the Cartmel range. Island units can also function as breakfast bars with cleverly placed curved units helping the flow of your kitchen design.

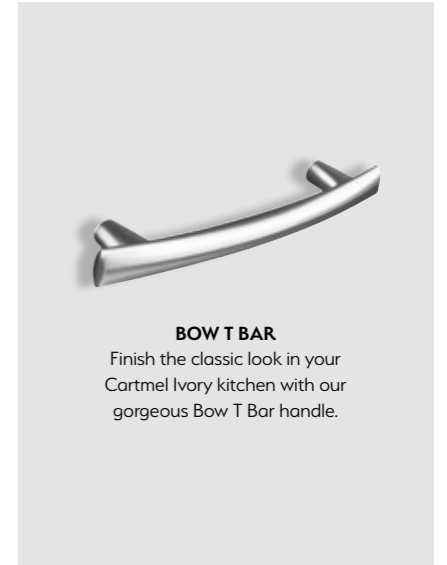

**BOW T BAR**  
Finish the classic look in your Cartmel Ivory kitchen with our gorgeous Bow T Bar handle.



BOW T BAR HANDLE PICTURED

Woodgrain Effect Shaker

*Mix a traditional styled door with a modern colour to impressive effect*

## Cartmel Light Grey

Cartmel in Light Grey creates a contemporary kitchen to be proud of, while both light and dark worktop finishes pair to great effect.

BLOCK END BAR HANDLE PICTURED

Woodgrain Effect Shaker





CARTMEL

# PAINT TO ORDER

Accentuate the uniqueness of your kitchen by choosing the Cartmel door in a hand painted finish. Choose the latest in vogue colour Midnight Blue or more of a classic choice in Chalkstone while the grain detail remains visible through every colour, creating the look of a timber door.



FRENCH GREY & WHITE GREY WITH BOW T BAR HANDLE PICTURED

## STANDARD PAINT TO ORDER PALETTE

Select from a palette of 23 standard colours or choose a colour swatch and let us match it. We have categorised each range into 4 different tone groups, to help you choose the ideal colour for your home:

### Neutral tones:

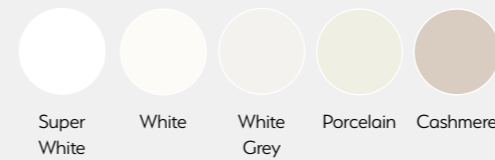

### Grey tones:



### Blue & Green tones:



### Earthy tones:





## Cartmel Lava Paint to Order

Lava is the deepest of our grey tones and also pairs beautifully with timber worktops. Use single curves to soften the lines and welcome you into the room.

BOW T BAR HANDLE PICTURED

Woodgrain Effect Shaker



# CARTMEL BESPOKE COLOURS

If you've got your heart set on a specific colour then Jigsaw is the brand for you.  
We can colour match to create your dream finish, don't compromise!



Bespoke based on:  
*Farrow & Ball  
Preference Red*

IMPERIAL & ELIPSE ANTIQUE COPPER HANDLES PICTURED



Bespoke based on:  
*RAL 3012  
Beige Red*

BLOCK END BAR HANDLE PICTURED

# THE CAMBRIDGE RANGE



*Welcome to a  
world of designer  
accessories!*



I've always appreciated traditional design and Cambridge offers so many options. From mantels to pillars and bottle racks to pilasters this range is a must have for country living.

**Andy Marsh, Director of Innovation**

*Shhh...*  
All of our doors and drawers come  
with soft close as standard



LIGHT GREY WITH D LITE CHROME HANDLE PICTURED



# CAMBRIDGE

## Real Timber Shaker Design

True timber fascias have represented a quality choice in kitchens for decades. The Cambridge range provides both this quality and a contemporary twist with 5 painted colours complementing the Oak finish. The colours combine to beautiful effect as we've illustrated or work equally as well on their own. The vast array of designer accessories help to create kitchens that are the focal point of any home.

- ✓ *V Groove detail*
- ✓ *20mm Door Thickness*
- ✓ *Real timber materials*



AVAILABLE COLOURS:



Ivory Mussel Light Grey Dust Grey Oak Indigo

NEW

# Cambridge Indigo

Embrace a new feel to timber with the bold introduction of indigo. Both oak cabinets and white worktops combine superbly well in this spacious kitchen.



ELIPSE CHROME & CUP PLUS HANDLES PICTURED

Timber Shaker

WAVE CHROME HANDLE PICTURED



## Cambridge Ivory

Ivory provides a lighter, airy feel to a kitchen improved even further with subtle lighting as shown. Use glazed units to display your finest crockery.

## Cambridge Dust Grey

The darker tones of dust grey offer both warmth and definition. Dust Grey combines beautifully with chrome accessories for a truly stunning kitchen.

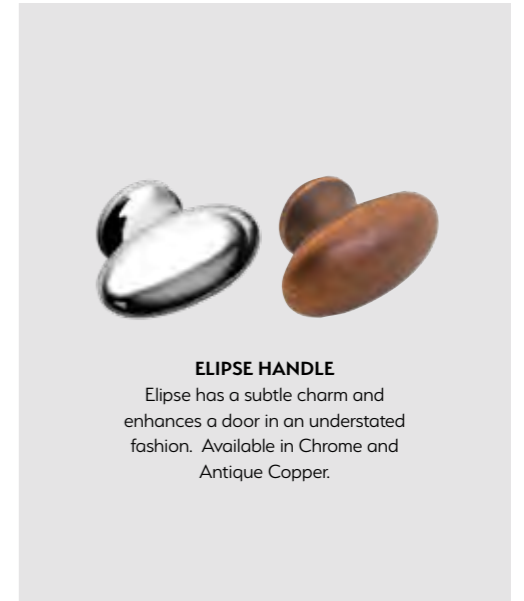

### ELIPSE HANDLE

Elipse has a subtle charm and enhances a door in an understated fashion. Available in Chrome and Antique Copper.



*Create  
ambience with  
plinth lighting*

ELIPSE CHROME HANDLE PICTURED

Timber Shaker

## Cambridge Mussel & Oak

The trending option of two tone kitchens is also suitable for classic options. Oak has a warmth and quality feel that never dates while ivory is a timeless colour. Glazed units are perfect for creating both a feature area and additional light.

*Shhh...*

All of our doors and drawers come with soft close as standard



*Create a stunning contrast with a two tone kitchen*

WAVE & ELIPSE CHROME HANDLES PICTURED



Timber Shaker





## Cambridge Light Grey

Take a highly fashionable colour and apply it to a timeless door style for a stunning effect. Use tongue and groove panels to heighten the traditional feel.

D LITE CHROME HANDLE PICTURED

*Add curves  
to soften edges*

Timber Shaker



CAMBRIDGE

# PAIN T TO O R D E R

Painted Cambridge doors retain the visible timber grain detailing through the painted finish and offer a truly bespoke aesthetic upon installation. Cambridge allows you to create both contemporary and traditional designs which can be complemented by your colour choice.



PEBBLE GREY WITH CHROME WAVE HANDLE PICTURED

## STANDARD PAINT TO ORDER PALETTE

Select from a palette of 23 standard colours or choose a colour swatch and let us match it. We have categorised each range into 4 different tone groups, to help you choose the ideal colour for your home:

### Neutral tones:

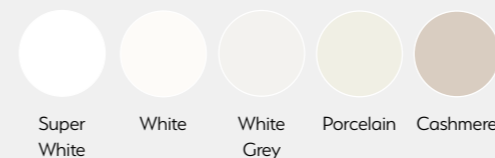

### Grey tones:



### Blue & Green tones:



### Earthy tones:





## Cambridge Denim Paint to Order

Go light and airy with a hint of pastel through the choice of denim from our blue tones. Our unique larger curved doors can be used in a variety of ways including the creation of a media station as shown here.

D LITE CHROME HANDLE PICTURED

Timber Shaker



# CAMBRIDGE BESPOKE COLOURS

If you've got your heart set on a specific colour then Jigsaw is the brand for you.  
We can colour match to create your dream finish, don't compromise!

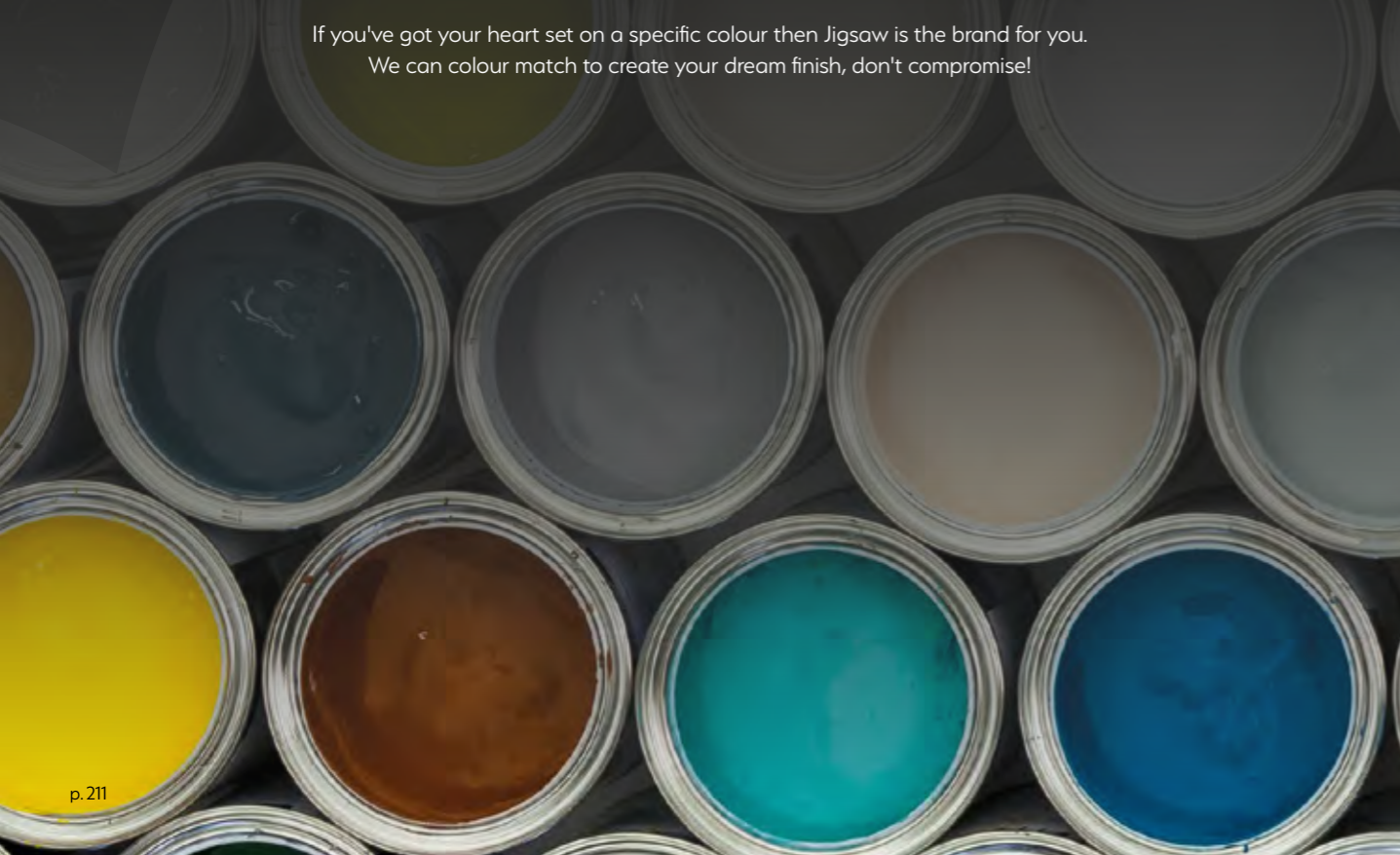

ELIPSE CHROME HANDLE PICTURED



WAVE CHROME HANDLE PICTURED

# THE WINDSOR RANGE

## Real Timber Shaker Design

If you're searching for the ultimate traditional kitchen then you've found it! Windsor doors are constructed from timber in a 5 piece shaker door with internal beading around the frame to provide even more definition. Look for the likes of pilasters, columns, mantels and corbels to make every zone of your kitchen distinct.

- ✔ *Internal beading detail*
- ✔ *20mm Door Thickness*
- ✔ *Real timber materials*



The beading detail on the Windsor range really gives that British country cottage look that I love. Use the barrel pilasters for extra character.

**Sara Johnson, International Designer**



WINDSOR

# PAINT TO ORDER

The vast array of components within Windsor allows you to create a highly personal traditional kitchen and the unique look. The timber grain, a statement of quality is still apparent through any painted colour option ensuring your choice is a timeless one.



DUST GREY WITH IMPERIAL & CUP PLUS CHROME HANDLES PICTURED

## STANDARD PAINT TO ORDER PALETTE

Select from a palette of 23 standard colours or choose a colour swatch and let us match it. We have categorised each range into 4 different tone groups, to help you choose the ideal colour for your home:

### Neutral tones:

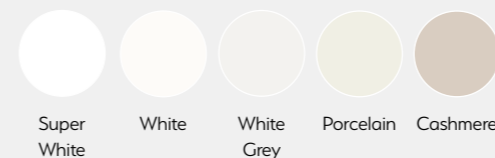

### Grey tones:



### Blue & Green tones:



### Earthy tones:





## Windsor Taupe Grey Paint to Order

Taupe grey combines warmth and neutrality for a beautiful classic kitchen. This kitchen illustrates a number of the ornate accessories available in Windsor to stunning effect.

ELIPSE CHROME HANDLE PICTURED



# WINDSOR BESPOKE COLOURS

If you've got your heart set on a specific colour then Jigsaw is the brand for you.  
We can colour match to create your dream finish, don't compromise!



IMPERIAL & CUP PLUS CHROME HANDLES PICTURED



ELIPSE CHROME HANDLE PICTURED





Smart

# STORAGE

So you've chosen your door range and cabinet colour, what about what sits behind the door? We've got a number of options to make access quicker and easier and ensure you maximise the space in your kitchen.