

THE BEDROOM

DIRECTORY

PWS





COVER PHOTOGRAPHY: CHAPTER SHOWN IN HARFORTH BLUE PAINT-TO-ORDER
PHOTOGRAPHY: ORIGIN SHOWN IN REGENTS GREEN PAINT-TO-ORDER

WELCOME TO THE PWS 2021 BEDROOM DIRECTORY

PWS is the market leading distributor of kitchen and bedroom components - proudly supplying our customers for over 110 years.

We're committed to continuous innovation and a highly integrated, customer-centric approach. In 2019 we extended the tried and tested PWS formula into the bedroom, by offering high quality and flexible bedroom components in both complete and component format, alongside a dedicated made-to-measure offer and a highly popular sliding wardrobe collection. In 2021 we have expanded our market leading offer even further, by introducing a new Paint-to-order service across some of our best-selling bedroom ranges.

Delivering excellent service and understanding our customers' requirements is at the heart of everything we do, ensuring that it is always quick and easy to work with us, and that our proposition adds real value to your business.

Most importantly, whether you are buying kitchen or bedroom components, you and your business are supported by one personal team, dedicated to providing expert advice, and assisting a professional, streamlined journey from start to finish.

We hope you enjoy the new PWS Bedroom Directory.



WARDROBES,
DOORS & ACCESSORIES
1.01 - 1.102



INTERNAL ACCESSORIES
2.01 - 2.20



HANDLES
3.01 - 3.26



LIGHTING
4.01 - 4.10



CABINET & COMPONENTS
5.01 - 5.20



TECHNICAL INFORMATION
6.01 - 6.56



WHY CHOOSE PWS?

THE MOST COMPREHENSIVE AND FLEXIBLE PRODUCT PORTFOLIO

PWS offers one of the largest and most inclusive ranges of kitchen and bedroom products and componentry, with over 10,500 stocked items. Our extensive choice of stocked door families are supported by a wide range of paint-to-order and entirely made-to-measure solutions.

STOCKED FINISHES



MADE-TO-MEASURE

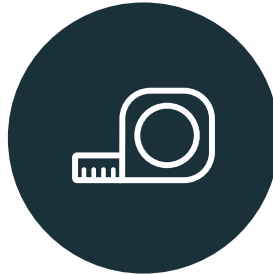

PAINT-TO-ORDER



THE MOST EXTENSIVE BEDROOM FURNITURE OFFER IN THE INDUSTRY

...

LEADING INNOVATION



We want to pioneer and define our sector. And, as a long-established organisation, we have unrivalled access to consumer and industry intelligence across product and process trends, which enables us to innovate, differentiate and launch fast.

QUALITY ALWAYS



Quality begins and ends with the customer and we strive to always satisfy your needs. To this end, we have a global perspective in sourcing only the very best products and materials across our categories from around the world, underpinned by a policy of continued improvement in process and service.

TRUE PARTNERSHIP



We want to understand your business and your goals, to develop a partnership via which we can tailor and provide you with specific product, service and commercial benefits.

EXCEPTIONAL SERVICES AND SUPPORT

Dependability, knowledge, expertise, responsiveness and communication, are critical in a multifaceted industry, and these values sit at the very core of PWS. Our customer-centric service culture is personal, efficient and reliable.

END-TO-END SUPPORT



YOUR PERSONAL SUPPORT TEAM

See Pg. 09



EASY ORDERING PLATFORMS

See Pg. 10



FLEXIBLE DELIVERY OPTIONS

See inside back cover

MARKETING & RETAIL



MARKETING SUPPORT & TRAINING

See Pg. 12



SHOWROOM DESIGN SERVICE

See Pg. 18



INSPIRATIONAL DESIGN CENTRES

See Pg. 16

PRODUCT & INSTALLATION



PAINT-TO-ORDER SERVICE

See Pg. 06



EXTENSIVE MADE-TO-ORDER SERVICE

See Pg. 1.65



DRILLING & JOINERY

Made-to-Measure ranges only
Unity See Pg. 1.73
Stanhope See Pg. 1.80



INSTALLATION

See Pg. 20

INDUSTRY LEADING WARRANTY PACKAGES

We offer a 6 year warranty* on all door and door range accessories and 10 years on all Sensio LED lighting.

*excluding sliding



PAINT-TO-ORDER SERVICE



At PWS, we're committed to continually improving our service proposition to our customers. Our fully automated, paint-to-order (PTO) service offers an extensive colour palette and a superior quality and finish.

We've recently moved from polyurethane to water-based paint. This allows us to significantly reduce our VOC emissions, whilst also delivering a much higher standard of paint finishing.* Delivered out of our industry leading paint finishing facility at our County Durham headquarters, we employ the very latest technology innovations and manufacturing techniques, with a dedicated quality management team to ensure the highest levels of performance at all times.



ROBOTIC ACCURACY

Our high-performance robotic machinery incorporates the latest in 3D scanning, air filtration, temperature control and drying technology, for the utmost accuracy in application, and consistency of colour and finish every time. The only one of its kind in Europe.

IN-HOUSE QUALITY ASSURED

Our high-quality, Fira Gold Certified paint is machine mixed in-house, and applied in the most highly controlled atmospheres to ensure quality control at all stages.

IT'S ALL IN THE PREPARATION

Specialist sanding and priming technology tailors the preparation of each door material type to optimise the paint adhesion - for a truly flawless finish that stands the test of time.

DRILLING SERVICE FOR PAINTED PRODUCTS

Our drilling service for painted products helps to significantly reduce potential damage - and makes things easier for you and your customers all round.

THE OPTIMUM ENVIRONMENT

Our super-scale dust extraction and filtration network cleans the air in the whole building every hour - to continuously ensure the purest environment and optimum paint finishing conditions.

THE GREATEST CAPACITY AND THROUGHPUT

Our highly automated technology allows us to handle volume with ease, offering the greatest capacity and quickest throughput in the industry. Our robotic paint line can run faster than five metres a minute. It both paints and dries, enabling product to be painted on both sides the same day.

A BETTER, GREENER, WATER-BASED FINISH

Our new water-based paint not only helps us to provide a much greener service, but also delivers a higher quality finish with far greater scratch resistance.

*Our new water-based finish has been implemented across all 35 matt colours.

35 MATT COLOURS TO CHOOSE FROM



Wherever you see our paint-to-order symbol, this range can be painted in any of our Paint-to-order colours. Ranging from muted neutrals to vibrant shades, our painted palette consists of 35 different carefully considered matt colours.

NEUTRALS

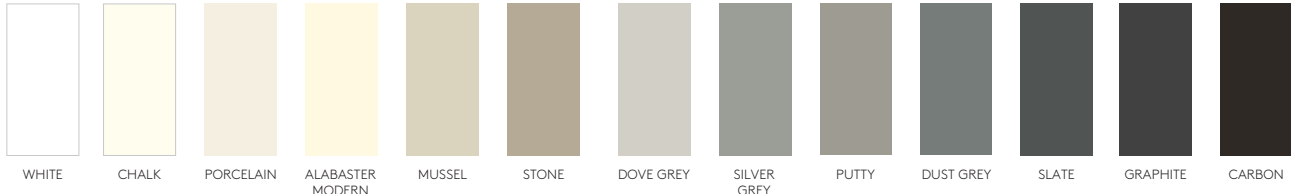

GREYS

WARM NEUTRALS

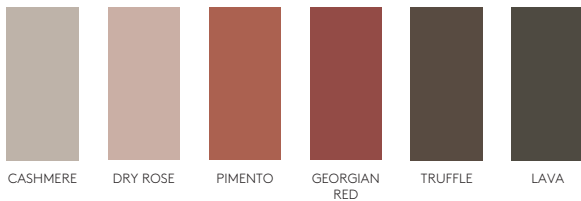

OLIVE GREENS

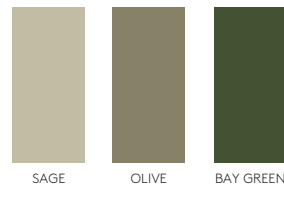

FOREST GREENS

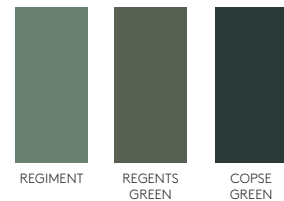

GREEN BLUES

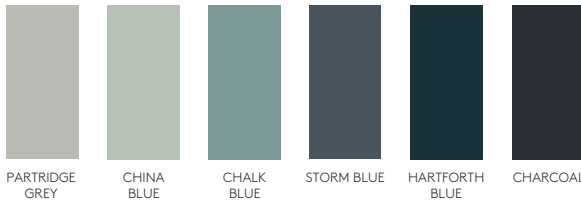

INK BLUES

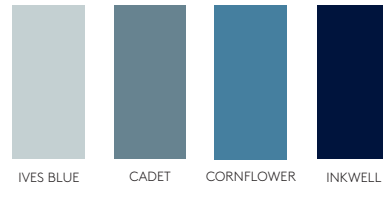

Paint-to-Order lead-times:

The stated lead-times for Paint-to-Order are for guidance purposes only and always subject to manufacturing capacity. An accurate lead-time, in the form of a delivery date, will be confirmed with each individual order acknowledgment.



*Lead-time based on orders placed before 5pm, Tuesday cut-off.

Because of the variables between the photographic and print process, colours shown in print may vary slightly from the actual product supplied.

See page 1.08 on how to order PAINT-TO-ORDER RANGES



A FIFTH GENERATION BUSINESS

FOUNDED IN 1909

Our story began over 110 years ago, as a family run, independent business in County Durham. From day one, our approach was to create a furniture collection that was innovative, flexible and good quality, all at an affordable price; values that remain strong today.

Still owned by the same family, we've now grown to become the market leading distributor of bedroom components in the UK and our portfolio is as diverse as it is creative.

We go to great lengths to ensure that the suppliers we work with are world class. Our long-standing supplier relationships are built on trust and dependability, driven by our desire to supply innovative, high quality products to our customers.

We're proud to have helped create thousands of homes, forging lasting partnerships with a growing family of valued customers nationwide.

An established family business built for the future.



Darlington, High Row - circa 1909

CUSTOMER-CENTRIC SUPPORT

At PWS, delivering excellent customer service is at the heart of everything we do.

With this in mind our customer-centric support hub is designed to improve our business partnership with you, and make it much quicker and easier to work with us.

This hub joins all PWS kitchen and bedroom sales and customer service teams together in one dedicated place, providing a seamless customer journey, and the most comprehensive range of products and services under one roof.

YOUR PERSONAL TEAM OF EXPERTS AND 'ONE CALL' SERVICE



Our support hub provides all customers with a dedicated team of experts working closely with you at all times - there to support all of your business needs via one quick and easy call. This includes:



**LOCAL
AREA SALES
MANAGER**
(EXTERNAL)

Face-to-face business support in your local area



**BUSINESS
DEVELOPMENT**
(INTERNAL)

An extension to your business providing valuable sales support and account management



**CUSTOMER
SERVICES**
(INTERNAL)

End-to-end support for all projects: inc. dedicated worksurface advisor

CUSTOMER INDUCTION PROGRAMME

All new PWS customers receive a personal induction programme, and continued day-to-day support going forward, covering:



TRADING ARRANGEMENTS

- Order process
- Our enhanced remedial service
- Our returns procedure
- Logistics and delivery



PERSONAL CUSTOMER SERVICE ADVISOR

- Every customer is assigned a personal customer services advisor as a point of contact and guide through every stage of your ordering process.
- Direct dial for your personal support hub.



EXPERT PRODUCT KNOWLEDGE

- Your dedicated team are fully trained in all aspects of our products and services.
- As part of our customer induction programme we provide tailored training and trade material to support you in becoming a PWS product and brand champion in all areas.



PROBLEM RESOLUTION

- We have a robust remedial procedure in place as part of our problem resolution service. This will be managed through an enhanced lead time.

OPENING HOURS 8am - 7pm Monday - Thursday | 8am - 5pm Friday **TRADE COUNTER OPEN** 7am - 5pm Monday - Friday



PWS

WWW.PWS.CO.UK

SHOP KITCHENS

SHOP BEDROOMS

**Our new website includes a host of new features to make it easier for you to
TRADE SMARTER - ANYWHERE, ANYTIME, ANY PLACE.**

- ✓ Easily browse our complete collection of over 18,000 products
- ✓ Place, track & check your orders & quotations
- ✓ View instant pricing
- ✓ Quick order entry
- ✓ Brand new consignment area to track deliveries & collections
- ✓ Download the latest Directory, Technical Manuals, consumer brochures & more

AN EASY TO NAVIGATE ONE-STOP-SHOP

From stocked, paint-to-order and bespoke - to accessories, lighting and worksurfaces, you can now find our full kitchen and bedroom portfolio in one easy to navigate place.



ORDERING MADE SIMPLE

We want to make your service experience with us as simple and hassle free as possible which is why we are investing in our online services.



EQ FROM COMPUSOFT

Many customers use EQ and we have worked with Compusoft to integrate our online services, to make placing an order even simpler and real-time through this leading business management platform for the industry.

- Using your PWS login details, place orders electronically through EQ with instant stock availability information and live stock allocation.
- EQ Direct Pricing allows you to download your PWS product prices directly into EQ (PWS list and net prices) without the need to manage the discount lists in EQ.
- As with the PWS website, ordering through EQ directly, rather than by email, allocates the stock immediately to your order.
- You can track and progress your order immediately on the PWS Website.

WHAT DO I NEED?

1. EQ version 14.2.158 and above
 2. PWS website login details
- Set-up in the EQ supplier screen for account placing orders directly and EQ Direct Pricing integration.



CAD PACKAGES

We offer dedicated catalogues in the major CAD software platforms:



BEDROOM MARKETING SUPPORT

CONSUMER LITERATURE

Our high quality, inspirational consumer brochures feature a mix of room set, product and lifestyle photography to help your customer create their dream bedroom.

Order code	Description
KDB1BC	The Bedroom Collection

To order, please speak to your Area Sales Manager or Sales team.



SAMPLE DOORS

All of our ranges are available as samples in either 447x397/397x447 or 570x397 (Unity/Stanhope/Alpina size) to help you illustrate key features and benefits of each design to your customer - see price list for sample doors.

DOORSTAND

Doorstands are the perfect way to display our door ranges in your showroom. Ideal for smaller spaces where room is at a premium, these units allow you to store frontal samples in a compact, tidy way.

Designed to give customers quick and easy access to all sample door styles and colours in one place. Each door stand holds 15 doors. Manufactured from Egger U961 board and 3mm ABS edging with Kesseböhmer door display rails.

UNIT DIMENSIONS

Height 2100mm x width 433mm x depth 600mm

Supplied boxed, flatpack with cam and dowel fixings.
Full assembly instructions.

Order code	Description
DOORSTAND	Door display stand, 2100x433x600mm (No doors) Choose your own doors from our price list.



DOOR DISPLAY RAILS

Effectively display our doors, handleboards and worktop samples using our Chrome finished rails.

- Left and right-hand versions available
- Supplied in packs of 10

Order code	Description
KDRLH	Left handed
KDRRH	Right handed

HANDLEBOARDS

Handleboards are the perfect way to display the wide range of handle options we have available. With the ability to hold up to twelve styles, simply choose the handles you want to display from the handle section in this directory.

Handleboard



Order code	Description
BHANDLE/BOARD	Blank handleboard and clips to attach handles
BHB/CLIPS	Additional clips

PAINT SWATCHES

Paint swatches are the best way to show our full paint-to-order palette.

Order code	Description
CLASSICSWATCH	Paint-to-order colour sample swatch book

SWATCHES



Designed to be a quick and easy tool to showcase all colour options in a handy briefcase size. These swatches can be left on display for browsing customers as they are fully labelled with range and colour references.

Modern, Classic & Internal Accessory Swatches. 3 x Individual come as 18mm rectangular sample sets.

All of the available finishes in our Alpina made-to-measure ranges are available in a swatch booklet.

Stanhope samples available on request.

Order code	Description
KDMODSWATCH	Colour Swatch, Modern Collection and Internal Accessories
KDCCLASSSWATCH	Colour Swatch, Classic Collection and Internal Accessories
KDFULLSWATCH	Colour Swatch, Modern and Classic Collection including Internal Accessories
VENEER/SWATCH	Alpina sample swatch book
STANHOPE/SWATCH	Stanhope swatches
SLIDING/SAMPLE	Sliding sample box
UNITY/SWATCH	Gloss, matt, metallic, timber and concrete effect finishes

Please contact customer services for more information and to order any of the above items

REAL BEDROOMS

REAL BEDROOM PROJECTS

Why not promote your real bedroom projects on our social media channels. Showcasing and sharing your real bedroom projects allows you to display your best work to prospective customers, and is proven to encourage more consumer engagement and generate more leads.

Submit your real bedroom projects to:

PWS PR & Communications Team

Email: pr@pws.co.uk

Tel: +44 (0) 1325 505 529



BRAND NEW INSTAGRAM PLATFORM

Specifically designed to
showcase your work



Instagram

FOLLOW OUR PAGE
@thebedroomcollection_

Remember to tag us in your projects to get noticed.

STAY SOCIAL

It's really easy for you to engage with us via our consumer social media platforms.

There's always so much to get involved in to promote your business - from case studies, to special features on your showroom, or why not collaborate with us on a design or styling project.





INSPIRATIONAL DESIGN CENTRES

Strategically located at PWS' Southern and Northern business hubs, our design centres are the best platforms for inspiration, where you can browse our abundance of stunning kitchen and bedroom displays, and see our exceptional products and materials up close.

Available for you to use as an extension of your own showroom, you are free to show your own customers around, explore hundreds of samples, and join our regular training events.

Visits to our design centres are arranged on a pre-booked appointment basis. Please contact our customer service team who will be happy to schedule this for you.



Aycliffe Business Park
Newton Aycliffe
Co. Durham
DL5 6EQ



778 Buckingham Avenue
Slough
Berkshire
SL1 4NL

NEW VIRTUAL SHOWROOMS

Bringing the Design Centre experience to you - any time, any place, anywhere

We recently launched our virtual showrooms, giving you the opportunity to browse our state-of-the-art Design Centre from anywhere on any device.

Visit www.pws.co.uk/bedrooms and explore over 60 trend leading kitchen and bedroom sets.

To book a visit contact us at sales-support@pws.co.uk



SHOWROOM DESIGN SERVICE

We're proud to offer all showroom based customers access to our dedicated showroom design service for both kitchens and bedrooms.

From advice on a single door swap to full showroom planning, our experienced designers can help to take the hassle out of planning and designing your displays. Working closely with you, they can create tailored designs which will fit beautifully, accurately, and commercially in your showroom – whilst being on hand to offer expert design advice on the latest products, materials, colours, finishes and details.

We all know that consumers like to buy what they have seen. This is why many retailers ask our designers to help them replicate our imagery in their showroom. This can often help you to ensure a consistent consumer journey, with designs that may have already been seen in our brochures or online marketing platforms, and that your customers can trust and begin to imagine in their own home.

Additionally, many of our retailers often plan their display updates in line with our product launches, which tend to generate the most demand from consumers looking to recreate these featured looks.

Our designers can also assist with the wider elements of your showroom design.

From work/meeting spaces, entrance ways, and sample/specification areas, to completely bespoke concepts, as well as providing advice on styling, materials and finishes, our showroom design service will help to create effortless flow and maximum engagement - and truly bring your space to life.

To request a kitchen or bedroom showroom design contact
showroomdesign@pws.co.uk



Receive stunning 3D designs, overview plan with dimensions, full technical drawings, component and internal storage break downs, as well a quote for your display.



COMPLETE BEDROOMS INSTALLATION PROPOSITION

When purchasing a complete bedroom we can offer you additional services.

INSTALLATION - COMPLETE BEDROOMS

All of our Bedroom installers have had intensive training to ensure that they can continue delivering you an exceptional service. From initial design to installation you can be assured that your customers fitted bedroom will be installed within four to six weeks of the order being placed.



Designed & Quoted

Once your design and quotation has been created in your store and submitted to your assigned customer service member, it will be listed as 'subject to survey' until installations@pws.co.uk qualify your order and design, and arrange a pre-installation home survey.



Pre-installation home survey

Within one week from receipt of your order, one of our bedroom fitters will arrange a pre-fit home survey. This survey will last approximately 30 minutes and will assess the site to check that dimensions in the design are correct and whether there are any obstructions or access problems for delivery. Once satisfied, a date within 4 weeks to deliver and install the furniture will be arranged by phone or email.



Surveys & installations

For all survey and installation queries contact:

Email: installations@pws.co.uk
Tel: 01325 329450



Premium Delivery

We provide a premium delivery service. There will be an option for the consumer to select a specific delivery day and delivery slot between Monday to Friday, 8am to 5 pm. Delivery will be made at least one day before installation commences and a call will be made one hour before delivery to confirm that plans can still go ahead. Additional delivery costs apply.

POINTS 1-5 - 1 WEEK
 POINTS 6-14 - 3 WEEKS

- CUSTOMER SERVICES
- INSTALLATION COORDINATOR
- INSTALLER

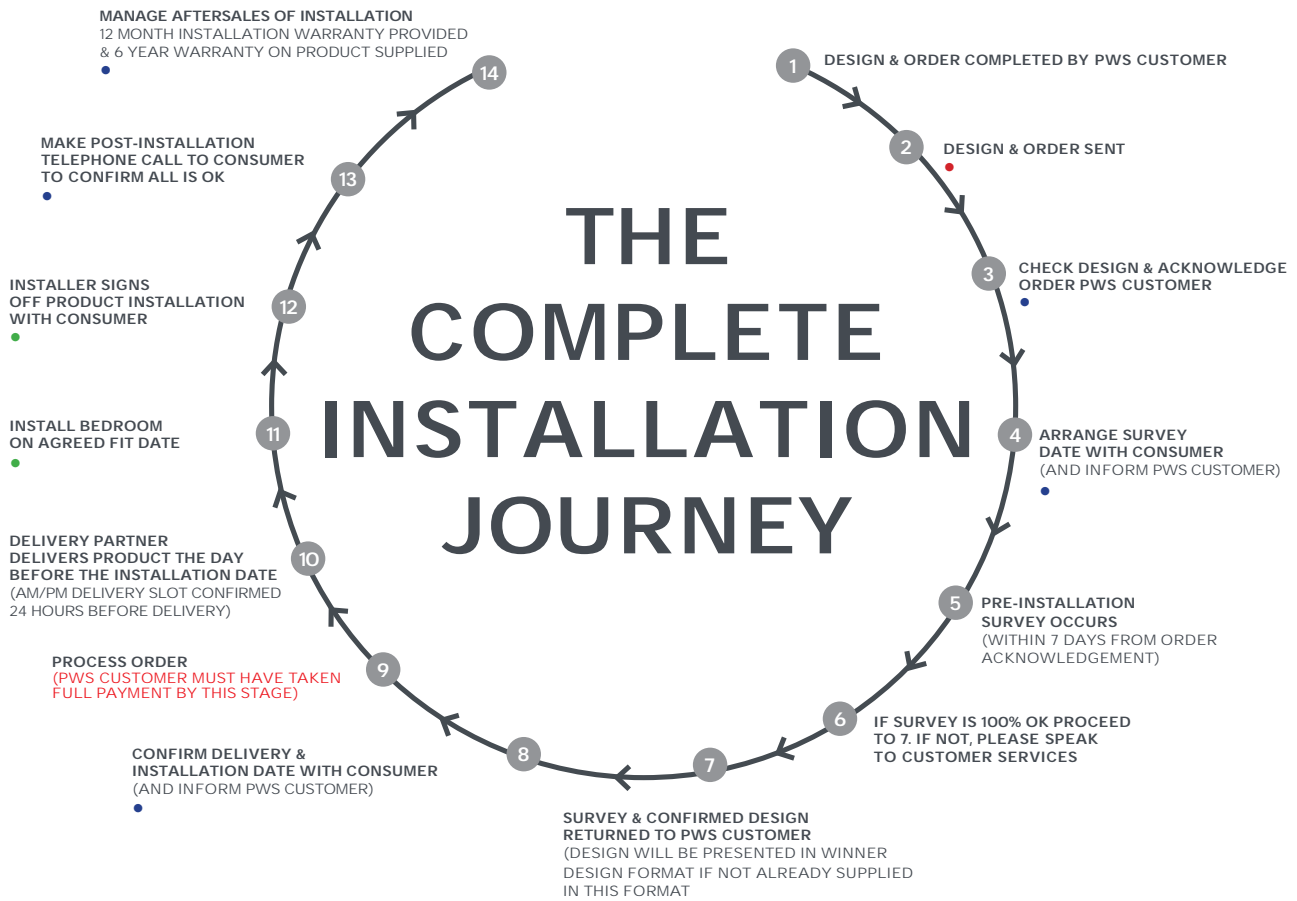

FITTING DAYS AND TIMES
 MONDAY TO FRIDAY 8AM TO 6PM

DELIVERY DATES AND TIMES
 MONDAY TO FRIDAY 8AM TO 5PM

AM DELIVERY SLOT 8AM 12 NOON
 PM DELIVERY SLOT 12 NOON TO 5PM

AM AND PM DELIVERY SLOT CONFIRMED
 24 HOURS BEFORE AGREED DELIVERY DATE

DRIVER CALLS 1 HOUR PRIOR TO DELIVERY ON DAY

A modern bedroom with a large wardrobe system. The wardrobe has a mirror door that reflects the room, including a window with blinds, a radiator, and a white vanity with a bowl. In the foreground, a bed is made with white striped bedding and a grey blanket. The floor is made of light-colored wood in a herringbone pattern.

WARDROBES, DOORS & ACCESSORIES

PHOTOGRAPHY: SCULPT SHOWN IN SAGE PAINT-TO-ORDER

WARDROBES, DOORS & ACCESSORIES

Range Selector	03
Paint-to-order Summary	07
Paint-to-order Order Flow Chart	08
CLASSIC COLLECTION	09
Chapter	
Complete	11
Component	15
Origin	
Complete	19
Component	23
MODERN COLLECTION	27
Esker	
Complete	29
Component	33
Parity	
Complete	37
Component	41
Sculpt	
Complete	45
Component	49
Feature Collection	
Glass & Mirror	53
Walnut	57
Care & Maintenance Kits	63
THE MADE-TO-MEASURE COLLECTION	65
Ordering & Leadtimes	68
Unity	69
Stanhope	75
Alpina	83
Sliding	87
Co-ordinating MFC Board Options	101

KEY



Price
Indication

Look out
for pound
symbols to
indicate price
banding

1 = Low
5 = High



Lacquered/
Painted

Indicates
the door
has a
lacquered
finish



Stocked
Finishes

Indicates
that the
door family
has finishes
available
from stock



Paint-to-Order
Service

Indicates that
the door family
is available in
Paint-to-order

Because of the variables between the photographic and print process, colours shown in print may vary slightly from the actual product supplied.

RANGE SELECTOR

PRODUCT AVAILABILITY

CLASSIC			MODERN			MADE-TO-MEASURE		
STOCKED RANGE	Paint-to-order	Lacquered/ Painted	STOCKED RANGE	Paint-to-order	Lacquered/ Painted	NON STOCKED	Paint-to-order	Bespoke door sizes
CHAPTER	✓	X	ESKER	✓	✓	ALPINA	X	✓
ORIGIN	✓	X	PARITY	✓	✓	STANHOPE	X	✓
CHESTS	X	X	SCULPT	✓	✓	UNITY	X	✓
			CHESTS	X	X	SLIDING	X	✓

CLASSIC RANGES

CHAPTER (PAGE 11)

STOCKED £ £ PAINT-TO-ORDER £ £ £



STOCKED COLOURS

COLOUR REFERENCE CODE	STOCKED COLOURS
01	PARTRIDGE GREY
02	PORCELAIN
03	STONE

SERVICE OPTIONS

XX	PAINT-TO-ORDER Matt only
----	-----------------------------

ORIGIN (PAGE 19)

STOCKED £ £ PAINT-TO-ORDER £ £ £



STOCKED COLOURS

COLOUR REFERENCE CODE	STOCKED COLOURS
01	PARTRIDGE GREY
02	PORCELAIN
03	STONE

SERVICE OPTIONS

XX	PAINT-TO-ORDER Matt only
----	-----------------------------

CLASSIC CHESTS (PAGE 13)

STOCKED COLOURS

COLOUR REFERENCE CODE	STOCKED COLOURS
01	PARTRIDGE GREY
02	PORCELAIN
03	STONE

CHEST TOP FINISH



MATCHING TOP

TEXTURED OAK EFFECT TOP

Paint-to-order not available on Chests

When ordering, use the colour reference code in place of **
Use codes below for flat-packed. Add an 'A' for assembled.
For example: KDO3**2D486 (flat-packed), KDO3**2D486A (assembled)

PRODUCT KEY:



Painted Finish



Stocked Range



Paint-to-Order Service



Made-to-Measure Door Ranges



Bespoke Door Sizes



Price Bands 1 - 5

MODERN RANGES

ESKER (PAGE 29)

STOCKED £ £ £ PAINT-TO-ORDER (MATT ONLY) £ £ £ £



STOCKED COLOURS

CASHMERE	04
DOVE GREY	05
ANTHRACITE	06

SERVICE OPTIONS

PAINT-TO-ORDER (NEW) (P) Matt only	XX
------------------------------------	----

COLOUR REFERENCE CODE

PARITY (PAGE 37)

MATT £ £ £ GLOSS £ £ £ PAINT-TO-ORDER (MATT ONLY) £ £ £



CASHMERE MATT & GLOSS	04
DOVE GREY MATT & GLOSS	05
ANTHRACITE MATT ONLY	06
WHITE MATT & GLOSS	07

SERVICE OPTIONS

PAINT-TO-ORDER (NEW) (P) Matt only	XX
------------------------------------	----

COLOUR REFERENCE CODE

SCULPT (PAGE 45)

STOCKED £ £ £ PAINT-TO-ORDER (MATT ONLY) £ £ £ £



STOCKED COLOURS

CASHMERE MATT & GLOSS	04
DOVE GREY MATT & GLOSS	05
ANTHRACITE MATT ONLY	06
WHITE MATT & GLOSS	07

SERVICE OPTIONS

PAINT-TO-ORDER (NEW) (P) Matt only	XX
------------------------------------	----

COLOUR REFERENCE CODE

MODERN CHESTS (PAGE 31)



STOCKED COLOURS

CASHMERE MATT & GLOSS	04
DOVE GREY MATT & GLOSS	05
ANTHRACITE MATT ONLY	06
WHITE MATT & GLOSS	07

Paint-to-order not available on Chests

COLOUR REFERENCE CODE

When ordering, use the colour reference code in place of **
Supplied fully assembled only.

THE FEATURE COLLECTION

COLOUR REFERENCE CODE BELOW DOORS

GLASS, MIRROR (PAGE 53)

£ £ £ £



10



11

WALNUT (PAGE 57)

£



08

Because of the variables between the photographic and print process, colours shown in print may vary slightly from the actual product supplied.

MADE-TO-MEASURE

UNITY (PAGE 69)

	SUPERMATT (UBB) £ £		GLOSS (UBB) £ £		WOODGRAIN EFFECT (UBA) £		
		PURE WHITE		PURE WHITE			
		CASHMERE		CASHMERE	WHITE HALIFAX OAK	NATURAL DAVOS OAK	RECLAIMED OAK
		LIGHT GREY		LIGHT GREY			
		DUST GREY		DUST GREY	CHARACTER GRAPHITE	SEPIA GLADSTONE OAK	BLACK ASH
		GRAPHITE		GRAPHITE			
		PEBBLE GREY					
	GLOSS METALLIC (UBC) £ £ £	FEATURE CONCRETE £					
			BRUNSWICK (UBC)				
			HAYWARD (UBA)				
			TRELICK (UBA)				

ALPINA (PAGE 83) PREFIX SHOWN IN BRACKETS BELOW

NATURAL OAK MATT (BNO)	SMOKED LARCH TEXTURED (BSB)	MID OAK TEXTURED (BMO)	DEEP OAK MATT (BDO)	BURNT ASH TEXTURED (BBA)	SMOKED OAK MATT (BSM)

STANHOPE CLASSIC (PAGE 75)

BOLAM One piece Shaker (SBB)	ELSDON One piece Shaker (SBC)

STANHOPE MODERN (PAGE 75)

WHITFIELD Square Slab (SBA)	HENSHAW Sapponetta Slab (SBA)	ACOMB Integrated handle (SBA)

MATT

	PORCELAIN
	DOVE GREY
	CASHMERE
	DUST GREY
	BLUE CANVAS
	INDIGO BLUE
	THORPE GREEN
	GRAPHITE
	MATT BLACK

WOODGRAIN EFFECT

	SUPER WHITE
	CREAM
	GREY
	MUSSEL
	CASHMERE

GLOSS

	WHITE
	CREAM
	DOVE GREY
	CASHMERE
	DUST GREY

FEATURE

CONCRETE

Please Note:
Acomb is **not** available in Gloss finishes

SLIDING (PAGE 87)

SLIDING DOOR CONFIGURATIONS

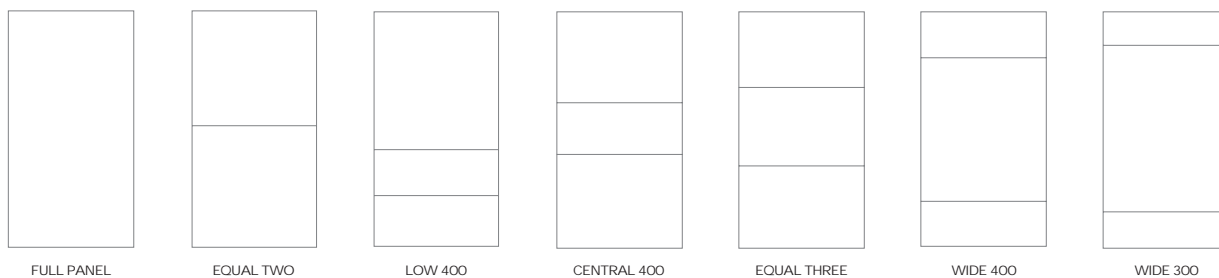

Choose from over 35 colours across matt and gloss coloured board, woodgrain board, glass, satin glass and mirror.

Whether you would like all one colour or mix of materials the choice is yours.

MIRROR

BOARD COLOURS



WOODGRAIN BOARD COLOURS

GLASS COLOURS



SATIN GLASS COLOURS



All board thickness are 18mm. Curve profiles only suitable for use with glass or mirrored doors.

PAINT-TO-ORDER SUMMARY



PAINT-TO-ORDER DOOR RANGES:

CLASSIC



Chapter

Origin

MODERN



Esker

Parity

Sculpt

ENHANCED 2021 PAINT-TO-ORDER COLOUR PALETTE:

NEUTRALS



WHITE

CHALK

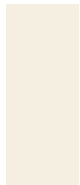

PORCELAIN



ALABASTER
MODERN



MUSSEL



STONE

GREYS



DOVE GREY



SILVER
GREY



PUTTY



DUST GREY



SLATE



GRAPHITE



CARBON

WARM NEUTRALS



CASHMERE



DRY ROSE



PIMENTO



GEORGIAN
RED



TRUFFLE



LAVA

OLIVE GREENS



SAGE



OLIVE



BAY GREEN

FOREST GREENS



REGIMENT



REGENTS
GREEN



COPSE
GREEN

GREEN BLUES



PARTRIDGE
GREY



CHINA
BLUE



CHALK
BLUE



STORM BLUE



HARTFORTH
BLUE



CHARCOAL

INK BLUES



IVES BLUE



CADET



CORNFLOWER



INKWELL



Paint-to-Order lead-times:

The stated lead-times for Paint-to-Order are for guidance purposes only and always subject to manufacturing capacity. An accurate lead-time, in the form of a delivery date, will be confirmed with each individual order acknowledgment.



*Lead-time based on orders placed before 5pm, Tuesday cut-off.

Because of the variables between the photographic and print process, colours shown in print may vary slightly from the actual product supplied.

PAINT-TO-ORDER ORDER FLOW CHART

The easiest way to order is at www.pws.co.uk/bedrooms

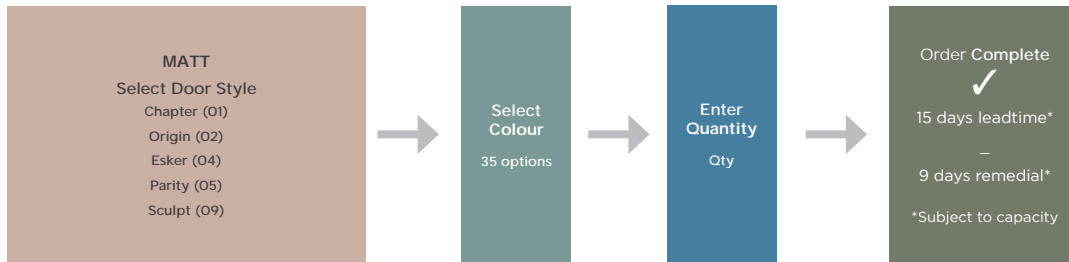

When placing orders for paint-to-order doors please be aware of the following:

- 1.** Stated lead times for Paint-to-Order are designed as a guideline and always subject to manufacturing capacity.
An accurate lead-time, in the form of a delivery date, will be confirmed with each individual order acknowledgement.
- 2.** Orders for paint-to-order door ranges can be placed by email or via the PWS website.
Upon receipt of each order to PWS you will receive an itemised order acknowledgement.
- 3.** Due to the bespoke nature of paint-to-order products, it is not possible to cancel or amend orders once placed.
Additions to an order will be processed as a new order.
- 4.** Orders for painted product will be dispatched upon completion of the full order
No part orders will be dispatched.
- 5.** PWS cannot accept the return of surplus paint-to-order product.
- 6.** Although we strive to maintain consistency, as a painted product there will be batch-to-batch variances.
PWS cannot guarantee an exact colour match between orders. We do not recommend mixing doors ordered through paint-to-order with doors ordered from stock.
- 7.** The paint colours depicted in our marketing materials are indicative of the colours of the painted product.
Paint colours do vary batch to batch and substrate to substrate.
- 8.** A selection of care and maintenance kits are available for paint-to-order colours.



THE
CLASSIC
COLLECTION

PHOTOGRAPHY: CHAPTER SHOWN IN DRY ROSE PAINT-TO-ORDER

PRODUCT CODES FOR CLASSIC COMPLETE



STEP 1 PICK A WARDROBE COMBINATION

STEP 1: SUPPLY ONLY OR INSTALLATION	
KD	Supply only
KC	Installation available on request

STEP 2: SELECT A RANGE	
01	Chapter
02	Origin

STEP 3: SELECT A DOOR COLOUR	
01	Partridge Grey
02	Porcelain
03	Stone
XX	Paint-to-order

STEP 4: SELECT A WARDROBE SIZE	
SR400L	Single robe 400mm (hinged on left)
SR400R	Single robe 400mm (hinged on right)
SR450L	Single robe 450mm (hinged on left)
SR450R	Single robe 450mm (hinged on right)
SR500L	Single robe 500mm (hinged on left)
SR500R	Single robe 500mm (hinged on right)
SRM500L	Single robe 500mm mirror (hinged on left)
SRM500R	Single robe 500mm mirror (hinged on right)
DR800	Double robe 800mm
DR900	Double robe 900mm
DR1000	Double robe 1000mm
DMM1000L	Double robe mirror hinged on left
DMM1000R	Double robe mirror hinged on right
DRM1000	Double robe mirror doors
CR1000L	Corner robe hinged on left 1000mm
CR1000R	Corner robe hinged on right 1000mm
CRM1000L	Corner robe mirror hinged on left 1000mm
CRM1000R	Corner robe mirror hinged on right 1000mm
FS400	Single feature storage box 400mm
FS450	Single feature storage box 450mm
FS500	Single feature storage box 500mm
FS1000	Double feature storage box 1000mm

For example: KD0101SR400L = Chapter partridge grey single robe hinged on left (when installed)



STEP 2 CHOOSE YOUR WARDROBE ACCESSORIES

STEP 1: SUPPLY ONLY or INSTALLATION	
KD	Supply only
KC	Installation available on request

STEP 2: SELECT A RANGE (MATCHING)	
01	Chapter
02	Origin

STEP 3: SELECT A COLOUR	
01	Partridge Grey
02	Porcelain
03	Stone
XX	Paint-to-order

STEP 4: SELECT EXTERNAL ACCESSORIES	
TO COMPLETE STEP 4	
Choose one of the following options per a product code	
For cornice, end product code with one of the below:	
CO3050	Moulded Cornice 3050mm
CS3050	Cornice 3050mm
For plinth, end product code with one of the below:	
MP3050	Moulded plinth 3050mm
SP3050	Classic plinth 3050mm
CP3050	Custom fit plinth 3050mm
For end panel, end code with one of the below:	
EP2400	End panel 2400mm
For feature post, end code with one of the below:	
FPV2400	Feature end post with 3 fillers
FPH3050	Tall feature end post with 3 fillers
For passepartout, end code with one of the below:	
PS7200	Small passepartout pack 2400mm
PL7850	Large passepartout pack 3050mm
ET5000	Edging tape

Cornice example: KD0101CO3050
Plinth example: KD0101SP3050
End Panel example: KD0101EP2400





THE COMPLETE COLLECTION CHAPTER

PHOTOGRAPHY: CHAPTER SHOWN IN STONE.

A classic shaker door available in three painted colours. The simple profile, ornate beading and neutral colour palette all help to create an elegant interior. Our complete collection includes everything you will need to build your wardrobe.

KEY FEATURES

- Classic Shaker with beading
- Choice of three paint effect colours
- Textured finish, giving the look and feel close to real timber
- Mirrored options available
- 19mm thickness door
- Paint-to-order service available (excludes chests)

HINGES

Pre-drilled for hinge positions

4 X soft close Blum hinges and hinge plates are supplied with wardrobe frontals

2 X soft close Blum hinges and hinge plates are supplied with feature storage frontals

HANDED

Doors are left and right handed

HANDLES

Handles are not included. Please see section 4 for handle options.

CHAPTER COMPLETE



*Lead-time based on orders placed before 5pm, Tuesday cut-off.
PAINT-TO-ORDER



Stocked Range

TEXTURED WOODGRAIN



PARTRIDGE GREY



PORCELAIN



STONE

XX

O1

O2

O3

	Width	H	Product code	Description
Single Robe	400	LH RH	KD01**SR400L	2260(H)x400(W)x610mm(D)
			KD01**SR400R	
	450	LH RH	KD01**SR450L	2260(H)x450(W)x610mm(D)
KD01**SR450R				
500	LH RH	KD01**SR500L	2260(H)x500(W)x610mm(D)	
		KD01**SR500R		
Single Mirrored Robe	500	LH RH	KD01**SRM500L	2260(H)x500(W)x610mm(D)
			KD01**SRM500R	
Double Robe	800	n/a	KD01**DR800	2260(H)x800(W)x610mm(D)
	900	n/a	KD01**DR900	2260(H)x900(W)x610mm(D)
	1000	n/a	KD01**DR1000	2260(H)x1000(W)x610mm(D)
Double Robe, Single Mirror	1000	LH RH	KD01**DMM1000L	2260(H)x1000(W)x610mm(D)
			KD01**DMM1000R	

	Width	H	Product code	Description
Double Mirrored Robe	1000	n/a	KD01**DRM1000	2260(H)x1000(W)x610mm(D)
Corner Robe	1000	LH RH	KD01**CR1000L	2260(H)x1000(W)x610mm(D)
			KD01**CR1000R	
Corner Robe with Mirror	1000	LH RH	KD01**CRM1000L	2260(H)x1000(W)x610mm(D)
			KD01**CRM1000R	
Single Feature Storage Unit	400	n/a	KD01**FS400	450(H)x400(W)x430mm(D)
	450	n/a	KD01**FS450	450(H)x450(W)x430mm(D)
	500	n/a	KD01**FS500	450(H)x500(W)x430mm(D)
Double Feature Storage Unit	1000		KD01**FS1000	450(H)x1000(W)x430mm(D)
Sample Door	400	n/a	KD01**SAM397	Sample Door, 447(H)x397(W)x19mm(D)

CHAPTER COMPLETE | Range Content



PAINT-TO-ORDER (XX)
15 working days
9 days remedial

TEXTURED WOODGRAIN



PARTRIDGE GREY

PORCELAIN

STONE

01

02

03

ACCESSORIES

When ordering, use the colour reference code in place of **

CORNICE



Moulded Cornice
3050x70x109mm
KD01**CO3050



Classic Cornice
3050x66x76mm
KD01**CS3050

PLINTH



Moulded Plinth
3050x100x25mm
KD01**MP3050



Classic Plinth
3050x100x19mm
KD01**SP3050



Custom Fit Plinth
3050x160x19mm
KD01**CP3050

FEATURE POSTS



Feature End Post
2400x100x50mm
KD01**FPV2400



Tall Feature End Post
3050x100x50mm
KD01**FPH3050

PASSEPARTOUT



Small Passepartout Pack
3 x 2400x100x50mm
KD01**PS7200



Large Passepartout Pack
2 x 2400x100x50mm and
1 x 3050x100x50mm
KD01**PL7850

END PANELS



End Panel
2400x650x19mm
KD01**EP2400

EDGING TAPE



Edging Tape
5mx23mmx0.5mm
KD01**ET5000

CHESTS

When ordering, use the colour reference code in place of **
Use codes below for flat-packed. Add an 'A' for assembled
For example: KD03**2D486 (flat-packed), KD03**2D486A (assembled)

Paint-to-order not available on Chests

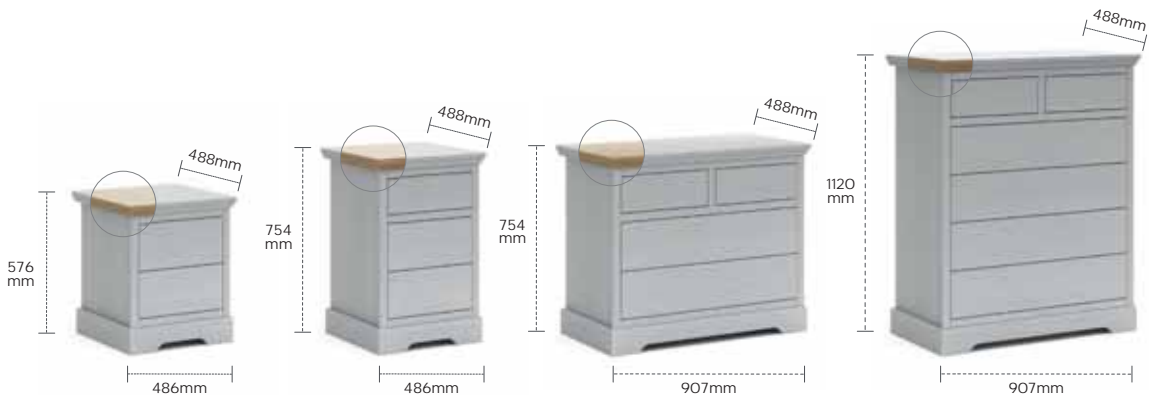

Matching Top:
Oak Effect Top:
2 Drawer Bedside
KD03**2D486
KD03**2DO486

3 Drawer Bedside
KD03**3D486
KD03**3DO486

2 + 2 Drawer
KD03**4D907
KD03**4DO907

4 + 2 Drawer
KD03**6D907
KD03**6DO907



Matching Top:
Oak Effect Top:
Dressing Table
KD03**DT1500
KD03**DTO1500



Custom Fit Desk
KD03**DK2400
KD03**DKO2400

* NOTE: Custom Panel - Oak Effect
2260 x 750 x 22mm

* NOTE: Matching Colour
2400 x 650 x 19mm



Paint-to-Order
Service



Shown above: Chapter shown in Partridge Grey and bedside chest with Oak effect top

DETAIL



2 drawer bedside chest with Oak effect top



3 drawer bedside chest with matching top



4 + 2 wide chest with matching top

THE COMPONENT COLLECTION

CHAPTER

A classic shaker door available in three paint effect woodgrain colours. The simple profile, ornate beading and neutral colour palette all help to create an elegant interior. Our complete collection includes everything you will need to build your wardrobe.

PHOTOGRAPHY: CHAPTER SHOWN IN STONE.

KEY FEATURES

- Beaded Shaker door
- Choice of three paint effect colours
- Textured finish, giving the look and feel close to real timber
- Mirrored options available
- 19mm thickness door
- Paint to order service available (excludes chests)

CHAPTER COMPONENT

STOCKED
PAINT-TO-ORDER



Stocked Range



Paint-to-Order Service



STOCKED FINISHES

Colour reference code shown below door.

TEXTURED DOOR FINISHES



PARTRIDGE GREY

PORCELAIN

STONE

01

02

03

MIRROR



AVAILABLE IN ALL COLOURS

SERVICE OPTIONS



PAINT-TO-ORDER (XX)

15 working days
9 days remedial

Dark colours will be painted on a lighter material. When painting a mirror door you may be able to see a small reflection of the lighter finish around the edge of the mirror.

Due to the manufacturing process of the Chapter & Origin Mirror doors, you may see a line of the lighter primary material around the edge of the mirror, which is more noticeable on the darker painted finishes.

FRONTAL SPECIFICATION:

DOOR STYLE	Classic Shaker with Beading. 7 piece wardrobe door construction. 5 piece feature door construction
DOOR THICKNESS	19mm
DOOR WIDTH	397/447/497mm
SPECIFICATION:	Shaker profile with Beading

STILE WIDTH	85mm
MID RAIL WIDTH	95mm
CENTRE PANEL RECESSED	6mm

FINISH:	Alfatherm foil finish - woodgrain / paint effect 19mm wrapped MDF
----------------	--

DOOR DETAIL



FOR TOUCH-UP LACQUER /CARE & MAINTENANCE KITS SEE PAGE 1.63.

DOOR FINISH	COMPLEMENTARY BOARD MATCHES
Porcelain	Egger W1200 Porcelain White
Partridge Grey	Egger U708 Light Grey
Stone	Egger U702 ST27 Cashmere Grey

CHEST TOP FINISH

Matching as above or Textured Oak Effect
H3368 Natural Lancaster Oak ST9



MATCHING



TEXTURED OAK EFFECT

CHAPTER COMPONENT | Range Content

Codes stated are suffix codes. Colour reference code for door must be used when ordering.

DOORS

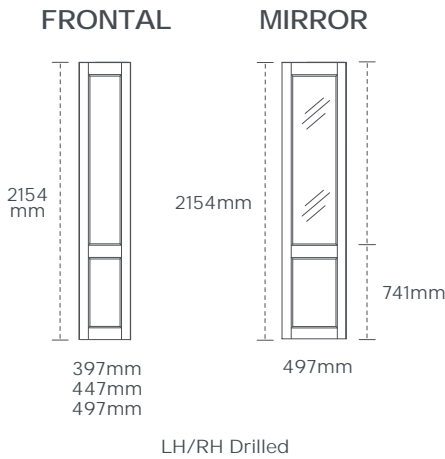

FEATURE STORAGE DOORS

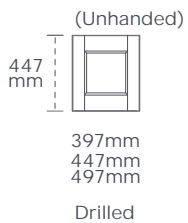

	Product code	Description	Handed
	KD01**SAM397	Sample Door, 447x397x19mm	Unhanded
	KD01**FD397	447x397x19mm, Drilled	Unhanded
	KD01**FD447	447x447x19mm, Drilled	Unhanded
	KD01**FD497	447x497x19mm, Drilled	Unhanded
	KD01**BD397L	2154x397x19mm, Robe Frontal, LH Drilled	LH
	KD01**BD397R	2154x397x19mm, Robe Frontal, RH Drilled	RH
	KD01**BD447L	2154x447x19mm, Robe Frontal, LH Drilled	LH
	KD01**BD447R	2154x447x19mm, Robe Frontal, RH Drilled	RH
	KD01**BD497L	2154x497x19mm, Robe Frontal, LH Drilled	LH
	KD01**BD497R	2154x497x19mm, Robe Frontal, RH Drilled	RH
	KD01**BDM497L	2154x497x19mm, Mirrored Robe Frontal, LH Drilled	LH
	KD01**BDM497R	2154x497x19mm, Mirrored Robe Frontal, RH Drilled	RH

ACCESSORIES

When ordering, use the colour reference code in place of **

CORNICE

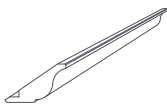

Moulded Cornice
3050x70x109mm
KD01**CO3050

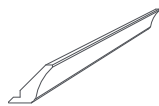

Classic Cornice
3050x66x76mm
KD01**CS3050

PLINTH

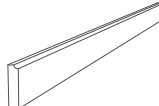

Moulded Plinth
3050x100x25mm
KD01**MP3050



Classic Plinth
3050x100x19mm
KD01**SP3050

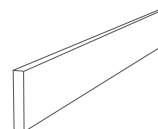

Custom Fit Plinth
3050x160x19mm
KD01**CP3050

CORNER POST



Corner Post for corner robe
2260x105x58mm
KD01**CRP2260

FEATURE POSTS

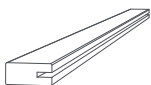

Feature End Post
2400x100x50mm
KD01**FPV2400

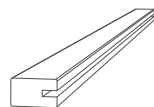

Tall Feature End Post
3050x100x50mm
KD01**FPH3050

PASSEPARTOUT

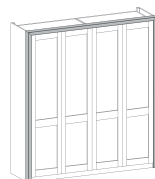

Small Passepartout Pack
3 x 2400x100x50mm
KD01**PS7200

Large Passepartout Pack
2 x 2400x100x50mm and
1 x 3050x100x50mm
KD01**PL7850

END PANELS



End Panel
2400x650x19mm
KD01**EP2400

EDGING TAPE



Edging Tape
5mx23mmx0.5mm
KD01**ET5000

CHESTS



2 Drawer Bedside



4 Drawer Bedside



2 + 2 Drawer



4 + 2 Drawer

Paint-to-order not available on Chests

Matching Chests can be bought through our Complete Range - see page 1.13



PAINT-TO-ORDER
(XX)
15 working days
9 days remedial

TEXTURED WOODGRAIN



PARTRIDGE
GREY

PORCELAIN

STONE

01

02

03



Shown above: Chapter shown in Oak effect

DETAIL



Feature storage unit doors used as seating area (Oak effect finish)



Moulded cornice, feature end post and end panel (Partridge Grey finish)



Feature end post and end panel (Stone finish)



THE COMPLETE COLLECTION

ORIGIN

PHOTOGRAPHY: ORIGIN SHOWN IN STONE.

A crisp shaker design available in three paint effect colours to allow the range to sit comfortably in both modern and period homes.

The range includes feature mirrored doors to offer additional design versatility.

Our complete collection includes everything you will need to build your wardrobe.

KEY FEATURES

- 19mm thickness door
- Classic Shaker
- Available in 3 paint effect colours
- Doors available as single, double and mirrored
- Paint-to-order service available (excludes chests)

HINGES

Pre-drilled for hinge positions

4 x soft close Blum hinges are supplied with the frontals

2 x soft close Blum hinges and hinge plates are supplied with feature storage frontals

HANDED

Doors are left and right handed

HANDLES

Handles are not included. Please see section 4 for handle options.

ORIGIN COMPLETE



TEXTURED WOODGRAIN

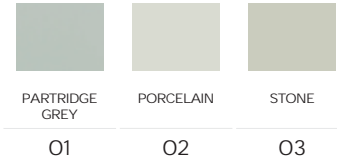

	Width	H	Product code	Description
Single Robe	400		LH KD02**SR400L	2260(H)x400(W)x610mm(D)
			RH KD02**SR400R	
	450		LH KD02**SR450L	2260(H)x450(W)x610mm(D)
RH KD02**SR450R				
	500		LH KD02**SR500L RH KD02**SR500R	2260(H)x500(W)x610mm(D)
Single Mirrored Robe	500		LH KD02**SRM500L	2260(H)x500(W)x610mm(D)
			RH KD02**SRM500R	
Double Robe	800	n/a	KD02**DR800	2260(H)x800(W)x610mm(D)
	900	n/a	KD02**DR900	2260(H)x900(W)x610mm(D)
	1000	n/a	KD02**DR1000	2260(H)x1000(W)x610mm(D)
Double Robe, Single Mirror	1000		LH KD02**DMM1000L	2260(H)x1000(W)x610mm(D)
			RH KD02**DMM1000R	

	Width	H	Product code	Description
Double Mirrored Robe	1000	n/a	KD02**DRM1000	2260(H)x1000(W)x610mm(D)
Corner Robe	1000		LH KD02**CR1000L	2260(H)x1000(W)x610mm(D)
			RH KD02**CR1000R	
Corner Robe with Mirror	1000		LH KD02**CRM1000L	2260(H)x1000(W)x610mm(D)
			RH KD02**CRM1000R	
Single Feature Storage Unit	400	n/a	KD02**FS400	450(H)x400(W)x430mm(D)
	450	n/a	KD02**FS450	450(H)x450(W)x430mm(D)
	500	n/a	KD02**FS500	450(H)x500(W)x430mm(D)
Double Feature Storage Unit	1000		KD02**FS1000	450(H)x1000(W)x430mm(D)
Sample Door	400	n/a	KD02**SAM397	Sample Door, 447(H)x397(W)x19mm(D)

ORIGIN COMPLETE | Range Content



PAINT-TO-ORDER (XX)
15 working days
9 days remedial

TEXTURED WOODGRAIN



PARTRIDGE GREY

PORCELAIN

STONE

01

02

03

ACCESSORIES

When ordering, use the colour reference code in place of **

CORNICE



Moulded Cornice
3050x70x109mm
KD02**CO3050



Classic Cornice
3050x66x76mm
KD02**CS3050

PLINTH



Moulded Plinth
3050x100x25mm
KD02**MP3050



Classic Plinth
3050x100x19mm
KD02**SP3050



Custom Fit Plinth
3050x160x19mm
KD02**CP3050

FEATURE POSTS



Feature End Post
2400x100x50mm
KD02**FPV2400



Tall Feature End Post
3050x100x50mm
KD02**FPH3050

PASSEPARTOUT



Small Passepartout Pack
3 x 2400x100x50mm
KD02**PS7200



Large Passepartout Pack
2 x 2400x100x50mm and
1 x 3050x100x50mm
KD02**PL7850

END PANELS



End Panel
2400x650x19mm
KD02**EP2400

EDGING TAPE



Edging Tape
5mx23mmx0.5mm
KD02**ET5000

CHESTS

When ordering, use the colour reference code in place of **
Use codes below for flat-packed. Add an 'A' for assembled
For example: KD03**2D486 (flat-packed), KD03**2D486A (assembled)

Paint-to-order not available on Chests

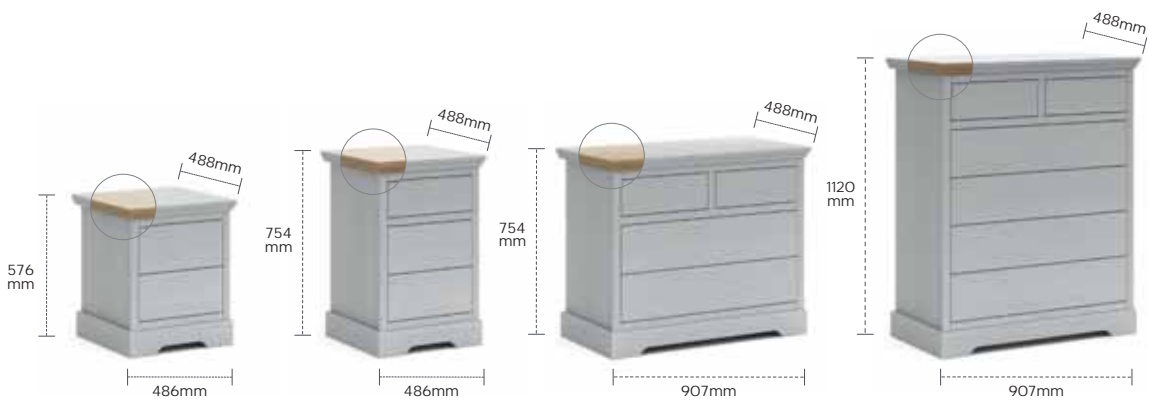

Matching Top: KD03**2D486
Oak Effect Top: KD03**2DO486

2 Drawer Bedside
KD03**2D486

3 Drawer Bedside
KD03**3D486
KD03**3DO486

2 + 2 Drawer
KD03**4D907
KD03**4DO907

4 + 2 Drawer
KD03**6D907
KD03**6DO907



Matching Top: KD03**DT1500
Oak Effect Top: KD03**DTO1500

Dressing Table
KD03**DT1500
KD03**DTO1500



Custom Fit Desk
KD03**DK2400
KD03**DKO2400

* NOTE: Custom Panel - Oak Effect
2260 x 750 x 22mm

* NOTE: Matching Colour
2400 x 650 x 19mm



Paint-to-Order
Service



Shown above: Origin shown in Porcelain with feature storage units and a 4 + 2 chest with Oak effect top

DETAIL



KDH3024



Edge detail Oak effect chest top



Additional linen internals



THE COMPONENT COLLECTION

ORIGIN

A classic shaker door available in three paint effect woodgrain colours to allow the range to sit comfortably in both modern and period homes. The range includes feature mirrored doors to offer additional design versatility.

PHOTOGRAPHY: ORIGIN SHOWN IN PARTRIDGE GREY.

KEY FEATURES

- Shaker door
- Choice of **3 paint effect colours**
- **Textured finish, giving the look and feel close to real timber**
- Mirrored options available
- 19mm thickness door
- Paint to order service available (excludes chests)

ORIGIN COMPONENT

STOCKED
PAINT-TO-ORDER



Stocked Range



Paint-to-Order Service



STOCKED FINISHES

Colour reference code shown below door.

TEXTURED DOOR FINISHES



PARTRIDGE GREY

PORCELAIN

STONE

01

02

03

MIRROR



AVAILABLE IN ALL COLOURS

SERVICE OPTIONS



PAINT-TO-ORDER (XX)
15 working days
9 days remedial

Dark colours will be painted on a lighter material. When painting a mirror door you may be able to see a small reflection of the lighter finish around the edge of the mirror.

Due to the manufacturing process of the Chapter & Origin Mirror doors, you may see a line of the lighter primary material around the edge of the mirror, which is more noticeable on the darker painted finishes.

FRONTAL SPECIFICATION:

DOOR STYLE	Classic Shaker. 7 piece wardrobe door construction. 5 piece feature door construction
DOOR THICKNESS	19mm
DOOR WIDTH	397, 447, 497

STILE WIDTH	85mm
MID RAIL WIDTH	95mm
CENTRE PANEL RECESSED	6mm

FINISH:	Alfatherm foil finish - woodgrain / paint effect 19mm wrapped MDF
----------------	--

DOOR DETAIL



FOR TOUCH-UP LACQUER /CARE & MAINTENANCE KITS
SEE PAGE 1.63.

DOOR FINISH	COMPLEMENTARY BOARD MATCHES
Porcelain	Egger W1200 Porcelain White
Partridge Grey	Egger U708 Light Grey
Stone	Egger U702 ST27 Cashmere Grey

CHEST TOP FINISH

Matching as above or Textured Oak Effect
H3368 Natural Lancaster Oak ST9



MATCHING



TEXTURED OAK EFFECT

ORIGIN COMPONENT | Range Content

Codes stated are suffix codes. Colour reference code for door must be used when ordering.

DOORS

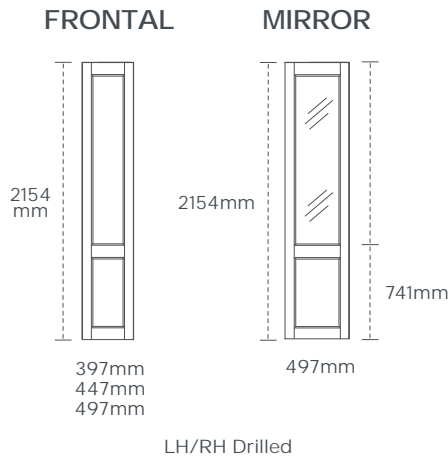

FEATURE STORAGE DOORS

(Unhanded)

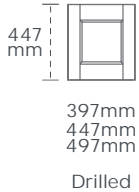

	Product code	Description	Handed
	KD02**SAM397	Sample Door, 447x397x19mm	Unhanded
	KD02**FD397	447x397x19mm, Drilled	Unhanded
	KD02**FD447	447x447x19mm, Drilled	Unhanded
	KD02**FD497	447x497x19mm, Drilled	Unhanded
	KD02**BD397L	2154x397x19mm, Robe Frontal, LH Drilled	LH
	KD02**BD397R	2154x397x19mm, Robe Frontal, RH Drilled	RH
	KD02**BD447L	2154x447x19mm, Robe Frontal, LH Drilled	LH
	KD02**BD447R	2154x447x19mm, Robe Frontal, RH Drilled	RH
	KD02**BD497L	2154x497x19mm, Robe Frontal, LH Drilled	LH
	KD02**BD497R	2154x497x19mm, Robe Frontal, RH Drilled	RH
	KD02**BDM497L	2154x497x19mm, Mirrored Robe Frontal, LH Drilled	LH
	KD02**BDM497R	2154x497x19mm, Mirrored Robe Frontal, RH Drilled	RH

ACCESSORIES

When ordering, use the colour reference code in place of **

CORNICE

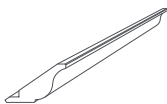

Moulded Cornice
3050x70x109mm
KD02**CO3050

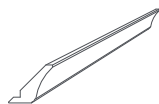

Classic Cornice
3050x66x76mm
KD02**CS3050

PLINTH

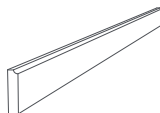

Moulded Plinth
3050x100x25mm
KD02**MP3050

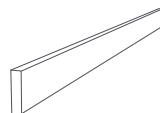

Classic Plinth
3050x100x19mm
KD02**SP3050

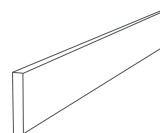

Custom Fit Plinth
3050x160x19mm
KD02**CP3050

CORNER POST



Corner Post for corner robe
2260x105x58mm
KD02**CRP2260

FEATURE POSTS

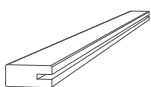

Feature End Post
2400x100x50mm
KD02**FPV2400

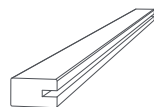

Tall Feature End Post
3050x100x50mm
KD02**FPH3050

PASSEPARTOUT

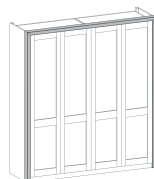

Small Passepartout Pack
3 x 2400x100x50mm
KD02**PS7200

Large Passepartout Pack
2 x 2400x100x50mm and
1 x 3050x100x50mm
KD02**PL7850

END PANELS



End Panel
2400x650x19mm
KD02**EP2400

EDGING TAPE



Edging Tape
5mx23mmx0.5mm
KD02**ET5000

CHESTS



2 Drawer Bedside



4 Drawer Bedside



2 + 2 Drawer



4 + 2 Drawer

Paint-to-order not available on Chests

Matching Chests can be bought through our Complete Range - see page 1.21



TEXTURED WOODGRAIN



PAINT-TO-ORDER
(XX)
15 working days
9 days remedial

PARTRIDGE
GREY
01

PORCELAIN
02

STONE
03



Shown above: Origin shown in Stone. Chest tops in Oak effect

DETAIL



Chest Oak effect top detail



KDH3020



Internals in Oak effect



THE MODERN COLLECTION

PHOTOGRAPHY: SCULPT SHOWN IN STORM BLUE PAINT-TO-ORDER

PRODUCT CODES FOR MODERN COMPLETE



STEP 1 PICK A WARDROBE COMBINATION

STEP 1: SUPPLY ONLY OR INSTALLATION	
KD	Supply only
KC	Installation available on request

STEP 2: SELECT A RANGE	
04	Esker
05	Parity Matt
06	Parity Gloss
09	Sculpt

STEP 3: SELECT A DOOR COLOUR	
04	Cashmere
05	Dove Grey
06	Anthracite (MATT ONLY)
07	White
XX	Paint-to-order

STEP 4: SELECT A WARDROBE SIZE	
SR400	Single robe 400mm (unhanded)
SR450	Single robe 450mm (unhanded)
SR500	Single robe 500mm (unhanded)
DR800	Double robe 800mm
DR900	Double robe 900mm
DR1000	Double robe 1000mm
DMM1000L	Double robe mirror hinged on left
DMM1000R	Double robe mirror hinged on right
DRM1000	Double robe mirror doors
DMG1000L	Double robe glass hinged on left
DMG1000R	Double robe glass hinged on right
CMS1000L / CRS1000L	Double stable robe hinged on left
CMS1000R / CRS1000R	Double stable robe hinged on right
CR1000	Double corner robe
CRM1000L	Corner robe mirror hinged on left
CRM1000R	Corner robe mirror hinged on right
CRG1000L	Corner robe glass hinged on left
CRG1000R	Corner robe glass hinged on right
FS400	Single feature storage box 400mm
FS450	Single feature storage box 450mm
FS500	Single feature storage box 500mm
FS1000	Double feature storage box 1000mm

For example: KD0504SR400L = Parity Matt cashmere single robe 400mm unhanded (supply only)

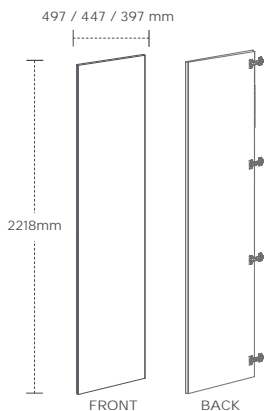

STEP 2 CHOOSE YOUR WARDROBE ACCESSORIES

STEP 1: SUPPLY ONLY or INSTALLATION	
KD	Supply only
KC	Installation available on request

STEP 2: SELECT A RANGE (MATCHING)	
04	Esker
05	Parity Matt
06	Parity Gloss
09	Sculpt

STEP 3: SELECT A COLOUR	
04	Cashmere
05	Dove Grey
06	Anthracite (MATT ONLY)
07	White
XX	Paint-to-order

STEP 4: SELECT EXTERNAL ACCESSORIES	
TO COMPLETE STEP 4	
Choose one of the following options per a product code	
For cornice, end product code with one of the below:	
CO3050	Cornice 3050mm
For plinth, end product code with one of the below:	
SP3050	Standard plinth 3050mm
CP3050	Custom fit plinth 3050mm
For end panel, end code with one of the below:	
EP2400	End panel 2400mm
For feature post, end code with one of the below:	
FPV2400	Feature post/vertical passepartout 2400mm
FPH3050	Feature post/horizontal passepartout 3050mm
For passepartout pack, end code with one of the below:	
PS7200	Small passepartout pack
PL7850	Large passepartout pack

Cornice example: KD0504CO3050
Custom fit plinth example: KD0504CP3050
End panel example: KDC0504EP2400



Paint-to-Order (XX)
15 working days
9 days remedial

AVAILABLE COLOURS:

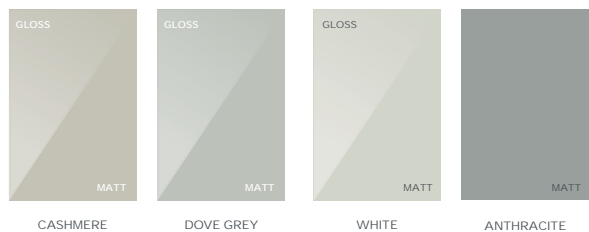



THE COMPLETE COLLECTION

ESKER

PHOTOGRAPHY: ESKER SHOWN IN MATT ANTHRACITE.

Available in matt painted finishes and coupled with subtle contours adds to the sophistication of this range and creates a soft variation within the modern collection.

The range includes feature mirrored doors to offer additional design versatility.

Our complete collection includes everything you will need to build your wardrobe.

KEY FEATURES

- Shallow modern shaker profile
- Available in three matt colours
- 18.5mm thickness door
- The range includes matching feature storage doors
- Paint-to-order service available (excludes chests)

HINGES

Pre-drilled for hinge positions

4 x soft close Blum hinges are supplied with the frontals

2 x soft close Blum hinges and hinge plates are supplied with feature storage frontals

HANDED

Doors are left and right handed

HANDLES

Handles are not included. Please see section 4 for handle options.

1.29

Your one-stop-shop: www.pws.co.uk/bedrooms

ESKER COMPLETE



Stocked Range



CASHMERE

04



DOVE GREY

05



ANTHRACITE

06

XX

	Width	H	Product code	Description
Single Robe	400		LH KD04**SR400L	2260(H)x400(W)x610mm(D)
			RH KD04**SR400R	
			LH KD04**SR450L	2260(H)x450(W)x610mm(D)
RH KD04**SR450R				
	450		LH KD04**SR500L	2260(H)x500(W)x610mm(D)
			RH KD04**SR500R	
Single Mirrored Robe		500	LH KD04**SRM500L	2260(H)x500(W)x610mm(D)
			RH KD04**SRM500R	
Double Robe	800	n/a	KD04**DR800	2260(H)x800(W)x610mm(D)
			KD04**DR900	2260(H)x900(W)x610mm(D)
			KD04**DR1000	2260(H)x1000(W)x610mm(D)
Double Robe, Single Mirror	1000		LH KD04**DMM1000L	2260(H)x1000(W)x610mm(D)
			RH KD04**DMM1000R	

	Width	H	Product code	Description
Double Mirrored Robe	1000	n/a	KD04**DRM1000	2260(H)x1000(W)x610mm(D)
Corner Robe	1000		LH KD04**CR1000L	2260(H)x1000(W)x610mm(D)
			RH KD04**CR1000R	
Corner Robe with Mirror	1000		LH KD04**CRM1000L	2260(H)x1000(W)x610mm(D)
			RH KD04**CRM1000R	
Single Feature Storage Unit	400	n/a	KD04**FS400	450(H)x400(W)x430mm(D)
			KD04**FS450	450(H)x450(W)x430mm(D)
			KD04**FS500	450(H)x500(W)x430mm(D)
Double Feature Storage Unit	1000		KD04**FS1000	450(H)x1000(W)x430mm(D)
Sample Door	400	n/a	KD04**SAM397	Sample Door, 447(H)x397(W)x18.5mm(D)



PAINT-TO-ORDER
(XX)
15 working days
9 days remedial



CASHMERE
04



DOVE GREY
05



ANTHRACITE
06

ACCESSORIES

When ordering, use the colour reference code in place of **

CORNICE



Modern Cornice
3050x28x50mm
KDO4**CO3050



Plinth
3050x36x18.5mm
KDO4**SP3050



Custom Fit Plinth
3050x160x18.5mm
KDO4**CP3050

FEATURE POSTS



Feature End Post
(with 3 fillers)
2400x100x50mm
KDO4**FPV2400



Feature End Post
(with 1 filler)
3050x100x50mm
KDO4**FPH3050

PASSEPARTOUT



Small Passepartout Pack
3 x 2400x100x50mm
KDO4**PS7200



Large Passepartout Pack
2 x 2400x100x50mm and
1 x 3050x100x50mm
KDO4**PL7850

END PANELS



End Panel
2400x650x18.5mm
KDO4**EP2400

CHESTS

Paint-to-order not available on Chests

When ordering, use the colour reference code in place of **
Supplied fully assembled only.

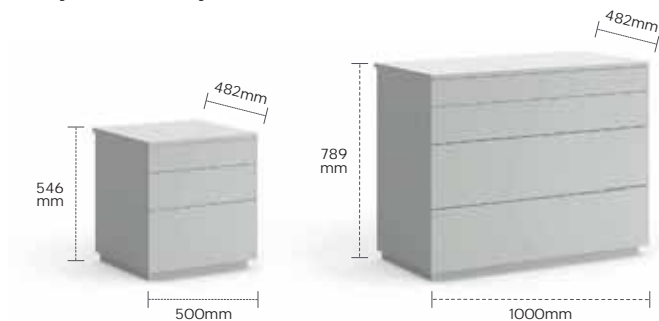

3 Drawer Bedside
Matt: KD11**3D500A

4 Drawer Wide Chest
KD11**4D1000A



Paint-to-Order
Service



Shown above: Esker shown in Matt Cashmere

DETAIL



Esker shown in Matt Cashmere with Walnut effect accessories



Chest detail



Esker mirror doors shown in Matt Cashmere

THE COMPONENT COLLECTION

ESKER

Esker combines classic design principles with contemporary vision. Available in matt painted finishes and coupled with subtle contours adds to the sophistication of this range and creates a soft variation within the modern collection.

The range includes feature mirrored doors to offer additional design versatility.

PHOTOGRAPHY: ESKER IN MATT CASHMERE.

KEY FEATURES

- **Shallow modern shaker profile**
- Available in three matt colours
- 18.5mm thickness door
- The range includes matching feature storage doors
- Paint-to-order service available

ESKER COMPONENT

STOCKED
PAINT-TO-ORDER
MATT ONLY



Lacquered/
Painted



Stocked
Range



Paint-to-Order
Service



STOCKED FINISHES

Colour reference code shown below door.

DOOR FINISHES



CASHMERE
MATT ONLY

DOVE GREY
MATT ONLY

ANTHRACITE
MATT ONLY

O4

O5

O6

Please see pages 1.54 for all Feature Door information.

SERVICE OPTIONS



PAINT-TO-ORDER
(XX)

15 working days
9 days remedial

MIRROR



AVAILABLE IN
ALL COLOURS

FRONTAL SPECIFICATION:

DOOR STYLE	Shallow modern shaker profile
DOOR THICKNESS	18.5mm
DOOR WIDTH	397, 447, 497mm

FEATURE MIRROR FRONTAL

HEIGHT	2218mm
WIDTH	497mm

FEATURE STORAGE

FRONTAL HEIGHT	447mm
FRONTAL WIDTH	397, 447, 497mm

ESKER STILE/ FRAME WIDTH (FOR WARDROBE AND FEATURE DOOR FRONTS)	90mm
MID AND BOTTOM STILE/FRAME WIDTH	140mm

SPECIFICATION:	Painted MDF
FINISH:	Painted matt lacquer

DOOR DETAIL



FOR TOUCH-UP LACQUER /CARE & MAINTENANCE KITS
SEE PAGE 1.63.

DOOR FINISH	COMPLEMENTARY BOARD MATCHES
MODERN - MATT	
Cashmere	U702 ST9 Cashmere Grey
Dove Grey	U708 ST9 Light Grey
Anthracite	U732 ST9 Dust Grey

Codes stated are suffix codes. Colour reference code for door must be used when ordering.

DOORS

FRONTAL

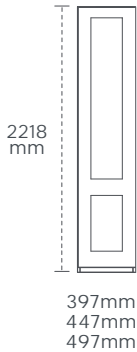



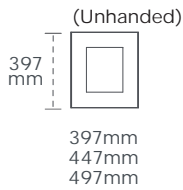

FEATURE STORAGE DOORS

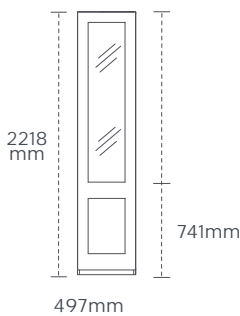

FEATURE MIRROR



	Product code	Description	Handed
	KD04**SAM397	Sample Door, 447x397x18.5mm	Unhanded
	KD04**FD397	447x397x18.5mm, Drilled	Unhanded
	KD04**FD447	447x447x18.5mm, Drilled	Unhanded
	KD04**FD497	447x497x18.5mm, Drilled	Unhanded
	KD04**BD397L	2218x397x18.5mm, Robe Frontal, LH Drilled	LH
	KD04**BD397R	2218x397x18.5mm, Robe Frontal, RH Drilled	RH
	KD04**BD447L	2218x447x18.5mm, Robe Frontal, LH Drilled	LH
	KD04**BD447R	2218x447x18.5mm, Robe Frontal, RH Drilled	RH
	KD04**BD497L	2218x497x18.5mm, Robe Frontal, LH Drilled	LH
	KD04**BD497R	2218x497x18.5mm, Robe Frontal, RH Drilled	RH
	KD04**BDM497L	2218x497x18.5mm, Mirrored Robe Frontal, LH Drilled	LH
	KD04**BDM497R	2218x497x18.5mm, Mirrored Robe Frontal, RH Drilled	RH

ACCESSORIES

When ordering, use the colour reference code in place of **

CORNICE

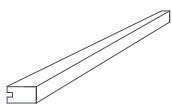

Modern Cornice
3050x28x50mm
KD04**CO3050

PLINTH



Plinth
3050x36x18.5mm
KD04**SP3050



Custom fit plinth
3050x160x18.5mm
KD04**CP3050

END PANELS



End Panel
2400x650x18.5mm
KD04**EP2400

CORNER POST



Corner Post for corner robe
2260x105x58mm
KD04**CRP2260

FEATURE POSTS

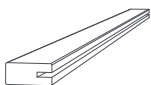

Feature Post 2400mm
1 x 2400x50x100mm
KD04**FPV2400

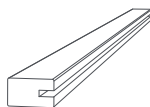

Feature Post 3050mm
1 x 3050x50x100mm
KD04**FPH3050

PASSEPARTOUT

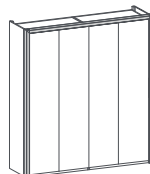

Small Passepertout Pack
3 x 2400x50x100mm
KD04**PS7200

Large Passepertout Pack
2 x 2400x50x100mm
1 x 3050x50x100mm
KD04**PL7850

CHESTS

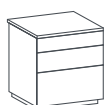

3 Drawer Bedside

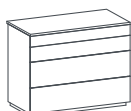

4 Drawer Wide Chest

Matching Chests can be bought through our Complete Range - see page 1.31

Paint-to-order not available on Chests



PAINT-TO-ORDER
(XX)
15 working days
9 days remedial



CASHMERE
04



DOVE GREY
05



ANTHRACITE
06



Shown above: Esker shown in Matt Anthracite

DETAIL



Esker bedside chest in Matt Anthracite



Internals in linen



Esker Cashmere with feature doors



THE COMPLETE COLLECTION
PARITY

PHOTOGRAPHY: PARITY SHOWN IN MATT CASHMERE.

Parity's simple form and linear appearance can adapt to any space to create a minimalist look. Handles can be selected to suit the customer's individual style.

Feature mirrored and featured glass doors are offered to create additional design versatility.

Our complete collection includes everything you will need to build your wardrobe.

KEY FEATURES

- Available in four colours
- Matt and gloss finishes (excluding Anthracite)
- Handles can be chosen separately
- Featured doors available
- Paint-to-order service available (excludes chests)

HINGES

Pre-drilled for hinge positions

4 x soft close Blum hinges and hinge plates are supplied with wardrobe frontals

2 x soft close Blum hinges and hinge plates are supplied with feature storage frontals

HANDED

Doors are unhandled

HANDLES

Handles are not included. Please see section 4 for handle options.

PARITY COMPLETE



CASHMERE MATT & GLOSS	DOVE GREY MATT & GLOSS	ANTHRACITE MATT ONLY	WHITE MATT & GLOSS
04	05	06	07

XX

	Width	H	Product code	Description
Single Robe 	400	n/a	Matt KD05**SR400 Gloss KD06**SR400	2260(H)x400(W)x610mm(D)
	450	n/a	Matt KD05**SR450 Gloss KD06**SR450	2260(H)x450(W)x610mm(D)
	500	n/a	Matt KD05**SR500 Gloss KD06**SR500	2260(H)x500(W)x610mm(D)
Double Robe 	800	n/a	Matt KD05**DR800 Gloss KD06**DR800	2260(H)x800(W)x610mm(D)
	900	n/a	Matt KD05**DR900 Gloss KD06**DR900	2260(H)x900(W)x610mm(D)
	1000	n/a	Matt KD05**DR1000 Gloss KD06**DR1000	2260(H)x1000(W)x610mm(D)
Stable Robe 	1000	n/a	Matt LH KD05**CRS1000L RH KD05**CRS1000R	2260(H)x1000(W)x610mm(D)
			Gloss LH KD06**CRS1000L RH KD06**CRS1000R	

	Width	H	Product code	Description
Corner Robe 	1000	n/a	Matt KD05**CR1000 Gloss KD06**CR1000	2260(H)x1000(W)x610mm(D)
Single Feature Storage Unit 	400	n/a	Matt KD05**FS400 Gloss KD06**FS400	450(H)x400(W)x430mm(D)
	450	n/a	Matt KD05**FS450 Gloss KD06**FS450	450(H)x450(W)x430mm(D)
	500	n/a	Matt KD05**FS500 Gloss KD06**FS500	450(H)x500(W)x430mm(D)
Double Feature Storage Unit 	1000	n/a	Matt KD05**FS1000 Gloss KD06**FS1000	450(H)x1000(W)x430mm(D)
Sample Door 	400	n/a	Matt KD05**SAM397 Gloss KD06**SAM397	Sample Door, 447(H)x397(W)x18.5mm(D)

FEATURE DOORS

	Width	H	Product code	Description
Corner Robe Mirror 	1000	n/a	Matt LH KD05**CRM1000L RH KD05**CRM1000R	2260(H)x1000(W)x610mm(D)
			Gloss LH KD06**CRM1000L RH KD06**CRM1000R	

	Width	H	Product code	Description				
Feature Mirror Door 	1000	n/a	Matt LH KD05**DMM1000L RH KD05**DMM1000R	2260(H)x1000(W)x610mm(D)				
			Gloss LH KD06**DMM1000L RH KD06**DMM1000R					
			Feature Walnut Effect Door 		1000	n/a	Matt KD05**DMW1000	2260(H)x1000(W)x610mm(D)
							Gloss KD06**DMW1000	
Feature Glass Door 	1000	n/a	Matt LH KD05**DMG1000L RH KD05**DMG1000R	2260(H)x1000(W)x610mm(D)				
			Gloss LH KD06**DMG1000L RH KD06**DMG1000R					

ONLY AVAILABLE IN STOCKED COLOURS - NOT PAINT-TO-ORDER



PAINT-TO-ORDER
(XX)
15 working days
9 days remedial



CASHMERE
MATT & GLOSS
04



DOVE GREY
MATT & GLOSS
05



ANTHRACITE
MATT ONLY
06



WHITE
MATT & GLOSS
07

ACCESSORIES

When ordering, use the colour reference code in place of **

CORNICE



Modern Cornice
3050x28x50mm
Matt: KD05**CO3050
Gloss: KD06**CO3050



Plinth
3050x36x18.5mm
Matt: KD05**SP3050
Gloss: KD06**SP3050



Custom Fit Plinth
3050x160x18.5mm
Matt: KD05**CP3050
Gloss: KD06**CP3050

FEATURE POSTS



Feature End Post
(with 3 fillers)
2400x100x50mm
Matt: KD05**FPV2400
Gloss: KD06**FPV2400



Feature End Post
(with 1 filler)
3050x100x50mm
Matt: KD05**FPH3050
Gloss: KD06**FPH3050

PASSEPARTOUT



Small Passepartout Pack
3 x 2400x100x50mm
Matt: KD05**PS7200
Gloss: KD06**PS7200



Large Passepartout Pack
2 x 2400x100x50mm and
1 x 3050x100x50mm
Matt: KD05**PL7850
Gloss: KD06**PL7850

END PANELS



End Panel
2400x650x18.5mm
Matt: KD05**EP2400
Gloss: KD06**EP2400

CHESTS

Paint-to-order not available on Chests

When ordering, use the colour reference code in place of **
Supplied fully assembled only.

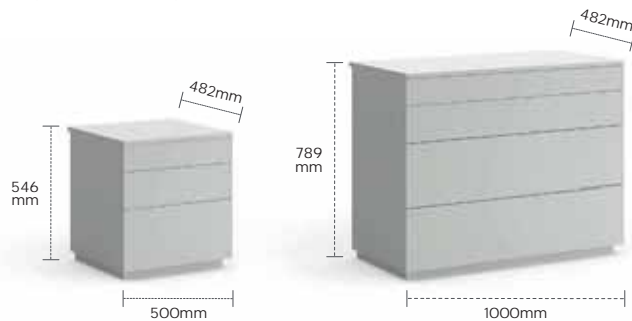

3 Drawer Bedside
Matt: KD11**3D500A
Gloss: KD12**3D500A

4 Drawer Wide Chest
KD11**4D1000A
KD12**4D1000A



Paint-to-Order
Service



Shown above: Parity shown in Gloss Cashmere

DETAIL



Walnut effect internals



Feature mirror door



Bedside chest shown in Gloss Cashmere

THE COMPONENT COLLECTION

PARITY

Parity's simple form and linear appearance can adapt to any space to create the most minimalist looks. Handles can be selected to suit the customers individual style.

Feature mirrored and featured glass doors are offered to create additional design versatility.

PHOTOGRAPHY: PARITY MATT WHITE.

KEY FEATURES

- Available in four colours
- **Matt and gloss finishes** (excluding Anthracite)
- Handles can be chosen separately
- Featured doors available
- Paint-to-order service available

PARITY COMPONENT

STOCKED MATT
STOCKED GLOSS
PAINT-TO-ORDER
MATT ONLY



Lacquered/
Painted



Stocked
Range



Paint-to-Order
Service



STOCKED FINISHES

Colour reference code shown below door.

DOOR FINISHES

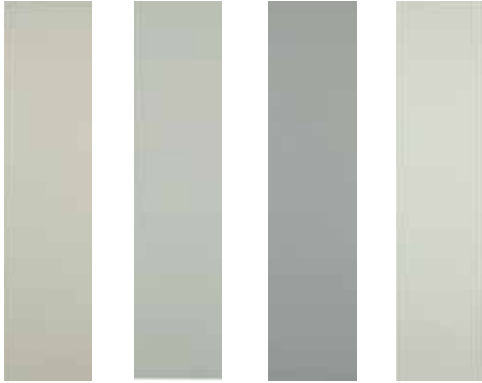

CASHMERE
MATT & GLOSS

04

DOVE GREY
MATT & GLOSS

05

ANTHRACITE
MATT ONLY

06

WHITE
MATT & GLOSS

07

COMPLEMENTARY DOORS



FEATURE
MIRROR

FEATURE
GLASS

FEATURE
WALNUT
EFFECT

Please see page 1.54 and 1.58 for all Feature Door information.

SERVICE OPTIONS



PAINT-TO-ORDER
(XX)
15 working days
9 days remedial

FRONTAL SPECIFICATION:

DOOR STYLE	One piece modern slab
HANDED	Doors are unhandled
DOOR THICKNESS	18.5mm
DOOR HEIGHT	2218mm
DOOR WIDTH	397, 447, 497mm

STABLE DOOR

HANDED	Handed due to hinge positions
HEIGHT	1458mm
WIDTH	497mm
THICKNESS	18.5mm
BLANKING PANEL DIMENSIONS	H 794 x W 497 x 22mm

Blanking panel thickness (To allow tolerance for the chest to be pushed up against it)

FEATURE STORAGE

FRONTAL HEIGHT	447mm
FRONTAL WIDTHS	397, 447, 497mm
SPECIFICATION	Painted MDF
FINISH	Painted matt/gloss lacquer

DOOR DETAIL



FOR TOUCH-UP LACQUER /CARE & MAINTENANCE KITS
SEE PAGE 1.63.

DOOR FINISH	COMPLEMENTARY BOARD MATCHES
MODERN - MATT	
White	W1000 ST9 Premium White
Cashmere	U702 ST9 Cashmere Grey
Dove Grey	U708 ST9 Light Grey
Anthracite	U732 ST9 Dust Grey
MODERN - GLOSS	
White	W1000 Premium White ST30
Cashmere	U702 ST30 Cashmere Grey
Dove Grey	U708 Light Grey ST30

PARITY COMPONENT | Range Content

Codes stated are suffix codes. Colour reference code for door must be used when ordering.

DOORS

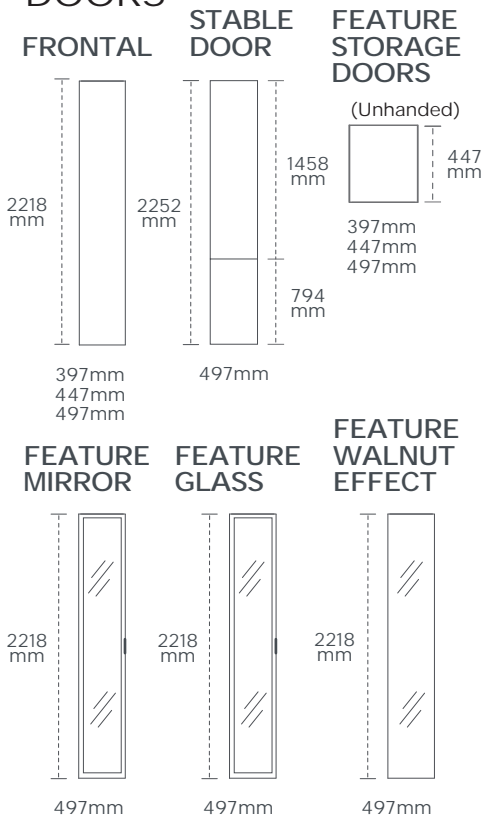

	Matt Product code	Gloss Product code	Description	Handed
	KD05**SAM397	KD06**SAM397	Sample Door, 447x397x18.5mm	Unhanded
	KD05**FD397	KD06**FD397	447x397x18.5mm, Drilled	Unhanded
	KD05**FD447	KD06**FD447	447x447x18.5mm, Drilled	Unhanded
	KD05**FD497	KD06**FD497	447x497x18.5mm, Drilled	Unhanded
	KD05**BD397	KD06**BD397	2218x397x18.5mm, Robe Frontal, Drilled	Unhanded
	KD05**BD447	KD06**BD447	2218x447x18.5mm, Robe Frontal, Drilled	Unhanded
	KD05**BD497	KD06**BD497	2218x497x18.5mm, Robe Frontal, Drilled	Unhanded
	KD05**SBD497L	KD06**SBD497L	2252x497x18.5mm, Stable Robe and blanking panel, LH Drilled	LH
	KD05**SBD497R	KD06**SBD497R	2252x497x18.5mm, Stable Robe and blanking panel, RH Drilled	RH

Please see page 1.54 for all Feature Door information.

ACCESSORIES

When ordering, use the colour reference code in place of **

CORNICE

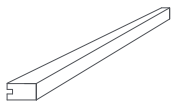

Modern Cornice
3050x28x50mm
Matt: KD05**CO3050
Gloss: KD06**CO3050

PLINTH

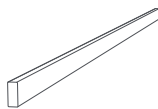

Plinth
3050x36x18.5mm
Matt: KD05**SP3050
Gloss: KD06**SP3050

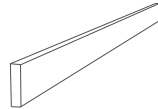

Custom fit plinth
3050x160x18.5mm
Matt: KD05**CP3050
Gloss: KD06**CP3050

END PANELS



End Panel
2400x650x18.5mm
Matt: KD05**EP2400
Gloss: KD06**EP2400

CORNER POST

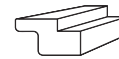

Corner Post for corner robe
2260x105x58mm
KD05**CRP2260
KD06**CRP2260

FEATURE POSTS

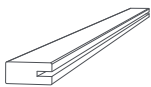

Feature Post 2400mm
1 x 2400x50x100mm
Matt: KD05**FPV2400
Gloss: KD06**FPV2400

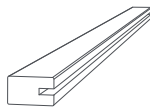

Feature Post 3050mm
1 x 3050x50x100mm
Matt: KD05**FPH3050
Gloss: KD06**FPH3050

PASSEPARTOUT

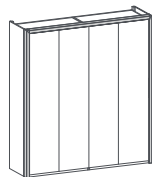

Small Passepartout Pack
3 x 2400x50x100mm
Matt: KD05**PS7200
Gloss: KD06**PS7200

Large Passepartout Pack
2 x 2400x50x100mm
1 x 3050x50x100mm
Matt: KD05**PL7850
Gloss: KD06**PL7850

CHESTS



3 Drawer Bedside

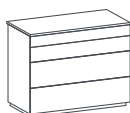

4 Drawer Wide Chest

Matching Chests can be bought through our Complete Range - see page 1.39

Paint-to-order not available on Chests



PAINT-TO-ORDER
(XX)
15 working days
9 days remedial



CASHMERE
MATT & GLOSS
04



DOVE GREY
MATT & GLOSS
05



ANTHRACITE
MATT ONLY
06



WHITE
MATT & GLOSS
07



Shown above: Parity shown in Gloss Cashmere

DETAIL



Gloss Cashmere 4 Drawer Chest with Crystal Bow Handle (KDH3008)

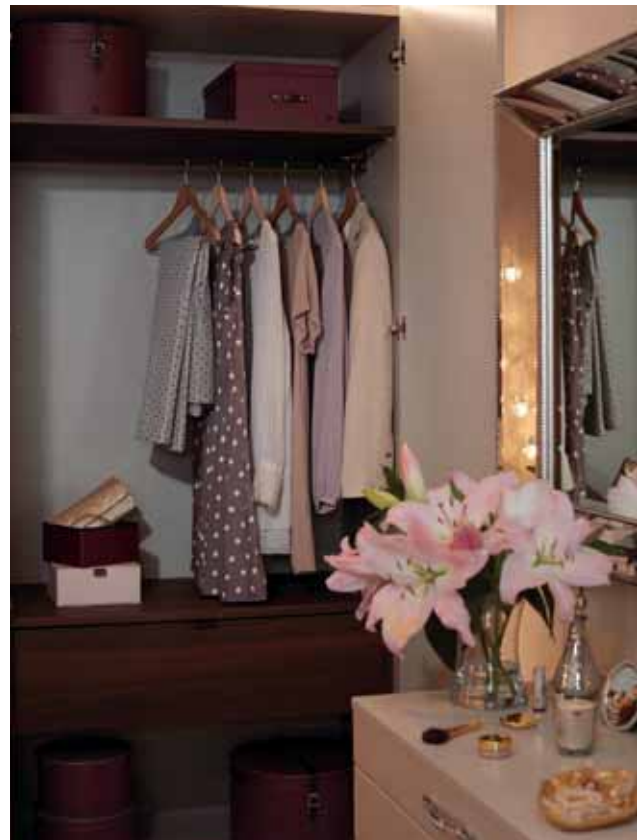

Walnut internal accessories



THE COMPLETE COLLECTION

SCULPT

PHOTOGRAPHY: SCULPT SHOWN IN MATT ANTHRACITE.

Inspired by Italian design, Sculpt is bold and distinctive. The integrated handle creates a strong structural statement.

The range includes feature mirrored and featured glass doors to offer additional design versatility.

Our complete collection includes everything you will need to build your wardrobe.

KEY FEATURES

- Vertical half integrated handle
- Available in four matt colours
- Feature doors available
- Available in four painted colours
- Paint-to-order service available (excludes chests)

HINGES

Pre-drilled for hinge positions

4 x soft close Blum hinges are supplied with wardrobe frontals

2 x soft close Blum hinges and hinge plates are supplied with feature storage frontals

HANDED

Doors are left and right handed

HANDLES

Vertical half integrated handle
No additional handles required





1.45

Your one-stop-shop: www.pws.co.uk/bedrooms



SCULPT COMPLETE

P 15 WORKING DAYS
9 DAYS REMEDIAL
*Lead-time based on orders placed before 5pm, Tuesday cut-off.
PAINT-TO-ORDER





Stocked Range

			
CASHMERE MATT & GLOSS	DOVE GREY MATT & GLOSS	ANTHRACITE MATT ONLY	WHITE MATT & GLOSS
04	05	06	07



XX

	Width	H	Product code	Description
Single Robe 	400		LH KD09**SR400L RH KD09**SR400R	2260(H)x400(W)x610mm(D)
	450		LH KD09**SR450L RH KD09**SR450R	2260(H)x450(W)x610mm(D)
	500		LH KD09**SR500L RH KD09**SR500R	2260(H)x500(W)x610mm(D)
Double Robe 	800	n/a	KD09**DR800	2260(H)x800(W)x610mm(D)
	900	n/a	KD09**DR900	2260(H)x900(W)x610mm(D)
	1000	n/a	KD09**DR1000	2260(H)x1000(W)x610mm(D)
	1000	n/a	KD09**CMSI000L RH KD09**CMSI000R	2260(H)x1000(W)x610mm(D)
Stable Robe 	1000		LH KD09**CMSI000L RH KD09**CMSI000R	2260(H)x1000(W)x610mm(D)

*Stable door is a slab

	Width	H	Product code	Description
Corner Robe 	1000		LH KD09**CRI000L RH KD09**CRI000R	2260(H)x1000(W)x610mm(D)
	400	n/a	KD09**FS400	450(H)x400(W)x430mm(D)
	450	n/a	KD09**FS450	450(H)x450(W)x430mm(D)
Single Feature Storage Unit 	500	n/a	KD09**FS500	450(H)x500(W)x430mm(D)
	1000		KD09**FS1000	450(H)x1000(W)x430mm(D)
Double Feature Storage Unit 	1000		KD09**FS1000	450(H)x1000(W)x430mm(D)
Sample Door 	400	n/a	KD09**SAM397	Sample Door, 447(H)x397(W)x18.5mm(D)

FEATURE DOORS

	Width	H	Product code	Description
Corner Robe Mirror 	1000		LH KD09**CRM1000L RH KD09**CRM1000R	2260(H)x1000(W)x610mm(D)
Corner Robe Glass 	1000		LH KD09**CRG1000L RH KD09**CRG1000R	2260(H)x1000(W)x610mm(D)
Feature Glass Door 	1000		LH KD09**DMG1000L RH KD09**DMG1000R	2260(H)x1000(W)x610mm(D)
Feature Mirror Door 	1000		LH KD09**DMM1000L RH KD09**DMM1000R	2260(H)x1000(W)x610mm(D)
Feature Walnut Effect Door 	1000		LH KD09**DMW1000L RH KD09**DMW1000R	2260(H)x1000(W)x610mm(D)

ONLY AVAILABLE IN STOCKED COLOURS - NOT PAINT-TO-ORDER

SCULPT COMPLETE | Range Content



PAINT-TO-ORDER
(XX)
15 working days
9 days remedial



CASHMERE
MATT & GLOSS
04



DOVE GREY
MATT & GLOSS
05



ANTHRACITE
MATT ONLY
06



WHITE
MATT & GLOSS
07

ACCESSORIES

When ordering, use the colour reference code in place of **

CORNICE



Modern Cornice
3050x28x50mm
KD09**CO3050



Plinth
3050x36x18.5mm
KD09**SP3050



Custom Fit Plinth
3050x160x18.5mm
KD09**CP3050

FEATURE POSTS



Feature End Post
(with 3 fillers)
2400x100x50mm
KD09**FPV2400



Feature End Post
(with 1 filler)
3050x100x50mm
KD09**FPH3050

PASSEPARTOUT



Small Passepartout Pack
3 x 2400x100x50mm
KD09**PS7200



Large Passepartout Pack
2 x 2400x100x50mm and
1 x 3050x100x50mm
KD09**PL7850

END PANELS



End Panel
2400x650x18.5mm
KD09**EP2400

CHESTS

Paint-to-order not available on Chests

When ordering, use the colour reference code in place of **

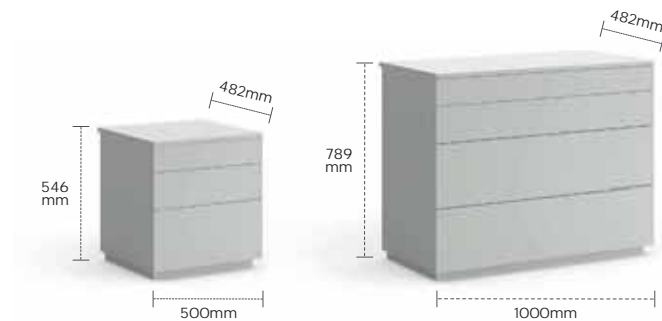

Matt: 3 Drawer Bedside
KD11**3D500A

Matt: 4 Drawer Wide Chest
KD11**4D1000A



Paint-to-Order
Service



Shown above: Sculpt shown in Matt Anthracite with feature glass door & Walnut effect stackable drawer

DETAIL



Internal Walnut effect stackable drawer



Bedside with handle KDH3004



THE COMPONENT COLLECTION

SCULPT

Inspired by Italian design, Sculpt is bold and distinctive. The integrated handle creates a strong structural statement. The range includes feature mirrored and featured glass doors to offer additional design versatility.

PHOTOGRAPHY: SCULPT MATT ANTHRACITE.

KEY FEATURES

- Vertical half integrated handle
- Available in four matt painted colours
- Feature doors available
- Paint-to-order service available

SCULPT COMPONENT

STOCKED
PAINT-TO-ORDER
MATT ONLY



Lacquered/
Painted



Stocked
Range



Paint-to-Order
Service



STOCKED FINISHES

Colour reference code shown below door.

DOOR FINISHES

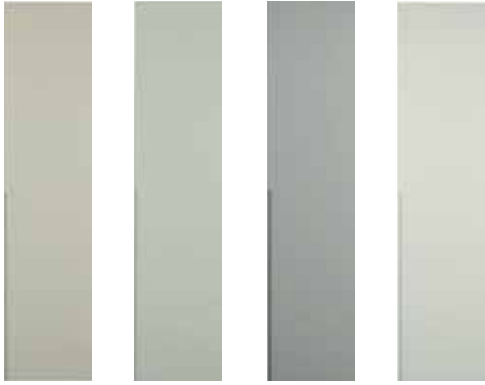

CASHMERE
MATT ONLY

04

DOVE GREY
MATT ONLY

05

ANTHRACITE
MATT ONLY

06

WHITE
MATT ONLY

07

COMPLEMENTARY DOORS



FEATURE
MIRROR

FEATURE
GLASS

FEATURE
WALNUT
EFFECT

Please see page 1.54 and 1.58 for all Feature Door information.

SERVICE OPTIONS



PAINT-TO-ORDER
(XX)
15 working days
9 days remedial

FRONTAL SPECIFICATION:

DOOR STYLE	One piece Modern integrated handle
DOOR THICKNESS	18.5mm
DOOR WIDTH	397, 447, 497mm

FEATURE STORAGE

FRONTAL HEIGHT	447mm
FRONTAL WIDTHS	397, 447 497mm
SPECIFICATION	Painted MDF
FINISH	Painted matt/gloss lacquer

STABLE DOOR

HANDED	Handed due to hinge positions
HEIGHT	1458mm
WIDTH	497mm
THICKNESS	18.5mm
BLANKING PANEL DIMENSIONS	H 794 x W 497 x 22mm

Blanking panel thickness (To allow tolerance for the chest to be pushed up against it)

Feature storage doors and stable doors available in Slab only

DOOR DETAIL



FOR TOUCH-UP LACQUER /CARE & MAINTENANCE KITS
SEE PAGE 1.63.

DOOR FINISH	COMPLEMENTARY BOARD MATCHES
MODERN - MATT	
White	W1000 ST9 Premium White
Cashmere	U702 ST9 Cashmere Grey
Dove Grey	U708 ST9 Light Grey
Anthracite	U732 ST9 Dust Grey

SCULPT COMPONENT | Range Content

Codes stated are suffix codes. Colour reference code for door must be used when ordering.

DOORS

FRONTAL

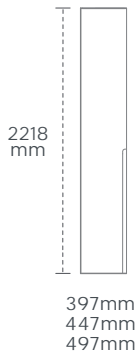

FEATURE STORAGE DOORS

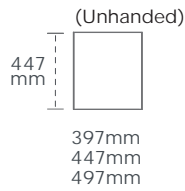

FEATURE MIRROR



FEATURE GLASS

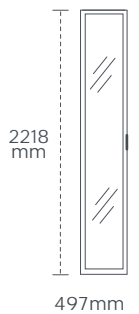

FEATURE WALNUT EFFECT



Please see page 1.54 for all Feature Door information.

	Product code	Description	Handed
	KD09**SAM397	Sample Door, 447x397x18.5mm	Unhanded
	KD09**FD397	447x397x18.5mm, Drilled	Unhanded
	KD09**FD447	447x447x18.5mm, Drilled	Unhanded
	KD09**FD497	447x497x18.5mm, Drilled	Unhanded
	KD09**BD397L	2218x397x18.5mm, Robe Frontal, LH Drilled	LH
	KD09**BD397R	2218x397x18.5mm, Robe Frontal, RH Drilled	RH
	KD09**BD447L	2218x447x18.5mm, Robe Frontal, LH Drilled	LH
	KD09**BD447R	2218x447x18.5mm, Robe Frontal, RH Drilled	RH
	KD09**BD497L	2218x497x18.5mm, Robe Frontal, LH Drilled	LH
	KD09**BD497R	2218x497x18.5mm, Robe Frontal, RH Drilled	RH

Stable door from Parity range can be used see page 1.43.

ACCESSORIES

When ordering, use the colour reference code in place of **

CORNICE

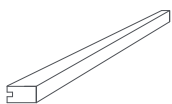

Modern Cornice
3050x28x50mm
KD09**CO3050

PLINTH



Plinth
3050x36x18.5mm
KD09**SP3050

END PANEL



End Panel
2400x650x18.5mm
KD09**EP2400

CORNER POST



Corner Post for corner robe
2260x105x58mm
KD09**CRP2260

FEATURE POSTS

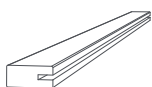

Feature Post 2400mm
1 x 2400x50x100mm
KD09**FPV2400

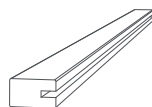

Feature Post 3050mm
1 x 3050x50x100mm
KD09**FPH3050

PASSEPARTOUT

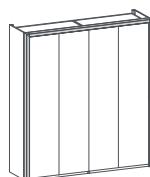

Small Passepertout Pack
3 x 2400x50x100mm
KD09**PS7200

Large Passepertout Pack
2 x 2400x50x100mm
1 x 3050x50x100mm
KD09**PL7850

CHESTS

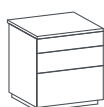

3 Drawer Bedside

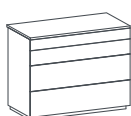

4 Drawer Wide Chest

Matching Chests can be bought through our Complete Range - see page 1.47

Paint-to-order not available on Chests



PAINT-TO-ORDER
(XX)
15 working days
9 days remedial



CASHMERE
MATT & GLOSS
04



DOVE GREY
MATT & GLOSS
05



ANTHRACITE
MATT ONLY
06



WHITE
MATT & GLOSS
07



Shown above: Sculpt shown in Matt Anthracite with feature glass door

DETAIL



Modern 3 drawer bedside



Desk made with single stackable Walnut effect drawer



THE FEATURE COLLECTION

GLASS & MIRROR

Our Universal feature doors are available in two finishes: bronze tinted glass, and grey tinted mirror both with a contemporary bronze aluminium frame and integrated handle. Our feature doors look stunning used alongside our modern collection.

PHOTOGRAPHY: FEATURE MIRROR DOORS SHOWN IN GREY TINTED MIRROR ALONGSIDE PARITY GLOSS CASHMERE.

KEY FEATURES

- 19mm thickness
- Universal door size that merge perfectly with any range from the modern collection
- 3mm front frame for contemporary appearance
- Integrated 120mm handle
- Pre-drilled for hinges

THE FEATURE COLLECTION

GLASS & MIRROR



GLASS

10



MIRROR

11

STOCKED FINISHES

Colour reference code shown below door.

FEATURE
GLASS

10

FEATURE
MIRROR

11

FRONTAL SPECIFICATION:

FEATURE GLASS

HEIGHT	2218mm
THICKNESS	19mm
WIDTH	497mm
SPECIFICATION	Bronze tinted glass 19mm aluminium frame with mitred construction Bronze frame finish Matching bronze aluminium handle comes separately to be fixed to the frame
HANDLE	Door handle is 120mm long. Set 980 from the bottom of the door

FEATURE MIRROR

HEIGHT	2218mm
THICKNESS	19mm
WIDTH	497mm
SPECIFICATION	Silver tinted mirror 19mm aluminium frame with mitred construction Bronze frame finish Matching bronze aluminium handle comes separately to be fixed to the frame
HANDLE	Door handle is 120mm long. Set 980 from the bottom of the door

DOOR SPECIFICATION DETAIL

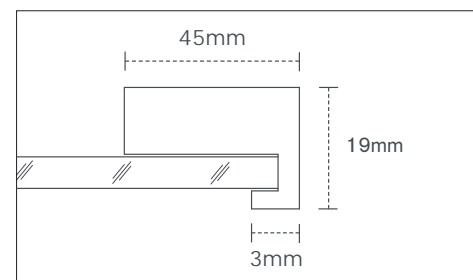



COMPLETE & COMPONENT

GLASS & MIRROR

PHOTOGRAPHY: BRONZE TINTED GLASS FEATURE DOOR
USED ALONGSIDE SCULPT IN MATT ANTHRACITE.

COMPLETE & COMPONENT GLASS & MIRROR

£ £ £ £



GLASS

10



MIRROR



11

COMPLETE



GLASS DOORS



	Width	H	Product code	Description
Single Robe				
	500		LH KD1010SR500L RH KD1010SR500R	Single wardrobe with feature glass door 2260(H)x500(W)x610mm(D) Satin brown frame with bronze tinted glass
Double Robe				
	1000	n/a	KD1010DR1000	Double wardrobe with feature glass doors 2260(H)x1000(W)x610mm(D) Satin brown frame with bronze tinted glass
Double Robe				
	1000	n/a	KD1010DMW1000L	Double wardrobe with feature glass door LH and walnut doors combined 2260(H)x1000(W)x610mm(D) 1 x glass door and 1 x walnut effect door, left hand
Double Robe				
	1000	n/a	KD1010DMW1000R	Double wardrobe with feature glass door RH and walnut doors combined 2260(H)x1000(W)x610mm(D) 1 x glass door and 1 x walnut effect door, right hand

MIRROR DOORS

	Width	H	Product code	Description
Single Robe				
	500		LH KD1011SR500L RH KD1011SR500R	Single wardrobe with feature mirror door 2260(H)x500(W)x610mm(D) Satin brown frame with grey tinted mirror
Double Robe				
	1000	n/a	KD1011DR1000	Double wardrobe with feature mirror doors 2260(H)x1000(W)x610mm(D) Satin brown frame with grey tinted mirror
Double Robe				
	1000	n/a	KD1011DMW1000L	Double wardrobe with feature mirror door LH and walnut doors combined 2260(H)x1000(W)x610mm(D) Satin brown frame with grey tinted mirror, left hand
Double Robe				
	1000	n/a	KD1011DMW1000R	Double wardrobe with feature mirror door RH and walnut doors combined 2260(H)x1000(W)x610mm(D) Satin brown frame with grey tinted mirror, right hand

COMPONENT

Feature Glass Sample Door				
	397	n/a	KD1010SAM397	447(H)x397(W)x19mm(D)
Feature Glass Door				
	497		LH KD1010BD497L RH KD1010BD497R	2218(H)x497(W)x19mm(D)

Feature Mirror Sample Door				
	397	n/a	KD1011SAM397	447(H)x397(W)x19mm(D)
Feature Mirror Door				
	497		LH KD1011BD497L RH KD1011BD497R	2218(H)x497(W)x19mm(D)

THE FEATURE COLLECTION

WALNUT

Our Universal feature walnut door collection looks stunning used alongside any range from our modern collection or on its own.

PHOTOGRAPHY: IMAGE SHOWS A FULL WARDROBE MADE WITH DOORS AND ACCESSORIES FROM THE FEATURE WALNUT SECTION.

KEY FEATURES

- 19mm door thickness
- Pre-drilled for hinges
- 19mm chipboard
- Foil wrapped and edge banded on the short edges
- **Walnut effect (flat matt finish)**
- Universal door size that merge perfectly with any range from the modern collection
- Full selection of accessories

THE FEATURE COLLECTION

WALNUT



WALNUT

08

STOCKED FINISHES

Colour reference code shown below door.



FEATURE
WALNUT
EFFECT

08

FRONTAL SPECIFICATION:

WALNUT

HEIGHT	2218mm
THICKNESS	19mm
WIDTH	497mm
SPECIFICATION	19mm chipboard Foil wrapped and edge banded on short edges Walnut effect flat matt finish

DOOR DETAIL



FOR TOUCH-UP LACQUER /CARE & MAINTENANCE KITS
SEE PAGE 1.63.

DOOR FINISH	COMPLEMENTARY BOARD MATCHES
Walnut	Egger H3702 Tobacco Pacific Walnut ST10



COMPLETE
WALNUT

PHOTOGRAPHY: FEATURE WALNUT DOORS AND ACCESSORIES
COMBINED WITH FEATURE MIRROR DOORS.

COMPLETE WALNUT



WALNUT

08

	Width	H	Product code	Description
<p>Single Robe</p> 	500	n/a	KD1008SR500	Single wardrobe with feature walnut door 2260(H)x500(W)x610mm(D)
<p>Double Robe</p> 	1000	n/a	KD1008DR1000	Double wardrobe with feature walnut doors 2260(H)x1000(W)x610mm(D)

	Width	H	Product code	Description
<p>Corner Robe</p> 	1000	n/a	KD1008CR1000	Corner wardrobe with feature walnut doors and corner post 2260(H)x1000(W)x610mm(D)



COMPONENT
WALNUT

PHOTOGRAPHY: WALNUT INTERNALS SHOWN IN WARDROBE
WITH FEATURE WALNUT DOORS.



WALNUT

08

DOORS

FRONTAL

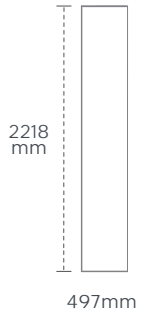

FEATURE STORAGE DOORS

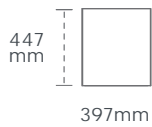

	Product code	Description	Handed
	KD1008SAM397	Walnut Sample Door, 447x397x19mm	Unhanded
	KD1008BD497	Walnut Door, 2218x497x19mm	Unhanded

ACCESSORIES

PLINTH

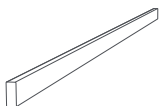

Plinth
3050x36x19mm
KC1008SP3050

END PANEL



End Panel
2400x650x19mm
KC1008EP2400

CUSTOM FIT PANEL



End Panel
2260x750x22mm
KC1308EP2260

EDGING TAPE



End Panel
5000x23x0.5mm
KC1308ET5000

CORNER POST



Corner Post for corner robe
2260x105x58mm
KD1008CRP2260

FEATURE POSTS

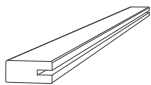

Feature Post 2400mm
1 x 2400x50x100mm
KC1008FPV2400

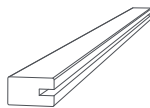

Feature Post 3050mm
1 x 3050x50x100mm
KC1008FPH3050

PASSEPARTOUT

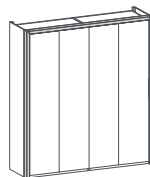

Small Passepertout Pack
3 x 2400x50x100mm
KC1008PS7200

Large Passepertout Pack
2 x 2400x50x100mm
1 x 3050x50x100mm
KC1008PL7850

CARE AND MAINTENANCE KITS

CARE & MAINTENANCE KIT

Suitable for repairing minor scuff marks and scratches.
For a full list of finish options see the price list.

Care & Maintenance Kit contents:

- 1x softwax
- 1x touch up pen
- 1x softwax applicator
- 1x scotchbrite pad



Product Code	Description
KDA6110	Care and Maintenance Kit for Classic Partridge Grey
KDA6111	Care and Maintenance Kit for Classic Porcelain
KDA6112	Care and Maintenance Kit for Classic Stone
KDA6113	Care and Maintenance Kit for Modern Cashmere (gloss and matt)
KDA6114	Care and Maintenance Kit for Modern Dove Grey (gloss and matt)
KDA6115	Care and Maintenance Kit for Modern Anthracite (matt)
KDA6116	Care and Maintenance Kit for Modern White (gloss and matt)
KDA6117	Care and Maintenance Kit for Modern Accent (Walnut)
KDA6118	Care and Maintenance Kit for Modern Accent (Oak)
KDA6119	ECO 2 cleaning solution 150ml

PAINT-TO-ORDER

Product Code	Description
CKPWSALABMOD	Alabaster Modern
CKPWSBAYGREEN	Bay Green
CKPWSCADET	Cadet
CKPWSCARBON	Carbon
CKPWSCASHMERE	Cashmere
CKPWSCHALK	Chalk
CKPWSCHALKBLUE	Chalk Blue
CKPWSCHARCOAL	Charcoal
CKPWSCHINABLUE	China Blue
CKPWSCOPSEGR	Copse Green
CKPWSCORNFLOWER	Cornflower
CKPWSDOVEGREY	Dove Grey
CKPWSDRYROSE	Dry Rose
CKPWSDUSTGREY	Dust Grey
CKPWSGEORED	Georgian Red
CKPWSGRAPHITE	Graphite
CKPWSHARTBLUE	Hartforth Blue
CKPWSLAVA	Lava
CKPWSINKWELL	Inkwell
CKPWSIVESBLUE	Ives Blue
CKPWSMS	Sage
CKPWSMUSSEL	Mussel
CKPWSOLIVE	Olive
CKPWSPGREY	Partridge Grey
CKPWSPIMENTO	Pimento
CKPWSPORCELAIN	Porcelain
CKPWSPUTTY	Putty
CKPWSREGGREEN	Regents Green
CKPWSREGIMENT	Regiment
CKPWS SILVERGREY	Silver Grey
CKPWS SLATE	Slate
CKPWSSTONE	Stone
CKPWSSTORMBLUE	Storm Blue
CKPWSTRUFFLE	Truffle
CKPWSWHITE	White





THE
Made-to-measure
COLLECTION





MADE-TO-MEASURE DOOR RANGES

CONTENTS

- 1.68 LEADTIMES & HOW-TO-ORDER
- 1.69 UNITY
- 1.75 STANHOPE
- 1.83 ALPINA

HOW TO ORDER & LEADTIMES

MADE-TO-MEASURE RANGES & LEADTIMES

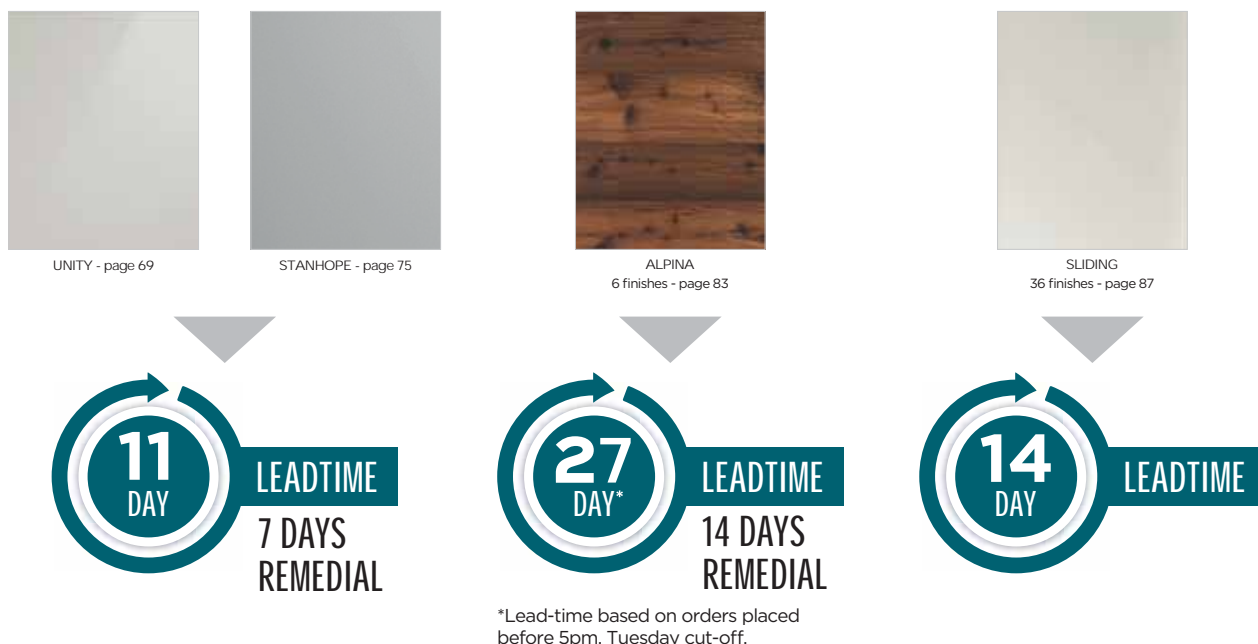

HOW-TO-ORDER MADE-TO-ORDER RANGES

- ORDERING WITH CODES FROM 'QUICK-GLANCE' SIZE LIST**
For quick ordering, accessories can be ordered with supplied codes - please see relevant pages in this section for more information.
- ORDERING BESPOKE DOOR SIZES**
The PWS Price List includes a 'next-size-up' pricing table for all made-to-measure ranges that can be used to understand instant pricing for bespoke sizes.

THE EASIEST WAY TO ORDER IS ON WWW.PWS.CO.UK/BEDROOMS

*MADE-TO-ORDER delivery dates will be confirmed with each order acknowledgment.

WHEN PLACING ORDERS FOR MADE-TO-ORDER DOORS, PLEASE BE AWARE OF THE FOLLOWING:

- Orders for made-to-order door ranges can be placed by email.**
Upon receipt of each order to PWS you will receive an itemised order acknowledgement.
- Due to the bespoke nature of made-to-order products, it is not possible to cancel or amend orders once placed.**
Additions to an order will be processed as a new order.
- Orders for made-to-measure product will be despatched upon completion of the full order.**
No part orders will be despatched.
- PWS cannot accept the return of surplus made-to-order product that may have been ordered incorrectly.**
- Although we strive to maintain consistency, there may be batch-to-batch variances with made-to-measure product.**
We cannot guarantee an exact colour match between orders.
- PWS made-to-order ranges depicted in our marketing materials are indicative of the colours, however colours may vary batch to batch.**

THE MADE-TO-MEASURE COLLECTION

UNITY

Unity is a made-to-measure collection of edged slab doors, available in an extensive choice of 23 finishes including high gloss, soft-touch supermatt, metallics, concrete effect and woodgrain effect, with a choice of two edge options. Manufactured in the UK, doors are available in any size (up to 2540mm high x 897mm wide) and with the additional flexibility of angled doors, it makes Unity ideal for bedrooms.

UNITY SHOWN IN SUPERMATT LIGHT GREY AND SUPERMATT PURE WHITE

KEY FEATURES

- Fully made-to-measure collection manufactured in the UK
- **23 stunning finishes in 5 different finish types**
- Two edge options
- Angled doors
- Drilling service
- 11 day lead-time
- Six-year guarantee
- Can now be ordered with an accompanying cabinet

UNITY COMPONENT

Made-to-Measure Collection

WOODGRAIN



MATT/GLOSS



ONE DOOR STYLE, MADE-TO-MEASURE SIZES

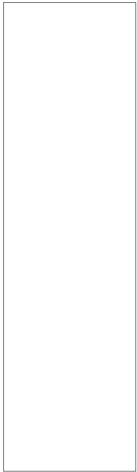

UNITY

Unity frontals can now be ordered with an accompanying cabinet which are available in a selection of stocked sizes. Please see our Price List for more information.

FRONTAL SPECIFICATION:

DOOR STYLE	Slab
DOOR THICKNESS	18mm
DOOR WIDTH	Made-to-measure

SPECIFICATION:	Gloss/matt - MDF Woodgrain - MFC
-----------------------	-------------------------------------

COVERING/ MATERIAL FINISH:	<p>Gloss Colours & Metallic: Acrylic front face with matching matt PVC reverse.</p> <p>Supermatt: Matt PVC front face with matching matt reverse.</p> <p>Woodgrain effect: Melamine face chipboard with matching reverse.</p>
---	--

EDGE OPTIONS



**Matching
AirTech Edge**



**Two-Tone
3D glass effect**
(Gloss doors only)

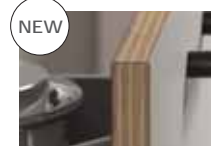

Multiplex Edging

NOTES:

- Two-tone 3D glass effect edging is available in gloss finishes only
- Multiplex Edging available in all finishes
- End panels are edged all 4 sides as standard and are supplied in matching edge only
- Pelmet & plinth are edged on one long side only with a matching edge.



Made to measure



Manufactured in the UK



High gloss or fingerprint free supermatt



11 day lead time



Fira Gold Certification



6 year guarantee



UNITY COMPONENT

Made-to-Measure Collection

COLOUR OPTIONS AND FINISHES | All available in made-to-measure sizes.

GLOSS FINISHES



PURE WHITE

CASHMERE

LIGHT GREY

DUST GREY

GRAPHITE

GLOSS METALLIC FINISHES



FJORD
METALLIC

GOLD
METALLIC

Notes:
Metallic colours have a directional finish as indicated by arrows on the protective film. Arrows should all face in the same direction when fitting. Drilling must be specified left or right hand with metallic doors.

SUPERMATT FINISHES (Matching edge only)



PURE WHITE

CASHMERE

PEBBLE GREY

LIGHT GREY

DUST GREY

INDIGO BLUE

GRAPHITE

WOODGRAIN EFFECT (Matching edge only)

CHARACTER
GRAPHITERECLAIMED
OAKWHITE
HALIFAX
OAKNATURAL
DAVOS OAKSEPIA
GLADSTONE
OAK

BLACK

Notes:

All mfc woodgrain effect finishes come in a vertical grain direction as standard and matching edge only.

CONCRETE FINISHES



BRUNSWICK

HAYWARD

TRELICK

EDGE OPTIONS

**Matching
AirTech Edge****Two-Tone
3D glass effect**
(Gloss doors only)**NOTES:**

- Two-tone 3D glass effect edging is available in gloss finishes only
- Multiplex Edging available in all finishes
- End panels are edged all 4 sides as standard and are supplied in matching edge only
- Pelmet & plinth are edged on one long side only with a matching edge.

NEW

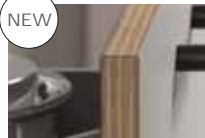
**Multiplex Edging**

UNITY COMPONENT

Made-to-Measure size guide

MADE-TO-MEASURE SIZES

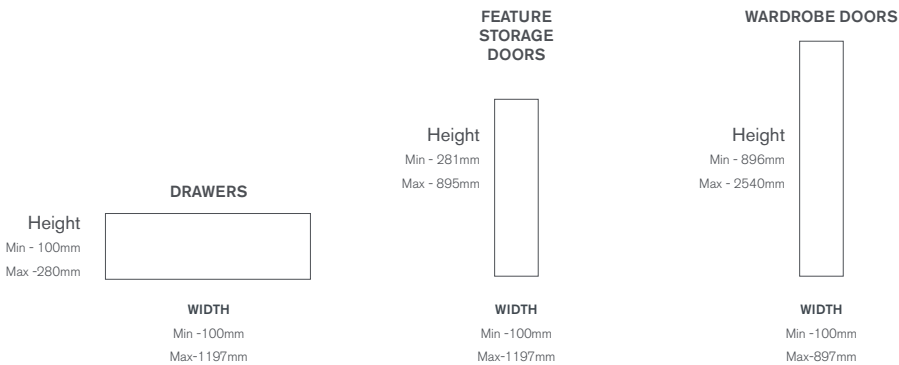

ANGLED DOORS

- Angled doors are available within the same door size parameters listed above (up to 2540x897mm)
- When ordering, please specify the type of angled door (A or B) and dimensions for Left Hand Height (LH), Right Hand Height (RH), Bottom Width (BW) and for stepped angled doors specify Top width (TW).
- Additional 5 day lead time will apply to orders that include angled doors.

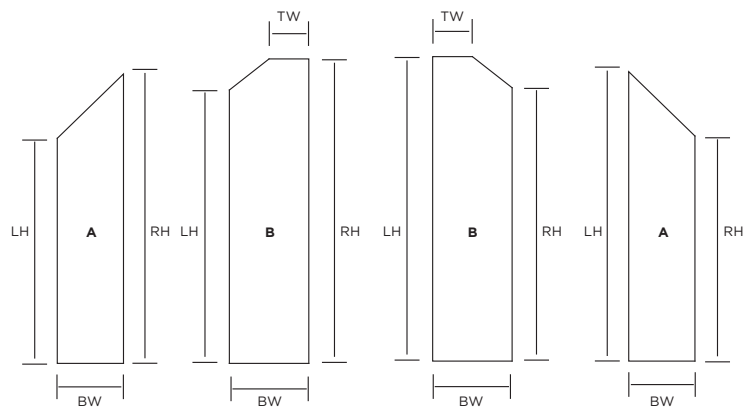

DOOR DRILLING SERVICE

Default hinge holes by door size (based on standard PWS drilling pattern - see below)
Please note: illustrations shown are Left Hand.

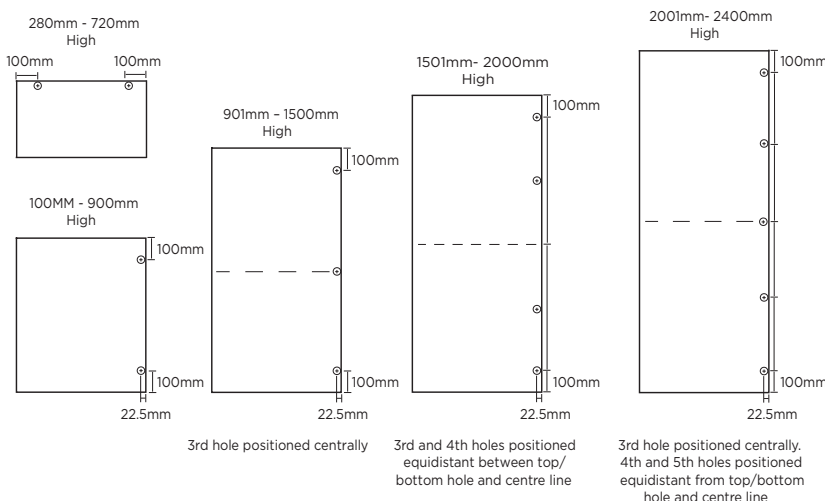

- A door drilling service for Unity is available, charged at £1 a hole.
- PWS's recommended standard drilling pattern is 100mm (+/- 1mm) from the ends with a 13.5mm deep hole (+/- 0.5mm), hole diameter of 35mm (+/- 0.2mm) and centre of hole 22.5 (+/- 0.5mm) from the side from side.
- Door drilling can be selected at the point of order on pws.co.uk or by completing the PWS 'UNITY ORDER FORM'.
- Additional hinge holes will be drilled by default depending on door height as indicated in the above illustrations.
- Top Box drilling is available for door heights between 280-720mm high (Top Box application must be specified at the point of order).
- Due to a directional finish, drilling on metallic doors should be stipulated left or right hand (please note illustrations shown above are left handed).
- Drilling is not available on angled doors or end panels.
- Please allow 2 days' additional lead-time to all orders that require drilling.

ACCESSORIES

When ordering, use the prefix codes for the relevant colour in place of **

CORNICE

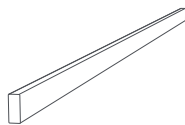

Modern Cornice/Light Pelmet
3000x70x18mm, edged one long
side only with a blank finish on
the hidden face
**C30

(woodgrain is 2800x70x18)

PLINTH

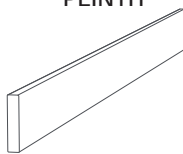

Plinth 3000x150x18mm, edged
one long side only with a blank
finish on the hidden face
**P30

(woodgrain is 2800x150x18)

CORNER POST



Corner post
Please use a plinth to
create a corner post

END PANELS



End panels are available to order as a
standalone product type in the same
made-to-measure sizes as doors. End
panels are supplied in a matching edge
only and edged all 4 sides as standard.

*Pelmet and plinth are edged on one
long side only with a matching edge.*

UNITY COMPLETE

Unity frontals can now be ordered with an accompanying cabinet which are available in a selection of stocked sizes. Please see page 98 of our Price List for more information.



Single Robe

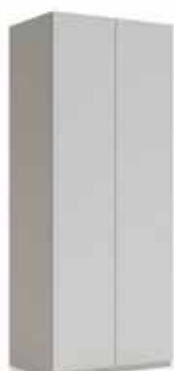

Double Robe

Single Feature
Storage Unit



Double Feature
Storage Unit



THE MADE-TO-MEASURE COLLECTION

STANHOPE

Stanhope is a fully made-to-measure PVC door collection available in five door styles with a choice of matt and gloss colours to achieve both modern and classic looks.

An array of supporting accessories and angled doors make this collection ideal for bedrooms.

STANHOPE'S BOLAM SHOWN IN MATT PORCELAIN

KEY FEATURES

- Made-to-measure PVC door range
- A versatile collection of 5 door styles and multiple finishes covering gloss, matt and a woodgrain effect.
- Angled door options and a huge array of accessories
- Manufactured in the UK with a 11 day lead time and a 6 year guarantee
- FIRA gold and PEFC certified.
- Can now be ordered with an accompanying cabinet

STANHOPE COMPONENT

PVC Made-to-Measure Range

MODERN



CLASSIC



CLASSIC DOOR STYLES



ELSDON

BOLAM

MODERN DOOR STYLES

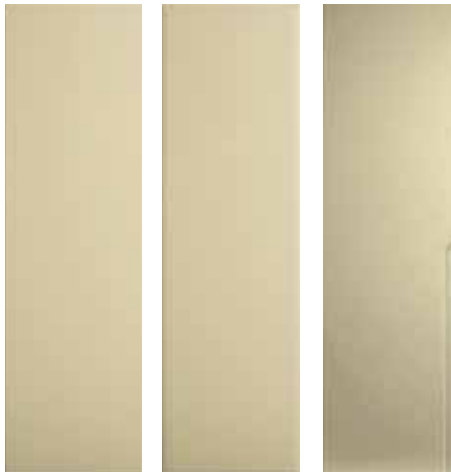

WHITFIELD

HENSHAW

ACOMB

Stanhope frontals can now be ordered with an accompanying cabinet which are available in a selection of stocked sizes. Please see our Price List for more information.

FRONTAL SPECIFICATION:

DOOR STYLE	A choice of 5 doors
DOOR THICKNESS	18mm
DOOR WIDTH	Made-to-measure

ELSDON

STILE WIDTH	74mm
CENTRE PANEL RECESSED	6mm

BOLAM

STILE WIDTH	110mm
MID RAIL WIDTH	225mm

SPECIFICATION:	MDF core substrate with vinyl wrapped PVC front surface (Gloss Haze is PET material)
REVERSE:	All doors have a matching reverse finish (gloss colours have matching matt finish) with the exception of Concrete with a light grey reverse
CERTIFICATION:	Fira Gold (selected doors tested to BS 6222-3) All Stanhope finishes are PEFC certified



11 day lead time



Manufactured in the UK



Fira Gold Certification



Made-to-measure



Bespoke sizes



6 year guarantee



REMEDIAL



LEAD-TIME

STANHOPE COMPONENT

AVAILABLE IN
ANGLED DOORS

PVC Made-to-Measure Range

CLASSIC

CLASSIC DOOR STYLES



ELSDON

BOLAM

MATT



PORCELAIN

DOVE GREY

CASHMERE

DUST GREY

BLUE CANVAS



INDIGO BLUE

THORPE GREEN

GRAPHITE

MATT BLACK

DOOR FINISH SUGGESTED BOARD OPTIONS

Porcelain	Egger: W1100, Alpine white
Dove Grey	Egger: U708, Kronospan 0112, Finsa U12 Natural Grey, Pfeiderer: U1188
Cashmere	Egger: U702, Kronospan: 5981, Pfeiderer: U1168, Finsa: Gris Coco 15R
Dust Grey	Egger U732
Blue Canvas	Egger: U540, Pfeiderer: U18002 (U1717)
Indigo Blue	Egger U599
Thorpe Green	Pfeiderer U19008
Graphite	Egger: U961
Matt Black	Egger U999
Super White woodgrain	Egger: W980, Kronospan: K101, Pfeiderer: W300, Finsa: White 020
Woodgrain Cream	Egger: U104, Kronospan: U514, Pfeiderer: U1303, Finsa: Contempo, Ivory 65B
Woodgrain Grey	Egger: U708, Kronospan 0112, Finsa U12 Natural Grey, Pfeiderer: U1188
Woodgrain Mussel	Egger: U100, Pfeiderer: U1331, Finsa: Gris Porrino 194
Woodgrain Cashmere	Egger: U702, Kronospan: 5981, Pfeiderer: U1168, Finsa: Gris Coco 15R

WOODGRAIN



SUPER WHITE

CREAM

GREY

MUSSEL

CASHMERE

***NB:** The above board options are suggested matches only. We recommend that board samples are ordered to check against preferred door finishes before making a cabinet selection.

1.77

Your one-stop-shop: www.pws.co.uk/bedrooms

MODERN

MODERN DOOR STYLES

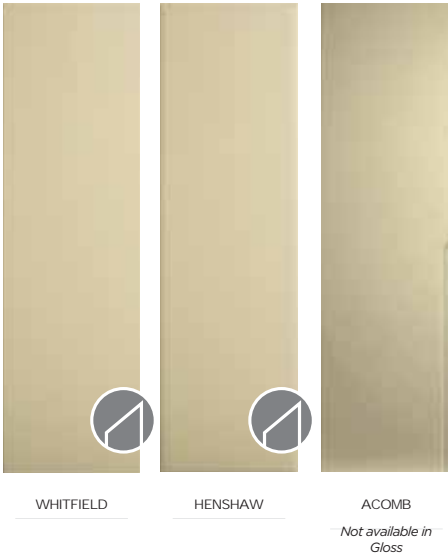

GLOSS



MATT

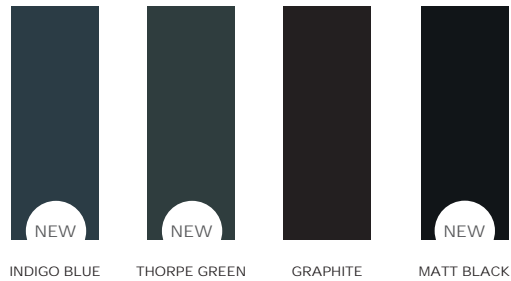

DOOR FINISH SUGGESTED BOARD OPTIONS

Gloss White	Egger: W980, Kronospan: K101, Pfleiderer: W300, Finsa: White 020
Gloss Cream	Egger: U104, Kronospan: U514 or 7031, Pfleiderer: U1306, Finsa: Contempo Ivory 65B
Gloss Dove Grey	Egger U708
Gloss Cashmere	Egger U702
Gloss Dust Grey	Egger U732
Porcelain	Egger: W1100, Alpine white
Dove Grey	Egger: U708, Kronospan 0112, Finsa U12 Natural Grey, Pfleiderer: U1188
Cashmere	Egger: U702, Kronospan: 5981, Pfleiderer: U1168, Finsa: Gris Coco 15R
Dust Grey	Egger U732
Blue Canvas	Egger: U540, Pfleiderer: U18002 (U1717)
Indigo Blue	Egger U599
Thorpe Green	Pfleiderer U19008
Graphite	Egger: U961
Matt Black	Egger U999
Super White woodgrain	Egger: W980, Kronospan: K101, Pfleiderer: W300, Finsa: White 020
Woodgrain Cream	Egger: U104, Kronospan: U514, Pfleiderer: U1303, Finsa: Contempo, Ivory 65B
Woodgrain Grey	Egger: U708, Kronospan 0112, Finsa U12 Natural Grey, Pfleiderer: U1188
Woodgrain Mussel	Egger: U100, Pfleiderer: U1331, Finsa: Gris Porrino 194
Woodgrain Cashmere	Egger: U702, Kronospan: 5981, Pfleiderer: U1168, Finsa: Gris Coco 15R
Concrete	Use matching vinyl wrapped panels or self adhesive vinyl

WOODGRAIN



***NB:** The above board options are suggested matches only. We recommend that board samples are ordered to check against preferred door finishes before making a cabinet selection.

STANHOPE COMPONENT

Made-to-Measure size guide

RECOMMENDED COMBINATIONS



Single



Double

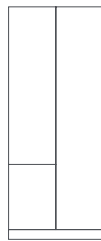

Stable door



Feature door

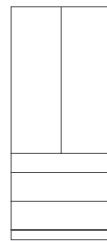

2 door,
1 x small drawer
2 x medium drawer

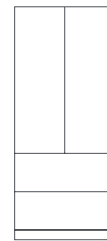

2 door,
2 x large drawer

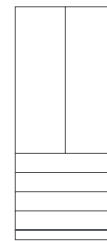

2 door,
4 x small drawer

A stable door will be possible but you will need to be aware of the parameters e.g. Stile/rail on your chosen door style.



DOOR/DRAWER SIZE PARAMETERS

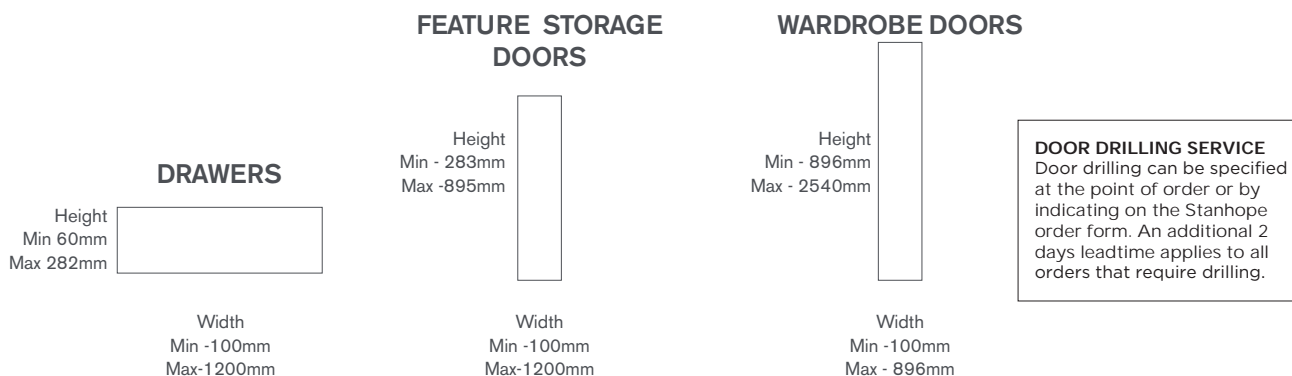

Size parameter exceptions:

BOLAM:

Minimum door width with internal Shaker design - 275mm

ACOMB:

Minimum drawer/door width - 240mm. Integrated handle profile on drawer fronts and doors below 1699mm high have a 200mm long groove on the top. Doors above 1700mm high have a 900mm long groove on the left/right hand side.

ELSDON:

Minimum drawer height with internal Shaker design - 160mm

Min drawer width with internal design - 230mm

Min door width with internal design - 230mm
Bedroom door 1495 high panels will be sized to match in line with 2155 door.

- 1 Panel door/drawers below 649mm
- 2 Panel doors 650-1699mm
- 3 Panel doors 1495 only
- 4 Panel doors 1700+ over

3 panel doors are available for <1699mm. Please state at time of order.

Please state at time of order If cross rails need to align across all bespoke sizes.

Grain Direction

- Drawer fronts are supplied with horizontal grain as standard
- Standard and Tall doors are supplied with vertical grain in all finishes except Gloss Haze which is horizontal on all drawers/doors.

Doors for corner cabinets

Doors can be supplied with either left or right side edge square. Available up to Max. 1699mm high.

Wardrobe doors

Wardrobe door designs with two panels will be supplied with the mid rail at 655mm from the bottom edge to the centre of the mid rail as standard unless otherwise specified.

ANGLED DOOR OPTIONS

Only available in Bolam, Whitfield and Henshaw.

Angled doors are available in a wide variety of angles and shapes as shown in left illustration and the PWS Stanhope order form.

- Angled doors are available within the same door size parameters listed above (up to 2540x896mm)
- Angled doors are not available in gloss
- When ordering, please specify the type of angled door (A or B) and dimensions for Left Hand Height (LH), Right Hand Height (RH), Bottom Width (BW) and for stepped angled doors specify Top width (TW).
- Additional 5 day lead time will apply to orders that include angled doors.
- Door sizes above 1700mm high in Bolam, will be supplied with a mid-rail as standard. Mid-rail height is 6x5mm as standard unless otherwise specified at order.

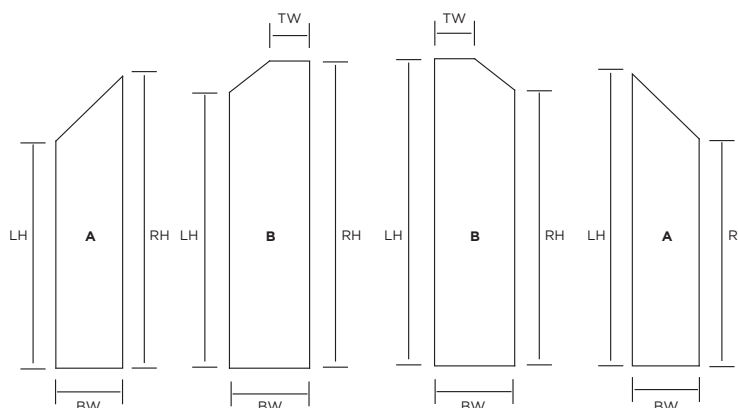

ACCESSORIES

OPEN FRAME DOORS

Open frame doors are available in all door styles in any size.

3 frame options are available on doors:

Min height 1700mm - Max height 2540mm. The top open and top & bottom open frames are available with any mid rail height (655mm supplied unless other requested). Min width 296mm - Max width 650mm.

When ordering, use the prefix codes for the relevant colour in place of ****BESPOKE**

Door style	Code prefix	Price
Acomb	SBA	1
Henshaw	SBA	1
Whitfield	SBA	1
Bolam	SBB	2
Elsdon	SBC	3



Top Open Frame



Top & Bottom Open Frame



Full Open Frame



Georgian Frame Doors
*Not available in Acomb/Elsdon

*Not available in Gloss Colours
(Mid-rail height 655 only)

GLAZING OPTIONS

Available in open and Georgian framed doors

Framed doors can be supplied frame only or rebated with (acrylic) glazing fitted, see glazing options below.



Frame only (no glazing)



Clear Glass



Frosted Glass

CORNICE



Tangent Cornice*
45mm High when fixed.
3050mm length
***C30

*Not available in Gloss Haze or Concrete



Tangent Light Pelmet
57mm High When fixed.
3050mm length
**L30

MULTI-PURPOSE RAIL



55x36x3050mm
***MR30

RADIUS RAIL

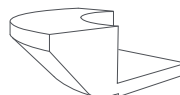

Radius Cornice Piece (Tangent)
120x120mm
***RCP120

*Not available in Gloss Haze or Concrete



Radius Rail
80x34x3050mm
***RR30

PILASTER OPTIONS



Gun Barrel Pilaster
End Block 160 wide
900x93x46mm -
***BPI900

*Not available in High Gloss



Corner post
Please use plinth to create a corner post.



Fluted Pilasters
900x100x18mm - ***FP1900
2540x100x18mm - ***FP12540



Modern Pilasters
900x100x18mm - ***MP1900
2540x100x18mm - ***MP12540

PLINTH

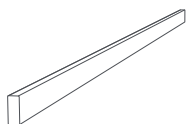

Can be supplied any height between 100mm and 200mm. 2540mm length.
***ACCBESPOKE

SQUARE AND T&G END PANELS



Plain end panel
18 or 25mm thick.
Up to 2540x897mm

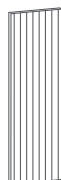

T&G end panel
18 or 25mm thick.
Up to 2540x897mm

Gloss Haze plain panels supplied with white back
Concrete panels supplied with light grey back
25mm panels supplied with cream reverse

GENERAL ACCESSORIES



Edging Tape (pre-glued)
22mmx50m
xxxET1

Gloss Colours have a matt finish except for Gloss White. Not available in Matt Blue Canvas

STANHOPE COMPLETE

Stanhope frontals can now be ordered with an accompanying cabinet which are available in a selection of stocked sizes. Please see page 100 of our Price List for more information.



Single Robe

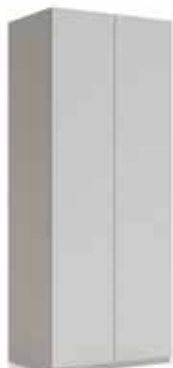

Double Robe

Single Feature Storage Unit



Double Feature Storage Unit



THE MADE-TO-MEASURE COLLECTION

ALPINA

Alpina is a made-to measure collection of timber veneered doors. Available in 6 striking woodgrain designs with a choice of matt and heavily embossed textured finishes. These premium veneer doors will add style to any modern bedroom design and will work well when mixed with other door frontals.

ALPINA SHOWN IN NATURAL OAK AND PARITY MATT WHITE
FROM THE COMPLETE COLLECTION

KEY FEATURES

- Made-to-measure real timber veneer collection
- 6 striking woodgrain designs
- Contemporary palette which includes both matt and heavily embossed textured veneers
- All doors come with a matching matt reverse

ALPINA COMPONENT

Made-to-Measure Collection



STOCKED FINISHES

Prefix code for door range/colour shown in brackets.

MATT TEXTURED



NATURAL
OAK
(BNO)
*Horizontal
grain*



DEEP
OAK
(BDO)
*Horizontal
grain*



SMOKED
OAK
(BSM)
*Horizontal
grain*

TEXTURED FINISHES



BURNT
ASH
(BBA)
*Horizontal
grain*



SMOKED
LARCH
(BSL)
*Horizontal
grain*



MID
OAK
(BMO)
*Vertical
grain*

FRONTAL SPECIFICATION:

DOOR STYLE	Slab
DOOR THICKNESS	Natural Oak and Deep Oak - 18.5mm Burnt ash, Smoked larch and Mid oak - 19.5mm
SPECIFICATION:	Veneered Chipboard, edged
VENEER REVERSE:	Matching veneer back
FINISH:	Real timber veneer

BESPOKE DOOR SIZE PARAMETERS

- ✓ CHOOSE HEIGHT
- ✓ CHOOSE WIDTH

	MIN	MAX
HEIGHT	100mm	2540mm
WIDTH	100mm	897mm

NOTES ON GRAIN DIRECTION

Grain direction varies for different woodgrains

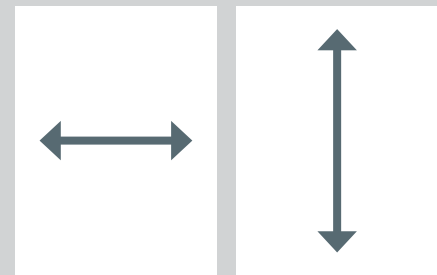

Please refer to door images for grain direction by door finish. All accessories match grain direction of door, with the exception of plinth and cornice which are horizontal grain direction as standard for all finishes.



26 day*
lead time



Made-to-
measure



6 year
guarantee

*For orders received before 12pm midday every Wednesday.

ALPINA COMPONENT

Made-to-Measure size guide

DOOR/DRAWER SIZE PARAMETERS

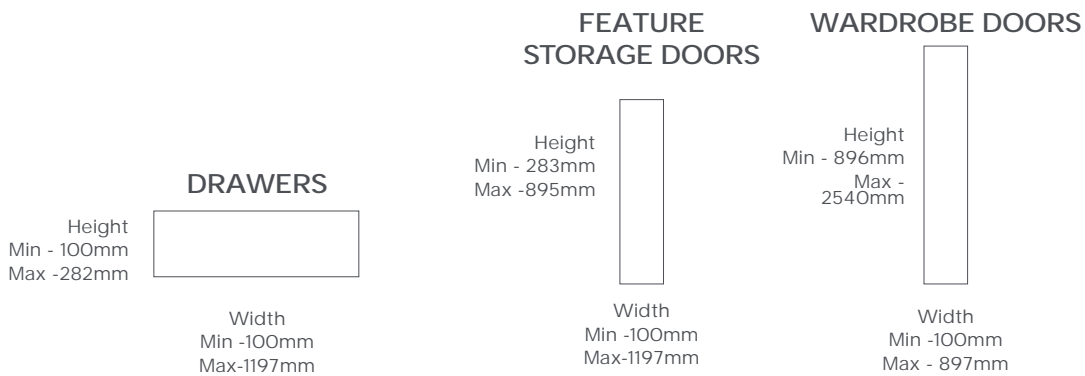

RECOMMENDED COMBINATIONS

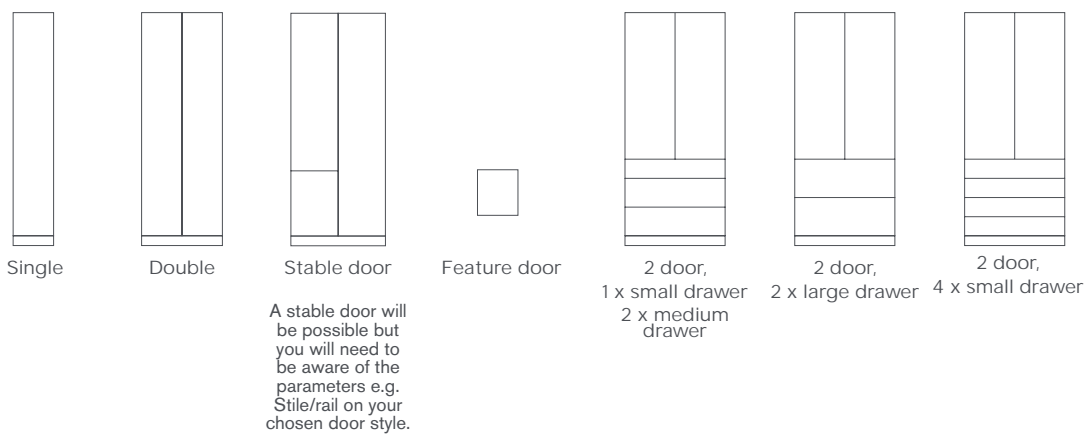

ACCESSORIES - When ordering please use prefix code below in place of **

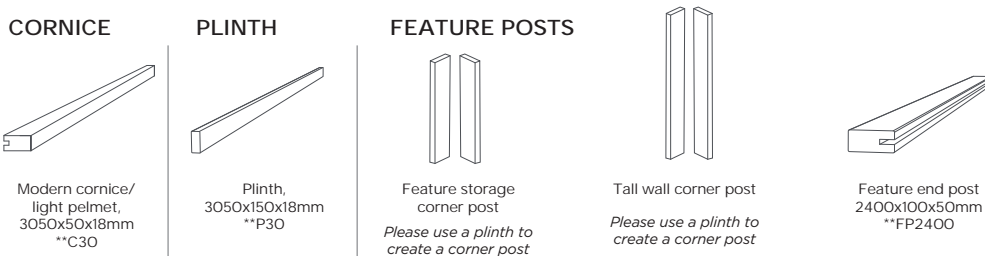

END PANELS

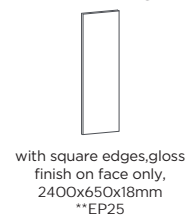

EDGING TAPE





NATURAL OAK



DEEP OAK



BURNT ASH



SMOKED LARCH



MID OAK



SMOKED OAK



Shown above: Alpina in deep Oak

DETAIL



Alpina in Burnt Ash



Drawer front shown in Burnt Ash



Alpina shown in Natural Oak and Parity matt white from the Complete Collection

THE MADE-TO-MEASURE COLLECTION

SLIDING

Available in 35 finishes from glass, satin glass, mirror and panel options, our range of sliding doors enable maximum space. Whether it's a loft of sloping eaves, impressive heights of Georgian ceilings, or a quaint cottage footprint we'll help you achieve more than you ever thought possible.

SLIDING SHOWN IN WHITE GLASS WITH
WHITE MATT LINERS AND END PANELS

KEY FEATURES

- Expertly created in the UK
- Made-to-Measure
- With solid aluminium frames, glass and MFC board panels
- Soft closers fitted as standard
- Internal storage solutions tailored to suit storage needs

SLIDING



SLIDING DOOR CONFIGURATIONS

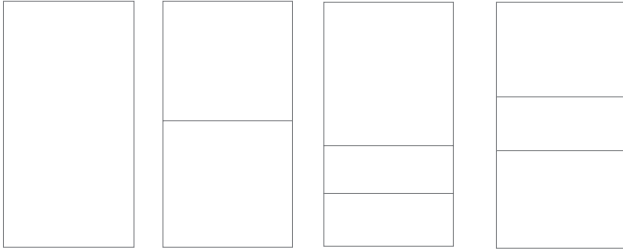

FULL PANEL

EQUAL TWO

LOW 400

CENTRAL 400

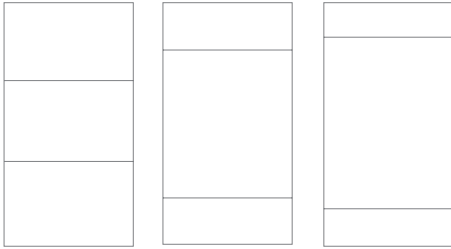

EQUAL THREE

WIDE 400

WIDE 300

FRONTAL SPECIFICATION:

DOOR STYLE	A choice of 8 door styles
DOOR THICKNESS	Dependant on range chosen
DOOR WIDTH	Made-to-measure Minimum 600mm Maximum 1100mm
DOOR HEIGHT	Made-to-measure Minimum 1100mm Maximum 2500mm
SPECIFICATION:	Boards - 118mm MFC Satin, Mirror, Glass - 8mm Glass
FINISH:	8mm - Woodgrain effect MFC, Matt MFC, Gloss MFC, Satin Glass, Glass, Mirror

14 day
lead time

Manufactured
in the UK

Made-to-
measure

Bespoke
sizes

6 year
guarantee*

*More detailed information on guarantee
6 Years - top, bottom, track, wheels, door
frame and joint

Not covered - Soft close mechanism, central
panel and solid panel; glass/mirror/board.



SLIDING

HOW-TO-PLAN YOUR SLIDER

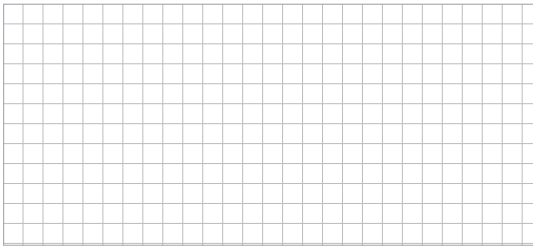

Measure your space

Ensure you are fully equipped to start planning. Measure your space wall to wall, including ceiling heights. Remember to note down things like:

- ✓ Sockets
- ✓ Switches
- ✓ Window ledges
- ✓ Radiators
- ✓ Doors

Create a wardrobe run

You will need to decide how many doors you would like for your run. Whether its 2, 3 or 4.

Please bear in mind if you are using internal storage how this would work with the number of doors you require.

- * Minimum door = 600mm
- * Maximum door = 1100mm

STEP 1

Choose your Aluminium frame profile

Depending on the look you are aiming to achieve with your sliding wardrobe will depend on the frame you may choose. We have five frame types and six frame colours to choose from; some may be easier for you to open than others as each frame type has a different shape.

Its best that you take the time to select the frame that is best for you as once selected it cannot be changed.

Your tracks will be supplied in the same colour as your chosen frame profile.

FRAME OPTIONS



PRISM



FIGURE



CURVE
(for use with glass doors only)



CUBE



SHAPE

BEST SELLERS

FRAME PROFILE COLOUR



SATIN SILVER



WHITE GLOSS



BLACK GLOSS



CHAMPAGNE



WENGE WOODGRAIN



WENGE HIGH GLOSS

STEP 2

Choose your door designs

Choosing your desired door design may come hand in hand with choosing how many doors you require; If you would like your wardrobe to look a certain way it may depend on the width of your space determining how many doors you will require.

When you know, you can choose any mix of door designs within your wardrobe run, with any mix of colours or materials.



FULL PANEL



EQUAL TWO



LOW 400



CENTRAL 400



EQUAL THREE



WIDE 400



WIDE 300

STEP
3

Choose your door finishes

Choose from over 35 colours across matt and gloss coloured board, woodgrain board, glass, satin glass and mirror.

Whether you would like all one colour or mix of materials the choice is yours.

MIRROR

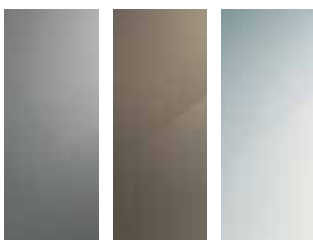
SILVER
MIRRORBRONZE
MIRRORGREY
MIRROR

BOARD COLOURS

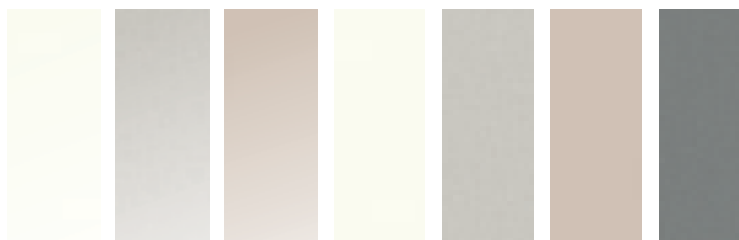
GLOSS
WHITEGLOSS
DOVE GREYGLOSS
CASHMEREMATT
WHITEMATT
DOVE GREYMATT
CASHMEREMATT
ANTHRACITE

WOODGRAIN BOARD COLOURS

CLASSIC
PORCELAINCLASSIC
GREYCLASSIC
STONE

OAK

WALNUT

GLASS COLOURS



WHITE

RICH
ALUMINIUMCLASSIC
GREY

CASHMERE

DAKAR

STONE
GREYMETAL
TAUPEBLUE
SHADOW

ANTHRACITE

AUBERGINE

STARLIGHT
BLACK

SATIN GLASS COLOURS

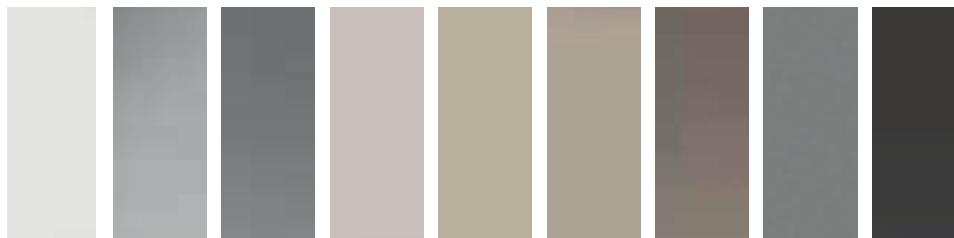
SATIN
WHITESATIN
SILVERSATIN
GREYSATIN
CASHMERESATIN
DAKARSATIN
STONE
GREYSATIN
BRONZESATIN
ANTHRACITESATIN
BLACK

All board thickness 18mm except when using curve profile, board matches 8mm.

T: 01325 505599 | E: sales-support@pws.co.uk

1.90

SLIDING

STEP
4

Choose your end panels and liners

If your wardrobe is going wall to wall you will only require liners but if you require one or two ends open, you will need to choose an end panel as well as a liner. You can choose from matt and gloss coloured board or woodgrain board to frame your wardrobe.

If you need a bit of help on what colours complement each other, why not take a look at our painting guide on page 1.94.

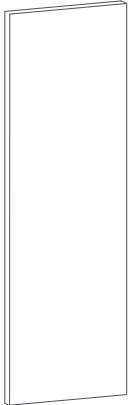

END PANEL









2800mm L x 620mm
W x 18mm D







LINER

2800mm L x 100mm
W x 18mm D

BOARD COLOURS

							
MATT WHITE	MATT CASHMERE	MATT DOVE GREY	MATT ANTHRACITE	MATT BLACK (liner only)	GLOSS WHITE	GLOSS CASHMERE	GLOSS DOVE GREY

WOODGRAIN BOARDS

				
CLASSIC PORCELAIN	CLASSIC STONE	CLASSIC GREY	OAK	WALNUT



STEP
5

Choose your shelf and hanging rail

Whether you simply want a shelf and hanging rail or something a bit more, you can tailor the internals depending on your storage needs.

**HANGING RAIL**

The shelf is supplied at 2800mm (length) x 620mm (depth) with 2 x support batons.

The hanging rail has a maximum width of 2500mm. Please be aware of this when planning internals.

BOARD COLOURSMATT
WHITEMATT
CASHMEREMATT
DOVE GREYMATT
ANTHRACITE**TEXTURED**BEIGE
LINENGREY
LINEN**WOODGRAIN BOARDS**CLASSIC
PORCELAINCLASSIC
STONECLASSIC
GREY

OAK



WALNUT

**HANGING
RAIL**

SILVER

SLIDING RANGE TO BOARD MATCH

HOW TO USE THE BOARD MATCH CHART

Whether you are looking for a board match on the sliding collection alone, or would like to see which colour chests or bedframes you can mix with the sliding collection, this sliding board match table should have all the matches you require.

	SECTION 1 WARDROBE/CHESTS		SECTION 2 SLIDING		
	Glass Colour 8mm	Satin Glass Colour 8mm	Board Colour 8mm	End Panels & Liners 18mm	Internal Colour 18mm
These finishes are relating to the MODERN COLLECTION: - Modern Chests - Sculpt - Parity - Flow - Esker	Modern - Matt				
	White	SATIN WHITE	MATT WHITE	MATT WHITE	MATT WHITE
	Cashmere	SATIN CASHMERE	MATT CASHMERE	MATT CASHMERE	MATT CASHMERE
	Dove Grey	N/A	MATT DOVE GREY	MATT DOVE GREY	MATT DOVE GREY
These finishes are relating to the CLASSIC COLLECTION: - Classic Chests - Chapter - Origin	Modern - Gloss				
	White	SATIN WHITE	GLOSS WHITE	GLOSS WHITE	N/A
	Cashmere	SATIN CASHMERE	GLOSS CASHMERE	GLOSS CASHMERE	N/A
	Dove Grey	N/A	GLOSS DOVE GREY	GLOSS DOVE GREY	N/A
Classic					
Porcelain	N/A	N/A	CLASSIC PORCELAIN	CLASSIC PORCELAIN	N/A
Partridge Grey	CLASSIC GREY	N/A	CLASSIC GREY	CLASSIC GREY	N/A
Stone	CASHMERE	SATIN CASHMERE	CLASSIC STONE	CLASSIC STONE	N/A

TO MATCH;

Wardrobe/Chest finishes with sliding finishes.

Use both sections. Use the left column to choose your finish. View horizontally to see which Sliding door finishes, end panels/liners and Internal colours are the best match for your chest finish.

TO MATCH;

Sliding door finishes with end panels and internals.

Only use Section 2 - Sliding. View horizontally to see what recommendations we have to the closest match when choosing your sliding doors and accessories finishes.

EXAMPLE:



If you have chosen a Modern Matt Cashmere Chest, we think the closest colour match to this finish for sliding doors would either be (1) Gloss Cashmere door, (2) Satin Glass finish would be Satin Cashmere or (3) Matt Cashmere board finish. If you were looking for the end panel match for your slider, this would be Matt Cashmere (4), as well as the internal colour (5).

SLIDING RANGE TO BOARD MATCH

DOORS				
Glass Colour 8mm	Satin Glass Colour 8mm	Board Colour 8mm	End Panels & Liners 18mm	Internal Colour 18mm

Modern - Matt

White	WHITE	SATIN WHITE	MATT WHITE	MATT WHITE	MATT WHITE
Cashmere	CASHMERE	SATIN CASHMERE	MATT CASHMERE	MATT CASHMERE	MATT CASHMERE
Dove Grey	N/A	N/A	MATT DOVE GREY	MATT DOVE GREY	MATT DOVE GREY
Anthracite	ANTHRACITE	SATIN ANTHRACITE	MATT ANTHRACITE	MATT ANTHRACITE	MATT ANTHRACITE

Modern - Gloss

White	WHITE	SATIN WHITE	GLOSS WHITE	GLOSS WHITE	N/A
Cashmere	CASHMERE	SATIN CASHMERE	GLOSS CASHMERE	GLOSS CASHMERE	N/A
Dove Grey	N/A	N/A	GLOSS DOVE GREY	GLOSS DOVE GREY	N/A

Classic

Porcelain	N/A	N/A	CLASSIC PORCELAIN	CLASSIC PORCELAIN	N/A
Partridge Grey	CLASSIC GREY	N/A	CLASSIC GREY	CLASSIC GREY	N/A
Stone	CASHMERE	SATIN CASHMERE	CLASSIC STONE	CLASSIC STONE	N/A

We do not recommend using gloss or woodgrain colours as internals as they are prone to marking and damage. However these are available should your customer want them.

SLIDING HOW TO MEASURE GUIDE

Follow our measurement guide to accurately complete your order form.

To receive an order form please contact the sales team by emailing sales-support@pws.co.uk or calling 01325 329 050

Measure your space

It is very important that you take accurate measurements before ordering your sliding wardrobe.



Use a **spirit level** to check the walls, ceiling and floor is level.

If the floor is very uneven, the doors may slide unintentionally!

We hope to eliminate any instances where the floor and walls may be slightly out with the liners that the tracks and doors fit too on both the floor and the top of the wardrobe.



MAXIMUM

The maximum tolerance we are likely to be able to adjust is 15mm when the walls are not straight.

You can have full floor to ceiling sliding doors on any height opening, up to a maximum of 2500mm.



MINIMUM

Our smallest recommended opening width for sliding doors is 1100mm.

WALL TO WALL

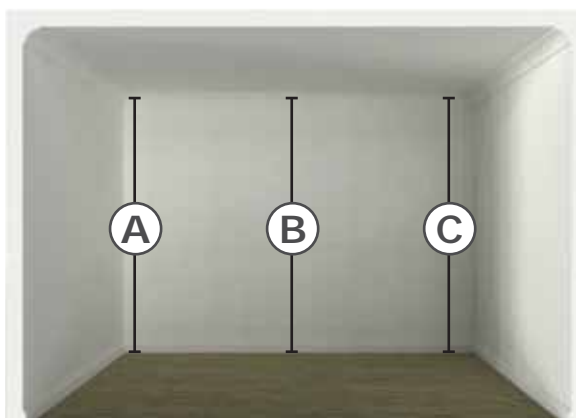

Measuring height

1A



Measure the height of your opening in at least three places.

We recommend measuring both outside uprights (A & C) and from the centre (B)

IMPORTANT: Please always provide us with the smallest measurements

Remember to include factors that may affect the position of your wardrobe such as sockets, switches, window ledges or pipes etc.

Measuring width

1B

WALL TO WALL



It is important to check the walls with a spirit level to see if they bow or curve. Our liners will eliminate any instances up to a maximum of 15mm. If the walls are out by more than this, we will add additional liners or end panels depending on the difference to ensure the opening can be made straight.

If you have coving and skirting, we will need to remove a section to fit the liner to during the installation



Again, we recommend you measure the width of your opening in at least three places. We recommend measuring the top (D) bottom (F) and from the centre (E)

Please ensure you measure (F) above any skirting board and (D) below any coving that may hinder wardrobe installation.

IMPORTANT: Please always provide us with the smallest measurements

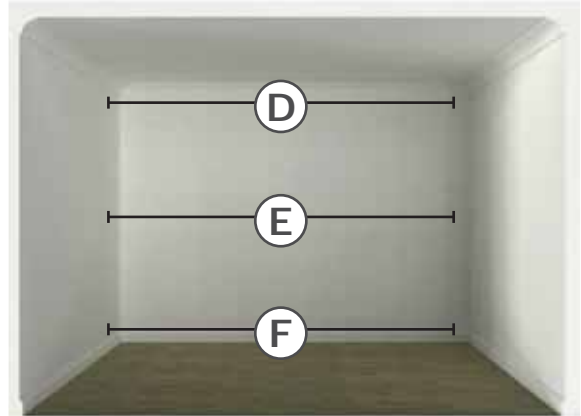

Single end panel

2

If your wardrobe cannot go from wall to wall because of obstructions such as a door, or your room does not require a wall to wall wardrobe you can use an end panel on one end.

We still recommend you measure the width of your opening in at least two places. We recommend measuring the top (G) bottom (H)

IMPORTANT: In the case of wall to end panel measure the dimension from the wall you would like the wardrobe to fix to along to the proposed end where the end panel will be.

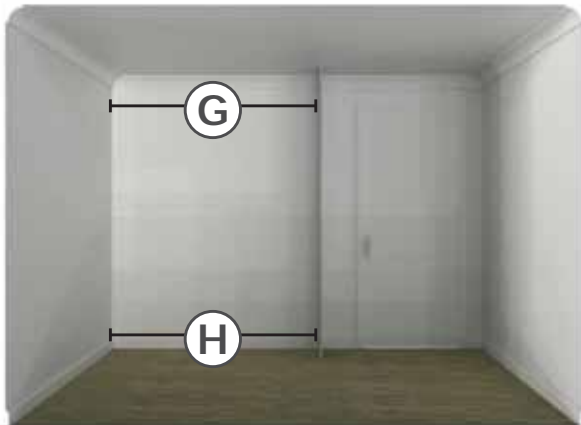

Double end panel

3

If your wardrobe cannot go from wall to wall or you do not want to have it fixed to a wall at one side; you can create a free-standing sliding wardrobe in an open space. *As long as the back of the wardrobe can fix to a flat wall.*

You will need to measure the entirety of the open space you would like to have a sliding wardrobe. (I)

IMPORTANT: provide the maximum width you want your wardrobe to be.

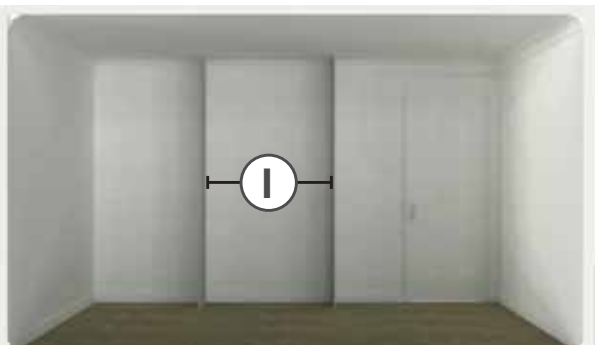

SLIDING

FRAME OPTIONS

The look you are aiming to achieve with your sliding wardrobe will depend on the frame you may choose. We have five frame types and six frame colours to choose from; some may be easier for you to open than others as each frame type has a different shape. Its best that you take the time to select the frame that is best for you as once selected it cannot be changed.

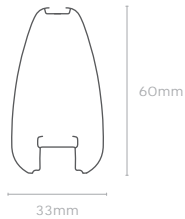
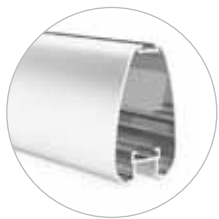

PRISM

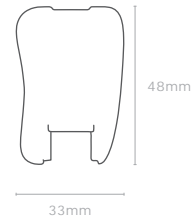
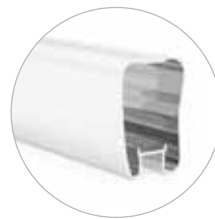

FIGURE

BEST SELLER

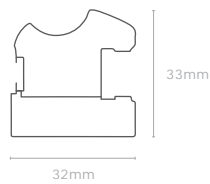
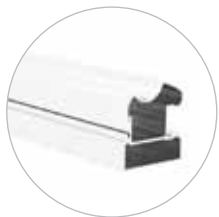

SHAPE

BEST SELLER

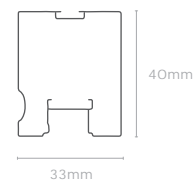
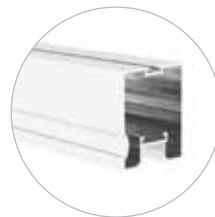

CUBE

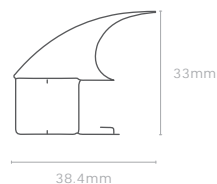

CURVE

(for use with glass doors only)

FRAME PROFILE COLOURS

Sliding wardrobe tracks will be coloured to match the frame.

SATIN SILVER



CHAMPAGNE



BLACK GLOSS



WHITE GLOSS

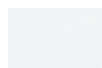

WENGE WOODGRAIN



WENGE HIGH GLOSS



DOOR DESIGNS

Truly bespoke in function, we offer seven designs to choose from. You could choose to have all of your doors within one or multiple door designs.

Choosing your desired door design may come hand in hand with choosing how many doors you require; If you would like your wardrobe to look a certain way it may depend on the width of your space determining how many doors you will require.

You can choose any mix of door designs within your wardrobe run, with any mix of colours or materials.

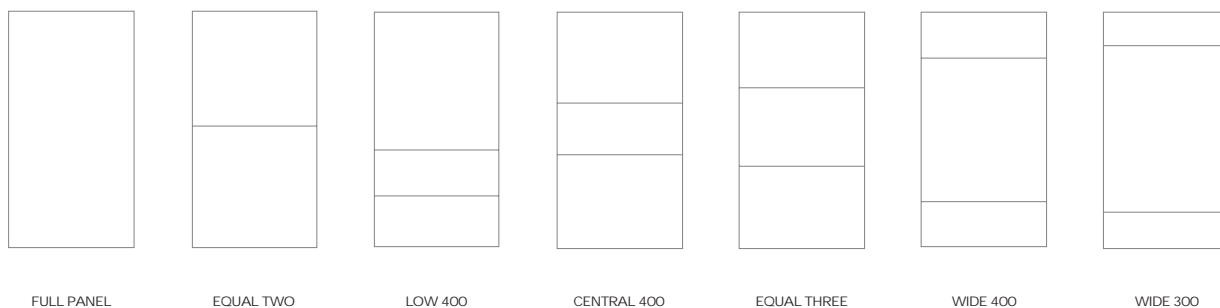

DOOR COLOURS

Choose from over 35 door colour options ranging from glass, satin glass, mirror, matt, gloss and textured woodgrain boards.

Depending on the door design you can mix and match up to three materials.

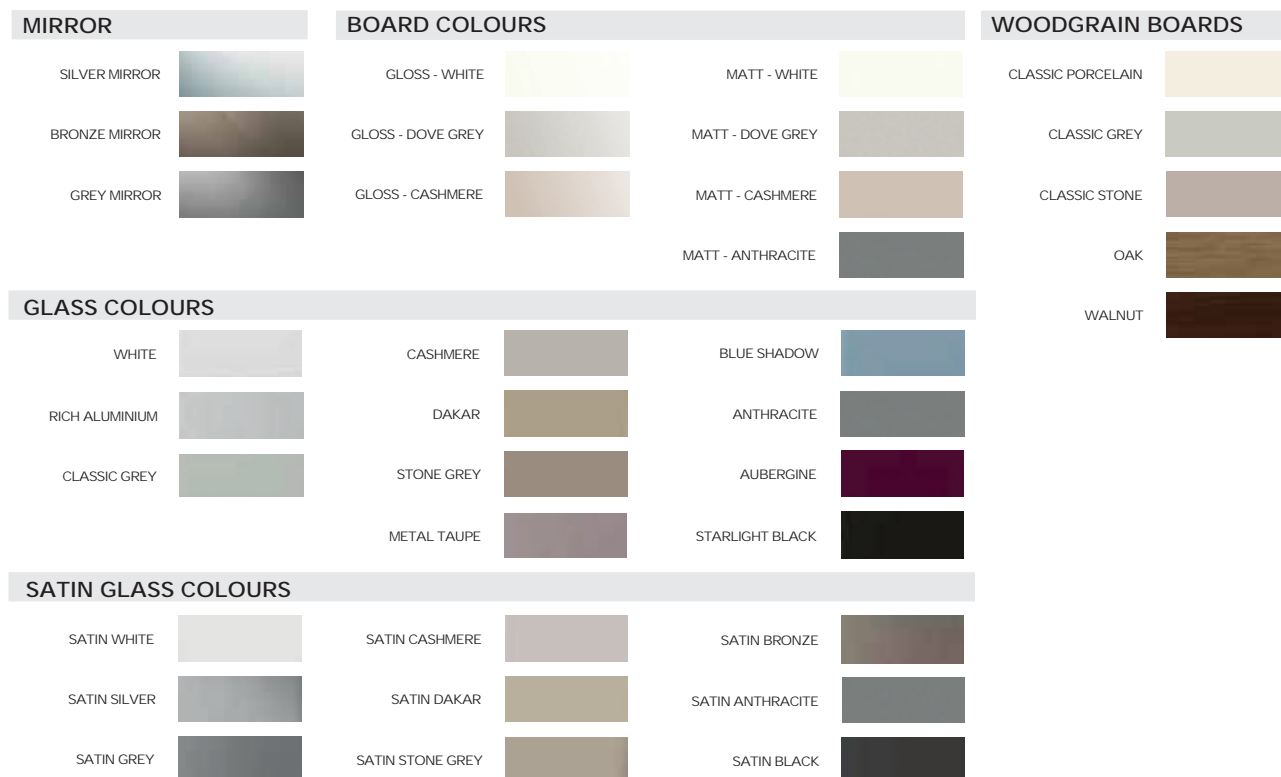

SLIDING ACCESSORIES

END PANELS AND LINERS

In a wall to wall wardrobe we always recommend using 4 x liners to create a finished edge for the doors to run into. These also help to disguise imperfections where walls, floors and ceilings are uneven.

End panels are great to use if you don't have a wall to wall space, or to reduce the height left at the top of the wardrobe in instances with high ceilings.



END PANEL

2800mm L x 620mm
W x 18mm D



LINER

2800mm L x 100mm
W x 18mm D

COLOURS FOR END PANEL OR LINERS

Panel
thickness
18mm

BOARD COLOURS		WOODGRAIN BOARDS	
MATT WHITE	GLOSS WHITE	CLASSIC PORCELAIN	OAK
MATT CASHMERE	GLOSS CASHMERE	CLASSIC STONE	WALNUT
MATT DOVE GREY	GLOSS DOVE GREY	CLASSIC GREY	LINEN
MATT ANTHRACITE			GREY LINEN
MATT BLACK (liner only) <small>NEW</small>			Linen is only recommended for internal use

SLIDING INTERNALS

SHELF AND HANGING RAIL

The shelf and hanger rail provides a practical standard hanging solution.

It can be used individually or as multiples, combined together with the use of an end panel between for larger widths; additionally to this you could use end panels to create shelves.

The shelf is supplied at a 2800mm (width) x 620mm (depth) and comes with two baton lengths for support. It is important to note that the maximum length of a hanging rail is 2500mm. The hanging rail comes with a central vertical support, two end brackets and two ceiling fixture supports as standard. Please speak to a member of our team for further information on alternative options.



SHELF AND HANGER

Standard storage fits a maximum width of 2800mm and are 620mm deep

COLOURS FOR SHELF AND HANGING RAIL

Panel thickness 18mm

We do not recommend gloss panels for shelves and hanging rails as they are more likely to scratch and mark.

BOARD COLOURS	WOODGRAIN BOARDS		TEXTURED
MATT WHITE	CLASSIC PORCELAIN	OAK	BEIGE LINEN
MATT CASHMERE	CLASSIC STONE	WALNUT	GREY LINEN
MATT DOVE GREY	CLASSIC GREY		
MATT ANTHRACITE			
HANGING RAIL			
SILVER			

Additional hanging rail end brackets and central bracket for vertical supports are available on request.

CO-ORDINATING MFC BOARD OPTIONS

The below MFC board options are only suggested matches to our door colours and do not necessarily offer a direct match. We strongly recommend that you order board samples and compare against the door before making your final cabinet finish selection.

STOCKED AND PAINT-TO-ORDER DOOR COLOURS

COLOUR	STOCK DOOR AVAILABILITY	PAINT-TO-ORDER AVAILABILITY	MFC BOARD OPTIONS
Alabaster Modern	-	✓	Egger - U104, Kronospan - 7031
Anthracite	Origin, Parity (matt only), Sculpt		Egger - U732 ST9 Dust Grey
Bay Green	-	✓	n/a
Cadet	-	✓	n/a
Carbon	-	✓	Egger - U999, Kronospan - 0190
Cashmere	Origin, Parity (matt/gloss), Sculpt	✓	Egger - U702 ST9 Cashmere Grey (matt), U702 ST30 Cashmere Grey (gloss), Kronospan - 5981
Chalk	-	✓	n/a
Chalk Blue	-	✓	n/a
Charcoal	-	✓	n/a
China Blue	-	✓	n/a
Copse Green	-	✓	n/a
Cornflower	-	✓	n/a
Dove Grey	Origin, Parity (matt/gloss), Sculpt	✓	Egger - U708 ST9 Light Grey (matt), U708 Light Grey ST30 (gloss), Kronospan - 0112
Dry Rose	-	✓	n/a
Dust Grey	-	✓	Egger - U732, Kronospan - 0171
Georgian Red	-	✓	n/a
Graphite	-	✓	Egger - U961, Kronospan - 0164
Hartforth Blue	-	✓	Egger U599 Kronospan - 8984BS
Inkwell	-	✓	n/a
Ives Blue	-	✓	Egger - U533
Lava	-	✓	Egger - U741, Kronospan - 7184
Mussel	-	✓	Egger - U100, Kronospan - 5982
Olive	-	✓	n/a
Partridge Grey	Chapter, Origin	✓	Egger U708 Light Grey
Pimento	-	✓	n/a
Porcelain	Chapter, Origin	✓	Egger - W1200 Porcelain White
Putty	-	✓	n/a
Regents Green	-	✓	n/a
Regiment	-	✓	n/a
Sage	-	✓	n/a
Silver Grey	-	✓	Egger - U765
Slate	-	✓	n/a
Stone	Chapter, Origin	✓	Egger U207 Cashmere Grey
Storm Blue	-	✓	n/a
Truffle	-	✓	Egger - U748
White	Parity (matt/gloss), Sculpt	✓	Egger - W1000 ST9 Premium White (matt), W1000 Premium White ST30 (gloss), Kronospan - 0113

UNITY MADE-TO-MEASURE - COLOURS

COLOUR	DOOR OPTIONS	MFC BOARD OPTIONS
Cashmere	Acrylic Gloss, Supermatt PVC	Egger - U702, Kronospan - 5981
Dust Grey	Acrylic Gloss, Supermatt PVC	Egger - U732, Kronospan - 0171
Fjord	Metallic Gloss	Egger - U636, Kronospan - K097
Gold	Metallic Gloss	n/a
Graphite	Acrylic Gloss, Supermatt PVC	Egger - U961, Kronospan - 0164
Indigo	Supermatt PVC	Egger - U599
Light Grey	Acrylic Gloss, Supermatt PVC	Egger - U708, Kronospan - 0112
Pebble Grey	Supermatt PVC	Egger - U201
Pure White	Acrylic Gloss, Supermatt PVC	Egger - W1000, Kronospan - 0113

UNITY MADE-TO-MEASURE - WOODGRAINS

COLOUR	MFC BOARD OPTIONS
Black Ash	Egger - U999, Kronospan - 0190
Character Graphite	Egger - H3452
Natural Davos Oak	Egger - H3131, Kronospan - K006
Reclaimed Oak	Egger - H1180, Kronospan - K003
Sepia Gladstone Oak	Egger - H3342
White Halifax Oak	Egger - H1176, Kronospan - 5529

STANHOPE MADE-TO-MEASURE

COLOUR	MFC BOARD OPTIONS
Gloss White	Egger - W980, Kronospan - K101, Pfleiderer - W300, Finsa - 020
Gloss Cream	Egger - U104, Kronospan - U514 / 7031, Pfleiderer - U1306, Finsa - 65B
Gloss Cashmere	Egger - U702, Kronospan - 5981, Pfleiderer - U1168, Finsa - 15R
Gloss Dove Grey	Egger - U708, Kronospan - 0112, Pfleiderer - U1188, Finsa - U12
Gloss Dust Grey	Egger - U732
Concrete	n/a
Porcelain	Egger - W1100
Cashmere	Egger - U702, Kronospan - 5981, Pfleiderer - U1168, Finsa - 15R
Dove Grey	Egger - U708, Kronospan - 0112, Pfleiderer - U1188, Finsa - U12
Dust Grey	Egger - U732
Indigo Blue	Egger - U599
Blue Canvas	Egger - U540, Pfleiderer - U18002 (U1717)
Graphite	Egger - U961
Super White Woodgrain	Egger - W980, Kronospan - K101, Pfleiderer - W300, Finsa - 020
Cream Woodgrain	Egger - U104, Kronospan - U514, Pfleiderer - U1303, Finsa - 65B
Grey Woodgrain	Egger - U708, Kronospan - 0112, Pfleiderer - U1188, Finsa - U12
Dove Grey	Egger - U708
Matt Black	Egger - U999
Mussel Woodgrain	Egger - U100, Pfleiderer - U1331, Finsa - 194
Cashmere Woodgrain	Egger - U702, Kronospan - 5981, Pfleiderer - U1168, Finsa - 15R
Thorpe Green	Pfleiderer - U19008

SLIDING BOARD COLOURS

COLOUR	MFC BOARD OPTIONS
Matt White	W1000 ST9 Premium White
Gloss White	W1000 Premium white ST30
Matt Cashmere	U702 ST9 Cashmere Grey
Gloss Cashmere	U702 ST30 Cashmere Grey
Matt Dove Grey	U708 ST9 Light Grey
Gloss Dove Grey	U708 Light Grey ST30
Matt Anthracite	U732 ST9 Dust Grey
Porcelain Woodgrain	W1200 Porcelain White ST27
Partridge Grey Woodgrain & Classic Grey Woodgrain	U708 Light Grey ST27
Stone Woodgrain	U702 Cashmere Grey ST27
Oak Woodgrain	H3368 Natural Lancaster Oak ST9
Walnut Woodgrain	H3702 Tobacco Pacific Walnut ST10
Linen	F416 Beige Linen ST10, F417 Grey Linen ST10

Please Note: for any colour without a suggested board option we recommend considering a contrasting colour or woodgrain

A modern wardrobe with a dark wood finish and gold-colored hardware. The wardrobe is open, revealing a hanging rail with several items of clothing, including a white checkered shirt, a red dress, a white shirt, and a dark jacket. Below the hanging rail are shelves with various accessories, including a black belt, a black bag, and a pink box. At the bottom of the wardrobe are three drawers with gold-colored handles. The wardrobe is illuminated by a warm, ambient light strip along the top edge.

INTERNAL ACCESSORIES

INTERNAL ACCESSORIES

Hanging Rails	03
Additional Shelving	05
Stackable Internal Drawers	09
Single Stackable Internal Drawers	11
Internal Drawer Bundles	13
Additional Storage Solutions	15
Internal Bundles 500/800/900	17
Internal Bundles 1000	19



INTERNAL ACCESSORIES

HANGING RAILS

Designed to fit within our complete wardrobes, these hanging rails come with two fixing options that allow them to be fixed to a shelf above, or to the wardrobe cabinet depending on the internal configuration.

PHOTOGRAPHY: SATIN BROWN HANGING RAIL SHOWN.

KEY FEATURES

- Pre-cut to suit all complete wardrobe widths
- Multiple fixing options
- Ridged rail profile to prevent hanger movement
- Comes supplied with fixings

PRODUCT SPECIFICATION:







SPECIFICATION	Aluminium rail
FINISH	Bronze effect finish

HANGING RAILS



SATIN BROWN

Designed to fit within our complete wardrobes within section ** these hanging rails come with two fixing options, that allow them to be fixed to a shelf above, or to the wardrobe gables depending on the internal configuration.

	Product code	Description	Max Weight Restrictions
Width 400mm			
Hanging Rail			
	KD1313HR400	400mm hanging rail in Satin Brown	14.1kg
Width 450mm			
Hanging Rail			
	KD1313HR450	450mm hanging rail in Satin Brown	16.1kg
Width 500mm			
Hanging Rail			
	KD1313HR500	500mm hanging rail in Satin Brown	18.1kg
Width 800mm			
Hanging Rail			
	KD1313HR800	800mm hanging rail in Satin Brown	30.1kg
Width 900mm			
Hanging Rail			
	KD1313HR900	900mm hanging rail in Satin Brown	34.1kg
Width 1000mm			
Hanging Rail			
	KD1313HR1000	1000mm hanging rail in Satin Brown	38.1kg



INTERNAL ACCESSORIES

ADDITIONAL SHELVING

Designed to suit our complete wardrobes, additional shelves are available in Linen, Walnut and Oak effect to complement any of the internal options. Additional shelves are sold in pairs.

PHOTOGRAPHY: WALNUT EFFECT SHELVES SHOWN.

KEY FEATURES

- Packed in pairs
- 22mm MDF
- Foil wrapped (edge banded on 2 short edges)
- Depth 500mm
- Available to suit 400, 450, 500, 800, 900 and 1000mm wardrobe widths
- Available in Linen, Walnut and Textured Oak Effect
- One shelf pack comes with 8 x shelf studs for adjustable shelves and 8x brackets used for fixing the shelves above the stackable drawers.

ADDITIONAL SHELVING

		
WALNUT EFFECT	OAK EFFECT	LINEN
08	09	12

STOCKED FINISHES

Colour reference code shown below shelf.

SHELVES TO FIT SINGLE WARDROBE

		
WALNUT EFFECT	OAK EFFECT	LINEN
08	09	12

SHELVES TO FIT DOUBLE WARDROBE

		
WALNUT EFFECT	OAK EFFECT	LINEN
08	09	12

PRODUCT SPECIFICATION:

THICKNESS	22mm MDF
EDGE PROFILE	Foil wrapped (edge banded on 2 short edges)
DEPTH	500mm
AVAILABLE TO SUIT	400 / 500 / 800 / 900 / 1000mm wardrobe widths
AVAILABLE IN	Linen / Walnut / Textured Oak

SHELVING DETAIL



SHELF FINISH	COMPLEMENTARY BOARD MATCHES
Linen	Egger F417 Grey Linen Egger F416 Beige Linen
Walnut Effect	H3702 Tobacco Pacific Walnut ST10
Oak Effect	Egger H3368 Natural Lancaster Oak

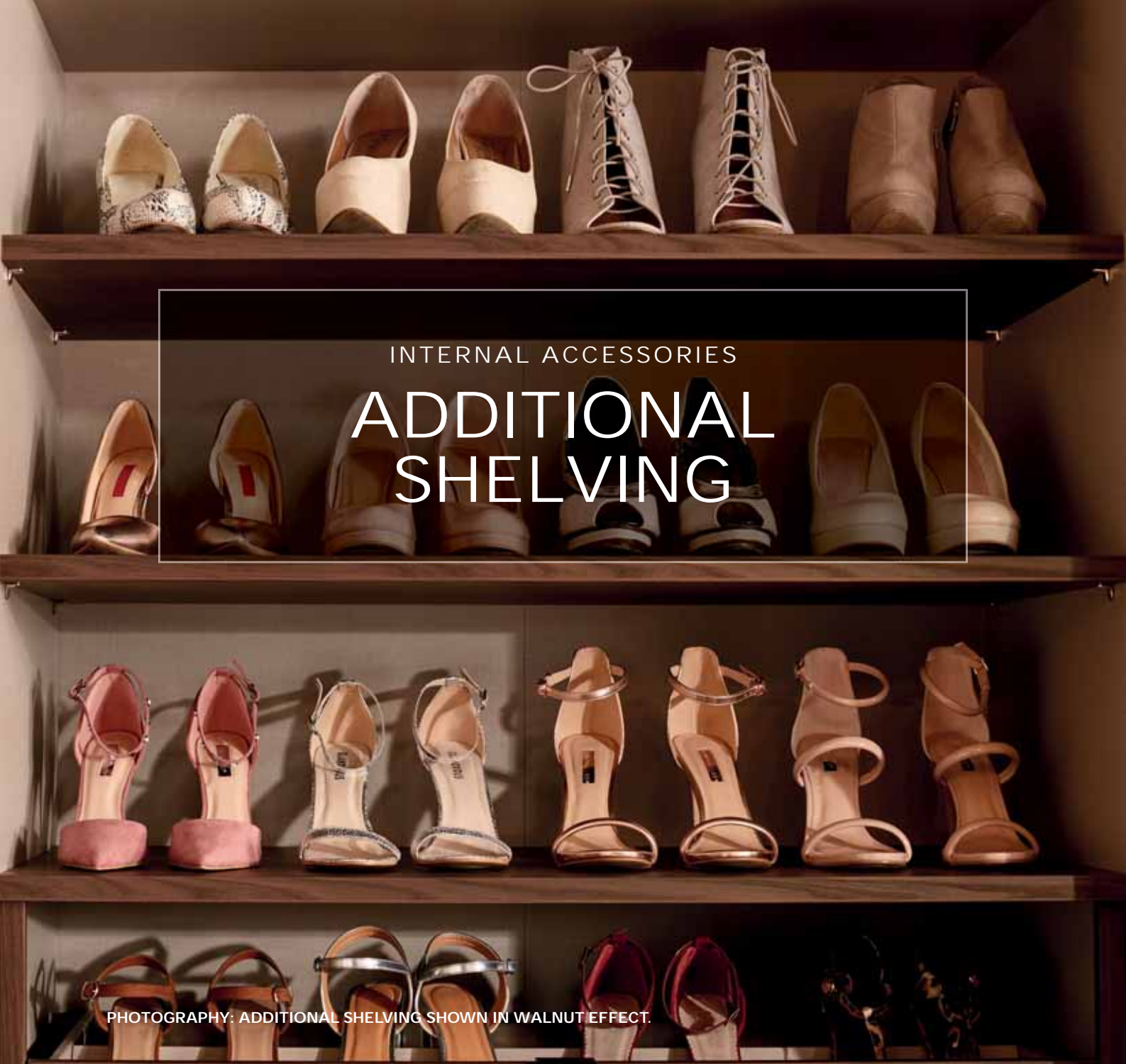

INTERNAL ACCESSORIES

ADDITIONAL SHELVING

PHOTOGRAPHY: ADDITIONAL SHELVING SHOWN IN WALNUT EFFECT.

Standard linen shelf included in the robe pack is 554mm in depth. Additional shelves in linen/oak/walnut are 500mm in depth. All additional shelves come packed in pairs.

KEY FEATURES

- Pre-cut to suit all complete wardrobe widths
- Packed in pairs
- Foil wrapped (edge banded on 2 short edges)

ADDITIONAL SHELVING

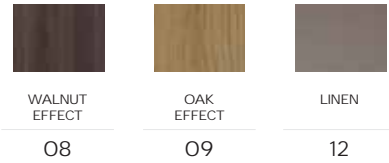

Colour reference code for shelf shown at the top of the page.

Product code	Description	Max Weight Restrictions	Product code	Description	Max Weight Restrictions
Width 400mm			Width 800mm		
KD13**SH400	To Fit Single Wardrobe (H) 22mm (W) 364mm (D) 500mm Additional shelves for wardrobe, pair	18.2kg	KD13**SH800	To Fit Double Wardrobe (H) 22mm (W) 764mm (D) 500mm Additional shelves for wardrobe, pair	38.2kg
Width 450mm			Width 900mm		
KD13**SH450	To Fit Single Wardrobe (H) 22mm (W) 414mm (D) 500mm Additional shelves for wardrobe, pair	20.7kg	KD13**SH900	To Fit Double Wardrobe (H) 22mm (W) 864mm (D) 500mm Additional shelves for wardrobe, pair	43.2kg
Width 500mm			Width 1000mm		
KD13**SH500	To Fit Single Wardrobe (H) 22mm (W) 464mm (D) 500mm Additional shelves for wardrobe, pair	23.2kg	KD13**SH1000	To Fit Double Wardrobe (H) 22mm (W) 964mm (D) 500mm Additional shelves for wardrobe, pair	48.2kg



INTERNAL ACCESSORIES

STACKABLE INTERNAL DRAWERS

Designed to suit our complete wardrobes within section six the stackable internal drawers are available to buy in singles or bundle combinations depending on the internal configuration.

PHOTOGRAPHY: OAK EFFECT STACKABLE DRAWERS.

KEY FEATURES

- Supplied flatpack
- 450mm Blum runners
- Available to suit 500 / 800 / 900/ 1000 complete wardrobes
- Available in 3 finishes: Linen / Walnut / Oak
- Brushed bronze handle included (adds 2mm to height of drawer front)
- Supplied with matching fillers

STACKABLE INTERNAL DRAWERS

		
WALNUT EFFECT	OAK EFFECT	LINEN
08	09	12

STOCKED FINISHES

Colour reference code shown below drawer.

SHALLOW



WALNUT EFFECT

08

OAK EFFECT

09

LINEN

12

DEEP



WALNUT EFFECT

08

OAK EFFECT

09

LINEN

12

3 DRAWER BUNDLES



OAK EFFECT

09



LINEN

12



WALNUT EFFECT

08

4 DRAWER BUNDLES



OAK EFFECT

09



LINEN

12



WALNUT EFFECT

08

PRODUCT SPECIFICATION:

DRAWER BOX	12mm thick
TOTAL DEPTH	468mm
DRAWER FRONT HEIGHT	123/251mm

DRAWER DETAIL



DRAWER FINISH	COMPLEMENTARY BOARD MATCHES
Linen	Egger F417 Grey Linen Egger F416 Beige Linen
Walnut Effect	Egger H3702 Tobacco Pacific Walnut ST10
Oak Effect	Egger H3368 Natural Lancaster Oak



INTERNAL ACCESSORIES

STACKABLE INTERNAL DRAWERS

PHOTOGRAPHY: DEEP STACKABLE DRAWERS SHOWN.

KEY FEATURES

- Supplied flatpack
- 450mm Blum runners
- Available to suit 500/800/900/1000 complete wardrobes
- Available in 3 finishes: Linen / Walnut / Oak
- Brushed Bronze handle included (adds 2mm to height of drawer front)
- Supplied with matching fillers

PRODUCT SPECIFICATION:

DRAWER BOX	12mm thick
TOTAL DEPTH	468mm
DRAWER FRONT HEIGHT	123/251mm

STACKABLE INTERNAL DRAWERS

WALNUT
EFFECT

08

OAK
EFFECT









09



LINEN

12

Colour reference code for drawer shown at the top of the page.

Product code		Description	Product code		Description
Width 500mm			Width 500mm		
Single Shallow (H) 125mm (W) 464mm (D) 468mm 	KD13**DS500	500mm shallow drawer	Single Deep (H) 253mm (W) 464mm (D) 468mm 	KD13**DD500	Single shallow drawer
Width 800mm			Width 800mm		
Single Shallow (H) 125mm (W) 764mm (D) 468mm 	KD13**DS800	Single shallow drawer	Single Deep (H) 253mm (W) 764mm (D) 468mm 	KD13**DD800	Single shallow drawer
Width 900mm			Width 900mm		
Single Shallow (H) 125mm (W) 864mm (D) 468mm 	KD13**DS900	Single shallow drawer	Single Deep (H) 253mm (W) 864mm (D) 468mm 	KD13**DD900	Single shallow drawer
Width 1000mm			Width 1000mm		
Single Shallow (H) 125mm (W) 964mm (D) 468mm 	KD13**DS1000	Single shallow drawer	Single Deep (H) 253mm (W) 964mm (D) 468mm 	KD13**DD1000	Single shallow drawer

REMINDER

- To complete your stackable drawer a set, 1 x shelf pack of the same width needs to be added to your order.
- Each stackable drawer is supplied with x2 fillers which will require cutting. These conceal the drawer runners.
- This means when using more than one drawer per wardrobe there will be excess fillers.
- Comes supplied with fixings.



INTERNAL ACCESSORIES

STACKABLE INTERNAL DRAWER BUNDLES

PHOTOGRAPHY: WALNUT EFFECT 3 DRAWER BUNDLE SHOWN.

KEY FEATURES

- Supplied flatpack
- 450mm Blum runners
- Available to suit 500/800/900/1000 complete wardrobes
- Available in 3 finishes: Linen / Walnut / Oak
- Brushed bronze handle included (adds 2mm to height of drawer front)
- Supplied with matching fillers
- Shelf pack included so will have 1x remaining shelf

PRODUCT SPECIFICATION:



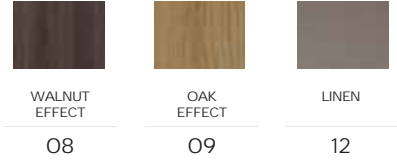

DRAWER BOX	12mm thick
TOTAL DEPTH	468mm
DRAWER FRONT HEIGHT	123/251mm

STACKABLE INTERNAL DRAWER BUNDLES







Colour reference code for drawer shown at the top of the page.

3 DRAWER BUNDLES

Product code	Description
Width 500mm	
3 Drawer Bundle (H) 660mm (W) 464mm (D) 450mm 	KD13**S3500 500mm 3 drawer bundle for wardrobe
Width 800mm	
3 Drawer Bundle (H) 660mm (W) 764mm (D) 450mm 	KD13**S3800 800mm 3 drawer bundle for wardrobe
Width 900mm	
3 Drawer Bundle (H) 660mm (W) 864mm (D) 450mm 	KD13**S3900 900mm 3 drawer bundle for wardrobe
Width 1000mm	
3 Drawer Bundle (H) 660mm (W) 964mm (D) 450mm 	KD13**S31000 1000mm 3 drawer bundle for wardrobe

4 DRAWER BUNDLES

Product code	Description
Width 500mm	
4 Drawer Bundle (H) 790mm (W) 464mm (D) 450mm 	KD13**S4500 500mm 4 drawer bundle for wardrobe
Width 800mm	
4 Drawer Bundle (H) 790mm (W) 764mm (D) 450mm 	KD13**S4800 800mm 4 drawer bundle for wardrobe
Width 900mm	
4 Drawer Bundle (H) 790mm (W) 864mm (D) 450mm 	KD13**S4900 900mm 4 drawer bundle for wardrobe
Width 1000mm	
4 Drawer Bundle (H) 790mm (W) 964mm (D) 450mm 	KD13**S41000 1000mm 4 drawer bundle for wardrobe



INTERNAL ACCESSORIES

ADDITIONAL STORAGE SOLUTIONS





To allow additional internal creativity within our complete wardrobes we have designed some key additional storage options.

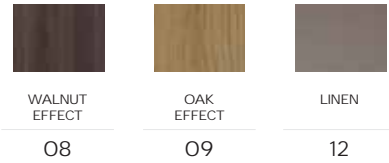

For more information on these products please see the product specification pages within the technical information section.

PHOTOGRAPHY: PIGEON HOLE UNIT SHOWN.

ADDITIONAL STORAGE SOLUTIONS

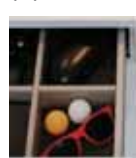

	Product code	Description
Pigeon Hole Unit		
(H) 380mm (W) 962mm (D) 350mm 	KD1312PH1000	Pigeon hole Unit for 1000mm double wardrobe in linen
	KD1308PH1000	Pigeon hole Unit for 1000mm double wardrobe in walnut effect
	KD1309PH1000	Pigeon hole Unit for 1000mm double wardrobe in oak effect
Organiser Grill - Designed to fit the Shallow Stackable Drawers		
(H) 50mm (W) 878mm (D) 437mm 	KD1312OG1000	1000mm wide, cut to size in linen only
Shoe Rack Conversion Kit		
(W) 964mm 	KD1312RK1000	Shoe Rack Conversion Kit in linen only (Can be cut down to suit smaller widths)
Corner Wardrobe Shelf Stack		
(H) 1489mm (W) 538mm 	KD1312SHCR1000	Additional shelves for 1000mm corner wardrobe in linen only
Edging Tape		
(H) 23mm (L) 5000mm (D) 0.5mm 	KD1312ET5000	Edging tape in linen
	KD1308ET5000	Edging tape in walnut effect
	KD1309ET5000	Edging tape in oak effect

	Product code	Description
Custom Fit End Panel		
(H) 2260mm (W) 750mm (D) 22mm 	KD1309CEP2260	Custom fit end panel in oak effect
	KD1308CEP2260	Custom fit end panel in walnut effect
Linen Panel to Modify Robe - Includes a strip of edging		
(H) 2400mm (W) 650mm (D) 19mm 	KD1312MEP2400	Linen panel to modify robe only
Felt Liner		
(H) 435mm (W) 875mm 	KD1314FL875	Felt drawer liner for use with stackable drawers (cut to size)
(H) 385mm (W) 915mm 	KD1314FL915	Felt drawer liner for use with modern chest (cut to size)



INTERNAL ACCESSORIES BUNDLES

All bundle pricing has been calculated on the assumption that the standard shelf (554mm depth) has been removed and replaced by the additional shelf (500mm depth). A filler pack will be included with every bundle - used to conceal the drawer runners (cutting required). If organiser grill or shoe conversion kit is required please order separately.

500/800/900MM BUNDLES

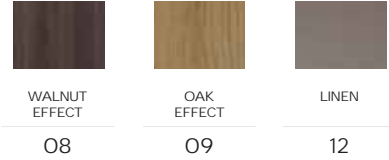

Bundles are created with individual internal components for ease of ordering to add to any wardrobe sale. Wardrobe cabinets are not included. Colour reference code for bundles shown at the top of the page.

	Product code	Description
Bundle 1		
	x1	Shallow Stackable Drawer
	x2	Deep Stackable Drawer
	x1	Additional Shelf Pack (x2 Shelves per Pack)
	KD13**IB1/500	500mm wide for single wardrobe
	KD13**IB1/800	800mm wide for double wardrobe
	KD13**IB1/900	900mm wide for double wardrobe
Bundle 2		
	x2	Shallow Stackable Drawer
	x2	Deep Stackable Drawer
	x1	Additional Shelf Pack (x2 Shelves per Pack)
	KD13**IB2/500	500mm wide for single wardrobe
	KD13**IB2/800	800mm wide for double wardrobe
	KD13**IB2/900	900mm wide for double wardrobe
Bundle 3		
	x1	Shallow Stackable Drawer
	x1	Deep Stackable Drawer
	x1	Additional Shelf Pack (x2 Shelves per Pack)
	KD13**IB3/500	500mm wide for single wardrobe
	KD13**IB3/800	800mm wide for double wardrobe
	KD13**IB3/900	900mm wide for double wardrobe
Bundle 4		
	x2	Deep Stackable Drawer
	x1	Additional Shelf Pack (x2 Shelves per Pack)
	KD13**IB4/500	500mm wide for single wardrobe
	KD13**IB4/800	800mm wide for double wardrobe
	KD13**IB4/900	900mm wide for double wardrobe
Bundle 5		
	x1	Deep Stackable Drawer
	x1	Additional Shelf Pack (x2 Shelves per Pack)
	KD13**IB5/500	500mm wide for single wardrobe
	KD13**IB5/800	800mm wide for double wardrobe
	KD13**IB5/900	900mm wide for double wardrobe

	Product code	Description
Bundle 6		
	x3	Additional Shelf Pack (x2 Shelves per Pack)
	KD13**IB6/500	500mm wide for single wardrobe
	KD13**IB6/800	800mm wide for double wardrobe
	KD13**IB6/900	900mm wide for double wardrobe
Bundle 7		
	x2	Shallow Stackable Drawers
	x1	Deep Stackable Drawer
	x1	Additional Shelf Pack (x2 Shelves per Pack)
	KD13**IB7/500	500mm wide for single wardrobe
	KD13**IB7/800	800mm wide for double wardrobe
	KD13**IB7/900	900mm wide for double wardrobe
Bundle 8		
	x2	Shallow Stackable Drawers
	x1	Additional Shelf Pack (x2 Shelves per Pack)
	KD13**IB8/500	500mm wide for single wardrobe
	KD13**IB8/800	800mm wide for double wardrobe
	KD13**IB8/900	900mm wide for double wardrobe
Bundle 9		
	x1	Additional Shelf Pack
	x1	Hanging Rail (x2 Shelves per Pack)
	KD13**IB9/500	500mm wide for single wardrobe
	KD13**IB9/800	800mm wide for double wardrobe
	KD13**IB9/900	900mm wide for double wardrobe
Bundle 10		
	x2	Additional Shelf Pack (x2 Shelves per Pack)
	KD13**IB10/500	500mm wide for single wardrobe
	KD13**IB10/800	800mm wide for double wardrobe
	KD13**IB10/900	900mm wide for double wardrobe



INTERNAL ACCESSORIES BUNDLES



PHOTOGRAPHY: BUNDLE 16 SHOWN IN OAK EFFECT.









All bundle pricing has been calculated on the assumption that the standard shelf (554mm depth) has been removed and replaced by the additional shelf (500mm depth). A filler pack will be included with every bundle. This is used to conceal the drawer runners (cutting required).









If the organiser grill or shoe conversion kit is required please order separately.

1000MM BUNDLES

Bundles are created with individual internal components for ease of ordering to add to any wardrobe sale. Wardrobe cabinets are not included. Colour reference code for bundles shown at the top of the page.

		
WALNUT EFFECT	OAK EFFECT	LINEN
08	09	12

	Product code	Description
Bundle 1		
		x1 Shallow Stackable Drawer x2 Deep Stackable Drawer x1 Additional Shelf Pack (x2 shelves per pack)
	KD13**IB1	1000mm wide for double wardrobe
Bundle 2		
		x2 Shallow Stackable Drawer x2 Deep Stackable Drawer x1 Additional Shelf Pack (x2 shelves per pack) <small>* please note the Linen option includes 1x linen panel to modify robe, not a custom fit panel.</small>
	KD13**IB2	1000mm wide for double wardrobe
Bundle 3		
		x1 Shallow Stackable Drawer x2 Deep Stackable Drawer x1 Additional Shelf Pack (x2 shelves per pack) x1 Pigeon Hole Unit
	KD13**IB3	1000mm wide for double wardrobe
Bundle 4		
		x1 Shallow Stackable Drawer x1 Deep Stackable Drawer x1 Additional Shelf Pack (x2 shelves per pack) x1 Pigeon Hole Unit
	KD13**IB4	1000mm wide for double wardrobe
Bundle 5		
		x2 Deep Stackable Drawer x1 Additional Shelf Pack (x2 shelves per pack)
	KD13**IB5	1000mm wide for double wardrobe
Bundle 6		
		x1 Shallow Stackable Drawer x1 Deep Stackable Drawer x1 Additional Shelf Pack (x2 shelves per pack) x1 Pigeon Hole Unit
	KD13**IB6	1000mm wide for double wardrobe
Bundle 7		
		x1 Deep Stackable Drawer x1 Additional Shelf Pack (x2 shelves per pack)
	KD13**IB7	1000mm wide for double wardrobe
Bundle 8		
		x2 Deep Stackable Drawer x1 Additional Shelf Pack (x2 shelves per pack) x1 Pigeon Hole Unit
	KD13**IB8	1000mm wide for double wardrobe

	Product code	Description
Bundle 9		
		x1 Shallow Stackable Drawer x2 Deep Stackable Drawer x2 Additional Shelf Pack (x2 shelves per pack) x1 Pigeon Hole Unit
	KD13**IB9	1000mm wide for double wardrobe
Bundle 10		
		x1 500mm wide Shallow Stackable Drawer x2 500mm Deep Stackable Drawer x1 Custom Fit End Panel x2 Additional Shelf Pack (x2 shelves per pack) - 500mm x1 Additional Shelf Pack (x2 shelves per pack) - 1000mm <small>* please note the Linen option includes 1x linen panel to modify robe, not a custom fit panel.</small>
	KD13**IB10	1000mm wide for double wardrobe
Bundle 11		
		x3 Additional Shelf Pack (x2 shelves per pack)
	KD13**IB11	1000mm wide for double wardrobe
Bundle 12		
		x1 Additional Shelf Pack (x2 shelves per pack) x1 Hanging Rail
	KD13**IB12	1000mm wide for double wardrobe
Bundle 13		
		x2 Shallow Stackable Drawer x1 Deep Stackable Drawer x1 Additional Shelf Pack (x2 shelves per pack)
	KD13**IB13	1000mm wide for double wardrobe
Bundle 14		
		x2 Shallow Stackable Drawer x1 Additional Shelf Pack (x2 shelves per pack)
	KD13**IB14	1000mm wide for double wardrobe
Bundle 15		
		x1 Additional Shelf Pack (x2 shelves per pack) x1 Hanging Rail
	KD13**IB15	1000mm wide for double wardrobe
Bundle 16		
		x2 Additional Shelf Pack (x2 shelves per pack)
	KD13**IB16	1000mm wide for double wardrobe



HANDLES

HANDLES

HANDLE FINISHES

Stainless Steel Effect	03
Chrome	05
Nickel	08
Pewter	10
Knurled	11
Industrial Matt Black	15
Black Satin Effect	16
Matt Black	17
White	18
Bright Copper	19
Aged Copper	19
Burnt Copper	19
Antique Bronze Effect	20
Brushed & Satin Brass	21
Aged Brass	22
Leather	24
Timber	25
Push Latch	26

KEY FEATURES

- Over 200 handles across 12 finishes
- Detailed product information for every handle including the code, weight, technical drawing and price band.
- All PWS handles include fixing screws as standard
- An enhanced presentation of our Knurled handle collection, showcasing the multitude of options.
- Some handles belong to a family to help you identify and plan effective handle design combinations.

STAINLESS STEEL EFFECT



Guildford
Cup Handle

- 1 BH1027.32.SS | 0.2kg | 32mm
- 2 BH1028.64.SS | 0.2kg | 64mm
- 2 BH1029.128.SS | 0.3kg | 128mm

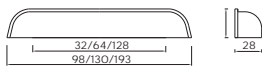

Portland
Cup Handle

- 1 B1003/79SS | 0.3kg | 64mm

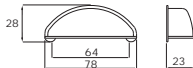

Portland
Knob Handle

- 1 BTK2SS | 0.1kg | 30mm

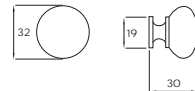

Wilton
Crystal Knob Handle

- 2 KDH3014 | 0.05kg | 40mm

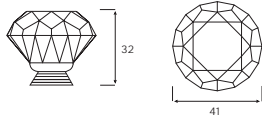

Arlington
T-Bar Handle

- 1 BH503.60.SS | 0.08kg | 60mm

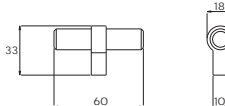

Arlington
Bar Handle

- 1 BH503.128.SS | 0.1kg | 128mm

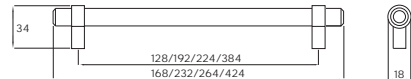

Dartmouth
T-Bar Handle

- 2 BH1123.60.SS | 0.08kg | 60mm



Dartmouth
Bar Handle

- 4 BH1128.160.SS | 0.18kg | 160mm

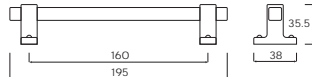

Clerkenwell
Trim Handle

- 2 BH1124.96.SS | 0.05kg | 96mm
- 2 BH1124.256.SS | 0.11kg | 256mm

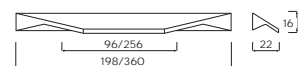



Marylebone
Teardrop Trim Handle
1 BH1087.32.SS | 0.14kg | 50mm
1 BH1087.160.SS | 0.06kg | 200mm

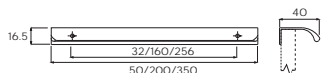

Marylebone
Block Handle
2 KDH3000 | 0.13kg | 96/128mm
2 KDH3001 | 0.18kg | 160/192mm

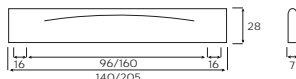

NEW



Dale
Knob Handle
1 BK557.35.SS | 0.49kg | 35mm

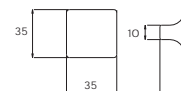

NEW



Law
Knob Handle
2 BK808.50.SS | 0.1kg | 50mm

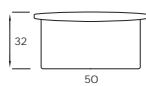

NEW



Strand
T-Bar Handle
1 BH1143.60.SS | 0.03kg | 60mm

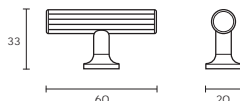

NEW



Strand
Bar Handle
3 BH1144.242.SS | 0.096kg | 192mm

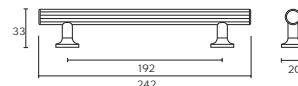

NEW



Didsbury
Knob Handle
1 BK1120.33.SS | 0.035kg | 33mm

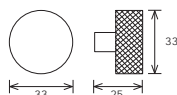

NEW



Didsbury
Knob
2 BK1120.33490SS | 42mm

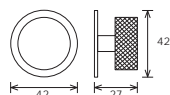

NEW



Didsbury
D-Handle
3 BH1140.192.SS | 0.95kg | 192mm

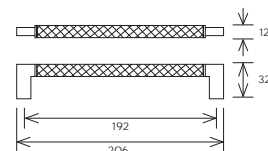

NEW



Didsbury
D-Handle
3 BH1140.192491SS | 192mm

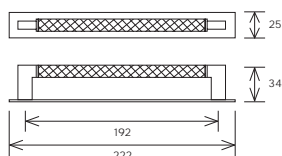

CHROME



Hoxton
Cup Handle
2 BH1108.96.CH | 0.08kg | 96mm



Barton
Cup Handle
1 BH1092.64.CH | 0.04kg | 64mm

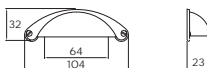

Weel
T-Bar Handle
1 BH1091.60.CH | 0.9kg | 60mm

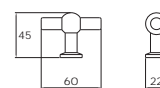

Collingwood
Cup Handle
5 BH1127.76.CH | 0.12kg | 76mm



Chatsworth
Knob Handle
4 BK877.35.CH | 0.2kg | 35mm



Yeadon
Square Knob Handle
with backplate
2 KDH3017 | 0.17kg | 38mm

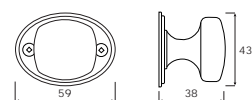

Yeadon
Round Knob Handle
with backplate
2 KDH3016 | 0.19kg | 35mm

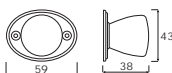

Wath
Knob Handle
1 KDH3018 | 0.08kg | 32mm



Wellington
Round Knob Handle
with backplate
5 BK1075.32.CH | 0.11kg | 32mm

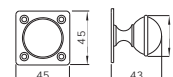



Sutton
Flat Handle
1 KDH3030 | 0.050kg | 32mm

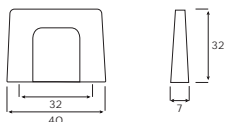

Hoxton
D Handle
2 BH1085.160.CH | 0.14kg | 160mm

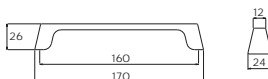

Darlington
D Handle
3 KDH3027 | 0.16kg | 160mm
3 KDH3028 | 2.10kg | 320mm

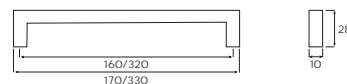

Linton
T-Bar Handle
2 BH1120.60.CH | 0.03kg | 60mm



Linton
Bar Handle
3 BH1120.160.CH | 0.1kg | 160mm
3 BH1120.256.CH | 0.11kg | 256mm

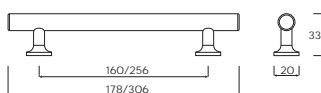

Fimber
D Handle
2 KDH3029 | 0.18kg | 160/224mm

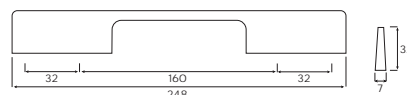

Bloomfield
Hexagonal T-Bar Handle
2 BH995.68.CH | 0.1kg | 68mm

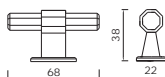

Bloomfield
Bar Handle
3 BH994.160.CH | 0.3kg | 160mm

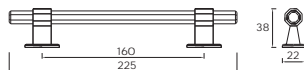

Kensington
D Handle
2 BH768.128.CH | 1.67kg | 96mm

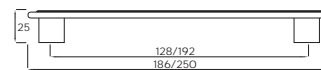

Kensington
D Handle
5 BH1044.128.CH | 0.17kg | 128mm

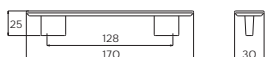

Kensington
Square Handle
4 BK1043.32.CH | 0.09kg | 32mm

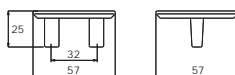

Crystal
Bow Handle
4 KDH3008 | 0.12kg | 160mm

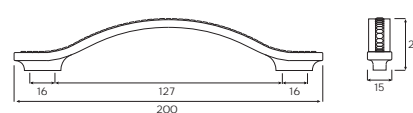

CHROME



Crystal
Small D Handle
2 KDH3009 | 0.05kg | 32mm

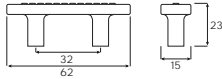

Crystal
D Handle
4 KDH3012 | 0.11kg | 192mm
4 KDH3013 | 0.75kg | 128mm

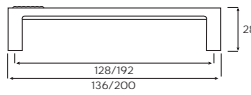

NEW



Barton
Knob Handle
1 BK265.33.CH | 0.07kg | 32mm



NEW



Kendall
Bow Handle
2 BH1141.160.CH | 0.084kg | 210mm
3 BH1141.288.CH | 0.139kg | 340mm
4 BH1141.448.CH | 0.216kg | 500mm

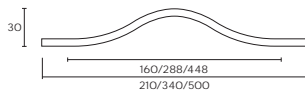

NEW



Bedford
Bar Handle
5 BH883.160.CH | 0.325kg | 232mm

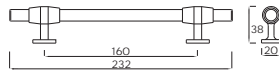

NICKEL



Belgrave
Cup Handle

1 B8/952.B.AN | 0.37kg | 64mm

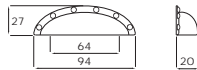

Belgrave
Knob Handle

1 BK1107.35.SN | 0.05kg | 35mm

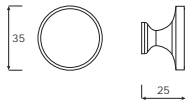

BEST
SELLER



Leeming
T-Bar Handle

1 KDH3011 | 0.1kg | 62mm

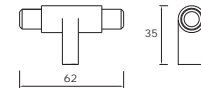

Satin & Nickel
Chelsea
Knob Handle

1 BK419.32.DN | 0.63kg | 32mm

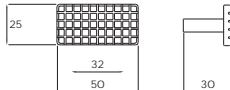

Chelsea
D Handle

2 BH420.128.DN | 1.07kg | 128mm



BEST
SELLER



Leeming
Bar Handle

2 KDH3010 | 0.27kg | 160mm

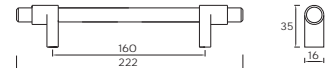

Bedford
T-Bar Handle

5 BH884.72.BN | 0.1kg | 72mm

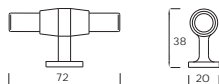

Bedford
Bar Handle

5 BH882.160.BN | 0.3kg | 160mm

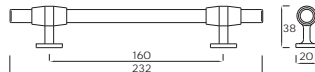

NEW



Harton
Knob Handle

2 BK1118.31.BN | 0.053kg | 31mm



NICKEL

NEW



Strand
T-Bar Handle
2 BH1143.60.BN | 0.03kg | 60mm

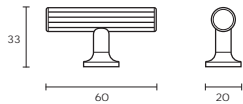

NEW



Strand
Bar Handle
3 BH1144.242.BN | 0.096kg | 242mm

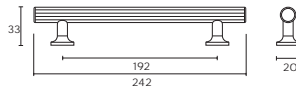

NEW



Taxal
Knob Handle
2 BK686.32.SN | 0.089kg | 57mm

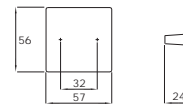

NEW



Chatsworth
Knob Handle
5 BK876.35.BN | 0.195kg | 35mm



PEWTER



Cromwell
Cup Handle

3 BH1111.64.PE | 0.07kg | 64mm

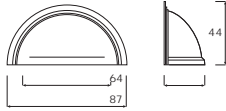

Chatsworth
Knob Handle

3 BK1109.35.PE | 0.08kg | 35mm

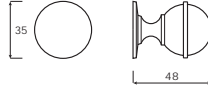

Aztec
Knob Handle

1 KDH3042 | 0.06kg | 41mm

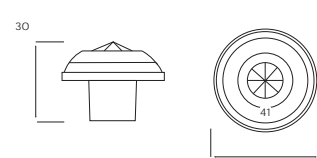

Berwick
Knob Handle with backplate

3 KDH3023 | 0.06kg | 30mm

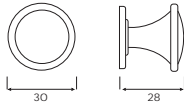

Berwick
Knob Handle

2 KDH3022 | 0.50kg | 30mm

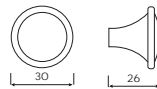

Berwick
Bar Handle

4 KDH3024 | 0.2kg | 96mm

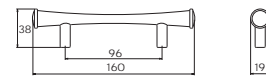

BEST
SELLER



Hampshire
Knob Handle

3 KDH3025 | 0.08kg | 31mm

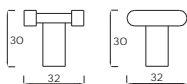

Hampshire
Bow Handle

4 KDH3026 | 0.16kg | 128mm

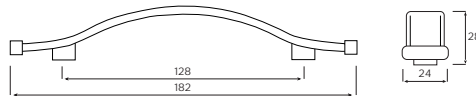

NEW



Eydon
Knob Handle

3 BK489.47.PE | 0.088kg | 47mm

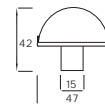

NEW



Welton
Knob Handle

3 BK484.44.PE | 0.076kg | 44mm



NEW



Stivichall
Knob Handle

1 BK265.33.PE | 0.07kg | 33mm



NEW



Finham
Knob Handle

2 BK719.46.PE | 0.168kg | 46mm

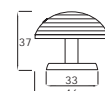

KNURLED

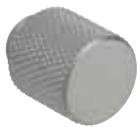

Knob Handle
1 BK1111.20.SS | 0.02kg | 20mm

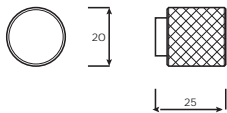

Knob Handle
1 BK1111.20.AGB | 0.02kg | 20mm

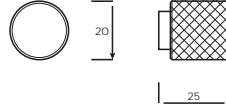

Knob Handle
1 BK1111.20.MB | 0.02kg | 20mm

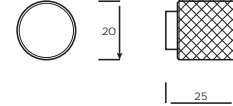

Knob Handle
2 BK1111.20B383SS | 40mm with circular backplate

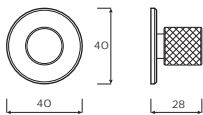

Knob Handle
2 BK1111.20B383AGB | 40mm with circular backplate

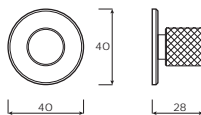

Knob Handle
2 BK1111.20B383MB | 40mm with circular backplate

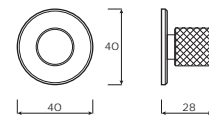

Knob Handle with backplate
2 BK1111.20B384SS | 0.04kg | 20mm

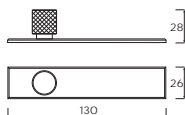

Knob Handle with backplate
2 BK1111.20B384AGB | 0.04kg | 20mm

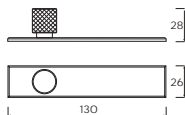

Knob Handle with backplate
2 BK1111.20B384MB | 0.04kg | 20mm

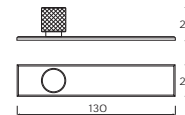



T-Bar Handle
 2 BH1125.35.SS | 0.03kg | 96mm

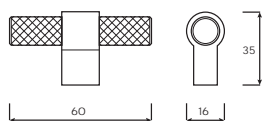

Knob T-Bar Handle
 2 BH1125.35.AGB | 0.03kg | 96mm

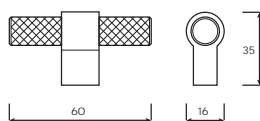

Knob T-Bar Handle
 2 BH1125.35.MB | 0.03kg | 96mm

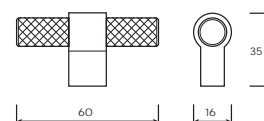

NEW



T-Bar Handle with backplate
 3 BH1125.35B383SS | 60mm

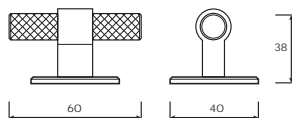

NEW



T-Bar Handle with backplate
 3 BH1125.35B383AGB | 60mm

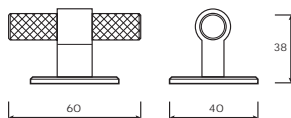

NEW



T-Bar Handle with backplate
 3 BH1125.35B383MB | 60mm

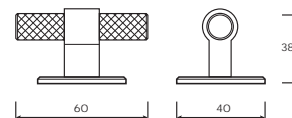

T-Bar Handle with backplate
 3 BH1125.35B385SS | 0.04kg | 40x26mm

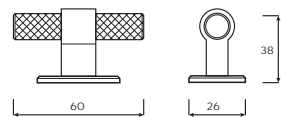

T-Bar Handle with backplate
 3 BH1125.35B385AGB | 0.04kg | 40x26mm

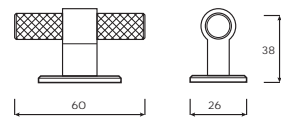

T-Bar Handle with backplate
 3 BH1125.35B385MB | 0.04kg | 40x26mm

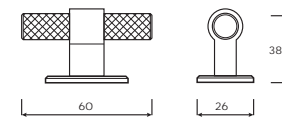

KNURLED

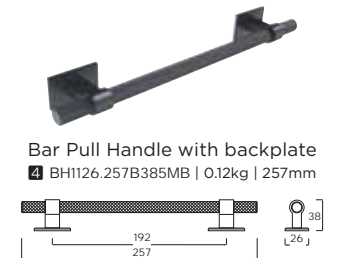
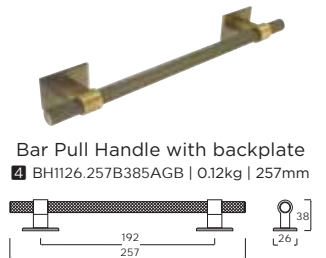
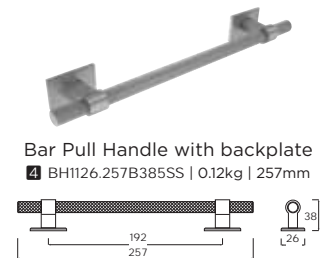
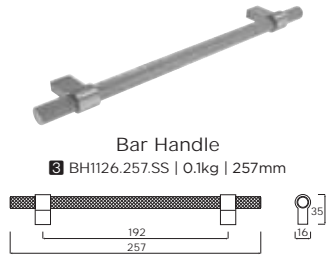



Bar Handle

5 BH1126.448.SS | 0.2kg | 448mm

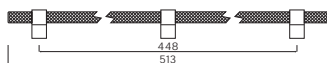

Bar Handle

5 BH1126.448.AGB | 0.2kg | 448mm

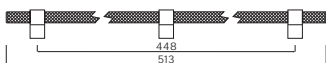

Bar Handle

5 BH1126.448.MB | 0.2kg | 448mm

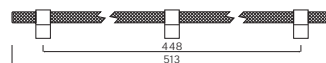

NEW



Bar Handle with backplate

5 B1126.448B383SS | 513mm

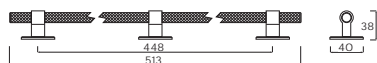

NEW



Bar Handle with backplate

5 B1126.448B383AGB | 513mm

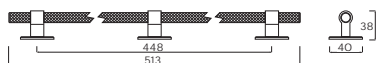

NEW



Bar Handle with backplate

5 B1126.448B383MB | 513mm

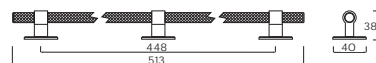

Bar Handle with backplate

5 B1126.448B385SS | 0.23kg | 448mm

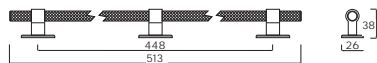

Bar Handle with backplate

5 B1126.448B385AGB | 0.23kg | 448mm

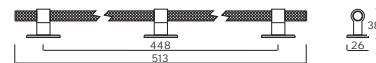

Bar Handle with backplate

5 B1126.448B385MB | 0.23kg | 448mm

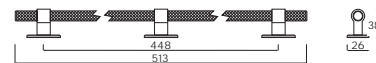

INDUSTRIAL MATT BLACK



Claremont
Cup Handle

1 BH1105.64.MB | 0.4kg | 64mm

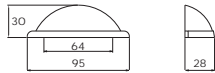

Claremont
Knob Handle

1 KDH3044 | 0.06kg | 32mm

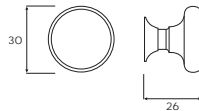

Claremont
D Handle

2 BH1103.160.MB | 0.05kg | 160mm

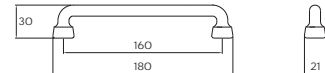

Hoxton
D Handle

2 KDH3046 | 0.12kg | 160mm

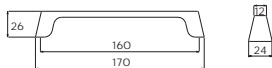

Bromley
Square Knob Handle

1 BK1112.35.MB | 0.04kg | 257mm

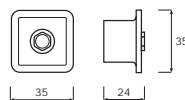

Bromley
D Handle

2 BH1129.225.MB | 0.13kg | 160mm

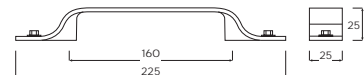

Hove
D Handle

2 BH1130.160.MB | 0.13kg | 160mm
2 BH1130.320.MB | 0.19kg | 320mm

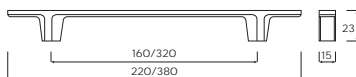

BLACK SATIN EFFECT

BEST SELLER



Yeadon
Round Knob Handle with backplate
2 KDH3015 | 0.2kg | 35mm

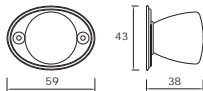

BEST SELLER



Bloomfield
Hexagonal T-Bar Handle
1 KDH3020 | 0.12kg | 68mm

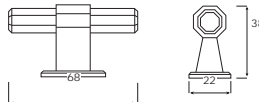

BEST SELLER



Bloomfield
Hexagonal Bar Handle
3 KDH3019 | 0.35kg | 160mm

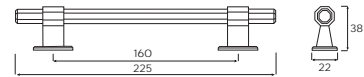

Askern
Geometric D Handle
2 KDH3004 | 0.13kg | 160mm
3 KDH3005 | 0.18kg | 320mm

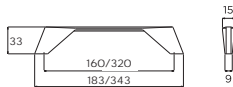

Marylebone
Trim Handle
1 BH1087.32.BS | 0.14kg | 50mm
1 BH1087.160.BS | 0.06kg | 200mm
1 BH1087.256.BS | 0.11kg | 350mm

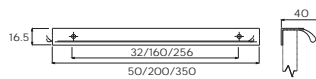

NEW



Weel
T-Bar Handle
2 BH1091.60.BS | 0.086kg | 60mm

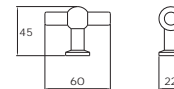

NEW



Arlington
Bar Handle
2 BH503.128.BS | 0.22kg | 168mm
2 BH504.192.BS | 0.3kg | 232mm

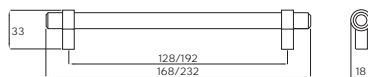

Barton
Knob Handle
1 BK1110.33.BS | 0.07kg | 33mm



Barton
Cup Handle
1 BH1092.64.BS | 0.04kg | 64mm

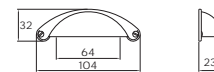

Yeadon
Square Knob Handle with backplate
2 KDH3040 | 0.6kg | 38mm



MATT BLACK

NEW



Lloyd
D-Handle

2 BH1156.160.MB | 0.12kg | 175mm

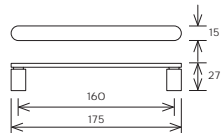

NEW



Lloyd
Knob Handle

1 BK1124.25.MB | 0.026kg | 25mm

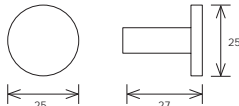

NEW



Yard
Knob Handle

1 BK1123.33.MB | 0.035kg | 33mm

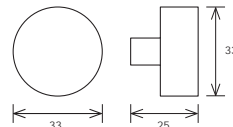

Yard
Pull Handle

1 BH1138.160.MB | 0.07kg | 160mm

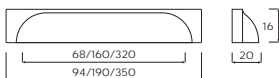

NEW



Yard
D-Handle

1 BH1137.160.MB | 0.082kg | 168mm
2 BH1137.224.MB | 0.112kg | 264mm

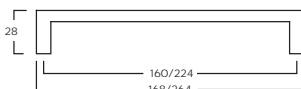

Didsbury
D Handle

2 BH1140.192.MB | 0.95kg | 192mm

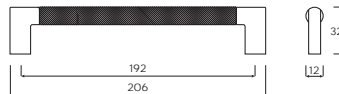

NEW



Didsbury
Knob Handle

2 BK1120.33490MB | 42mm

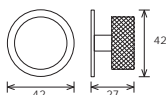

NEW



Didsbury
Knob Handle

1 BK1120.33.MB | 0.035kg | 33mm

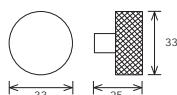

NEW



Didsbury
D-Handle

3 BH1140.192491MB | 222mm

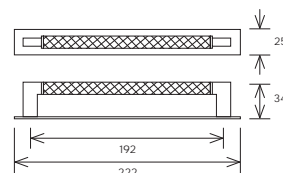

WHITE



Yard
Cup Handle

- 1 BH1138.64.MW | 0.04kg | 64mm
- 2 BH1138.160.MW | 0.07kg | 160mm
- 3 BH1138.320.MW | 0.14kg | 320mm

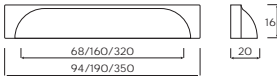

Hove
Slimline D Handle

- 2 BH1130.160.MW | 0.13kg | 160mm
- 2 BH1130.320.MW | 0.19kg | 320mm

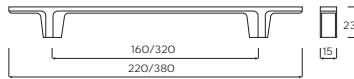

Yard
Slimline Bar handle

- 1 BH1137.160.MW | 0.08kg | 160mm
- 2 BH1137.224.MW | 0.11kg | 224mm

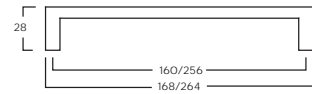

Rainton
Slimline D handle

- 2 BH1139.160.MW | 0.12kg | 160mm
- 2 BH1139.320.MW | 0.18kg | 320mm

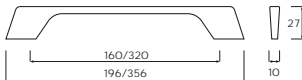

Soho
Slimline D handle

- 2 H1131.90.MW | 0.03kg | 90mm
- 3 H1131.250.MW | 0.09kg | 250mm

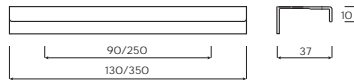

BRIGHT COPPER

NEW



Yard
D-Handle
1 BH1137.160.CO | 0.082kg | 168mm
2 BH1137.224.CO | 0.112kg | 264mm

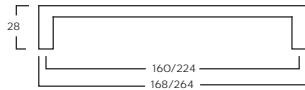

NEW



Yard
Knob Handle
1 BK1123.33.CO | 0.035kg | 33mm

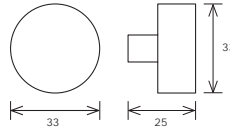

AGED COPPER



Eldon
Bar Handle
2 KDH3006 | 0.22kg | 188mm
2 KDH3007 | 0.37kg | 387mm

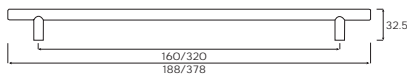

BURNT COPPER

NEW



Dale
Knob Handle
1 BK557.35.BC | 0.049kg | 35mm

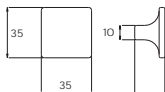

NEW



Ripon
Bow Handle
2 BH1086.160.BC | 0.097kg | 191mm

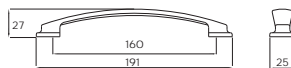

ANTIQUE BRONZE EFFECT



Claremont
Cup Handle

1 KDH3043 | 0.08kg | 64mm

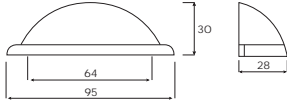

Claremont
Knob Handle

1 BK1106.30.BR | 0.05kg | 32mm



Claremont
D Handle

2 BH1103.160.BR | 0.13kg | 160mm

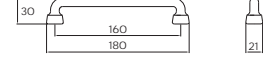

Wellington
Knob Handle

5 BK1075.32.BR | 0.11kg | 32mm

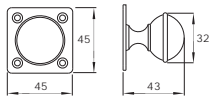

Bishop
Bar Handle

2 KDH3047 | 2kg | 160mm

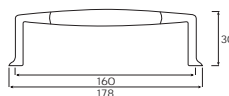

NEW



Weel
T-Bar Handle

2 BH1091.60.BR | 0.086kg | 60mm

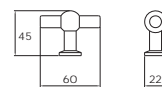

NEW



Didsbury
Knob Handle

1 BK1120.33.BR | 0.035kg | 33mm

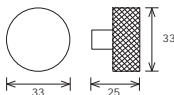

NEW



Didsbury
Knob Handle

2 BK1120.33490BR | 42mm

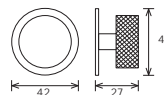

NEW



Didsbury
D-Handle

3 BH1140.192491BR | 222mm

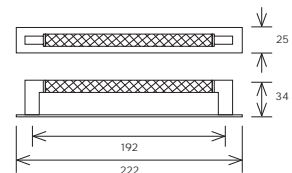

Didsbury
Knurled Handle

3 BH1140.192.BR | 0.95kg | 192mm

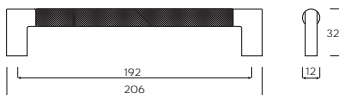

BRUSHED & SATIN BRASS

NEW



Lloyd
Knob Handle

1 BK1124.25.BHB | 0.026kg | 25mm

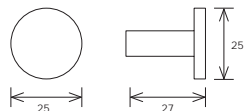

NEW



Lloyd
D-Handle

2 BH1156.160.BHB | 0.12kg | 175mm

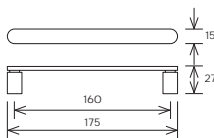

Hessay
Bar handle

2 BH1133.160.BHB | 0.12kg | 160mm
3 BH1133.320.BHB | 0.19kg | 320mm

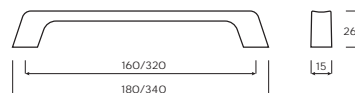

AGED BRASS

NEW



Harton
Knob Handle

2 BK1118.31.AGB | 0.053kg | 31mm



NEW



Strand
T-Bar Handle

2 BH1143.60.AGB | 0.03kg | 60mm

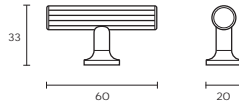

NEW



Strand
Bar Handle

3 BH1144.242.AGB | 0.096kg | 242mm

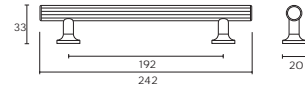

NEW



Didsbury
Knob Handle

2 BK1120.33490AGB | 42mm

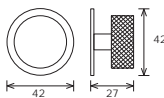

NEW



Didsbury
D-Handle

3 B1140.192491AGB | 222mm

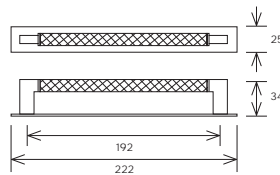

Stivichall
Knob Handle

1 BK266.33.AB | 0.7kg | 33mm

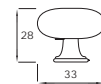

NEW



Didsbury
Knob Handle

1 BK1120.33.AGB | 0.035kg | 33mm

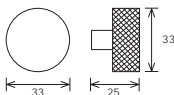

NEW



Didsbury
D-Handle

3 BH1140.192.AGB | 0.096kg | 206mm

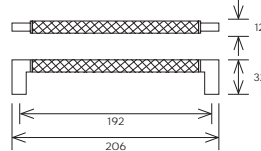

NEW



Barton
Knob Handle

1 BK1110.33.AGB | 0.07kg | 33mm

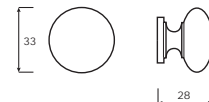

NEW



Yard
Knob Handle

1 BK1123.33.AGB | 0.035kg | 33mm

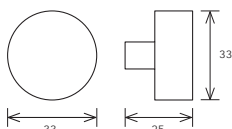

Yard
Bar handle

1 BH1137.160.AGB | 0.08kg | 160mm
2 BH1137.224.AGB | 0.1kg | 224mm

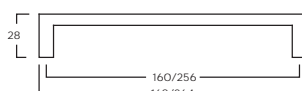

Yard
Cup Trim Handle

1 BH1138.64.AGB | 0.04kg | 64mm
2 BH1138.160.AGB | 0.07kg | 160mm
3 BH1138.320.AGB | 0.14kg | 320mm

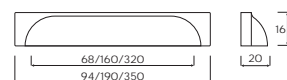

AGED BRASS



Dartmouth
D Handle

4 BH1128.160.AGB | 0.18kg | 160mm

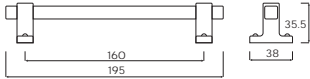

Dartmouth
T-Bar Handle

2 BH1123.60.AGB | 0.08kg | 60mm

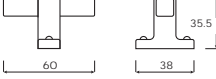

LEATHER

NEW



*Brown leather
Jeaker
Loop Handle*

2 BH1149.80.BWNLE | 0.01kg | 80mm

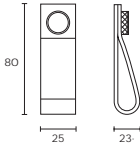

NEW



*Black leather
Jeaker
Loop Handle*

2 BH1149.80.BKLE | 0.01kg | 80mm

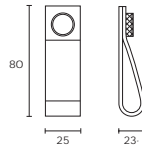

NEW



*Brown leather
Jeaker
Bow Handle*

3 BH1150.160.BWNLE | 0.016kg | 200mm

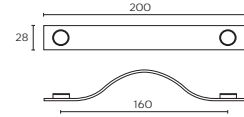

NEW



*Black leather
Jeaker
Bow Handle*

3 BH1150.160.BKLE | 0.016kg | 200mm

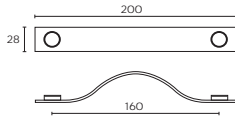

TIMBER



Knob Handle
1 KDH3021 | 0.04kg | 55mm

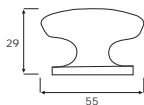

NEW



Archer
Knob Handle | Sanded Oak
1 BS87/44X10 | 0.022kg | 44mm

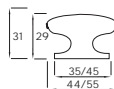

NEW



Howlett
Knob Handle | Walnut finish
2 BK967.50.WA | 0.015kg | 50mm

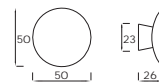

NEW



Taylor
Bow Handle | Oak
3 BH954.192.OA | 0.05kg | 265mm

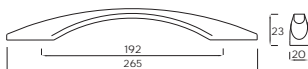

NEW



Spencer
Knob Handle | Oak
1 BS87/44BL | 0.024kg | 44mm
1 BS87/55BL | 0.035kg | 55mm

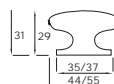

NEW



Spencer
Knob Handle | Light Oak
1 BS87/44X71 | 0.024kg | 44mm



NEW



Spencer
Knob Handle | Oak stained and lacquered
1 BS87/44X20 | 0.024kg | 44mm



NEW



Archer
Knob Handle | Oak
1 BS87/44CR | 0.024kg | 44mm
1 BS87/55CR | 0.035kg | 55mm
2 BS87/70CR | 0.062kg | 70mm

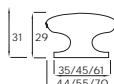

PUSH LATCH



BEST
SELLER



Hidden

Push latch mechanism
for handleless frontals

1 KDH3039 | 0.035kg | 124mm

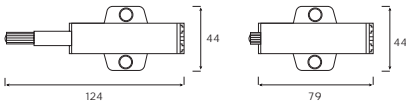









LIGHTING & ELECTRICAL
ACCESSORIES

LIGHTING & ELECTRICAL ACCESSORIES

Cabinet Lighting - Mains Powered	03
Cabinet Lighting - Rechargeable	04
Plinth Lighting	05
Flexible Strip Lighting	06
Drivers	07
Sensors	09
Evoline	10

KEY TO ICONS USED

 <p>Cool/ Natural/ Warm LED Colour</p> <p>The colour temperature of the LED lighting product.</p>	 <p>Dimmer</p> <p>This product can be dimmed.</p>	 <p>110°</p> <p>The beam angle of the product.</p>	 <p>1.5 metres</p> <p>The cable length that comes with the product.</p>	 <p>2 per m</p> <p>Quantity of LED lights per metre</p>	 <p>R</p> <p>Bedroom light can be fitted after installation.</p>
--	--	---	--	--	---

For more information on all Sensio products visit: www.sensio.co.uk



sensio[®]
furniture lighting solutions



ON ALL SENSIO
LED LIGHTING

CABINET LIGHTING

Mains powered lighting

ARK

LED Under Cabinet Light



- An elongated design offers a vast spread of light
- Fully diffused lens - no visible dots
- Removable front bezel provides simple installation, hidden fixings and a sleek finish
- High number of LEDs for bright light output
- Easy installation using daisy chaining to fit multiple lights into one area
- Stainless steel finish
- Dimmable

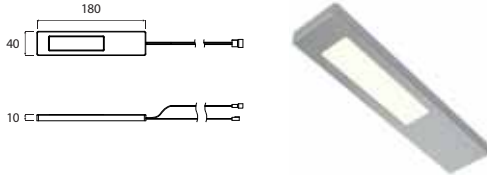

	Code	Wattage	Voltage	Qty	Driver	LED Colour
SINGLE	BSE11192CO	2.5W	24V	1	● Required	Cool White
SINGLE	BSE11192WO	2.5W	24V	1	● Required	Warm White

ACCESSORIES	
Code	Description
SE9009	HD LED Link Cable

PINTO

LED Flat Disc Light



- Discreet fitting, only 6mm deep
- 16 integrated LEDs
- Each fitting runs at only 1.5W so 4 fittings can be run from a single 6W driver
- Simple to install, surface mount using 2 screws

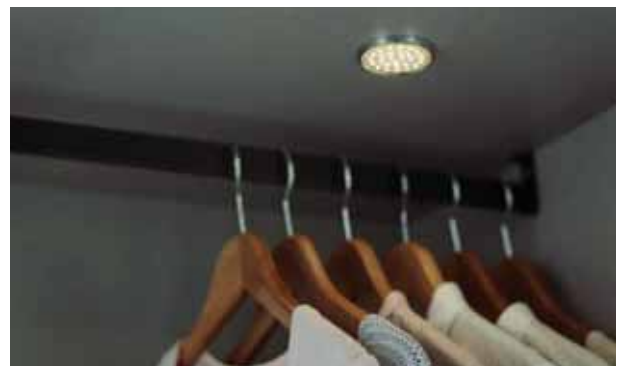
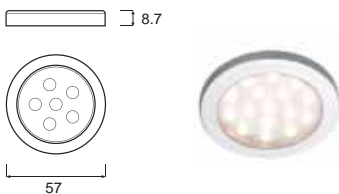

	Code	Wattage	Voltage	Qty	Driver	LED Colour
PACK	BSE10138WWK3.24	4.5W	24V	3	6W included	Warm White
SINGLE	BSE10138WW.24	1.5W	24V	1	● Required	Warm White

CABLES, CONNECTORS & ACCESSORIES REQUIRED	
Code	Description
BSE9009	HD LED Link Cable - 2.5m - Extends the cable on fitting This extension cable can be used with all products which are run via a green driver

See page 4.07 for Drivers

CABINET LIGHTING

Rechargeable lighting

MAGNUM

Rechargeable Battery Light



- Quick and simple to install. No wiring required
- Magnet mounted with a mini USB port to make charging as simple as possible
- Diffuser conceals all visible LED points
- Very versatile light suitable for installation in a variety of locations
- PIR motion sensor switch to control light
- Stainless Steel or Chrome
- Supplied with USB charging lead

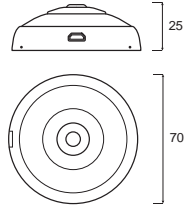

	Finish	Code	Wattage	Voltage	Qty	LED Colour
SINGLE	Chrome	BSE330INO	0.4W	5V	1	Cool White
SINGLE	Stainless Steel	BSE330ONO	0.4W	5V	1	Cool White

PLINTH LIGHTING

Mains powered lighting

SPECTO LED Round Plinth Light



- Fitting can be daisy chained together
- 2 x 75cm cable per fitting for daisy chain connection

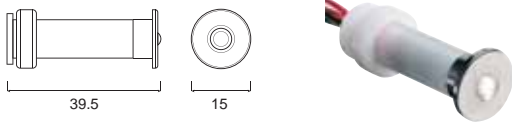

	Code	Wattage	Qty	Driver	LED Colour
PACK	BSE15091C4	1.28W	4	6W included	Cool White
PACK	BSE15091W4	1.28W	4	6W included	Warm White

LUCE SLS LED Square Plinth Light



- No visible LED points
- Light sits flush to plinth
- Fittings can be daisy chained together
- Super thin, Stainless steel square plinth lights

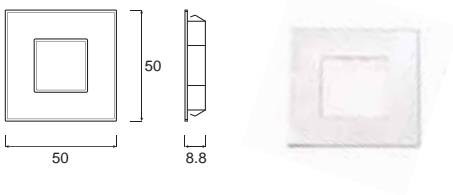

	Code	Wattage	Voltage	Qty	Driver	LED Colour
PACK	BSE15090C4	2.4W	24V	4	6W included	Cool White
PACK	BSE15090W4	2.4W	24V	4	6W included	Warm White

FLEXIBLE STRIP LIGHTING

PRIMO 2 5M Clip LED Flexible Strip





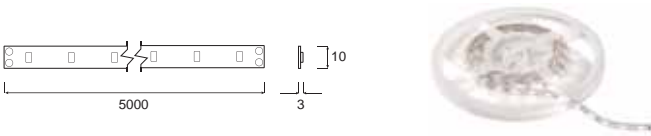

- Can be cut and re-used up to 50 times
- Illuminate several areas of a room with one strip
- Self-adhesive 3M tape on the back of the fitting for installation
- Supplied as a 5m reel
- Can be cut to length (every 100mm)
- Suitable for multiple areas-including plinth, over/under cabinet



	Code	Wattage	Voltage	Qty	Length	Driver	Led Colour
SINGLE	KDL4008	18W	24V	1	5m	● Required	Warm White

ADDITIONAL PRODUCTS FOR LED FLEXIBLE STRIP LIGHTING

Code	Description
 KDL4009	Primo end cap, interconnecting clip (Connects the two flexible strips together)
 KDL4010	Primo 50mm corner connector (Use between two flexible strips when running around a corner)
 KDL4011	Primo 2.5m driver connection cable (Connects the strip to the driver)
 SE9009	HD LED Link Cable - 2.5m - Extends the cable on fitting This extension cable can be used with all products which are run via a green driver

See page 4.07 for Drivers

DRIVERS

HOW TO CALCULATE YOUR DRIVERS

In order to power Sensio light fittings the following drivers are required. Each driver's main cable length is 1.5m. It is important to note that our drivers have a limited number of ports to connect your lights to. For example a driver with 6 ports is limited to a maximum of 6 lights.

Each driver can run a number of lights. Simply divide the wattage of the driver by the wattage of a single light and this will tell you exactly how many lights can be run by the driver.

Example: 15W driver with 3W lights, 15 / 3 = 5 lights



TITAN 6W/24V Low Profile Driver

Code	Power	Description
BSE490950	6W	Driver with 4 ports



TITAN 15W/24V Low Profile Driver

Code	Power	Description
BSE491950	15W	Driver with 6 ports



TITAN 30W/24V Low Profile Driver

Code	Power	Description
BSE492950	30W	Driver with 6 ports



DIMMABLE 24V/60W DRIVER

Compatible with Leading/Trailing Edge Dimmers

Sensio mains dimmable constant voltage driver can supply up to 60W of Sensio LED fittings.

The driver is compatible with the majority of trailing/leading edge dimmers and can be wired in the normal configuration with the dimmer switch in the live feed to the driver.

The device is class 2 and accordingly does not need an earth connection. It is suitable for indoor use only and feature a 230V input for UK or European use.

- Energy Efficient (High Powder Factor >0.95)
- Suitable for the supply of up to 60W Sensio LED fitting
- Fully isolated
- Dimmable range 5% to 100%

Code	Description
BSE40699	Dimmable 24V/60W Driver



HD LED LINK CABLE

2.5m

- HD LED Link Cable - 2.5m - Extends the cable on fitting
- This extension cable can be used with all products which are run via a green driver

Code	Description
BSE9009	HD LED Link Cable



SENSORS

250W MOTION SENSOR SWITCH

WATTAGE: 250W
USE WITH: 12V, 24V OR 240V PRODUCTS
CUT-OUT: 20mm
CABLE LENGTH: 1.5M
DETECTION RANGE: 0.5M-2.5M

This can be mounted inside a cabinet unit and will detect once the door is opened and will switch the light fitting on.

Code	Description
BSE40515	250W motion sensor switch



CABINET SENSOR SWITCH

WATTAGE: 250W
USE WITH: 12V, 24V or 240V products
CUT-OUT: 13m
CABLE LENGTH: 2m
DETECTION RANGE: 5-10cm

Recess into the front of an interior shelf inside the cabinet. On opening the door the connected internal lights will switch on, when the door is closed the lights will switch off.

Code	Wattage	Qty	Driver
BSE40518	250W*	1	Required

* Maximum



WARNING:

All light fittings must be fitted by a qualified electrician. Care must be taken where lights are enclosed in a cabinet, ensuring there is adequate ventilation. Light fittings should not be fitted in the vicinity of flammable surfaces.

BACKFLIP

The Evoline BackFlip sits nearly flush on a worksurface. At a touch of a finger, it turns 180 degrees to reveal two power sockets and a USB charger. With a total installation height of just 53mm, the BackFlip can be fitted above most drawers. Perfect to use on custom desks.



*European socket is shown for display purposes only. This product will come with a UK socket.

AVAILABLE FINISHES



Black Glass (Gloss)
Product Code: BBF2BK



Stainless Steel
Product Code: BBF2SS



White Glass (Gloss)
Product Code: BBF2WH

A modern, well-organized walk-in closet. The closet features glass-fronted cabinets with dark wood frames. Inside, there are wooden shelves holding folded clothes, handbags, and perfume bottles. Several coats, including a leopard print one, are hanging on hangers. The floor is made of light-colored wood, and a tufted ottoman is visible in the foreground.

CABINETS & COMPONENTS

CABINETS & COMPONENTS

5

CABINETS	03
COMPONENTS	05
Hinges	06
Door buffers and pads	09
Adjustable legs and fixings	10
Plinth clips	11
Table & worktop support legs	12
Decorative legs	13
Wall cabinet hangers	14
Wall fixings	15
Aventos lift mechanism	16
Fittings	17
Connector block	18
Shelf supports	19

If purchasing a complete product all hardware comes as standard.



PHOTOGRAPHY: PIGEON HOLE IN WALNUT EFFECT.

Available in Linen, our wardrobes are available in various single and double widths. You can combine these wardrobes with doors from our other ranges and storage solutions from our internal accessories section.

KEY FEATURES

- Can be built vertically or horizontally
- Supplied in three packs with all fixings and assembly instructions
- Comes with Internal Shelf and Satin Brown hanging rail
- Pre-drilled for storage combinations from our Internal accessories collection
- Pre-drilled for hinges
- 4x height adjustable feet
- Removable base for feet adjustment

5.03 Your one-stop-shop: www.pws.co.uk/bedrooms

CABINETS / WALK-IN WARDROBES

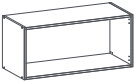

LINEN

	Width	Product code	Description
Single Open Feature (Cabinet Only) 	400	KDFS400	450(H)x400(W)x430mm(D)
	450	KDFS450	450(H)x450(W)x430mm(D)
	500	KDFS500	450(H)x500(W)x430mm(D)
Double Open Feature 	1000	KDFS1000	450(H)x1000(W)x430mm(D)

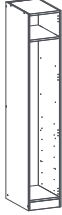
	Width	Product code	Description
Single Robe (Cabinet Only) 	400	KDROBE400	2260(H)x400(W)x590mm(D)
	450	KDROBE450	2260(H)x450(W)x590mm(D)
	500	KDROBE500	2260(H)x500(W)x590mm(D)

	Width	Product code	Description
Double Robe (Cabinet Only) 	800	KDROBE800	2260(H)x800(W)x590mm(D)
	900	KDROBE900	2260(H)x900(W)x590mm(D)
	1000	KDROBE1000	2260(H)x1000(W)x590mm(D)

	Quantity	Product code	Description
Linen Stickers 	9	ZZKDVA0480	9mm linen cover stickers (shelf drawer runner holes) - Approx 60 per sheet
	14	ZZKDVA0481	14mm linen cover stickers (used on cam holes) - Approx 20 per sheet

CORNER BLANKING PANEL

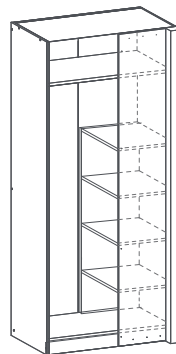

KD1312CC2260

Corner conversion kit with blanking panel 2260x430x18mm (linen only)

Please order corner post for a corner robe separately. This can be found in the door section of each range.

(Showing corner wardrobe shelf pack - sold separately. See page 2.16)

- You can use either an 800mm 900mm or 1000mm open wardrobe in a corner.
- We recommend you ensure at least a 500mm opening

WARDROBE FINISH	COMPLEMENTARY BOARD MATCHES
Linen Grey	Egger F426 Grey Linen
Linen Beige	Egger F425 Beige Linen

CABINETS & COMPONENTS

COMPONENTS



HINGES

Pre-drilled component doors require a BLUM EXPANDO hinge. See our range of hinges below.

FEATURE STORAGE UNIT HINGE PACK

*Comes with mounting plate (See last product on this page).



- Clip-Top BLUMOTION - Blum soft close hinges
- Supplied in a pack of 2
- Includes hinges and back plates
- Includes cover cap
- 0.230kg

Order code	Description
KDC1020	Feature storage unit hinge pack, 2 x hinges and back plates

WARDROBE DOOR HINGE PACK

*Comes with mounting plate (See last product on this page).



- Clip-Top BLUMOTION - Blum soft close hinges
- Supplied in a pack of 4
- Includes hinges and back plates
- Includes cover cap
- 0.870kg

Order code	Description
KDC1013	Wardrobe door hinge pack, 4 x hinges and back plates

CORNER HINGE PACK

*Comes with mounting plate (See last product on this page).



- Clip-Top BLUMOTION- Blum 180 degree Soft Close hinges
- Supplied in a pack of 4
- Includes hinges and back plates
- Includes cover cap
- 0.870kg

Order code	Description
KDC1014	Corner hinge pack (180 degree), 4 x hinges and back plates

PERSONALISED COVER CAP



Printed with your logo for use with BLUM Clip, Clip-Top and Clip-Top BLUMOTION hinges

- Available in Nickel with standard printing colour black
- Contact your Area Sales Manager or Customer Service Representative today to order your unique cover cap
- MOQ 1000
- 12-15 weeks lead time

*price available on request

BLUM CLIP MOUNTING PLATE - 2 PART PRESSED CRUCIFORM

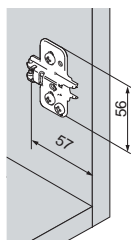
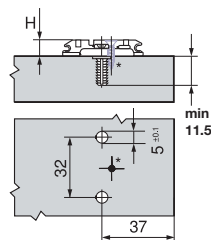

- +/- 2mm height adjustment
- Pre-mounted screws with split dowels included
- Drilling template available
- Fix with additional screw if used with wide angle hinges

HINGES

BLUM CLIP MOUNTING PLATE - 2 PART PRESSED CRUCIFORM

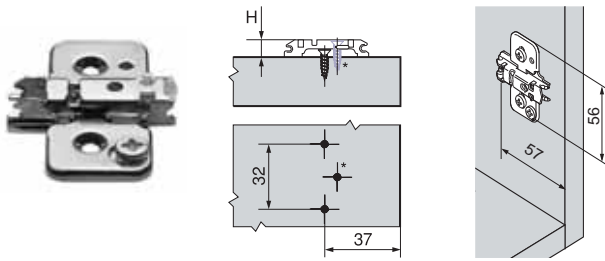

- +/- 2mm height adjustment
- Fix with chipboard screws γ 3.5 or 4mm (recommended screw length 15mm)
- Drilling template available
- Fix with additional screw if used with wide angle hinges

Order code	Spacing	Finish	Height
B173H7100	0mm	Nickel plated	8.5mm

BLUM CLIP-TOP 110° HINGE

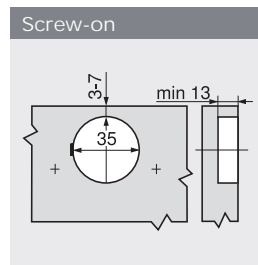
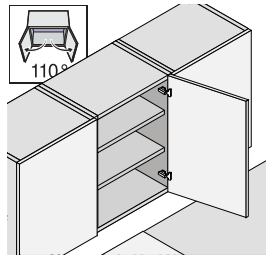

- All-metal hinge, nickel plated
- 110° opening angle
- Convenient spiral-tech depth adjustment
- With closing mechanism (spring)
- Tool-free door to cabinet assembly and removal



PRODUCT KEY



1 Screw-on boss



2 Arm cover cap



3 BLUMOTION

Order code

B71T3550
B70.1503
B973A0500.01

Product

1 Screw-on boss - sprung
2 Arm cover cap
3 BLUMOTION

170° STRAIGHT ARM CLIP TOP HINGE WITH SCREW ON BOSS

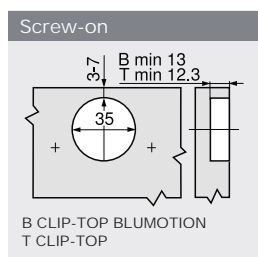
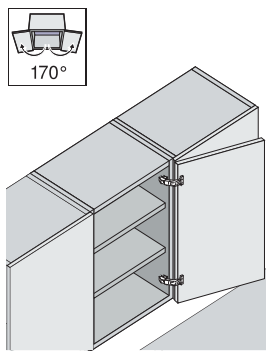

- All-metal hinge, nickel plated
- 170° opening angle
- Convenient spiral-tech depth adjustment
- With or without closing mechanism (spring)
- Tool-free door to cabinet assembly and removal



Screw-on boss - sprung



Safety information

If young children have access to furniture, with wide angle hinges, then the 155° opening O-protrusion hinges should be used.

Order code	Description
B71T6550	170 degree straight arm CLIP Top hinge with screw on boss

HINGES & DRAWER RUNNERS

BLUMOTION SOFT CLOSE MECHANISM FOR ATTACHMENT TO 170° HINGES

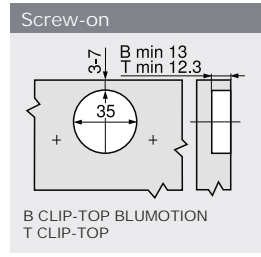
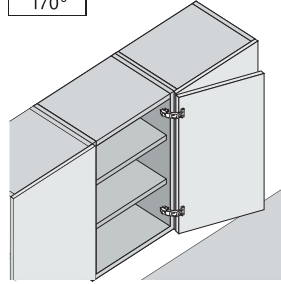

- All-metal hinge, nickel plated
- 170° opening angle
- Convenient spiral-tech depth adjustment
- With or without closing mechanism (spring)
- Tool-free door to cabinet assembly and removal



BLUMOTION



Safety information
If young children have access to furniture, with wide angle hinges, then the 155° opening 0-protrusion hinges should be used.

Order code	Description
B973A6000	BLUMOTION soft close mechanism for attachment to 170 degree hinges

DRAWER RUNNERS (PAIRS)

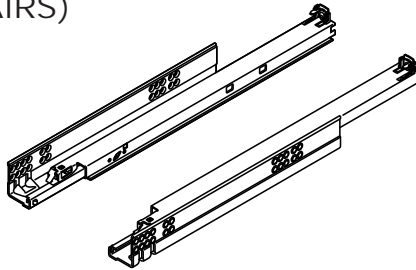

- BLUMOTION
- Locking device included

Order code	Tandem	Length	Weight
BTR270/30	Full-extension runners	270mm	30kg
BTR450/30	Full-extension runners	450mm	30kg

DOOR BUFFERS & PADS

CHAMELEON DOOR BUFFER

Standard

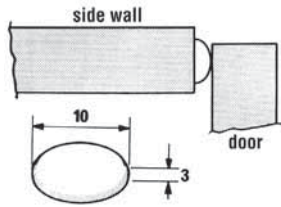
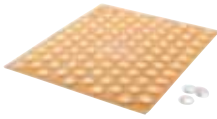

- Translucent finish
- Self-adhesive clear plastic buffer
- Suits any carcass colour
- Absorbs the impact of doors when using self-closing hinges
- 10mmØ x 3mm thick
- Supplied in sheets of 96 pieces
- For quantities, please refer to the price list

Order code
B3203

CHAMELEON DOOR BUFFER

Heavy duty

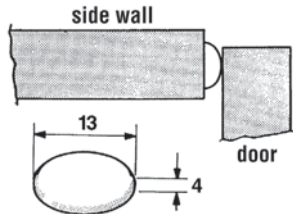
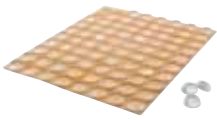

- Translucent finish
- Self-adhesive clear plastic buffer
- Suits any carcass colour
- Absorbs the impact of doors when using self-closing hinges
- 13mmØ x 4mm thick
- The increased surface area ensures greater adhesion
- Supplied in sheets of 80 pieces
- For quantities, please refer to the price list

Order code
B0038

DOOR BUFFER

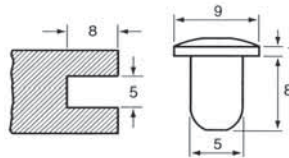

- Translucent finish
- Plastic door buffer
- Fits into a 5mmØ hole
- Suits any carcass colour
- For quantities, please refer to the price list

Order code
BDB2TR

LINEN STICKERS

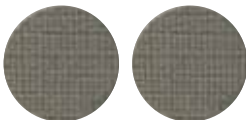

Order code

ZZKDVA0480	9mm linen cover stickers (shelf drawer runner holes) - Approx 60 per sheet
ZZKDVA0481	14mm linen cover stickers (used on cam holes) - Approx 20 per sheet

SELF-ADHESIVE PADS



- 300 white polyethylene foam pads
- Adhesive on both faces
- Supplied in a dispenser box
- Suitable for positioning items prior to screw fixing
- Dimensions: 25mm x 12mm x 2mm

Order code
BDSP300

POWERSTICK 2 PACK ADHESIVE



- Bonds in seconds. This quick tool-free system is suitable for jointing a wide variety of timber, plastic, and metal products
- Aerosol CFC free
- POWER1 - 12 month shelf life

Order code Description

BDPOWER1	Pack of 50g adhesive/200ml activator
BDBPOWER1	Box of 12 powerstick, shrink wrapped pack of 200ml activator and 50g adhesive

ADJUSTABLE LEGS & SOCKETS

One-piece or two-piece legs

- One-piece legs offer the most economical system. However, using a separate fixing socket gives considerable handling advantages.

Which fixing system?

- Bolt fix or screw fix for low/medium level production
- Dowel fix for large scale production

Plastic, steel, or decorative legs?

- Plastic legs are economical and strong
- Steel legs are more suitable for heavy duty applications - use with steel fixing sockets
- Decorative legs are used where no plinth is used

Which height?

- 150mm for kitchens, 100mm for bedrooms. 140mm are available for special circumstances (e.g. uneven flooring)

End panel support

- All the sockets & leg fixings are designed to overlap the base/end panel joint, reducing joint loading



SERIES 450 Plastic

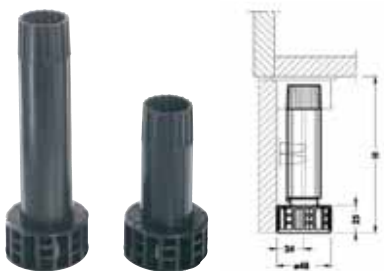

- Adjustable leg plastic
- Foot Ø: 48mm
- Leg height: 100mm or 150mm
- Adjustment range -5mm, +20mm
- Bulk packs of 2000 available

Socket compatibility: Plastic only

Order code	Description
B450 10 P2 OX O2	100mm high leg
B450 15 P2 OX O2	150mm high leg
B450 15 B2 OX O2	150mm bulk packed leg only

BOLT/SCREW FIX SOCKET Plastic

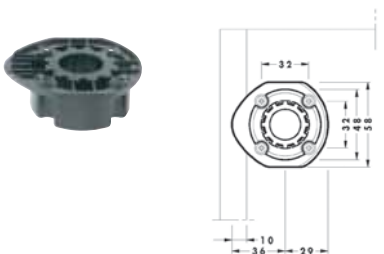

- Fix using 4x4mm chipboard screw (not supplied)
- Dimensions: 58x65mm, reduced flange
- End panel support
- For quantities, please refer to the price list

Order code	Description
B840 00 P2 H5 00	Bolt or screw fix, 58x65mm, plastic

BOLT/SCREW FIX SOCKET Plastic

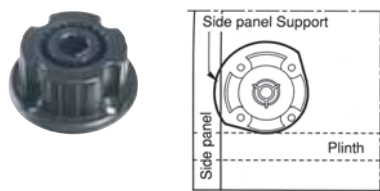

- Fix using 10mmØ, bolt or 4x4mm chipboard screws (not supplied)
- Bolt fixing allows adjustment from inside or outside of the base unit
- Dimensions 60x60mm
- End panel support
- For quantities, please refer to the price list

Order code	Description
BDNO	Single bolt/screw fix socket

PLINTH CLIPS

Plinth Clips

- 24mm offset should be used when the leg is required to give end panel support. The plinth should be rebated to avoid a gap between the gable panel and plinth
- To fit the leg in this way the centre leg should be positioned 24mm from the edge of the base panel (assuming the plinth and the gable panel are the same thickness and the plinth rests flush with the gable). If the leg is to support the base panel only, the centre of the leg should be at least 30mm from the base end panel edge
- A 30mm offset plinth clip can be used to bring the plinth flush with the gable panel (no rebate required) or a 24mm offset clip with the plinth by 6mm

Adjustment

- Hollow bolt fixing allows leg adjustment from the inside of the carcass, making carcass levelling easy
- Screw or dowel fixing also allows internal adjustment by drilling a 10mm hole centrally over the leg and plug with a 10mm plug cap

Hidden mounting

- Cover caps are visible from the inside of the carcass, however screw or dowel fixing methods are unseen when installed with no internal adjustment

 **CAMAR**[®]
the art of innovation

SERIES 228 Steel and plastic



- Adjustable plinth clip
- Height: 30mm
- Offset: 24mm
- Fixing: screw fix, 3mm x 4mm chipboard screws (not supplied)
- For quantities, please refer to the price list

Leg compatibility: 350, 418, 415, and 450 series

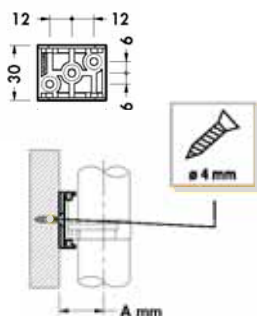

Order code	Description
B228 30 24 VI T2	Adjustable plinth clip

TABLE & WORKTOP SUPPORT LEGS

SERIES 615 & SERIES 620



- 570kg load capacity
- Both series 615 and 620 feature an adjustable foot
- Leg fixes to the underside of the worksurface using a screw-fix patented die-cast socket on both series
- 60mm and 80mmØ options

Order code	Finish	Dia	Height	Adj	Packing
B615 70 C1 O4 RN	Chrome	60mm	710mm	+30mm	set of 4
B620 70 C1 O1 RN	Chrome	80mm	710mm	+30mm	single
B620 70 IX O1 RN	Stainless Steel	80mm	710mm	+30mm	single
B615 87 C1 O1 RN	Chrome	60mm	870mm	+30mm	single
B620 87 C1 O1 RN	Chrome	80mm	870mm	+30mm	single
B620 87 IX O1 RN	Stainless Steel	80mm	870mm	+30mm	single

SERIES 606



- 570kg load capacity
- Features an adjustable foot
- Leg fixes to the underside of the worksurface using a welded steel plate
- 60mmØ

Can be cut down - (remove the plastic foot first)

Order code	Finish	Dia	Height	Adj	Packing
B606 87 C1 O1 RN	Chrome plated	60mm	870mm	+30mm	single

ADJUSTABLE SQUARE LEG

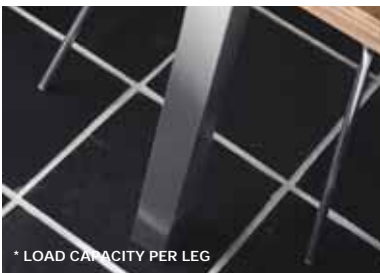

Height adjustment: Range of +10mm/-10mm Leg dimension: 60mm x60mm **Load capacity:** 470kg per leg

- A stainless steel worksurface support leg in a contemporary square design
- Supplied with all necessary fixings
- Available in two height options: 710mm and 870mm

Order code	Finish	Dia	Height	Packing
B646 70 IX O4 RN	Stainless Steel	80mm	710mm	set of 4
B646 87 IX O1 RN	Stainless Steel	80mm	870mm	single

DECORATIVE LEGS

BEECH VARNISHED LEG

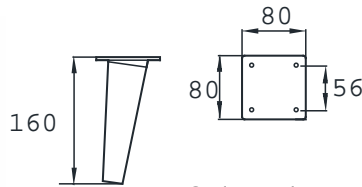

- Solid Beech, clear varnished, with white sockets
- Supplied in packs of 4
- No screws provided
- 157kg loading limit, per leg

Order code
BDL150BE

Description
Beech Varnished Leg, 150mm, pack of 4

SQUARE STACKABLE FEET

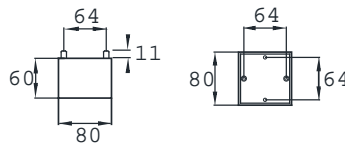

- Chrome effect
- Supplied in packs of 4
- No fixings provided
- Dowel and Screw fix required

Order code
BSF80BC

Description
Square stackable Feet, 80mmx80mmx60mm, bright chrome finish, pack of 4

BLACK MOUNTED FRAME

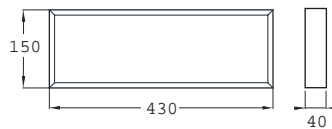

- Matt black powder coated finish
- Supplied ready to assemble with all fixings
- Supplied individually

Order code
BMODF430BK

Description
Black mounted frame, 430x150mm

DECORATIVE LEGS

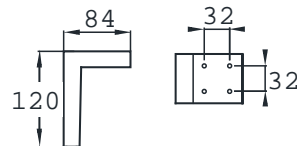

- Chrome effect
- Supplied in packs of 4 with fixing screws
- 68kg loading limit, per leg

Order code
BDL120CH

Description
Decorative legs, 120mm, flat base, bright chrome finish, pack of 4 with screws

WALL CABINET HANGERS

806 SERIES INTERNAL CABINET HANGER



- 28mm vertical adjustment and 25mm depth adjustment
- Unlimited horizontal adjustment when used with hanging rail
- All screw heads completely concealed
- Slide on, slide off cover
- Adjustment screws face the outside of the carcass for accessibility, allowing easy adjustment even when the cabinet is loaded
- For quantities, please refer to the price list

Further information

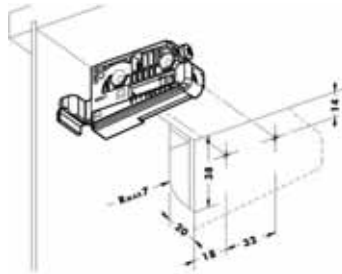

806 14 series

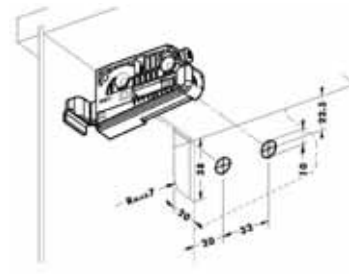

806 22 series

Order code	Colour	Fixing details
B806 14 P2 VI SX	Cream	Screw fix 4mmØ, left hand
B806 14 P2 VI DX	Cream	Screw fix 4mmØ, right hand
B806 00 NS 00 SX	Nickel	Cover cap, left hand
B806 00 NS 00 DX	Nickel	Cover cap, right hand

When using a concealed wall hanging bracket, a wall hanging rail will be required and should be secured to the wall using appropriate wall plugs and screws depending on the wall construction.

WALL FIXINGS

SLIMLINE STEEL HANGING RAIL

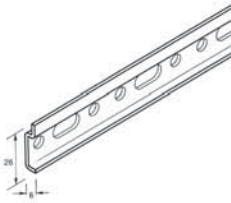

- 26mm steel rail which supports the wall unit cabinet hangers at any point along its length
- Especially suitable for hollow plasterboard walls
- Rail thickness 1.8mm
- For quantities, please refer to the price list

Order code	Description
B875 AC Z1 20 32	2032(L) x 26(H) x 6(D)mm

SLIMLINE STEEL HANGING PLATE

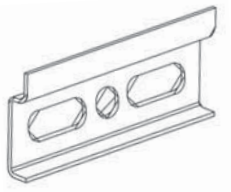

- 27mm steel plate
- Economical method of mounting cabinet hangers
- Plate thickness is 1.8mm
- For quantities, please refer to the price list

Order code	Description
B875 AC Z1 00 60	60(L) x 27(H) x 6(D)mm

AVENTOS HK-XS LIFT MECHANISM

AVENTOS HK-XS



AVENTOS HK-XS is a compact lifter for wall cabinets. Thanks to the narrow style, **AVENTOS HK-XS** offers a high level of design freedom.

AVENTOS HK-XS proves itself with the familiar **AVENTOS** quality of motion. Stay lifts open and close with seemingly weightless movement. They close silently and effortlessly in combination with **CLIP-TOP BLUMOTION** hinges.

- Specifically for small top wall cabinets or those with low internal depths
- Symmetrical lift mechanism, can be used on one or both sides for heavier frontals.
- Silent and effortless closing, thanks to **BLUMOTION**
- Stops at any opening position
- Easy assembly and adjustment



Order code	Description
BAVHKXS1000	AVENTOS HK-XS 200 - 1000 power factor
BAVHKXS1800	AVENTOS HK-XS 800 - 1800 power factor

Note
The power factor is doubled when used on two sides

FITTINGS

WARDROBE TUBE

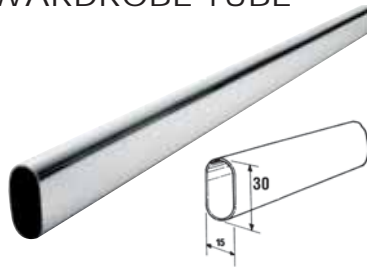

- Steel oval section tube, 0.7mm thick steel
- Suitable for use with SL322D, SL10 & SL20 tube supports
- Standard length 2500mm with a welded joint
- For quantities, please refer to the price list

Order code	Size
BT1130NP	Steel tube 30 x 15mm, nickel plated

TUBE SUPPORT

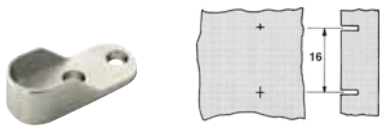

- Nickel plated finish
- Die-cast support for oval wardrobe tubes
- Screw-fixing with 3x No. 6 wood screws (not supplied)
- For quantities, please refer to the price list

Order code
BSL322DNP

CENTRE & END TUBE SUPPORT

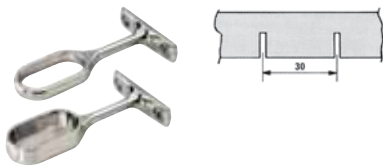

Centre tube support

- Chrome finish
- Die-cast support, easy installation
- For use where an 800mm+ span is encountered
- Screw fixing with No. 6 wood screws
- Blanked end which can be used as a matching end support
- For quantities, please refer to the price list

Order code	Description
BSL10NP	Tube bearing centre support
BSL20NP	Tube bearing end support

FOOT TACK

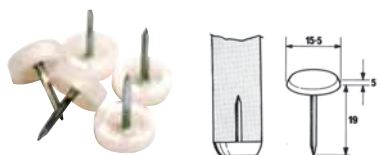

- Steel tack with a nylon head
- Can be used as a furniture glide to protect the furniture during manufacture and transport
- Can also be used to prevent moisture absorbing into end panels
- For quantities, please refer to the price list

Order code
B10560

SERIES 300 FURNITURE LEVELLER

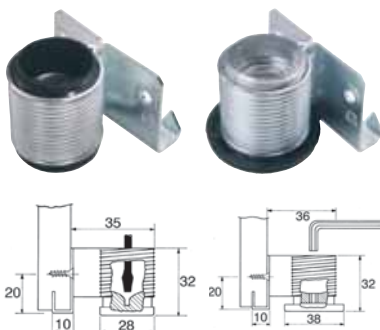

- Steel bodied leveller, adjustment up to +20mm
- Fastens to the bottom edge of the carcass with two integral knock-in spikes and is secured with two 3.5mm chipboard screws (not included)
- Can be adjusted internally by drilling a hole in the bottom of the base panel
- Plastic foot to be adjusted by a slotted screwdriver
- Die-cast version for heavy duty use adjusted by a 6mm allen key
- For quantities, please refer to the price list

Order code	Description	Loading capacity
B300 00 Z2 00 A2	Plastic foot	100kg
B300 00 Z2 00 Z2	Die-cast foot	150kg

CONNECTOR BLOCK

CONNECTOR BLOCK

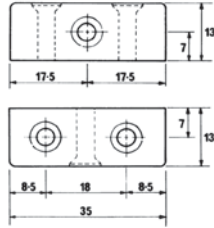

- Almond (RAL9001) finish
- Plastic KD block
- For quantities, please refer to the price list

Order code	Description
BKD1AL	Plastic connector block

SHELF SUPPORTS

SAFETY SHELF SUPPORT

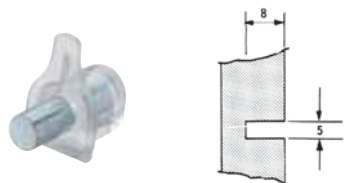

- Translucent plastic body with steel peg
- Suitable for conventional shelves
- Requires a 5mmØ hole
- For quantities, please refer to the price list

Order code
BSAF1

METAL SHELF SUPPORT

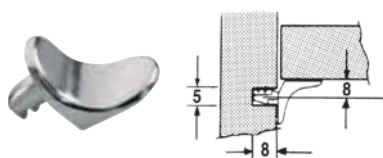

- Nickel plated finish
- Die-cast self-locking
- Requires a 5mmØ hole
- For quantities, please refer to the price list

Order code
BSEK2

SHELF STUD

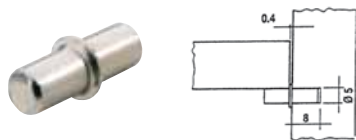

- Nickel plated finish
- Metal barrel type shelf studs with flange
- Can be used either way round
- Requires a 5mmØ hole
- For quantities, please refer to the price list

Order code
B148/5NP

SHELF STUD

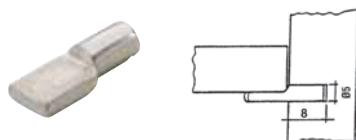

- Nickel plated finish
- Metal spade shape
- Requires a 5mmØ hole
- For quantities, please refer to the price list

Order code
B146/5NP

SHELF SUPPORTS

HEAVY DUTY CONCEALED WALL SHELF SUPPORT



- One piece design, suitable for shelf panels 22mm thick upwards
- Fixes into the face of the panel and through to the wall for additional support with 5mmøx50mm screws
- Suitable for shelf panels from 22mm thick (heavy duty only)
- Load bearing capacity up to 85kg per m² equally distributed
- The support is height and tilt adjustable
- Finish: bright zinc plated



BCSSPF120
(heavy duty)



BCSSWF120/160

Order code	Description	Dia	Length	Panel thickness
BCSSWF120	Wall fixing, concealed	12mmØ	120mm	22mm
BCSSWF160	Wall fixing, concealed	12mmØ	160mm	22mm
BCSSPF120	Heavy duty, face panel fixing	12mmØ	120mm	28mm



TECHNICAL
INFORMATION

TECHNICAL INFORMATION

THE 'HOW TO' GUIDE	03
COMPLETE/COMPONENT STOCKED PRODUCT SPECIFICATION	33
SLIDING WARDROBE SPECIFICATION	45
CABINET DETAIL FOR MANUFACTURERS	49

THE 'HOW TO' GUIDE

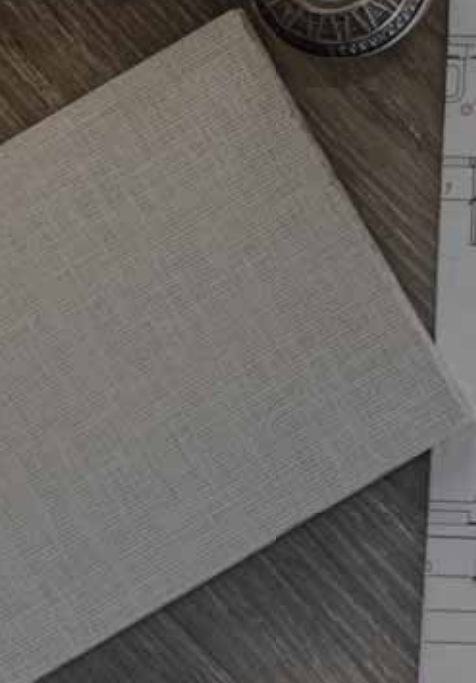
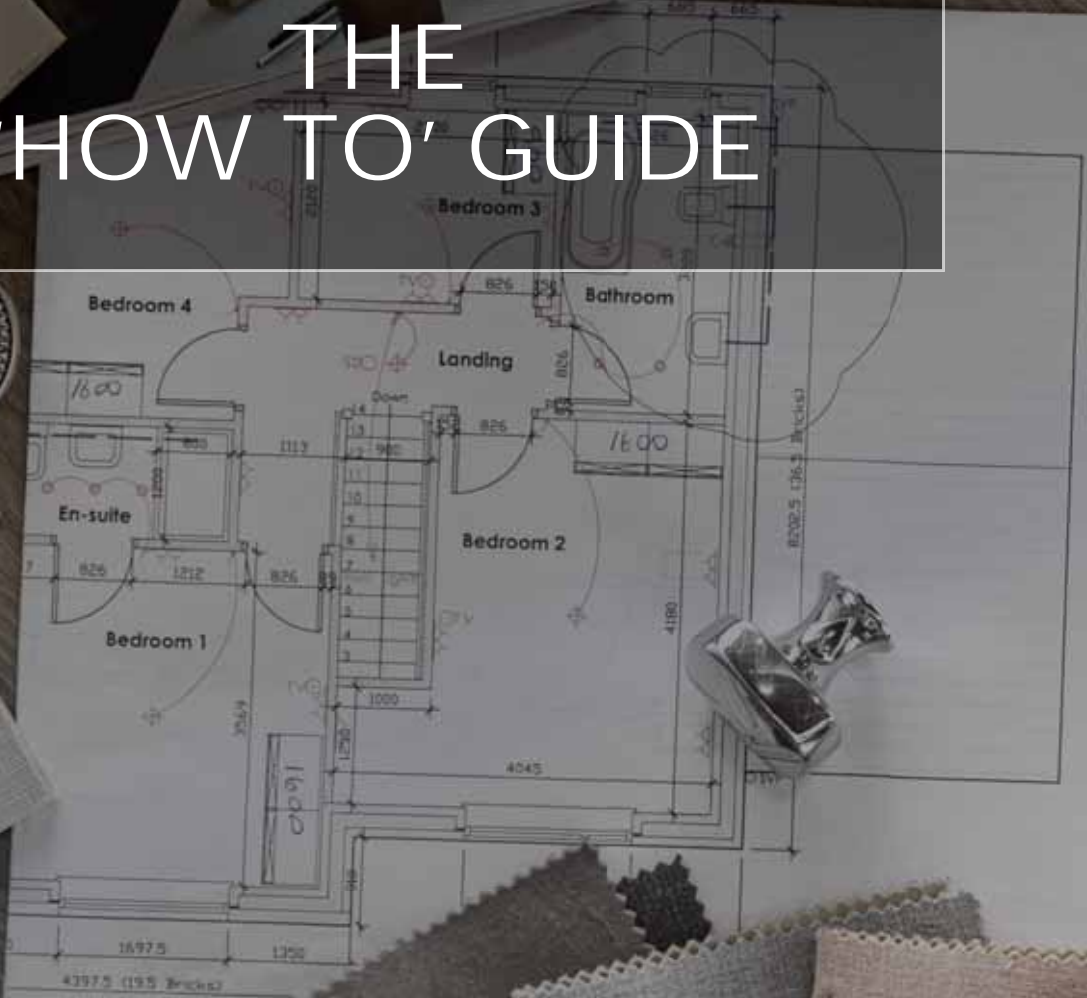

This document has been designed to help you familiarise yourself with the correct product to use in all scenarios, as featured in our brochures when using complete or component stocked product.

We have tried to explain every situation you may come across when planning a space; whether it's a simple run or something a little more complex.

If you encounter something difficult to plan that we have not covered please call your representative to speak direct with someone who can help.

CONTENTS

How to plan your design	05
Is it going against a wall?	07
Do you have an open end?	08
Do you want to add a feature post?	09
Feature post details	10
Which plinth do you need?	11
Do you need cornice?	12
— Cornice options	12
— Not enough height for cornice	13
— Infill to ceiling	13
— Feature post as cornice	14
Do you have additional height?	15
— Additional height	15
— Even more height	16
Choosing the correct plinth for a corner wardrobe	17
Do you want to use plinth on a stable robe?	19
How to do a break front	20

ADDITIONAL FEATURES

Floating shelves	22
How to integrate chests	23
— Classic	23
— Modern	24
Creating a custom fit desk	25
— Classic	25
— Modern	26
Uses for a feature storage unit	27
— Bridging units	27
— Window seats	28
— Media units	29
Creating a modern dressing table	31
Putting 2 chests together	32

'HOW TO' PLAN YOUR DESIGN - HINGED COMPLETE COLLECTION

STEP
1

MEASURE YOUR SPACE

Ensure you are fully equipped to start designing. The bedroom planning paper prompts things you need to think about when measuring a space including:

- ✓ Sockets
- ✓ Switches
- ✓ Window ledges etc

STEP
2

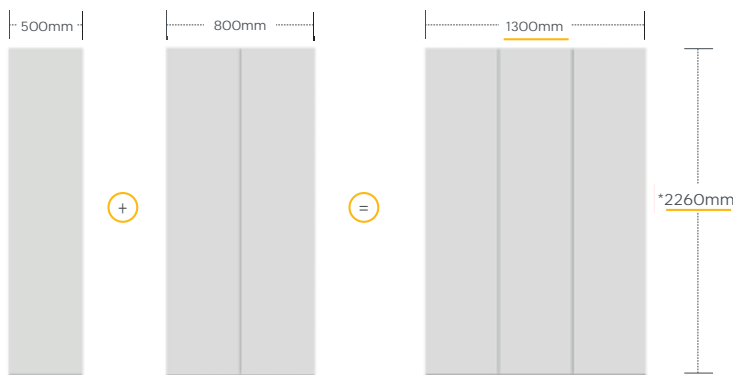

CREATE A WARDROBE RUN

Although our wardrobes are rounded numbers sometimes the cabinets can creep in size. Please remember a tolerance of + / - 1mm per wardrobe when planning a design; especially if the wardrobe run is to go wall to wall.

Please allow 1mm + / - per wardrobe

STEP 3

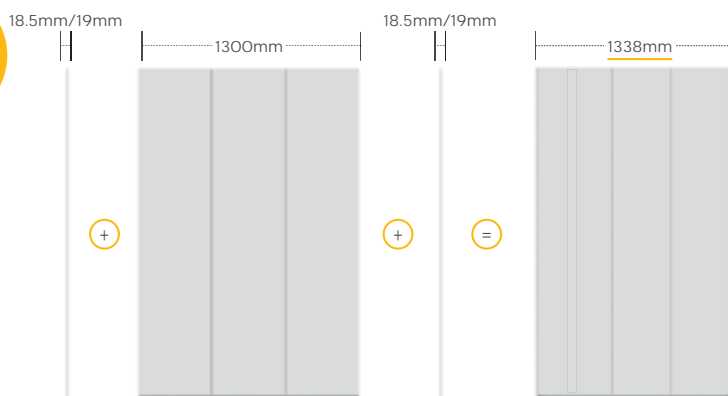

ADD END PANELS AND FILLERS

Depending on whether your design is wall to wall or open ended you will need to add either an end panel or a custom fit plinth to cover the linen coloured cabinet. For advice on what product to choose please see our next section.

STEP 4

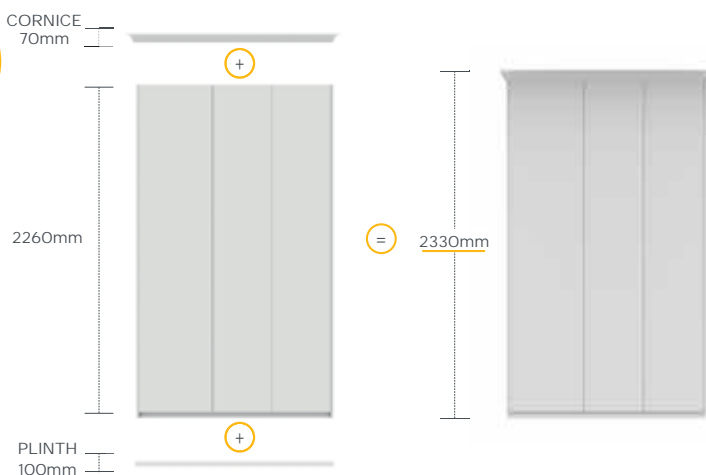

ADD CORNICE & PLINTH

You will always need to use a length of plinth to cover the structural base of the wardrobe and depending on whether your design has the space you can either add a cornice or an infill to ceiling to finish off the display.

STEP 5



ADD YOUR INTERNALS

Depending on the storage requirements we have multiple internal storage options for our wardrobes. You can choose from predetermined bundles or get creative and design your own. Please refer to section 2 for our full internals section.

IS IT GOING UP AGAINST A WALL?

FLUSH

If your wardrobe run is going up against a wall you can use a length of plinth to give the same effect as an end panel without wasting unnecessary product.

CLASSIC



PRODUCT NAME	DIMENSIONS
Moulded plinth	3050mm L x 100mm H x 25mm D
Classic plinth	3050mm L x 100mm H x 19mm D
Custom fit plinth	3050mm L x 160mm H x 19mm D

MODERN



PRODUCT NAME	DIMENSIONS
Plinth	3050mm L x 36mm H x 18.5mm D
Custom fit plinth	3050mm L x 160mm H x 18.5mm D

WITH GAP

If your wardrobe is going up against a wall but has a gap larger than 18.5mm/19mm; you can choose whether to make a filler from any of the following items.

CLASSIC



SIZE FILLER	PRODUCT NAME	DIMENSIONS
Up to 36mm	Moulded plinth	3050mm L x 100mm H x 25mm D
Up to 100mm	Classic plinth	3050mm L x 100mm H x 19mm D
Up to 160mm	Custom fit plinth	3050mm L x 160mm H x 19mm D
Up to 650mm	End panel	2400mm L x 650MM W x 19mm D

MODERN



SIZE FILLER	PRODUCT NAME	DIMENSIONS
Up to 36mm	plinth	3050mm L x 36mm H x 18.5mm D
Up to 160mm	Custom fit plinth	3050mm L x 160mm H x 18.5mm D
Up to 650mm	End panel	2400mm L x 650MM W x 18.5mm D

DO YOU HAVE AN OPEN END?

If your wardrobe has an open end you will need an end panel or custom fit plinth to cover the full visible depth of the wardrobes and any voids at the back.

FULL DEPTH



To cover the full depth of the wardrobe and any voids at the back, it's best to use an end panel.

CLASSIC

PRODUCT NAME	DIMENSIONS
End panel	2400mm L x 650MM W x 19mm D

MODERN

PRODUCT NAME	DIMENSIONS
End panel	2400mm L x 650MM W x 18.5mm D

INFILL PLINTH



To cover smaller depths into alcoves or between other objects choose from below:

CLASSIC

SIZE FILLER	PRODUCT NAME	DIMENSIONS
Up to 36mm	Moulded plinth	3050mm L x 100mm H x 25mm D
Up to 100mm	Classic plinth	3050mm L x 100mm H x 19mm D
Up to 160mm	Custom fit plinth	3050mm L x 160mm H x 19mm D
Up to 650mm	End panel	2400mm L x 650MM W x 19mm D

MODERN

SIZE FILLER	PRODUCT NAME	DIMENSIONS
Up to 36mm	Plinth	3050mm L x 36mm H x 18.5mm D
Up to 100mm	Custom fit plinth	3050mm L x 160mm H x 18.5mm D
Up to 650mm	End panel	2400mm L x 650MM W x 18.5mm D

DO YOU WANT TO ADD A FEATURE POST?

You can use a feature post to create a detail on the end of a wardrobe run. It can be up against a wall or on an open end. It can also be 50mm or 100mm facing depending on your preference and overall width.

MODERN

50mm



100mm



CLASSIC

50mm



100mm



FEATURE POST DETAIL; END PANEL FLUSH OR PUSHED BACK?

If the wardrobe run has an open end you can choose whether to put the end panel flush with the back of the feature post or push it back level with the recess on the reverse of the feature post to create additional detail.

MODERN

Flush



Pushed back



CLASSIC

Flush



Pushed back



WHAT PLINTH DO YOU NEED?

You will always need a plinth to cover the structural base of the wardrobes. Depending on whether you want to achieve a specific look or whether the floor runs out we have multiple options of plinth to choose from.



CLASSIC

The classic plinth is a simple design with a small edge detail that can be used in all scenarios.

The moulded plinth is slightly more decorative for a more classic look. It is also slightly thicker in depth.

CLASSIC PLINTH OPTIONS	
Moulded plinth	3050mm L x 100mm H x 25mm D
Classic plinth	3050mm L x 100mm H x 19mm D
Custom fit plinth	3050mm L x 160mm H x 19mm D

**as you can see the moulded plinth requires the return of the plinth around the wardrobe and the end panels cut to sit on top are to plinth thickness.*

MODERN

Both modern plinths give the same look aesthetically, the difference is only that the custom fit plinth can be cut in height if the floor runs out of level.

MODERN PLINTH OPTIONS	
Plinth	3050mm L x 36mm H x 18.5mm D
Custom fit plinth	3050mm L x 160mm H x 18.5mm D

DO YOU NEED A CORNICE?

Depending on what look you want to achieve or what height you have remaining we have various cornice options.

CLASSIC

If you would like to take a contemporary approach to the classic collection we recommend using the feature post or classic cornice. Although the classic cornice is a traditional shape it has a very linear design.

For a more ornate feature we would recommend the moulded cornice with a swallow neck profile.

CLASSIC CORNICE OPTIONS	
Feature post	3050mm L x 50mm H x 100mm D
Classic cornice	3050mm L x 66mm H x 76mm D
Moulded cornice	3050mm L x 70mm H x 109mm D

*FEATURE POST
as Cornice*



CLASSIC Cornice



MOULDED Cornice



MODERN

For a simple contemporary look we suggest the modern cornice, or for more of a statement we suggest the feature post as cornice.

If you want to create an ultra contemporary look you could leave the cornice off altogether.

MODERN CORNICE OPTIONS	
Feature post	3050mm L x 50mm H x 100mm D
Cornice	3050mm L x 28mm H x 50mm D

**FEATURE POST
as Cornice**



MODERN Cornice

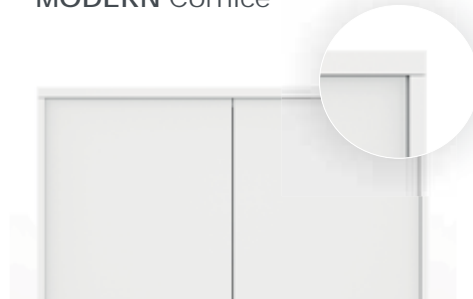

WHAT IF YOU DON'T HAVE THE CORRECT HEIGHT FOR A CORNICE?

If you have not got the full height needed to use a modern or classic cornice you have the option to use either a modern or classic plinth as cornice instead.

CLASSIC



When using either the classic plinth or custom fit plinth as cornice you will achieve the same aesthetical appearances. The difference will be in the height of the product remaining to fix it to the wardrobe. However, if you use the moulded plinth as cornice you have the option to use the scalloped edge detail on the plinth to create a feature around the wardrobe run as shown above.

SIZE FILLER	PRODUCT NAME	DIMENSIONS
25mm	Moulded plinth	3050mm L x 100mm H x 25mm D
19mm	Classic plinth	3050mm L x 100mm H x 19mm D
19mm	Custom fit plinth	3050mm L x 160mm H x 19mm D

MODERN



You can use either of the modern plinths for the same aesthetical appearances. The difference will be in the depth of the product remaining to fix it to the wardrobe.

SIZE FILLER	PRODUCT NAME	DIMENSIONS
18.5mm	Plinth	3050mm L x 36mm H x 18.5mm D
18.5mm	Custom fit plinth	3050mm L x 160mm H x 18.5mm D

WHAT IF YOU WANT TO INFILL TO CEILING?

If you do not want to use cornice but you also do not want a gap at the top of your wardrobe you can infill to the ceiling. Depending on the size of the gap we have varying products that can be used.

CLASSIC



HEIGHT REMAINING	PRODUCT NAME	DIMENSIONS
Up to 100mm	Classic plinth	3050mm L x 100mm H x 19mm D
Up to 160mm	Custom fit plinth	3050mm L x 160mm H x 19mm D
160+mm	End panel	2400mm L x 650mm H x 19mm D

MODERN



HEIGHT REMAINING	PRODUCT NAME	DIMENSIONS
Up to 100mm	Custom fit plinth	3050mm L x 160mm H x 18.5mm D
100mm +	End panel	2400mm L X 650mm W X 18.5mm D

DO YOU WANT A FEATURE POST INSTEAD?

You can create a decorative feature around the wardrobes by using a Passepartout.

When using a feature post to create a Passepartout around the wardrobe run, you can choose to either mitre or butt joint the posts in the corners.

If the Passepartout is on an open end, you then have the option of putting the end panel flush with the back of the feature post, or pushed back in line with the recess at the back of the post.

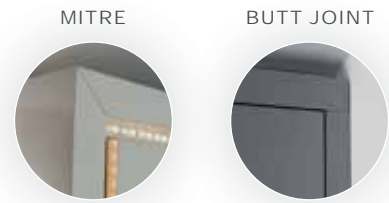

50mm MITRE

CLASSIC



Flush



Pushed back



MODERN



Flush

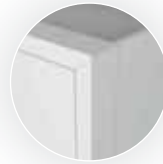

Pushed back

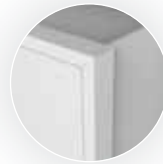

50mm BUTT JOINT

CLASSIC



Flush

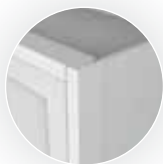

Pushed back



MODERN



Flush

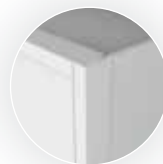

Pushed back

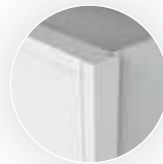

DO YOU HAVE ADDITIONAL HEIGHT?

If you have a ceiling height of 2710mm or above you can use feature storage units on top of wardrobes to fill the additional height.

Wardrobe 2260mm
 Feature storage unit 450mm

FEATURE STORAGE UNIT WITH CORNICE

Following that you can then use cornice, infill straight to the ceiling or create a feature with an additional section between the wardrobes and the feature storage units. To see how this works please see the next pages.

CLASSIC



HEIGHT REQUIRED	PRODUCT USED
2780mm	Wardrobe, feature storage unit & moulded cornice
2776mm	Wardrobe, feature storage unit & classic cornice
2760mm	Wardrobe, feature storage unit & feature post

MODERN



HEIGHT REQUIRED	PRODUCT USED
2746mm	Wardrobe, feature storage unit & cornice
2760mm	Wardrobe, feature storage unit & feature post

FEATURE STORAGE UNIT WITH INFILL

CLASSIC



MODERN



WHAT IF YOU HAVE EVEN MORE HEIGHT

If you have an even taller ceiling height there is an option to add in an additional feature by using a length of plinth or feature post between the feature storage unit and the wardrobes before adding a cornice or infill to ceiling.

INFILL BETWEEN ROBE AND FEATURE STORAGE UNIT

CLASSIC



MODERN



The classic collection has a lot more variation due to the varying heights between the classic and moulded cornice and plinth options. Please be aware of the height you have available when selecting the best solution for your design.

HEIGHT NEEDED	PRODUCT USED
2799mm	Wardrobe, feature storage unit, moulded cornice & classic plinth
2805mm	Wardrobe, feature storage unit, moulded cornice & moulded plinth
2795mm	Wardrobe, feature storage unit, classic cornice & classic plinth
2801mm	Wardrobe, feature storage unit, classic cornice & moulded plinth
2826mm	Wardrobe, feature storage unit, classic cornice & feature post (50mm facing)
2830mm	Wardrobe, feature storage unit, moulded cornice & feature post (50mm facing)

HEIGHT NEEDED	PRODUCT USED
2757mm	Wardrobe, feature storage unit, cornice & plinth (19mm facing)
2774mm	Wardrobe, feature storage unit, cornice & plinth (36mm facing)
2788mm	Wardrobe, feature storage unit, cornice & feature post (50mm facing)

HOW TO CHOOSE THE CORRECT PLINTH FOR A CORNER WARDROBE

When choosing the correct plinth for your wardrobe you must decide how you would like it to look first as each plinth may have a different application.

CLASSIC



MOULDED Plinth

When using the moulded plinth with a corner wardrobe you will need to remember that the corner post will need to be cut to the height of the doors so the plinth can sit beneath it.

The plinth should also be return mitred around the wardrobe with the end panel cut to the length of the doors and sat on top of the plinth. This is due to the thickness of the plinth – If you did not want to return mitre the plinth around the wardrobe you would need to pull the end panels forward – proud of the doors to cover the cut end of the plinths as the plinth is 25mm thick.

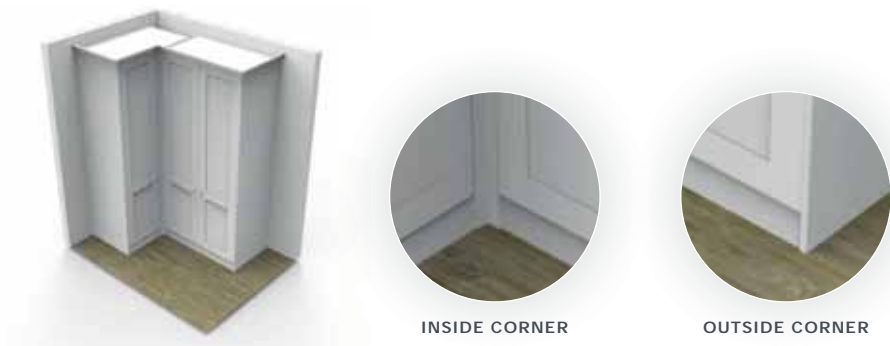

CLASSIC Plinth

When using the classic plinth you do not need to cut the corner post to the height of the door.

You can fit the corner post all the way to the floor and the classic plinth will run flush into it. You also do not need return mitre the plinth around the wardrobe as it will sit inside the end panels when fitted normally.

MODERN



INSIDE CORNER



OUTSIDE CORNER

MODERN Plinth

When using the modern plinth you do not need to cut the corner post to the height of the door.

You can fit the corner post all the way to the floor and the plinth will run flush into it. The plinth will also sit inside the end panels when fitted normally.

DO YOU USE A PLINTH WITH THE STABLE ROBE?

When designing with a stable robe you have an additional option to finish the front of the run with an additional piece of plinth.

MODERN

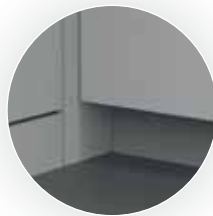

The stable robe is designed with a blanking panel that runs directly into the floor that allows you to push a modern chest into it. When the blanking panel runs to the floor and the chest is pushed into it the modern chest will have slight shadow gap beneath it.

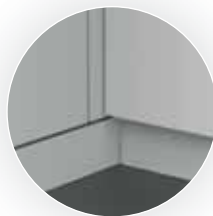

If you want to avoid the shadow gap at the bottom you can cut the blanking panel to the height of the door next to it and run the wardrobe plinth the full length of the run. You can then use a length of plinth under the modern 4 drawer chest up to the plinth on the wardrobe run and any gaps in the corner of the stable robe will now be hidden.

HOW TO DO A BREAKFRONT

If you want to create an additional design feature within the bedroom run, a popular feature is to create a breakfront with feature posts.

CLASSIC



MODERN

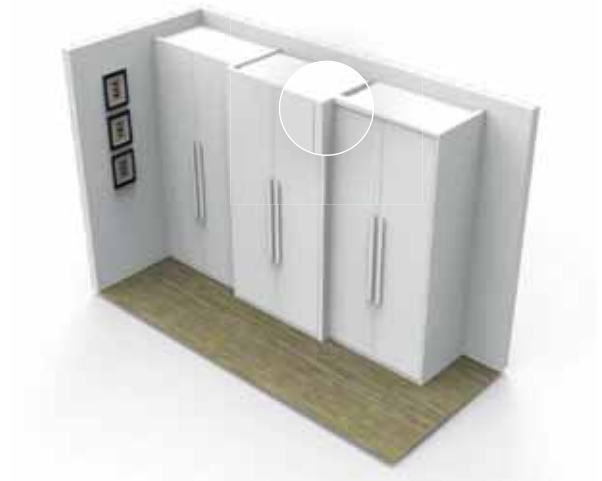

TO CREATE A BREAKFRONT YOU REQUIRE:

2X FEATURE POSTS
2400mm for standard wardrobe height
3050mm for wardrobes with top boxes

The most efficient way to create a breakfront is to use the post 50mm facing.

This allows you to pull the 'feature' wardrobes up to 100mm forward from the wardrobes on the back wall.

To ensure stability of the breakfront we suggest you baton the back of the wardrobe to the wall or; before placing the base into the wardrobe, baton to the floor which can then be hidden under the wardrobe base.



Oak finish no longer available



'HOW TO' GUIDE ADDITIONAL FEATURES

HOW TO CREATE A 'FLOATING' SHELF

To add an additional storage feature you can create a 'floating' shelf. These consist of a selection of feature posts as the front and two pieces of end panel, top and bottom enclosing the feature post giving it a 'chunky' appearance.

CLASSIC and MODERN



TO CREATE A FLOATING SHELF YOU WILL NEED:

QUANTITY DEPENDANT ON SHELF WIDTH + DEPTH
Feature post 2400 or 3050 - depending on length
End panel or custom fit panel - depending on colour

When working out your quantities please remember that you will need a piece of end panel for both the top and bottom of the reverse of the feature post - we call this double skinning the shelf.

HOW TO INTEGRATE CHESTS INTO A WARDROBE RUN

CLASSIC

PUSHED BACK

PULLED FORWARD

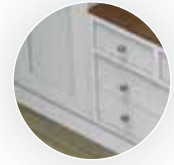
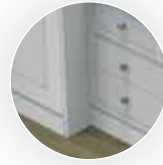

PUSHED BACK



Pushing the chest back will require the removal of the chest plinth to allow the piece to integrate seamlessly – this will need to be replaced with the same plinth that is used on the wardrobe run. To do this you will need to raise the chest on blocks or adjustable feet to the same height as the wardrobe plinth. (Not supplied)

The chest top with coving detail will still work when integrated but will need adjusting on the sides to remove the mitre return and scalloped edge profile.

PULLED FORWARD

OAK TOP

Pulling the chest forward will also require the removal of the chest plinth to allow the piece to integrate seamlessly – this will need to be replaced with the same plinth that is used on the wardrobe run but will now run completely across the front. To do this you will need to raise the chest on blocks or adjustable feet to the same height as the wardrobe plinth. (Not supplied)

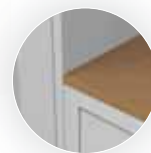

The chest top with coving detail will no longer work; and will require a panel to create a top. The panel should then sit between the two end panels used on the sides of the wardrobes for a fully fitted look.

COLOUR MATCHED

When pulling the chest forward and if you require a colour matched top you will need an additional panel in the colour of choice. You then have the option to reduce the width by 36mm by sitting the top under the end panels used on the sides of the wardrobe. However you could still follow the application shown above if you have the width.

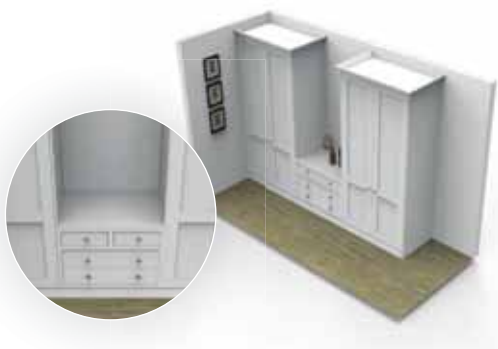

MODERN

PUSHED BACK



There will be no changes required if you push the chest back and it will fit seamlessly between the two end panels on each side of the wardrobes. It is best to be aware of the drawers when fitting to ensure they will still open.

There is an option to cover the structural plinth of the chest with the 36mm modern plinth to remove the shadow gap at the bottom.

PULLED FORWARD



NO TOP BOXES

Pulling the chest forward will require an additional end panel on the top of the chest to cover the void the back. If you are not using top boxes you can reduce the width by 36mm by sitting the top of the chest under the end panels used to cover the gables on the sides of the wardrobes and then continuing the wardrobe plinth all the way across the front of the wardrobe run.

WITH TOP BOXES

If you are using top boxes whilst integrating a chest you will need to sit the chest inside the end panels on the sides of the wardrobes - and then continuing the wardrobe plinth all the way across the wardrobe run, rather than setting the chest 36mm closer and under the end panels on the sides of the wardrobe. This is to allow for the top box width. Additionally if pulling the top boxes forward flush with the chest you will require a panel for the underside of the top boxes.



CREATING A CUSTOM FIT DESK

CLASSIC



OPEN END

When using the classic custom fit desk with an open end you have up to a length of 2400mm and a depth of 488mm with no changes. If you require the desk to be deeper you will need to consider over panelling the back of the chest to cover the gap made when you pull the chests off the wall, but you will also need to change the plinth.



AGAINST A WALL - No change

When using the classic custom fit desk against a wall. You have up to a length of 2400mm and a depth of 488mm with no changes. However due to the chest plinth detail you will end up with a small gap against the wall. To remove the gap please see the swapped plinth option below.

Again if you require the desk to be deeper you will need to consider over panelling to cover the gap at the back of the chest, but you will also need to change the plinth.



AGAINST A WALL - Swapped plinth

When using the classic custom fit desk against a wall without a gap you will need to remove the existing chest plinth and raise the chest on blocks or feet and swap the plinth to the same as what is being used on the rest of the wardrobes. You have up to a length of 2400mm and a depth of 488m for the chest top. (The blocks/feet are not supplied)

Again If you require the desk to be deeper you will need to consider over panelling to cover the gap at the back of the chest.

MODERN



OPEN END

To create a modern desk with an internal stackable drawer and an open end you need to order additional products to make a structural and supporting leg.

By using a feature post (50mm facing) and cladding, the back of the post with end panels, will create an independent and solid leg you can then fix the drawer runners to. The opposing side will fix directly into the end panel on the gable end of the wardrobe. You then have the option of using a colour matching or contrasting top for the desk top. Bear in mind the modern collection does not have edging tape so finished edges will need to be used where can be seen.



AGAINST A WALL - Without Feature Storage Units

To create a modern desk with an internal stackable drawer against a wall you need to ensure you have the correct fixings for the type of wall you are fixing to. If the wall is plasterboard we recommend using the batons and filler strips that come with the stackable drawer to fix to the walls - the widths of these drawers are as follows.

STACKABLE DRAWER	DRAWER WIDTH DIMENSION
500 stackable drawer + fillers	464mm
800 stackable drawer + fillers	764mm
900 stackable drawer + fillers	864mm
1000 stackable drawer + fillers	964mm

If you have a brick wall you have the option of removing the batons and filler strips and fitting the drawer flush to the wall. -the widths of the drawers without the fillers are as follows.

STACKABLE DRAWER	DRAWER WIDTH DIMENSION
500 stackable drawer	414mm
800 stackable drawer	714mm
900 stackable drawer	814mm
1000 stackable drawer	914mm



AGAINST A WALL - With Feature Storage Units

To create a modern desk with an internal stackable drawer against a wall with feature storage units above – your width will be determined by the size of the feature storage units you are using. Because feature storage units are external widths and the stackable drawers are designed for internal widths (inside wardrobe cabinet) you will need to remember to order something to make the larger fillers for either side of the drawers.



DIFFERENT USES FOR FEATURE STORAGE

BRIDGING UNIT

CLASSIC or **MODERN**



PUSHED BACK

When pushing the feature storage units back between two wardrobes you must remember that if you are using a cornice you will need to allow for the cornice around the wardrobes and the feature storage units, and also include end panel on the underside.



PULLED FORWARD

When pulling the feature storage units forward flush with wardrobes, the cabinets will need to be battened to the wall for stability. In this case the cornice will run along the front of the wardrobes in a straight run and will still require an end panel on the underside.

WINDOW SEAT



CLASSIC

To create a window seat in the classic collection you will need to divide the width by the amount of storage boxes required or that will fit. You may need to create fillers from end panels for additional width that will not work with our door sizes. To modify the cabinets to suit any shape, remember to order a linen panel to modify the robe. We have also raised the feature storage units from the floor on blocks and used a 100mm plinth to match the classic wardrobe collection.



MODERN

To create a window seat in the modern collection you will need to divide the width by the amount of storage boxes required or that will fit. You may need to create fillers from end panels for additional width that will not work with our door sizes. To modify the cabinets to suit any shape remember to order a linen panel to modify the robe. We have also raised the feature storage units from the floor on blocks and used a 36mm plinth to match the modern wardrobe collection.

In both instances we recommend that for the top of the window seat, you employ a professional upholsterer to create you a bespoke seat pad to fit the size, density and fabric options to suit your requirements.

DIFFERENT USES FOR FEATURE STORAGE

MEDIA UNIT AGAINST ROBES



CLASSIC

To create a media unit on the floor in the classic collection you have the option to create the top in either a colour matched panel or custom fit oak top. In the visual shown we put the finished edges to the front and side and cut edges to the wall and against the wardrobe. We have also raised the feature storage units from the floor on blocks and used a 100mm plinth to match the wardrobes. (Blocks are not supplied)



MODERN

To create a media unit on the floor in the modern collection you will need to remember that the modern collection does not have a matching edging tape. In the visual shown we put the finished edges to the front and side and cut edges to the wall and against the wardrobe. We have also raised the feature storage units from the floor on blocks and used a 36mm plinth to match the wardrobes. (Blocks are not supplied)



MEDIA UNIT STAND ALONE



CLASSIC

To create a media unit on the floor in the classic collection you have the option to create the top in either a colour matched or oak end panel or using the custom fit tops with the scalloped coving profile. In the visual shown we have used a custom fit top with scalloped coving profile. We have also raised the feature storage units from the floor on blocks and used a 100mm plinth to match the classic wardrobe collection. (Blocks are not supplied)



MODERN

To create a media unit on the floor in the modern collection you will need to remember that the modern collection does not have a matching edging tape. In the visual shown to create a top we have used modern 36mm plinth to create a frame and then sat the cut panel inside to create a finished edge. We have also raised the feature storage units from the floor on blocks and used a 36mm plinth to match the modern wardrobe collection. (Blocks are not supplied)

STAND ALONE DRESSING TABLE

MODERN

If you want to create a stand alone dressing table you can use the same method as the modern stackable drawer desk but to make it fully free standing you will need to duplicate the leg on both sides.

You need to remember that the width of the dressing table will be determined by the size of the stackable drawer you are using. Because the stackable drawers are designed for internal widths (inside wardrobe carcass) that the drawer front sizes are not standard.

You **do not** need to use the fillers that come with the stackable drawer, as the runners can fix to the new legs.



If you do not use this fillers the widths will be as follows.

DESCRIPTION	DRAWER WIDTH DIMENSION	OVERALL WIDTH
500 stackable drawer without fillers	464 mm	564 mm
800 stackable drawer without fillers	764mm	864mm
900 stackable drawer without fillers	864mm	964mm
1000 stackable drawer without fillers	964mm	1064mm

If you want your free standing dressing table to equal an even width you will need to use the fillers either side of the drawer.



PUTTING 2 CHESTS TOGETHER

CLASSIC

If you want to put 2x classic 2 + 2 chests together you can make them look like one complete unit by using a custom fit top and moulded plinth.

To join 2x classic chests together you will need to fully remove both of the structural plinths from the free standing chests and replace them with a length of moulded plinth. You may need to raise the chests on blocks in order to do this as the chests do not have additional feet.

You will also need to fully remove both chest tops and replace them with a custom fit top in either oak or colour matched to your chest. The top will require some custom work with the coving profile and edge banding.

**It may help to also take the chests flat-packed)*

PRODUCT REQUIRED
1x custom fit top
1x moulded plinth
1x coving profile (additional)



If you want to avoid having a joint line between the two chests you can remove the two chest edge pieces that will be side by side and replace with one piece of cut colour matched end panel. Please note the panel will need to be edged with matching edging tape as it will be seen when the drawers are opened.

**It may help to also take the chests flat-packed)*



MODERN

If you want to put 2x modern 4 drawer chests together you can make them look like one complete unit by using end panel and plinth.

You will need to put 2 cut pieces of end panel down each side of the modern chest – Finished edge to the front and also a finished edge 18.5mm higher than the top of the chest.

A piece of end panel can then be used to create a top which will sit inside the two raised edges of panel used on the ends of the chest. This will cover any cut panel edges – however you will need a finished edge to the front of the chest.

A length of plinth can then be ran across the front of the chests to hide any joins on the base.

PRODUCT REQUIRED
1 x Plinth
2 x End panels



A photograph of a bedroom corner. On the left, grey curtains are tied back with a thick rope. A white dresser with a light wood top and silver handles stands in the center. Above it is a wooden cabinet with glass doors, containing various decorative items like a star and a shell. A hanging lamp with a wire cage is visible in the upper left. The wall is white with horizontal wood paneling.

COMPLETE/COMPONENT
STOCKED PRODUCT
SPECIFICATION

Within this product specification section you will find the technical specification of each complete/component stocked product.

CONTENTS

Wardrobe cabinet specification	35
All pre-drilled holes	37
Corner cabinet fixing positions	38
Door drilling hinge position	39
Internal storage specification (Stackable drawers)	40
Classic Chests	41
Modern Chests	44

WARDROBE CABINET SPECIFICATION

WARDROBE CABINET SIZES:

SINGLE

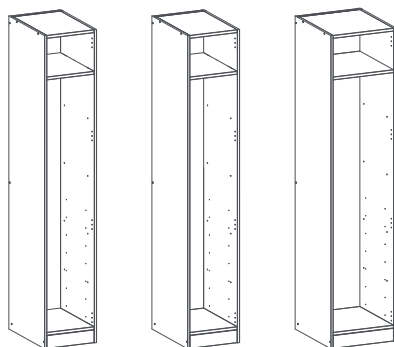

400mm

450mm

500mm

DOUBLE

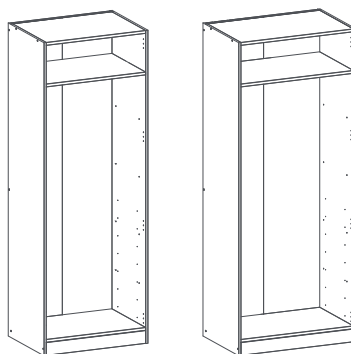

800mm

900mm

1000mm

CORNER

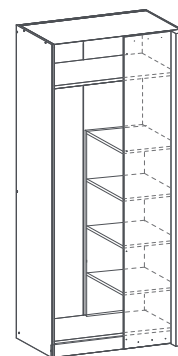

1000mm
(1150mm to allow for voids)

All wardrobes are supplied with Assembly Instructions.

CABINET SPECIFICATION:

- **18mm** Chipboard
- **2260mm** high (including structural plinth 100mm_
- Cabinet depth **610mm** (internal **558mm**, void at back **22mm**)
- Depth of internal space **560mm**
- Total depth including stocked door **610mm**
- Widths: **400 / 450 / 500 / 800 / 900 / 1000mm**
- Cabinet finish in foil wrapped textured linen effect (bespoke to PWS)
- 1 x 22mm thick matching textured linen shelf set at 278mm from the top of the cabinet
- 1 x brushed bronze effect hanging rail
- **8mm** linen effect back panel (clear silicone joint on reverse face of **800 / 900 & 1000mm** back panels)
- 4 x Metal height adjustable feet
- Vertical and horizontal assembly options
- CONFIRMAT screws with dowel construction
- Cabinets pre-drilled for hinge plates / shelving / hanging rails / internal stackable drawers from stocked selection
- Wardrobes come in 3 packs:

Pack 1 - 2 x 18mm end panels

Pack 2 - Wardrobe width pack: Top shelf, base & plinth 3 x cross rails for back panel, 1x brushed bronze hanging rail plus all fittings

Pack 3 - Wardrobe back panel: **8mm**

(Showing corner wardrobe shelf pack - sold separately. See page 2.16)

FEATURE STORAGE UNIT OFFER:

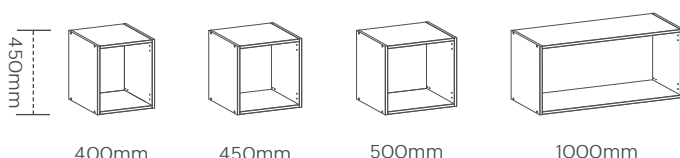

400mm

450mm

500mm

1000mm

- Standard wardrobe cabinet height: **2260mm**
- Standard wardrobe cabinet with feature storage unit height: **2710mm**

CABINET SPECIFICATION:

- **18mm** Chipboard
- **450mm** high
- Total depth including door 450mm
- Cabinet finish in foil wrapped textured linen effect
- CONFIRMAT and dowel construction
- Feature storage units come complete in 1 pack

WARDROBE CABINET SPECIFICATION

WARDROBE CABINET BREAKDOWN:

SINGLE / DOUBLE WARDROBE CABINET

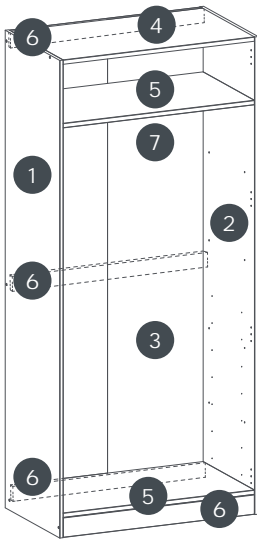

- 1 1 x 18mm left hand side panel (linen)
- 2 1 x 18mm right hand side panel (linen)
- 3 1 x 8mm back panel (linen)
- 4 1 x 22mm top (linen)
- 5 1 x 22mm shelf and 1 x base panel (linen)
- 6 4 x Structural batons (1 x acts as structural plinth / 3 x cross rail)
- 7 1 x bronze effect hanging rail

CORNER WARDROBE CABINET

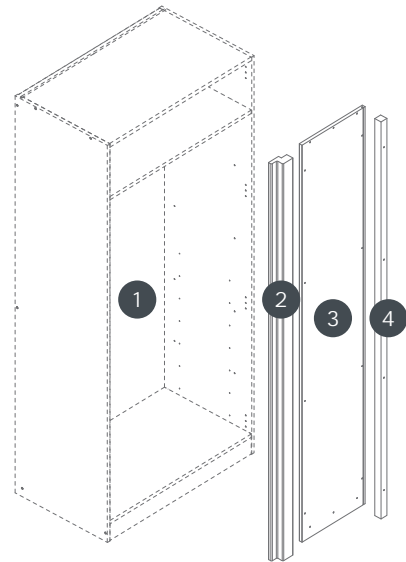

SINGLE / DOUBLE FEATURE CABINET

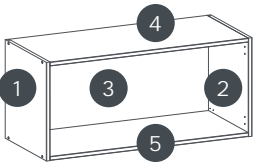

- 1 1 x 18mm left hand side panel (linen)
- 2 1 x 18mm right hand side panel (linen)
- 3 1 x 8mm back panel (linen)
- 4 1 x 18mm top (linen)
- 5 1 x 18mm base panel (linen)

- 1 1000mm double wardrobe
 - 2 Corner post 2260mm (H)
 - 3 Blanking panel (linen)
 - 4 Spacer Rail (raw chipboard)
- Corner Conversion Kit

(For corner wardrobe shelf pack please see page 2.16)

ASSEMBLY OF ROBE:

Before assembling the wardrobe cabinets, it is essential that the overall room height and floor space is determined. Horizontal assembly requires a minimum ceiling height of 2336mm and a minimum floor space (Length) of 4600mm in order to insert the back panel. If you are assembling in a small space, it is recommended that you follow the vertical assembly instructions providing you have a minimum ceiling height of 2300mm. Horizontal and vertical assembly guidelines can be found in the assembly instructions.

HORIZONTAL ASSEMBLY:

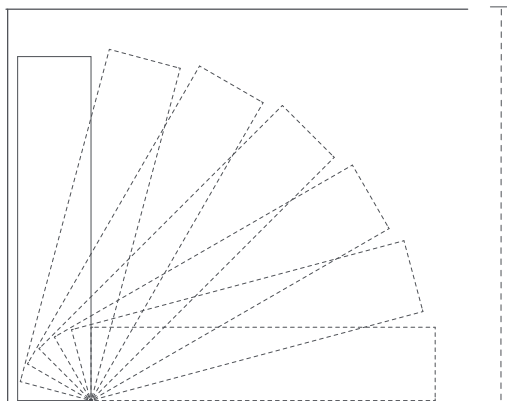

Minimum Ceiling Height: 2336mm

If cornice is to be applied minimum height requirement:

Modern 2366mm
Classic 2406mm

Minimum Floor Space: 4600mm

VERTICAL ASSEMBLY:

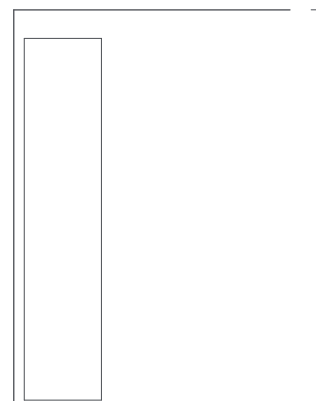

Minimum Ceiling Height: 2300mm

If cornice is to be applied minimum height requirement:

Modern 2330mm
Classic 2350mm

Vertical assembly requires an additional ceiling height clearance of 30mm for Modern cornice and 50mm for Classic cornice.

Horizontal assembly requires a clearance of 76mm in order to lift the wardrobe into an upright position. If cornice is to be applied, additional ceiling height is required depending on cornice style.

ALL PRE-DRILLED HOLES

All wardrobe cabinets (single and double) have the same side panel dimensions and drilling positions. Wardrobe cabinets are pre-drilled with 3mm diameter holes for internal pre-drilled holes that suit a variety of functions.

The below diagram illustrates the hole position with details of each function, please refer to key below. Subsequent pages contain details with critical dimensions relevant to each function

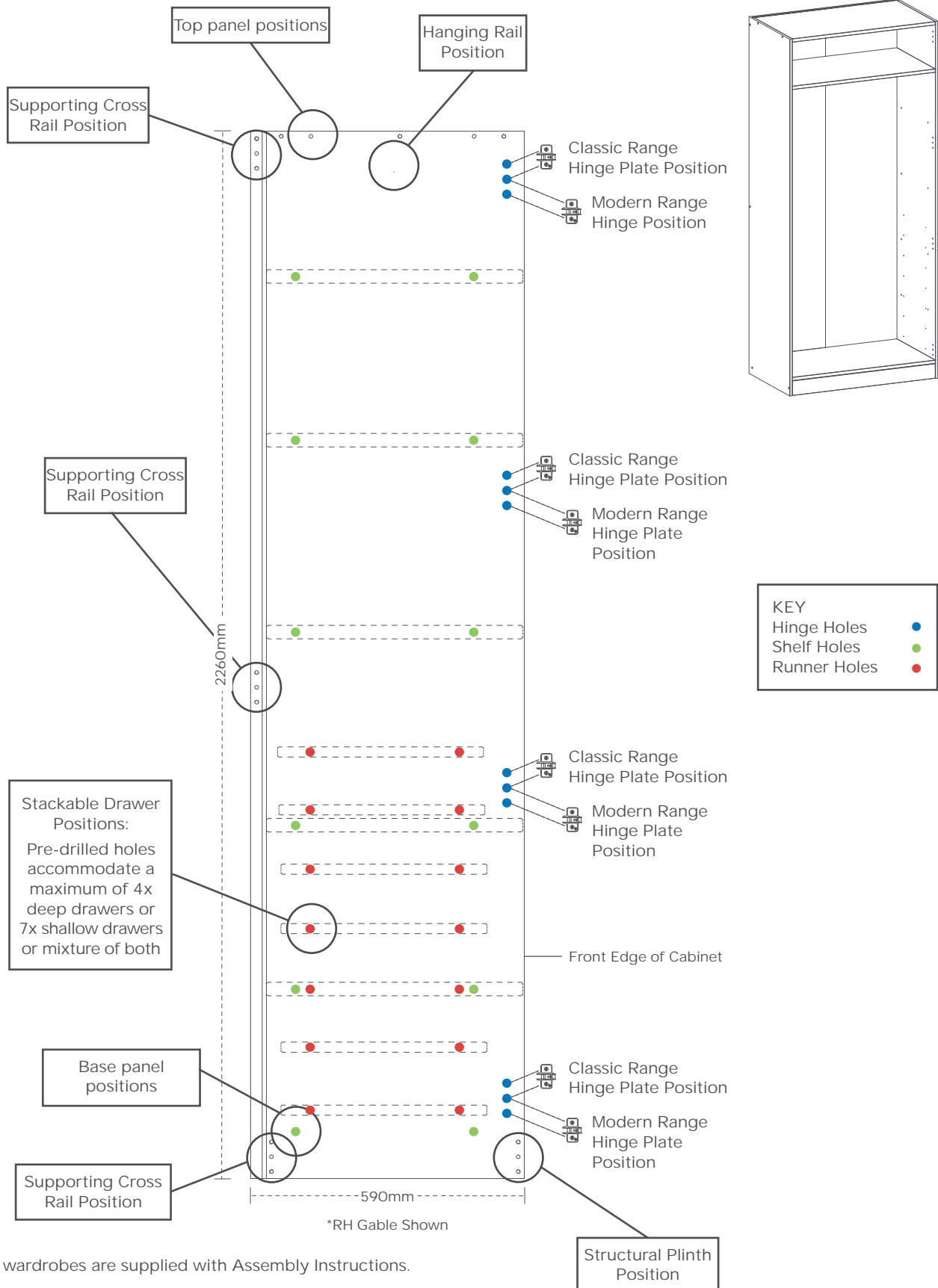

All wardrobes are supplied with Assembly Instructions.

CORNER CABINET FIXING POSITIONS

The blanking panel supplied with a corner wardrobe conversion kit comes pre-drilled for fixing.

The door supplied with a corner wardrobe bundle is drilled to fix to the wardrobe carcass - not the corner post

The corner post is fixed.

The spacer rails are also pre-drilled to align with the drilling positions on the blanking panel. The blanking panel is not handed and can therefore be flipped to accommodate left and right hand scenarios.

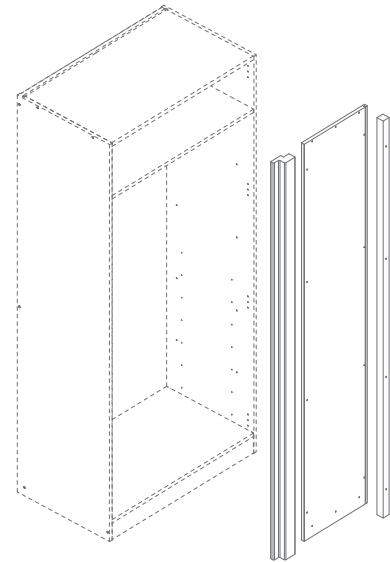
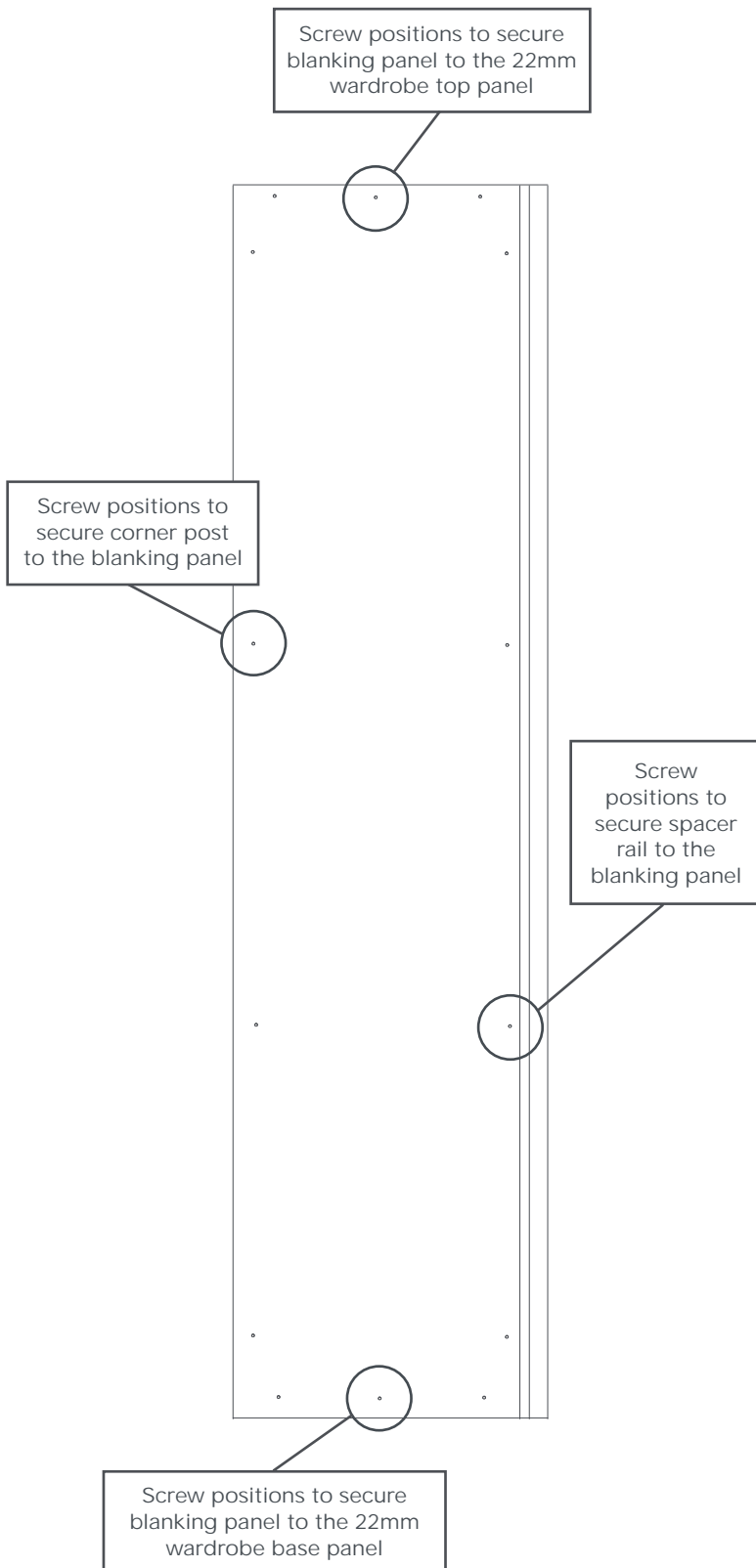

CORNER POST DIMENSIONS

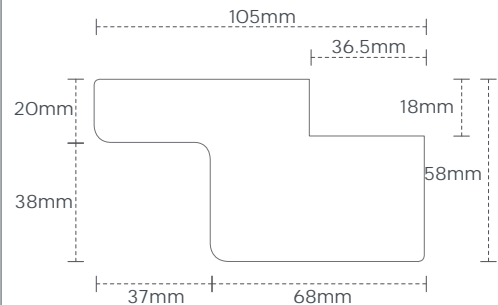

CORNER CONFIGURATION EXAMPLE

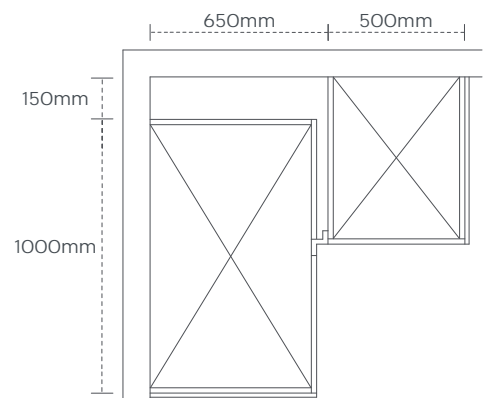

DOOR DRILLING/HINGE POSITION

CLASSIC STOCKED DOORS

Chapter, Origin

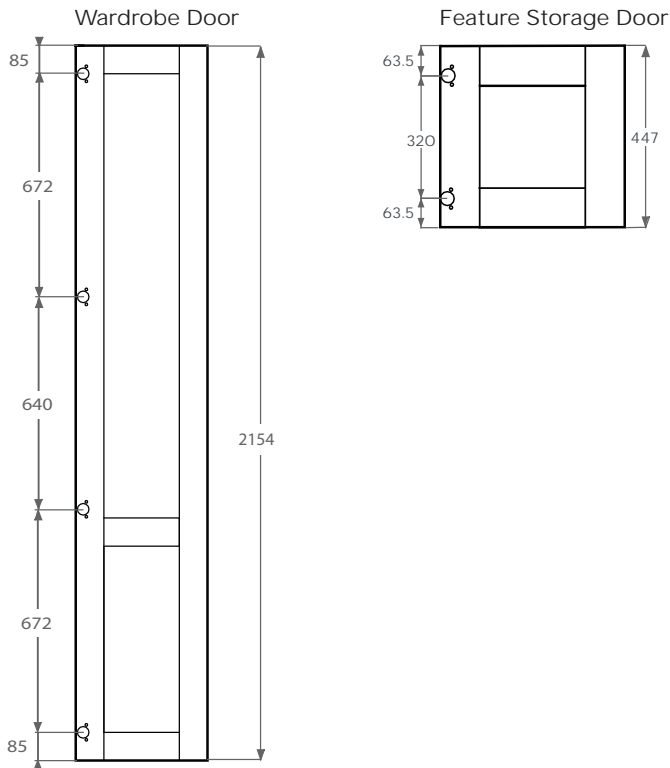

Door pre-drilled for Blum EXPANDO hinge see page 5.06 for our recommended range

MODERN STOCKED DOORS

Flow, Sculpt, Esker, Parity, Feature Mirror, Feature Glass, Feature Walnut

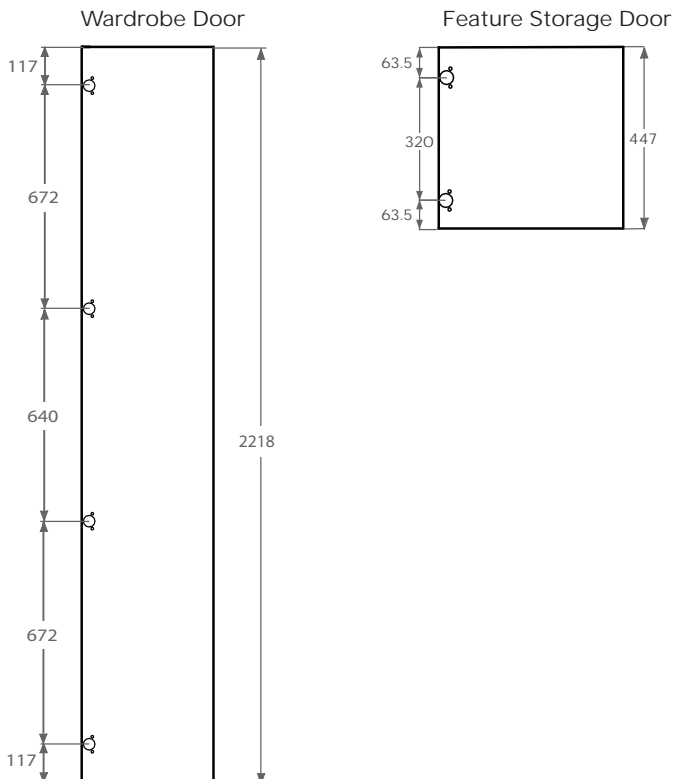

Detailed drillings are shown below

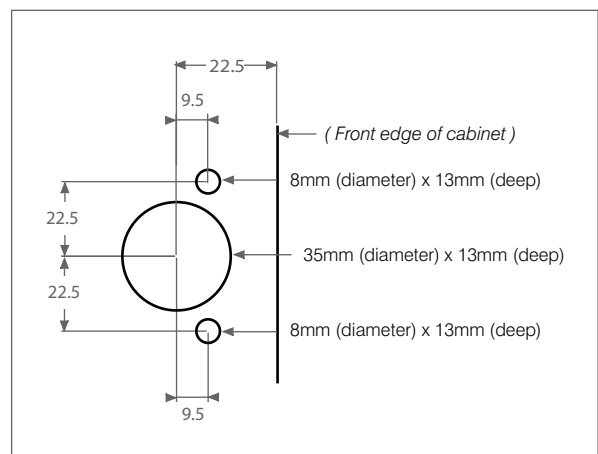

INTERNAL STORAGE SPECIFICATION

STACKABLE INTERNAL DRAWERS

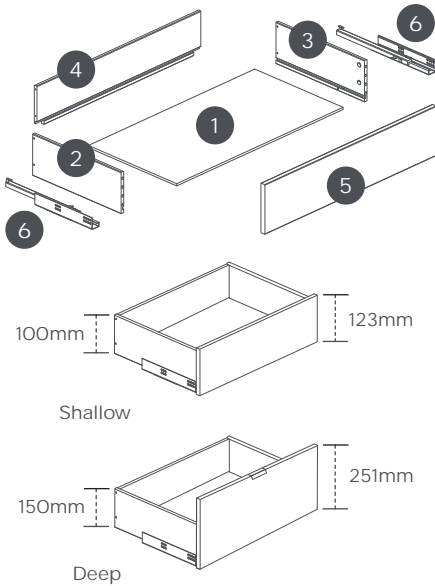

- Assembly required
- Drawer box 12mm thick
- Drawer box kits available to suit: 500 / 800 / 900 / 1000mm wardrobe widths
- Drawer boxes with drawer fronts fitted total 468mm deep
- 8mm thick bases in drawer boxes
- Drawer box and runners depth 450mm
- Drawer front 18mm thick
- Drawers available to suit: 500 / 800 / 900 / 1000mm wardrobe widths see chart below for more information
- Drawer front available in two heights: 123 / 251mm
- Cam and dowel construction
- Drawer fronts available in 3 finishes: Linen / Walnut / Textured Oak
- Brushed bronze handle included - adds 2mm to height of drawer front

- 1 Drawer base panel
- 2 Drawer left side panel
- 3 Drawer right side panel
- 4 Drawer back panel
- 5 Drawer frontal
- 6 Soft close drawer runners

SHALLOW

WARDROBE SIZE	DRAWER FRONT DIMENSIONS
500	L 414mm x H 123mm D x 18mm
800	L 714mm x H 123mm D x 18mm
900	L 814mm x H 123mm D x 18mm
1000	L 914mm x H 123mm D x 18mm

- Drawer box and frontal total 468mm deep
- Brushed bronze handle adds 2mm onto drawer front height

DEEP

WARDROBE SIZE	DRAWER FRONT DIMENSIONS
500	L 414mm x H 251mm D x 18mm
800	L 714mm x H 251mm D x 18mm
900	L 814mm x H 251mm D x 18mm
1000	L 914mm x H 251mm D x 18mm

- Drawer box and frontal total 468mm deep
- Brushed bronze handle adds 2mm onto drawer front height

CHESTS

CLASSIC | CHEST SPECIFICATIONS

Chests are supplied with option of **ASSEMBLED** or **FLAT PACKED**

Flat packed option, tops are supplied separately.

2 DRAWER BEDSIDE

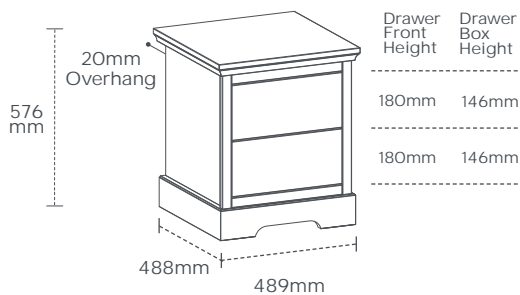

- Chest dimensions (including top profile): H 576 x W 489 x D 488mm (with 20mm overhang at back)
- Available assembled or unassembled
- Blum soft close drawer runners
- Alfatherm foil - woodgrain/paint effect
- Available finishes: Partridge Grey / Porcelain / Stone / Oak Effect
- Matching or textured Oak effect top options available
- Drawer boxes are finished in linen effect foil
- 8mm thick drawer box bases
- Small drawer takes 4.8kg load capacity

3 DRAWER BEDSIDE

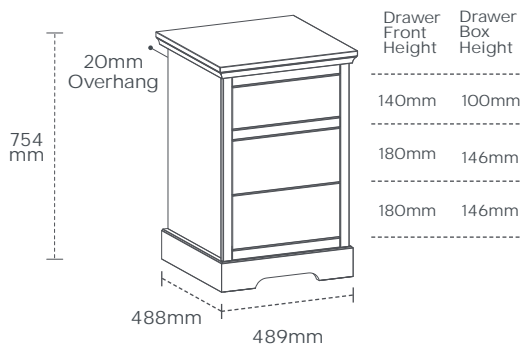

- Chest dimensions (including top profile): H 754 x W 489 x D 488mm (with 20mm overhang at back)
- Available assembled or unassembled
- Blum soft close drawer runners
- Alfatherm foil - woodgrain/paint effect
- Available finishes: Partridge Grey / Porcelain / Stone / Oak Effect
- Matching or textured Oak effect top options available
- Drawer boxes are finished in linen effect foil
- 8mm thick drawer box bases
- Small drawer takes 4.8kg load capacity

All chests are supplied with Assembly Instructions.

2 + 2 CHEST

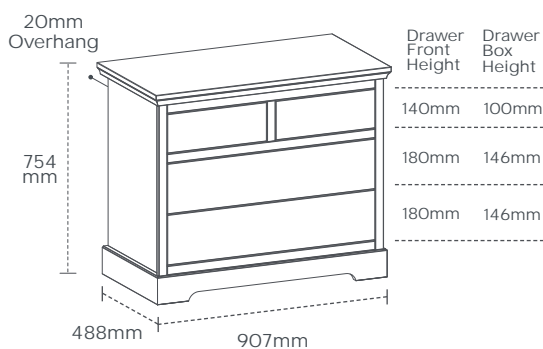

- Chest dimensions (including top profile): H 754 x W 907 x D 488mm (with 20mm overhang at back)
- Available assembled or unassembled
- Blum soft close drawer runners
- Alfatherm foil - woodgrain/paint effect
- Available finishes: Partridge Grey / Porcelain / Stone / Oak Effect
- Matching or textured Oak effect top options available
- Drawer boxes are finished in linen effect foil
- 8mm thick drawer box bases
- Small drawer takes 4.8kg load capacity
- Large drawer takes 9kg load capacity

4 + 2 CHEST

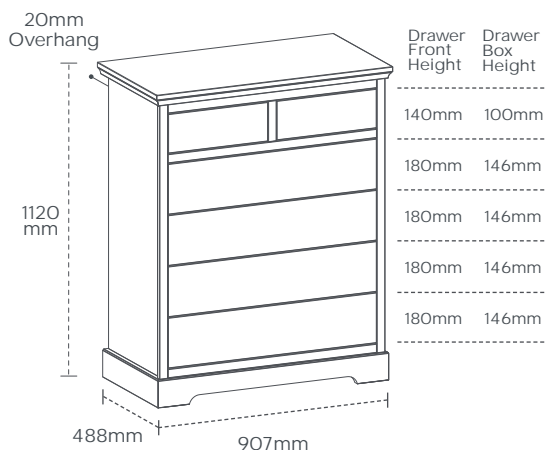

- Chest dimensions (including top profile): H 1120 x W 907 x D 488mm (with 20mm overhang at back)
- Available assembled or unassembled
- Blum soft close drawer runners
- Alfatherm foil - woodgrain/paint effect
- Available finishes: Partridge Grey / Porcelain / Stone / Oak Effect
- Matching or textured Oak effect top options available
- Drawer boxes are finished in linen effect foil
- 8mm thick drawer box bases
- Small drawer takes 4.8kg load capacity
- Large drawer takes 9kg load capacity

DRESSING TABLE

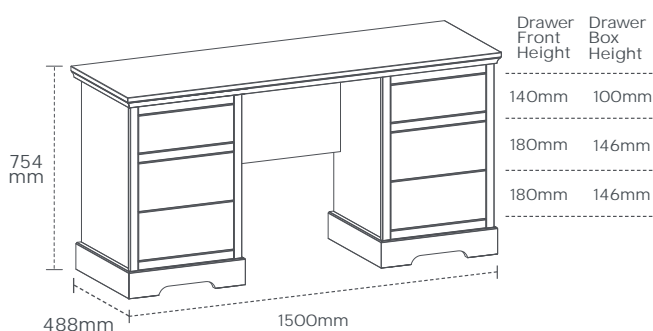

- Chest dimensions (including top profile): H 754 x W 1500 x D 488mm
- Available assembled or unassembled
- Blum soft close drawer runners
- Alfatherm foil - woodgrain/paint effect
- Available finishes: Partridge Grey / Porcelain / Stone / Oak Effect
- Matching or textured Oak effect top options available
- Unique dressing table profiled top (no cutting required)
- Modesty panel included (supplied with brackets colour matched to top)
- 566mm wide leg space
- Modesty panel and dressing table top are supplied in matching colours

DRESSING TABLE CONVERSION COMPONENTS

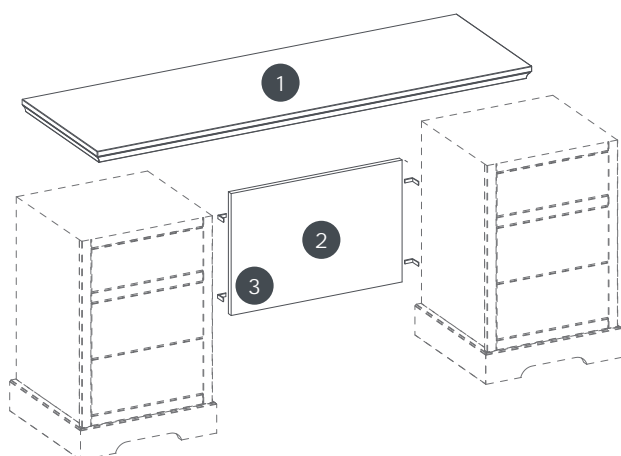

- 1 Dresser profiled top (no cutting required)
- 2 Modesty panel (matching colour top)
- 3 Brackets provided

CHESTS

CUSTOM FIT Desk

(For desk application)

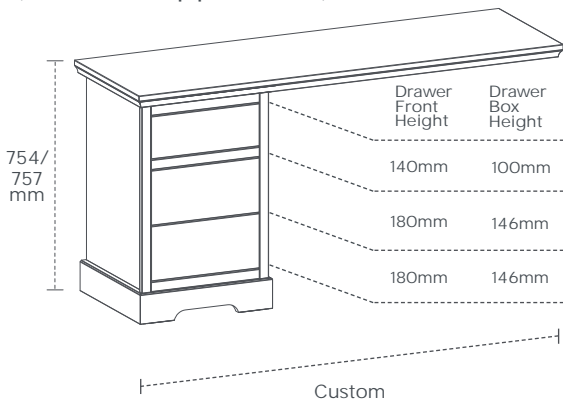

TO COMPLETE THE CUSTOM FIT DESK:

- 3 drawer chest with top
- Dressing table profiled top (cutting required)
- Colour matched desk top W 2400 x D 650 x H 19mm
Overall height of desk with colour matched top 754 mm and coving profile included (cutting required)
- Oak effect table top W 2260 x D 750 x H 22mm Overall height of desk with colour matched top 757 mm and coving profile included (cutting required)
- Available finishes: Partridge Grey / Porcelain / Stone / Oak Effect
- No modesty panel

Colour Matched Top



Textured Oak Top



All chests are supplied with Assembly Instructions.

TOP (for desk application)

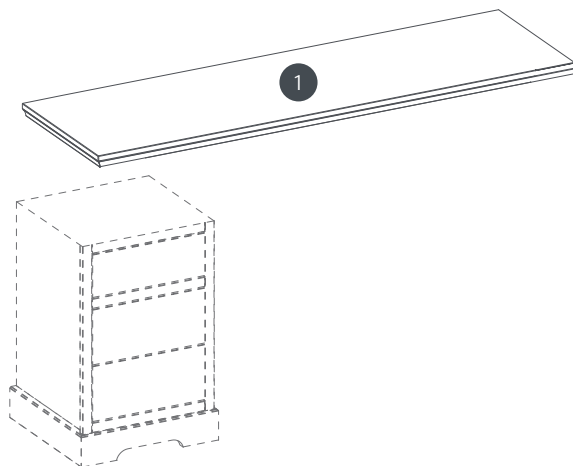

CUSTOM FIT TOP COMPONENT LIST:

- 1x choice of desk top
- 1x coving strip
- 1x MDF filler
- 1x edge banding strip

Coloured top: 2400 x 650 x 19mm

Oak top: 2260 x 750 x 22mm

(supplied with coving strip)

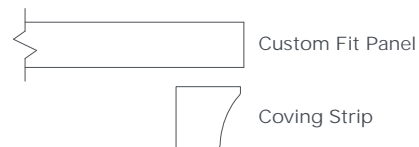

MODERN | CHEST SPECIFICATIONS

All Modern chests are supplied ASSEMBLED and have handles included in the price.

3 DRAWER BEDSIDE

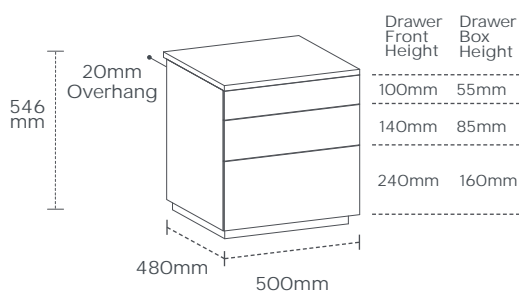

- Chest dimensions: H 546 x W 500 x D 482mm (including 20mm overhang at back)
- Supplied assembled
- Blum soft close drawer runners
- Solid 36mm MDF plinth base
- Chest top and side panels are only available in Matt finishes
- Drawer fronts are available in Matt & selected Gloss finishes
- Chests and drawer frontals are painted polyurethane finish
- Drawer boxes are finished in linen effect foil
- 4mm thick drawer box bases
- Small drawer takes 11kg load capacity
- Large drawer takes 23.8kg load capacity

4 DRAWER CHEST

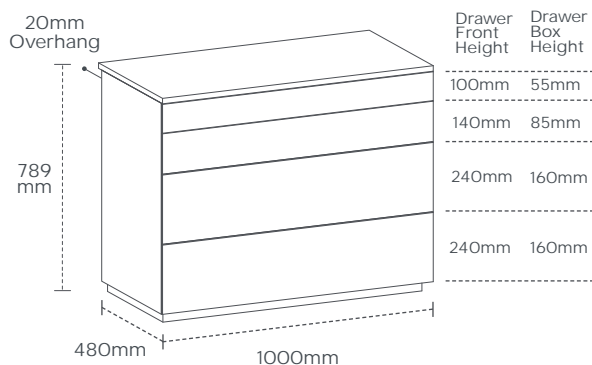

- Chest dimensions: H 789 x W 1000 x D 482mm (including 20mm overhang at back)
- Supplied assembled
- Soft close Blum drawer runners
- Solid 36mm MDF plinth base
- Chest top and side panels are only available in Matt finishes
- Drawer fronts are available in Matt & selected Gloss finishes
- Chests and drawer frontals are painted polyurethane finish
- Drawer boxes are finished in linen effect foil
- 4mm thick drawer box bases
- Small drawer takes 11kg load capacity
- Large drawer takes 23.8kg load capacity
- Strengthening metal strip on underside of top

SLIDING WARDROBE SPECIFICATION



Within this sliding wardrobe specification section you can find the key information needed when installing a sliding wardrobe. If you require any additional information please speak to a member of the sales team for our full installation guide.

CONTENTS

Sliding wardrobe information	47
— Overview	47
— Adjustment	47
— Soft close quantity options	47
— Fixing the door positioners	48
— Positioner dimensions	48

SLIDING WARDROBE INFORMATION

OVERVIEW

Typical Sliding Wardrobe Door Layout

- A Top Liner
- B Top Track
- C Liners
- D Sliding Doors
- E Bottom Track
- F Bottom Liner
- G End Panel (optional depending on design)

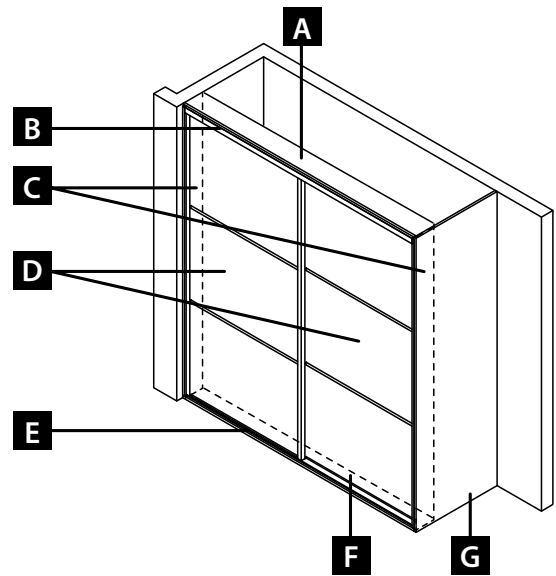

ADJUSTMENT

Bottom roller

The bottom roller can be adjusted using the allen key provided by turning the adjustment bolt through the hole in the side profile.

- To move the doors down – turn anti-clockwise
- To move the doors up – turn clockwise
- After adjustment, plug the hole with the plastic hole covers provided.

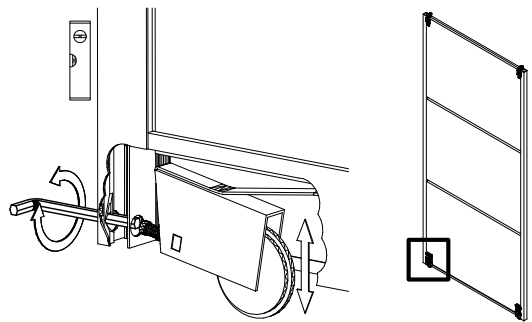

SOFT CLOSE QUANTITY OPTIONS

Soft close mechanisms will come fitted to the top of your doors. You can choose how many soft close pairs you require depending on how many doors are in your design.

Each mechanism requires a liner, wall or end panel to work against.

The maximum number of doors possible in a two-track arrangement using soft closers is four (two front doors and two rear doors). In 5-door arrangements the central door cannot be fitted with a soft close mechanism.

The diagram opposite shows the positions of the soft close mechanisms, depending upon which door arrangement is ordered so you can add the correct quantity to your order.

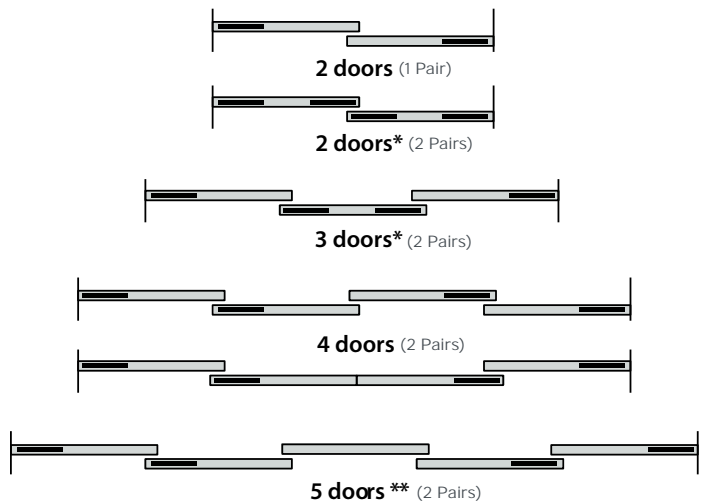

SLIDING WARDROBE INFORMATION

FIXING THE DOOR POSITIONERS

Bottom track door positioners

Aluminium door positioners need to be inserted into the bottom track.

Pull the doors to the closed position and mark on the bottom track the centre point between the doors. Slide the door positioners along the front and rear channels until the centre of each is at the centre point you have marked on the track. No screwing is necessary. For multi-door arrangements refer to the diagram opposite for correct placing of the door positioners. Or use the table below for dimensions.

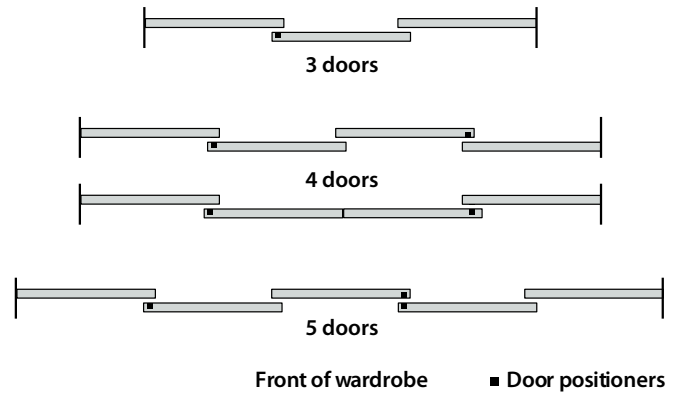

POSITIONER DIMENSIONS

Depending on the frame profile you have chosen will depend on the dimension the door positioner will need to be in relation the liner, wall or end panel.

Use the below table to find the dimension required for the frame type you are using.

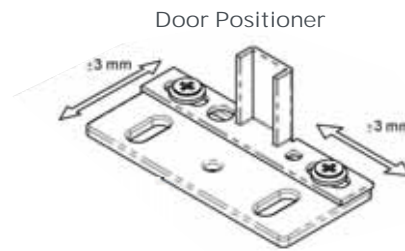

DIMENSION GUIDE	
Frame type	Dimension
Figure	145mm
Prism	150mm
Curve	120mm
Shape	120mm
Cube	125mm

Dimension example (Cube)

TRACK BACK

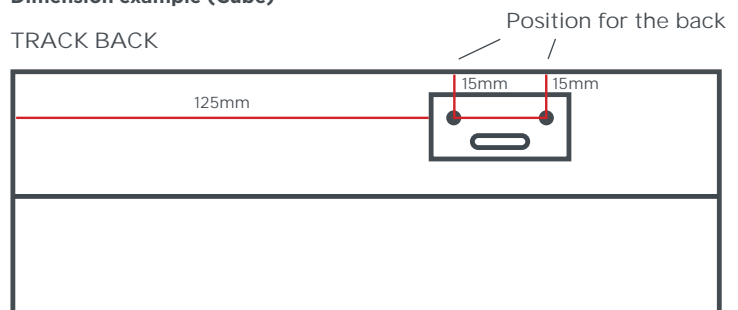

TRACK FRONT

CABINET DETAIL FOR MANUFACTURERS



If you choose to manufacture your own cabinet to use alongside our stocked doors we have collated the relevant technical information to create a cabinet in the same specification as our stocked Linen wardrobe.

CONTENTS

Wardrobe cabinet specification	51
Drilling specification	53
Corner cabinet conversion	54
Cabinet drilling	55
— Hinges & shelves	55
— Runners	56

WARDROBE CABINET SPECIFICATION

To create a wardrobe cabinet the same specification as our stocked Linen wardrobe please use the below points.

WARDROBE CABINET SIZES:

SINGLE

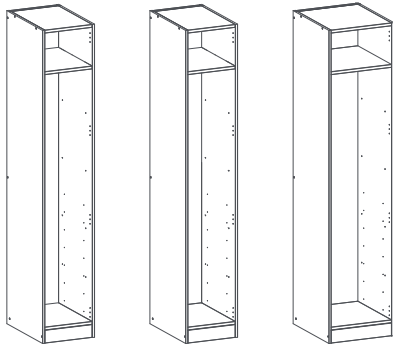

400mm

450mm

500mm

DOUBLE

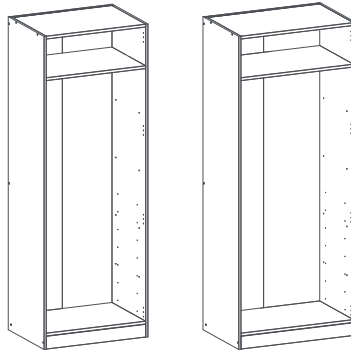

800mm

900mm

1000mm

CORNER

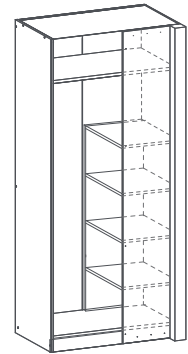

1000mm
(1150mm to allow for voids)

(Showing corner wardrobe shelf pack - sold separately. See page 2.16)

RECOMMENDED CABINET SPECIFICATION:

- 18mm Chipboard
- 2260mm high (including structural plinth 100mm)
- Cabinet depth 610mm (internal 558mm, void at back 22mm)
- Depth of internal space 560mm
- Total depth including stocked door 610mm
- Widths: 400 / 450 / 500 / 800 / 900 / 1000mm
- 1 x 22mm thick shelf set at 278mm from the top of the cabinet
- 8mm back panel
- 4 x Metal height adjustable feet

FEATURE STORAGE UNIT:

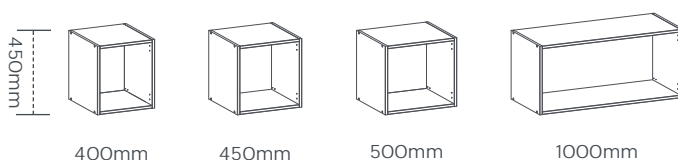

400mm

450mm

500mm

1000mm

RECOMMENDED CABINET SPECIFICATION:

- 18mm Chipboard
- 450mm high

WARDROBE CABINET SPECIFICATION

WARDROBE CABINET BREAKDOWN:

SINGLE / DOUBLE WARDROBE CABINET

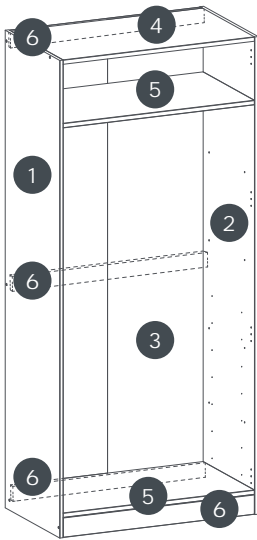

- 1 1 x 18mm left hand side panel
- 2 1 x 18mm right hand side panel
- 3 1 x 8mm back panel
- 4 1 x 22mm top
- 5 1 x 22mm shelf and 1 x base panel
- 6 4 x Structural batons (1 x acts as structural plinth /3 x cross rail)

CORNER WARDROBE CABINET

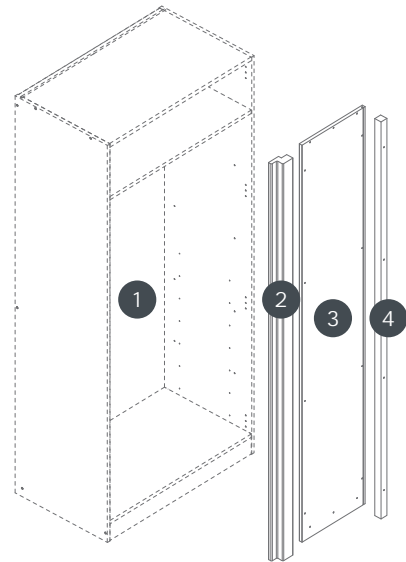

- 1 1000mm double wardrobe
 - 2 Corner post 2260mm (H)
 - 3 Blanking panel (linen)
 - 4 Spacer Rail (raw chipboard)
- } Corner Conversion Kit

SINGLE / DOUBLE FEATURE CABINET

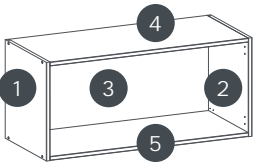

- 1 1 x 18mm left hand side panel
- 2 1 x 18mm right hand side panel
- 3 1 x 8mm back panel
- 4 1 x 18mm top
- 5 1 x 18mm base panel

(For corner wardrobe shelf pack please see page 2.16)

DRILLING SPECIFICATION

Our wardrobe cabinets are pre-drilled with 3mm diameter holes for internal pre-drilled holes that suit a variety of functions. The below diagram illustrates the hole position with details of each function, please refer to key below. Subsequent pages contain details with critical dimensions relevant to each function

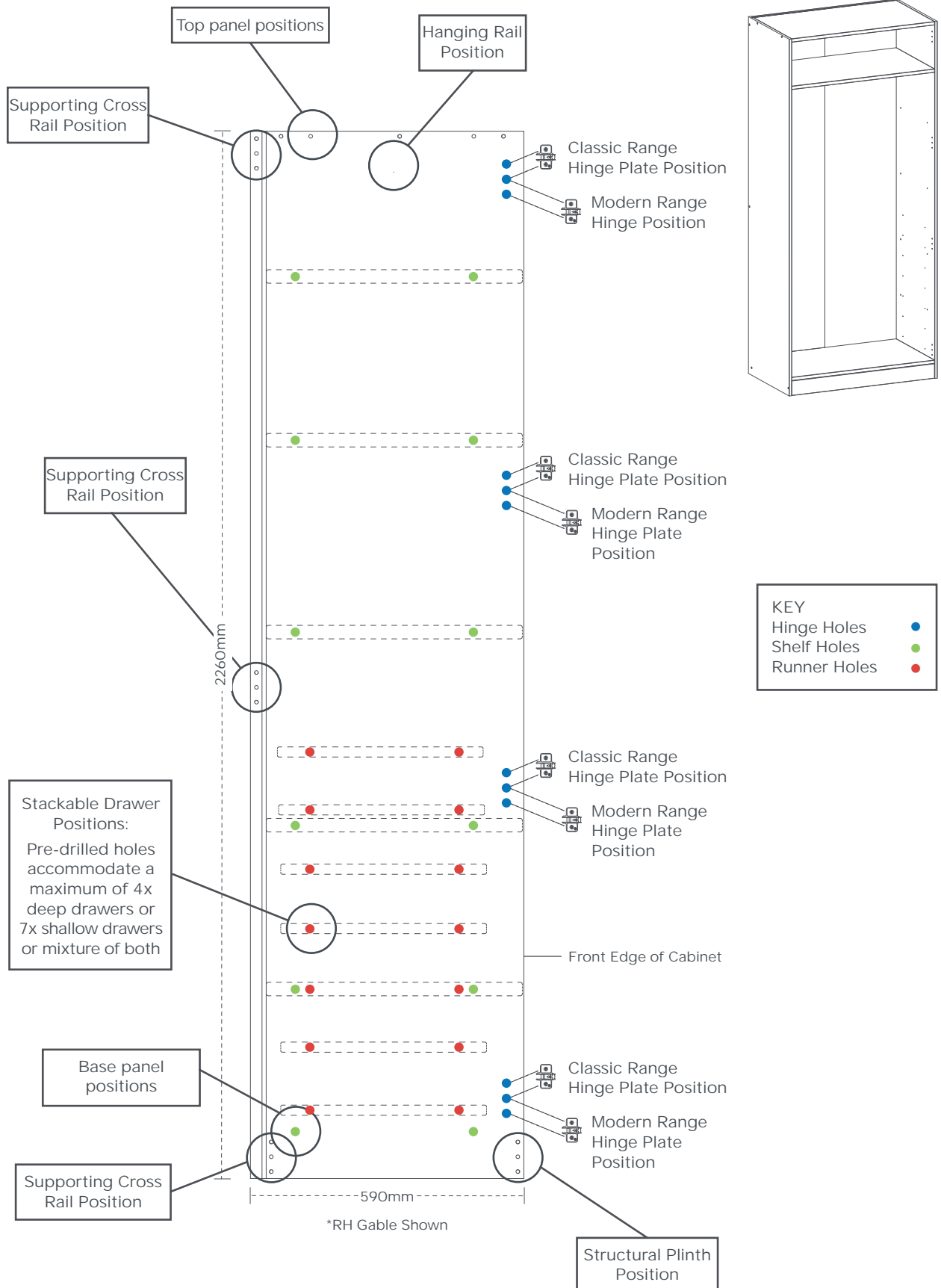

CORNER CABINET CONVERSION

We use a 22mm blanking panel and corner post to convert double robes into a corner wardrobe.

The door used on a corner wardrobe should be hinged from the wardrobe cabinet - not the corner post.

The corner post should be fixed and spacer rails used.

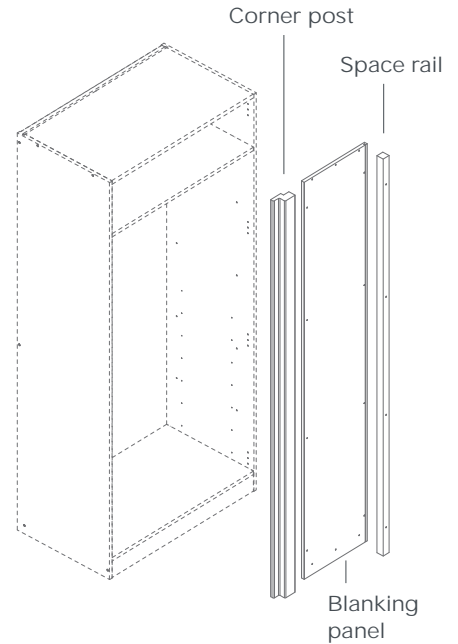
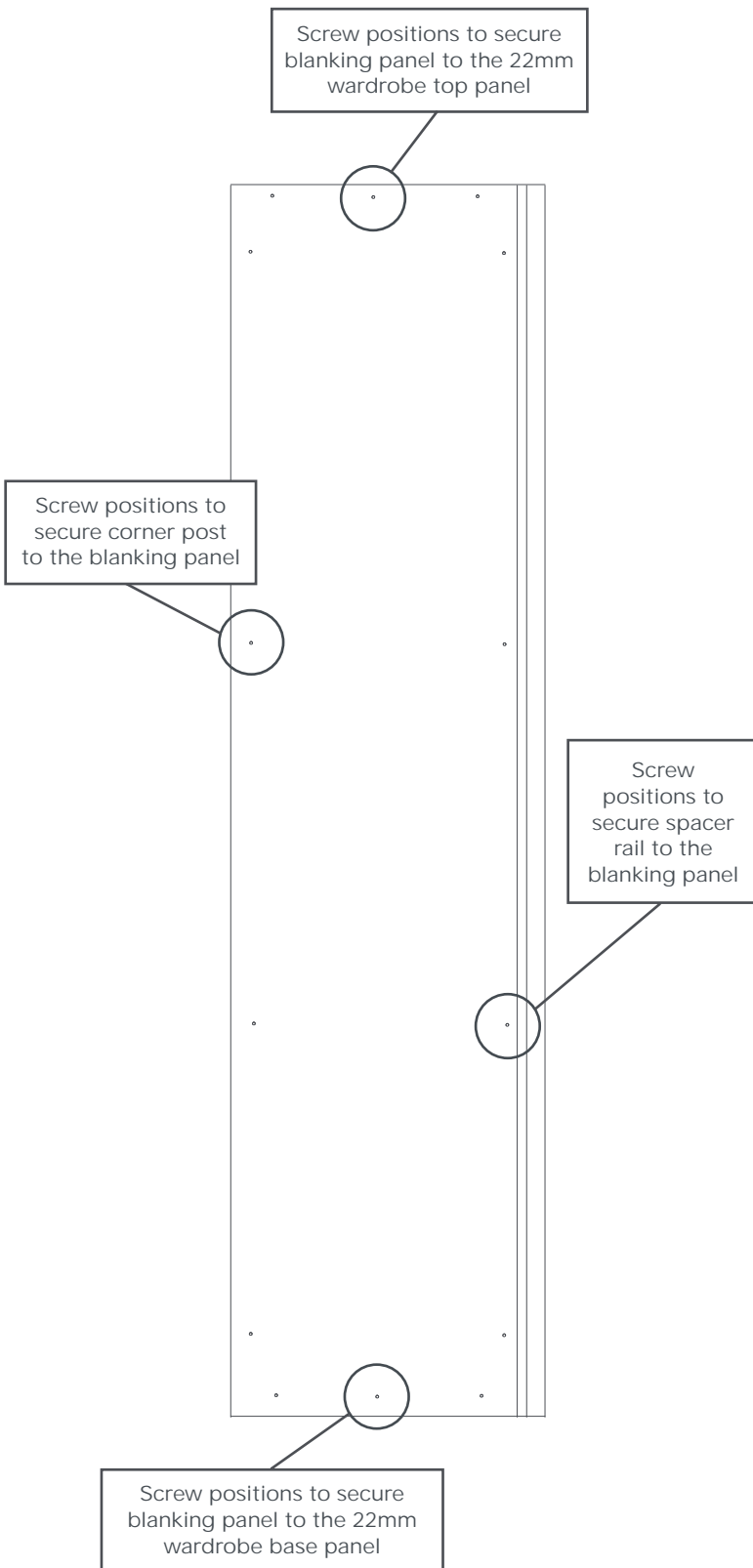

CORNER POST DIMENSIONS

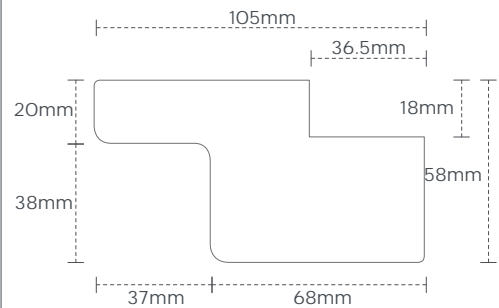

CORNER CONFIGURATION EXAMPLE

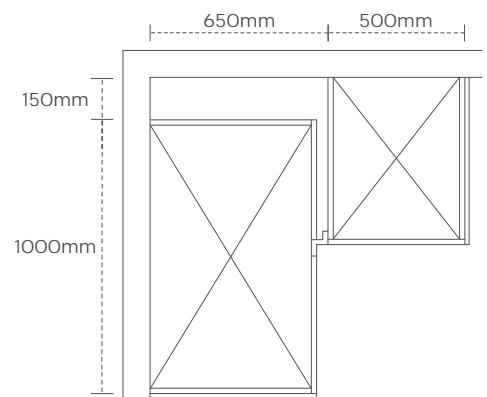

CABINET DRILLING

HINGE POSITIONS

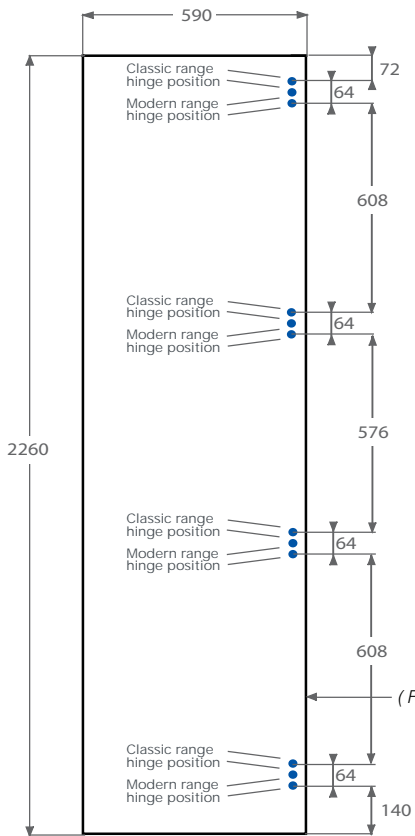

The drawings show the hinge drilling positions required to work with our pre-drilled frontal.

Please note: There are different drilling positions required for a modern frontal and a classic frontal.

Detailed drillings are shown below

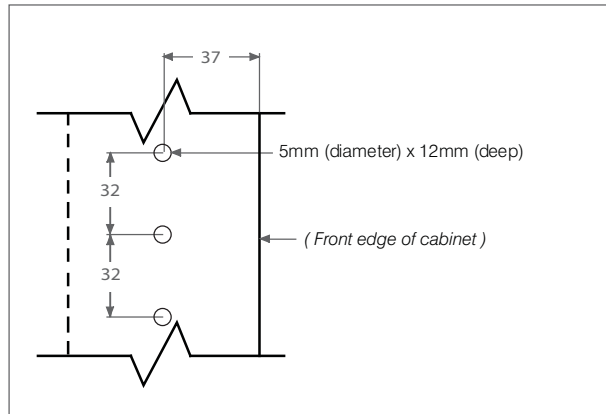

SHELVES

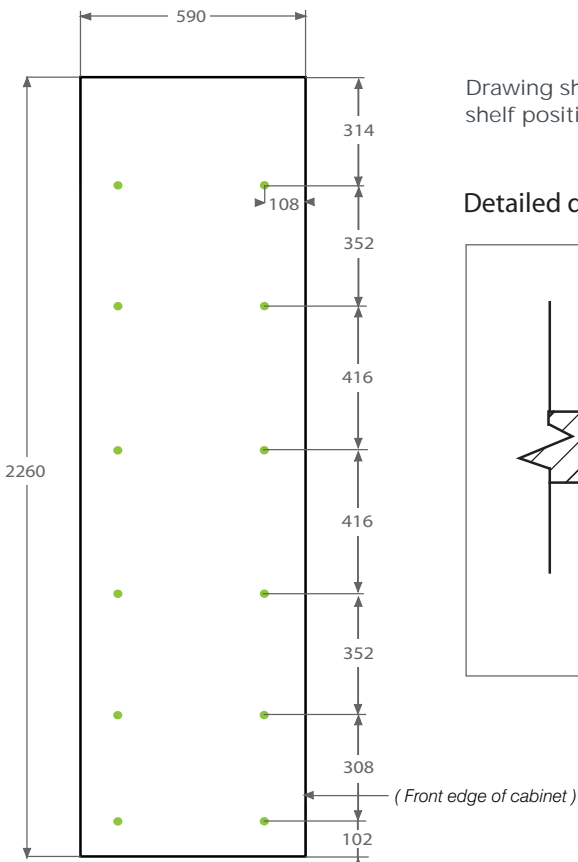

Drawing shows dimensions for our pre-drilled internal shelf positions.

Detailed drillings are shown below

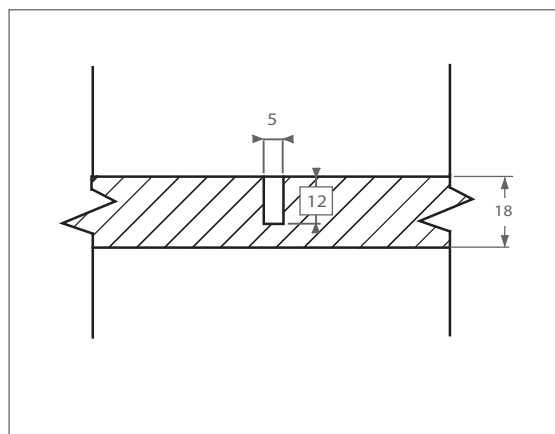

CABINET DRILLING

DRAWER RUNNERS, FOR STACKABLE DRAWERS

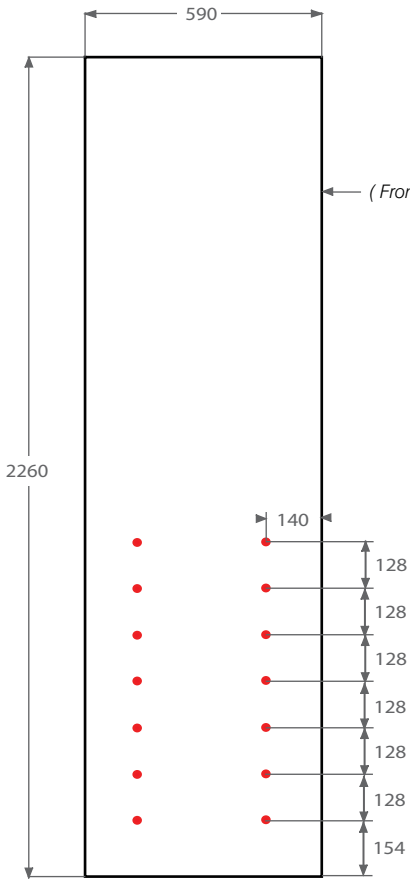

The drawing shows drilling required for a series of internal drawer combinations.

Detailed drillings are shown below

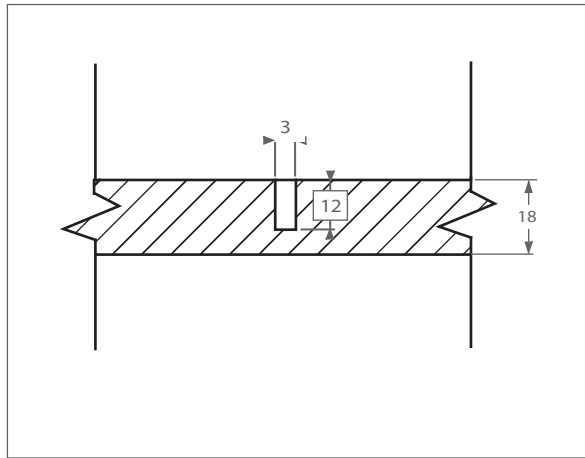



PHOTOGRAPHY: SCULPT SHOWN IN SAGE PAINT-TO-ORDER



IMPORTANT NOTICE



Colour reproduction

We take great care in the photography of products illustrated. Due to variables between photographic and print processes, colours and shades may vary from the actual product supplied.

Marketing policy

In line with our company policy of continuous improvement, we reserve the right to alter, amend or re-specify any product illustrated without prior notice.

Lifestyle imagery

Use of PWS Distributors Limited photographs and images:
We are able to supply photographs and images featuring PWS products (eg bedroom set shots, individual product shots) for customers to use in their own promotional material under licence from us. However, the copyright for our lifestyle photography is restricted under licence for use by PWS only, and therefore we are constrained by the licence contract and are unable to supply model shots for third party use.

Permission to use PWS Distributors Limited photographs and images
You may only use photographs and images of PWS Distributors Limited products or which in some other way relate to the business of PWS (eg photographs of our distribution centre or our vehicles) in good faith and in connection with the promotion and sale of products supplied or to be supplied by PWS. You may not use any such photograph or image for any other reason or purpose.

Copyright Notice

Photographs and images supplied or made available by PWS are copyright works. All rights in them are reserved whether arising under the national laws of any country, any international treaty or convention, or in any other way. The copyright and all other rights in such photographs and images are owned by PWS Distributors Limited. The photographs and images may not be used, reproduced, transmitted, stored in any form or by any means without the prior written permission of PWS Distributors Limited, except as permitted by any law and then only to the extent strictly permitted by such law. PWS Distributors Limited asserts all its rights in or relating to such photographs and images and the copyright in them to the fullest extent possible in all parts of the world.

(c) PWS Distributors Limited

DELIVERY

Standard delivery of goods works on a 48/72 hour delivery service from dispatch and applies to all products delivered within mainland UK.

Orders for stocked products placed before 5pm will be dispatched within 48/72 hours from receipt of your order confirmation. Delivery for non-stocked and processed products (such as paint-to-order or bespoke sizes) are subject to advertised lead times.

ORDER COLLECTION

Collection of goods from our Trade Counter in Newton Aycliffe can be arranged through the customer centric team. Pre-arranged collection slots are also available when you order online at www.pws.co.uk.

Collections by third-party carriers are not permitted.

Minimum order values, carriage terms and charges are stated at the time of order.

REPUBLIC OF IRELAND AND NORTHERN IRELAND

A separate form of this information is available for Republic of Ireland, please contact customer services.

UK GLOBAL TARIFF (UKGT)

Due to new Rules of Origin regulations related to the UK's Trade and Co-operation Agreement with the EU, it is possible that some of our items may incur tariffs in the future. In such instances, PWS reserves the right to pass any such tariffs onto the customer.

UK OUTSIDE MAINLAND UK, INCLUDING OFFSHORE

Orders for delivery outside mainland UK, excluding Republic of Ireland, will be charged carriage at cost and advised prior to despatch.

HIGHLANDS & ISLANDS, OFFSHORE MAINLAND UK

Carrier services to these areas are normally extended and their premium services not always available. Whilst the Company will despatch in accordance with your requests, delivery services may be extended. Please contact customer services for further information, including price.

ITEMS TO FOLLOW

Customers will be advised of any items to follow and the expected availability date.

MINIMUM ORDER AND BOX QUANTITIES

Please note we cannot despatch less than box quantities of screws, priced per unit and not per box. Where possible there is no minimum order quantity.

ENHANCED PREMIUM SERVICE

PWS Bedroom Collection are pleased to offer an enhanced delivery service, which can be made direct to the consumers home if required:

- All orders will benefit from a delivery pre-call confirming AM/PM.
- A further call will be made on the day within the final hour of delivery.
- Delivered to room of choice (up to 3rd floor).

Additional delivery costs apply.

Your one-stop-shop
www.pws.co.uk

PWS

PWS Distributors Ltd
PO BOX 20, Station Road
Aycliffe Business Park
Newton Aycliffe
Co. Durham DL5 6XJ, UK

T: +44(0)1325 505599
E: sales-support@pws.co.uk
www.pws.co.uk/bedrooms

