



Roll Alignment

Parallelism measurement and alignment of rolls and other objects

E970

ROLL ALIGNMENT THE EASY WAY

EASY-LASER® E970 PARALLELISM

For parallelism measurement of rolls and other objects in numerous applications. Any chosen object or the baseline can be used as a reference. For rolls with diameter 40 mm [1.6"] and larger. Maximum measurement distance with a standard system is 80 metres [260 feet]. Easy-Laser® E970 is a very versatile system. You can also use it to measure level, straightness and flatness on wire sections (suction boxes), flatness on bases and straightness on rolls. With a few accessories you can also perform shaft alignment. This makes Easy-Laser® a very cost effective solution for your maintenance department.



MEASUREMENT METHOD

This system use the traditional method where the laser beam (reference) is pointed alongside the machine, and then deflected 90° towards the detector on the measurement object by a penta prism. Measurement values for the horizontal position are registered in both ends of the object. The included precision level is used for the vertical position.

Rolls is the most common example of objects where parallelism measurement is crucial for highest machine performance. Some other examples are shown below.

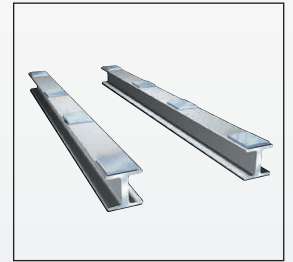
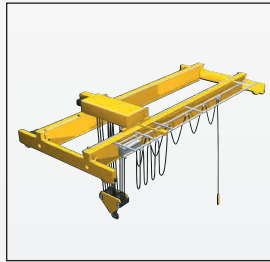

PARALLELISM MEASUREMENT

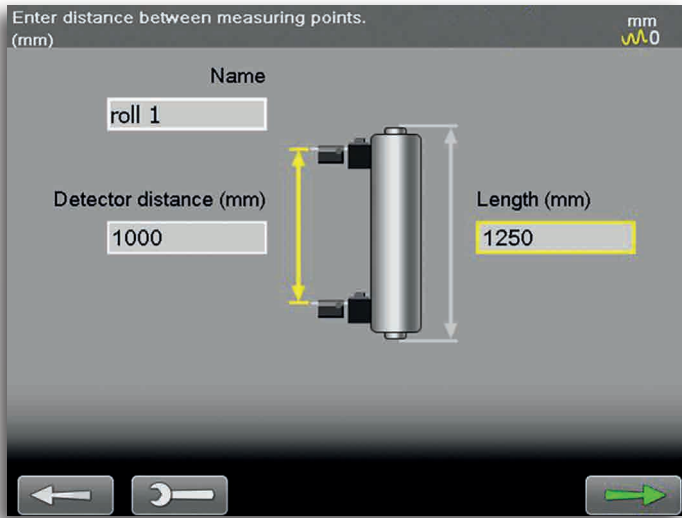

ENTER DISTANCES

Enter the distance between the measurement points and adjustment points of the roll, and give it a suitable name.

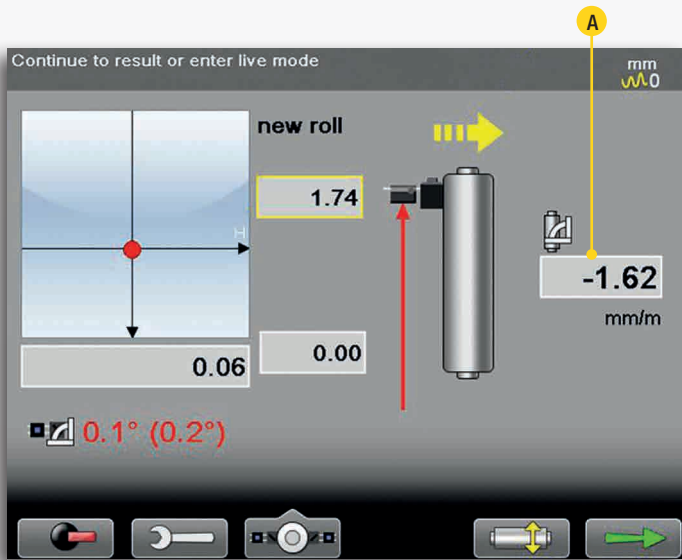

MEASURE

Register values in both ends. After second point the angular value is displayed live (A) for easy adjustment, if needed.

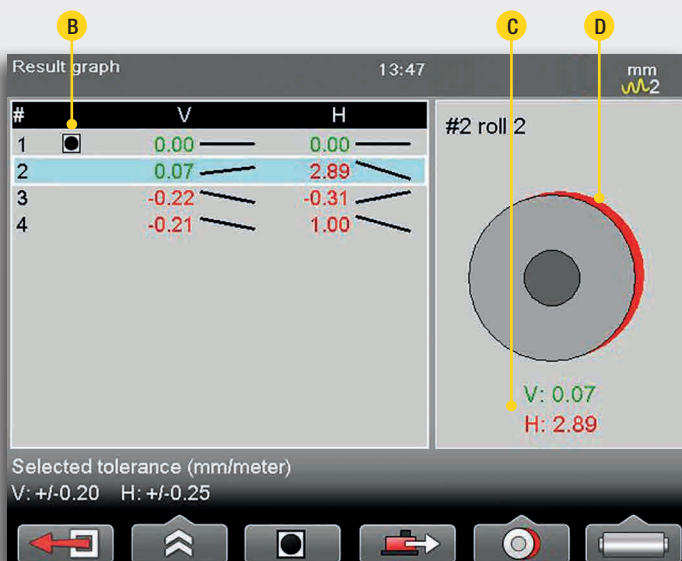

RESULT

The results for all measured rolls are displayed graphically and numerically in a table. Reference object marking (B). Angular values (C). Graphical representation of the roll position (D).



MORE POSSIBILITIES

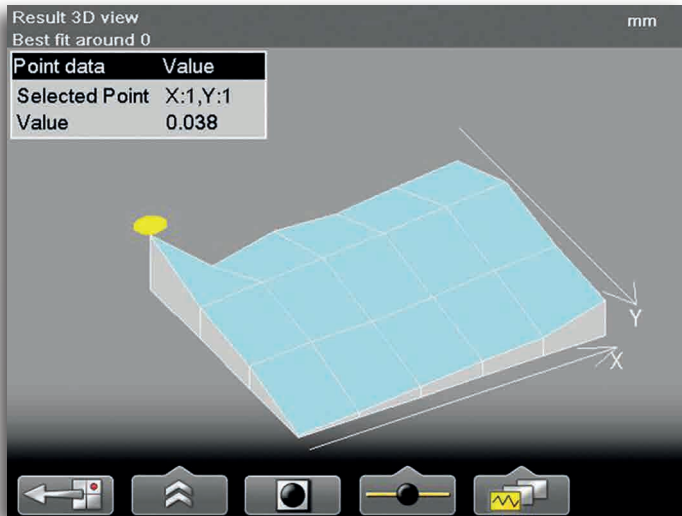

FLATNESS

You can also measure flatness, for example on wire sections (suction boxes) and bases. Place the laser transmitter D22 on the table or a tripod. Place the detector on selected points, and register values. The result can be displayed in a table or a graphical view (pictured). Test different settings of reference points to get optimal adjustment.

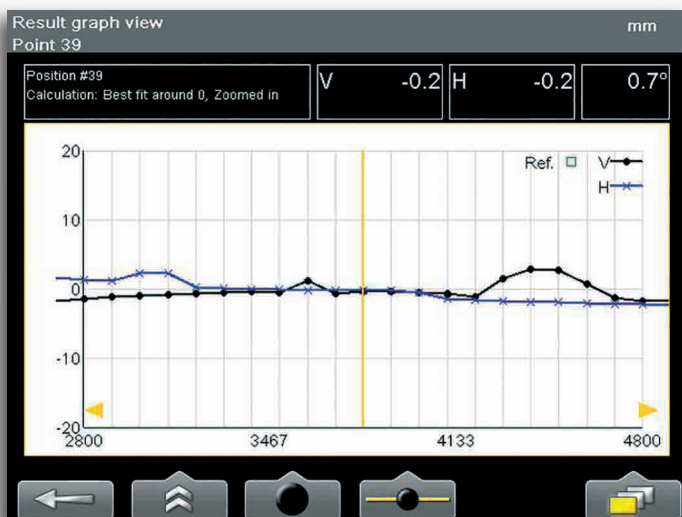

STRAIGHTNESS

Straightness is easily measured with the E970 system. Check rolls, machine frames, conveyors, etc.

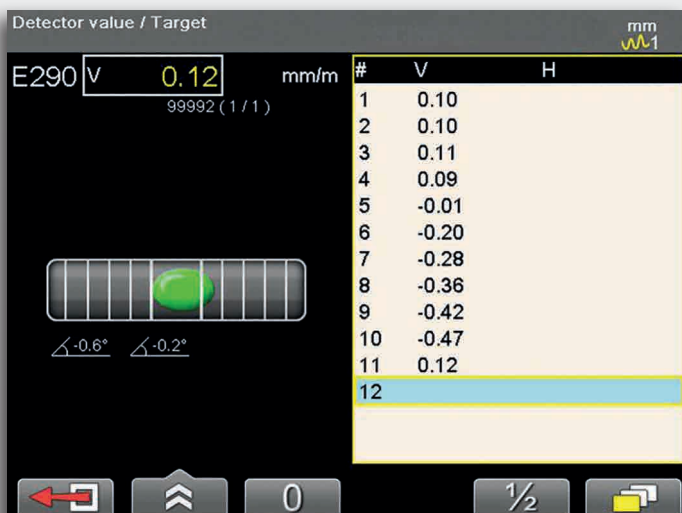

LEVEL

Most machines need to be installed level to work as intended. The E290 digital precision level is perfect for this task. You can also use the D22, with the laser beam pointing over the object, and then place the detector on selected points. Adjust with live values, or calculate required adjustments.

DOCUMENTATION

CREATE A PDF REPORT DIRECTLY

When measurement is complete it is possible to generate a PDF report containing graphs and measurement data directly in the measurement system's display unit. All the information about the measurement object is documented, and you can add your company's logo and address details if you so wish.



SAVING IN THE BUILT-IN MEMORY

You can, of course, save all measurements in the display unit's internal memory.

SAVE TO USB MEMORY

You can easily save desired measurements on your USB memory. This enables you to take it to your computer to print reports whilst leaving the measurement system in place.

CONNECT TO YOUR COMPUTER

The display unit is connected to the computer via the USB port. It then appears on the desktop as a USB Mass Storage Device which you can easily transfer files to and from.

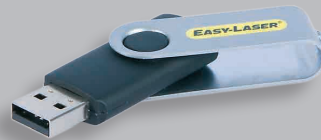

EASYLINK™ PC SOFTWARE

With the EasyLink™ database program you can save and organise all your measurements in one place, produce reports with both data and images and export to your maintenance systems. You can customise what your Excel reports should look like and what data should be visible and where it should be positioned. The program has a clear folder structure, where you drag and drop files from the display unit to the database. Create your own structure with folders for manufacturer, department or machine type for example. The database can also be located on a common server and shared with other users. For extra safety you can use EasyLink™ to make backups of what you have saved in the display unit.

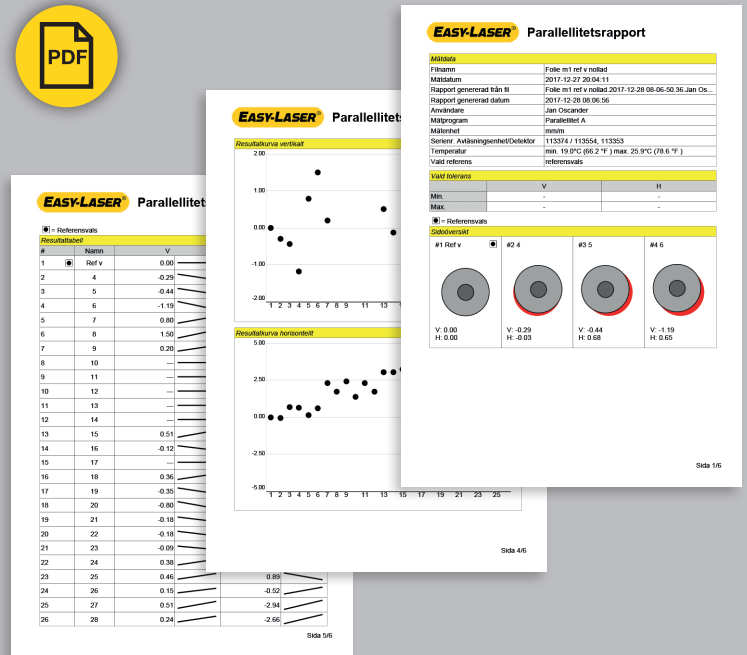
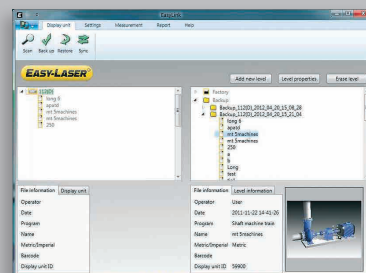

THE PARTS OF THE SYSTEM



A complete system contains	
1	Display unit E-series E51
1	Laser transmitter D22 incl. tilt table
1	Detector E7
1	Wireless unit for E7
1	Digital Precision Level E290
1	Extension kit for E290
1	Cable 2 m
1	Cable 5 m, extension
1	Angular prism (incl. laser alignment target)
1	Tripod adaptor for Angular prism
1	Parallelity kit
2	Tripods
1	Set of Rods 4x240 mm
1	Set of Rods 4x120 mm
1	Set of Rods 4x60 mm
1	Manual
1	Measuring tape 5 m
1	USB memory stick with documentation
1	USB cable
1	Battery charger (100–240 V AC)
1	DC charging cable
1	DC to USB adapter
1	Hexagon wrench set
1	Shoulder strap for Display unit
1	Cleaning cloth for optics
1	Carrying case

System Easy-Laser® E970, Part No. 12-0853

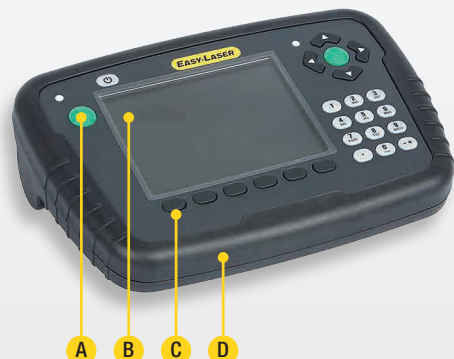

- A. Two Enter buttons, for left and right-handed users
- B. Large, easy to read colour display
- C. Proper buttons for clear feedback
- D. Thin profile gives a perfect grip for your hands

DISPLAY UNIT

The display unit for the E series enables you to work more efficiently and for longer than ever before thanks to several innovative solutions. It is also ergonomically designed with easy-to-grip rubber cladding and robust construction.

NEVER LOSE POWER!

The display unit is equipped with our Endurio™ Power management system. This ensures that you never have to stop in the middle of a measurement because the battery has run out.

LANGUAGE SELECTION

You can choose the language that you want to appear on screen. English, German, French, Spanish, Portuguese, Swedish, Finnish, Russian, Polish, Dutch, Italian, Japanese, Korean and Chinese are available.

ERGONOMIC

The display unit has a thin, easy-to-grip and rubber coated profile that ensures a secure grip. It has large well-spaced buttons that give clear feedback when pushed. In addition, the two Enter buttons make the system suitable for both right and left-handed users. The display screen has clear graphics that guide you through the measurement process.

PERSONAL SETTINGS

You can create a user profile where you can save your personal settings. You can also have different settings for different types of measurements, and save them as Favorites, for quick access from the main menu.

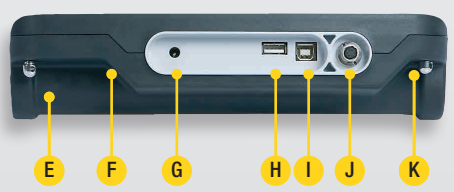

- E. Battery compartment
 - F. Robust, rubber coated design
 - G. Connection for charger
 - H. USB A
 - I. USB B
 - J. Easy-Laser® measurement equipment
 - K. Mounting for shoulder strap
- Note: Dust and splash guards for connectors removed on picture.

LASER TRANSMITTER

Laser transmitter D22 offers several mounting possibilities to make measurement possible in the most varying applications. It can be used to measure flatness, straightness, squareness and parallelism. For example flatness of wire sections. The laser beam can sweep 360° with a measurement distance of up to 40 metres [130'] in radius. The laser beam can be deflected 90° to the sweep, within 0.01 mm/m [0.05 mils/inch].

Part No. 12-0022

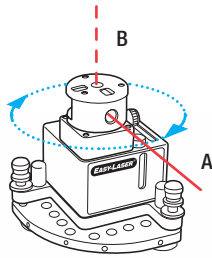

Option A: the laser beam is used for a 360° sweep.

Option B: the laser beam is angled at 90° to the sweep.

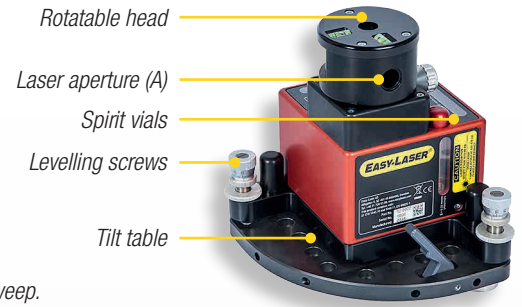

D22 mounted on tripod



Three super magnets for direct mounting on flat surfaces.

DETECTOR

System E970 comes with a 2-axis wireless positional detector (E7) placed on the roll with a sliding bracket with rotatable head. The bracket is kept in place with heavy duty, spring loaded magnets. For small roll diameters (<math>< \varnothing 85 \text{ mm [3.3"]}</math>) the included magnet base with rotatable head is used instead.

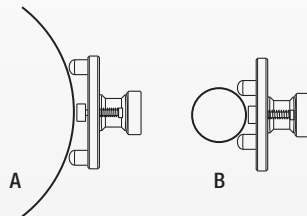

Adjustable feet:

A: Large diameters

B: Small diameters

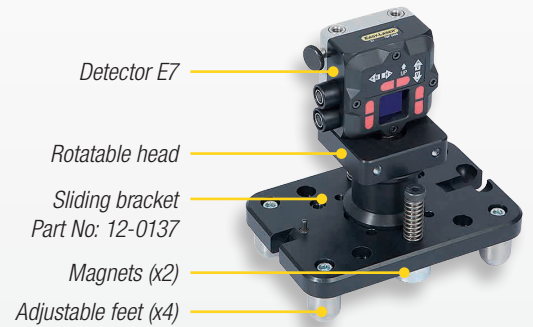

PRECISION LEVEL

The vertical angle (pitch) is measured with the E290 digital precision level. Accuracy is guaranteed by the precision-ground, hardened steel base. Easy-to-read OLED display with graphics makes the measurement procedure quick and easy.

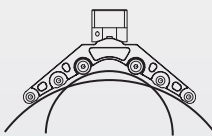

With extension kit

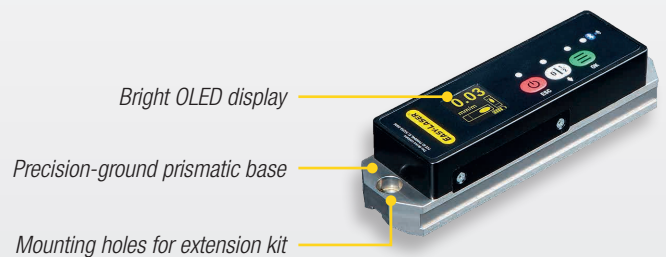

ANGULAR PRISM

The angular prism (penta prism) deflects the laser beam exactly 90°. Part No. 12-1136

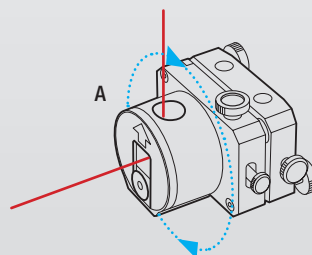
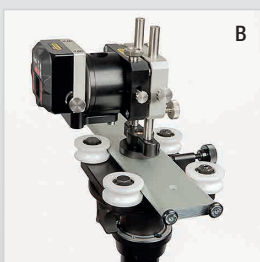

A. With the rotatable angular prism you can reach the detector almost anywhere on the machine.

B. With the detector mounted for precision pre-adjustment.



TECHNICAL DATA

System	
Relative humidity	10–95%
Weight	19.5 kg [43.0 lbs] (complete system, tripods excluded)
Carrying case	WxHxD: 620x490x220 mm [24.4x19.3x8.7"] Drop tested. Water and dust tight.
Laser transmitter D22	
Type of laser	Diode laser
Laser wavelength	630–680 nm
Laser Safety Class	Class 2
Output	< 1 mW
Beam diameter	6 mm [1/4"] at aperture
Working area, range	40-metre radius [130']
Type of battery	1 x R14 (C)
Operating time/battery	approx. 24 hours
Operating temperature	0–50 °C
Levelling range	± 30 mm/m [± 1.7"]
3 x spirit vials' scaling	0.02 mm/m
Squareness between laser beams	± 0.01 mm/m [2 arc sec.]
Flatness of sweep	± 0.01 mm
Fine turning	± 0.1 mm/m [20 arc sec.]
2 x spirit vials for rotation	± 5 mm/m
Housing material	Aluminium
Dimensions	WxHxD: 139x169x139 mm [5.47x6.64x5.47"]
Weight	2650 g [5.8 lbs]
Detector E7	
Type of detector	2 axis PSD 20x20 mm [0.78" sq]
Resolution	0.001 mm [0.05 mils]
Measurement accuracy	±1µm ±1%
Inclinometers	0.1° resolution
Thermal sensors	± 1° C accuracy
Environmental protection	IP Class 66 and 67
Operating temperature	-10–50 °C
Internal battery	Li Ion
Housing material	Anodized aluminium
Dimensions	WxHxD: 60x60x42 mm [2.36x2.36x1.65"]
Weight	186 g [6.6 oz]
Precision level E290	
Resolution	0.01 mm/m (0.001°)
Range	± 2 mm/m
Measurement accuracy	Range ±1 mm/m: accuracy within ±0.02 mm/m of displayed value. Range ±2 mm/m: accuracy within ±0.04 mm/m of displayed value.
Type of display	OLED
Wireless communication	BT wireless technology
Environmental protection	IP Class 67
Operating temperature	-10–50 °C
Internal battery	Li-Ion
Material	Hardened tempered steel, ABS plastics
Dimensions	WxHxD: 149x40x35 mm [5.9x1.6x1.4"]
Weight	530 g [18.7 oz]
Extension kit for E290	
For roll diameters	55–800 mm [2.16–31.50"]
Weight	430 g [15.2 oz]

Wireless connection unit	
Wireless communication	BT Wireless Technology
Operating temperature	-10–50 °C
Environmental protection	IP Class 66 and 67
Housing material	ABS
Dimensions	53x32x24 mm [2.1x1.2x0.9"]
Weight	25 g [0.9 oz]
Angular prism	
Turning range	360°
Fine turning	0.1 mm/m [20 arc sec.]
Parallelism accuracy	± 0.005 ± 0.002/M mm/m * [± 0.005 ± 0.007/F mils/inch] *
*	M is the measurement range in meters [m]. F is the measurement range in feet [ft].
Aperture size	∅ 18 mm [3/4"]
Knob and rod material	Stainless steel
Housing material	Aluminium
Dimensions	WxHxD: 88x60x109 mm [3.5x2.4x4.3"]
Weight	860g [1.9 lbs]
Display unit E51	
Type of display/size	VGA 5.7" colour
Displayed resolution	0.001 mm / 0.05 thou
Power management	Endurio™ system
Internal battery (stationary)	Li Ion
Battery compartment	For 4 pcs R 14 (C)
Operating time	Appr. 30 hours (Normal operating cycle)
Operating temperature	-10–50 °C
Connections	USB A, USB B, Easy-Laser® units
Wireless communication	Class I BT Wireless Technology
Storage memory	>100,000 measurements
Help functions	Calculator, Unit converter
Environmental protection	IP Class 65
Housing material	PC/ABS + TPE
Dimensions	WxHxD: 250x175x63 [9.8x6.9x2.5"]
Weight (without batteries)	1030 g [2.3 lbs]
Sliding bracket for E7	
Measurement diameters	∅ 80–500 mm [2.8"–17.6"]
Material	Anodized aluminium, Stainless steel
Dimensions	WxHxD: 150x100x95 mm [5.9x3.9x3.7"]
Weight	1700 g [59.9oz]
Tripod	
Mounting thread	5/8 UNC
Transport dimension	1110 mm [44"]
Height, Min. – Max.	500–2730 mm [19.7–107.5"]
Weight	7.9 kg [17.4 lbs]
Cables	
Type	With Push/Pull connectors
System cable	Length 2 m [78.7"]
Extension system cable	Length 5 m [196.8"]
USB cable	Length 1.8 m [70.8"]
Rods	
Length (extendable)	60/120/240 mm [2.36"/4.72"/9.44"]
Material	Stainless steel
EasyLink™ Data base software	
System requirements	Windows® XP, Vista, 7, 8, 10. For the export functions, Excel 2003 or newer must be installed on the PC.