



Casework

lunacraftcabinets.com



Good design doesn't have to be expensive.

LUNA products are designed and manufactured to be consistent in quality, materials, and finishes. We offer integrated, project solutions available through one efficient source, making selection, specification, and delivery easier.

The LunaCraft casework program is a versatile and customizable solution for a wide range of projects, from residential kitchens and bathrooms to commercial amenity and lobby spaces. The program offers flat packed casework for maximum shipping efficiency and easy on-site assembly using dowel and camlock construction, familiar to many installers and contractors.

Tailored to the unique needs and requirements of each project

Can be paired with Luna Quartz countertops for a seamless look

Offered in a range of price points to fit different budgets

Customization without sacrificing quality or style

Product Detail

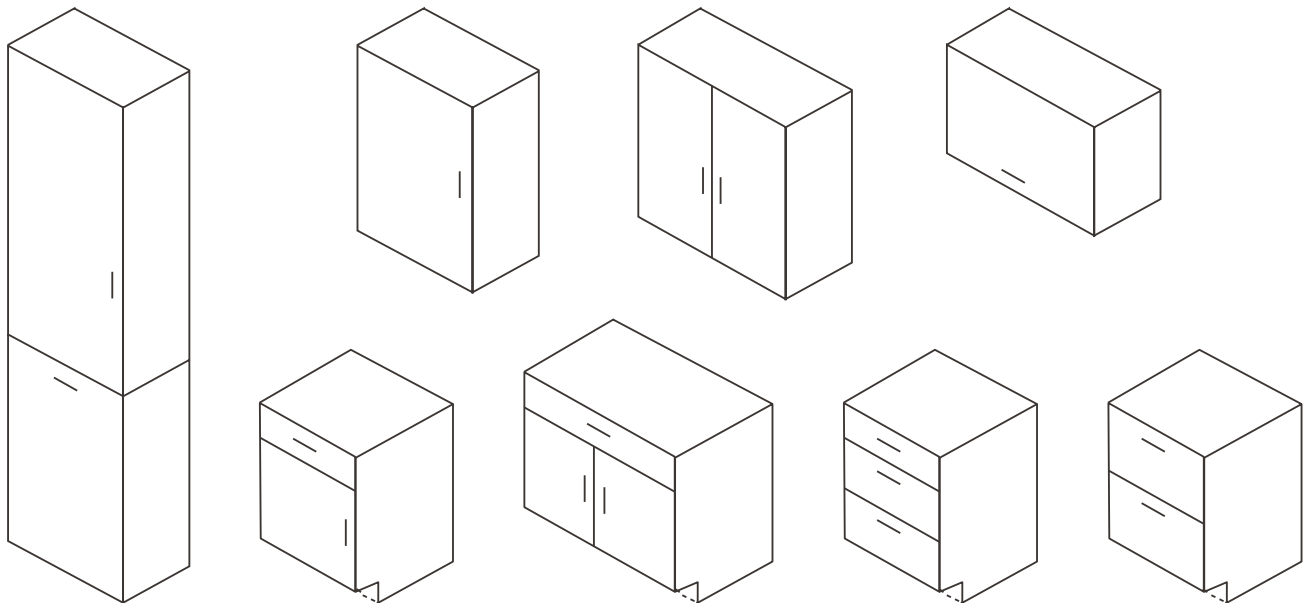

Specifications

Box Construction	Flat-Pack Frameless Cabinet
Box Material	5/8" Plywood, 5/8" Particle Board
Box Connection Type	Dowel & Camlock
Door Styles	Shaker Slab
Finish Veneer Options	Melamine Veneer TFL Veneer
Particle Board Interior Finish	Melamine
Plywood Interior Finish	Clear Coat or Melamine
Drawer Slides	DTC, Soft Close
Hinges	DTC, Adjustable Hinge
Base	Adjustable Pedestal Base Legs



FLAT PACK FRAMELESS CABINET SYSTEM

- **Case** - 5/8" PB or Plywood - Edgebanded face, Cam-lock assembly
- **Case Interior** - white melamine
- **Top, Bottom, & Sides** - grooved to accept captive back
- **Backing** - hot glued and stapled when cabinet is assembled
- **Shelves** - 5/8" white melamine faced, held in with metal clips. Drilled holes in case sides for shelf height adjustment
- **Doors** - 24" wide, 60" tall maximum warrantied size
- **Decorative Hardware** - ships separately
- **DTC** - Concealed soft close hinges & slides
- **Cabinet Door Finishes** - TFL & Melamine

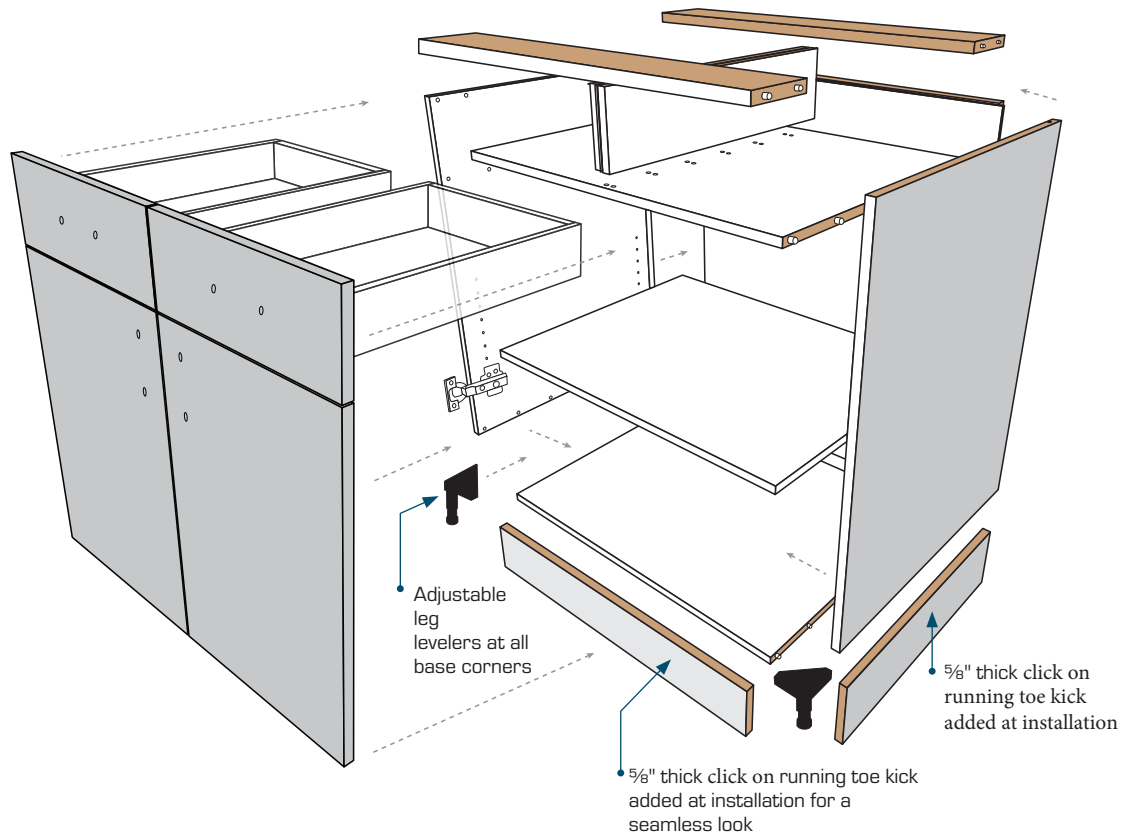
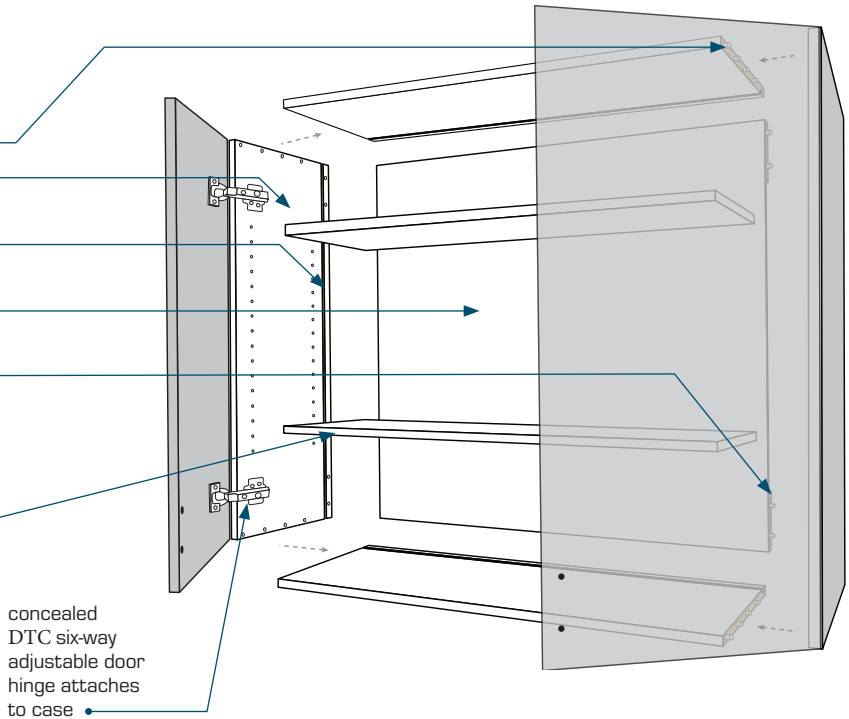

Door Styles

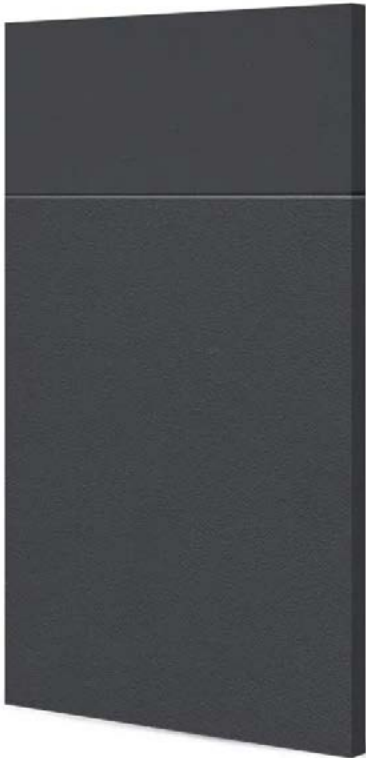

Slab

A slab door is a single, flat piece of material that is used as the front of the cabinet. It offers a clean and modern look, with a smooth and simple surface that is easy to clean and maintain.

AVAILABLE IN

Thermofoil

Melamine

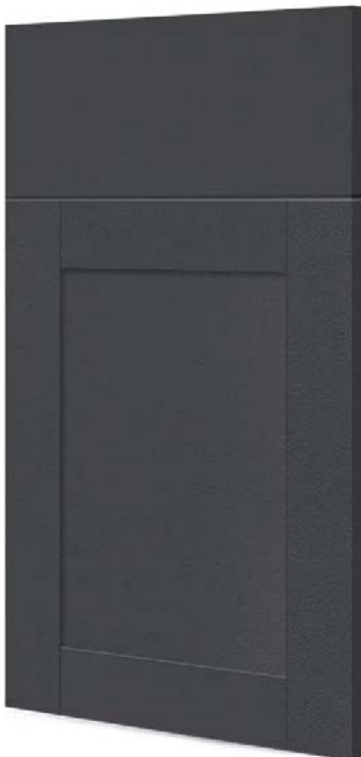

5-Piece Shaker

A 5-piece shaker door is constructed from five separate pieces joined together to form a frame and panel design. The frame surrounds a recessed panel, giving the door depth and dimensionality. It offers a classic and timeless look that works well in a variety of design styles.

AVAILABLE IN

Thermofoil

Melamine

Good design doesn't have to be expensive.

LunaCraft offers premium cabinets at a great value, creating a foundation for beautiful, high-quality kitchens and baths. Our casework finishes are intentionally curated with design and performance in mind, ensuring durability and longevity. LunaCraft offers a range of construction options to fit your budget and needs, from cost-effective to luxury designs.

With a variety of finishing options, including Melamine & Thermofoil our casework is durable and easy to maintain. Applicable to both commercial and residential environments, LunaCraft provides you with versatile and timeless solutions between styles and colors. Choose LunaCraft for premium quality and enduring style.



Ebony
E6826



Walnut
E6060



Espresso
E6076



Clove
E6848



Driftwood
E6847



Fog
E6818



White Oak
E6850



Sand
E6814



Natural
E6817



Sierra
E6802

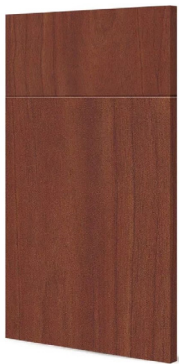

Redwood
E6806



Sequoia
E6822



Ponderoda
E6035



Pecan
E6002



Almond
E6809



Pinecone

E6801



Sable

E6059



Acorn

E6816



Chestnut

E6825



Bonsai

E6808

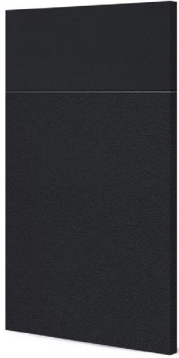

Onyx

S1027

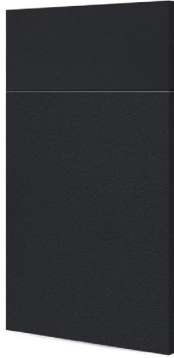

Midnight

S1005



Smoke

E6855

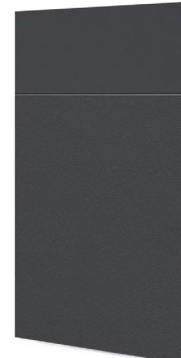

Gris

S1021



Basalt

E7809



Stone

E7021

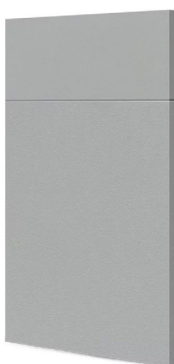

Dove

S1004

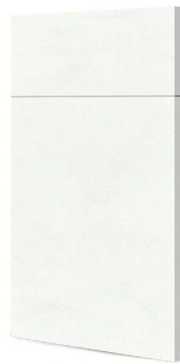

Pearl

S1009

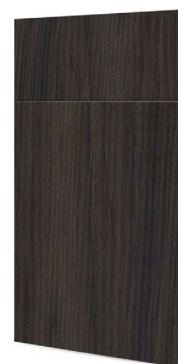

Chocolate

E7019



Charcoal

E6866



Graphite

E6917



Ash

E6922



Sagebrush

E6911



Taupe

E7808



Brown Oak

E7024



Tobacco

E8027



Terra

E8026



Mist

E8009



Jute

E6851



Linen

E6860

Finish Options

Melamine

Melamine cabinets are made from a type of resin that is bonded to a particleboard or MDF (medium-density fiberboard) substrate. The melamine finish is highly durable, scratch-resistant, and easy to clean. These cabinets are available in a variety of colors and finishes.

Thermofoil

Thermofoil cabinets are made from a thin layer of vinyl that is vacuum-sealed onto an MDF substrate. The resulting product is highly durable, moisture-resistant, and easy to clean. Thermofoil cabinets are available in a wide range of colors and finishes, including wood grain or stone patterns.

CARE & MAINTENANCE

BASIC CLEANING:

- Use a clean, soft, and lint-free cotton cloth dampened with warm water or a mild cleaner, if necessary, for cleaning your cabinet frames, fronts, shelves, and other wooden surfaces.
 - Use only cleaning agents intended for the materials you have.
 - Avoid damaging cabinet stains and finishes by blotting the surface instead of wiping when cleaning.
 - Never use a dirty or greasy cloth to clean cabinetry.
 - Harsh detergent residues may damage finishes.
 - Spills, water spots, and grease will come off easier if removed promptly.
 - Make sure cabinets are dry after cleaning. Avoid excessive moisture on wood cabinets.
 - Check areas around the sink and dishwasher to make sure that water and detergents do not dry on the cabinet surface.
 - Do not leave printed materials (newspapers, magazines, etc.) on cabinet surfaces as printed ink can bleed into the finish.
 - Avoid using a dirty dishcloth or a sponge to clean cabinet surfaces as it may contain remnants of harsh detergents that can harm the finish.
 - The following products and ingredients can damage cabinets and should be avoided:
 - Petroleum-based products
 - Solvents
 - Bleach
 - Strong detergents and soaps
 - Nail polish remover
 - Paint thinners
 - Wire brushes
 - Steel wool
 - Abrasive
 - Scoring pad
 - Ammonia
 - Soaps with dye
 - Self-polishing waxes (especially those that contain silicone)
-

AVOID EXCESSIVE MOISTURE & HEAT:

- Avoid draping wet or damp dishtowels over cabinet doors.
- Give special attention to areas around the sink and dishwasher.
- Do not attach towel racks to interior cabinet doors.
- Use trays under potted plants to catch excess water.
- Avoid placing small kitchen appliances, like coffee pots or toaster ovens, where heat or steam is directed onto cabinet surfaces.
- Always protect wood surfaces by using hot pads under hot items

AVOID ABRASIVES:

- Never use scouring pads, steel wool, wire brushes or powdered cleaners.
- Do not allow oven cleaners to contact any part of the cabinets.
- Avoid sliding objects across cabinet surfaces.
- Be careful with knives and other sharp objects that can damage cabinet surfaces.