



KITCHEN & BATH

2024 Retail Pricing



Pricing Effective November 1, 2023



A misty seascape with an industrial structure on the left and wind turbines in the background. The scene is hazy, with the sea and sky blending into a soft, greyish-white atmosphere. The industrial structure on the left has a dark, silhouetted appearance with various pipes and platforms. Two large wind turbines are visible in the background, their blades slightly blurred, suggesting movement. The overall mood is serene yet powerful, combining natural elements with human-made structures.

Strength & Beauty

From the maritime crucible, these luxury faucets emerge, a symphony of Naval might and design's grace, sculpted for opulent indulgence





OUR STORY

Waterstone Faucets was founded in 1999 by Chris Kuran. At its inception, the company primarily provided top-quality parts and finished components to large manufacturers that made and sold drinking water filtration systems.

As the news of Waterstone's quality parts and timely deliveries spread throughout the industry, customers began requesting that Waterstone provide small institutional drinking water faucets in custom finishes.

Recognizing these requests as a niche opportunity, Waterstone decided to change course and begin the production of high-quality Water Filtration Faucets in numerous finishes to match the higher-end kitchen faucets that were being sold for designer kitchens.

Waterstone then designed and developed its own line of decorative Water Filtration Faucets using only the best materials and finishes available. Utilizing the experience of selling certified products to the Water Quality system manufacturers, Waterstone had already created a highly efficient manufacturing system that could make anything it could design while maintaining the highest certifiable quality.

In 2002 Waterstone launched its first line of decorative Filtration Faucets and chose to market and sell these products through trained and qualified Kitchen and Bath showrooms throughout North America. Waterstone successfully changed direction from a manufacturer of water-quality components to a niche faucet company.

The program was a huge success, and the dealers began requesting other niche products. By this time, Waterstone Faucets was selling its filtration faucet program in all 50 states and Canada. By designing, engineering, manufacturing, finishing, assembling, testing, and packaging all products at our manufacturing facility in California, Waterstone has grown in size and added production capacity in preparation for its next big change. That change happened in 2005, again with the continued encouragement of its customers.

Waterstone made the decision to add Kitchen Faucets and related items to its product offerings. In typical fashion, Waterstone started from the ground up and designed, developed, and engineered a full line of Kitchen Faucet products to match its Water Filtration Faucets. The guiding focus and desire was to manufacture products that would match the uniqueness of the original groundbreaking Filtration Faucet designs.

In 2022, after 23 years Waterstone entered into the bath category with the introduction of the Argonaut collection, taking cues from Chris' experience in the Marines and on naval vessels with industrial and nautical design elements.

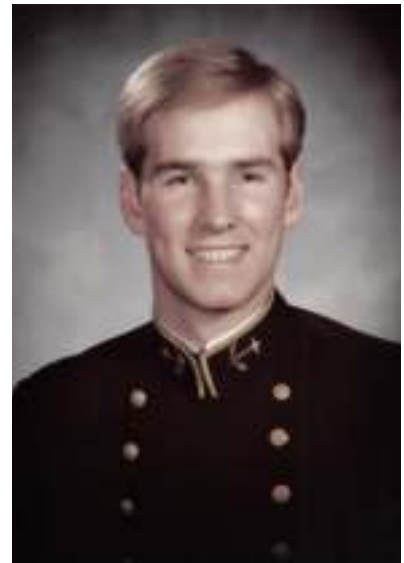

CORE VALUES

- Passion for Excellence
- Teamwork
- Caring For Our Family and Yours
- Fair and Honest Every Time
- Fun Product, Place, and People





@killowenconstruction
@waterstone_faucets

TYLER FARRELL & WATERSTONE FAUCETS

It is not just about expertise; it's also about a shared vision. Killowen Construction shares our values and vision for the future. Their reliability, integrity and customer-centric service makes them a welcome addition to the Waterstone Family. Stay tuned to see what we create together!



WELCOME TO WATERSTONE

In 2023 Waterstone hosted over 200 industry leaders in the A&D community at our factory in Murrieta California. At Waterstone we do things differently, come see the dedicated craftsman and engineers create the best faucets in the world. Join the adventure today! www.waterstoneco.com



CONTENTS

KITCHEN COLLECTION

SPLIT FINISH	PAGE
HOW TO ORDER	10
SPLIT FINISH DIAGRAMS	12
PULL-DOWNS	
THE WHEEL/ ENDEAVOR	19
TRADITIONAL	23
CONTEMPORARY	27
INDUSTRIAL	33
MODERN	39
FULTON INDUSTRIAL	45
FULTON MODERN	51
2 HANDLE INDUSTRIAL	57
2 HANDLE MODERN	63
2 HANDLE FULTON INDUSTRIAL	69
2 HANDLE FULTON MODERN	75
GANTRY	
TRADITIONAL	81
CONTEMPORARY	84
BRIDGE FAUCETS	
TRADITIONAL	85
CONTEMPORARY	90
KITCHEN FAUCETS	
TRADITIONAL	91
TWO HANDLE	94
CONTEMPORARY	96



PREP FAUCETS	PAGE
TRADITIONAL	97
CONTEMPORARY	101
BAR FAUCETS	
TRADITIONAL	102
CONTEMPORARY	104
INDUSTRIAL	105
FILTRATION FAUCETS	
TRADITIONAL	107
CONTEMPORARY	118
INDUSTRIAL	121
POTFILLERS	
WALL MOUNTED	123
COUNTER MOUNT	128
ACCESSORIES	
AIR GAPS	131
AIR SWITCHES	133
SOAP/ LOTION DISPENSERS	134
SIDE SPRAYS	138
HOLE COVERS	139
ESCUTCHEON PLATES	140
UNDERSINK SYSTEMS	142



HARDWARE COLLECTION

SPLIT FINISH	
HOW TO ORDER	145
SPLIT FINISH DIAGRAMS	148
CABINET KNOBS	149
CABINET PULLS	155
APPLIANCE/ DOOR PULLS	161



BATH COLLECTION

ARGONAUT

SPLIT FINISH

	PAGE
HOW TO ORDER	169
SPLIT FINISH DIAGRAMS	170

SHOWER

RETRACTABLE WHEEL SYSTEM W/ HANDSHOWER	175
WALL MOUNT SHOWER HEAD	175
THERMOSTATIC SHOWER TRIM W/ VOLUME CONTROL	175
DIVERTER TRIM	176
SLIDE BAR HAND SHOWER	176

TUB

FREESTANDING TUB FILLER W/ HAND SHOWER	176
DECK MOUNT TUB FILLER W/HAND SHOWER	177
DECK MOUNT TUB FILLER W/O HAND SHOWER	177
WALL MOUNT TUB FILLER W/ BACK PLATE	177

LAVATORY

LAVATORY FAUCETS AND PUSH DRAIN	178
------------------------------------	-----



BATH ACCESSORIES	PAGE
TOWEL BARS	178
TOILET PAPER HOLDER	178
SINGLE ROBE HOOK	179
DOUBLE ROBE HOOK	179
ROUGH-IN VALVES	
SHOWER	179
THERMOSTATIC VALVE	179
DIVERTER VALVE	180
FREESTANDING TUB FILLER	180
DECK MOUNT TUB FILLER	180
RAINSTONE SHOWER HEAD	
INDUSTRIAL	183
MODERN	184
QUICK REFERENCE GLOSSARY	185
POLICIES	
UMRP	197
TERMS AND CONDITIONS	198
LIFETIME FUNCTIONALITY	199
WARRANTY	
ORDER FULFILLMENT POLICY	200
DROP SHIP POLICY	200
FINISHES	
CARE AND CLEANING	201
FINISH WARRANTIES	205
FINISH PRICE GROUPS	206





- 9350-3-PN
- 1400-PN

KITCHEN

California architecture has a rich history of innovation and unique design. The state's diversity and creativity is reflected in our bridges, buildings, and homes. From Spanish Colonial to the modernism of Frank Gehry, California's architecture is truly an inspiration to us at Waterstone. We love the look of the bungalows, beach cottages and Bauhaus. The mid-century chic of L.A. and the Victorian style of the North. The Spanish style of Balboa Park and the California Missions. The space age style of our motels and gas stations. California has it all. At Waterstone, we take a little of everything and put it into our Kitchen Faucet designs. Creating a unique piece of architecture that will be the centerpiece of your kitchen.

SPLIT FINISHES

HOW TO DESIGNATE A SPLIT FINISH FAUCET WHEN ORDERING

Take the model number and add both finishes to the suffix starting with the Primary finish followed by the Accent finish. For Matte Black (MB) and Classic Bronze (CLZ), it would be 9810-MB/CLZ. If you wanted Classic Bronze (CLZ) and Polished Nickel (PN) it would be 9850-CLZ/PN. For all split finish designs click "Split Finishes" in the top menu of our home page at www.waterstonco.com

Faucet can be split using any combination of the standard finishes. For pricing add 10% to the higher list price of the 2 finishes.

For custom split finish add 40% to Group 3 pricing.



• 5100-PMB-0956/PN



WHEEL FAUCETS

White = Primary finish
 Gray = Accent finish

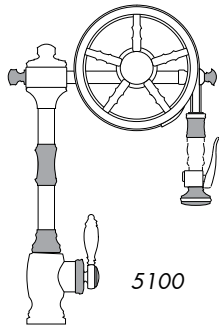

5100

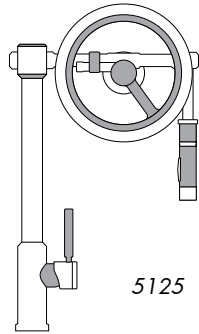

5125

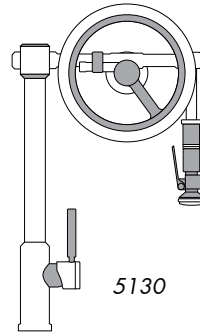

5130

PLP PULLDOWN FAUCETS

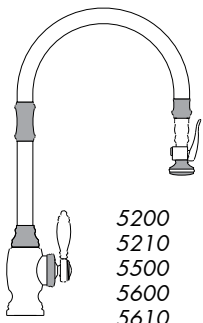

5200
5210
5500
5600
5610

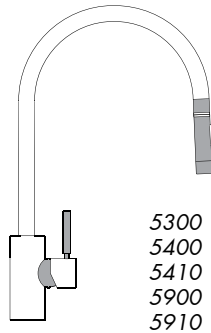

5300
5400
5410
5900
5910

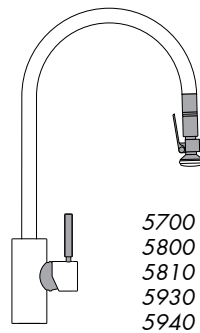

5700
5800
5810
5930
5940

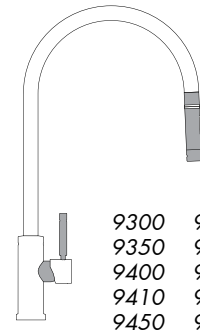

9300 9460
9350 9900
9400 9910
9410 9950
9450 9960

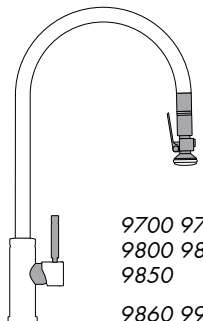

9700 9750
9800 9810
9850
9860 9930 9940
9980 9990

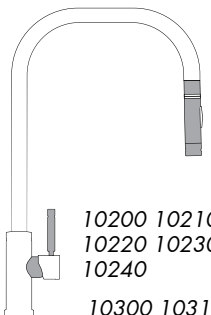

10200 10210
10220 10230
10240
10300 10310
10320 10330
10340

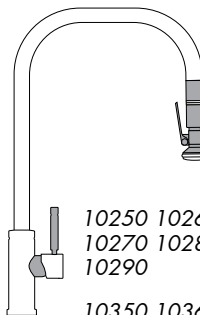

10250 10260
10270 10280
10290
10350 10360
10370 10380
10390

BRIDGE FAUCETS

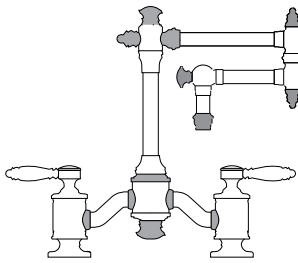

6100-12
6100-18

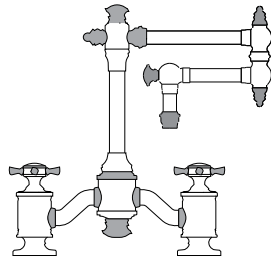

6150-12
6150-18

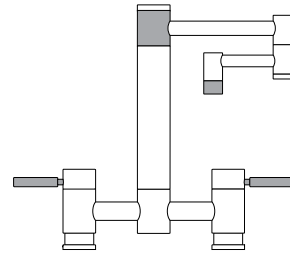

7600-12
7600-18

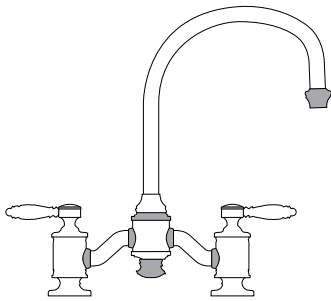

6300

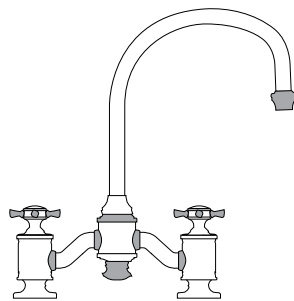

6350

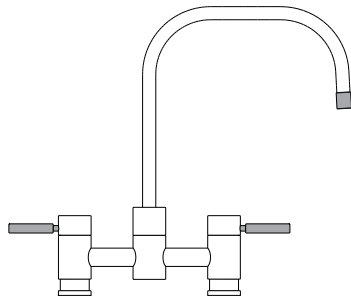

7825

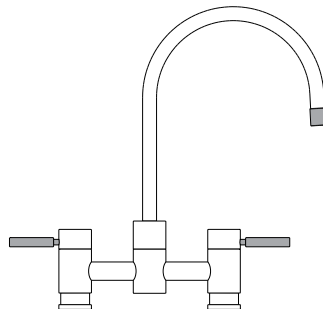

7800

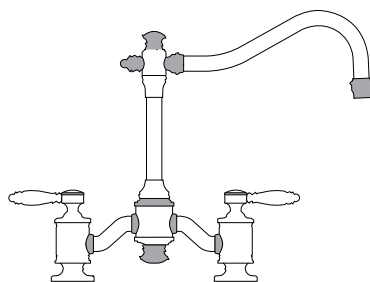

6200

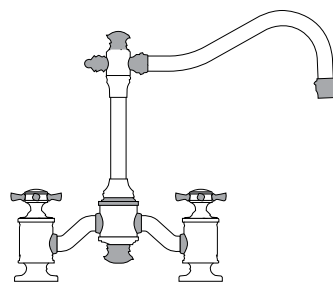

6250

2-HANDLE PLP



9302 9402 9412 9902
9912 9352 9452 9462
9952 9962



9702 9802 9812 9932
9942 9752 9852 9862
9982 9992



10202 10212 10222 10232
10242 10302 10312 10322
10332 10342



10252 10262 10272 10282
10292 10352 10362 10372
10382 10392

GANTRY FAUCETS

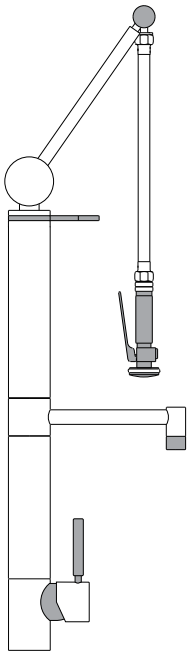

3700

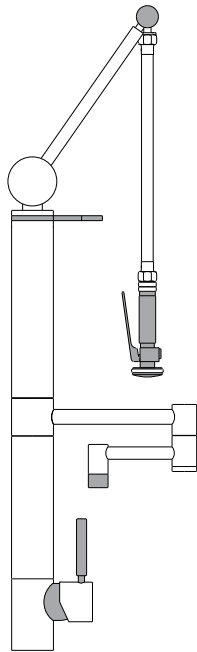

3710-12
3710-18

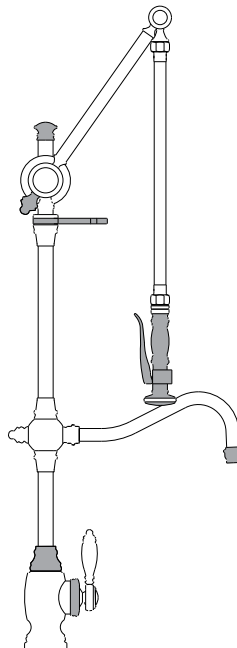

4400

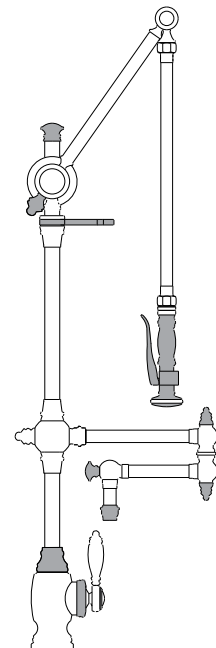

4410-12
4410-18

KITCHEN AND PREP FAUCETS

White = Primary finish
 Gray = Accent finish

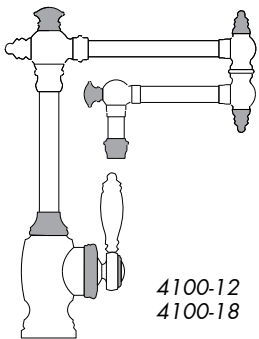

4100-12
4100-18

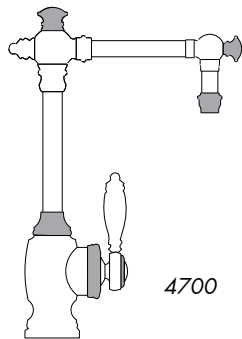

4700

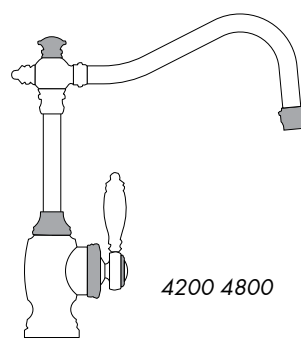

4200 4800

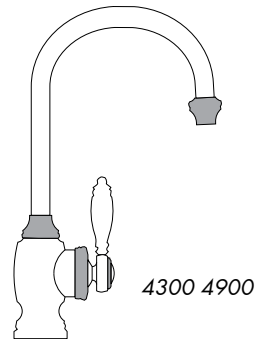

4300 4900

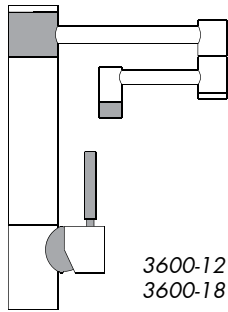

3600-12
3600-18

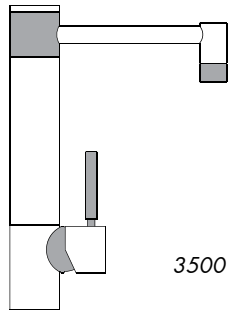

3500

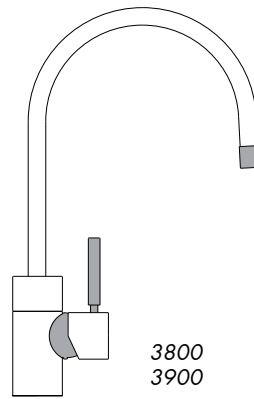

3800
3900

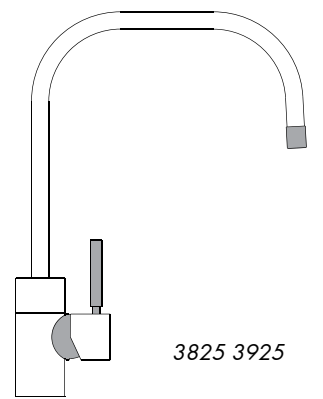

3825 3925

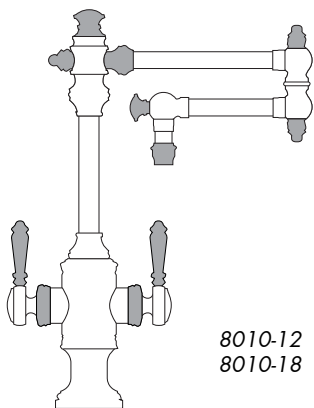

8010-12
8010-18

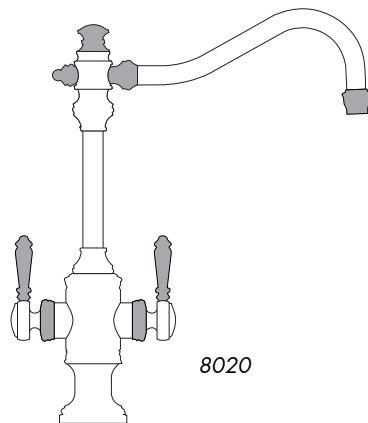

8020

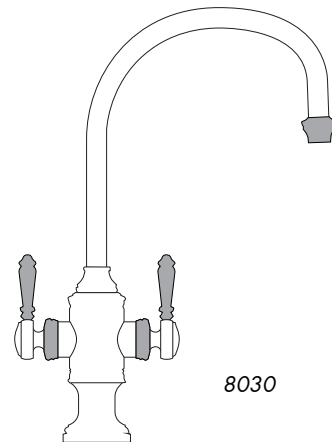

8030

WALL MOUNTED POTFILLERS

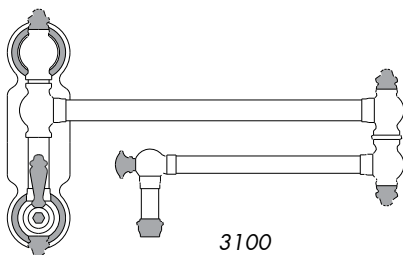

3100

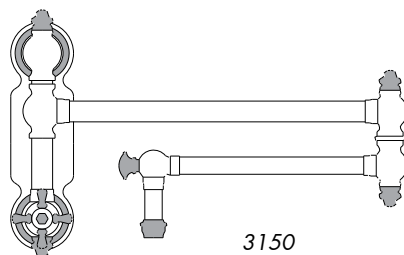

3150

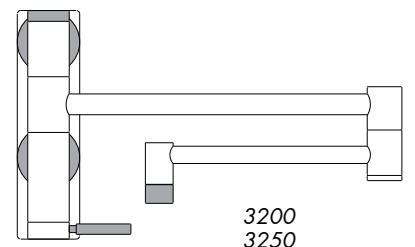

3200
3250

COUNTER MOUNTED POTFILLERS

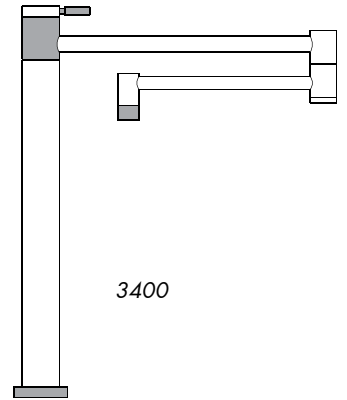
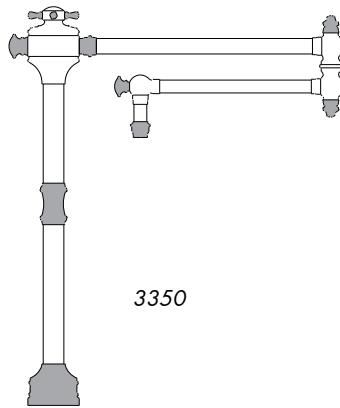
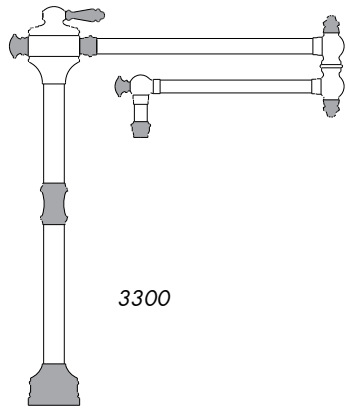

BAR FAUCETS

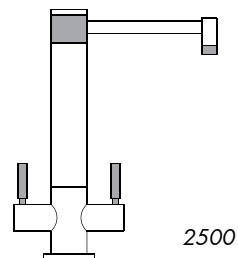
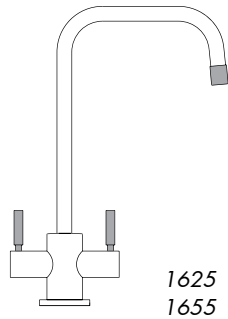
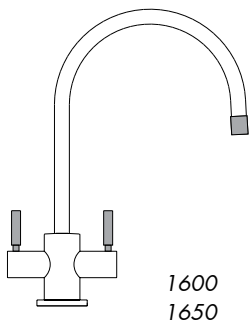
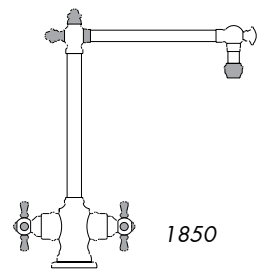
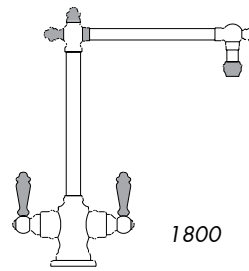
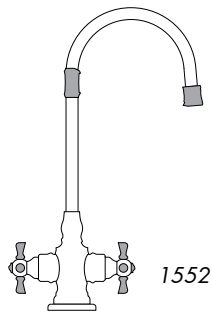
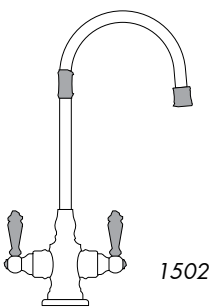
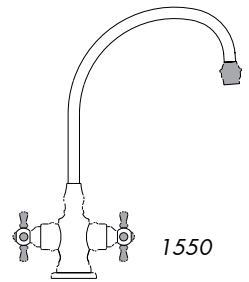
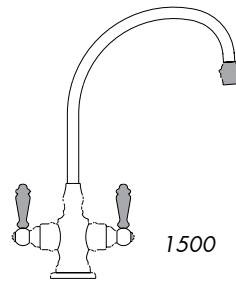
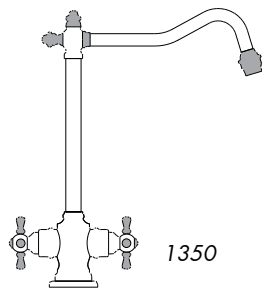
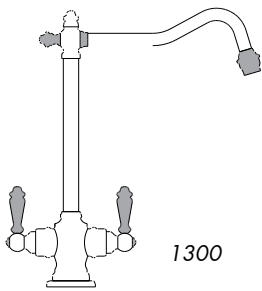

FILTRATION FAUCETS

White = Primary finish
 Gray = Accent finish

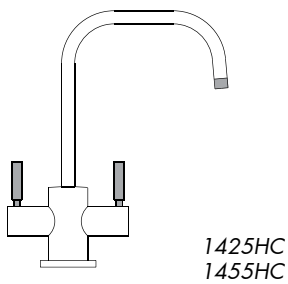
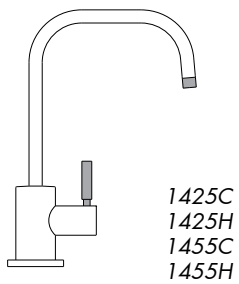
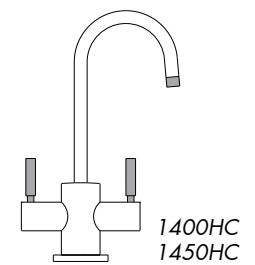
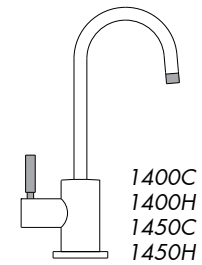
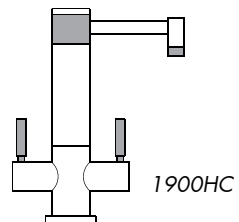
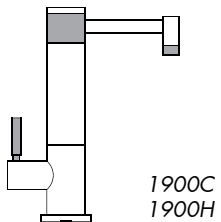
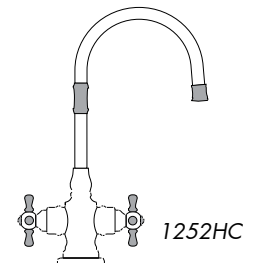
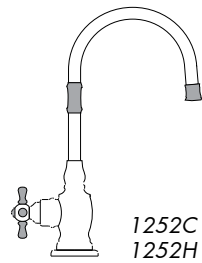
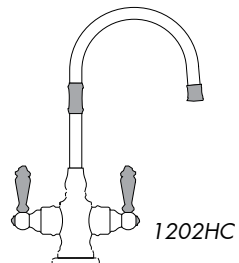
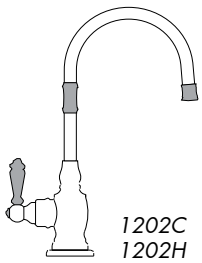
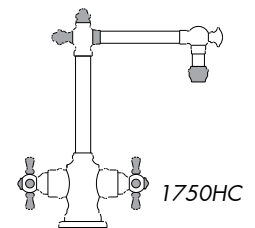
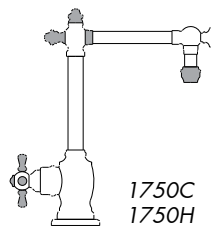
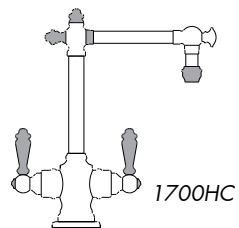
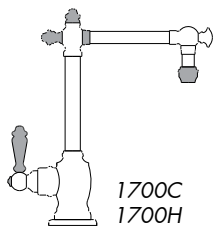
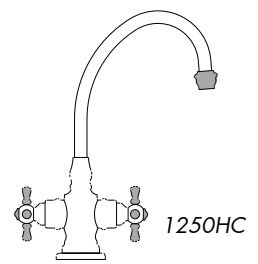
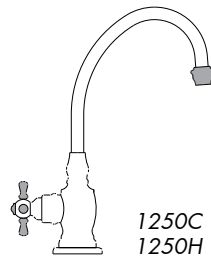
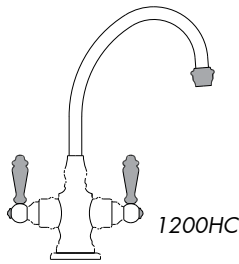
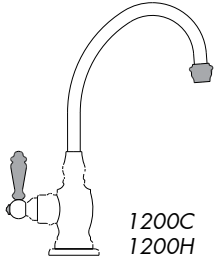
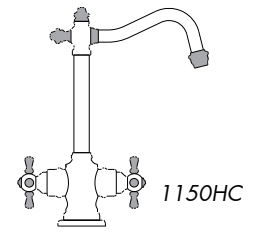
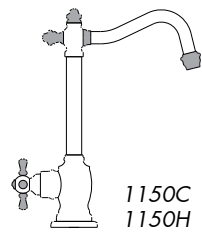
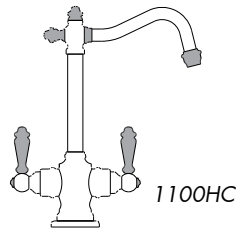
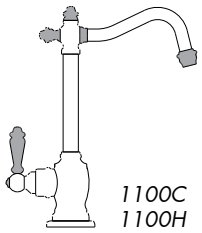

ACCESSORIES

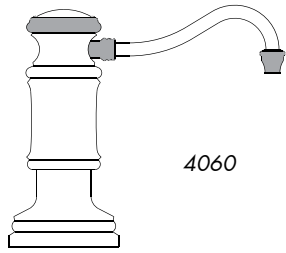

4060

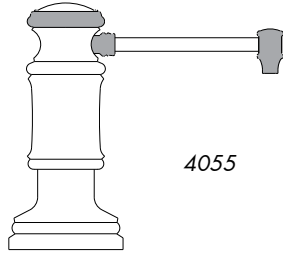

4055

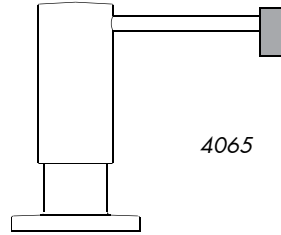

4065

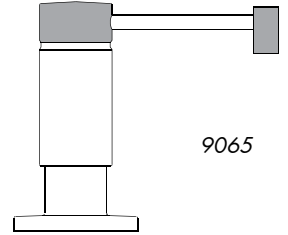

9065

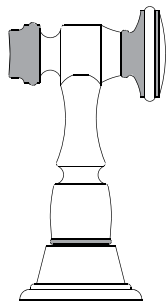

4025

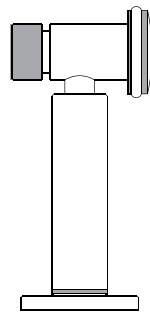

3025

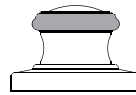

4010



3010
9010



4020 4030

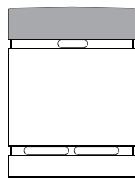

9020 9030
3020 3030

WHEEL & ENDEAVOR



- 5130-2-MB/CLZ
- 1400H-MB/CLZ



- 5130-3-CD
- 1400H-CD

How to Order A PLP Suite



• 5130-3-CD
• 1400H-CD

Waterstone offers complete suites! All suites' orders come in one box!

Elevate your kitchen's functionality and aesthetics with our versatile product suites, available in 2-piece, 3-piece, and 4-piece options, each thoughtfully curated to enhance your culinary haven.

See example below (Prices shown not current)

5125 SUITES

SUITE LIST PRICES:

MODEL #	GRP 1	GRP 2	GRP 3	CD
5125-2	8349	8767	11423	N/A
5125-3	8798	9239	12038	N/A
5125-4	9083	9538	12427	N/A

5125-2 5125-3 5125-4

2pc. Suite Soap/Lotion Dispenser (4065)
3pc. Suite includes Soap/Lotion Dispenser (4065) and Air Switch (3010)
4pc. Suite includes Soap/Lotion Dispenser (4065), Air Switch (3010) and Single Port Air Gap (3020)

TRADITIONAL WHEEL PULL-DOWN FAUCET

MODEL: 5100

LIST PRICES:

GRP 1 : 6863

GRP 2 : 7206

GRP 3 : 9390

MEETS THE FOLLOWING:

- ASME A112.18.1
- CSA B125.1
- NSF 61, 372
- CALGreen
- ICC Approved

- 19-1/2" overall height.
- 9-1/8" reach and can swivel 360 degrees.
- Lever handle spray head pulls out 17" from spout.
- 1.75 gpm maximum flow rate with aerated tip.
- "Positive Lock Pulldown" design locks sprayer in place.
- Hot/cold ceramic disk valve cartridge.
- Minimum install hole size 1-1/2"
- Compatible with reverse osmosis water and systems.
- Made from solid brass.
- Aerated stream diverts to spray when lever is held.
- Adjustable handle tension.



ENDEAVOR WHEEL PULL-DOWN FAUCET / TOGGLE SPRAYER

MODEL: 5125

LIST PRICES:

GRP 1 : 7872

GRP 2 : 8266

GRP 3 : 10770

MEETS THE FOLLOWING:

- ASME A112.18.1
- CSA B125.1
- NSF 61, 372
- CALGreen
- ICC Approved

- 19-5/8" overall height.
- 9-3/4" reach and can swivel 360 degrees.
- Toggle handle spray head pulls out 20" from spout.
- 1.75 gpm flow rate with aerated tip.
- Hot/cold ceramic disk valve cartridge.
- Aerated stream or Toggle activated spray.
- Toggle remains in spray mode until toggled back or faucet shut off.
- Minimum install hole 1- 1/2".
- Compatible with reverse osmosis water and systems.
- Made from solid brass.
- Wave spring handle tension.



ENDEAVOR WHEEL PULL-DOWN FAUCET / LEVER SPRAYER

MODEL: 5130

LIST PRICES:

GRP 1: 8056

GRP 2: 8459

GRP 3: 11023

MEETS THE FOLLOWING:

- ASME A112.18.1
- CSA B125.1
- NSF 61, 372
- CALGreen
- ICC Approved

- 19-5/8" overall height.
- 9-3/4" reach and can swivel 360 degrees.
- Toggle handle spray head pulls out 17" from spout.
- 1.75 gpm flow rate with aerated tip.
- "Positive Lock Pulldown" design locks sprayer in place
- Hot/cold ceramic disk valve cartridge.
- Minimum hole dimension 1-1/2"
- Compatible with reverse osmosis water and systems.
- Made from solid brass.
- Aerated stream diverts to spray when lever is held.
- Wave spring handle tension.



FINISH GROUP 1: CH
 FINISH GROUP 2: BLN, CD, CHB, CLZ, GR, MB, MW, PB, PN, SB, SC, SN, UPB
 FINISH GROUP 3: AB, ABZ, AC, AMB, AP, CB, DAB, DAC, DAMB, DAP, MAB, MAC, MAP, ORB, PC, TB

PRECIOUS METALS: PG, SG - 30% increase from Group 3*
 STAINLESS STEEL: SS *Pricing subject to change

TRADITIONAL PLP



• 5500-2-SN



- 5600-CLZ
- 4010-CLZ

TRADITIONAL EXTENDED REACH PLP PULL-DOWN FAUCET / LEVER SPRAYER

MODEL: 5500

LIST PRICES:

GRP 1 : 2902

GRP 2 : 3046

GRP 3 : 3970

SS : N/A

- 21-3/4" overall height.
- Spout has a larger 11" reach for big sinks and can swivel 360 degrees.
- Lever handle spray head pulls out 18" from spout.
- 1.75 gpm maximum flow rate with aerated tip.
- "Positive Lock Pulldown" design locks sprayer in place.
- Hot/cold ceramic disk valve cartridge.
- Minimum install hole size 1-1/2".
- Adjustable handle tension.
- Compatible with reverse osmosis water and systems.
- Made from solid brass.

MEETS THE FOLLOWING:

- ASME A112.18.1
- CSA B125.1
- NSF 61, 372
- CALGreen
- ICC Approved



TRADITIONAL PLP PULL-DOWN FAUCET / LEVER SPRAYER

MODEL: 5600

LIST PRICES:

GRP 1 : 2758

GRP 2 : 2898

GRP 3 : 3775

SS : N/A

- 18" overall height
- Spout has 8-1/2" reach and can swivel 360 degrees.
- Lever handle spray head pulls out 18" from spout.
- 1.75 gpm maximum flow rate with aerated tip.
- "Positive Lock Pulldown" design locks sprayer in place.
- Hot/cold ceramic disk valve cartridge.
- Minimum install hole size 1-1/2".
- Adjustable handle tension.
- Compatible with reverse osmosis water and systems.
- Made from solid brass.

MEETS THE FOLLOWING:

- ASME A112.18.1
- CSA B125.1
- NSF 61, 372
- CALGreen
- ICC Approved



TRADITIONAL PLP PULL-DOWN FAUCET/ ANGLED SPOUT / LEVER SPRAYER

MODEL: 5610

LIST PRICES:

GRP 1 : 2841

GRP 2 : 2982

GRP 3 : 3887

SS : N/A

- 18" overall height
- 6 degree angled spout directs water towards middle of sink.
- Spout has 9" reach and can swivel 360 degrees.
- Lever handle spray head pulls out 18" from spout.
- 1.75 gpm maximum flow rate with aerated tip.
- "Positive Lock Pulldown" design locks sprayer in place.
- Hot/cold ceramic disk valve cartridge.
- Minimum install hole size 1-1/2".
- Adjustable handle tension.
- Compatible with reverse osmosis water and systems.
- Made from solid brass.

MEETS THE FOLLOWING:

- ASME A112.18.1
- CSA B125.1
- NSF 61, 372
- CALGreen
- ICC Approved



FINISH GROUP 1: CH
 FINISH GROUP 2: BLN, CD, CHB, CLZ, GR, MB, MW, PB, PN, SB, SC, SN, UPB
 FINISH GROUP 3: AB, ABZ, AC, AMB, AP, CB, DAB, DAC, DAMB, DAP, MAB, MAC, MAP, ORB, PC, TB

PRECIOUS METALS: PG, SG - 30% increase from Group 3*
 STAINLESS STEEL: SS *Pricing subject to change

TRADITIONAL PREP SIZE PLP PULL-DOWN FAUCET / LEVER SPRAYER

MODEL: 5200

LIST PRICES:

GRP 1 : 2653

GRP 2 : 2784

GRP 3 : 3628

SS : N/A

MEETS THE FOLLOWING:

- ASME A112.18.1
- CSA B125.1
- NSF 61, 372
- CALGreen
- ICC Approved

- 16" overall height.
- Spout has 7" reach and can swivel 360 degrees.
- Lever handle spray head pulls out 18" from spout.
- 1.75 gpm maximum flow rate with aerated tip.
- Smaller food prep version of standard reach PLP Pull-down Faucet.
- "Positive Lock Pulldown" design locks sprayer in place.
- Hot/cold ceramic disk valve cartridge.
- Minimum install hole size 1-1/2".
- Adjustable handle tension.
- Compatible with reverse osmosis water and systems.
- Made from solid brass.



TRADITIONAL PREP SIZE PLP PULL-DOWN FAUCET / ANGLED SPOUT / LEVER SPRAYER

MODEL: 5210

LIST PRICES:

GRP 1 : 2730

GRP 2 : 2865

GRP 3 : 3734

SS : N/A

MEETS THE FOLLOWING:

- ASME A112.18.1
- CSA B125.1
- NSF 61, 372
- CALGreen
- ICC Approved

- 16" overall height.
- 10 degree angled spout directs water flow towards middle of sink.
- Spout has 8" reach and can swivel 360 degrees.
- Lever handle spray head pulls out 18" from spout.
- 1.75 gpm maximum flow rate with aerated tip.
- "Positive Lock Pulldown" design locks sprayer in place
- Smaller food prep version of standard reach PLP Pull-down.
- Hot/cold ceramic disk valve cartridge.
- Minimum install hole size 1-1/2".
- Adjustable handle tension.
- Compatible with reverse osmosis water and systems.
- Made from solid brass.



CONTEMPORARY PLP



• 5800-4-PN/BLN



CONTEMPORARY EXTENDED REACH PLP PULL-DOWN FAUCET / TOGGLE SPRAYER
MODEL: 5300

LIST PRICES:

GRP 1 : 2947

GRP 2 : 3093

GRP 3 : 4032

SS : 4140

- 21-1/2" overall height.
- Spout has 11-1/8" extended reach for larger sinks and can swivel 360 degrees.
- Toggle handle spray head pulls out 18" from spout.
- 1.75 gpm maximum flow rate with aerated tip.
- "Positive Lock Pulldown" design locks sprayer in place when not in use.
- Hot/cold ceramic disk valve cartridge.
- Minimum install hole size 1-1/2".
- Adjustable handle tension.
- Compatible with reverse osmosis water and systems.
- Made from solid brass or 316 stainless steel.

MEETS THE FOLLOWING:

- ASME A112.18.1
- CSA B125.1
- NSF 61, 372
- CALGreen
- ICC Approved



CONTEMPORARY EXTENDED REACH PLP PULL-DOWN FAUCET / LEVER SPRAYER
MODEL: 5700

LIST PRICES:

GRP 1 : 3021

GRP 2 : 3171

GRP 3 : 4132

SS : 4245

- 21-1/2" overall height.
- Spout has 11-1/8" extended reach for larger sinks and can swivel 360 degrees.
- Lever handle spray head pulls out 18" from spout.
- 1.75 gpm maximum flow rate with aerated tip.
- "Positive Lock Pulldown" design locks sprayer in place when not in use.
- Hot/cold ceramic disk valve cartridge.
- Minimum install hole size 1-1/2".
- Adjustable handle tension.
- Compatible with reverse osmosis water and systems.
- Made from solid brass or 316 stainless steel.

MEETS THE FOLLOWING:

- ASME A112.18.1
- CSA B125.1
- NSF 61, 372
- CALGreen
- ICC Approved



CONTEMPORARY PLP PULL-DOWN FAUCET / TOGGLE SPRAYER
MODEL: 5400

LIST PRICES:

GRP 1 : 2657

GRP 2 : 2789

GRP 3 : 3636

SS : 3733

- 17" overall height
- Spout has 8-5/8" reach and can swivel 360 degrees.
- Toggle handle spray head pulls out 18" from spout.
- 1.75 gpm maximum flow rate with aerated tip.
- "Positive Lock Pulldown" design locks sprayer in place when not in use.
- Hot/cold ceramic disk valve cartridge.
- Minimum install hole size 1-1/2".
- Adjustable handle tension.
- Compatible with reverse osmosis water and systems.
- Made from solid brass or 316 stainless steel.

MEETS THE FOLLOWING:

- ASME A112.18.1
- CSA B125.1
- NSF 61, 372
- CALGreen
- ICC Approved



FINISH GROUP 1: CH
 FINISH GROUP 2: BLN, CD, CHB, CLZ, GR, MB, MW, PB, PN, SB, SC, SN, UPB
 FINISH GROUP 3: AB, ABZ, AC, AMB, AP, CB, DAB, DAC, DAMB, DAP, MAB, MAC, MAP, ORB, PC, TB

PRECIOUS METALS: PG, SG - 30% increase from Group 3*
 STAINLESS STEEL: SS *Pricing subject to change

CONTEMPORARY PLP PULL-DOWN FAUCET / LEVER SPRAYER

MODEL: 5800

LIST PRICES:

GRP 1 : 2902

GRP 2 : 3046

GRP 3 : 3970

SS : 4077

- 17" overall height
- Spout has 8-5/8" reach and swivels 360 degrees.
- Lever handle spray head pulls out 18" from spout.
- Sprayer instantly diverts water from aerated stream to wide spray when lever handle is held.
- 1.75 gpm maximum flow rate with aerated tip.
- "Positive Lock Pulldown" design locks sprayer in place when not in use.
- Hot/cold ceramic disk valve cartridge.
- Minimum install hole size 1-1/2".
- Adjustable handle tension.
- Compatible with reverse osmosis water and systems.
- Made from solid brass or 316 stainless steel.

MEETS THE FOLLOWING:

- ASME A112.18.1
- CSA B125.1
- NSF 61, 372
- CALGreen
- ICC Approved



CONTEMPORARY PLP PULL-DOWN FAUCET / ANGLED SPOUT / TOGGLE SPRAYER

MODEL: 5410

LIST PRICES:

GRP 1 : 2734

GRP 2 : 2871

GRP 3 : 3741

SS : 3842

- 17" spout height.
- 7 degree angled spout directs water flow towards middle of sink.
- Spout has 9" reach and can swivel 360 degrees.
- Toggle handle spray head pulls out 18" from spout.
- 1.75 gpm maximum flow rate with aerated tip.
- "Positive Lock Pulldown" design locks sprayer in place when not in use.
- Hot/cold ceramic disk valve cartridge.
- Minimum install hole size 1-1/2".
- Adjustable handle tension.
- Compatible with reverse osmosis water and systems.
- Made from solid brass or 316 stainless steel.

MEETS THE FOLLOWING:

- ASME A112.18.1
- CSA B125.1
- NSF 61, 372
- CALGreen
- ICC Approved



CONTEMPORARY PLP PULL-DOWN FAUCET / ANGLED SPOUT / LEVER SPRAYER

MODEL: 5810

LIST PRICES:

GRP 1 : 2991

GRP 2 : 3139

GRP 3 : 4092

SS : 4202

- 17" overall height
- 7 degree angled spout flows outward towards middle of sink.
- Spout has 9-1/8" reach and can swivel 360 degrees.
- Lever handle spray head pulls out 18" from spout.
- 1.75 gpm maximum flow rate with aerated tip.
- "Positive Lock Pulldown" design locks sprayer in place when not in use.
- Hot/cold ceramic disk valve cartridge.
- Minimum install hole size 1-1/2".
- Adjustable handle tension.
- Compatible with reverse osmosis water and systems.
- Made from solid brass or 316 stainless steel.

MEETS THE FOLLOWING:

- ASME A112.18.1
- CSA B125.1
- NSF 61, 372
- CALGreen
- ICC Approved



FINISH GROUP 1: CH
 FINISH GROUP 2: BLN, CD, CHB, CLZ, GR, MB, MW, PB, PN, SB, SC, SN, UPB
 FINISH GROUP 3: AB, ABZ, AC, AMB, AP, CB, DAB, DAC, DAMB, DAP, MAB, MAC, MAP, ORB, PC, TB

PRECIOUS METALS: PG, SG - 30% increase from Group 3*
 STAINLESS STEEL: SS *Pricing subject to change

CONTEMPORARY PREP SIZE PLP PULL-DOWN FAUCET / TOGGLE SPRAYER

MODEL: 5900

LIST PRICES:

GRP 1 : 2644

GRP 2 : 2777

GRP 3 : 3619

SS : 3716

- 16" overall height.
- Spout has 7-5/8" reach and can swivel 360 degrees.
- Toggle handle spray head pulls out 18" from spout.
- Counterbalanced weight on spray hose allows smooth pull out and prevents snap back.
- 1.75 gpm maximum flow rate with aerated tip.
- "Positive Lock Pulldown" design locks sprayer in place when not in use.
- Hot/cold ceramic disk valve cartridge.
- Minimum install hole size 1-1/2".
- Adjustable handle tension.
- Compatible with reverse osmosis water and systems.
- Made from solid brass or 316 stainless steel.

MEETS THE FOLLOWING:

- ASME A112.18.1
- CSA B125.1
- NSF 61, 372
- CALGreen
- ICC Approved



CONTEMPORARY PREP SIZE PLP PULL-DOWN FAUCET / LEVER SPRAYER

MODEL: 5930

LIST PRICES:

GRP 1 : 2789

GRP 2 : 2930

GRP 3 : 3817

SS : 3921

- 16" overall height.
- Spout has 7-5/8" reach and can swivel 360 degrees.
- Lever handle spray head pulls out 18" from spout.
- 1.75 gpm maximum flow rate with aerated tip.
- Hot/cold ceramic disk valve cartridge.
- "Positive Lock Pulldown" design locks sprayer in place when not in use.
- Hot/cold ceramic disk valve cartridge.
- Minimum install hole size 1-1/2".
- Adjustable handle tension.
- Compatible with reverse osmosis water and systems.
- Made from solid brass or 316 stainless steel.

MEETS THE FOLLOWING:

- ASME A112.18.1
- CSA B125.1
- NSF 61, 372
- CALGreen
- ICC Approved



CONTEMPORARY PREP SIZE PLP PULL-DOWN FAUCET / ANGLED SPOUT / TOGGLE SPRAYER

MODEL: 5910

LIST PRICES:

GRP 1 : 2722

GRP 2 : 2859

GRP 3 : 3726

SS : 3826

- 16" overall height.
- 10 degree angled spout directs water flow towards middle of sink.
- Spout has 8-3/8" reach and can swivel 360 degrees.
- Toggle handle spray head pulls out 18" from spout.
- 1.75 gpm maximum flow rate with aerated tip.
- "Positive Lock Pulldown" design locks sprayer in place when not in use.
- Hot/cold ceramic disk valve cartridge.
- Minimum install hole size 1-1/2".
- Adjustable handle tension.
- Compatible with reverse osmosis water and systems.
- Made from solid brass or 316 stainless steel.

MEETS THE FOLLOWING:

- ASME A112.18.1
- CSA B125.1
- NSF 61, 372
- CALGreen
- ICC Approved



FINISH GROUP 1: CH
 FINISH GROUP 2: BLN, CD, CHB, CLZ, GR, MB, MW, PB, PN, SB, SC, SN, UPB
 FINISH GROUP 3: AB, ABZ, AC, AMB, AP, CB, DAB, DAC, DAMB, DAP, MAB, MAC, MAP, ORB, PC, TB

PRECIOUS METALS: PG, SG - 30% increase from Group 3*
 STAINLESS STEEL: SS *Pricing subject to change

CONTEMPORARY PREP SIZE PLP PULL-DOWN FAUCET / ANGLED SPOUT / LEVER SPRAYER MODEL: 5940

LIST PRICES:

GRP 1: 2874

GRP 2: 3017

GRP 3: 3933

SS : 4039

MEETS THE FOLLOWING:

- ASME A112.18.1
- CSA B125.1
- NSF 61, 372
- CALGreen
- ICC Approved

- 16" overall height
- 10 degree angled spout direct water flows towards middle of sink.
- Spout has 8-3/8" reach and can swivel 360 degrees.
- Lever handle spray head pulls out 18" from spout.
- 1.75 gpm maximum flow rate with aerated tip.
- "Positive Lock Pulldown" design locks sprayer in place when not in use.
- Hot/cold ceramic disk valve cartridge.
- Minimum install hole size 1-1/2".
- Adjustable handle tension.
- Compatible with reverse osmosis water and systems.
- Made from solid brass or 316 stainless steel.



INDUSTRIAL PLP



- 9700-SN
- 9010-SN
- 9065-SN



INDUSTRIAL EXTENDED REACH PLP PULL-DOWN FAUCET / TOGGLE SPRAYER

Model: 9300

LIST PRICES:

GRP 1 : 2307

GRP 2 : 2422

GRP 3 : 3156

SS : 3242

MEETS THE FOLLOWING:

- ASME A112.18.1
- CSA B125.1
- NSF 61, 372
- CALGreen
- ICC Approved

- 21-1/2" overall height
- Spout has 11-1/8" extended reach for larger sinks and can swivel 360 degrees.
- Toggle handle spray head pulls out 18" from spout.
- 1.75 gpm maximum flow rate with aerated tip.
- Modern diamond knurling.
- "Positive Lock Pulldown" design locks sprayer in place when not in use.
- Hot/cold ceramic disk valve cartridge.
- Minimum install hole size 1-1/2".
- Wave spring handle tension.
- Compatible with reverse osmosis water and systems.
- Made from solid brass or 316 stainless steel.



INDUSTRIAL EXTENDED REACH PLP PULL-DOWN FAUCET / LEVER SPRAYER

MODEL: 9700

LIST PRICES:

GRP 1 : 2687

GRP 2 : 2821

GRP 3 : 3676

SS : 3775

MEETS THE FOLLOWING:

- ASME A112.18.1
- CSA B125.1
- NSF 61, 372
- CALGreen
- ICC Approved

- 21-1/2" overall height
- Spout has 11-1/8" extended reach for larger sinks and can swivel 360 degrees.
- Lever handle spray head pulls out 18" from spout.
- 1.75 gpm maximum flow rate with aerated tip.
- Modern diamond knurling.
- "Positive Lock Pulldown" design locks sprayer in place when not in use.
- Hot/cold ceramic disk valve cartridge.
- Minimum install hole size 1-1/2".
- Wave spring handle tension.
- Compatible with reverse osmosis water and systems.
- Made from solid brass or 316 stainless steel.



INDUSTRIAL PLP PULL-DOWN FAUCET / TOGGLE SPRAYER

MODEL: 9400

LIST PRICES:

GRP 1 : 2068

GRP 2 : 2172

GRP 3 : 2830

SS : 2907

MEETS THE FOLLOWING:

- ASME A112.18.1
- CSA B125.1
- NSF 61, 372
- CALGreen
- ICC Approved

- 17" overall height
- Spout has 8-5/8" reach and can swivel 360 degrees.
- Toggle handle spray head pulls out 18" from spout.
- Spray swivel design is fully insulated against heat.
- 1.75 gpm maximum flow rate with aerated tip.
- Modern diamond knurling.
- "Positive Lock Pulldown" design locks sprayer in place when not in use.
- Hot/cold ceramic disk valve cartridge.
- Minimum install hole size 1-1/2".
- Wave spring handle tension.
- Compatible with reverse osmosis water and systems.
- Made from solid brass or 316 stainless steel.



FINISH GROUP 1: CH
 FINISH GROUP 2: BLN, CD, CHB, CLZ, GR, MB, MW, PB, PN, SB, SC, SN, UPB
 FINISH GROUP 3: AB, ABZ, AC, AMB, AP, CB, DAB, DAC, DAMB, DAP, MAB, MAC, MAP, ORB, PC, TB

PRECIOUS METALS: PG, SG - 30% increase from Group 3*
 STAINLESS STEEL: SS *Pricing subject to change

INDUSTRIAL PLP PULL-DOWN FAUCET / LEVER SPRAYER
MODEL: 9800

LIST PRICES:

GRP 1 : 2445

GRP 2 : 2568

GRP 3 : 3345

SS : 3435

MEETS THE FOLLOWING:

- ASME A112.18.1
- CSA B125.1
- NSF 61, 372
- CALGreen
- ICC Approved

- 17" overall height.
- Spout has 8-5/8" reach and can swivel 360 degrees.
- Lever handle spray head pulls out 18" from spout.
- Spray swivel design is fully insulated against heat.
- 1.75 gpm maximum flow rate with aerated tip.
- Modern diamond knurling.
- "Positive Lock Pulldown" design locks sprayer in place when not in use.
- Hot/cold ceramic disk valve cartridge.
- Minimum install hole size 1-1/2".
- Wave spring handle tension.
- Compatible with reverse osmosis water and systems.
- Made from solid brass or 316 stainless steel.



INDUSTRIAL PLP PULL-DOWN FAUCET / ANGLED SPOUT / TOGGLE SPRAYER
MODEL: 9410

LIST PRICES:

GRP 1 : 2180

GRP 2 : 2288

GRP 3 : 2982

SS : 3062

MEETS THE FOLLOWING:

- ASME A112.18.1
- CSA B125.1
- NSF 61, 372
- CALGreen
- ICC Approved

- 17" overall height
- 7 degree angled spout flows outward towards middle of sink.
- Spout has 9" reach and can swivel 360 degrees.
- Spray swivel design is fully insulated against heat.
- Toggle handle spray head pulls out 18" from spout.
- 1.75 gpm maximum flow rate with aerated tip.
- Modern diamond knurling.
- "Positive Lock Pulldown" design locks sprayer in place when not in use.
- Hot/cold ceramic disk valve cartridge.
- Minimum install hole size 1-1/2".
- Wave spring handle tension.
- Compatible with reverse osmosis water and systems.
- Made from solid brass or 316 stainless steel.



INDUSTRIAL PLP PULL-DOWN FAUCET / ANGLED SPOUT / LEVER SPRAYER
MODEL: 9810

LIST PRICES:

GRP 1 : 2549

GRP 2 : 2676

GRP 3 : 3488

SS : 3582

MEETS THE FOLLOWING:

- ASME A112.18.1
- CSA B125.1
- NSF 61, 372
- CALGreen
- ICC Approved

- 17" overall height
- 7 degree angled spout flows outward towards middle of sink.
- Spout has 9-1/8" reach and can swivel 360 degrees.
- Lever handle spray head pulls out 18" from spout.
- 1.75 gpm maximum flow rate with aerated tip.
- Modern diamond knurling.
- "Positive Lock Pulldown" design locks sprayer in place when not in use.
- Hot/cold ceramic disk valve cartridge.
- Minimum install hole size 1-1/2".
- Wave spring handle tension.
- Compatible with reverse osmosis water and systems.
- Made from solid brass or 316 stainless steel.



FINISH GROUP 1: CH
 FINISH GROUP 2: BLN, CD, CHB, CLZ, GR, MB, MW, PB, PN, SB, SC, SN, UPB
 FINISH GROUP 3: AB, ABZ, AC, AMB, AP, CB, DAB, DAC, DAMB, DAP, MAB, MAC, MAP, ORB, PC, TB

PRECIOUS METALS: PG, SG - 30% increase from Group 3*
 STAINLESS STEEL: SS *Pricing subject to change

**INDUSTRIAL PREP SIZE PLP PULL-DOWN FAUCET / TOGGLE SPRAYER
MODEL: 9900**

LIST PRICES:
GRP 1 : 2046
GRP 2 : 2149
GRP 3 : 2799
SS : 2874

MEETS THE FOLLOWING:

- ASME A112.18.1
- CSA B125.1
- NSF 61, 372
- CALGreen
- ICC Approved

- 16" overall height.
- Spout has 7-5/8" reach and can swivel 360 degrees.
- Toggle handle spray head pulls out 18" from spout.
- 1.75 gpm maximum flow rate with aerated tip.
- Modern diamond knurling.
- "Positive Lock Pulldown" design locks sprayer in place when not in use.
- Hot/cold ceramic disk valve cartridge.
- Minimum install hole size 1-1/2".
- Wave spring handle tension.
- Compatible with reverse osmosis water and systems.
- Made from solid brass or 316 stainless steel.



**INDUSTRIAL PREP SIZE PLP PULL-DOWN FAUCET / LEVER SPRAYER
MODEL: 9930**

LIST PRICES:
GRP 1 : 2415
GRP 2 : 2537
GRP 3 : 3305
SS : 3394

MEETS THE FOLLOWING:

- ASME A112.18.1
- CSA B125.1
- NSF 61, 372
- CALGreen
- ICC Approved

- 16" overall height.
- Spout has 7-5/8" reach and can swivel 360 degrees.
- Lever handle spray head pulls out 18" from spout.
- 1.75 gpm maximum flow rate with aerated tip.
- Modern diamond knurling.
- "Positive Lock Pulldown" design locks sprayer in place when not in use.
- Hot/cold ceramic disk valve cartridge.
- Minimum install hole size 1-1/2".
- Wave spring handle tension.
- Compatible with reverse osmosis water and systems.
- Made from solid brass or 316 stainless steel.



**INDUSTRIAL PREP SIZE PLP PULL-DOWN FAUCET / ANGLED SPOUT / TOGGLE SPRAYER
MODEL: 9910**

LIST PRICES:
GRP 1 : 2051
GRP 2 : 2154
GRP 3 : 2806
SS : 2883

MEETS THE FOLLOWING:

- ASME A112.18.1
- CSA B125.1
- NSF 61, 372
- CALGreen
- ICC Approved

- 16" overall height.
- 10 degree angled directs water outward towards middle of sink.
- Spout has 8-3/8" reach and can swivel 360 degrees.
- Toggle handle spray head pulls out 18" from spout.
- 1.75 gpm maximum flow rate with aerated tip.
- Modern diamond knurling.
- "Positive Lock Pulldown" design locks sprayer in place when not in use.
- Hot/cold ceramic disk valve cartridge.
- Minimum install hole size 1-1/2".
- Wave spring handle tension.
- Compatible with reverse osmosis water and systems.
- Made from solid brass or 316 stainless steel.



FINISH GROUP 1: CH
 FINISH GROUP 2: BLN, CD, CHB, CLZ, GR, MB, MW, PB, PN, SB, SC, SN, UPB
 FINISH GROUP 3: AB, ABZ, AC, AMB, AP, CB, DAB, DAC, DAMB, DAP, MAB, MAC, MAP, ORB, PC, TB

PRECIOUS METALS: PG, SG - 30% increase from Group 3*
 STAINLESS STEEL: SS *Pricing subject to change

INDUSTRIAL PREP SIZE PLP PULL-DOWN FAUCET / ANGLED SPOUT / LEVER SPRAYER MODEL: 9940

LIST PRICES:

GRP 1 : 2421

GRP 2 : 2542

GRP 3 : 3312

SS : 3402

MEETS THE FOLLOWING:

- ASME A112.18.1
- CSA B125.1
- NSF 61, 372
- CALGreen
- ICC Approved

- 16" overall height
- 10 degree angled spout flows outward towards middle of sink.
- Spout has 8-3/8" reach and can swivel 360 degrees.
- Lever handle spray head pulls out 18" from spout.
- 1.75 gpm maximum flow rate with aerated tip.
- Modern diamond knurling.
- "Positive Lock Pulldown" design locks sprayer in place when not in use.
- Hot/cold ceramic disk valve cartridge.
- Minimum install hole size 1-1/2".
- Wave spring handle tension.
- Compatible with reverse osmosis water and systems.
- Made from solid brass or 316 stainless steel.



MODERN PLP



- 9750-CH
- 3030-CH
- 1400H-CH



MODERN EXTENDED REACH PLP PULL-DOWN FAUCET / TOGGLE SPRAYER

MODEL: 9350

LIST PRICES:

GRP 1 : 2220

GRP 2 : 2330

GRP 3 : 3037

SS : 3120

- 21-1/2" overall height.
- Spout has 11-1/8" extended reach for larger sinks and can swivel 360 degrees.
- Toggle handle spray head pulls out 18" from spout.
- 1.75 gpm maximum flow rate with aerated tip.
- "Positive Lock Pulldown" design locks sprayer in place when not in use.
- Hot/cold ceramic disk valve cartridge.
- Minimum install hole size 1-1/2".
- Wave spring handle tension.
- Compatible with reverse osmosis water and systems.
- Made from solid brass or 316 stainless steel.

MEETS THE FOLLOWING:

- ASME A112.18.1
- CSA B125.1
- NSF 61, 372
- CALGreen
- ICC Approved



MODERN EXTENDED REACH PLP PULL-DOWN FAUCET / LEVER SPRAYER

MODEL: 9750

LIST PRICES:

GRP 1 : 2600

GRP 2 : 2731

GRP 3 : 3559

SS : 3654

- 21-1/2" overall height.
- Spout has 11-1/8" extended reach for larger sinks and can swivel 360 degrees.
- Lever handle spray head pulls out 18" from spout.
- 1.75 gpm maximum flow rate with aerated tip.
- "Positive Lock Pulldown" design locks sprayer in place when not in use.
- Hot/cold ceramic disk valve cartridge.
- Minimum install hole size 1-1/2".
- Wave spring handle tension.
- Compatible with reverse osmosis water and systems.
- Made from solid brass or 316 stainless steel.

MEETS THE FOLLOWING:

- ASME A112.18.1
- CSA B125.1
- NSF 61, 372
- CALGreen
- ICC Approved



MODERN PLP PULL-DOWN FAUCET / TOGGLE SPRAYER

MODEL: 9450

LIST PRICES:

GRP 1 : 1982

GRP 2 : 2081

GRP 3 : 2712

SS : 2785

- 17" overall height.
- Spout has 8-5/8" reach and can swivel 360 degrees.
- Toggle handle spray head pulls out 18" from spout.
- 1.75 gpm maximum flow rate with aerated tip.
- "Positive Lock Pulldown" design locks sprayer in place when not in use.
- Hot/cold ceramic disk valve cartridge.
- Minimum install hole size 1-1/2".
- Wave spring handle tension.
- Compatible with reverse osmosis water and systems.
- Made from solid brass or 316 stainless steel.

MEETS THE FOLLOWING:

- ASME A112.18.1
- CSA B125.1
- NSF 61, 372
- CALGreen
- ICC Approved



FINISH GROUP 1: CH
 FINISH GROUP 2: BLN, CD, CHB, CLZ, GR, MB, MW, PB, PN, SB, SC, SN, UPB
 FINISH GROUP 3: AB, ABZ, AC, AMB, AP, CB, DAB, DAC, DAMB, DAP, MAB, MAC, MAP, ORB, PC, TB

PRECIOUS METALS: PG, SG - 30% increase from Group 3*
 STAINLESS STEEL: SS *Pricing subject to change

MODERN PLP PULL-DOWN FAUCET / LEVER SPRAYER

MODEL: 9850

LIST PRICES:

GRP 1 : 2358

GRP 2 : 2476

GRP 3 : 3227

SS : 3313

- 17" overall height.
- Spout has 8-5/8" reach and can swivel 360 degrees.
- Lever handle spray head pulls out 18" from spout.
- 1.75 gpm maximum flow rate with aerated tip.
- "Positive Lock Pulldown" design locks sprayer in place when not in use.
- Hot/cold ceramic disk valve cartridge.
- Minimum install hole size 1-1/2".
- Wave spring handle tension.
- Compatible with reverse osmosis water and systems.
- Made from solid brass or 316 stainless steel.

MEETS THE FOLLOWING:

- ASME A112.18.1
- CSA B125.1
- NSF 61, 372
- CALGreen
- ICC Approved



MODERN PLP PULL-DOWN FAUCET / ANGLED SPOUT / TOGGLE SPRAYER

MODEL: 9460

LIST PRICES:

GRP 1 : 2093

GRP 2 : 2198

GRP 3 : 2863

SS : 2942

- 17" overall height.
- 7 degree angled spout directs water outward towards middle of sink.
- Spout has 9" reach and can swivel 360 degrees.
- Toggle handle spray head pulls out 18" from spout.
- 1.75 gpm maximum flow rate with aerated tip.
- "Positive Lock Pulldown" design locks sprayer in place when not in use.
- Hot/cold ceramic disk valve cartridge.
- Minimum install hole size 1-1/2".
- Wave spring handle tension.
- Compatible with reverse osmosis water and systems.
- Made from solid brass or 316 stainless steel.

MEETS THE FOLLOWING:

- ASME A112.18.1
- CSA B125.1
- NSF 61, 372
- CALGreen
- ICC Approved



MODERN PLP PULL-DOWN FAUCET / ANGLED SPOUT / LEVER SPRAYER

MODEL: 9860

LIST PRICES:

GRP 1 : 2462

GRP 2 : 2586

GRP 3 : 3370

SS : 3460

- 17" overall height
- Spout has 9-1/8" reach and can swivel 360 degrees.
- Lever handle spray head pulls out 18" from spout.
- 1.75 gpm maximum flow rate with aerated tip.
- "Positive Lock Pulldown" design locks sprayer in place when not in use.
- Hot/cold ceramic disk valve cartridge.
- Minimum install hole size 1-1/2".
- Wave spring handle tension.
- Compatible with reverse osmosis water and systems.
- Made from solid brass or 316 stainless steel.

MEETS THE FOLLOWING:

- ASME A112.18.1
- CSA B125.1
- NSF 61, 372
- CALGreen
- ICC Approved



FINISH GROUP 1: CH
 FINISH GROUP 2: BLN, CD, CHB, CLZ, GR, MB, MW, PB, PN, SB, SC, SN, UPB
 FINISH GROUP 3: AB, ABZ, AC, AMB, AP, CB, DAB, DAC, DAMB, DAP, MAB, MAC, MAP, ORB, PC, TB

PRECIOUS METALS: PG, SG - 30% increase from Group 3*
 STAINLESS STEEL: SS *Pricing subject to change

**MODERN PREP SIZE PLP PULL-DOWN FAUCET / TOGGLE SPRAYER
MODEL: 9950**

LIST PRICES:
GRP 1 : 1959
GRP 2 : 2057
GRP 3 : 2680
SS : 2752

MEETS THE FOLLOWING:

- ASME A112.18.1
- CSA B125.1
- NSF 61, 372
- CALGreen
- ICC Approved

- 16" overall height.
- Spout has 7-5/8" reach and can swivel 360 degrees.
- Toggle handle spray head pulls out 18" from spout.
- 1.75 gpm maximum flow rate with aerated tip.
- "Positive Lock Pulldown" design locks sprayer in place when not in use.
- Hot/cold ceramic disk valve cartridge.
- Minimum install hole size 1-1/2".
- Wave spring handle tension.
- Compatible with reverse osmosis water and systems.
- Made from solid brass or 316 stainless steel.



**MODERN PREP SIZE PLP PULL-DOWN FAUCET / LEVER SPRAYER
MODEL: 9980**

LIST PRICES:
GRP 1 : 2328
GRP 2 : 2445
GRP 3 : 3185
SS : 3272

MEETS THE FOLLOWING:

- ASME A112.18.1
- CSA B125.1
- NSF 61, 372
- CALGreen
- ICC Approved

- 16" overall height.
- Spout has 7-5/8" reach and can swivel 360 degrees.
- Lever handle spray head pulls out 18" from spout.
- 1.75 gpm maximum flow rate with aerated tip.
- "Positive Lock Pulldown" design locks sprayer in place when not in use.
- Hot/cold ceramic disk valve cartridge.
- Minimum install hole size 1-1/2".
- Wave spring handle tension.
- Compatible with reverse osmosis water and systems.
- Made from solid brass or 316 stainless steel.



**MODERN PREP SIZE PLP PULL-DOWN FAUCET / ANGLED SPOUT / TOGGLE SPRAYER
MODEL: 9960**

LIST PRICES:
GRP 1 : 1965
GRP 2 : 2063
GRP 3 : 2688
SS : 2761

MEETS THE FOLLOWING:

- ASME A112.18.1
- CSA B125.1
- NSF 61, 372
- CALGreen
- ICC Approved

- 16" overall height.
- 10 degree angled spout directs water outward towards middle of sink.
- Spout has 8-3/8" reach and can swivel 360 degrees.
- Toggle handle spray head pulls out 18" from spout.
- 1.75 gpm maximum flow rate with aerated tip.
- "Positive Lock Pulldown" design locks sprayer in place when not in use.
- Hot/cold ceramic disk valve cartridge.
- Minimum install hole size 1-1/2".
- Wave spring handle tension.
- Compatible with reverse osmosis water and systems.
- Made from solid brass or 316 stainless steel.



FINISH GROUP 1: CH
 FINISH GROUP 2: BLN, CD, CHB, CLZ, GR, MB, MW, PB, PN, SB, SC, SN, UPB
 FINISH GROUP 3: AB, ABZ, AC, AMB, AP, CB, DAB, DAC, DAMB, DAP, MAB, MAC, MAP, ORB, PC, TB

PRECIOUS METALS: PG, SG - 30% increase from Group 3*
 STAINLESS STEEL: SS *Pricing subject to change

**MODERN PREP SIZE PLP PULL-DOWN FAUCET / ANGLED SPOUT / LEVER SPRAYER
MODEL: 9990**

LIST PRICES:

GRP 1 : 2335

GRP 2 : 2451

GRP 3 : 3194

SS : 3281

MEETS THE FOLLOWING:

- ASME A112.18.1
- CSA B125.1
- NSF 61, 372
- CALGreen
- ICC Approved

- 16" overall height.
- 10 degree angled spout directs water outward towards middle of sink.
- Spout has 8-3/8" reach and can swivel 360 degrees.
- Lever handle spray head pulls out 18" from spout.
- 1.75 gpm maximum flow rate with aerated tip.
- "Positive Lock Pulldown" design locks sprayer in place when not in use.
- Hot/cold ceramic disk valve cartridge.
- Minimum install hole size 1-1/2".
- Wave spring handle tension.
- Compatible with reverse osmosis water and systems.
- Made from solid brass or 316 stainless steel.



FULTON INDUSTRIAL PLP



• 10270-MW/CLZ



FULTON INDUSTRIAL EXTENDED REACH PLP PULL-DOWN FAUCET / TOGGLE SPRAYER MODEL: 10200

LIST PRICES:

GRP 1: 2422

GRP 2: 2542

GRP 3: 3314

SS : 3404

MEETS THE FOLLOWING:

- ASME A112.18.1
- CSA B125.1
- NSF 61, 372
- CALGreen
- ICC Approved

- 20-3/16" overall height.
- 2 bend U-spout has 11-3/16" extended reach for larger sinks and can swivel 360 degrees.
- Toggle handle spray head pulls out 18" from spout.
- 1.75 gpm maximum flow rate with aerated tip.
- Modern diamond knurling.
- "Positive Lock Pulldown" design locks sprayer in place when not in use.
- Hot/cold ceramic disk valve cartridge.
- Minimum install hole size 1-1/2".
- Wave spring handle tension.
- Compatible with reverse osmosis water and systems.
- Made from solid brass or 316 stainless steel.



FULTON INDUSTRIAL EXTENDED REACH PLP PULL-DOWN FAUCET / LEVER SPRAYER MODEL: 10250

LIST PRICES:

GRP 1: 2821

GRP 2: 2961

GRP 3: 3860

SS : 3965

MEETS THE FOLLOWING:

- ASME A112.18.1
- CSA B125.1
- NSF 61, 372
- CALGreen
- ICC Approved

- 20-3/16" overall height.
- 2 bend U-spout has 11-3/16" extended reach for larger sinks and can swivel 360 degrees.
- Lever handle spray head pulls out 18" from spout.
- 1.75 gpm maximum flow rate with aerated tip.
- Modern diamond knurling.
- "Positive Lock Pulldown" design locks sprayer in place when not in use.
- Hot/cold ceramic disk valve cartridge.
- Minimum install hole size 1-1/2".
- Wave spring handle tension.
- Compatible with reverse osmosis water and systems.
- Made from solid brass or 316 stainless steel.



FULTON INDUSTRIAL PLP PULL-DOWN FAUCET / TOGGLE SPRAYER MODEL: 10210

LIST PRICES:

GRP 1: 2172

GRP 2: 2281

GRP 3: 2971

SS : 3053

MEETS THE FOLLOWING:

- ASME A112.18.1
- CSA B125.1
- NSF 61, 372
- CALGreen
- ICC Approved

- 16-1/16" overall height.
- 2 bend U-spout has 8-5/8" reach and can swivel 360 degrees.
- Toggle handle spray head pulls out 18" from spout.
- 1.75 gpm maximum flow rate with aerated tip.
- Modern diamond cut knurling.
- "Positive Lock Pulldown" design locks sprayer in place when not in use.
- Hot/cold ceramic disk valve cartridge.
- Minimum install hole size 1-1/2".
- Wave spring handle tension.
- Compatible with reverse osmosis water and systems.
- Made from solid brass or 316 stainless steel.



FINISH GROUP 1: CH
FINISH GROUP 2: BLN, CD, CHB, CLZ, GR, MB, MW, PB, PN, SB, SC, SN, UPB
FINISH GROUP 3: AB, ABZ, AC, AMB, AP, CB, DAB, DAC, DAMB, DAP, MAB, MAC, MAP, ORB, PC, TB

PRECIOUS METALS: PG, SG - 30% increase from Group 3*
STAINLESS STEEL: SS *Pricing subject to change

FULTON INDUSTRIAL PLP PULL-DOWN FAUCET / LEVER SPRAYER

MODEL: 10260

LIST PRICES:

GRP 1: 2568

GRP 2: 2696

GRP 3: 3512

SS : 3608

- 16-1/16" overall height.
- 2 bend U-spout has 8-5/8" reach and can swivel 360 degrees.
- Lever handle spray head pulls out 18" from spout.
- 1.75 gpm maximum flow rate with aerated tip.
- Modern diamond cut knurling.
- "Positive Lock Pulldown" design locks sprayer in place when not in use.
- Hot/cold ceramic disk valve cartridge.
- Minimum install hole size 1-1/2".
- Wave spring handle tension.
- Compatible with reverse osmosis water and systems.
- Made from solid brass or 316 stainless steel.

MEETS THE FOLLOWING:

- ASME A112.18.1
- CSA B125.1
- NSF 61, 372
- CALGreen
- ICC Approved



FULTON INDUSTRIAL PLP PULL-DOWN FAUCET / ANGLED SPOUT / TOGGLE SPRAYER

MODEL: 10220

LIST PRICES:

GRP 1: 2288

GRP 2: 2402

GRP 3: 3131

SS : 3215

- 16-1/16" overall height.
- 7 degree angled spout flows outward towards middle of sink.
- 2 bend U-spout has 9-1/16" reach and can swivel 360 degrees.
- Spray swivel design is fully insulated against heat.
- 1.75 gpm maximum flow rate with aerated tip. Thin, sleek faucet body design is perfect for modern kitchens.
- Modern diamond knurling.
- "Positive Lock Pulldown" design locks sprayer in place when not in use.
- Hot/cold ceramic disk valve cartridge.
- Minimum install hole size 1-1/2".
- Wave spring handle tension.
- Compatible with reverse osmosis water and systems.
- Made from solid brass or 316 stainless steel.

MEETS THE FOLLOWING:

- ASME A112.18.1
- CSA B125.1
- NSF 61, 372
- CALGreen
- ICC Approved



FULTON INDUSTRIAL PLP PULL-DOWN FAUCET / ANGLED SPOUT / LEVER SPRAYER

MODEL: 10270

LIST PRICES:

GRP 1: 2676

GRP 2: 2810

GRP 3: 3662

SS : 3761

- 16-1/16" overall height.
- 2 bend U-spout has 9-1/8" reach and can swivel 360 degrees.
- Spray swivel design is fully insulated against heat.
- Lever handle spray head pulls out 18" from spout.
- 1.75 gpm maximum flow rate with aerated tip.
- Modern diamond cut knurling gives industrial look.
- "Positive Lock Pulldown" design locks sprayer in place when not in use.
- Hot/cold ceramic disk valve cartridge.
- Minimum install hole size 1-1/2".
- Wave spring handle tension.
- Compatible with reverse osmosis water and systems.
- Made from solid brass or 316 stainless steel.

MEETS THE FOLLOWING:

- ASME A112.18.1
- CSA B125.1
- NSF 61, 372
- CALGreen
- ICC Approved



FINISH GROUP 1: CH
 FINISH GROUP 2: BLN, CD, CHB, CLZ, GR, MB, MW, PB, PN, SB, SC, SN, UPB
 FINISH GROUP 3: AB, ABZ, AC, AMB, AP, CB, DAB, DAC, DAMB, DAP, MAB, MAC, MAP, ORB, PC, TB

PRECIOUS METALS: PG, SG - 30% increase from Group 3*
 STAINLESS STEEL: SS *Pricing subject to change

**FULTON INDUSTRIAL PREP SIZE PLP PULL-DOWN FAUCET / TOGGLE SPRAYER
MODEL: 10230**

LIST PRICES:
GRP 1: 2149
GRP 2: 2256
GRP 3: 2938
SS : 3018

MEETS THE FOLLOWING:

- ASME A112.18.1
- CSA B125.1
- NSF 61, 372
- CALGreen
- ICC Approved

- 15-3/16" overall height.
- 2 bend U-spout has 7-5/8" reach and can swivel 360 degrees.
- Toggle handle spray head pulls out 18" from spout.
- 1.75 gpm maximum flow rate with aerated tip.
- Modern diamond cut knurling.
- "Positive Lock Pulldown" design locks sprayer in place when not in use.
- Hot/cold ceramic disk valve cartridge.
- Minimum install hole size 1-1/2".
- Wave spring handle tension.
- Compatible with reverse osmosis water and systems.
- Made from solid brass or 316 stainless steel.



**FULTON INDUSTRIAL PREP SIZE PLP PULL-DOWN FAUCET / LEVER SPRAYER
MODEL: 10280**

LIST PRICES:
GRP 1: 2550
GRP 2: 2677
GRP 3: 3487
SS : 3582

MEETS THE FOLLOWING:

- ASME A112.18.1
- CSA B125.1
- NSF 61, 372
- CALGreen
- ICC Approved

- 15-3/16" overall height.
- 2 bend U-spout has 7-5/8" reach and can swivel 360 degrees.
- Lever handle spray head pulls out 18" from spout.
- 1.75 gpm maximum flow rate with aerated tip.
- Modern diamond cut knurling.
- "Positive Lock Pulldown" design locks sprayer in place when not in use.
- Hot/cold ceramic disk valve cartridge.
- Minimum install hole size 1-1/2".
- Wave spring handle tension.
- Compatible with reverse osmosis water and systems.
- Made from solid brass or 316 stainless steel.



**FULTON INDUSTRIAL PREP SIZE PLP PULL-DOWN FAUCET / ANGLED SPOUT / TOGGLE SPRAYER
MODEL: 10240**

LIST PRICES:
GRP 1: 2167
GRP 2: 2284
GRP 3: 2972
SS : 3051

MEETS THE FOLLOWING:

- ASME A112.18.1
- CSA B125.1
- NSF 61, 372
- CALGreen
- ICC Approved

- 15-3/16" overall height.
- 10 degree angled spout flows outward towards middle of sink.
- 2 bend U-spout has 8-3/8" reach and can swivel 360 degrees.
- Toggle handle spray head pulls out 18" from spout.
- 1.75 gpm maximum flow rate with aerated tip.
- Modern diamond cut knurling.
- "Positive Lock Pulldown" design locks sprayer in place when not in use.
- Hot/cold ceramic disk valve cartridge.
- Minimum install hole size 1-1/2".
- Wave spring handle tension.
- Compatible with reverse osmosis water and systems.
- Made from solid brass or 316 stainless steel.



FINISH GROUP 1: CH
 FINISH GROUP 2: BLN, CD, CHB, CLZ, GR, MB, MW, PB, PN, SB, SC, SN, UPB
 FINISH GROUP 3: AB, ABZ, AC, AMB, AP, CB, DAB, DAC, DAMB, DAP, MAB, MAC, MAP, ORB, PC, TB

PRECIOUS METALS: PG, SG - 30% increase from Group 3*
 STAINLESS STEEL: SS *Pricing subject to change

FULTON INDUSTRIAL PREP SIZE PLP PULL-DOWN FAUCET / ANGLED SPOUT / LEVER SPRAYER MODEL: 10290

LIST PRICES:

GRP 1: 2555

GRP 2: 2694

GRP 3: 3505

SS : 3598

MEETS THE FOLLOWING:

- ASME A112.18.1
- CSA B125.1
- NSF 61, 372
- CALGreen
- ICC Approved
- 15-3/16" overall height.
- 10 degree angled spout flows outward towards middle of sink.
- 2 bend U-spout has 8-3/8" reach and can swivel 360 degrees.
- Lever handle spray head pulls out 18" from spout.
- 1.75 gpm maximum flow rate with aerated tip.
- "Positive Lock Pulldown" design locks sprayer in place when not in use.
- Hot/cold ceramic disk valve cartridge.
- Minimum install hole size 1-1/2".
- Wave spring handle tension.
- Compatible with reverse osmosis water and systems.
- Made from solid brass or 316 stainless steel.



FULTON MODERN PLP



- 1025O-GR
- 9010-GR



FULTON MODERN EXTENDED REACH PLP PULL-DOWN FAUCET / TOGGLE SPRAYER MODEL: 10300

LIST PRICES:

GRP 1: 2330

GRP 2: 2447

GRP 3: 3189

SS : 3276

MEETS THE FOLLOWING:

- ASME A112.18.1
- CSA B125.1
- NSF 61, 372
- CALGreen
- ICC Approved

- 20-3/16" overall height.
- 2 bend U-spout has 11-3/16" extended reach for larger sinks and can swivel 360 degrees.
- Toggle handle spray head pulls out 18" from spout.
- 1.75 gpm maximum flow rate with aerated tip.
- "Positive Lock Pulldown" design locks sprayer in place when not in use.
- Hot/cold ceramic disk valve cartridge.
- Minimum install hole size 1-1/2".
- Wave spring handle tension.
- Compatible with reverse osmosis water and systems.
- Made from solid brass or 316 stainless steel.



FULTON MODERN EXTENDED REACH PLP PULL-DOWN FAUCET / LEVER SPRAYER MODEL: 10350

LIST PRICES:

GRP 1: 2730

GRP 2: 2868

GRP 3: 3737

SS : 3837

MEETS THE FOLLOWING:

- ASME A112.18.1
- CSA B125.1
- NSF 61, 372
- CALGreen
- ICC Approved

- 20-3/16" overall height.
- 2 bend U-spout has 11-3/16" extended reach for larger sinks and can swivel 360 degrees.
- Toggle handle spray head pulls out 18" from spout.
- 1.75 gpm maximum flow rate with aerated tip.
- "Positive Lock Pulldown" design locks sprayer in place when not in use.
- Hot/cold ceramic disk valve cartridge.
- Minimum install hole size 1-1/2".
- Wave spring handle tension.
- Compatible with reverse osmosis water and systems.
- Made from solid brass or 316 stainless steel.



FULTON MODERN PLP PULL-DOWN FAUCET / TOGGLE SPRAYER MODEL: 10310

LIST PRICES:

GRP 1: 2080

GRP 2: 2185

GRP 3: 2846

SS : 2925

MEETS THE FOLLOWING:

- ASME A112.18.1
- CSA B125.1
- NSF 61, 372
- CALGreen
- ICC Approved

- 16-1/16" overall height.
- 2 bend U-spout has 8-5/8" reach and can swivel 360 degrees.
- Toggle handle spray head pulls out 18" from spout.
- 1.75 gpm maximum flow rate with aerated tip.
- "Positive Lock Pulldown" design locks sprayer in place when not in use.
- Hot/cold ceramic disk valve cartridge.
- Minimum install hole size 1-1/2".
- Wave spring handle tension.
- Compatible with reverse osmosis water and systems.
- Made from solid brass or 316 stainless steel.



FINISH GROUP 1: CH
FINISH GROUP 2: BLN, CD, CHB, CLZ, GR, MB, MW, PB, PN, SB, SC, SN, UPB
FINISH GROUP 3: AB, ABZ, AC, AMB, AP, CB, DAB, DAC, DAMB, DAP, MAB, MAC, MAP, ORB, PC, TB

PRECIOUS METALS: PG, SG - 30% increase from Group 3*
STAINLESS STEEL: SS *Pricing subject to change

FULTON MODERN PLP PULL-DOWN FAUCET / LEVER SPRAYER

MODEL: 10360

LIST PRICES:

GRP 1: 2476

GRP 2: 2600

GRP 3: 3387

SS : 3480

- 16-1/16" overall height.
- 2 bend U-spout has 8-5/8" reach and can swivel 360 degrees.
- Lever handle spray head pulls out 18" from spout.
- 1.75 gpm maximum flow rate with aerated tip.
- "Positive Lock Pulldown" design locks sprayer in place when not in use.
- Hot/cold ceramic disk valve cartridge.
- Minimum install hole size 1-1/2".
- Wave spring handle tension.
- Compatible with reverse osmosis water and systems.
- Made from solid brass or 316 stainless steel.

MEETS THE FOLLOWING:

- ASME A112.18.1
- CSA B125.1
- NSF 61, 372
- CALGreen
- ICC Approved



FULTON MODERN PLP PULL-DOWN FAUCET / ANGLED SPOUT / TOGGLE SPRAYER

MODEL: 10320

LIST PRICES:

GRP 1: 2197

GRP 2: 2308

GRP 3: 3007

SS : 3089

- 16-1/16 overall height.
- 7 degree angled spout directs water outward towards middle of sink.
- 2 bend U-spout has 9-1/16" reach and can swivel 360 degrees.
- Toggle handle spray head pulls out 18" from spout.
- 1.75 gpm maximum flow rate with aerated tip.
- "Positive Lock Pulldown" design locks sprayer in place when not in use.
- Hot/cold ceramic disk valve cartridge.
- Minimum install hole size 1-1/2".
- Wave spring handle tension.
- Compatible with reverse osmosis water and systems.
- Made from solid brass or 316 stainless steel.

MEETS THE FOLLOWING:

- ASME A112.18.1
- CSA B125.1
- NSF 61, 372
- CALGreen
- ICC Approved



FULTON MODERN PLP PULL-DOWN FAUCET / ANGLED SPOUT / LEVER SPRAYER

MODEL: 10370

LIST PRICES:

GRP 1: 2585

GRP 2: 2716

GRP 3: 3538

SS : 3634

- 16-1/16" overall height.
- 7 degree angled spout directs water outward towards middle of sink.
- 2 bend U-spout has 9-1/8" reach and can swivel 360 degrees.
- Lever handle spray head pulls out 18" from spout.
- 1.75 gpm maximum flow rate with aerated tip.
- "Positive Lock Pulldown" design locks sprayer in place when not in use.
- Hot/cold ceramic disk valve cartridge.
- Minimum install hole size 1-1/2".
- Wave spring handle tension.
- Compatible with reverse osmosis water and systems.
- Made from solid brass or 316 stainless steel.

MEETS THE FOLLOWING:

- ASME A112.18.1
- CSA B125.1
- NSF 61, 372
- CALGreen
- ICC Approved



FINISH GROUP 1: CH
 FINISH GROUP 2: BLN, CD, CHB, CLZ, GR, MB, MW, PB, PN, SB, SC, SN, UPB
 FINISH GROUP 3: AB, ABZ, AC, AMB, AP, CB, DAB, DAC, DAMB, DAP, MAB, MAC, MAP, ORB, PC, TB

PRECIOUS METALS: PG, SG - 30% increase from Group 3*
 STAINLESS STEEL: SS *Pricing subject to change

FULTON MODERN PREP SIZE PLP PULL-DOWN FAUCET / TOGGLE SPRAYER**MODEL: 10330****LIST PRICES:****GRP 1: 2057****GRP 2: 2160****GRP 3: 2813****SS : 2890****MEETS THE FOLLOWING:**

- ASME A112.18.1
- CSA B125.1
- NSF 61, 372
- CALGreen
- ICC Approved

- 15-3/16" overall height.
- 2 bend U-spout has 7-5/8" reach and can swivel 360 degrees.
- Toggle handle spray head pulls out 18" from spout.
- 1.75 gpm maximum flow rate with aerated tip.
- "Positive Lock Pulldown" design locks sprayer in place when not in use.
- Hot/cold ceramic disk valve cartridge.
- Minimum install hole size 1-1/2".
- Wave spring handle tension.
- Compatible with reverse osmosis water and systems.
- Made from solid brass or 316 stainless steel.

**FULTON MODERN PREP SIZE PLP PULL-DOWN FAUCET / LEVER SPRAYER****MODEL: 10380****LIST PRICES:****GRP 1: 2445****GRP 2: 2568****GRP 3: 3344****SS : 3437****MEETS THE FOLLOWING:**

- ASME A112.18.1
- CSA B125.1
- NSF 61, 372
- CALGreen
- ICC Approved

- 15-3/16" overall height.
- 2 bend U-spout has 7-5/8" reach and can swivel 360 degrees.
- Lever handle spray head pulls out 18" from spout.
- 1.75 gpm maximum flow rate with aerated tip.
- "Positive Lock Pulldown" design locks sprayer in place when not in use.
- Hot/cold ceramic disk valve cartridge.
- Minimum install hole size 1-1/2".
- Wave spring handle tension.
- Compatible with reverse osmosis water and systems.
- Made from solid brass or 316 stainless steel.

**FULTON MODERN PREP SIZE PLP PULL-DOWN FAUCET / ANGLED SPOUT / TOGGLE SPRAYER****MODEL: 10340****LIST PRICES:****GRP 1: 2075****GRP 2: 2190****GRP 3: 2849****SS : 2923****MEETS THE FOLLOWING:**

- ASME A112.18.1
- CSA B125.1
- NSF 61, 372
- CALGreen
- ICC Approved

- 15-3/16" overall height.
- 10 degree angled spout directs water outward towards middle of sink.
- 2 bend U-spout has 8-3/8" reach and can swivel 360 degrees.
- Toggle handle spray head pulls out 18" from spout.
- 1.75 gpm maximum flow rate with aerated tip.
- "Positive Lock Pulldown" design locks sprayer in place when not in use.
- Hot/cold ceramic disk valve cartridge.
- Minimum install hole size 1-1/2".
- Wave spring handle tension.
- Compatible with reverse osmosis water and systems.
- Made from solid brass or 316 stainless steel.



FINISH GROUP 1: CH
 FINISH GROUP 2: BLN, CD, CHB, CLZ, GR, MB, MW, PB, PN, SB, SC, SN, UPB
 FINISH GROUP 3: AB, ABZ, AC, AMB, AP, CB, DAB, DAC, DAMB, DAP, MAB, MAC, MAP, ORB, PC, TB

PRECIOUS METALS: PG, SG - 30% increase from Group 3*
 STAINLESS STEEL: SS *Pricing subject to change

FULTON MODERN PREP SIZE PLP PULL-DOWN FAUCET / ANGLED SPOUT / LEVER SPRAYER MODEL: 10390

LIST PRICES:

GRP 1: 2465

GRP 2: 2602

GRP 3: 3384

SS : 3474

MEETS THE FOLLOWING:

- ASME A112.18.1
- CSA B125.1
- NSF 61, 372
- CALGreen
- ICC Approved

- 15-3/16" overall height.
- 10 degree angled spout directs water outward towards middle of sink.
- 2 bend U-spout has 8-3/8" reach and can swivel 360 degrees.
- Lever handle spray head pulls out 18" from spout.
- 1.75 gpm maximum flow rate with aerated tip.
- "Positive Lock Pulldown" design locks sprayer in place when not in use.
- Hot/cold ceramic disk valve cartridge.
- Minimum install hole size 1-1/2".
- Wave spring handle tension.
- Compatible with reverse osmosis water and systems.
- Made from solid brass or 316 stainless steel.



INDUSTRIAL 2 HANDLE PLP



• 9402-MB/CLZ



**INDUSTRIAL 2 HANDLE PLP PULL-DOWN KITCHEN FAUCET EXT. REACH / TOGGLE SPRAYER
MODEL: 9302**

LIST PRICES:

GRP 1: 1750

GRP 2: 1971

GRP 3: 2366

SS : 2484

MEETS THE FOLLOWING:

- ASME A112.18.1
- CSA B125.1
- NSF 61, 372
- CALGreen
- ICC Approved

- 21-1/2" overall height.
- Modern diamond knurling gives industrial look.
- Wave spring handle brake system provides smooth pull and prevents sagging.
- Innovative wave spring handle tension system prevents sagging and requires no adjustment.
- Spout has 11-1/8" extended reach for larger sinks and can swivel 360 degrees.
- Toggle handle spray head pulls out 18" from spout.
- 1.75 gpm maximum flow rate with aerated tip.
- Modern diamond knurling gives industrial look..
- "Positive Lock Pulldown" design locks sprayer in place when not in use.
- 1/4 turn Hot/cold ceramic disk valve cartridge.
- Minimum install hole size 1-1/2".
- Wave spring handle tension.
- Compatible with reverse osmosis water and systems.
- Made from solid brass or 316 stainless steel.



**INDUSTRIAL 2 HANDLE PLP PULL-DOWN KITCHEN FAUCET / LEVER SPRAYER
MODEL: 9702**

LIST PRICES:

GRP 1: 2117

GRP 2: 2446

GRP 3: 2599

SS : 2728

MEETS THE FOLLOWING:

- ASME A112.18.1
- CSA B125.1
- NSF 61, 372
- CALGreen
- ICC Approved

- 21-1/2" overall height.
- Spout has 11-1/8" extended reach for larger sinks and can swivel 360 degrees.
- Lever handle spray head pulls out 18" from spout.
- 1.75 gpm maximum flow rate with aerated tip.
- Modern diamond knurling.
- "Positive Lock Pulldown" design locks sprayer in place when not in use.
- 1/4 turn Hot/cold ceramic disk valve cartridge.
- Minimum install hole size 1-1/2".
- Wave spring handle tension.
- Compatible with reverse osmosis water and systems.
- Made from solid brass or 316 stainless steel.



**INDUSTRIAL 2 HANDLE PULL-DOWN KITCHEN FAUCET / TOGGLE SPRAYER
MODEL: 9402**

LIST PRICES:

GRP 1: 1715

GRP 2: 1935

GRP 3: 2331

SS : 2447

MEETS THE FOLLOWING:

- ASME A112.18.1
- CSA B125.1
- NSF 61, 372
- CALGreen
- ICC Approved

- 17" overall height.
- Modern diamond knurling gives industrial look.
- Spout has 8-5/8" reach and can swivel 360 degrees.
- Toggle handle spray head pulls out 18" from spout.
- Spray swivel design is fully insulated against heat.
- 1.75 gpm maximum flow rate with aerated tip.
- "Positive Lock Pulldown" design locks sprayer in place when not in use.
- 1/4 turn Hot/cold ceramic disk valve cartridge.
- Minimum install hole size 1-1/2".
- Wave spring handle tension.
- Compatible with reverse osmosis water and systems.
- Made from solid brass or 316 stainless steel.



FINISH GROUP 1: CH
FINISH GROUP 2: BLN, CD, CHB, CLZ, GR, MB, MW, PB, PN, SB, SC, SN, UPB
FINISH GROUP 3: AB, ABZ, AC, AMB, AP, CB, DAB, DAC, DAMB, DAP, MAB, MAC, MAP, ORB, PC, TB

PRECIOUS METALS: PG, SG - 30% increase from Group 3*
STAINLESS STEEL: SS *Pricing subject to change

INDUSTRIAL 2 HANDLE PLP PULL-DOWN KITCHEN FAUCET / LEVER SPRAYER

MODEL: 9802

LIST PRICES:

GRP 1: 2040

GRP 2: 2369

GRP 3: 2833

SS : 2974

MEETS THE FOLLOWING:

- ASME A112.18.1
- CSA B125.1
- NSF 61, 372
- CALGreen
- ICC Approved

- 17" overall height
- Spout has 8-5/8" reach and can swivel 360 degrees.
- Lever handle spray head pulls out 18" from spout.
- Spray swivel design is fully insulated against heat.
- 1.75 gpm maximum flow rate with aerated tip.
- Modern diamond knurling
- "Positive Lock Pulldown" design locks sprayer in place when not in use.
- 1/4 turn Hot/cold ceramic disk valve cartridge.
- Minimum install hole size 1-1/2".
- Wave spring handle tension.
- Compatible with reverse osmosis water and systems.
- Made from solid brass or 316 stainless steel.



INDUSTRIAL 2 HANDLE PLP PULL-DOWN KITCHEN FAUCET / ANGLED SPOUT / TOGGLE SPRAYER

MODEL: 9412

LIST PRICES:

GRP 1: 1718

GRP 2: 1939

GRP 3: 2460

SS : 2583

MEETS THE FOLLOWING:

- ASME A112.18.1
- CSA B125.1
- NSF 61, 372
- CALGreen
- ICC Approved

- 17" overall height.
- 10 degree angled spout directs water outward towards middle of the sink.
- Modern diamond knurling gives industrial look.
- 7 degree angled spout directs water outward towards middle of sink.
- Spout has 9" reach and can swivel 360 degrees.
- Spray swivel design is fully insulated against heat.
- Toggle handle spray head pulls out 18" from spout.
- 1.75 gpm maximum flow rate with aerated tip.
- "Positive Lock Pulldown" design locks sprayer in place when not in use.
- 1/4 turn Hot/cold ceramic disk valve cartridge.
- Minimum install hole size 1-1/2".
- Wave spring handle tension.
- Compatible with reverse osmosis water and systems.
- Made from solid brass or 316 stainless steel.



INDUSTRIAL 2 HANDLE PLP PULL-DOWN KITCHEN FAUCET / ANGLED SPOUT / LEVER SPRAYER

MODEL: 9812

LIST PRICES:

GRP 1: 2014

GRP 2: 2343

GRP 3: 2496

SS : 2620

MEETS THE FOLLOWING:

- ASME A112.18.1
- CSA B125.1
- NSF 61, 372
- CALGreen
- ICC Approved

- 17" overall height
- 7 degree angled spout directs water outward towards middle of sink.
- Spout has 9-1/8" reach and can swivel 360 degrees.
- Lever handle spray head pulls out 18" from spout.
- 1.75 gpm maximum flow rate with aerated tip.
- Modern diamond knurling gives industrial look.
- "Positive Lock Pulldown" design locks sprayer in place when not in use.
- 1/4 turn Hot/cold ceramic disk valve cartridge.
- Minimum install hole size 1-1/2".
- Wave spring handle tension.
- Compatible with reverse osmosis water and systems.
- Made from solid brass or 316 stainless steel.



FINISH GROUP 1: CH
 FINISH GROUP 2: BLN, CD, CHB, CLZ, GR, MB, MW, PB, PN, SB, SC, SN, UPB
 FINISH GROUP 3: AB, ABZ, AC, AMB, AP, CB, DAB, DAC, DAMB, DAP, MAB, MAC, MAP, ORB, PC, TB

PRECIOUS METALS: PG, SG - 30% increase from Group 3*
 STAINLESS STEEL: SS *Pricing subject to change

**INDUSTRIAL PREP SIZE 2 HANDLE PLP PULL-DOWN KITCHEN FAUCET / TOGGLE SPRAYER
MODEL: 9902**

LIST PRICES:

GRP 1 :1715

GRP 2 :1935

GRP 3 :2456

SS :2578

MEETS THE FOLLOWING:

- ASME A112.18.1
- CSA B125.1
- NSF 61, 372
- CALGreen
- ICC Approved

- 16" overall height
- Spout has 7-5/8" reach and can swivel 360 degrees.
- Toggle handle spray head pulls out 18" from spout.
- 1.75 gpm maximum flow rate with aerated tip.
- Modern diamond knurling gives industrial look.
- "Positive Lock Pulldown" design locks sprayer in place when not in use.
- 1/4 turn Hot/cold ceramic disk valve cartridge.
- Minimum install hole size 1-1/2".
- Wave spring handle tension.
- Compatible with reverse osmosis water and systems.
- Made from solid brass or 316 stainless steel.



**INDUSTRIAL PREP SIZE 2 HANDLE PLP PULL-DOWN KITCHEN FAUCET / ANGLED SPOUT / LEVER HANDLE
MODEL: 9932**

LIST PRICES:

GRP 1 :2040

GRP 2 :2369

GRP 3 :2514

SS :2639

MEETS THE FOLLOWING:

- ASME A112.18.1
- CSA B125.1
- NSF 61, 372
- CALGreen
- ICC Approved

- 16" overall height
- Spout has 7-5/8" reach and can swivel 360 degrees.
- Lever handle spray head pulls out 18" from spout.
- 1.75 gpm maximum flow rate with aerated tip.
- "Positive Lock Pulldown" design locks sprayer in place when not in use.
- 1/4 turn Hot/cold ceramic disk valve cartridge.
- Minimum install hole size 1-1/2".
- Wave spring handle tension.
- Compatible with reverse osmosis water and systems.
- Made from solid brass or 316 stainless steel.



**INDUSTRIAL PREP SIZE 2 HANDLE PLP PULL-DOWN KITCHEN FAUCET / ANGLED SPOUT / TOGGLE SPRAYER
MODEL: 9912**

LIST PRICES:

GRP 1 :1722

GRP 2 :1943

GRP 3 :2456

SS :2580

MEETS THE FOLLOWING:

- ASME A112.18.1
- CSA B125.1
- NSF 61, 372
- CALGreen
- ICC Approved

- 16" overall height
- 10 degree angled spout directs water outwards towards the middle of sink.
- Spout has 7-5/8" reach and can swivel 360 degrees.
- Toggle handle spray head pulls out 18" from spout.
- 1.75 gpm maximum flow rate with aerated tip.
- Modern diamond knurling gives industrial look.
- "Positive Lock Pulldown" design locks sprayer in place when not in use.
- 1/4 turn Hot/cold ceramic disk valve cartridge.
- Minimum install hole size 1-1/2".
- Wave spring handle tension.
- Compatible with reverse osmosis water and systems.
- Made from solid brass or 316 stainless steel.



FINISH GROUP 1: CH
FINISH GROUP 2: BLN, CD, CHB, CLZ, GR, MB, MW, PB, PN, SB, SC, SN, UPB
FINISH GROUP 3: AB, ABZ, AC, AMB, AP, CB, DAB, DAC, DAMB, DAP, MAB, MAC, MAP, ORB, PC, TB

PRECIOUS METALS: PG, SG - 30% increase from Group 3*
STAINLESS STEEL: SS *Pricing subject to change

INDUSTRIAL PREP SIZE 2 HANDLE PLP PULL-DOWN KITCHEN FAUCET / ANGLED SPOUT / LEVER SPRAYER MODEL: 9942

LIST PRICES:

GRP 1 :2047

GRP 2 :2376

GRP 3 :2472

SS :2595

MEETS THE FOLLOWING:

- ASME A112.18.1
- CSA B125.1
- NSF 61, 372
- CALGreen
- ICC Approved

- 16" overall height
- 10 degree angled spout flows outward towards middle of sink.
- Spout has 8-3/8" reach and can swivel 360 degrees.
- Lever handle spray head pulls out 18" from spout.
- 1.75 gpm maximum flow rate with aerated tip.
- Modern diamond knurling gives industrial look.
- "Positive Lock Pulldown" design locks sprayer in place when not in use.
- 1/4 turn Hot/cold ceramic disk valve cartridge.
- Minimum install hole size 1-1/2".
- Wave spring handle tension.
- Compatible with reverse osmosis water and systems.
- Made from solid brass or 316 stainless steel.



MODERN 2 HANDLE PLP



• 9852-CD



**MODERN EXTENDED REACH 2 HANDLE PLP PULL-DOWN FAUCET / TOGGLE SPRAYER
MODEL: 9352**

LIST PRICES:

GRP 1 :1763
GRP 2 :2288
GRP 3 :2496
SS :2650

MEETS THE FOLLOWING:

- ASME A112.18.1
- CSA B125.1
- NSF 61, 372
- CALGreen
- ICC Approved

- 21-1/2" overall height
- Spout has 11-1/8" extended reach for larger sinks and can swivel 360 degrees.
- Toggle handle spray head pulls out 18" from spout.
- 1.75 gpm maximum flow rate with aerated tip.
- "Positive Lock Pulldown" design locks sprayer in place when not in use.
- 1/4 turn Hot/cold ceramic disk valve cartridge.
- Minimum install hole size 1-1/2".
- Wave spring handle tension.
- Compatible with reverse osmosis water and systems.
- Made from solid brass or 316 stainless steel.



**MODERN EXTENDED REACH 2 HANDLE PLP PULL-DOWN FAUCET / LEVER SPRAYER
MODEL: 9752**

LIST PRICES:

GRP 1 :1847
GRP 2 :2160
GRP 3 :2475
SS :2598

MEETS THE FOLLOWING:

- ASME A112.18.1
- CSA B125.1
- NSF 61, 372
- CALGreen
- ICC Approved

- 21-1/2" overall height
- Spout has 11-1/8" extended reach for larger sinks and can swivel 360 degrees.
- Lever handle spray head pulls out 18" from spout.
- 1.75 gpm maximum flow rate with aerated tip.
- "Positive Lock Pulldown" design locks sprayer in place when not in use.
- 1/4 turn Hot/cold ceramic disk valve cartridge.
- Minimum install hole size 1-1/2".
- Wave spring handle tension.
- Compatible with reverse osmosis water and systems.
- Made from solid brass or 316 stainless steel.



**MODERN 2 HANDLE PLP PULL-DOWN FAUCET / TOGGLE SPRAYER
MODEL: 9452**

LIST PRICES:

GRP 1 :1752
GRP 2 :2038
GRP 3 :2459
SS :2620

MEETS THE FOLLOWING:

- ASME A112.18.1
- CSA B125.1
- NSF 61, 372
- CALGreen
- ICC Approved

- 17" overall height
- Spout has 8-5/8" reach and can swivel 360 degrees.
- Toggle handle spray head pulls out 18" from spout.
- When pushed, sprayer toggle button locks in place and instantly diverts water from aerated stream to wide spray.
- 1.75 gpm maximum flow rate with aerated tip.
- "Positive Lock Pulldown" design locks sprayer in place when not in use.
- 1/4 turn Hot/cold ceramic disk valve cartridge.
- Minimum install hole size 1-1/2".
- Wave spring handle tension.
- Compatible with reverse osmosis water and systems.
- Made from solid brass or 316 stainless steel.



FINISH GROUP 1: CH
 FINISH GROUP 2: BLN, CD, CHB, CLZ, GR, MB, MW, PB, PN, SB, SC, SN, UPB
 FINISH GROUP 3: AB, ABZ, AC, AMB, AP, CB, DAB, DAC, DAMB, DAP, MAB, MAC, MAP, ORB, PC, TB

PRECIOUS METALS: PG, SG - 30% increase from Group 3*
 STAINLESS STEEL: SS *Pricing subject to change

MODERN 2 HANDLE PLP PULL-DOWN FAUCET / LEVER SPRAYER

MODEL: 9852

LIST PRICES:

GRP 1 :1812

GRP 2 :2125

GRP 3 :2440

SS :2562

MEETS THE FOLLOWING:

- ASME A112.18.1
- CSA B125.1
- NSF 61, 372
- CALGreen
- ICC Approved

- 17" overall height.
- Spout has 8-5/8" reach and can swivel 360 degrees.
- Lever handle spray head pulls out 18" from spout.
- Counterbalanced weight on spray hose allows smooth pull out and prevents snap back.
- 1.75 gpm maximum flow rate with aerated tip.
- "Positive Lock Pulldown" design locks sprayer in place when not in use.
- 1/4 turn Hot/cold ceramic disk valve cartridge.
- Minimum install hole size 1-1/2".
- Wave spring handle tension.
- Compatible with reverse osmosis water and systems.
- Made from solid brass or 316 stainless steel.



MODERN 2 HANDLE PLP PULL-DOWN FAUCET / ANGLED SPOUT / TOGGLE SPRAYER

MODEL: 9462

LIST PRICES:

GRP 1 :1672

GRP 2 :1942

GRP 3 :2463

SS :2586

MEETS THE FOLLOWING:

- ASME A112.18.1
- CSA B125.1
- NSF 61, 372
- CALGreen
- ICC Approved

- 17" overall height.
- 7 degree angled spout flows outward towards middle of sink.
- Spout has 9" reach and can swivel 360 degrees.
- Toggle handle spray head pulls out 18" from spout.
- 1.75 gpm maximum flow rate with aerated tip.
- "Positive Lock Pulldown" design locks sprayer in place when not in use.
- 1/4 turn Hot/cold ceramic disk valve cartridge.
- Minimum install hole size 1-1/2".
- Wave spring handle tension.
- Compatible with reverse osmosis water and systems.
- Made from solid brass or 316 stainless steel.



MODERN 2 HANDLE PLP PULL-DOWN FAUCET / ANGLED SPOUT / LEVER SPRAYER

MODEL: 9862

LIST PRICES:

GRP 1 :1816

GRP 2 :2129

GRP 3 :2444

SS :2566

MEETS THE FOLLOWING:

- ASME A112.18.1
- CSA B125.1
- NSF 61, 372
- CALGreen
- ICC Approved

- 17" overall height.
- 7 degree angled spout directs water outward towards the middle of sink.
- Spout has 8-5/8" reach and can swivel 360 degrees.
- Lever handle spray head pulls out 18" from spout.
- Counterbalanced weight on spray hose allows smooth pull out and prevents snap back.
- 1.75 gpm maximum flow rate with aerated tip.
- "Positive Lock Pulldown" design locks sprayer in place when not in use.
- 1/4 turn Hot/cold ceramic disk valve cartridge.
- Minimum install hole size 1-1/2".
- Wave spring handle tension.
- Compatible with reverse osmosis water and systems.
- Made from solid brass or 316 stainless steel.



FINISH GROUP 1: CH
 FINISH GROUP 2: BLN, CD, CHB, CLZ, GR, MB, MW, PB, PN, SB, SC, SN, UPB
 FINISH GROUP 3: AB, ABZ, AC, AMB, AP, CB, DAB, DAC, DAMB, DAP, MAB, MAC, MAP, ORB, PC, TB

PRECIOUS METALS: PG, SG - 30% increase from Group 3*
 STAINLESS STEEL: SS *Pricing subject to change

**MODERN PREP SIZE 2 HANDLE PLP PULL-DOWN FAUCET / TOGGLE SPRAYER
MODEL: 9952**

LIST PRICES:
GRP 1 :1668
GRP 2 :1939
GRP 3 :2459
SS :2581

MEETS THE FOLLOWING:

- ASME A112.18.1
- CSA B125.1
- NSF 61, 372
- CALGreen
- ICC Approved

- 16" overall height
- Spout has 7-5/8" reach and can swivel 360 degrees.
- Toggle handle spray head pulls out 18" from spout.
- When pushed, sprayer toggle button locks in place and instantly diverts water from aerated stream to wide spray.
- Counterbalanced weight on spray hose allows smooth pull out and prevents snap back.
- 1.75 gpm maximum flow rate with aerated tip.
- "Positive Lock Pulldown" design locks sprayer in place when not in use.
- 1/4 turn Hot/cold ceramic disk valve cartridge.
- Minimum install hole size 1-1/2".
- Wave spring handle tension.
- Compatible with reverse osmosis water and systems.
- Made from solid brass or 316 stainless steel.



**MODERN PREP SIZE 2 HANDLE PLP PULL-DOWN FAUCET / LEVER SPRAYER
MODEL: 9982**

LIST PRICES:
GRP 1 :1812
GRP 2 :2125
GRP 3 :2440
SS :2562

MEETS THE FOLLOWING:

- ASME A112.18.1
- CSA B125.1
- NSF 61, 372
- CALGreen
- ICC Approved

- 16" overall height
- Spout has 7-5/8" reach and can swivel 360 degrees.
- Lever handle spray head pulls out 18" from spout.
- Counterbalanced weight on spray hose allows smooth pull out and prevents snap back.
- 1.75 gpm maximum flow rate with aerated tip.
- "Positive Lock Pulldown" design locks sprayer in place when not in use.
- 1/4 turn Hot/cold ceramic disk valve cartridge.
- Minimum install hole size 1-1/2".
- Wave spring handle tension.
- Compatible with reverse osmosis water and systems.
- Made from solid brass or 316 stainless steel.



**MODERN PREP SIZE 2 HANDLE PLP PULL-DOWN FAUCET / ANGLED SPOUT / TOGGLE SPRAYER
MODEL: 9962**

LIST PRICES:
GRP 1 :1676
GRP 2 :1946
GRP 3 :2467
SS :2590

MEETS THE FOLLOWING:

- ASME A112.18.1
- CSA B125.1
- NSF 61, 372
- CALGreen
- ICC Approved

- 16" overall height
- 10 degree angled spout directs water outward towards middle of sink.
- Spout has 8-3/8" reach and can swivel 360 degrees.
- Toggle handle spray head pulls out 18" from spout.
- Counterbalanced weight on spray hose allows smooth pull out and prevents snap back.
- 1.75 gpm maximum flow rate with aerated tip.
- "Positive Lock Pulldown" design locks sprayer in place when not in use.
- 1/4 turn Hot/cold ceramic disk valve cartridge.
- Minimum install hole size 1-1/2".
- Wave spring handle tension.
- Compatible with reverse osmosis water and systems.
- Made from solid brass or 316 stainless steel.



FINISH GROUP 1: CH
 FINISH GROUP 2: BLN, CD, CHB, CLZ, GR, MB, MW, PB, PN, SB, SC, SN, UPB
 FINISH GROUP 3: AB, ABZ, AC, AMB, AP, CB, DAB, DAC, DAMB, DAP, MAB, MAC, MAP, ORB, PC, TB

PRECIOUS METALS: PG, SG - 30% increase from Group 3*
 STAINLESS STEEL: SS *Pricing subject to change

MODERN PREP SIZE 2 HANDLE PLP PULL-DOWN FAUCET / ANGLED SPOUT / LEVER SPRAYER MODEL: 9992

LIST PRICES:

GRP 1 :1819

GRP 2 :2133

GRP 3 :2447

SS :2569

MEETS THE FOLLOWING:

- ASME A112.18.1
- CSA B125.1
- NSF 61, 372
- CALGreen
- ICC Approved

- 16" overall height
- 10 degree angled spout directs water outward towards middle of sink.
- Spout has 8-3/8" reach and can swivel 360 degrees.
- Lever handle spray head pulls out 18" from spout.
- Counterbalanced weight on spray hose allows smooth pull out and prevents snap back.
- 1.75 gpm maximum flow rate with aerated tip.
- "Positive Lock Pulldown" design locks sprayer in place when not in use.
- 1/4 turn Hot/cold ceramic disk valve cartridge.
- Minimum install hole size 1-1/2".
- Wave spring handle tension.
- Compatible with reverse osmosis water and systems.
- Made from solid brass or 316 stainless steel.



FULTON INDUSTRIAL 2 HANDLE PLP



• 10212-CD



FULTON INDUSTRIAL EXTENDED REACH 2 HANDLE PLP PULL-DOWN FAUCET / TOGGLE SPRAYER
MODEL: 10202

LIST PRICES:

GRP 1 : 1900
GRP 2 : 2136
GRP 3 : 2497
SS : 2621

MEETS THE FOLLOWING:

- ASME A112.18.1
- CSA B125.1
- NSF 61, 372
- CALGreen
- ICC Approved

- 19-1/8" overall height
- 2 bend U-spout has 11-3/16" extended reach for larger sinks and can swivel 360 degrees.
- Toggle handle spray head pulls out 18" from spout.
- Counterbalanced weight on spray hose allows smooth pull out and prevents snap back.
- 1.75 gpm maximum flow rate with aerated tip.
- "Positive Lock Pulldown" design locks sprayer in place when not in use.
- 1/4 turn Hot/cold ceramic disk valve cartridge.
- Minimum install hole size 1-1/2".
- Wave spring handle tension.
- Compatible with reverse osmosis water and systems.
- Made from solid brass or 316 stainless steel.



FULTON INDUSTRIAL EXTENDED REACH 2 HANDLE PLP PULL-DOWN FAUCET / LEVER SPRAYER
MODEL: 10252

LIST PRICES:

GRP 1 : 1890
GRP 2 : 2203
GRP 3 : 2518
SS : 2643

MEETS THE FOLLOWING:

- ASME A112.18.1
- CSA B125.1
- NSF 61, 372
- CALGreen
- ICC Approved

- 19-1/4" overall height
- 2 bend U-spout has 11-3/16" extended reach for larger sinks and can swivel 360 degrees.
- Lever handle spray head pulls out 18" from spout.
- Counterbalanced weight on spray hose allows smooth pull out and prevents snap back.
- 1.75 gpm maximum flow rate with aerated tip.
- "Positive Lock Pulldown" design locks sprayer in place when not in use.
- 1/4 turn Hot/cold ceramic disk valve cartridge.
- Minimum install hole size 1-1/2".
- Wave spring handle tension.
- Compatible with reverse osmosis water and systems.
- Made from solid brass or 316 stainless steel.



FULTON INDUSTRIAL 2 HANDLE PLP PULL-DOWN FAUCET / TOGGLE SPRAYER
MODEL: 10212

LIST PRICES:

GRP 1 : 1866
GRP 2 : 2102
GRP 3 : 2522
SS : 2648

MEETS THE FOLLOWING:

- ASME A112.18.1
- CSA B125.1
- NSF 61, 372
- CALGreen
- ICC Approved

- 16" overall height
- 2 bend U-spout has 8-5/8" reach and can swivel 360 degrees.
- Toggle handle spray head pulls out 18" from spout.
- Counterbalanced weight on spray hose allows smooth pull out and prevents snap back.
- 1.75 gpm maximum flow rate with aerated tip.
- "Positive Lock Pulldown" design locks sprayer in place when not in use.
- 1/4 turn Hot/cold ceramic disk valve cartridge.
- Minimum install hole size 1-1/2".
- Wave spring handle tension.
- Compatible with reverse osmosis water and systems.
- Made from solid brass or 316 stainless steel.



FINISH GROUP 1: CH
 FINISH GROUP 2: BLN, CD, CHB, CLZ, GR, MB, MW, PB, PN, SB, SC, SN, UPB
 FINISH GROUP 3: AB, ABZ, AC, AMB, AP, CB, DAB, DAC, DAMB, DAP, MAB, MAC, MAP, ORB, PC, TB

PRECIOUS METALS: PG, SG - 30% increase from Group 3*
 STAINLESS STEEL: SS *Pricing subject to change

FULTON INDUSTRIAL 2 HANDLE PLP PULL-DOWN FAUCET / LEVER SPRAYER
MODEL: 10262

LIST PRICES:

GRP 1 : 2022
GRP 2 : 2365
GRP 3 : 2563
SS : 2691

MEETS THE FOLLOWING:

- ASME A112.18.1
- CSA B125.1
- NSF 61, 372
- CALGreen
- ICC Approved

- 16" overall height
- 2 bend U-spout has 8-5/8" reach and can swivel 360 degrees.
- Lever handle spray head pulls out 18" from spout.
- Counterbalanced weight on spray hose allows smooth pull out and prevents snap back.
- 1.75 gpm maximum flow rate with aerated tip.
- "Positive Lock Pulldown" design locks sprayer in place when not in use.
- 1/4 turn Hot/cold ceramic disk valve cartridge.
- Minimum install hole size 1-1/2".
- Wave spring handle tension.
- Compatible with reverse osmosis water and systems.
- Made from solid brass or 316 stainless steel.



PULL-DOWN FAUCETS

FULTON INDUSTRIAL 2 HANDLE PLP PULL-DOWN FAUCET / ANGLED SPOUT / TOGGLE SPRAY
MODEL: 10222

LIST PRICES:

GRP 1 : 1748
GRP 2 : 1968
GRP 3 : 2489
SS : 2613

MEETS THE FOLLOWING:

- ASME A112.18.1
- CSA B125.1
- NSF 61, 372
- CALGreen
- ICC Approved

- 16" overall height
- 7 degree angled spout directs water outward towards middle of sink.
- 2 bend U-spout has 9-1/16" reach and can swivel 360 degrees.
- Spray swivel design is fully insulated against heat.
- Counterbalanced weight on spray hose allows smooth pull out and prevents snap back.
- 1.75 gpm maximum flow rate with aerated tip.
- "Positive Lock Pulldown" design locks sprayer in place when not in use.
- 1/4 turn Hot/cold ceramic disk valve cartridge.
- Minimum install hole size 1-1/2".
- Wave spring handle tension.
- Compatible with reverse osmosis water and systems.
- Made from solid brass or 316 stainless steel.



FULTON INDUSTRIAL 2 HANDLE PLP PULL-DOWN FAUCET / ANGLED SPOUT / LEVER SPRAYER
MODEL: 10272

LIST PRICES:

GRP 1 : 1936
GRP 2 : 2265
GRP 3 : 2477
SS : 2599

MEETS THE FOLLOWING:

- ASME A112.18.1
- CSA B125.1
- NSF 61, 372
- CALGreen
- ICC Approved

- 16" overall height
- 7 degree angled spout directs water outward towards middle of sink.
- 2 bend U-spout has 9-1/8" reach and can swivel 360 degrees.
- Spray swivel design is fully insulated against heat.
- Lever handle spray head pulls out 18" from spout.
- Counterbalanced weight on spray hose allows smooth pull out and prevents snap back.
- 1.75 gpm maximum flow rate with aerated tip.
- "Positive Lock Pulldown" design locks sprayer in place when not in use.
- 1/4 turn Hot/cold ceramic disk valve cartridge.
- Minimum install hole size 1-1/2".
- Wave spring handle tension.
- Compatible with reverse osmosis water and systems.
- Made from solid brass or 316 stainless steel.



FINISH GROUP 1: CH
 FINISH GROUP 2: BLN, CD, CHB, CLZ, GR, MB, MW, PB, PN, SB, SC, SN, UPB
 FINISH GROUP 3: AB, ABZ, AC, AMB, AP, CB, DAB, DAC, DAMB, DAP, MAB, MAC, MAP, ORB, PC, TB

PRECIOUS METALS: PG, SG - 30% increase from Group 3*
 STAINLESS STEEL: SS *Pricing subject to change

FULTON INDUSTRIAL PREP SIZE 2 HANDLE PLP PULL-DOWN FAUCET / TOGGLE SPRAYER MODEL: 10232

LIST PRICES:

GRP 1 : 1745

GRP 2 : 1937

GRP 3 : 2546

SS : 2673

MEETS THE FOLLOWING:

- ASME A112.18.1
- CSA B125.1
- NSF 61, 372
- CALGreen
- ICC Approved

- 15-1/8" overall height
- 2 bend U-spout has 7-5/8" reach and can swivel 360 degrees.
- Toggle handle spray head pulls out 18" from spout.
- Counterbalanced weight on spray hose allows smooth pull out and prevents snap back.
- 1.75 gpm maximum flow rate with aerated tip.
- "Positive Lock Pulldown" design locks sprayer in place when not in use.
- 1/4 turn Hot/cold ceramic disk valve cartridge.
- Minimum install hole size 1-1/2".
- Wave spring handle tension.
- Compatible with reverse osmosis water and systems.
- Made from solid brass or 316 stainless steel.



FULTON INDUSTRIAL PREP SIZE 2 HANDLE PLP PULL-DOWN FAUCET / LEVER SPRAYER MODEL: 10282

LIST PRICES:

GRP 1 : 2025

GRP 2 : 2326

GRP 3 : 2566

SS : 2694

MEETS THE FOLLOWING:

- ASME A112.18.1
- CSA B125.1
- NSF 61, 372
- CALGreen
- ICC Approved

- 15-1/8" overall height
- 2 bend U-spout has 7-5/8" reach and can swivel 360 degrees.
- Lever handle spray head pulls out 18" from spout.
- Counterbalanced weight on spray hose allows smooth pull out and prevents snap back.
- 1.75 gpm maximum flow rate with aerated tip.
- "Positive Lock Pulldown" design locks sprayer in place when not in use.
- 1/4 turn Hot/cold ceramic disk valve cartridge.
- Minimum install hole size 1-1/2".
- Wave spring handle tension.
- Compatible with reverse osmosis water and systems.
- Made from solid brass or 316 stainless steel.



FULTON INDUSTRIAL PREP SIZE 2 HANDLE PLP PULL-DOWN FAUCET / ANGLE SPOUT / TOGGLE SPRAYER MODEL: 10242

LIST PRICES:

GRP 1 : 1723

GRP 2 : 1843

GRP 3 : 2524

SS : 2650

MEETS THE FOLLOWING:

- ASME A112.18.1
- CSA B125.1
- NSF 61, 372
- CALGreen
- ICC Approved

- 15-1/8" overall height
- 10 degree angled spout directs water outward towards middle of sink.
- 2 bend U-spout has 8-3/8" reach and can swivel 360 degrees.
- Toggle handle spray head pulls out 18" from spout.
- Counterbalanced weight on spray hose allows smooth pull out and prevents snap back.
- 1.75 gpm maximum flow rate with aerated tip.
- "Positive Lock Pulldown" design locks sprayer in place when not in use.
- 1/4 turn Hot/cold ceramic disk valve cartridge.
- Minimum install hole size 1-1/2".
- Wave spring handle tension.
- Compatible with reverse osmosis water and systems.
- Made from solid brass or 316 stainless steel.



FINISH GROUP 1: CH
FINISH GROUP 2: BLN, CD, CHB, CLZ, GR, MB, MW, PB, PN, SB, SC, SN, UPB
FINISH GROUP 3: AB, ABZ, AC, AMB, AP, CB, DAB, DAC, DAMB, DAP, MAB, MAC, MAP, ORB, PC, TB

PRECIOUS METALS: PG, SG - 30% increase from Group 3*
STAINLESS STEEL: SS *Pricing subject to change

FULTON INDUSTRIAL PREP SIZE 2 HANDLE PLP PULL-DOWN FAUCET / ANGLE SPOUT / LEVER SPRAYER MODEL: 10292

LIST PRICES:

GRP 1 : 2003

GRP 2 : 2231

GRP 3 : 2544

SS : 2671

MEETS THE FOLLOWING:

- ASME A112.18.1
- CSA B125.1
- NSF 61, 372
- CALGreen
- ICC Approved

- 15-1/8" overall height
- 10 degree angled spout directs water outward towards middle of sink.
- 2 bend U-spout has 8-3/8" reach and can swivel 360 degrees.
- Lever handle spray head pulls out 18" from spout.
- Counterbalanced weight on spray hose allows smooth pull out and prevents snap back.
- 1.75 gpm maximum flow rate with aerated tip.
- "Positive Lock Pulldown" design locks sprayer in place when not in use.
- 1/4 turn Hot/cold ceramic disk valve cartridge.
- Minimum install hole size 1-1/2".
- Wave spring handle tension.
- Compatible with reverse osmosis water and systems.
- Made from solid brass or 316 stainless steel.



FULTON MODERN 2 HANDLE PLP



• 10332-CD



FULTON MODERN EXTENDED REACH 2 HANDLE PLP FAUCET / TOGGLE SPRAYER
MODEL: 10302

LIST PRICES:

- GRP 1 : 1759**
- GRP 2 : 1980**
- GRP 3 : 2501**
- SS : 2626**

MEETS THE FOLLOWING:

- ASME A112.18.1
- CSA B125.1
- NSF 61, 372
- CALGreen
- ICC Approved

- 19-1/4" overall height
- 2 bend U-spout has 11-3/16" extended reach for larger sinks and can swivel 360 degrees.
- Toggle handle spray head pulls out 18" from spout.
- Counterbalanced weight on spray hose allows smooth pull out and prevents snap back.
- 1.75 gpm maximum flow rate with aerated tip.
- "Positive Lock Pulldown" design locks sprayer in place when not in use.
- 1/4 turn Hot/cold ceramic disk valve cartridge.
- Minimum install hole size 1-1/2".
- Wave spring handle tension.
- Compatible with reverse osmosis water and systems.
- Made from solid brass or 316 stainless steel.



FULTON MODERN EXTENDED REACH 2 HANDLE PLP PULL-DOWN FAUCET / LEVER SPRAYER
MODEL: 10352

LIST PRICES:

- GRP 1 : 1853**
- GRP 2 : 2167**
- GRP 3 : 2481**
- SS : 2605**

MEETS THE FOLLOWING:

- ASME A112.18.1
- CSA B125.1
- NSF 61, 372
- CALGreen
- ICC Approved

- 19-1/4" overall height
- 2 bend U-spout has 11-3/16" extended reach for larger sinks and can swivel 360 degrees.
- Toggle handle spray head pulls out 18" from spout.
- Counterbalanced weight on spray hose allows smooth pull out and prevents snap back.
- 1.75 gpm maximum flow rate with aerated tip.
- "Positive Lock Pulldown" design locks sprayer in place when not in use.
- 1/4 turn Hot/cold ceramic disk valve cartridge.
- Minimum install hole size 1-1/2".
- Wave spring handle tension.
- Compatible with reverse osmosis water and systems.
- Made from solid brass or 316 stainless steel.



FULTON MODERN 2 HANDLE PLP PULL-DOWN FAUCET / TOGGLE SPRAYER
MODEL: 10312

LIST PRICES:

- GRP 1 : 1696**
- GRP 2 : 1966**
- GRP 3 : 2486**
- SS : 2610**

MEETS THE FOLLOWING:

- ASME A112.18.1
- CSA B125.1
- NSF 61, 372
- CALGreen
- ICC Approved

- 16" overall height
- 2 bend U-spout has 8-5/8" reach and can swivel 360 degrees.
- Toggle handle spray head pulls out 18" from spout.
- When pushed, sprayer toggle button locks in place and instantly diverts water from aerated stream to wide spray.
- Counterbalanced weight on spray hose allows smooth pull out and prevents snap back.
- 1.75 gpm maximum flow rate with aerated tip.
- "Positive Lock Pulldown" design locks sprayer in place when not in use.
- 1/4 turn Hot/cold ceramic disk valve cartridge.
- Minimum install hole size 1-1/2".
- Wave spring handle tension.
- Compatible with reverse osmosis water and systems.
- Made from solid brass or 316 stainless steel.



FINISH GROUP 1: CH
 FINISH GROUP 2: BLN, CD, CHB, CLZ, GR, MB, MW, PB, PN, SB, SC, SN, UPB
 FINISH GROUP 3: AB, ABZ, AC, AMB, AP, CB, DAB, DAC, DAMB, DAP, MAB, MAC, MAP, ORB, PC, TB

PRECIOUS METALS: PG, SG - 30% increase from Group 3*
 STAINLESS STEEL: SS *Pricing subject to change

FULTON MODERN 2 HANDLE PLP PULL-DOWN FAUCET / LEVER SPRAYER

MODEL: 10362

LIST PRICES:

- GRP 1 : 1839**
- GRP 2 : 2152**
- GRP 3 : 2467**
- SS : 2590**

MEETS THE FOLLOWING:

- ASME A112.18.1
- CSA B125.1
- NSF 61, 372
- CALGreen
- ICC Approved

- 16" overall height
- 2 bend U-spout has 8-5/8" reach and can swivel 360 degrees.
- Lever handle spray head pulls out 18" from spout.
- Counterbalanced weight on spray hose allows smooth pull out and prevents snap back.
- Counterbalanced weight on spray hose allows smooth pull out and prevents snap back.
- 1.75 gpm maximum flow rate with aerated tip.
- "Positive Lock Pulldown" design locks sprayer in place when not in use.
- 1/4 turn Hot/cold ceramic disk valve cartridge.
- Minimum install hole size 1-1/2".
- Wave spring handle tension.
- Compatible with reverse osmosis water and systems.
- Made from solid brass or 316 stainless steel.



FULTON MODERN 2 HANDLE PLP PULL-DOWN FAUCET / ANGLED SPOUT / TOGGLE SPRAYER

MODEL: 10322

LIST PRICES:

- GRP 1 : 1702**
- GRP 2 : 1972**
- GRP 3 : 2492**
- SS : 2616**

MEETS THE FOLLOWING:

- ASME A112.18.1
- CSA B125.1
- NSF 61, 372
- CALGreen
- ICC Approved

- 16" overall height
- 7 degree angled spout directs water outward towards middle of sink.
- 2 bend U-spout has 9-1/16" reach and can swivel 360 degrees.
- Spray swivel design is fully insulated against heat.
- Toggle handle spray head pulls out 18" from spout.
- Counterbalanced weight on spray hose allows smooth pull out and prevents snap back.
- 1.75 gpm maximum flow rate with aerated tip.
- "Positive Lock Pulldown" design locks sprayer in place when not in use.
- 1/4 turn Hot/cold ceramic disk valve cartridge.
- Minimum install hole size 1-1/2".
- Wave spring handle tension.
- Compatible with reverse osmosis water and systems.
- Made from solid brass or 316 stainless steel.



FULTON MODERN 2 HANDLE PLP PULL-DOWN FAUCET / ANGLED SPOUT / LEVER SPRAYER

MODEL: 10372

LIST PRICES:

- GRP 1 : 1845**
- GRP 2 : 2158**
- GRP 3 : 2473**
- SS : 2596**

MEETS THE FOLLOWING:

- ASME A112.18.1
- CSA B125.1
- NSF 61, 372
- CALGreen
- ICC Approved

- 16" overall height
- 7 degree angled spout flows outward towards middle of sink.
- 2 bend U-spout has 9-1/8" reach and can swivel 360 degrees.
- Spray swivel design is fully insulated against heat.
- Lever handle spray head pulls out 18" from spout.
- Counterbalanced weight on spray hose allows smooth pull out and prevents snap back.
- 1.75 gpm maximum flow rate with aerated tip.
- "Positive Lock Pulldown" design locks sprayer in place when not in use.
- 1/4 turn Hot/cold ceramic disk valve cartridge.
- Minimum install hole size 1-1/2".
- Wave spring handle tension.
- Compatible with reverse osmosis water and systems.
- Made from solid brass or 316 stainless steel.



FINISH GROUP 1: CH
 FINISH GROUP 2: BLN, CD, CHB, CLZ, GR, MB, MW, PB, PN, SB, SC, SN, UPB
 FINISH GROUP 3: AB, ABZ, AC, AMB, AP, CB, DAB, DAC, DAMB, DAP, MAB, MAC, MAP, ORB, PC, TB

PRECIOUS METALS: PG, SG - 30% increase from Group 3*
 STAINLESS STEEL: SS *Pricing subject to change

**FULTON MODERN PREP SIZE 2 HANDLE PLP PULL-DOWN FAUCET / TOGGLE SPRAYER
MODEL: 10332**

LIST PRICES:

GRP 1 : 1699
GRP 2 : 1941
GRP 3 : 2490
SS : 2614

MEETS THE FOLLOWING:

- ASME A112.18.1
- CSA B125.1
- NSF 61, 372
- CALGreen
- ICC Approved
- 15-1/8" overall height
- 2 bend U-spout has 7-5/8" reach and can swivel 360 degrees.
- Toggle handle spray head pulls out 18" from spout.
- Counterbalanced weight on spray hose allows smooth pull out and prevents snap back.
- 1.75 gpm maximum flow rate with aerated tip.
- "Positive Lock Pulldown" design locks sprayer in place when not in use.
- 1/4 turn Hot/cold ceramic disk valve cartridge.
- Minimum install hole size 1-1/2".
- Wave spring handle tension.
- Compatible with reverse osmosis water and systems.
- Made from solid brass or 316 stainless steel.



**FULTON MODERN PREP SIZE 2 HANDLE PLP PULL-DOWN FAUCET / LEVER SPRAYER
MODEL: 10382**

LIST PRICES:

GRP 1 : 1842
GRP 2 : 2127
GRP 3 : 2470
SS : 2593

MEETS THE FOLLOWING:

- ASME A112.18.1
- CSA B125.1
- NSF 61, 372
- CALGreen
- ICC Approved
- 15-1/8" overall height
- 2 bend U-spout has 7-5/8" reach and can swivel 360 degrees.
- Lever handle spray head pulls out 18" from spout.
- Counterbalanced weight on spray hose allows smooth pull out and prevents snap back.
- 1.75 gpm maximum flow rate with aerated tip.
- "Positive Lock Pulldown" design locks sprayer in place when not in use.
- 1/4 turn Hot/cold ceramic disk valve cartridge.
- Minimum install hole size 1-1/2".
- Wave spring handle tension.
- Compatible with reverse osmosis water and systems.
- Made from solid brass or 316 stainless steel.



**FULTON MODERN PREP SIZE 2 HANDLE PLP PULL-DOWN FAUCET / ANGLE SPOUT / TOGGLE SPRAYER
MODEL: 10342**

LIST PRICES:

GRP 1 : 1679
GRP 2 : 1848
GRP 3 : 2470
SS : 2593

MEETS THE FOLLOWING:

- ASME A112.18.1
- CSA B125.1
- NSF 61, 372
- CALGreen
- ICC Approved
- 15-1/8" overall height
- 10 degree angled spout directs water outward towards middle of sink.
- 2 bend U-spout has 8-3/8" reach and can swivel 360 degrees.
- Toggle handle spray head pulls out 18" from spout.
- Counterbalanced weight on spray hose allows smooth pull out and prevents snap back.
- 1.75 gpm maximum flow rate with aerated tip.
- "Positive Lock Pulldown" design locks sprayer in place when not in use.
- 1/4 turn Hot/cold ceramic disk valve cartridge.
- Minimum install hole size 1-1/2".
- Wave spring handle tension.
- Compatible with reverse osmosis water and systems.
- Made from solid brass or 316 stainless steel.



FINISH GROUP 1: CH
 FINISH GROUP 2: BLN, CD, CHB, CLZ, GR, MB, MW, PB, PN, SB, SC, SN, UPB
 FINISH GROUP 3: AB, ABZ, AC, AMB, AP, CB, DAB, DAC, DAMB, DAP, MAB, MAC, MAP, ORB, PC, TB

PRECIOUS METALS: PG, SG - 30% increase from Group 3*
 STAINLESS STEEL: SS *Pricing subject to change

FULTON MODERN PREP SIZE 2 HANDLE PLP PULL-DOWN FAUCET / ANGLE SPOUT / LEVER SPRAYER MODEL: 10392

LIST PRICES:

GRP 1 : 1821

GRP 2 : 2033

GRP 3 : 2449

SS : 2571

MEETS THE FOLLOWING:

- ASME A112.18.1
- CSA B125.1
- NSF 61, 372
- CALGreen
- ICC Approved

- 15-1/8" overall height
- 10 degree angled spout directs water outward towards middle of sink.
- 2 bend U-spout has 8-3/8" reach and can swivel 360 degrees.
- Lever handle spray head pulls out 18" from spout.
- Counterbalanced weight on spray hose allows smooth pull out and prevents snap back.
- 1.75 gpm maximum flow rate with aerated tip.
- "Positive Lock Pulldown" design locks sprayer in place when not in use.
- 1/4 turn Hot/cold ceramic disk valve cartridge.
- Minimum install hole size 1-1/2".
- Wave spring handle tension.
- Compatible with reverse osmosis water and systems.
- Made from solid brass or 316 stainless steel.



GANTRY FAUCETS



- 4410-12-PB
- 4010-PB



TRADITIONAL GANTRY® PULL-DOWN FAUCET / HOOK SPOUT

MODEL: 4400

LIST PRICES:

GRP 1 : 5511

GRP 2 : 5786

GRP 3 : 7539

SS : N/A

MEETS THE FOLLOWING:

- ASME A112.18.1
- CSA B125.1
- NSF 61, 372
- CALGreen
- ICC Approved

- 32-3/4" overall height.
- Spray arm extends and pivots to reach all areas of sink.
- Sprayer instantly diverts water from aerated stream to wide spray when lever handle is held.
- Hook spout has 10-3/4" reach and can swivel 360 degrees.
- 1.75 gpm maximum flow rate with aerated tip.
- Spray arm spring technology gives the sprayer an easy, smooth pull.
- Handle ring can be adjusted to preferred push/pull tension and prevents sag.
- Single handle can mount in front, right or left hand positions.
- Minimum install hole 1-1/2".
- Hot/cold ceramic disk valve cartridge.
- Compatible with reverse osmosis water and systems.
- Made from solid brass.



TRADITIONAL GANTRY® PULL-DOWN FAUCET / 12" ARTICULATED SPOUT

MODEL: 4410-12

LIST PRICES:

GRP 1 : 6345

GRP 2 : 6662

GRP 3 : 8681

SS : N/A

MEETS THE FOLLOWING:

- ASME A112.18.1
- CSA B125.1
- NSF 61, 372
- CALGreen
- ICC Approved

- 32-3/4" overall height.
- Spray arm extends and pivots to reach all areas of sink.
- Sprayer instantly diverts water from aerated stream to wide spray when lever handle is held.
- Articulated spout has 12" reach and can swivel 360 degrees.
- 1.75 gpm maximum flow rate with aerated tip.
- Spray arm spring technology gives the sprayer an easy, smooth pull.
- Handle ring can be adjusted to preferred push/pull tension and prevents sag.
- Single handle can mount in front, right or left hand positions.
- Minimum install hole 1-1/2".
- Hot/cold ceramic disk valve cartridge.
- Compatible with reverse osmosis water and systems.
- Made from solid brass.



TRADITIONAL GANTRY® PULL-DOWN FAUCET / 18" ARTICULATED SPOUT

MODEL: 4410-18

LIST PRICES:

GRP 1 : 6522

GRP 2 : 6849

GRP 3 : 8924

SS : N/A

MEETS THE FOLLOWING:

- ASME A112.18.1
- CSA B125.1
- NSF 61, 372
- CALGreen
- ICC Approved

- 26-5/8" overall height.
- Spray arm extends and pivots to reach all areas of sink.
- Sprayer instantly diverts water from aerated stream to wide spray when lever handle is held.
- Articulated spout has 18" reach and can swivel 360 degrees.
- 1.75 gpm maximum flow rate with aerated tip.
- Spray arm spring technology gives the sprayer an easy, smooth pull.
- Handle ring can be adjusted to preferred push/pull tension and prevents sag.
- Single handle can mount in front, right or left hand positions.
- Minimum install hole 1-1/2".
- Hot/cold ceramic disk valve cartridge.
- Compatible with reverse osmosis water and systems.
- Made from solid brass.



FINISH GROUP 1: CH
 FINISH GROUP 2: BLN, CD, CHB, CLZ, GR, MB, MW, PB, PN, SB, SC, SN, UPB
 FINISH GROUP 3: AB, ABZ, AC, AMB, AP, CB, DAB, DAC, DAMB, DAP, MAB, MAC, MAP, ORB, PC, TB

PRECIOUS METALS: PG, SG - 30% increase from Group 3*
 STAINLESS STEEL: SS *Pricing subject to change

CONTEMPORARY GANTRY® PULL-DOWN FAUCET / STRAIGHT SPOUT

MODEL: 3700

LIST PRICES:

GRP 1 : 6257

GRP 2 : 6569

GRP 3 : 8559

SS : 8792

MEETS THE FOLLOWING:

- ASME A112.18.1
- CSA B125.1
- NSF 61, 372
- CALGreen
- ICC Approved

- 32-3/4" overall height.
- Spray arm extends and pivots to reach all areas of sink.
- Sprayer instantly diverts water from aerated stream to wide spray when lever handle is held.
- Straight spout has 10-3/8" reach and can swivel 360 degrees.
- 1.75 gpm maximum flow rate with aerated tip.
- Spray arm spring technology gives the sprayer an easy, smooth pull.
- Handle ring can be adjusted to preferred push/pull tension and prevents sag.
- Single handle can mount in front, right or left hand positions.
- Minimum install hole 1-1/2".
- Hot/cold ceramic disk valve cartridge.
- Compatible with reverse osmosis water and systems.
- Made from solid brass.



CONTEMPORARY GANTRY® PULL-DOWN FAUCET / 12" ARTICULATED SPOUT

MODEL: 3710-12

LIST PRICES:

GRP 1 : 6647

GRP 2 : 6980

GRP 3 : 9095

SS : 9342

MEETS THE FOLLOWING:

- ASME A112.18.1
- CSA B125.1
- NSF 61, 372
- CALGreen
- ICC Approved

- 32-3/4" overall height.
- Spray arm extends and pivots to reach all areas of sink.
- Sprayer instantly diverts water from aerated stream to wide spray when lever handle is held.
- Articulated spout has 12" reach and can swivel 360 degrees.
- 1.75 gpm maximum flow rate with aerated tip.
- Spray arm spring technology gives the sprayer an easy, smooth pull.
- Handle ring can be adjusted to preferred push/pull tension and prevents sag.
- Single handle can mount in front, right or left hand positions.
- Minimum install hole 1-1/2".
- Hot/cold ceramic disk valve cartridge.
- Compatible with reverse osmosis water and systems.
- Made from solid brass.



CONTEMPORARY GANTRY® PULL-DOWN FAUCET / 18" ARTICULATED SPOUT

MODEL: 3710-18

LIST PRICES:

GRP 1 : 6825

GRP 2 : 7166

GRP 3 : 9336

SS : 9590

MEETS THE FOLLOWING:

- ASME A112.18.1
- CSA B125.1
- NSF 61, 372
- CALGreen
- ICC Approved

- 32-3/4" overall height.
- Spray arm extends and pivots to reach all areas of sink.
- Sprayer instantly diverts water from aerated stream to wide spray when lever handle is held.
- Articulated spout has 18" reach and can swivel 360 degrees.
- 1.75 gpm maximum flow rate with aerated tip.
- Spray arm spring technology gives the sprayer an easy, smooth pull.
- Handle ring can be adjusted to preferred push/pull tension and prevents sag.
- Single handle can mount in front, right or left hand positions.
- Minimum install hole 1-1/2".
- Hot/cold ceramic disk valve cartridge.
- Compatible with reverse osmosis water and systems.
- Made from solid brass.



FINISH GROUP 1: CH
 FINISH GROUP 2: BLN, CD, CHB, CLZ, GR, MB, MW, PB, PN, SB, SC, SN, UPB
 FINISH GROUP 3: AB, ABZ, AC, AMB, AP, CB, DAB, DAC, DAMB, DAP, MAB, MAC, MAP, ORB, PC, TB

PRECIOUS METALS: PG, SG - 30% increase from Group 3*
 STAINLESS STEEL: SS *Pricing subject to change

BRIDGE FAUCETS



- 6200-4-SB
- 1100HC-SB



• 6350-1-MB

How to Order A Kitchen Suite

Waterstone offers complete suites! All suites orders come in one box!

Elevate your kitchen's functionality and aesthetics with our versatile product suites, available in 2-piece, 3-piece, and 4-piece options, each thoughtfully curated to enhance your culinary haven.

See example below (Prices shown not current)

6350 SUITES

SUITE LIST PRICES:

MODEL #	GRP 1	GRP 2	GRP 3	SS
6350-1	3727	3913	5099	N/A
6350-2	4291	4505	5870	N/A
6350-3	4787	5027	6550	N/A
6350-4	5103	5358	6981	N/A

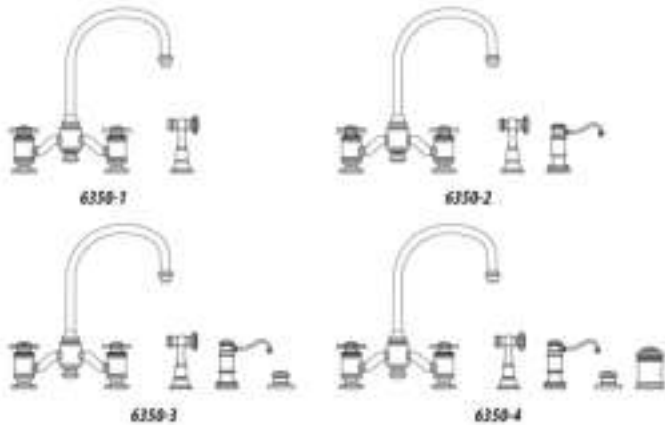

- 1pc. Suite includes Side Spray (4025)
- 2pc. Suite includes Side Spray (4025) and Soap/Lotion Dispenser (4060)
- 3pc. Suite includes Side Spray (4025), Soap/Lotion Dispenser (4060) and Air Switch (4010)
- 4pc. Suite includes Side Spray (4025), Soap/Lotion Dispenser (4060), Air Switch (4010) and Single Port Air Gap (4020)

TOWSON BRIDGE FAUCET / 12" ARTICULATED SPOUT / LEVER HANDLES

MODEL: 6100-12

LIST PRICES:

GRP 1 : 3462
GRP 2 : 3635
GRP 3 : 4735
SS : N/A

MEETS THE FOLLOWING:

- ASME A112.18.1
- CSA B125.1
- NSF 61, 372
- CALGreen
- ADA compliant
- ICC Approved

- 12-3/8" overall height.
- Two-holed Bridge Faucet design mounts 8" on center.
- Articulated spout has 12" reach and can swivel 360 degrees.
- Equipped with spray diverter and 1/4" NPT pipe fitting connection for optional side spray.
- 1.75 gpm maximum flow rate with aerated tip.
- Ergonomic double lever handles.
- ADA compliant.
- 1/4 turn Hot and cold ceramic disk valve cartridges.
- Compatible with reverse osmosis water and systems.
- Made from solid brass.



TOWSON BRIDGE FAUCET / 18" ARTICULATED SPOUT / LEVER HANDLES

MODEL: 6100-18

LIST PRICES:

GRP 1 : 3598
GRP 2 : 3778
GRP 3 : 4924
SS : N/A

MEETS THE FOLLOWING:

- ASME A112.18.1
- CSA B125.1
- NSF 61, 372
- CALGreen
- ADA compliant
- ICC Approved

- 12-3/8" overall height.
- Two-holed Bridge Faucet design mounts 8" on center.
- Articulated spout has 18" reach and can swivel 360 degrees.
- Equipped with spray diverter and 1/4" NPT pipe fitting connection for optional side spray.
- 1.75 gpm maximum flow rate with aerated tip.
- Ergonomic double lever handles.
- ADA compliant.
- 1/4 turn Hot and cold ceramic disk valve cartridges.
- Compatible with reverse osmosis water and systems.
- Made from solid brass.



TOWSON BRIDGE FAUCET / 12" ARTICULATED SPOUT / CROSS HANDLES

MODEL: 6150-12

LIST PRICES:

GRP 1 : 3666
GRP 2 : 3850
GRP 3 : 5016
SS : N/A

MEETS THE FOLLOWING:

- ASME A112.18.1
- CSA B125.1
- NSF 61, 372
- CALGreen
- ICC Approved

- 12-3/8" overall height.
- Two-holed Bridge Faucet design mounts 8" on center.
- Articulated spout has 12" reach and can swivel 360 degrees.
- Equipped with spray diverter and 1/4" NPT pipe fitting connection for optional side spray.
- 1.75 gpm maximum flow rate with aerated tip.
- Ergonomic double lever handles.
- ADA compliant.
- 1/4 turn Hot and cold ceramic disk valve cartridges.
- Compatible with reverse osmosis water and systems.
- Made from solid brass.



FINISH GROUP 1: CH
 FINISH GROUP 2: BLN, CD, CHB, CLZ, GR, MB, MW, PB, PN, SB, SC, SN, UPB
 FINISH GROUP 3: AB, ABZ, AC, AMB, AP, CB, DAB, DAC, DAMB, DAP, MAB, MAC, MAP, ORB, PC, TB

PRECIOUS METALS: PG, SG - 30% increase from Group 3*
 STAINLESS STEEL: SS *Pricing subject to change

TOWSON BRIDGE FAUCET / 18" ARTICULATED SPOUT / CROSS HANDLES
MODEL: 6150-18

LIST PRICES:

GRP 1 : 3804
GRP 2 : 3995
GRP 3 : 5206
SS : N/A

MEETS THE FOLLOWING:

- ASME A112.18.1
- CSA B125.1
- NSF 61, 372
- CALGreen
- ICC Approved

- 12-3/8" overall height.
- Two-holed Bridge Faucet design mounts 8" on center.
- Articulated spout has 18" reach and can swivel 360 degrees.
- Equipped with spray diverter and 1/4" NPT pipe fitting connection for optional side spray.
- 1.75 gpm maximum flow rate with aerated tip.
- Ergonomic double lever handles.
- ADA compliant.
- 1/4 turn Hot and cold ceramic disk valve cartridges.
- Compatible with reverse osmosis water and systems.
- Made from solid brass.



ANNAPOLIS BRIDGE FAUCET / HOOK SPOUT / LEVER HANDLES
MODEL: 6200

LIST PRICES:

GRP 1 : 3284
GRP 2 : 3447
GRP 3 : 4492
SS : N/A

MEETS THE FOLLOWING:

- ASME A112.18.1
- CSA B125.1
- NSF 61, 372
- CALGreen
- ICC Approved

- 13-3/8" overall height.
- Two-holed Bridge Faucet design mounts 8" on center.
- Hook spout has 10-1/4" reach and can swivel 360 degrees.
- Equipped with spray diverter and 1/4" NPT pipe fitting connection for optional side spray.
- 1.75 gpm maximum flow rate with aerated tip.
- Ergonomic double lever handles.
- ADA compliant.
- 1/4 turn Hot and cold ceramic disk valve cartridges.
- Compatible with reverse osmosis water and systems.
- Made from solid brass.



ANNAPOLIS BRIDGE FAUCET / HOOK SPOUT / CROSS HANDLES
MODEL: 6250

LIST PRICES:

GRP 1 : 3324
GRP 2 : 3490
GRP 3 : 4548
SS : N/A

MEETS THE FOLLOWING:

- ASME A112.18.1
- CSA B125.1
- NSF 61, 372
- CALGreen
- ICC Approved

- 13-3/8" overall height.
- Two-holed Bridge Faucet design mounts 8" on center.
- Hook spout has 10-1/4" reach and can swivel 360 degrees.
- Equipped with spray diverter and 1/4" NPT pipe fitting connection for optional side spray.
- 1.75 gpm maximum flow rate with aerated tip.
- Ergonomic double lever handles.
- ADA compliant.
- 1/4 turn Hot and cold ceramic disk valve cartridges.
- Compatible with reverse osmosis water and systems.
- Made from solid brass.



FINISH GROUP 1: CH
 FINISH GROUP 2: BLN, CD, CHB, CLZ, GR, MB, MW, PB, PN, SB, SC, SN, UPB
 FINISH GROUP 3: AB, ABZ, AC, AMB, AP, CB, DAB, DAC, DAMB, DAP, MAB, MAC, MAP, ORB, PC, TB

PRECIOUS METALS: PG, SG - 30% increase from Group 3*
 STAINLESS STEEL: SS *Pricing subject to change

HAMPTON BRIDGE FAUCET / C-SPOUT / LEVER HANDLES
MODEL: 6300

LIST PRICES:

GRP 1 : 2873
GRP 2 : 3017
GRP 3 : 3931
SS : N/A

- 14-1/8" overall height.
- Two-holed Bridge Faucet design mounts 8" on center.
- C-spout has 8-1/4" reach and can swivel 360 degrees.
- Equipped with spray diverter and 1/4" NPT pipe fitting connection for optional side spray.
- 1.75 gpm maximum flow rate with aerated tip.
- Ergonomic double lever handles.
- ADA compliant.
- 1/4 turn Hot and cold ceramic disk valve cartridges.
- Compatible with reverse osmosis water and systems.
- Made from solid brass.



MEETS THE FOLLOWING:

- ASME A112.18.1
- CSA B125.1
- NSF 61, 372
- CALGreen
- ICC Approved

HAMPTON BRIDGE FAUCET / C-SPOUT / CROSS HANDLES
MODEL: 6350

LIST PRICES:

GRP 1: 3010
GRP 2: 3160
GRP 3: 4117
SS : N/A

- 14-1/8" overall height.
- Two-holed Bridge Faucet design mounts 8" on center.
- C-spout has 8-1/4" reach and can swivel 360 degrees.
- Equipped with spray diverter and 1/4" NPT pipe fitting connection for optional side spray.
- 1.75 gpm maximum flow rate with aerated tip.
- Ergonomic double lever handles.
- ADA compliant.
- 1/4 turn Hot and cold ceramic disk valve cartridges.
- Compatible with reverse osmosis water and systems.
- Made from solid brass.



MEETS THE FOLLOWING:

- ASME A112.18.1
- CSA B125.1
- NSF 61, 372
- CALGreen
- ICC Approved

HUNLEY BRIDGE FAUCET / 12" ARTICULATED SPOUT
MODEL: 7600-12

LIST PRICES:

GRP 1: 3147
GRP 2: 3305
GRP 3: 4306
SS : 4422

- 13" overall height.
- Two-holed Bridge Faucet design mounts 8" on center.
- Articulated spout has 12" reach and can swivel 360 degrees.
- Equipped with spray diverter and 1/4" NPT pipe fitting connection for optional side spray.
- 1.75 gpm maximum flow rate with aerated tip.
- Ergonomic double lever handles.
- ADA compliant.
- Hot and cold ceramic disk valve cartridges.
- Compatible with reverse osmosis water and systems.
- Made from eco-friendly solid brass or 316 stainless steel.



MEETS THE FOLLOWING:

- ASME A112.18.1
- CSA B125.1
- NSF 61, 372
- CALGreen
- ADA compliant

FINISH GROUP 1: CH
 FINISH GROUP 2: BLN, CD, CHB, CLZ, GR, MB, MW, PB, PN, SB, SC, SN, UPB
 FINISH GROUP 3: AB, ABZ, AC, AMB, AP, CB, DAB, DAC, DAMB, DAP, MAB, MAC, MAP, ORB, PC, TB

PRECIOUS METALS: PG, SG - 30% increase from Group 3*
 STAINLESS STEEL: SS *Pricing subject to change

HUNLEY BRIDGE FAUCET / 18" ARTICULATED SPOUT
MODEL: 7600-18

LIST PRICES:

GRP 1: 3420

GRP 2: 3591

GRP 3: 4680

SS : 4807

- 13" overall height.
- Two-holed Bridge Faucet design mounts 8" on center.
- Articulated spout has 18" reach and can swivel 360 degrees.
- Equipped with spray diverter and 1/4" NPT pipe fitting connection for optional side spray.
- 1.75 gpm maximum flow rate with aerated tip.
- Ergonomic double lever handles.
- ADA compliant.
- 1/4 turn Hot and cold ceramic disk valve cartridges.
- Compatible with reverse osmosis water and systems.
- Made from solid brass or 316 stainless steel.



MEETS THE FOLLOWING:

- ASME A112.18.1
- CSA B125.1
- NSF 61, 372
- CALGreen
- ICC Approved

PARCHE BRIDGE FAUCET / C-SPOUT
MODEL: 7800

LIST PRICES:

GRP 1: 2600

GRP 2: 2729

GRP 3: 3556

SS : 3652

- 16-1/4" overall height.
- Two-holed Bridge Faucet design mounts 8" on center.
- C-spout has 9-1/8" reach and can swivel 360 degrees.
- Equipped with spray diverter and 1/4" NPT pipe fitting connection for optional side spray.
- 1.75 gpm maximum flow rate with aerated tip.
- Ergonomic double lever handles.
- ADA compliant.
- 1/4 turn Hot and cold ceramic disk valve cartridges.
- Compatible with reverse osmosis water and systems.
- Made from solid brass or 316 stainless steel.



MEETS THE FOLLOWING:

- ASME A112.18.1
- CSA B125.1
- NSF 61, 372
- CALGreen
- ICC Approved

FULTON BRIDGE FAUCET / 2 BEND U-SPOUT
MODEL: 7825

LIST PRICES:

GRP 1: 2667

GRP 2: 2800

GRP 3: 3649

SS : 3748

- 16-1/4" spout height.
- Two-holed Bridge Faucet design mounts 8" on center.
- 2 bend U-spout has 11-1/8" reach and can swivel 360 degrees.
- Equipped with spray diverter and 1/4" NPT pipe fitting connection for optional side spray.
- 1.75 gpm maximum flow rate with aerated tip.
- Ergonomic double lever handles.
- ADA compliant.
- 1/4 turn Hot and cold ceramic disk valve cartridges.
- Compatible with reverse osmosis water and systems.
- Made from solid brass or 316 stainless steel.



MEETS THE FOLLOWING:

- ASME A112.18.1
- CSA B125.1
- NSF 61, 372
- CALGreen
- ICC Approved

FINISH GROUP 1: CH
 FINISH GROUP 2: BLN, CD, CHB, CLZ, GR, MB, MW, PB, PN, SB, SC, SN, UPB
 FINISH GROUP 3: AB, ABZ, AC, AMB, AP, CB, DAB, DAC, DAMB, DAP, MAB, MAC, MAP, ORB, PC, TB

PRECIOUS METALS: PG, SG - 30% increase from Group 3*
 STAINLESS STEEL: SS *Pricing subject to change

KITCHEN FAUCETS



- 4200-PN
- 4025-PN
- 4060-PN
- 4020-PN
- 1100HC-PN



TOWSON KITCHEN FAUCET / 12" ARTICULATED SPOUT**MODEL: 4100-12****LIST PRICES:****GRP 1: 2068****GRP 2: 2172****GRP 3: 2832****SS : N/A****MEETS THE FOLLOWING:**

- ASME A112.18.1
- CSA B125.1
- NSF 61, 372
- CALGreen
- ICC Approved

- 12-3/4" overall height.
- Equipped with spray diverter and 1/4" NPT pipe fitting connection for optional side spray.
- 1.75 gpm maximum flow rate with aerated tip.
- When mounted on side, handle can adjust 45 degrees for backsplash clearance.
- Articulated spout has 12" reach and can swivel 360 degrees.
- Single handle can mount in front, right or left hand positions.
- Handle ring can be adjusted to preferred push/pull tension and prevents sag.
- Hot/cold ceramic disk valve cartridge.
- Compatible with reverse osmosis water and systems.
- Made from solid brass.

**TOWSON KITCHEN FAUCET / 18" ARTICULATED SPOUT****MODEL: 4100-18****LIST PRICES:****GRP 1: 2191****GRP 2: 2301****GRP 3: 2999****SS : N/A****MEETS THE FOLLOWING:**

- ASME A112.18.1
- CSA B125.1
- NSF 61, 372
- CALGreen
- ICC Approved

- 12-3/4" overall height.
- Articulated spout has 18" reach and can swivel 360 degrees.
- Equipped with spray diverter and 1/4" NPT pipe fitting connection for optional side spray.
- 1.75 gpm maximum flow rate with aerated tip.
- Handle ring can be adjusted to preferred push/pull tension and prevents sag.
- Hot/cold ceramic disk valve cartridge.
- Compatible with reverse osmosis water and systems.
- Made from solid brass.

**ANNAPOLIS KITCHEN FAUCET / HOOK SPOUT****MODEL: 4200****LIST PRICES:****GRP 1: 1863****GRP 2: 1956****GRP 3: 2550****SS : N/A****MEETS THE FOLLOWING:**

- ASME A112.18.1
- CSA B125.1
- NSF 61, 372
- CALGreen
- ICC Approved

- 13-1/2" overall height.
- Hook spout has 10-1/2" reach and can swivel 360 degrees.
- Equipped with spray diverter and 1/4" NPT pipe fitting connection for optional side spray.
- 1.75 gpm maximum flow rate with aerated tip.
- Handle ring can be adjusted to preferred push/pull tension and prevents sag.
- Hot/cold ceramic disk valve cartridge.
- Compatible with reverse osmosis water and systems.
- Made from solid brass.



FINISH GROUP 1: CH
 FINISH GROUP 2: BLN, CD, CHB, CLZ, GR, MB, MW, PB, PN, SB, SC, SN, UPB
 FINISH GROUP 3: AB, ABZ, AC, AMB, AP, CB, DAB, DAC, DAMB, DAP, MAB, MAC, MAP, ORB, PC, TB

PRECIOUS METALS: PG, SG - 30% increase from Group 3*
 STAINLESS STEEL: SS *Pricing subject to change

HAMPTON KITCHEN FAUCET / C-SPOUT

MODEL: 4300

LIST PRICES:

GRP 1: 1832

GRP 2: 1923

GRP 3: 2506

SS : N/A

- 14" spout height.
- C-spout has 8-3/4" reach and can swivel 360 degrees.
- Equipped with spray diverter and 1/4" NPT pipe fitting connection for optional side spray.
- 1.75 gpm maximum flow rate with aerated tip.
- Handle ring can be adjusted to preferred push/pull tension and prevents sag.
- Hot/cold ceramic disk valve cartridge.
- Made from solid brass.

MEETS THE FOLLOWING:

- ASME A112.18.1
- CSA B125.1
- NSF 61, 372
- CALGreen
- ICC Approved



TOWSON TWO HANDLE KITCHEN FAUCET / 12" ARTICULATED SPOUT

MODEL: 8010-12

LIST PRICES:

GRP 1: 2410

GRP 2: 2529

GRP 3: 3296

SS : N/A

- 14-3/4" overall height.
- Articulated spout has 12" reach and can swivel 360 degrees.
- Equipped with spray diverter and 1/4" NPT pipe fitting connection for optional side spray.
- 1.75 gpm maximum flow rate with aerated tip.
- Hot and cold dual lever control with ceramic disk valve cartridges.
- Adjustable handle brake system provides smooth pull and prevents sagging.
- Compatible with reverse osmosis water and systems.
- Made from solid brass.

MEETS THE FOLLOWING:

- ASME A112.18.1
- CSA B125.1
- NSF 61, 372
- CALGreen
- ICC Approved



TOWSON TWO HANDLE KITCHEN FAUCET / 18" ARTICULATED SPOUT

MODEL: 8010-18

LIST PRICES:

GRP 1: 2561

GRP 2: 2689

GRP 3: 3505

SS : N/A

- 14-3/4" overall height.
- Articulated spout has 18" reach and can swivel 360 degrees.
- Equipped with spray diverter and 1/4" NPT pipe fitting connection for optional side spray.
- 1.75 gpm maximum flow rate with aerated tip.
- Hot and cold dual lever control with ceramic disk valve cartridges.
- Adjustable handle brake system provides smooth pull and prevents sagging.
- Compatible with reverse osmosis water and systems.
- Made from solid brass.

MEETS THE FOLLOWING:

- ASME A112.18.1
- CSA B125.1
- NSF 61, 372
- CALGreen
- ICC Approved



FINISH GROUP 1: CH
 FINISH GROUP 2: BLN, CD, CHB, CLZ, GR, MB, MW, PB, PN, SB, SC, SN, UPB
 FINISH GROUP 3: AB, ABZ, AC, AMB, AP, CB, DAB, DAC, DAMB, DAP, MAB, MAC, MAP, ORB, PC, TB

PRECIOUS METALS: PG, SG - 30% increase from Group 3*
 STAINLESS STEEL: SS *Pricing subject to change

ANNAPOLIS TWO HANDLE KITCHEN FAUCET / HOOK SPOUT

MODEL: 8020

LIST PRICES:

GRP 1: 1864

GRP 2: 1958

GRP 3: 2551

SS : N/A

MEETS THE FOLLOWING:

- ASME A112.18.1
- CSA B125.1
- NSF 61, 372
- CALGreen
- ICC Approved

- 15-1/2" overall height.
- Hook spout has 10-1/2" reach and can swivel 360 degrees.
- Equipped with spray diverter and 1/4" NPT pipe fitting connection for optional side spray.
- 1.75 gpm maximum flow rate with aerated tip.
- Hot and cold dual lever control with ceramic disk valve cartridges.
- Adjustable handle brake system provides smooth pull and prevents sagging.
- Compatible with reverse osmosis water and systems.
- Made from solid brass.



HAMPTON TWO HANDLE KITCHEN FAUCET / C-SPOUT

MODEL: 8030

LIST PRICES:

GRP 1: 1838

GRP 2: 1930

GRP 3: 2516

SS : N/A

MEETS THE FOLLOWING:

- ASME A112.18.1
- CSA B125.1
- NSF 61, 372
- CALGreen
- ICC Approved

- 16" overall height.
- C-spout has 8-1/4" reach and can swivel 360 degrees.
- Equipped with spray diverter and 1/4" NPT pipe fitting connection for optional side spray.
- 1.75 gpm maximum flow rate with aerated tip.
- Adjustable handle brake system provides smooth pull and prevents sagging.
- Compatible with reverse osmosis water and systems.
- Made from solid brass.



HUNLEY KITCHEN FAUCET / 12" ARTICULATED SPOUT

MODEL: 3600-12

LIST PRICES:

GRP 1: 2121

GRP 2: 2226

GRP 3: 2901

SS : 2979

MEETS THE FOLLOWING:

- ASME A112.18.1
- CSA B125.1
- NSF 61, 372
- CALGreen
- ICC Approved

- 13" overall height.
- Equipped with spray diverter and 1/4" NPT pipe fitting connection for optional side spray.
- 1.75 gpm maximum flow rate with aerated tip.
- Articulated spout has 12" reach and can swivel 360 degrees.
- Ergonomic single lever handle.
- Handle ring can be adjusted to preferred push/pull tension and prevents sag.
- Hot/cold ceramic disk valve cartridge.
- Compatible with reverse osmosis water and systems.
- Made from solid brass.



FINISH GROUP 1: CH
 FINISH GROUP 2: BLN, CD, CHB, CLZ, GR, MB, MW, PB, PN, SB, SC, SN, UPB
 FINISH GROUP 3: AB, ABZ, AC, AMB, AP, CB, DAB, DAC, DAMB, DAP, MAB, MAC, MAP, ORB, PC, TB

PRECIOUS METALS: PG, SG - 30% increase from Group 3*
 STAINLESS STEEL: SS

HUNLEY KITCHEN FAUCET / 18" ARTICULATED SPOUT

MODEL: 3600-18

LIST PRICES:

GRP 1: 2249

GRP 2: 2360

GRP 3: 3077

SS : 3160

MEETS THE FOLLOWING:

- ASME A112.18.1
- CSA B125.1
- NSF 61, 372
- CALGreen
- ICC Approved

- 13" overall height.
- Equipped with spray diverter and 1/4" NPT pipe fitting connection for optional side spray.
- 1.75 gpm maximum flow rate with aerated tip.
- Articulated spout has 18" reach and can swivel 360 degrees.
- Ergonomic single lever handle.
- Handle ring can be adjusted to preferred push/pull tension and prevents sag.
- Hot/cold ceramic disk valve cartridge.
- Compatible with reverse osmosis water and systems.
- Made from solid brass or 316 stainless steel.



PARCHE KITCHEN FAUCET / C-SPOUT

MODEL: 3800

LIST PRICES:

GRP 1: 1793

GRP 2: 1882

GRP 3: 2453

SS : 2520

MEETS THE FOLLOWING:

- ASME A112.18.1
- CSA B125.1
- NSF 61, 372
- CALGreen
- ICC Approved

- 16-5/8" overall height.
- C-spout has 9-1/8" reach and can swivel 360 degrees.
- Equipped with spray diverter and 1/4" NPT pipe fitting connection for optional side spray.
- 1.75 gpm maximum flow rate with aerated tip.
- Handle ring can be adjusted to preferred push/pull tension and prevents sag.
- Hot/cold ceramic disk valve cartridge.
- Compatible with reverse osmosis water and systems.
- Made from solid brass or 316 stainless steel.



FULTON KITCHEN FAUCET / 2 BEND U-SPOUT

MODEL: 3825

LIST PRICES:

GRP 1: 1858

GRP 2: 1951

GRP 3: 2541

SS : 2611

MEETS THE FOLLOWING:

- ASME A112.18.1
- CSA B125.1
- NSF 61, 372
- CALGreen
- ICC Approved

- 16-5/8" overall height.
- Equipped with spray diverter and 1/4" NPT pipe fitting connection for optional side spray.
- 1.75 gpm maximum flow rate with aerated tip.
- Articulated spout has 12" reach and can swivel 360 degrees.
- Ergonomic single lever handle.
- Handle ring can be adjusted to preferred push/pull tension and prevents sag.
- Hot/cold ceramic disk valve cartridge.
- Compatible with reverse osmosis water and systems.
- Made from solid brass or 316 stainless steel.



FINISH GROUP 1: CH
 FINISH GROUP 2: BLN, CD, CHB, CLZ, GR, MB, MW, PB, PN, SB, SC, SN, UPB
 FINISH GROUP 3: AB, ABZ, AC, AMB, AP, CB, DAB, DAC, DAMB, DAP, MAB, MAC, MAP, ORB, PC, TB

PRECIOUS METALS: PG, SG - 30% increase from Group 3*
 STAINLESS STEEL: SS

PREP & BAR FAUCETS



- 4900-TB
- 4010-TB



- 1655-SN
- 1455HC-SN



- 1850-SN
- 1750-SN

TOWSON PREP FAUCET / STRAIGHT SPOUT

MODEL: 4700

LIST PRICES:

GRP 1: 1825

GRP 2: 1916

GRP 3: 2497

SS : N/A

MEETS THE FOLLOWING:

- ASME A112.18.1
- CSA B125.1
- NSF 61, 372
- CALGreen
- ICC Approved

- 12-3/4" overall height.
- Straight spout has 6" reach and can swivel 360 degrees.
- Equipped with spray diverter and 1/4" NPT pipe fitting connection for optional side spray.
- 1.75 gpm maximum flow rate with aerated tip.
- Handle ring can be adjusted to preferred push/pull tension and prevents sag.
- Hot/cold ceramic disk valve cartridge.
- Compatible with reverse osmosis water and systems.
- Made from solid brass.



ANNAPOLIS PREP FAUCET / HOOK SPOUT

MODEL: 4800

LIST PRICES:

GRP 1: 1793

GRP 2: 1882

GRP 3: 2453

SS : N/A

MEETS THE FOLLOWING:

- ASME A112.18.1
- CSA B125.1
- NSF 61, 372
- CALGreen
- ICC Approved

- 12-5/8" overall height.
- Hook spout has 6-3/4" reach and can swivel 360 degrees.
- Equipped with spray diverter and 1/4" NPT pipe fitting connection for optional side spray.
- 1.75 gpm maximum flow rate with aerated tip.
- Hot/cold ceramic disk valve cartridge.
- Handle ring can be adjusted to preferred push/pull tension and prevents sag.
- Compatible with reverse osmosis water and systems.
- Made from solid brass.



HAMPTON PREP FAUCET / C-SPOUT

MODEL: 4900

LIST PRICES:

GRP 1: 1729

GRP 2: 1816

GRP 3: 2366

SS : N/A

MEETS THE FOLLOWING:

- ASME A112.18.1
- CSA B125.1
- NSF 61, 372
- CALGreen
- ICC Approved

- 13-3/4" overall height..
- C-spout has 6-3/4" reach and can swivel 360 degrees.
- Equipped with spray diverter and 1/4" NPT pipe fitting connection for optional side spray.
- 1.75 gpm maximum flow rate with aerated tip.
- Hot/cold ceramic disk valve cartridge.
- Handle ring can be adjusted to preferred push/pull tension and prevents sag.
- Compatible with reverse osmosis water and systems.
- Made from solid brass



FINISH GROUP 1: CH
 FINISH GROUP 2: BLN, CD, CHB, CLZ, GR, MB, MW, PB, PN, SB, SC, SN, UPB
 FINISH GROUP 3: AB, ABZ, AC, AMB, AP, CB, DAB, DAC, DAMB, DAP, MAB, MAC, MAP, ORB, PC, TB

PRECIOUS METALS: PG, SG - 30% increase from Group 3*
 STAINLESS STEEL: SS

HUNLEY PREP FAUCET / STRAIGHT SPOUT
MODEL: 3500

LIST PRICES:
GRP 1: 1788
GRP 2: 1877
GRP 3: 2445
SS : 2512

MEETS THE FOLLOWING:

- ASME A112.18.1
- CSA B125.1
- NSF 61, 372
- CALGreen
- ICC Approved

- 13" overall height.
- Straight spout has 6-1/2" reach and can swivel 360 degrees.
- Equipped with spray diverter and 1/4" NPT pipe fitting connection for optional side spray.
- 1.75 gpm maximum flow rate with aerated tip.
- Handle ring can be adjusted to preferred push/pull tension and prevents sag.
- Hot/cold ceramic disk valve cartridge.
- Compatible with reverse osmosis water and systems.
- Made from solid brass or 316 stainless steel.



PARCHE PREP FAUCET / C-SPOUT
MODEL: 3900

LIST PRICES:
GRP 1: 1665
GRP 2: 1748
GRP 3: 2278
SS : 2340

MEETS THE FOLLOWING:

- ASME A112.18.1
- CSA B125.1
- NSF 61, 372
- CALGreen
- ICC Approved

- 16-5/8" overall height.
- C-spout has 7" reach and can swivel 360 degrees.
- Equipped with spray diverter and 1/4" NPT pipe fitting connection for optional side spray.
- 1.75 gpm maximum flow rate with aerated tip.
- Handle ring can be adjusted to preferred push/pull tension and prevents sag.
- Hot/cold ceramic disk valve cartridge..
- Compatible with reverse osmosis water and systems
- Made from solid brass or 316 stainless steel.



FULTON PREP FAUCET / 2 BEND U-SPOUT
MODEL: 3925

LIST PRICES:
GRP 1: 1729
GRP 2: 1816
GRP 3: 2366
SS : 2430

MEETS THE FOLLOWING:

- ASME A112.18.1
- CSA B125.1
- NSF 61, 372
- CALGreen
- ICC Approved

- 15-1/4" overall height.
- 2 bend U-spout has 7" reach and can swivel 360 degrees.
- Equipped with spray diverter and 1/4" NPT pipe fitting connection for optional side spray.
- 1.75 gpm maximum flow rate with aerated tip.
- Handle ring can be adjusted to preferred push/pull tension and prevents sag.
- Hot/cold ceramic disk valve cartridge.
- Compatible with reverse osmosis water and systems.
- Made from solid brass or 316 stainless steel.



FINISH GROUP 1: CH
 FINISH GROUP 2: BLN, CD, CHB, CLZ, GR, MB, MW, PB, PN, SB, SC, SN, UPB
 FINISH GROUP 3: AB, ABZ, AC, AMB, AP, CB, DAB, DAC, DAMB, DAP, MAB, MAC, MAP, ORB, PC, TB

PRECIOUS METALS: PG, SG - 30% increase from Group 3*
 STAINLESS STEEL: SS

ANNAPOLIS BAR FAUCET / LEVER HANDLES

MODEL: 1300

LIST PRICES:

GRP 1: 1102

GRP 2: 1158

GRP 3: 1509

SS : N/A

- 11-1/2" overall height.
- Hook spout has 7" reach and can swivel 360 degrees.
- 1.7 gpm maximum flow rate with aerated tip.
- 1/4 turn ceramic disk valve cartridges.
- Compatible with reverse osmosis water and systems.
- Removable aerator tip for easy cleaning.
- 3/8" compression connections.
- Reinforced braided hoses.
- Made from solid brass.

MEETS THE FOLLOWING:

- ASME A112.18.1
- CSA B125.1
- NSF 61, 372
- CALGreen
- ICC Approved



ANNAPOLIS BAR FAUCET / CROSS HANDLES

MODEL: 1350

LIST PRICES:

GRP 1: 1136

GRP 2: 1193

GRP 3: 1553

SS : N/A

- 11-1/2" overall height.
- Hook spout has 7" reach and can swivel 360 degrees.
- 1.7 gpm maximum flow rate with aerated tip.
- 1/4 turn ceramic disk valve cartridges.
- Compatible with reverse osmosis water and systems.
- Removable aerator tip for easy cleaning.
- 3/8" compression connections.
- Reinforced braided hoses.
- Made from solid brass.

MEETS THE FOLLOWING:

- ASME A112.18.1
- CSA B125.1
- NSF 61, 372
- CALGreen
- ICC Approved



HAMPTON BAR FAUCET / LEVER HANDLES

MODEL: 1500

LIST PRICES:

GRP 1: 983

GRP 2: 1034

GRP 3: 1346

SS : N/A

- 11-3/4" overall height.
- C-spout has 7" reach and can swivel 360 degrees.
- 1.7 gpm maximum flow rate with aerated tip.
- 1/4 turn ceramic disk valve cartridges.
- Compatible with reverse osmosis water and systems.
- Removable aerator tip for easy cleaning.
- 3/8" compression connections.
- Reinforced braided hoses.
- Made from solid brass.

MEETS THE FOLLOWING:

- ASME A112.18.1
- CSA B125.1
- NSF 61, 372
- CALGreen
- ICC Approved



FINISH GROUP 1: CH
 FINISH GROUP 2: BLN, CD, CHB, CLZ, GR, MB, MW, PB, PN, SB, SC, SN, UPB
 FINISH GROUP 3: AB, ABZ, AC, AMB, AP, CB, DAB, DAC, DAMB, DAP, MAB, MAC, MAP, ORB, PC, TB

PRECIOUS METALS: PG, SG - 30% increase from Group 3*
 STAINLESS STEEL: SS

HAMPTON BAR FAUCET / CROSS HANDLES

MODEL: 1550

LIST PRICES:

GRP 1: 1039

GRP 2: 1091

GRP 3: 1421

SS : N/A

- 11-3/4" overall height.
- C-spout has 7" reach and can swivel 360 degrees.
- 1.7 gpm maximum flow rate with aerated tip.
- 1/4 turn ceramic disk valve cartridges.
- Compatible with reverse osmosis water and systems.
- Removable aerator tip for easy cleaning.
- 3/8" compression connections.
- Reinforced braided hoses.
- Made from solid brass.

MEETS THE FOLLOWING:

- ASME A112.18.1
- CSA B125.1
- NSF 61, 372
- CALGreen
- ICC Approved



PEMBROKE BAR FAUCET / LEVER HANDLES

MODEL: 1502

LIST PRICES:

GRP 1: 1027

GRP 2: 1080

GRP 3: 1405

SS : N/A

- 12-1/4" overall height.
- Matches all traditional PLP Pulldown Faucets.
- C-spout has 5" reach and can swivel 360 degrees.
- 1.7 gpm maximum flow rate with aerated tip.
- 1/4 turn ceramic disk valve cartridges.
- Compatible with reverse osmosis water and systems.
- Removable aerator tip for easy cleaning.
- 3/8" compression connections.
- Reinforced braided hoses.
- Made from solid brass.

MEETS THE FOLLOWING:

- ASME A112.18.1
- CSA B125.1
- NSF 61, 372
- CALGreen
- ICC Approved



PEMBROKE BAR FAUCET / CROSS HANDLES

MODEL: 1552

LIST PRICES:

GRP 1: 1073

GRP 2: 1128

GRP 3: 1469

SS : N/A

- 12-1/4" overall height.
- C-spout has 5" reach and can swivel 360 degrees.
- 1.7 gpm maximum flow rate with aerated tip.
- 1/4 turn ceramic disk valve cartridges.
- Compatible with reverse osmosis water and systems.
- Removable aerator tip for easy cleaning.
- 3/8" compression connections.
- Reinforced braided hoses.
- Made from solid brass.

MEETS THE FOLLOWING:

- ASME A112.18.1
- CSA B125.1
- NSF 61, 372
- CALGreen
- ICC Approved



FINISH GROUP 1: CH
 FINISH GROUP 2: BLN, CD, CHB, CLZ, GR, MB, MW, PB, PN, SB, SC, SN, UPB
 FINISH GROUP 3: AB, ABZ, AC, AMB, AP, CB, DAB, DAC, DAMB, DAP, MAB, MAC, MAP, ORB, PC, TB

PRECIOUS METALS: PG, SG - 30% increase from Group 3*
 STAINLESS STEEL: SS

TOWSON BAR FAUCET / LEVER HANDLES

MODEL: 1800

LIST PRICES:

GRP 1: 1296

GRP 2: 1360

GRP 3: 1773

SS : N/A

- 11-1/2" overall height.
- Straight spout has 7" reach and can swivel 360 degrees.
- 1.7 gpm maximum flow rate with aerated tip.
- 1/4 turn ceramic disk valve cartridges.
- Compatible with reverse osmosis water and systems.
- Removable aerator tip for easy cleaning.
- 3/8" compression connections.
- Reinforced braided hoses.
- Made from solid brass.

MEETS THE FOLLOWING:

- ASME A112.18.1
- CSA B125.1
- NSF 61, 372
- CALGreen
- ICC Approved



TOWSON BAR FAUCET / CROSS HANDLES

MODEL: 1850

LIST PRICES:

GRP 1: 1367

GRP 2: 1436

GRP 3: 1871

SS : N/A

- 11-1/2" overall height.
- Straight spout has 7" reach and can swivel 360 degrees.
- 1.7 gpm maximum flow rate with aerated tip.
- 1/4 turn ceramic disk valve cartridges.
- Compatible with reverse osmosis water and systems.
- Removable aerator tip for easy cleaning.
- 3/8" compression connections.
- Reinforced braided hoses.
- Made from solid brass.

MEETS THE FOLLOWING:

- ASME A112.18.1
- CSA B125.1
- NSF 61, 372
- CALGreen
- ICC Approved



PARCHE BAR FAUCET

MODEL: 1600

LIST PRICES:

GRP 1: 977

GRP 2: 1025

GRP 3: 1336

SS : 1372

- 13" overall height.
- C-spout has 7-1/4" reach and can swivel 360 degrees.
- 1.7 gpm maximum flow rate with aerated tip.
- 1/4 turn ceramic disk valve cartridges.
- Compatible with reverse osmosis water and systems.
- Removable aerator tip for easy cleaning.
- 3/8" compression connections.
- Reinforced braided hoses.
- Made from solid brass or 316 stainless steel.

MEETS THE FOLLOWING:

- ASME A112.18.1
- CSA B125.1
- NSF 61, 372
- CALGreen
- ICC Approved



FINISH GROUP 1: CH
 FINISH GROUP 2: BLN, CD, CHB, CLZ, GR, MB, MW, PB, PN, SB, SC, SN, UPB
 FINISH GROUP 3: AB, ABZ, AC, AMB, AP, CB, DAB, DAC, DAMB, DAP, MAB, MAC, MAP, ORB, PC, TB

PRECIOUS METALS: PG, SG - 30% increase from Group 3*
 STAINLESS STEEL: SS

FULTON BAR FAUCET**MODEL: 1625****LIST PRICES:****GRP 1: 989****GRP 2: 1039****GRP 3: 1353****SS : 1391****MEETS THE FOLLOWING:**

- ASME A112.18.1
- CSA B125.1
- NSF 61, 372
- CALGreen
- ICC Approved

- 13" overall height.
- 2 bend U-spout has 6-1/4" reach and can swivel 360 degrees.
- 1.7 gpm maximum flow rate with aerated tip.
- 1/4 turn ceramic disk valve cartridges.
- Compatible with reverse osmosis water and systems.
- Removable aerator tip for easy cleaning.
- 3/8" compression connections.
- Reinforced braided hoses.
- Made from solid brass or 316 stainless steel.

**HUNLEY BAR FAUCET****MODEL: 2500****LIST PRICES:****GRP 1: 1314****GRP 2: 1380****GRP 3: 1797****SS : 1846****MEETS THE FOLLOWING:**

- ASME A112.18.1
- CSA B125.1
- NSF 61, 372
- CALGreen
- ICC Approved

- 11" overall height.
- Straight spout has 7" reach and can swivel 360 degrees.
- 1.7 gpm maximum flow rate with aerated tip.
- 1/4 turn ceramic disk valve cartridges.
- Compatible with reverse osmosis water and systems.
- Removable aerator tip for easy cleaning.
- 3/8" compression connections.
- Reinforced braided hoses.
- Made from solid brass or 316 stainless steel.

**INDUSTRIAL BAR FAUCET / C-SPOUT****MODEL: 1650****LIST PRICES:****GRP 1: 1073****GRP 2: 1128****GRP 3: 1469****SS : 1510****MEETS THE FOLLOWING:**

- ASME A112.18.1
- CSA B125.1
- NSF 61, 372
- CALGreen
- ICC Approved

- 13" overall height.
- C-spout has 7-1/4" reach and can swivel 360 degrees.
- 1.7 gpm maximum flow rate with aerated tip.
- 1/4 turn ceramic disk valve cartridges.
- Compatible with reverse osmosis water and systems.
- Removable aerator tip for easy cleaning.
- 3/8" compression connections.
- Reinforced braided hoses.
- Made from solid brass or 316 stainless steel.



FINISH GROUP 1: CH
 FINISH GROUP 2: BLN, CD, CHB, CLZ, GR, MB, MW, PB, PN, SB, SC, SN, UPB
 FINISH GROUP 3: AB, ABZ, AC, AMB, AP, CB, DAB, DAC, DAMB, DAP, MAB, MAC, MAP, ORB, PC, TB

PRECIOUS METALS: PG, SG - 30% increase from Group 3*
 STAINLESS STEEL: SS

INDUSTRIAL BAR FAUCET / 2 BEND U-SPOUT

MODEL: 1655

LIST PRICES:

GRP 1: 1087

GRP 2: 1142

GRP 3: 1487

SS : 1527

- 13" overall height.
- 2 bend U-spout has 6-1/4" reach and can swivel 360 degrees.
- 1.7 gpm maximum flow rate with aerated tip.
- 1/4 turn ceramic disk valve cartridges.
- Compatible with reverse osmosis water and systems.
- Removable aerator tip for easy cleaning.
- 3/8" compression connections.
- Reinforced braided hoses.
- Made from solid brass or 316 stainless steel.



MEETS THE FOLLOWING:

- ASME A112.18.1
- CSA B125.1
- NSF 61, 372
- CALGreen
- ICC Approved

FILTRATION FAUCETS



- 9900-MB/CLZ
- 1450H-MBCLZ



- 3710-18-4-CH
- 1900HC-CH



- 5600-3-AB
- 1202H-AB

ANNAPOLIS COLD ONLY FILTRATION FAUCET / LEVER HANDLE MODEL: 1100C

LIST PRICES:

GRP 1: 805

GRP 2: 843

GRP 3: 1100

SS : N/A

MEETS THE FOLLOWING:

- ASME A112.18.1
- CSA B125.1
- NSF 61, 372
- CALGreen
- ICC Approved

- 9" overall height.
- Hook spout has 4-7/8" reach and can swivel 360 degrees.
- 1.1 gpm maximum flow rate.
- 1/4 turn ceramic disk valve cartridge
- Cold filtered water on demand.
- For use with Waterstone Filtration System.
- Compatible with reverse osmosis water and systems.
- 1/4" tubing connection
- Made from solid brass



ANNAPOLIS HOT ONLY FILTRATION FAUCET / LEVER HANDLE MODEL: 1100H

LIST PRICES:

GRP 1: 836

GRP 2: 878

GRP 3: 1143

SS : N/A

MEETS THE FOLLOWING:

- ASME A112.18.1
- CSA B125.1
- NSF 61, 372
- CALGreen
- ICC Approved

- 9" overall height.
- Hook spout has 4-7/8" reach and can swivel 360 degrees.
- 1.1 gpm maximum flow rate.
- 1/4 turn ceramic disk valve cartridge
- Instant hot water on demand.
- For use with Waterstone Filtration System.
- Compatible with reverse osmosis water and systems.
- 1/4" tubing connection
- Made from solid brass



ANNAPOLIS HOT AND COLD FILTRATION FAUCET / LEVER HANDLES MODEL: 1100HC

LIST PRICES:

GRP 1: 939

GRP 2: 987

GRP 3: 1285

SS : N/A

MEETS THE FOLLOWING:

- ASME A112.18.1
- CSA B125.1
- NSF 61, 372
- CALGreen
- ICC Approved

- 9" overall height.
- Hook spout has 4-7/8" reach and can swivel 360 degrees.
- 1.1 gpm maximum flow rate.
- 1/4 turn ceramic disk valve cartridges.
- Hot and cold filtered water on demand.
- For use with Waterstone Filtration System.
- Compatible with reverse osmosis water and systems.
- 1/4" tubing connection
- Made from solid brass



FINISH GROUP 1: CH
FINISH GROUP 2: BLN, CD, CHB, CLZ, GR, MB, MW, PB, PN, SB, SC, SN, UPB
FINISH GROUP 3: AB, ABZ, AC, AMB, AP, CB, DAB, DAC, DAMB, DAP, MAB, MAC, MAP, ORB, PC, TB

PRECIOUS METALS: PG, SG - 30% increase from Group 3*
STAINLESS STEEL: SS

ANNAPOLIS COLD ONLY FILTRATION FAUCET / CROSS HANDLE
MODEL: 1150C

LIST PRICES:

GRP 1: 843

GRP 2: 885

GRP 3: 1153

SS : N/A

MEETS THE FOLLOWING:

- ASME A112.18.1
- CSA B125.1
- NSF 61, 372
- CALGreen
- ICC Approved

- 9" overall height.
- Hook spout has 4-7/8" reach and can swivel 360 degrees.
- 1 gpm maximum flow rate.
- 1/4 turn ceramic disk valve cartridge.
- 1/4" compression connection.
- Cold filtered water on demand.
- For use with Waterstone Filtration System.
- Compatible with reverse osmosis water and systems.
- 1/4" tubing connection
- Made from solid brass



ANNAPOLIS HOT ONLY FILTRATION FAUCET / CROSS HANDLE
MODEL: 1150H

LIST PRICES:

GRP 1: 868

GRP 2: 912

GRP 3: 1187

SS : N/A

MEETS THE FOLLOWING:

- ASME A112.18.1
- CSA B125.1
- NSF 61, 372
- CALGreen
- ICC Approved

- 9" overall height.
- Hook spout has 4-7/8" reach and can swivel 360 degrees.
- 1.1 gpm maximum flow rate.
- 1/4 turn ceramic disk valve cartridge
- Instant hot water on demand.
- For use with Waterstone Filtration System.
- Compatible with reverse osmosis water and systems.
- 1/4" tubing connection.
- Made from solid brass.



ANNAPOLIS HOT AND COLD FILTRATION FAUCET / CROSS HANDLES
MODEL: 1150HC

LIST PRICES:

GRP 1: 974

GRP 2: 1023

GRP 3: 1332

SS : N/A

MEETS THE FOLLOWING:

- ASME A112.18.1
- CSA B125.1
- NSF 61, 372
- CALGreen
- ICC Approved

- 9" overall height.
- Hook spout has 4-7/8" reach and can swivel 360 degrees.
- 1.1 gpm maximum flow rate.
- 1/4 turn ceramic disk valve cartridges.
- Hot and cold filtered water on demand.
- For use with Waterstone Filtration System.
- Compatible with reverse osmosis water and systems.
- 1/4" tubing connection.
- Made from solid brass.



FINISH GROUP 1: CH
 FINISH GROUP 2: BLN, CD, CHB, CLZ, GR, MB, MW, PB, PN, SB, SC, SN, UPB
 FINISH GROUP 3: AB, ABZ, AC, AMB, AP, CB, DAB, DAC, DAMB, DAP, MAB, MAC, MAP, ORB, PC, TB

PRECIOUS METALS: PG, SG - 30% increase from Group 3*
 STAINLESS STEEL: SS

FILTRATION FAUCETS

HAMPTON COLD ONLY FILTRATION FAUCET / LEVER HANDLE
MODEL: 1200C

LIST PRICES:
GRP 1: 728
GRP 2: 764
GRP 3: 996
SS : N/A

MEETS THE FOLLOWING:

- ASME A112.18.1
- CSA B125.1
- NSF 61, 372
- CALGreen
- ICC Approved

- 9-7/8" overall height.
- C-spout has 5-1/4" reach and can swivel 360 degrees.
- 1.1 gpm maximum flow rate.
- Cold filtered water on demand.
- For use with Waterstone Filtration System.
- Compatible with reverse osmosis water and systems.
- 1/4" tubing connection.
- Made from solid brass.



HAMPTON HOT ONLY FILTRATION FAUCET / LEVER HANDLE
MODEL: 1200H

LIST PRICES:
GRP 1: 778
GRP 2: 817
GRP 3: 1065
SS : N/A

MEETS THE FOLLOWING:

- ASME A112.18.1
- CSA B125.1
- NSF 61, 372
- CALGreen
- ICC Approved

- 9-7/8" overall height.
- C-spout has 5-1/4" reach and can swivel 360 degrees.
- 1.1 gpm maximum flow rate.
- Instant hot water on demand.
- For use with Waterstone Filtration System.
- Compatible with reverse osmosis water and systems.
- 1/4" tubing connection.
- Made from solid brass.



HAMPTON HOT AND COLD FILTRATION FAUCET / LEVER HANDLES
MODEL: 1200HC

LIST PRICES:
GRP 1: 881
GRP 2: 926
GRP 3: 1205
SS : N/A

MEETS THE FOLLOWING:

- ASME A112.18.1
- CSA B125.1
- NSF 61, 372
- CALGreen
- ICC Approved

- 9-7/8" overall height.
- C-spout has 5-1/4" reach and can swivel 360 degrees.
- 1.1 gpm maximum flow rate.
- Hot and cold filtered water on demand.
- For use with Waterstone Filtration System.
- Compatible with reverse osmosis water and systems.
- 1/4" tubing connection.
- Made from solid brass.



FINISH GROUP 1: CH
 FINISH GROUP 2: BLN, CD, CHB, CLZ, GR, MB, MW, PB, PN, SB, SC, SN, UPB
 FINISH GROUP 3: AB, ABZ, AC, AMB, AP, CB, DAB, DAC, DAMB, DAP, MAB, MAC, MAP, ORB, PC, TB

PRECIOUS METALS: PG, SG - 30% increase from Group 3*
 STAINLESS STEEL: SS

**HAMPTON COLD ONLY FILTRATION FAUCET / CROSS HANDLE
MODEL 1250C**

LIST PRICES:
GRP 1: 763
GRP 2: 800
GRP 3: 1043
SS : N/A

MEETS THE FOLLOWING:

- ASME A112.18.1
- CSA B125.1
- NSF 61, 372
- CALGreen
- ICC Approved

- 9-7/8" overall height.
- C-spout has 5-1/4" reach and can swivel 360 degrees.
- 1.1 gpm maximum flow rate.
- Cold filtered water on demand.
- For use with Waterstone Filtration System.
- Compatible with reverse osmosis water and systems.
- 1/4" tubing connection.
- Made from solid brass.



**HAMPTON HOT ONLY FILTRATION FAUCET / CROSS HANDLE
MODEL:1250H**

LIST PRICES:
GRP 1: 810
GRP 2: 851
GRP 3: 1108
SS : N/A

MEETS THE FOLLOWING:

- ASME A112.18.1
- CSA B125.1
- NSF 61, 372
- CALGreen
- ICC Approved

- 9-7/8" overall height.
- C-spout has 5-1/4" reach and can swivel 360 degrees.
- 1.1 gpm maximum flow rate.
- Instant hot water on demand.
- For use with Waterstone Filtration System.
- Compatible with reverse osmosis water and systems.
- 1/4" tubing connection.
- Made from solid brass.



**HAMPTON HOT AND COLD FILTRATION FAUCET / CROSS HANDLES
MODEL: 1250HC**

LIST PRICES:
GRP 1: 913
GRP 2: 959
GRP 3: 1249
SS : N/A

MEETS THE FOLLOWING:

- ASME A112.18.1
- CSA B125.1
- NSF 61, 372
- CALGreen
- ICC Approved

- 9-7/8" overall height.
- C-spout has 5-1/4" reach and can swivel 360 degrees.
- 1.1 gpm maximum flow rate
- Hot and cold filtered water on demand.
- For use with Waterstone Filtration System.
- Compatible with reverse osmosis water and systems.
- 1/4" tubing connection.
- Made from solid brass.



FINISH GROUP 1: CH
 FINISH GROUP 2: BLN, CD, CHB, CLZ, GR, MB, MW, PB, PN, SB, SC, SN, UPB
 FINISH GROUP 3: AB, ABZ, AC, AMB, AP, CB, DAB, DAC, DAMB, DAP, MAB, MAC, MAP, ORB, PC, TB

PRECIOUS METALS: PG, SG - 30% increase from Group 3*
 STAINLESS STEEL: SS

PEMBROKE COLD ONLY FILTRATION FAUCET / LEVER HANDLE

MODEL: 1202C

LIST PRICES:

GRP 1: 808

GRP 2: 849

GRP 3: 1104

SS : N/A

- 10-1/4" overall height.
- C-spout has 5" reach and can swivel 360 degrees.
- 1.1 gpm maximum flow rate.
- For use with Waterstone Filtration System.
- Compatible with reverse osmosis water and systems.
- 1/4" tubing connection.
- Made from solid brass.

MEETS THE FOLLOWING:

- ASME A112.18.1
- CSA B125.1
- NSF 61, 372
- CALGreen
- ICC Approved



PEMBROKE HOT ONLY FILTRATION FAUCET / LEVER HANDLE

MODEL: 1202H

LIST PRICES:

GRP 1: 877

GRP 2: 921

GRP 3: 1200

SS : N/A

- 10-1/4" overall height.
- C-spout has 5" reach and can swivel 360 degrees.
- 1.1 gpm maximum flow rate.
- For use with Waterstone Filtration System.
- Compatible with reverse osmosis water and systems.
- 1/4" tubing connection.
- Made from solid brass.

MEETS THE FOLLOWING:

- ASME A112.18.1
- CSA B125.1
- NSF 61, 372
- CALGreen
- ICC Approved



PEMBROKE HOT AND COLD FILTRATION FAUCET / LEVER HANDLES

MODEL: 1202HC

LIST PRICES:

GRP 1: 985

GRP 2: 1036

GRP 3: 1349

SS : N/A

- 10-1/4" overall height.
- C-spout has 5" reach and can swivel 360 degrees.
- 1.1 gpm maximum flow rate.
- For use with Waterstone Filtration System.
- Compatible with reverse osmosis water and systems.
- 1/4" tubing connection.
- Made from solid brass.

MEETS THE FOLLOWING:

- ASME A112.18.1
- CSA B125.1
- NSF 61, 372
- CALGreen
- ICC Approved



FINISH GROUP 1: CH
 FINISH GROUP 2: BLN, CD, CHB, CLZ, GR, MB, MW, PB, PN, SB, SC, SN, UPB
 FINISH GROUP 3: AB, ABZ, AC, AMB, AP, CB, DAB, DAC, DAMB, DAP, MAB, MAC, MAP, ORB, PC, TB

PRECIOUS METALS: PG, SG - 30% increase from Group 3*
 STAINLESS STEEL: SS

PEMBROKE COLD ONLY FILTRATION FAUCET / CROSS HANDLE

MODEL: 1252C

LIST PRICES:

GRP 1: 838

GRP 2: 881

GRP 3: 1148

SS : N/A

MEETS THE FOLLOWING:

- ASME A112.18.1
- CSA B125.1
- NSF 61, 372
- CALGreen
- ICC Approved

- 10-1/4" overall height.
- C-spout has 5" reach and can swivel 360 degrees.
- 1.1 gpm maximum flow rate.
- For use with Waterstone Filtration System.
- Compatible with reverse osmosis water and systems.
- 1/4" tubing connection.
- Made from solid brass.



PEMBROKE HOT ONLY FILTRATION FAUCET / CROSS HANDLE

MODEL: 1252H

LIST PRICES:

GRP 1: 902

GRP 2: 948

GRP 3: 1235

SS : N/A

MEETS THE FOLLOWING:

- ASME A112.18.1
- CSA B125.1
- NSF 61, 372
- CALGreen
- ICC Approved

- 10-1/4" overall height.
- C-spout has 5" reach and can swivel 360 degrees.
- 1.1 gpm maximum flow rate.
- For use with Waterstone Filtration System.
- Compatible with reverse osmosis water and systems.
- 1/4" tubing connection.
- Made from solid brass.



PEMBROKE HOT AND COLD FILTRATION FAUCET / CROSS HANDLES

MODEL: 1252HC

LIST PRICES:

GRP 1: 1015

GRP 2: 1067

GRP 3: 1390

SS : N/A

MEETS THE FOLLOWING:

- ASME A112.18.1
- CSA B125.1
- NSF 61, 372
- CALGreen
- ICC Approved

- 10-1/4" overall height.
- C-spout has 5" reach and can swivel 360 degrees.
- 1.1 gpm maximum flow rate.
- For use with Waterstone Filtration System.
- Compatible with reverse osmosis water and systems.
- 1/4" tubing connection.
- Made from solid brass.



FINISH GROUP 1: CH
 FINISH GROUP 2: BLN, CD, CHB, CLZ, GR, MB, MW, PB, PN, SB, SC, SN, UPB
 FINISH GROUP 3: AB, ABZ, AC, AMB, AP, CB, DAB, DAC, DAMB, DAP, MAB, MAC, MAP, ORB, PC, TB

PRECIOUS METALS: PG, SG - 30% increase from Group 3*
 STAINLESS STEEL: SS

TOWSON COLD ONLY FILTRATION FAUCET / LEVER HANDLE
MODEL: 1700C

LIST PRICES:
GRP 1: 1015
GRP 2: 1067
GRP 3: 1390
SS : N/A

- 9" overall height.
- Straight spout has 4-3/4" reach and can swivel 360 degrees.
- 1.1 gpm maximum flow rate.
- For use with Waterstone Filtration System.
- Compatible with reverse osmosis water and systems.
- 1/4" tubing connection.
- Made from solid brass.

MEETS THE FOLLOWING:

- ASME A112.18.1
- CSA B125.1
- NSF 61, 372
- CALGreen
- ICC Approved



TOWSON HOT ONLY FILTRATION FAUCET / LEVER HANDLE
MODEL: 1700H

LIST PRICES:
GRP 1: 1080
GRP 2: 1133
GRP 3: 1477
SS : N/A

- 9" overall height.
- Straight spout has 4-3/4" reach and can swivel 360 degrees.
- 1.1 gpm maximum flow rate.
- For use with Waterstone Filtration System.
- Compatible with reverse osmosis water and systems.
- 1/4" tubing connection.
- Made from solid brass.

MEETS THE FOLLOWING:

- ASME A112.18.1
- CSA B125.1
- NSF 61, 372
- CALGreen
- ICC Approved



TOWSON HOT AND COLD FILTRATION FAUCET / LEVER HANDLES
MODEL: 1700HC

LIST PRICES:
GRP 1: 1197
GRP 2: 1257
GRP 3: 1637
SS : N/A

- 9" overall height.
- Straight spout has 4-3/4" reach and can swivel 360 degrees.
- 1.1 gpm maximum flow rate.
- For use with Waterstone Filtration System.
- Compatible with reverse osmosis water and systems.
- 1/4" tubing connection.
- Made from solid brass.

MEETS THE FOLLOWING:

- ASME A112.18.1
- CSA B125.1
- NSF 61, 372
- CALGreen
- ICC Approved



FINISH GROUP 1: CH
 FINISH GROUP 2: BLN, CD, CHB, CLZ, GR, MB, MW, PB, PN, SB, SC, SN, UPB
 FINISH GROUP 3: AB, ABZ, AC, AMB, AP, CB, DAB, DAC, DAMB, DAP, MAB, MAC, MAP, ORB, PC, TB

PRECIOUS METALS: PG, SG - 30% increase from Group 3*
 STAINLESS STEEL: SS

TOWSON COLD ONLY FILTRATION FAUCET / CROSS HANDLE MODEL: 1750C

LIST PRICES:

GRP 1: 1043

GRP 2: 1097

GRP 3: 1429

SS : N/A

MEETS THE FOLLOWING:

- ASME A112.18.1
- CSA B125.1
- NSF 61, 372
- CALGreen
- ICC Approved

- 9" overall height.
- Straight spout has 4-3/4" reach and can swivel 360 degrees.
- 1.1 gpm maximum flow rate.
- For use with Waterstone Filtration System.
- Compatible with reverse osmosis water and systems.
- 1/4" tubing connection.
- Made from solid brass.



TOWSON HOT ONLY FILTRATION FAUCET / CROSS HANDLE MODEL: 1750H

LIST PRICES:

GRP 1: 1006

GRP 2: 1055

GRP 3: 1374

SS : N/A

MEETS THE FOLLOWING:

- ASME A112.18.1
- CSA B125.1
- NSF 61, 372
- CALGreen
- ICC Approved

- 9" overall height.
- Straight spout has 4-3/4" reach and can swivel 360 degrees.
- 1.1 gpm maximum flow rate.
- For use with Waterstone Filtration System.
- Compatible with reverse osmosis water and systems.
- 1/4" tubing connection.
- Made from solid brass.



TOWSON HOT AND COLD FILTRATION FAUCET / CROSS HANDLES MODEL: 1750HC

LIST PRICES:

GRP 1: 1287

GRP 2: 1352

GRP 3: 1762

SS : N/A

MEETS THE FOLLOWING:

- ASME A112.18.1
- CSA B125.1
- NSF 61, 372
- CALGreen
- ICC Approved

- 9" overall height.
- Straight spout has 4-3/4" reach and can swivel 360 degrees.
- 1.1 gpm maximum flow rate.
- For use with Waterstone Filtration System.
- Compatible with reverse osmosis water and systems.
- 1/4" tubing connection.
- Made from solid brass.



FINISH GROUP 1: CH
FINISH GROUP 2: BLN, CD, CHB, CLZ, GR, MB, MW, PB, PN, SB, SC, SN, UPB
FINISH GROUP 3: AB, ABZ, AC, AMB, AP, CB, DAB, DAC, DAMB, DAP, MAB, MAC, MAP, ORB, PC, TB

PRECIOUS METALS: PG, SG - 30% increase from Group 3*
STAINLESS STEEL: SS

**PARCHE COLD ONLY FILTRATION FAUCET
MODEL: 1400C**

LIST PRICES:
GRP 1: 698
GRP 2: 733
GRP 3: 955
SS : 980

- 9-3/4" overall height.
- C-spout has 4" reach and can swivel 360 degrees.
- 1.1 gpm maximum flow rate.
- For use with Waterstone Filtration System.
- Compatible with reverse osmosis water and systems.
- 1/4" tubing connection.
- Made from solid brass or 316 stainless steel.

MEETS THE FOLLOWING:

- ASME A112.18.1
- CSA B125.1
- NSF 61, 372
- CALGreen
- ICC Approved



**PARCHE HOT ONLY FILTRATION FAUCET
MODEL: 1400H**

LIST PRICES:
GRP 1: 764
GRP 2: 803
GRP 3: 1044
SS : 1073

- 9-3/4" overall height.
- C-spout has 4" reach and can swivel 360 degrees.
- 1.1 gpm maximum flow rate.
- For use with Waterstone Filtration System.
- Compatible with reverse osmosis water and systems.
- 1/4" tubing connection.
- Made from solid brass or 316 stainless steel.

MEETS THE FOLLOWING:

- ASME A112.18.1
- CSA B125.1
- NSF 61, 372
- CALGreen
- ICC Approved



**PARCHE HOT AND COLD FILTRATION FAUCET
MODEL: 1400HC**

LIST PRICES:
GRP 1: 828
GRP 2: 870
GRP 3: 1135
SS : 1164

- 9-3/4" overall height.
- C-spout has 4" reach and can swivel 360 degrees.
- 1.1 gpm maximum flow rate.
- For use with Waterstone Filtration System.
- Compatible with reverse osmosis water and systems.
- 1/4" tubing connection.
- Made from solid brass or 316 stainless steel.

MEETS THE FOLLOWING:

- ASME A112.18.1
- CSA B125.1
- NSF 61, 372
- CALGreen
- ICC Approved



FINISH GROUP 1: CH
 FINISH GROUP 2: BLN, CD, CHB, CLZ, GR, MB, MW, PB, PN, SB, SC, SN, UPB
 FINISH GROUP 3: AB, ABZ, AC, AMB, AP, CB, DAB, DAC, DAMB, DAP, MAB, MAC, MAP, ORB, PC, TB

PRECIOUS METALS: PG, SG - 30% increase from Group 3*
 STAINLESS STEEL: SS

FULTON COLD ONLY FILTRATION FAUCET

MODEL: 1425C

LIST PRICES:

GRP 1: 746

GRP 2: 782

GRP 3: 1020

SS : 1048

- 9-3/4" overall height.
- 2 bend U-spout has 6" reach and can swivel 360 degrees.
- 1.1 gpm maximum flow rate.
- For use with Waterstone Filtration System.
- Compatible with reverse osmosis water and systems.
- 1/4" tubing connection.
- Made from solid brass or 316 stainless steel.

MEETS THE FOLLOWING:

- ASME A112.18.1
- CSA B125.1
- NSF 61, 372
- CALGreen
- ICC Approved



FULTON HOT ONLY FILTRATION FAUCET

MODEL: 1425H

LIST PRICES:

GRP 1: 810

GRP 2: 851

GRP 3: 1108

SS : 1138

- 9-3/4" overall height.
- 2 bend U-spout has 6" reach and can swivel 360 degrees.
- 1.1 gpm maximum flow rate.
- For use with Waterstone Filtration System.
- Compatible with reverse osmosis water and systems.
- 1/4" tubing connection.
- Made from solid brass or 316 stainless steel.

MEETS THE FOLLOWING:

- ASME A112.18.1
- CSA B125.1
- NSF 61, 372
- CALGreen
- ICC Approved



FULTON HOT AND COLD FILTRATION FAUCET

MODEL: 1425HC

LIST PRICES:

GRP 1: 875

GRP 2: 919

GRP 3: 1198

SS : 1230

- 9-3/4" overall height.
- 2 bend U-spout has 6" reach and can swivel 360 degrees.
- 1.1 gpm maximum flow rate.
- For use with Waterstone Filtration System.
- Compatible with reverse osmosis water and systems.
- 1/4" tubing connection.
- Made from solid brass or 316 stainless steel.

MEETS THE FOLLOWING:

- ASME A112.18.1
- CSA B125.1
- NSF 61, 372
- CALGreen
- ICC Approved



FINISH GROUP 1: CH
 FINISH GROUP 2: BLN, CD, CHB, CLZ, GR, MB, MW, PB, PN, SB, SC, SN, UPB
 FINISH GROUP 3: AB, ABZ, AC, AMB, AP, CB, DAB, DAC, DAMB, DAP, MAB, MAC, MAP, ORB, PC, TB

PRECIOUS METALS: PG, SG - 30% increase from Group 3*
 STAINLESS STEEL: SS

**HUNLEY COLD ONLY FILTRATION FAUCET
MODEL: 1900C**

LIST PRICES:

GRP 1: 993

GRP 2: 1042

GRP 3: 1358

SS : 1395

- 9" overall height.
- Straight spout has 5-3/4" reach and can swivel 360 degrees.
- 1.1 gpm maximum flow rate.
- For use with Waterstone Filtration System.
- Compatible with reverse osmosis water and systems.
- 1/4" tubing connection.
- Made from solid brass or 316 stainless steel.

MEETS THE FOLLOWING:

- ASME A112.18.1
- CSA B125.1
- NSF 61, 372
- CALGreen
- ICC Approved



**HUNLEY HOT ONLY FILTRATION FAUCET
MODEL: 1900H**

LIST PRICES:

GRP 1: 1052

GRP 2: 1103

GRP 3: 1438

SS : 1477

- 9" overall height.
- Straight spout has 5-3/4" reach and can swivel 360 degrees.
- 1.1 gpm maximum flow rate.
- For use with Waterstone Filtration System.
- Compatible with reverse osmosis water and systems.
- 1/4" tubing connection.
- Made from solid brass or 316 stainless steel.

MEETS THE FOLLOWING:

- ASME A112.18.1
- CSA B125.1
- NSF 61, 372
- CALGreen
- ICC Approved



**HUNLEY HOT AND COLD FILTRATION FAUCET
MODEL: 1900HC**

LIST PRICES:

GRP 1: 1115

GRP 2: 1171

GRP 3: 1526

SS : 1567

- 9" overall height.
- Straight spout has 5-3/4" reach and can swivel 360 degrees.
- 1.1 gpm maximum flow rate.
- For use with Waterstone Filtration System.
- Compatible with reverse osmosis water and systems.
- 1/4" tubing connection.
- Made from solid brass or 316 stainless steel.

MEETS THE FOLLOWING:

- ASME A112.18.1
- CSA B125.1
- NSF 61, 372
- CALGreen
- ICC Approved



FINISH GROUP 1: CH
FINISH GROUP 2: BLN, CD, CHB, CLZ, GR, MB, MW, PB, PN, SB, SC, SN, UPB
FINISH GROUP 3: AB, ABZ, AC, AMB, AP, CB, DAB, DAC, DAMB, DAP, MAB, MAC, MAP, ORB, PC, TB

PRECIOUS METALS: PG, SG - 30% increase from Group 3*
STAINLESS STEEL: SS

INDUSTRIAL COLD ONLY FILTRATION FAUCET / C-SPOUT

MODEL: 1450C

LIST PRICES:

GRP 1: 752

GRP 2: 791

GRP 3: 1031

SS : 1058

- 9-3/4" overall height.
- C-spout has 4" reach and can swivel 360 degrees.
- 1.1 gpm maximum flow rate.
- For use with Waterstone Filtration System.
- Compatible with reverse osmosis water and systems.
- 1/4" tubing connection.
- Made from solid brass or 316 stainless steel.

MEETS THE FOLLOWING:

- ASME A112.18.1
- CSA B125.1
- NSF 61, 372
- CALGreen
- ICC Approved



INDUSTRIAL HOT ONLY FILTRATION FAUCET / C-SPOUT

MODEL: 1450H

LIST PRICES:

GRP 1: 824

GRP 2: 866

GRP 3: 1127

SS : 1158

- 9-3/4" overall height.
- C-spout has 4" reach and can swivel 360 degrees.
- 1.1 gpm maximum flow rate.
- For use with Waterstone Filtration System.
- Compatible with reverse osmosis water and systems.
- 1/4" tubing connection.
- Made from solid brass or 316 stainless steel.

MEETS THE FOLLOWING:

- ASME A112.18.1
- CSA B125.1
- NSF 61, 372
- CALGreen
- ICC Approved



INDUSTRIAL HOT AND COLD FILTRATION FAUCET / C-SPOUT

MODEL: 1450HC

LIST PRICES:

GRP 1: 895

GRP 2: 938

GRP 3: 1224

SS : 1257

- 9-3/4" overall height.
- C-spout has 4" reach and can swivel 360 degrees.
- 1.1 gpm maximum flow rate.
- For use with Waterstone Filtration System.
- Compatible with reverse osmosis water and systems.
- 1/4" tubing connection.
- Made from solid brass or 316 stainless steel.

MEETS THE FOLLOWING:

- ASME A112.18.1
- CSA B125.1
- NSF 61, 372
- CALGreen
- ICC Approved



FINISH GROUP 1: CH
 FINISH GROUP 2: BLN, CD, CHB, CLZ, GR, MB, MW, PB, PN, SB, SC, SN, UPB
 FINISH GROUP 3: AB, ABZ, AC, AMB, AP, CB, DAB, DAC, DAMB, DAP, MAB, MAC, MAP, ORB, PC, TB

PRECIOUS METALS: PG, SG - 30% increase from Group 3*
 STAINLESS STEEL: SS

**INDUSTRIAL COLD ONLY FILTRATION FAUCET / 2 BEND U-SPOUT
MODEL: 1455C**

LIST PRICES:

GRP 1: 805

GRP 2: 843

GRP 3: 1100

SS : 1130

MEETS THE FOLLOWING:

- ASME A112.18.1
- CSA B125.1
- NSF 61, 372
- CALGreen
- ICC Approved

- 9-3/4" overall height.
- 2 bend U-spout has 6" reach and can swivel 360 degrees.
- 1.1 gpm maximum flow rate.
- For use with Waterstone Filtration System.
- Compatible with reverse osmosis water and systems.
- 1/4" tubing connection.
- Made from solid brass or 316 stainless steel.



**INDUSTRIAL HOT ONLY FILTRATION FAUCET / 2 BEND U-SPOUT
MODEL: 1455H**

LIST PRICES:

GRP 1 : 883

GRP 2 : 927

GRP 3 : 1207

SS : 1240

MEETS THE FOLLOWING:

- ASME A112.18.1
- CSA B125.1
- NSF 61, 372
- CALGreen
- ICC Approved

- 9-3/4" overall height.
- 2 bend U-spout has 6" reach and can swivel 360 degrees.
- 1.1 gpm maximum flow rate.
- For use with Waterstone Filtration System.
- Compatible with reverse osmosis water and systems.
- 1/4" tubing connection.
- Made from solid brass or 316 stainless steel.



**INDUSTRIAL HOT AND COLD FILTRATION FAUCET / 2 BEND U-SPOUT
MODEL: 1455HC**

LIST PRICES:

GRP 1 : 954

GRP 2 : 1003

GRP 3 : 1307

SS : 1342

MEETS THE FOLLOWING:

- ASME A112.18.1
- CSA B125.1
- NSF 61, 372
- CALGreen
- ICC Approved

- 9-3/4" overall height.
- 2 bend U-spout has 6" reach and can swivel 360 degrees.
- 1.1 gpm maximum flow rate.
- For use with Waterstone Filtration System.
- Compatible with reverse osmosis water and systems.
- 1/4" tubing connection.
- Made from solid brass or 316 stainless steel.



FINISH GROUP 1: CH
FINISH GROUP 2: BLN, CD, CHB, CLZ, GR, MB, MW, PB, PN, SB, SC, SN, UPB
FINISH GROUP 3: AB, ABZ, AC, AMB, AP, CB, DAB, DAC, DAMB, DAP, MAB, MAC, MAP, ORB, PC, TB

PRECIOUS METALS: PG, SG - 30% increase from Group 3*
STAINLESS STEEL: SS *Pricing subject to change

POTFILLERS



• 3200-CD

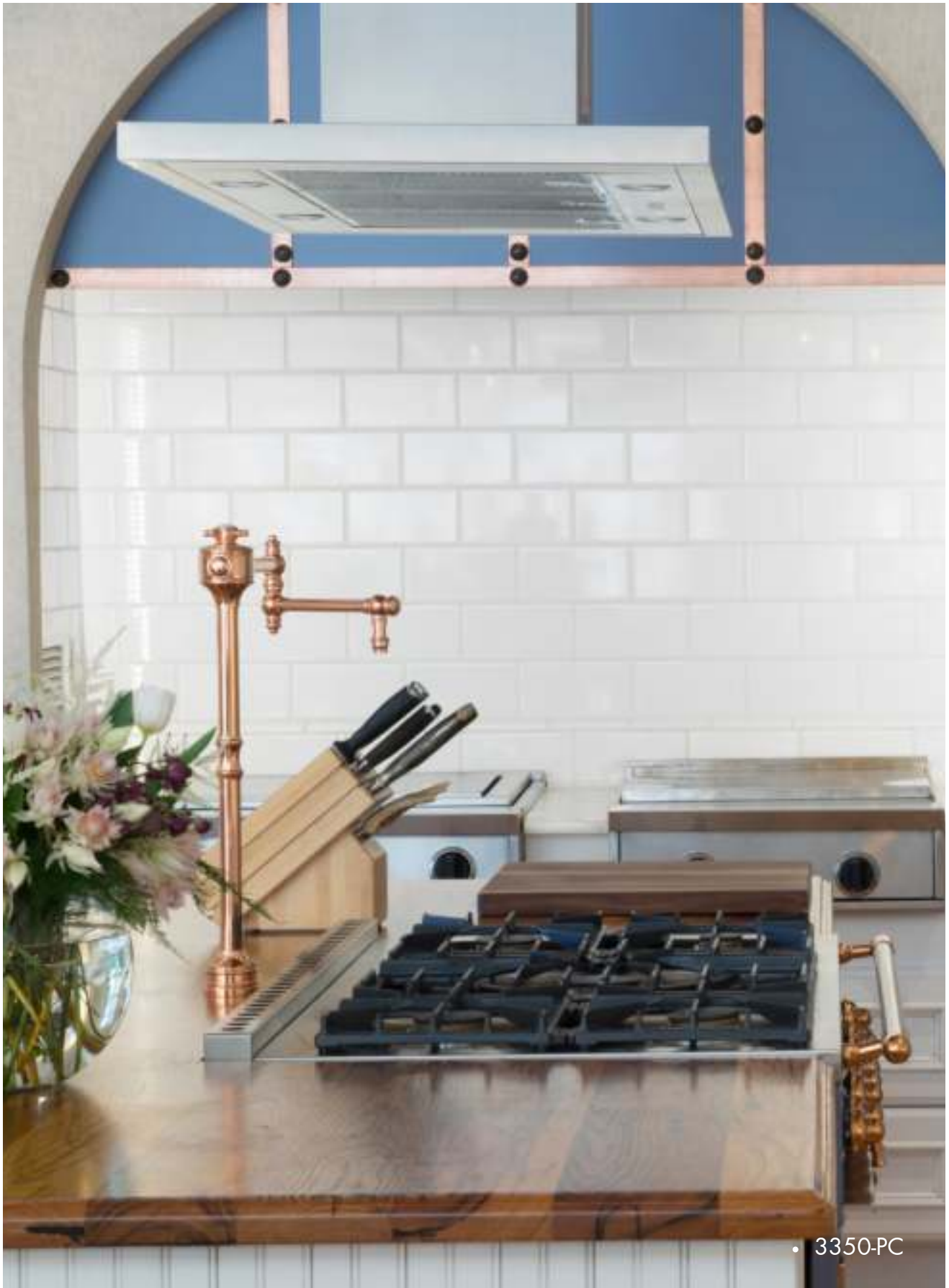

• 3350-PC



- 3100-CHB
- 4300-CHB
- 4010-CHB

TRADITIONAL WALL MOUNTED POTFILLER / LEVER HANDLE**MODEL: 3100****LIST PRICES:****GRP 1 : 2009****GRP 2 : 2110****GRP 3 : 2750****SS : N/A****MEETS THE FOLLOWING:**

- ASME A112.18.1
- CSA B125.1
- NSF 61, 372
- CALGreen
- ICC Approved

- 8-7/8" overall height.
- Stub-out connection 1/2" NPT.
- Articulated spout reach swings 22".
- 1.75 gpm maximum flow rate with aerated tip.
- 1/4 turn ceramic disk valve cartridge.
- Cold water hook up.
- Built-in check valve prevents dripping.
- Compatible with RO water and systems.
- Made from solid brass.

**TRADITIONAL WALL MOUNTED POTFILLER / CROSS HANDLE****MODEL: 3150****LIST PRICES:****GRP 1 : 1920****GRP 2 : 2016****GRP 3 : 2625****SS : N/A****MEETS THE FOLLOWING:**

- ASME A112.18.1
- CSA B125.1
- NSF 61, 372
- CALGreen
- ICC Approved

- 8-7/8" overall height.
- Stub-out connection 1/2" NPT.
- Articulated spout reach swings 22".
- 1.75 gpm maximum flow rate with aerated tip.
- 1/4 turn ceramic disk valve cartridge.
- Cold water hook up.
- Built-in check valve prevents dripping.
- Compatible with RO water and systems.
- Made from solid brass.



CONTEMPORARY WALL MOUNTED POTFILLER

MODEL: 3200

LIST PRICES:

GRP 1 :1869

GRP 2 :1962

GRP 3 : 2557

SS : 2626

- 8-1/4" overall height.
- Stub-out connection 1/2" NPT.
- Articulated spout reach swings 22".
- 1.75 gpm maximum flow rate with aerated tip.
- 1/4 turn ceramic disk valve cartridge.
- Cold water hook up.
- Built-in check valve prevents dripping.
- Compatible with RO water and systems.
- Made from solid brass or 316 stainless steel.



MEETS THE FOLLOWING:

- ASME A112.18.1
- CSA B125.1
- NSF 61, 372
- CALGreen
- ICC Approved

INDUSTRIAL WALL MOUNTED POTFILLER

MODEL: 3250

LIST PRICES:

GRP 1 : 1927

GRP 2 : 2023

GRP 3 : 2638

SS : 2708

- 8-1/4" overall height.
- Stub-out connection 1/2" NPT.
- Articulated spout reach swings 22".
- 1.75 gpm maximum flow rate with aerated tip.
- 1/4 turn ceramic disk valve cartridge.
- Cold water hook up.
- Built-in check valve prevents dripping.
- Compatible with RO water and systems.
- Made from solid brass or 316 stainless steel.



MEETS THE FOLLOWING:

- ASME A112.18.1
- CSA B125.1
- NSF 61, 372
- CALGreen
- ICC Approved

FINISH GROUP 1: CH
 FINISH GROUP 2: BLN, CD, CHB, CLZ, GR, MB, MW, PB, PN, SB, SC, SN, UPB
 FINISH GROUP 3: AB, ABZ, AC, AMB, AP, CB, DAB, DAC, DAMB, DAP, MAB, MAC, MAP, ORB, PC, TB

PRECIOUS METALS: PG, SG - 30% increase from Group 3*
 STAINLESS STEEL: SS *Pricing subject to change

TRADITIONAL COUNTER MOUNTED POTFILLER / LEVER HANDLE
MODEL: 3300

LIST PRICES:

GRP 1 : 1998

GRP 2 : 2097

GRP 3 : 2733

SS : N/A

MEETS THE FOLLOWING:

- ASME A112.18.1
- CSA B125.1
- NSF 61, 372
- CALGreen
- ICC Approved

- 21-3/8" overall height.
- Articulated spout reach swings 22".
- 1.75 gpm maximum flow rate with aerated tip.
- 1/4 turn ceramic disk valve cartridge.
- Mounts on counter right next to stove.
- Cold water hook up.
- Built-in check valve prevents dripping.
- Ergonomic single lever handle.
- Compatible with RO water and systems.
- Reinforced braided connection hose.
- 3/8 compression connection.
- Made from solid brass.



TRADITIONAL COUNTER MOUNTED POTFILLER / CROSS HANDLE
MODEL: 3350

LIST PRICES:

GRP 1 : 2128

GRP 2 : 2235

GRP 3 : 2912

SS : N/A

MEETS THE FOLLOWING:

- ASME A112.18.1
- CSA B125.1
- NSF 61, 372
- CALGreen
- ICC Approved

- 21-3/8" overall height.
- Articulated spout reach swings 22".
- 1.75 gpm maximum flow rate with aerated tip.
- 1/4 turn ceramic disk valve cartridge.
- Mounts on counter right next to stove.
- Cold water hook up.
- Built-in check valve prevents dripping.
- Ergonomic single cross handle.
- Compatible with RO water and systems.
- Reinforced braided connection hose.
- 3/8 compression connection.
- Made from solid brass.



CONTEMPORARY COUNTER MOUNTED POTFILLER
MODEL: 3400

LIST PRICES:

GRP 1: 1998

GRP 2: 2097

GRP 3: 2733

SS : 2807

MEETS THE FOLLOWING:

- ASME A112.18.1
- CSA B125.1
- NSF 61, 372
- CALGreen
- ICC Approved

- 20-3/8" overall height.
- Articulated spout reach swings 22".
- 1.75 gpm maximum flow rate with aerated tip.
- 1/4 turn ceramic disk valve cartridge.
- Mounts on counter right next to stove.
- Cold water hook up.
- Built-in check valve prevents dripping.
- Single lever handle.
- Compatible with reverse osmosis water and systems.
- Made from solid brass or 316 stainless steel.
- Reinforced braided connection hose.
- 3/8 compression connection.
- Made from solid brass or 316 stainless steel.



FINISH GROUP 1: CH
 FINISH GROUP 2: BLN, CD, CHB, CLZ, GR, MB, MW, PB, PN, SB, SC, SN, UPB
 FINISH GROUP 3: AB, ABZ, AC, AMB, AP, CB, DAB, DAC, DAMB, DAP, MAB, MAC, MAP, ORB, PC, TB

PRECIOUS METALS: PG, SG - 30% increase from Group 3*
 STAINLESS STEEL: SS *Pricing subject to change

ACCESSORIES



- 5500-3-SB
- 1200HC-SB



- 5600-CHB
- 1200HC-CHB

CONTEMPORARY SINGLE PORT AIR GAP

MODEL: 3020

LIST PRICES:

GRP 1: 285

GRP 2: 299

GRP 3: 389

SS : 400

- Made from solid brass or 316 stainless steel.
- Prevents dishwasher back flow and dirt buildup.
- Matches all contemporary Waterstone faucets.
- Cover hides upper nut and washer edges.



MEETS THE FOLLOWING:

- UPC

TRADITIONAL SINGLE PORT AIR GAP

MODEL: 4020

LIST PRICES:

GRP 1: 316

GRP 2: 331

GRP 3: 431

SS : N/A

- Prevents dishwasher back flow and dirt buildup.
- Matches all traditional Waterstone faucets.
- Cover hides upper nut and washer edges.
- Made from eco-friendly solid brass.
- Includes 2 accent button options.



MEETS THE FOLLOWING:

- UPC

INDUSTRIAL SINGLE PORT AIR GAP

MODEL: 9020

LIST PRICES:

GRP 1: 297

GRP 2: 312

GRP 3: 407

SS : 417

- Prevents dishwasher back flow and dirt buildup.
- Modern knurling design matches any Industrial PLP Pulldown Faucet.
- Cover hides upper nut and washer edges.
- Made from eco-friendly solid brass or 316 stainless steel.



MEETS THE FOLLOWING:

- UPC

FINISH GROUP 1: CH
 FINISH GROUP 2: BLN, CD, CHB, CLZ, GR, MB, MW, PB, PN, SB, SC, SN, UPB
 FINISH GROUP 3: AB, ABZ, AC, AMB, AP, CB, DAB, DAC, DAMB, DAP, MAB, MAC, MAP, ORB, PC, TB

PRECIOUS METALS: PG, SG - 30% increase from Group 3*
 STAINLESS STEEL: SS *Pricing subject to change

CONTEMPORARY DUAL PORT AIR GAP
MODEL: 3030

LIST PRICES:
GRP 1: 341
GRP 2: 358
GRP 3: 466
SS : 480

MEETS THE FOLLOWING:

- UPC

- Prevents dishwasher back flow and dirt buildup.
- Includes adapters for either a 2nd dishwasher or a reverse osmosis filtration port.
- Matches all contemporary Waterstone faucets.
- Cover hides upper nut and washer edges.
- Made from solid brass or 316 stainless steel.



TRADITIONAL DUAL PORT AIR GAP
MODEL: 4030

LIST PRICES:
GRP 1: 340
GRP 2: 357
GRP 3: 465
SS : N/A

MEETS THE FOLLOWING:

- UPC

- Prevents dishwasher back flow and dirt buildup.
- Includes adapters for either a 2nd dishwasher or a reverse osmosis filtration port.
- Matches all traditional Waterstone faucets.
- Cover hides upper nut and washer edges.
- Made from eco-friendly solid brass.
- Includes 2 accent button options.



INDUSTRIAL DUAL PORT AIR GAP
MODEL: 9030

LIST PRICES:
GRP 1: 363
GRP 2: 381
GRP 3: 497
SS : 509

MEETS THE FOLLOWING:

- UPC

- Prevents dishwasher back flow and dirt buildup.
- Includes adapters for either a 2nd dishwasher or a reverse osmosis filtration port.
- Modern knurling design matches any Industrial PLP Pulldown Faucet.
- Cover hides upper nut and washer edges.
- Made from solid brass or 316 stainless steel.



PRECIOUS METALS: PG, SG - 30% increase from Group 3*
 STAINLESS STEEL: SS

FINISH GROUP 1: CH
 FINISH GROUP 2: BLN, CD, CHB, CLZ, GR, MB, MW, PB, PN, SB, SC, SN, UPB
 FINISH GROUP 3: AB, ABZ, AC, AMB, AP, CB, DAB, DAC, DAMB, DAP, MAB, MAC, MAP, ORB, PC, TB

*Pricing subject to change

CONTEMPORARY AIR SWITCH
MODEL: 3010

LIST PRICES:
GRP 1: 449
GRP 2: 472
GRP 3: 615
SS : 632

MEETS THE FOLLOWING:

- UL (Connection box)
- CSA Enclosure Type 2
- ADA Compliant

- Air-activated garbage disposal switch.
- Convenient alternative to a wall switch.
- Great for kitchen sink, kitchen island or counter tops.
- Includes two-outlet control box and tubing.
- Isolated from electrical connections.
- Made from solid brass or 316 stainless steel.



- Connection Box**
- 4-1/4"H x 3"W x 2"D
 - 120v 15Amp 1Hp
 - 9-1/2' Tubing included

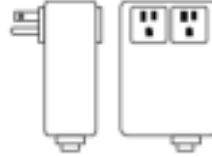

TRADITIONAL AIR SWITCH
MODEL: 4010

LIST PRICES:
GRP 1: 496
GRP 2: 522
GRP 3: 680
SS : N/A

MEETS THE FOLLOWING:

- UL (Connection box)
- CSA Enclosure Type 2
- ADA Compliant

- Air-activated garbage disposal switch.
- Convenient alternative to a wall switch.
- Great for kitchen sink, kitchen island or counter tops.
- Includes two-outlet control box and tubing.
- Isolated from electrical connections.
- Made from eco-friendly solid brass.
- Simplifies first time disposer installations.
- Easily replaceable air pump.
- Includes 2 accent button options.



- Connection Box**
- 4-1/4"H x 3"W x 2"D
 - 120v 15Amp 1Hp
 - 9-1/2' Tubing included

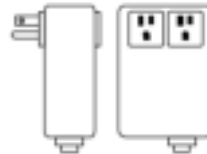

INDUSTRIAL AIR SWITCH
MODEL: 9010

LIST PRICES:
GRP 1: 453
GRP 2: 476
GRP 3: 620
SS : 636

MEETS THE FOLLOWING:

- UL (Connection box)
- CSA Enclosure Type 2
- ADA Compliant

- Air-activated garbage disposal switch.
- Convenient alternative to a wall switch.
- Great for kitchen sink, kitchen island or counter tops.
- Includes two-outlet control box and tubing.
- Isolated from electrical connections.
- Made from solid brass or 316 stainless steel.
- Simplifies first time disposer installations.
- Easily replaceable air pump.



- Connection Box**
- 4-1/4"H x 3"W x 2"D
 - 120v 15Amp 1Hp
 - 9-1/2' Tubing included

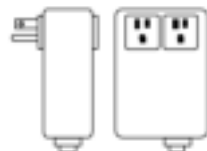

FINISH GROUP 1: CH
FINISH GROUP 2: BLN, CD, CHB, CLZ, GR, MB, MW, PB, PN, SB, SC, SN, UPB
FINISH GROUP 3: AB, ABZ, AC, AMB, AP, CB, DAB, DAC, DAMB, DAP, MAB, MAC, MAP, ORB, PC, TB

PRECIOUS METALS: PG, SG - 30% increase from Group 3*
STAINLESS STEEL: SS *Pricing subject to change

**TRADITIONAL SOAP/ LOTION DISPENSER / STRAIGHT SPOUT
MODEL: 4055**

LIST PRICES:
GRP 1 : 564
GRP 2 : 592
GRP 3 : 771
SS : N/A

MEETS THE FOLLOWING:

- ASME A112.18.1
- CSA B125.1
- NSF 61
- CALGreen

- Replaces unsightly soap bottles.
- Pump can be removed to refill soap from top of sink.
- Solid feel, smooth non-wobble pump action feel.
- Straight spout design is ideal for the Towson Suite.
- Anti-wick tip helps protect delicate patina finishes.
- Made from eco-friendly solid brass.
- 3-5/8" reach spout.
- High volume 2cc pump.
- 12 oz. capacity (approx).
- Includes 3 choices of accent buttons.



**TRADITIONAL SOAP/LOTION DISPENSER / EXTENDED STRAIGHT SPOUT
MODEL: 4055E**

LIST PRICES:
GRP 1 : 592
GRP 2 : 622
GRP 3 : 810
SS : N/A

MEETS THE FOLLOWING:

- ASME A112.18.1
- CSA B125.1
- NSF 61
- CALGreen

- Replaces unsightly soap bottles.
- Pump can be removed to refill soap from top of sink.
- Solid feel, smooth non-wobble pump action feel.
- Straight spout design is ideal for the Towson Suite.
- Anti-wick tip helps protect delicate patina finishes.
- Made from eco-friendly solid brass.
- 5" extended reach spout.
- High volume 2cc pump.
- 12 oz. capacity (approx).
- Includes 3 choices of accent buttons.



TRADITIONAL SOAP/LOTION DISPENSER / HOOK SPOUT**MODEL: 4060****LIST PRICES:****GRP 1 : 564****GRP 2 : 592****GRP 3 : 771****SS : N/A****MEETS THE FOLLOWING:**

- ASME A112.18.1
- CSA B125.1
- NSF 61
- CALGreen

- Replaces unsightly soap bottles.
- Pump can be removed to refill soap from top of sink.
- Solid feel, smooth non-wobble pump action feel.
- Hook spout design is ideal for all traditional faucets.
- Anti-wick tip helps protect delicate patina finishes.
- Made from eco-friendly solid brass.
- 4" reach spout.
- High volume 2cc pump.
- 12 oz. capacity (approx).
- Includes 3 choices of accent buttons.

**TRADITIONAL SOAP/LOTION DISPENSER / EXTENDED HOOK SPOUT****MODEL: 4060E****LIST PRICES:****GRP 1 : 592****GRP 2 : 622****GRP 3 : 810****SS : N/A****MEETS THE FOLLOWING:**

- ASME A112.18.1
- CSA B125.1
- NSF 61
- CALGreen

- Replaces unsightly soap bottles.
- Pump can be removed to refill soap from top of sink.
- Solid feel, smooth non-wobble pump action feel.
- Hook spout design is ideal for all traditional faucets.
- Anti-wick tip helps protect delicate patina finishes.
- Made from eco-friendly solid brass.
- 5" reach spout.
- High volume 2cc pump.
- 12 oz. capacity (approx).
- Includes 3 choices of accent buttons.



CONTEMPORARY SOAP/LOTION DISPENSER

MODEL: 4065

LIST PRICES:

GRP 1 : 477

GRP 2 : 501

GRP 3 : 653

SS : 670

MEETS THE FOLLOWING:

- ASME A112.18.1
- CSA B125.1
- NSF 61
- CALGreen

- Replaces unsightly soap bottles.
- Pump can be removed to refill soap from top of sink.
- Solid feel, smooth non-wobble pump action feel.
- Straight spout design is ideal for all contemporary faucets.
- Anti-wick tip helps protect delicate patina finishes.
- 3" reach spout.
- High volume 2cc pump.
- Made from eco-friendly solid brass or 316 stainless steel.
- 12 oz. capacity (approx).



CONTEMPORARY SOAP/LOTION DISPENSER / EXTENDED SPOUT

MODEL: 4065E

LIST PRICES:

GRP 1 : 501

GRP 2 : 526

GRP 3 : 686

SS : 704

MEETS THE FOLLOWING:

- ASME A112.18.1
- CSA B125.1
- NSF 61
- CALGreen

- Replaces unsightly soap bottles.
- Pump can be removed to refill soap from top of sink.
- Solid feel, smooth non-wobble pump action feel.
- Straight spout design is ideal for all contemporary faucets.
- Anti-wick tip helps protect delicate patina finishes.
- 5" reach spout.
- High volume 2cc pump.
- Made from eco-friendly solid brass or 316 stainless steel.
- 12 oz. capacity (approx).



INDUSTRIAL SOAP/ LOTION DISPENSER**MODEL: 9065****LIST PRICES:****GRP 1 : 480****GRP 2 : 505****GRP 3 : 658****SS : 675****MEETS THE FOLLOWING:**

- ASME A112.18.1
- CSA B125.1
- NSF 61
- CALGreen

- Modern knurling design matches any Industrial PLP Pulldown Faucet.
- Replaces unsightly soap bottles.
- Pump can be removed to refill soap from top of sink.
- Removable head for easy internal cleaning.
- Solid feel, smooth non-wobble pump action feel.
- Anti-wick tip helps protect delicate patina finishes.
- 3" reach spout.
- High volume 2cc pump.
- Made from eco-friendly solid brass or 316 stainless steel.
- 12 oz. capacity (approx).

**INDUSTRIAL SOAP / LOTION DISPENSER / EXTENDED SPOUT****MODEL: 9065E****LIST PRICES:****GRP 1 : 504****GRP 2 : 530****GRP 3 : 691****SS : 709****MEETS THE FOLLOWING:**

- ASME A112.18.1
- CSA B125.1
- NSF 61
- CALGreen

- Modern knurling design matches any Industrial PLP Pulldown Faucet.
- Replaces unsightly soap bottles.
- Pump can be removed to refill soap from top of sink.
- Removable head for easy internal cleaning.
- Solid feel, smooth non-wobble pump action feel.
- Anti-wick tip helps protect delicate patina finishes.
- 5" reach spout.
- High volume 2cc pump.
- Made from eco-friendly solid brass or 316 stainless steel.
- 12 oz. capacity (approx).



CONTEMPORARY SIDE SPRAY

MODEL: 3025

LIST PRICES:

GRP 1 : 717
GRP 2 : 753
GRP 3 : 982
SS : 1008

MEETS THE FOLLOWING:

- ASME A112.18.1
- CSA B125.1
- NSF 61
- CALGreen

- Works with all Waterstone contemporary Kitchen, Bridge and Prep Faucets.
- Ergonomic and fully insulated handle.
- Reaches every corner of the sink.
- No drip spray nozzle head.
- Large spray pattern.
- Includes mounting base
- PTFE bump guard.
- Made from solid brass or 316 stainless steel.
- 48" nylon reinforced connection hose.



TRADITIONAL SIDE SPRAY

MODEL: 4025

LIST PRICES:

GRP 1: 717
GRP 2: 753
GRP 3: 982
SS : N/A

MEETS THE FOLLOWING:

- ASME A112.18.1
- CSA B125.1
- NSF 61
- CALGreen

- Works with all Waterstone traditional Kitchen, Bridge and Prep Faucets.
- Ergonomic and fully insulated handle.
- Reaches every corner of the sink.
- No drip spray nozzle head.
- Large spray pattern.
- Made from eco-friendly solid brass.
- Includes mounting base
- PTFE bump guard.
- 48" nylon reinforced connection hose.



CONTEMPORARY HOLE COVER**MODEL: 3080****LIST PRICES:****GRP 1 : 140****GRP 2 : 147****GRP 3 : 193****SS : 196**

- Perfect for 2-holed Bridge Faucets.
- Mounting hardware included for easy installation.
- Matches all contemporary Waterstone faucet Suites.
- 2-1/8" diameter covers standard size sink holes.
- Made from solid brass or 316 stainless steel.

MEETS THE FOLLOWING:

- CALGreen

**TRADITIONAL HOLE COVER / COMPASS BUTTON****MODEL: 4070****LIST PRICES:****GRP 1 : 124****GRP 2 : 129****GRP 3 : 168****SS : N/A**

- Perfect for 2-holed Bridge Faucets.
- Mounting hardware included for easy installation.
- Solid brass construction.
- Matches all traditional Waterstone faucet Suites.
- Stylish compass logo button.
- 2-1/8" diameter covers standard size sink holes.

MEETS THE FOLLOWING:

- CALGreen

**TRADITIONAL HOLE COVER / FINISH BUTTON****MODEL: 4080****LIST PRICES:****GRP 1 : 129****GRP 2 : 136****GRP 3 : 178****SS : N/A**

- Perfect for 2-holed Bridge Faucets.
- Mounting hardware included for easy installation.
- Solid brass construction.
- Matches all traditional Waterstone faucet Suites.
- 2-1/8" diameter covers standard size sink holes.

MEETS THE FOLLOWING:

- CALGreen



FINISH GROUP 1: CH
 FINISH GROUP 2: BLN, CD, CHB, CLZ, GR, MB, MW, PB, PN, SB, SC, SN, UPB
 FINISH GROUP 3: AB, ABZ, AC, AMB, AP, CB, DAB, DAC, DAMB, DAP, MAB, MAC, MAP, ORB, PC, TB

PRECIOUS METALS: PG, SG - 30% increase from Group 3*
 STAINLESS STEEL: SS *Pricing subject to change

CONTEMPORARY 6" ESCUTCHEON PLATE

MODEL: 3783

LIST PRICES:

GRP 1 : 274

GRP 2 : 288

GRP 3 : 375

SS : 385

MEETS THE FOLLOWING:

- CALGreen

- Works with all contemporary Waterstone PLP, Gantry, Kitchen and Prep Faucets.
- Machine tapered top won't pool water.
- 6" base plate for concealing extra faucet holes.
- Made from a 3/8" thick solid brass or stainless steel plate.
- Plate will accept 1-3/8" or 1-1/4" mounting shanks.



CONTEMPORARY 10" ESCUTCHEON PLATE

MODEL: 3784

LIST PRICES:

GRP 1 : 330

GRP 2 : 346

GRP 3 : 450

SS : 463

MEETS THE FOLLOWING:

- CALGreen

- Works with all contemporary Waterstone PLP, Gantry, Kitchen and Prep Faucets.
- Machine tapered top won't pool water.
- 10" base plate for concealing extra faucet holes.
- Made from a 3/8" thick solid brass or stainless steel plate.
- Plate will accept 1-3/8" or 1-1/4" mounting shanks.



TRADITIONAL 6" ESCUTCHEON PLATE**MODEL: 4783****LIST PRICES:****GRP 1 : 293****GRP 2 : 308****GRP 3 : 401****SS : N/A****MEETS THE FOLLOWING:**

- CALGreen

- Works with all traditional Waterstone PLP, Gantry, Kitchen and Prep Faucets.
- Machine tapered top won't pool water.
- 6" base plate for concealing extra faucet holes.
- Made from a 3/8" thick solid brass plate.
- Plate will accept 1-3/8" or 1-1/4" mounting shanks.

**TRADITIONAL 10" ESCUTCHEON PLATE****MODEL: 4784****LIST PRICES:****GRP 1 : 361****GRP 2 : 378****GRP 3 : 493****SS : N/A****MEETS THE FOLLOWING:**

- CALGreen

- Works with all traditional Waterstone PLP, Gantry, Kitchen and Prep Faucets.
- Machine tapered top won't pool water.
- 10" base plate for concealing extra faucet holes.
- Made from a 3/8" thick solid brass plate.
- Plate will accept 1-3/8" or 1-1/4" mounting shanks.



**ULTIMATE UNDER SINK SYSTEM
MODEL: 1000**

**LIST PRICE:
1225**

- Great tasting water with the security of leak detection in one package.
- Includes a Waterstone Hot Tank, Multi-Stage Filtration System and a Safety Valve Leak Detector.



**INSTA-HOT UNDER SINK SYSTEM
MODEL: 2000**

**LIST PRICE:
814**

- Instant hot water and leak detector in one package.
- Hot Tank dispenses hot water instantly.
- Includes Hot Tank, PRV (pressure regulator valve) and a Safety Valve Leak Detector.
- Leak Detector shuts off when moisture is detected.
- Compatible with reverse osmosis water and systems.
- Easy to install.
- Connection fittings included.
- The Hot Tank carries a 2 year warranty.



**FILTRATION UNDER SINK SYSTEM
MODEL: 3000**

**LIST PRICE:
601**

- Great tasting, filtered water on demand.
- Removes sediment, chlorine, bad taste and odor from municipal drinking water.
- Includes a Waterstone Multi-Stage Filtration System and a Safety Valve Leak Detector.
- Leak Detector shuts off when moisture is detected.
- Compatible with reverse osmosis water and systems.
- Connection fittings included.
- Easy to install.



HOT TANK MODEL: 5000

**LIST PRICE:
684**

MEETS THE FOLLOWING:

- UL
- CSA

- Dimensions- 11-1/4"H x 6-3/4" W x 8-1/4" D.
- Adjustable temperature 140F to 190F (60C to 88C).
- Heating element - 1300 watts, 10.8 amps, 120 volts, 60 Hz.
- Inlet water pressure, 35 psi min, to 60 psi max.
- Minimum inlet volume (filter output), 1 gal/min.
- Instant hot water on demand. Perfect for hot coffee, tea, hot chocolate or soup.
- Up to 60 cups per hour capacity.
- Integrated vent, works with any Waterstone Hot Only or Hot and Cold filtration faucet.
- Insulated 1/2 gal. stainless steel tank.
- Compatible with reverse osmosis water and systems.
- Includes Pressure Regulator Valve (PRV).
- 2 year manufacturer warranty



DIGITAL HOT TANK MODEL: 7000

**LIST PRICE:
725**

MEETS THE FOLLOWING:

- UL
- CSA

- Dimensions: 8"L x 8"W x 12-1/4"H.
- Precision temperature adjustment from 167F to 208F (75C to 98C).
- Heating element: 1500 watts, 120 volts.
- 3/8" inlet and outlet connections.
- Instant hot water on demand.
- Digital interface and temperature control.
- Insulated 1/2 gallon 304 stainless steel tank.
- Built-in inline Pressure Regulator Valve protects lifespan of internal parts.
- ABS plastic housing for lighter overall weight.
- Non-pressurized bladder system.
- Dry burn and over heat protection sensors.
- Auto shut off if low water or no water present.
- Sound insulation and rubber feet for noise reduction.
- Compatible with RO filtration systems.
- 2 year manufacturer warranty.



PRESSURE REGULATOR VALVE (PRV): MODEL: 4500

**LIST PRICE:
161**

MEETS THE FOLLOWING:

- NSF

- 1/4" compression connections.
- Regulates water pressure to 60 psi maximum.
- Flows up to 4 gpm @ 100 psi.
- Required for all 5000 Hot Tank installations.
- Made from solid brass.



SAFETY VALVE LEAK DETECTOR MODEL: AS-414-SS

LIST PRICE:
209

MEETS THE FOLLOWING:

- ASME A112.18.1
- CSA B125.1

- Has both 1/4" and 3/8" quick connect fittings included.
- Automatically shuts off water when moisture is detected.
- Audio alarm alerts when leak occurs.
- Colored LED indicators.
- Quick connect for easy installation.
- User friendly product design with one button reset.
- Use with Waterstone Hot Tank and/or Multi-Stage Filtration unit.



MULTI-STAGE FILTRATION UNIT MODEL: 30101

LIST PRICE:
457

MEETS THE FOLLOWING:

- NSF

- Dimensions: 7" W x 6-1/4" D x 15-1/2" H.
- Unit Weight: 4.75 lbs.
- Intake water pressure range: 40 psi to 100 psi max.
- Intake water temp. range: 32F to 120F max.
- 1000 gallon capacity filtration system.
- Single cartridge multi-stage filter.
- 1st Stage Filter - 20 Microns
- 2nd Stage Filter - 5 Microns
- 3rd Stage Filter - GAC
- For municipal potable water use only.
- Includes attachment tubing.
- Made to work with AS-414 Safety Valve Leak Detector.
- Manufactured by Nimbus Inc, and distributed by Waterstone Faucets.
- Manufacturer provided 1 year warranty.



FILTRATION REPLACEMENT CARTRIDGES MODELS: 30102, 30102-2

LIST PRICES:
SINGLE: 159
2 PACK: 246

MEETS THE FOLLOWING:

- NSF

- Single or dual pack replacement cartridge for #30101 Multi-Stage Filtration Unit.
- 1000 gallon capacity cartridge filtration system.





HARDWARE

TRADITIONAL, INDUSTRIAL, CONTEMPORARY

Enhance your living space with our exquisite hardware, perfectly complementing our industry-leading kitchen and bath faucets in both design and quality. Now, you can indulge in the perfect fusion of elegance and functionality at incredible price reductions on most models. Experience the tailored sophistication that elevates your home to new heights. Explore an impressive assortment of 33 captivating finishes, featuring our latest addition, the alluring Chardonnay finish, meticulously crafted to infuse sophistication into any decor. With our innovative split finish options, allow yourself to make a distinct statement that embodies your unique style.



- HCK-101-CH
- HCP-0600-UPB
- HMP-0800-MB/SN



- HIK-200-CH



- HTK-002-AP
- HTK-006-CLZ
- HTP-2400-SN/CLZ

SPLIT FINISHES

HOW TO DESIGNATE SPLIT FINISH HARDWARE WHEN ORDERING

Take the model number and add both finishes to the suffix starting with the Primary finish followed by the Accent finish. For Matte Black (MB) and POLISHED NICKEL (PN), it would be HIP-0400-MB/PN. If you wanted Classic Bronze (CLZ) and Polished Nickel (PN) it would be HIP-0400-CLZ/PN. For all split finish designs click “Split Finishes” in the top menu of our home page at www.waterstonco.com

Hardware can be split using any combination of the standard finishes. For pricing add 10% to the higher list price of the 2 finishes.

For custom split finish add 40% to Group 3 pricing.



HARDWARE

White = Primary finish
 Gray = Accent finish

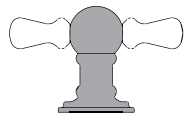

HTK-006

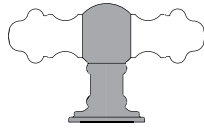

HTK-007

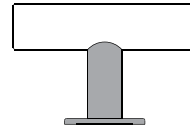

HCK-103
HMK-103

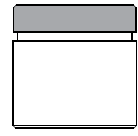

HIK-201
HIK-202

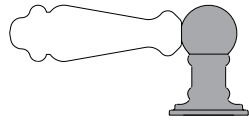

HTK-005

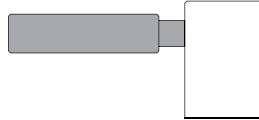

HCK-102
HMK-102

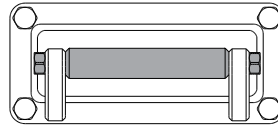

HIP-200
HIP-300
HIP-400

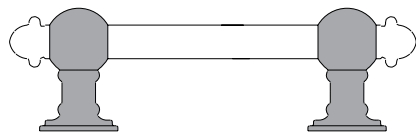

HTP-0300
HTP-0350
HTP-0400
HTP-0500
HTP-0600
HTP-0800
HTP-1200
HTP-1201

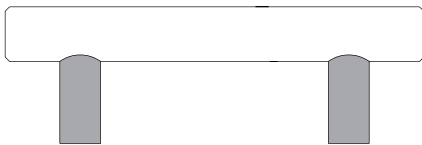

HCP-0300
HCP-0350
HCP-0400
HCP-0500
HCP-0600
HCP-0800
HCP-1200

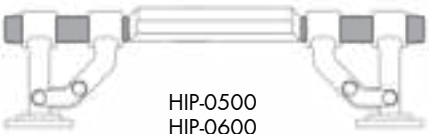

HIP-0500
HIP-0600
HIP-0800
HIP-1200

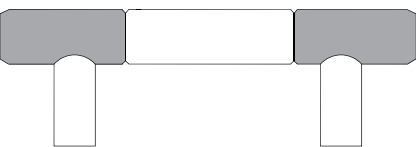

HMP-0300
HMP-0350
HMP-0400
HMP-0500
HMP-0600
HMP-0800
HMP-1200

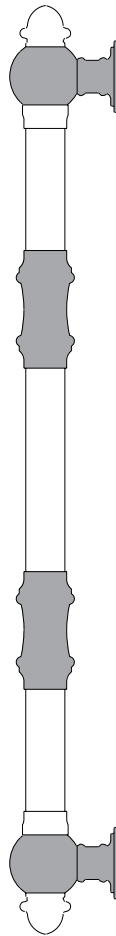

HTP-1800
HTP-2400
HTP-3000



HCP-1201
HCP-1800
HCP-2400
HCP-3000



HIP-1201
HIP-1800
HIP-2400
HIP-3000



HMP-1201
HMP-1800
HMP-2400
HMP-3000

CABINET KNOBS



• HIK-200-CD



TRADITIONAL SMALL PLAIN KNOB**MODEL: HTK-001****LIST PRICES:****GRP 1 : 46****GRP 2 : 51****GRP 3 : 80****SS : N/A**

- 1-1/8" wide plain design.
- Matches all Waterstone Traditional Faucets.
- Made from solid brass.
- Includes mounting hardware.
- Fits materials from 1/4" to 1-1/2" thick.

**TRADITIONAL LARGE PLAIN KNOB****MODEL: HTK-002****LIST PRICES:****GRP 1 : 48****GRP 2 : 53****GRP 3 : 82****SS : N/A**

- 1-1/2" wide plain design.
- Matches all Waterstone Traditional Faucets.
- Made from solid brass.
- Includes mounting hardware.
- Fits materials from 1/4" to 1-1/2" thick.

**TRADITIONAL SMALL DECORATIVE KNOB****MODEL: HTK-003****LIST PRICES:****GRP 1 : 52****GRP 2 : 57****GRP 3 : 85****SS : N/A**

- 1-1/8" wide decorative design.
- Matches all Waterstone Traditional Faucets.
- Made from solid brass.
- Includes mounting hardware.
- Fits materials from 1/4" to 1-1/2" thick.

**TRADITIONAL LARGE DECORATIVE KNOB****MODEL: HTK-004****LIST PRICES:****GRP 1 : 53****GRP 2 : 58****GRP 3 : 87****SS : N/A**

- 1-1/2" wide decorative design.
- Matches all Waterstone Traditional Faucets.
- Made from solid brass.
- Includes mounting hardware.
- Fits materials from 1/4" to 1-1/2" thick.



FINISH GROUP 1: CH
 FINISH GROUP 2: BLN, CD, CHB, CLZ, GR, MB, MW, PB, PN, SB, SC, SN, UPB
 FINISH GROUP 3: AB, ABZ, AC, AMB, AP, CB, DAB, DAC, DAMB, DAP, MAB, MAC, MAP, ORB, PC, TB

PRECIOUS METALS: PG, SG - 30% increase from Group 3*
 STAINLESS STEEL: SS *Pricing subject to change

TRADITIONAL POST PULL

MODEL: HTK-005

LIST PRICES:

GRP 1 : 54
GRP 2 : 59
GRP 3 : 115
SS : N/A

- 2-1/4" wide decorative design.
- Matches all Waterstone Traditional Faucets.
- Made from solid brass.
- Includes mounting hardware.
- Fits materials from 1/4" to 1-1/2" thick.



TRADITIONAL SMALL T-PULL

MODEL: HTK-006

LIST PRICES:

GRP 1 : 56
GRP 2 : 61
GRP 3 : 135
SS : N/A

- 2" wide decorative design.
- Matches all Waterstone Traditional Faucets.
- Made from solid brass.
- Includes mounting hardware.
- Fits materials from 1/4" to 1-1/2" thick.



TRADITIONAL LARGE T-PULL

MODEL: HTK-007

LIST PRICES:

GRP 1 : 57
GRP 2 : 64
GRP 3 : 149
SS : N/A

- 2-3/8" wide decorative design.
- Matches all Waterstone Traditional Faucets.
- Made from solid brass.
- Includes mounting hardware.
- Fits materials from 1/4" to 1-1/2" thick.



CONTEMPORARY SMALL KNOB

MODEL: HCK-100

LIST PRICES:

GRP 1 : 12
GRP 2 : 16
GRP 3 : 23
SS : 27

- 3/4" wide plain design.
- Matches all Waterstone Contemporary and Modern Faucets.
- Made from solid brass or 316 stainless steel.
- Includes mounting hardware.
- Fits materials from 1/4" to 1-1/2" thick.



FINISH GROUP 1: CH
 FINISH GROUP 2: BLN, CD, CHB, CLZ, GR, MB, MW, PB, PN, SB, SC, SN, UPB
 FINISH GROUP 3: AB, ABZ, AC, AMB, AP, CB, DAB, DAC, DAMB, DAP, MAB, MAC, MAP, ORB, PC, TB

PRECIOUS METALS: PG, SG - 30% increase from Group 3*
 STAINLESS STEEL: SS *Pricing subject to change

CONTEMPORARY LARGE KNOB MODEL: HCK-101

LIST PRICES:

GRP 1 : 24
GRP 2 : 28
GRP 3 : 42
SS : 62

- 1-1/8" wide plain design.
- Matches all Waterstone Contemporary and Modern Faucets.
- Made from solid brass or 316 stainless steel.
- Includes mounting hardware.
- Fits materials from 1/4" to 1-1/2" thick.



CONTEMPORARY POST PULL MODEL: HCK-102

LIST PRICES:

GRP 1 : 24
GRP 2 : 28
GRP 3 : 39
SS : 62

- 2" wide plain design.
- Made from solid brass or 316 stainless steel.
- Includes mounting hardware.
- Fits materials from 1/4" to 1-1/2" thick.



CONTEMPORARY T-PULL MODEL: HCK-103

LIST PRICES:

GRP 1 : 28
GRP 2 : 32
GRP 3 : 44
SS : 53

- 2" wide plain design.
- Made from solid brass or 316 stainless steel.
- Includes mounting hardware.
- Fits materials from 1/4" to 1-1/2" thick.



INDUSTRIAL 3 SPOKE KNOB MODEL: HIK-200

LIST PRICES:

GRP 1 : 77
GRP 2 : 97
GRP 3 : 106
SS : N/A

- 1-1/2" wide 3 spoke, knurled design.
- Made from solid brass.
- Includes mounting hardware.
- Fits materials from 1/4" to 1-1/2" thick.



FINISH GROUP 1: CH
FINISH GROUP 2: BLN, CD, CHB, CLZ, GR, MB, MW, PB, PN, SB, SC, SN, UPB
FINISH GROUP 3: AB, ABZ, AC, AMB, AP, CB, DAB, DAC, DAMB, DAP, MAB, MAC, MAP, ORB, PC, TB

PRECIOUS METALS: PG, SG - 30% increase from Group 3*
STAINLESS STEEL: SS *Pricing subject to change

INDUSTRIAL SMALL KNURLED KNOB
MODEL: HIK-201

LIST PRICES:

GRP 1 : 20
GRP 2 : 28
GRP 3 : 67
SS : N/A

- 3/4" wide knurled design.
- Designed with intricate diamond knurling.
- Made from solid brass.
- Includes mounting hardware.
- Fits materials from 1/4" to 1-1/2" thick.



INDUSTRIAL LARGE KNURLED KNOB
MODEL: HIK-202

LIST PRICES:

GRP 1 : 32
GRP 2 : 40
GRP 3 : 99
SS : N/A

- 1-1/8" wide knurled design.
- Designed with intricate diamond knurling.
- Made from solid brass.
- Includes mounting hardware.
- Fits materials from 1/4" to 1-1/2" thick.



MODERN INDUSTRIAL POST PULL
MODEL: HMK-102

LIST PRICES:

GRP 1 : 38
GRP 2 : 42
GRP 3 : 110
SS : N/A

- 2-1/4" wide industrial design.
- Designed with intricate diamond knurling.
- Matches all Waterstone Industrial Faucets.
- Made from solid brass.
- Includes mounting hardware.
- Fits materials from 1/4" to 1-1/2" thick.



MODERN INDUSTRIAL T-PULL
MODEL: HMK-103

LIST PRICES:

GRP 1 : 45
GRP 2 : 54
GRP 3 : 118
SS : N/A

- 2" wide industrial design.
- Designed with intricate diamond knurling.
- Made from solid brass.
- Includes mounting hardware.
- Fits materials from 1/4" to 1-1/2" thick.



FINISH GROUP 1: CH
 FINISH GROUP 2: BLN, CD, CHB, CLZ, GR, MB, MW, PB, PN, SB, SC, SN, UPB
 FINISH GROUP 3: AB, ABZ, AC, AMB, AP, CB, DAB, DAC, DAMB, DAP, MAB, MAC, MAP, ORB, PC, TB

PRECIOUS METALS: PG, SG - 30% increase from Group 3*
 STAINLESS STEEL: SS *Pricing subject to change

CABINET PULLS



• HCP-0800-CD



• HIP-0800-MB/CLZ



• HIP-0800-MB/CLZ

TRADITIONAL CABINET PULLS

LIST PRICES:

Model:	Size:	GP1	GP2	GP3	SS
HTP-0300	3"	90	104	265	N/A
HTP-0350	3.5"	91	108	275	N/A
HTP-0400	4"	93	111	282	N/A
HTP-0500	5"	96	115	288	N/A
HTP-0600	6"	98	117	290	N/A
HTP-0800	8"	102	123	292	N/A

- Choice of 3", 3.5", 4", 5", 6" and 8" center to center.
- Matches all Waterstone Traditional Faucets.
- Made with solid brass.
- Includes mounting hardware.
- Fits materials from 1/4" to 1-1/2" thick.
- Available in 33 finishes and split finishes.



CONTEMPORARY CABINET PULLS

LIST PRICES

Model:	Size:	GP1	GP2	GP3	SS
HCP-0300	3"	75	99	155	205
HCP-0350	3.5"	78	103	160	210
HCP-0400	4"	79	105	169	215
HCP-0500	5"	82	106	175	220
HCP-0600	6"	85	108	179	225
HCP-0800	8"	89	115	180	230

- Choice of 3", 3.5", 4", 5", 6" and 8" center to center.
- Matches all Waterstone Contemporary and Modern Faucets.
- Made with solid brass or 316 stainless steel.
- Includes mounting hardware.
- Fits materials from 1/4" to 1-1/2" thick.
- Available in 33 finishes, solid stainless steel and split finishes.



INDUSTRIAL HANDLE PULLS

LIST PRICES

Model:	Size:	GP1	GP2	GP3	SS
HIP-0500	5"	299	346	504	N/A
HIP-0600	6"	323	376	524	N/A
HIP-0800	8"	352	408	546	N/A

- Choice of 5", 6" or 8" center to center.
- Designed with intricate diamond knurling.
- Matches all Waterstone Industrial Faucets.
- Fits materials from 1/4" to 1-1/2" thick.
- Made with solid brass.
- Includes mounting hardware.



FINISH GROUP 1: CH
 FINISH GROUP 2: BLN, CD, CHB, CLZ, GR, MB, MW, PB, PN, SB, SC, SN, UPB
 FINISH GROUP 3: AB, ABZ, AC, AMB, AP, CB, DAB, DAC, DAMB, DAP, MAB, MAC, MAP, ORB, PC, TB

PRECIOUS METALS: PG, SG - 30% increase from Group 3*
 STAINLESS STEEL: SS

MODERN INDUSTRIAL CABINET PULLS

LIST PRICES

Model:	Size:	GP1	GP2	GP3	SS
HMP-0300	3"	105	132	269	N/A
HMP-0350	3.5"	108	141	272	N/A
HMP-0400	4"	114	149	278	N/A
HMP-0500	5"	123	158	285	N/A
HMP-0600	6"	126	167	288	N/A
HMP-0800	8"	135	175	292	N/A

- Choice of 3", 3.5", 4", 5", 6" and 8" center to center.
- Designed with intricate diamond knurling.
- Matches all Waterstone Industrial Faucets.
- Made with solid brass.
- Includes mounting hardware.
- Fits materials from 1/4" to 1-1/2" thick.



INDUSTRIAL BIN PULLS

LIST PRICES

Model:	Size:	GP1	GP2	GP3	SS
HIP-0200	2"	274	317	498	N/A
HIP-0300	3"	322	385	525	N/A
HIP-0400	4"	374	463	552	N/A

- Choice of 2", 3" and 4" bin pulls.
- Designed with intricate diamond knurling.
- Matches all Waterstone Industrial Faucets.
- Made with solid brass.
- Includes mounting hardware.
- Fits materials from 1/4" to 1-1/2" thick.



TRADITIONAL 12" HEAVY DUTY DRAWER PULL

MODEL: HTP-1200

LIST PRICES:

GRP 1 : 105
GRP 2 : 129
GRP 3 : 296
SS : N/A

- 12" center to center.
- Made from solid brass.
- Includes mounting hardware.
- Fits materials from 1/4" to 1-1/2" thick.



FINISH GROUP 1: CH
 FINISH GROUP 2: BLN, CD, CHB, CLZ, GR, MB, MW, PB, PN, SB, SC, SN, UPB
 FINISH GROUP 3: AB, ABZ, AC, AMB, AP, CB, DAB, DAC, DAMB, DAP, MAB, MAC, MAP, ORB, PC, TB

PRECIOUS METALS: PG, SG - 30% increase from Group 3*
 STAINLESS STEEL: SS *Pricing subject to change

CONTEMPORARY 12" HEAVY DUTY DRAWER PULL**MODEL: HCP-1200****LIST PRICES:****GRP 1 : 120****GRP 2 : 163****GRP 3 : 199****SS : 240**

- 12" center to center.
- Made from solid brass or 316 stainless steel.
- Includes mounting hardware.
- Fits materials from 1/4" to 1-1/2" thick.

**INDUSTRIAL 12" HEAVY DUTY DRAWER PULL****MODEL: HIP-1200****LIST PRICES:****GRP 1 : 388****GRP 2 : 488****GRP 3 : 585****SS : N/A**

- 12" center to center.
- Designed with diamond knurling pattern.
- Made from solid brass.
- Includes mounting hardware.
- Fits materials from 1/4" to 1-1/2" thick.

**MODERN INDUSTRIAL 12" HEAVY DUTY DRAWER PULL****MODEL: HMP-1200****LIST PRICES:****GRP 1 : 165****GRP 2 : 205****GRP 3 : 299****SS : N/A**

- Ideal for heavy cabinet drawers or dishwashers.
- 12" center to center.
- Matches all Waterstone Industrial Faucets.
- Made from solid brass.
- Fits materials from 1/4" to 1-1/2" thick.
- Includes mounting hardware.



APPLIANCE & DOOR PULLS



• HCP-0800-CD



• HIP-3000-MB/CLZ

TRADITIONAL 12", 18", 24" AND 30" APPLIANCE / DOOR PULLS

LIST PRICES

Model:	Size:	GP1	GP2	GP3	SS
HTP-1201	12"	275	280	425	N/A
HTP-1800	18"	428	506	698	N/A
HTP-2400	24"	482	565	789	N/A
HTP-3000	30"	598	699	855	N/A

- Choice of 12", 18", 24" or 30" center to center.
- Made from solid brass.
- Includes mounting hardware.
- Fits materials from 1/4" to 1-1/2" thick.



CONTEMPORARY 12", 18", 24" AND 30" APPLIANCE / DOOR PULLS

LIST PRICES

Model:	Size:	GP1	GP2	GP3	SS
HCP-1201	12"	225	295	315	399
HCP-1800	18"	290	325	330	465
HCP-2400	24"	312	396	402	499
HCP-3000	30"	365	465	535	599

- Choice of 12", 18", 24" or 30" center to center.
- Minimal style is ideal for modern kitchens.
- Made from brass or 316 stainless steel.
- Includes mounting hardware.
- Fits materials from 1/4" to 1-1/2" thick.



INDUSTRIAL 12", 18", 24" AND 30" APPLIANCE / DOOR PULLS

LIST PRICES

Model:	Size:	GP1	GP2	GP3	SS
HIP-1201	12"	436	517	772	N/A
HIP-1800	18"	493	586	886	N/A
HIP-2400	24"	687	792	1055	N/A
HIP-3000	30"	780	893	1181	N/A

- Choice of 12", 18", 24" or 30" center to center.
- 24" and 30" feature heavy duty 1" thick handles.
- Made from solid brass.
- Includes mounting hardware.
- Fits materials from 1/4" to 1-1/2" thick.



FINISH GROUP 1: CH
 FINISH GROUP 2: BLN, CD, CHB, CLZ, GR, MB, MW, PB, PN, SB, SC, SN, UPB
 FINISH GROUP 3: AB, ABZ, AC, AMB, AP, CB, DAB, DAC, DAMB, DAP, MAB, MAC, MAP, ORB, PC, TB

PRECIOUS METALS: PG, SG - 30% increase from Group 3*
 STAINLESS STEEL: SS *Pricing subject to change

MODERN INDUSTRIAL 12", 18", 24" AND 30" APPLIANCE / DOOR PULLS

LIST PRICES

Model:	Size:	GP1	GP2	GP3	SS
HMP-1201	12"	365	425	475	N/A
HMP-1800	18"	405	515	525	N/A
HMP-2400	24"	475	595	625	N/A
HMP-3000	30"	528	647	710	N/A

- Choice of 12", 18", 24" or 30" center to center.
- Designed with intricate diamond knurling.
- Made from solid brass.
- Includes mounting hardware.
- Fits materials from 1/4" to 1-1/2" thick.



HARDWARE

MODERN INDUSTRIAL 12" AND 18" DOOR PULLS / 2 PULLS BACK TO BACK

LIST PRICES

Model:	Size:	GP1	GP2	GP3	SS
HMP-1201B	12"	785	905	1005	N/A
HMP-1800B	18"	865	1085	1105	N/A

- 2 piece, back to back door pull set.
- Adds a modern touch to glass or wooden doors.
- 12" or 18" center to center.
- Matches all Waterstone Industrial Faucets and hardware.
- Made from brass.
- Includes mounting hardware with break to length screws.
- Fits doors from 1/4" to 2-3/4" thick.



MODERN INDUSTRIAL 24" AND 30" DOOR PULLS / 2 PULLS BACK TO BACK

LIST PRICES

Model:	Size:	GP1	GP2	GP3	SS
HMP-2400B	24"	1005	1245	1305	N/A
HMP-3000B	30"	1111	1349	1475	N/A

- 2 piece, back to back door pull set.
- Adds a modern touch to glass or wooden doors.
- 24" or 30" center to center.
- Matches all Waterstone Industrial Faucets and hardware.
- Made from brass.
- Includes mounting hardware with break to length screws.
- Fits doors from 1/4" to 2-3/4" thick.



FINISH GROUP 1: CH
 FINISH GROUP 2: BLN, CD, CHB, CLZ, GR, MB, MW, PB, PN, SB, SC, SN, UPB
 FINISH GROUP 3: AB, ABZ, AC, AMB, AP, CB, DAB, DAC, DAMB, DAP, MAB, MAC, MAP, ORB, PC, TB

PRECIOUS METALS: PG, SG - 30% increase from Group 3*
 STAINLESS STEEL: SS *Pricing subject to change



BATH

Waterstone has excelled in the luxury kitchen faucet industry for over 20 years. Our commitment to innovation and developing superior quality, high-end faucet products is unprecedented. We now bring that innovative spirit and begin our voyage into the bathroom. We are proud to introduce the latest blend of art and technology - The Argonaut Bath Suite. A collection of bath products that cater to a niche of homeowners who seek the spirit of adventure.



AG245-1-PN

ARGONAUT



• AG201-1-PN



SPLIT FINISHES

Waterstone Designed STANDARD Split Finishes

Faucet can be split using any combination of the standard finishes listed below. For pricing add 10% to the higher list price of the 2 finishes.

- Chrome - CH
- Chardonnay - CD
- Matte Black - MB
- Polished Nickel - PN
- Satin Nickel - SN
- Unlacquered Polished Brass - UPB

HOW TO DESIGNATE A SPLIT FINISH FAUCET WHEN ORDERING

Take the model number and add both finishes to the suffix starting with the **Primary finish** followed by the **Accent finish**. For Matte Black (MB) and Classic Bronze (CLZ), it would be **AG254-1-MBCLZ**. If you wanted Classic Bronze (CLZ) and Polished Nickel (PN) it would be **AG254-1-CLZPN**. For all split finish designs click "Split Finishes" in the top menu of our home page on www.waterstoneco.com



- AG201-1-MB/PN

*Pricing subject to change

SHOWER

□ White = Primary finish
■ Gray = Accent finish

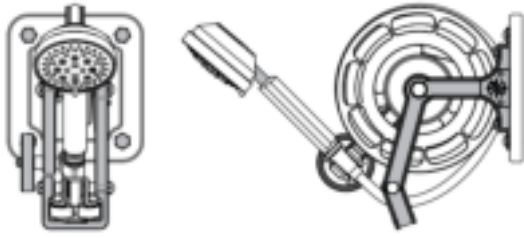

AG254-1



AG250-1

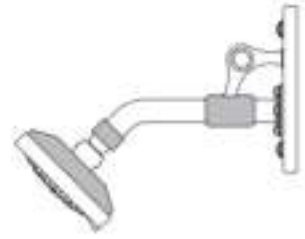

AG255-1



AG231-1

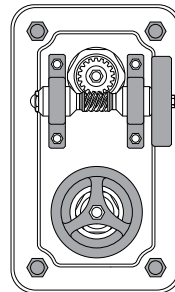

AG221-1

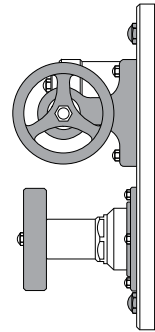

LAVATORY FAUCET

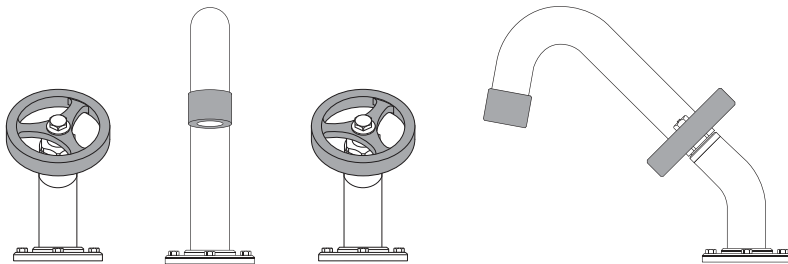

AG210-1

TUB

□ White = Primary finish
■ Gray = Accent finish

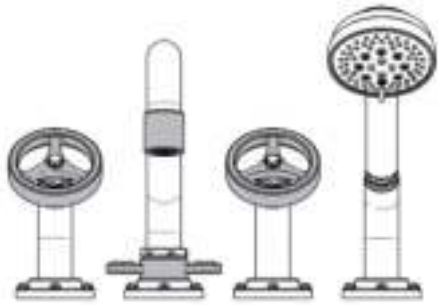

AG240-1

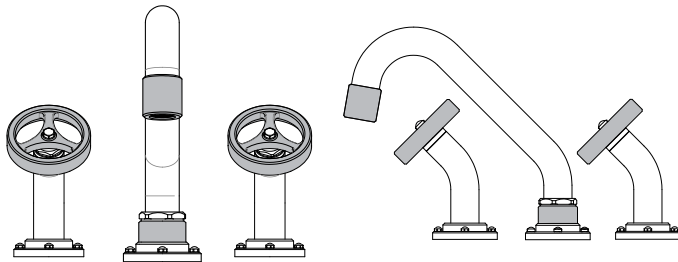

AG241-1



AG244-1

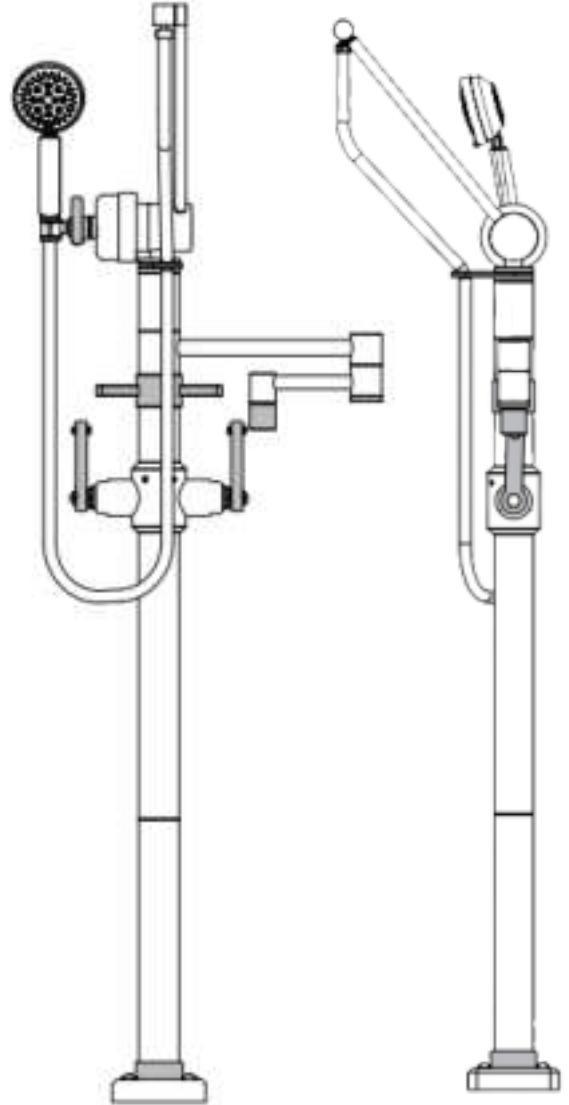
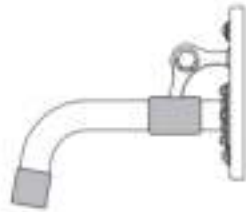

AG245-1

ACCESSORIES

□ White = Primary finish
■ Gray = Accent finish

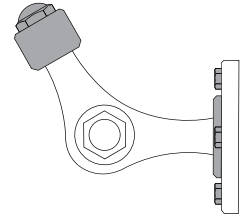
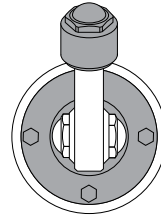
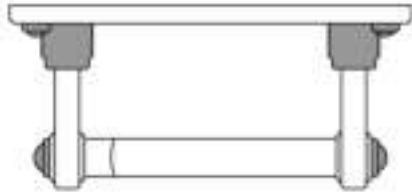

AG301-1

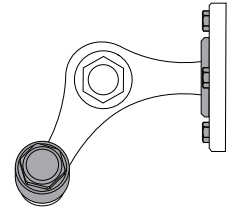
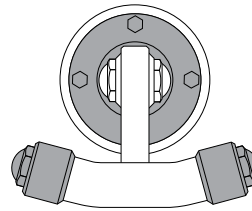

AG307-1

AG302-1

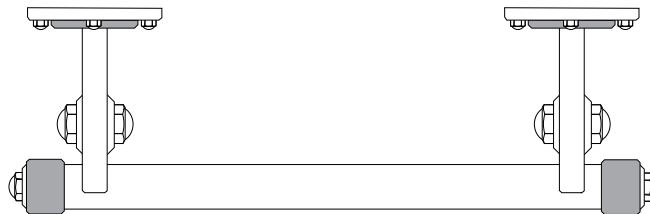
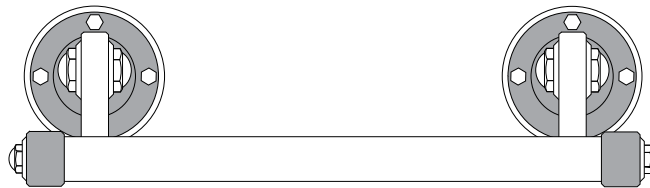

AG308-1, AG318-2, AG324-1, AG330-1

BATH

*Pricing subject to change

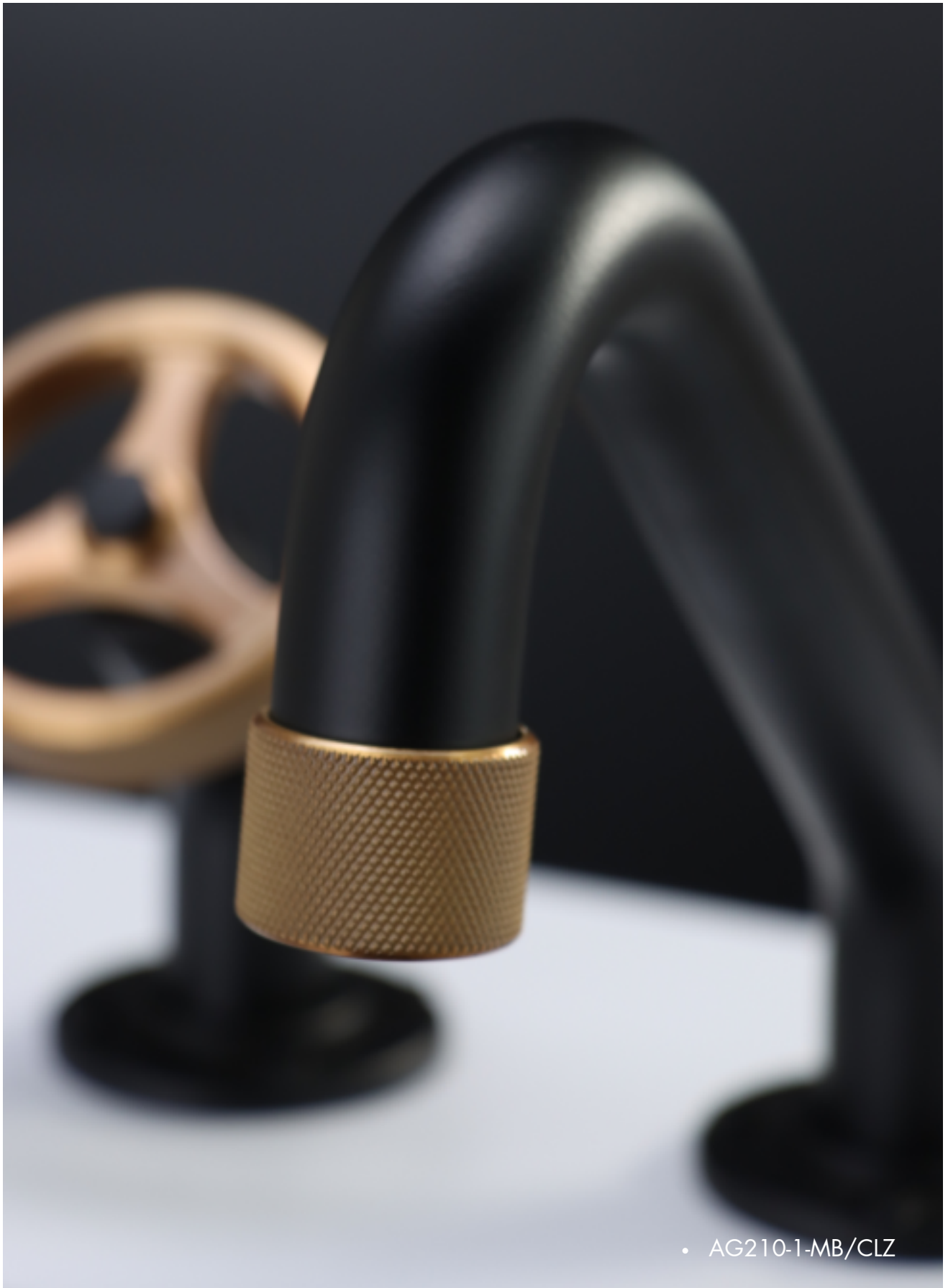

• AG210-1-MB/CLZ



RETRACTABLE WHEEL SYSTEM W/ HAND SHOWER**MODEL: AG254-1****LIST PRICES:****GRP 1: 5446****GRP 2: 6053**

MEETS THE FOLLOWING:

- ASME A112.18.1
- CSA B125.1
- CALGreen

- Rough-in 10122 required (sold separately).
- Wheel spring technology allows the hand shower to be extracted from holder with ease.
- Hand shower hose locks in place when deployed, then auto retracts with a gentle tug
- Hand shower can be adjusted up and down to desired spray angle
- Hand shower includes thumb tab for a smooth transition between spray options
- 3 individual spray options - firm, massage or soft aerated spray
- Resistant to reverse osmosis water
- 68" hose length.
- 4" wide spray face.
- 1.75 gpm flow rate.

**WALL MOUNT SHOWER HEAD W/ BACK PLATE****MODEL: AG250-1****LIST PRICES:****GRP 1: 3026****GRP 2: 3459**

MEETS THE FOLLOWING:

- ASME A112.18.1
- CSA B125.1
- CALGreen

- Rough-in 10122 required.
- 3 individual spray options - firm, massage or soft aerated spray.
- Shower head can swivel in any direction for the desired spray angle.
- Resistant to reverse osmosis water.
- 4" wide spray face.
- 9" shower arm reach.
- 1.75 gpm maximum flow rate.
- 5-1/2"W x 7-1/4"H back plate.

**THERMOSTATIC SHOWER TRIM W/ BUILT IN VOLUME CONTROL****MODEL: AG221-1****LIST PRICES:****GRP 1: 3341****GRP 2: 3911**

MEETS THE FOLLOWING:

- ASME A112.18.1
- CSA B125.1

- Rough-in valve required (sold separately, model #10120).
- Independent controls for volume and water temperature.
- Hot limit stop prevents scalding.
- Push and turn handle feature overrides hot limit stop to increase water temperature.
- Volume control operates by stainless steel spherical drive system.
- Includes cartridge stem extension kit for wall thickness up to 3"
- 6-1/2"W x 11"H trim plate size.



DIVERTER TRIM
MODEL: AG231-1

LIST PRICES:
GRP 1: 1277
GRP 2: 1515

MEETS THE FOLLOWING:

- ASME A112.18.1
- CSA B125.1

- Rough-in valve required (sold separately, model #10121).
- Single handle diverter allows a quick switch between 2 or 3 individual components.
- When turned, handle gently clicks into desired function.
- Includes cartridge stem extension kit for wall thickness up to 3"
- 6-1/2"W x 6-1/2"H trim plate size.



SLIDE BAR HAND SHOWER
MODEL: AG255-1

LIST PRICES:
GRP 1: 3827
GRP 2: 4218

MEETS THE FOLLOWING:

- ASME A112.18.1
- CSA B125.1
- CALGreen

- 36" slide bar with 24" of vertical movement.
- Wheeled slide bar allows for variable shower heights.
- Bar mount locks hand shower in place to desired height, angle and position.
- 3 individual spray options - firm, massage or soft aerated spray.
- Resistant to reverse osmosis water.
- 4" wide spray face.
- 60" hose length.
- 1.75 gpm flow rate.



FREESTANDING TUB FILLER W/ HAND SHOWER
MODEL: AG245-1

LIST PRICES:
GRP 1: 9432
GRP 2: 10035

MEETS THE FOLLOWING:

- ASME A112.18.1
- CSA B125.1
- CALGreen

- Rough-in required (sold separately, model #10123).
- 18 gpm maximum flow rate.
- Floor mounted, single post design.
- ADA compliant lever handles control desired volume and temperature.
- 3/4" hot and cold ceramic disk 1/4 turn cartridges.
- Push lever diverts water flow between tub spout and hand shower.
- Overall height: 62-1/8"
- Floor to spout tip height: 38"
- 17" articulated spout reach.
- Laminar spout flow creates a solid stream of water without splatter.
- Long reaching 60" spray hose.
- Spray arm spring technology lets hand shower extend with ease.
- 4" hand shower spray face.
- 1.75 gpm hand shower flow rate.
- 3 individual spray options – firm, massage or soft aerated spray.
- Hand shower adjusts up and down to desired spray angle.
- Resistant to reverse osmosis water.



FINISH GROUP 1: CH
FINISH GROUP 2: CD, MB, PN, SN, UPB,

*Pricing subject to change

DECK MOUNT TUB FILLER W/ HAND SHOWER**MODEL: AG240-1****LIST PRICES:****GRP 1: 4032****GRP 2: 4699**

MEETS THE FOLLOWING:

- ASME A112.18.1
- CSA B125.1
- CALGreen

- Rough-in required (sold separately, model #10124).
- Laminar spout flow creates a solid stream of water without splatter.
- Push lever diverts water flow between tub spout and hand shower.
- 3 individual spray options - firm, massage or soft aerated spray.
- 4 hole, 1-1/4" diameter mounting design.
- 3/4" hot and cold ceramic disk 1/4 turn cartridges.
- 9" tub spout reach.
- 4" wide hand shower spray face
- 1.75 gpm hand shower flow rate.

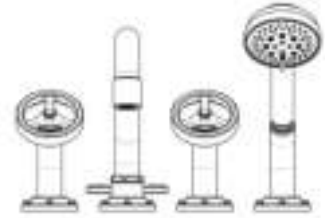
**DECK MOUNT TUB FILLER****MODEL: AG241-1****LIST PRICES:****GRP 1: 3487****GRP 2: 4400**

MEETS THE FOLLOWING:

- ASME A112.18.1
- CSA B125.1
- CALGreen

- 3 Hole, 1-1/4" diameter mounting design.
- 3/4" hot and cold ceramic disk 1/4 turn cartridges.
- 9" tub spout reach.
- Rough-in required (sold separately, model #10124).
- Laminar spout flow creates a solid stream of water without splatter.

**WALL MOUNT TUB SPOUT W/ BACK PLATE****MODEL: AG244-1****LIST PRICES:****GRP 1: 2178****GRP 2: 2610**

MEETS THE FOLLOWING:

- ASME A112.18.1
- CSA B125.1
- CALGreen

- Rough-in 10122 required. (sold separately)
- 9" tub spout reach.
- 5-1/2"W x 8-1/4"H back plate.
- Laminar spout flow creates a solid stream of water without splatter.



LAVATORY FAUCET AND PUSH DRAIN

MODEL AG210-1 PUSH DRAIN W/ OVERFLOW
 MODEL AG210-2 PUSH DRAIN W/O OVERFLOW

LIST PRICES:

Model: AG210-1 | GRP 1: 2392 | GRP 2: 2683

Model: AG210-2 | GRP 1: 2485 | GRP 2: 2776

Model: AG280-1 | GRP 1: 190 | GRP 2: 222

Model: AG281-1 | GRP 1: 190 | GRP 2: 222

MEETS THE FOLLOWING:

- ASME A112.18.1
- CSA B125.1
- CALGreen
- NSF 61, 372

- 6-3/4" spout height
- 6-3/8" spout reach.
- Handles can be installed between 8" to 16" on center.
- 1/2" hot and cold ceramic disk 1/4 turn cartridges.
- 1.75 gpm maximum flow rate.
- 20" reinforced braided connection hoses with 3/8" compression fitting.
- Two-handle, widespread bathroom lavatory faucet.
- Includes push drain. With overflow (10100) or without overflow (10100A).
- Aerated spout tip for smooth water flow.
- Resistant to reverse osmosis water.



AG281-1
NO OVERFLOW



AG280-1
OVERFLOW

TOWEL BARS

LIST PRICES:

8" Model: AG308-1 | GRP 1: 1029 | GRP 2: 1162

18" Model: AG318-1 | GRP 1: 1143 | GRP 2: 1280

24" Model: AG324-1 | GRP 1: 1154 | GRP 2: 1290

30" Model: AG330-1 | GRP 1: 1165 | GRP 2: 1305

- Available in 8in, 18in, 24in or 30in wide.
- Includes heavy duty snap toggle mounting system for drywall and screws for wood doors or panels.



TOILET PAPER HOLDER

MODEL: AG307-1

LIST PRICES:

GRP 1: 1197

GRP 2: 1310

- 8-1/4"W x 3"H back plate

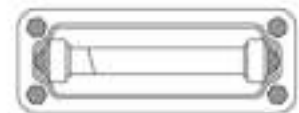

SINGLE ROBE HOOK

MODEL: AG301-1

LIST PRICES:

GRP 1: 498

GRP 2: 559

- Extends 3-5/8" from wall.
- Includes heavy duty snap toggle mounting system for drywall and screws for wood doors or panels.
- Ideal for hanging heavy robes or towels



DOUBLE ROBE HOOK

MODEL: AG302-1

LIST PRICES:

GRP 1: 624

GRP 2: 713

- 2-1/2"W x 3-3/8"H back plate.
- Extends 3-11/16" from wall. Includes heavy duty snap toggle mounting system for drywall and screws for wood doors or panels.



WALL MOUNT SHOWER ROUGH-IN BOX

ROUGH: 10122 (AG254-1,AG250-1)

LIST PRICES:

ROUGH: 247

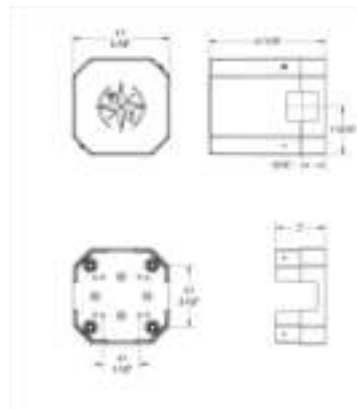

THERMOSTATIC SHOWER VALVE

MODEL: 10120

LIST PRICES:

ROUGH: 848

MEETS THE FOLLOWING:

- ASME A112.18.1
- CSA B125.1
- ASSE 1016/ASME A112.1016/CSA B125.16

- Rough-in valve kit for the AG221-1
- Thermostatic-Volume Control Shower Trim.
- Independent controls for volume and water temperature.
- Adjustable hot limit stop prevents scalding.
- Integral hot and cold inlet service stops ensure easy cartridge access.
- Brass construction.
- Includes mud guard and hardware.
- 3/4" NPT female thread (inlet and outlet) valve body.
- 1/4 turn washer-less ceramic disc,
- 3/4" valve cartridges.



DIVERTER CONTROL VALVE (ROUGH-IN FOR 10105)

MODEL: 10121

LIST PRICES:

ROUGH: 391

MEETS THE FOLLOWING:

- ASME A112.18.1
- CSA B125.1

- 1/2" NPT female inlet connection.
- Three 1/2" NPT female outlet connections.
- Rough-in valve for the AG231-1 Diverter Trim.
- Two or three-way diverter valve.
- Diverts water flow to up to three separate components/outlets.
- Single handle operation.
- Brass construction.
- Includes mud guard and hardware.
- Trim kit sold separately.



FREESTANDING TUB VALVE

MODEL: 10123

LIST PRICES:

ROUGH: 890

MEETS THE FOLLOWING:

- ASME A112.18.1
- CSA B125.1

- Rough-in valve for the AG245-1 Freestanding Tub Filler.
- 3/4" NPT inlet connections.
- Maximum floor thickness 2-1/4".
- Brass construction.
- Includes mud guard and hardware.
- Trim sold separately.



DECK MOUNT TUB VALVE

MODEL: 10124

LIST PRICES:

ROUGH: 939

MEETS THE FOLLOWING:

- ASME A112.18.1
- CSA B125.1

- 3/4" NPT inlet connections.
- 1.75 gpm flow rate for hand shower.
- Rough-in valve for the AG240-1 Deck Mount Tub Fillers.
- Ceramic disc valve cartridge.
- Brass construction.
- Trim kit sold separately.

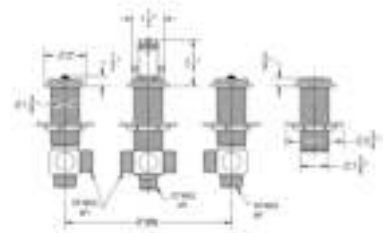

DECK MOUNT TUB VALVE W/O HANDSHOWER

MODEL: 10124A

LIST PRICES:

ROUGH: 568

- 3/4" NPT inlet connections.
- 1.75 gpm flow rate for hand shower.
- Rough-in valve for the AG240-1 Deck Mount Tub Fillers.
- Ceramic disc valve cartridge.
- Brass construction.
- Trim kit sold separately.

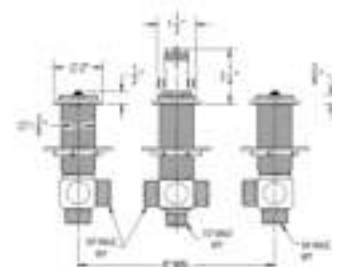

FINISH GROUP 1: CH
FINISH GROUP 2: CD, MB, PN, SN, UPB,

*Pricing subject to change

RAINSTONE

Where rain's gentle embrace converges with
naval might, bestowing tranquility and power





8" RAINSHOWER HEAD - INDUSTRIAL, KNURLED

MODEL: RS256-1

LIST PRICES:

GRP 1: 1053

GRP 2: 1180

MEETS THE FOLLOWING:

- ASME A112.18.1
- CSA B125.1
- CALGreen

- 8" round diameter.
- Ceiling mounted only, single function shower head.
- Machined from Solid Brass
- Individual waterways for a symmetrical flow
- Immersive Spray
- 97 Self-cleaning nozzles
- 1/2" NPT connection.
- 1.75 gpm flow rate.
- 6" Straight shower arm and flange included.



9-1/2" RAINSHOWER HEAD - INDUSTRIAL, KNURLED

MODEL: RS256-2

LIST PRICES:

GRP 1: 1210

GRP 2: 1335

MEETS THE FOLLOWING:

- ASME A112.18.1
- CSA B125.1
- CALGreen

- 9-1/2" round diameter.
- Ceiling mounted only, single function shower head.
- Machined from Solid Brass
- Individual waterways for a symmetrical flow
- Immersive Spray
- 145 Self-cleaning nozzles
- 1/2" NPT connection.
- 1.75 gpm flow rate.
- 6" Straight shower arm and flange included.

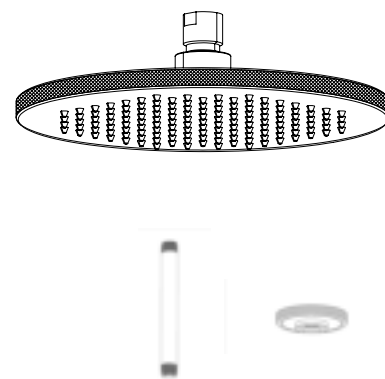

12" RAINSHOWER HEAD - INDUSTRIAL, KNURLED

MODEL: RS256-3

LIST PRICES:

GRP 1: 1532

GRP 2: 1657

MEETS THE FOLLOWING:

- ASME A112.18.1
- CSA B125.1
- CALGreen

- 12" round diameter.
- Ceiling mounted only, single function shower head.
- Machined from Solid Brass
- Individual waterways for a symmetrical flow
- Immersive Spray
- 249 Self-cleaning nozzles
- 1/2" NPT connection.
- 1.75 gpm flow rate.
- 6" Straight shower arm and flange included.

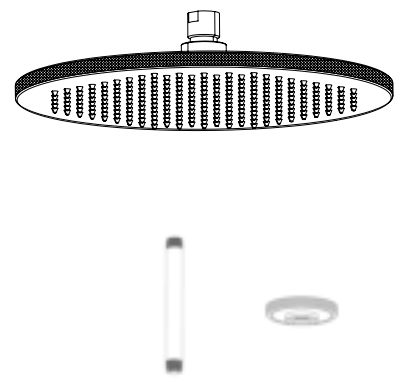

FINISH GROUP 1: CH
FINISH GROUP 2: CD, MB, PN, SN, UPB,

*Pricing subject to change

8" ROUND MODERN RAINSHOWER HEAD

MODEL: RS256-4

LIST PRICES:

GRP 1: 1040

GRP 2: 1167

MEETS THE FOLLOWING:

- ASME A112.18.1
- CSA B125.1
- CALGreen

- 8" round diameter.
- Ceiling mounted only, single function shower head.
- Machined from Solid Brass
- Individual waterways for a symmetrical flow
- Immersive Spray
- 97 Self-cleaning nozzles
- 1/2" NPT connection.
- 1.75 gpm flow rate.
- 6" Straight shower arm and flange included.

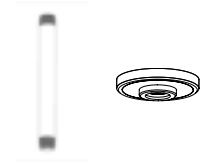
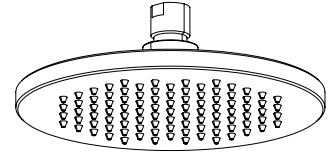

9-1/2" ROUND MODERN RAINSHOWER HEAD

MODEL: RS256-5

LIST PRICES:

GRP 1: 1197

GRP 2: 1324

MEETS THE FOLLOWING:

- ASME A112.18.1
- CSA B125.1
- CALGreen

- 9-1/2" round diameter.
- Ceiling mounted only, single function shower head.
- Machined from Solid Brass
- Individual waterways for a symmetrical flow
- Immersive Spray
- 145 Self-cleaning nozzles
- 1/2" NPT connection.
- 1.75 gpm flow rate.
- 6" Straight shower arm and flange included.

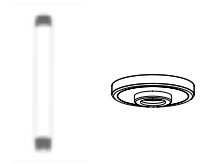
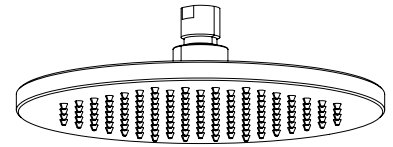

12" ROUND MODERN RAINSHOWER HEAD

MODEL: RS256-6

LIST PRICES:

GRP 1: 1520

GRP 2: 1646

MEETS THE FOLLOWING:

- ASME A112.18.1
- CSA B125.1
- CALGreen

- 12" round diameter.
- Ceiling mounted only, single function shower head.
- Machined from Solid Brass
- Individual waterways for a symmetrical flow
- Immersive Spray
- 249 Self-cleaning nozzles
- 1/2" NPT connection.
- 1.75 gpm flow rate.
- 6" Straight shower arm and flange included.

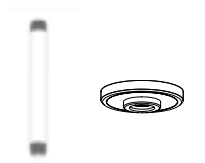
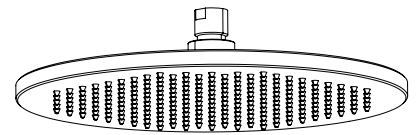

MODEL #	NAME	GRP 1	GRP 2	GRP 3	SS	PAGE
1000	ULTIMATE UNDER SINK SYSTEM	1225	N/A	N/A	N/A	142
1100C	ANNAPOLIS COLD ONLY FILTRATION FAUCET - LEVER HANDLE	805	843	1100	N/A	110
1100H	ANNAPOLIS HOT ONLY FILTRATION FAUCET - LEVER HANDLE	836	878	1143	N/A	110
1100HC	ANNAPOLIS HOT AND COLD FILTRATION FAUCET - LEVER HANDLES	939	987	1285	N/A	110
1150C	ANNAPOLIS COLD ONLY FILTRATION FAUCET - CROSS HANDLE	843	885	1153	N/A	111
1150H	ANNAPOLIS HOT ONLY FILTRATION FAUCET - CROSS HANDLE	868	912	1187	N/A	111
1150HC	ANNAPOLIS HOT AND COLD FILTRATION FAUCET - CROSS HANDLES	974	1023	1332	N/A	111
1200C	HAMPTON COLD ONLY FILTRATION FAUCET - LEVER HANDLE	728	764	996	N/A	112
1200H	HAMPTON HOT ONLY FILTRATION FAUCET - LEVER HANDLE	778	817	1065	N/A	112
1200HC	HAMPTON HOT AND COLD FILTRATION FAUCET - LEVER HANDLES	881	926	1205	N/A	112
1202C	PEMBROKE COLD ONLY FILTRATION FAUCET - LEVER HANDLE	808	849	1104	N/A	114
1202H	PEMBROKE HOT ONLY FILTRATION FAUCET - LEVER HANDLE	877	921	1200	N/A	114
1202HC	PEMBROKE HOT AND COLD FILTRATION FAUCET - LEVER HANDLES	985	1036	1349	N/A	114
1250C	HAMPTON COLD ONLY FILTRATION FAUCET - CROSS HANDLE	763	800	1043	N/A	113
1250H	HAMPTON HOT ONLY FILTRATION FAUCET - CROSS HANDLE	810	851	1108	N/A	113
1250HC	HAMPTON HOT AND COLD FILTRATION FAUCET - CROSS HANDLES	913	959	1249	N/A	113
1252C	PEMBROKE COLD ONLY FILTRATION FAUCET - CROSS HANDLE	838	881	1148	N/A	115
1252H	PEMBROKE HOT ONLY FILTRATION FAUCET - CROSS HANDLE	902	948	1235	N/A	115
1252HC	PEMBROKE HOT AND COLD FILTRATION FAUCET - CROSS HANDLES	1015	1067	1390	N/A	115
1300	ANNAPOLIS BAR FAUCET - LEVER HANDLES	1102	1158	1509	N/A	102
1350	ANNAPOLIS BAR FAUCET - CROSS HANDLES	1136	1193	1553	N/A	102
1400C	PARCHE COLD ONLY FILTRATION FAUCET - LEVER HANDLE	698	733	955	980	118
1400H	PARCHE HOT ONLY FILTRATION FAUCET - LEVER HANDLE	764	803	1044	1073	118
1400HC	PARCHE HOT AND COLD FILTRATION FAUCET - LEVER HANDLES	828	870	1135	1164	118
1425C	FULTON COLD ONLY FILTRATION FAUCET - LEVER HANDLE	746	782	1020	1048	119
1425H	FULTON HOT ONLY FILTRATION FAUCET - LEVER HANDLE	810	851	1108	1138	119
1425HC	FULTON HOT AND COLD FILTRATION FAUCET - LEVER HANDLES	875	919	1198	1230	119
1450C	INDUSTRIAL COLD ONLY FILTRATION FAUCET - C-SPOUT	752	791	1031	1058	121
1450H	INDUSTRIAL HOT ONLY FILTRATION FAUCET - C-SPOUT	824	866	1127	1158	121
1450HC	INDUSTRIAL HOT AND COLD FILTRATION FAUCET - C-SPOUT	895	938	1224	1257	121
1455C	INDUSTRIAL COLD ONLY FILTRATION FAUCET - 2 BEND U-SPOUT	805	843	1100	1130	122
1455H	INDUSTRIAL HOT ONLY FILTRATION FAUCET - 2 BEND U-SPOUT	883	927	1207	1240	122

MODEL #	NAME	GRP 1	GRP 2	GRP 3	SS	PAGE
1455HC	INDUSTRIAL HOT AND COLD FILTRATION FAUCET - 2 BEND U-SPOUT	954	1003	1307	1342	122
1500	HAMPTON BAR FAUCET - LEVER HANDLES	983	1034	1346	N/A	102
1502	PEMBROKE BAR FAUCET - LEVER HANDLES	1027	1080	1405	N/A	103
1550	HAMPTON BAR FAUCET - CROSS HANDLES	1039	1091	1421	N/A	103
1552	PEMBROKE BAR FAUCET - CROSS HANDLES	1073	1128	1469	N/A	103
1600	PARCHE BAR FAUCET	977	1025	1336	1372	104
1625	FULTON BAR FAUCET	989	1039	1353	1391	105
1650	INDUSTRIAL BAR FAUCET - C-SPOUT	1073	1128	1469	1510	105
1655	INDUSTRIAL BAR FAUCET - 2 BEND U-SPOUT	1087	1142	1487	1527	106
1700C	TOWSON COLD ONLY FILTRATION FAUCET - LEVER HANDLE	1015	1067	1390	N/A	116
1700H	TOWSON HOT ONLY FILTRATION FAUCET - LEVER HANDLE	1080	1133	1477	N/A	116
1700HC	TOWSON HOT AND COLD FILTRATION FAUCET - LEVER HANDLES	1197	1257	1637	N/A	116
1750C	TOWSON COLD ONLY FILTRATION FAUCET - CROSS HANDLE	1043	1097	1429	N/A	117
1750H	TOWSON HOT ONLY FILTRATION FAUCET - CROSS HANDLE	1006	1055	1374	N/A	117
1750HC	TOWSON HOT AND COLD FILTRATION FAUCET - CROSS HANDLES	1287	1352	1762	N/A	117
1800	TOWSON BAR FAUCET - LEVER HANDLES	1296	1360	1773	N/A	104
1850	TOWSON BAR FAUCET - CROSS HANDLES	1367	1436	1871	N/A	104
1900C	HUNLEY COLD ONLY FILTRATION FAUCET - LEVER HANDLES	993	1042	1358	1395	120
1900H	HUNLEY HOT ONLY FILTRATION FAUCET - LEVER HANDLES	1052	1103	1438	1477	120
1900HC	HUNLEY HOT AND COLD FILTRATION FAUCET - LEVER HANDLES	1115	1171	1526	1567	120
2000	INSTA-HOT UNDER SINK SYSTEM	814	N/A	N/A	N/A	142
2100	TRADITIONAL RO AIR GAP	385	404	527	N/A	N/A
2200	CONTEMPORARY RO AIR GAP	366	385	500	515	N/A
2500	HUNLEY BAR FAUCET	1314	1380	1797	1846	105
3000	FILTRATION UNDER SINK SYSTEM	601	N/A	N/A	N/A	142
3010	CONTEMPORARY AIR SWITCH	449	472	615	632	133
3020	CONTEMPORARY SINGLE PORT AIR GAP	285	299	389	400	131
3025	CONTEMPORARY SIDE SPRAY	717	753	982	1008	138
3030	CONTEMPORARY DUAL PORT AIR GAP	341	358	466	480	132
3080	CONTEMPORARY HOLE COVER	140	147	193	198	139
3100	TRADITIONAL WALL MOUNTED POTFILLER - LEVER HANDLE	2009	2110	2750	N/A	126
3150	TRADITIONAL WALL MOUNTED POTFILLER - CROSS HANDLE	1920	2016	2625	N/A	126

MODEL #	NAME	GRP 1	GRP 2	GRP 3	SS	PAGE
3200	CONTEMPORARY WALL MOUNTED POTFILLER	1869	1962	2557	2626	127
3250	INDUSTRIAL WALL MOUNTED POTFILLER	1927	2023	2638	2708	127
3300	TRADITIONAL COUNTER MOUNTED POTFILLER - LEVER HANDLE	1998	2097	2733	N/A	128
3350	TRADITIONAL COUNTER MOUNTED POTFILLER - CROSS HANDLE	2128	2235	2912	N/A	128
3400	CONTEMPORARY COUNTER MOUNTED POTFILLER	1998	2097	2733	2807	128
3500	HUNLEY PRÉP FAUCET	1788	1877	2445	2512	101
3600-12	HUNLEY KITCHEN FAUCET - 12" ARTICULATED SPOUT	2121	2226	2901	2979	95
3600-18	HUNLEY KITCHEN FAUCET - 18" ARTICULATED SPOUT	2249	2360	3077	3160	96
3700	CONTEMPORARY GANTRY PULLDOWN FAUCET - STRAIGHT SPOUT	6257	6569	8559	8792	84
3710-12	CONTEMPORARY GANTRY PULLDOWN FAUCET - 12" ARTICULATED SPOUT	6647	6980	9095	9342	84
3710-18	CONTEMPORARY GANTRY PULLDOWN FAUCET - 18" ARTICULATED SPOUT	6825	7166	9336	9590	84
3783	CONTEMPORARY 6" ESCUTCHEON PLATE	274	288	375	385	140
3784	CONTEMPORARY 10" ESCUTCHEON PLATE	330	346	450	463	140
3800	PARCHE KITCHEN FAUCET	1793	1882	2453	2520	96
3825	FULTON KITCHEN FAUCET	1858	1951	2541	2611	96
3900	PARCHE PRÉP FAUCET	1665	1748	2278	2340	101
3925	FULTON PRÉP FAUCET	1729	1816	2366	2430	101
4010	TRADITIONAL AIR SWITCH	496	522	680	N/A	133
4020	TRADITIONAL SINGLE PORT AIR GAP	316	331	431	N/A	131
4025	TRADITIONAL SIDE SPRAY	717	753	982	N/A	138
4030	TRADITIONAL DUAL PORT AIR GAP	340	357	465	N/A	132
4055	TRADITIONAL SOAP/LOTION DISPENSER - STRAIGHT SPOUT	564	592	771	N/A	134
4055E	TRADITIONAL SOAP/LOTION DISPENSER - EXTENDED STRAIGHT SPOUT	592	622	810	N/A	134
4060	TRADITIONAL SOAP/LOTION DISPENSER - HOOK SPOUT	564	592	771	N/A	135
4060E	TRADITIONAL SOAP/LOTION DISPENSER - EXTENDED HOOK SPOUT	592	622	810	N/A	135
4065	CONTEMPORARY SOAP/LOTION DISPENSER	477	501	653	670	136
4065E	CONTEMPORARY SOAP/LOTION DISPENSER - EXTENDED SPOUT	501	526	686	704	136
4070	TRADITIONAL DECORATIVE HOLE COVER - COMPASS BUTTON	124	129	168	N/A	139
4080	TRADITIONAL DECORATIVE HOLE COVER - FINISH BUTTON	129	136	178	N/A	139
4100-12	TOWSON KITCHEN FAUCET - 12" ARTICULATED SPOUT	2068	2172	2832	N/A	93

MODEL #	NAME	GRP 1	GRP 2	GRP 3	SS	PAGE
4100-18	TOWSON KITCHEN FAUCET - 18" ARTICULATED SPOUT	2191	2301	2999	N/A	93
4200	ANNAPOLIS KITCHEN FAUCET	1863	1956	2550	N/A	93
4300	HAMPTON KITCHEN FAUCET	1832	1923	2506	N/A	94
4400	TRADITIONAL GANTRY PULLDOWN FAUCET - HOOK SPOUT	5511	5786	7539	N/A	83
4410-12	TRADITIONAL GANTRY PULLDOWN FAUCET - 12" ARTICULATED SPOUT	6345	6662	8681	N/A	83
4410-18	GANTRY PULLDOWN FAUCET - TRADITIONAL - 18" ARTICULATED SPOUT	6522	6849	8924	N/A	83
4500	PRV - PRESSURE REGULATOR VALVE	161	N/A	N/A	N/A	143
4700	TOWSON PREP FAUCET	1825	1916	2497	N/A	100
4783	TRADITIONAL 6" ESCUTCHEON PLATE	293	308	401	N/A	141
4784	TRADITIONAL 10" ESCUTCHEON PLATE	361	378	493	N/A	141
4800	ANNAPOLIS PREP FAUCET	1793	1882	2453	N/A	100
4900	HAMPTON PREP FAUCET	1729	1816	2366	N/A	100
5000	HOT TANK	684	N/A	N/A	N/A	143
5100	TRADITIONAL WHEEL PULLDOWN FAUCET	6863	7206	9390	N/A	22
5125	ENDEAVOR WHEEL PULLDOWN FAUCET - TOGGLE SPRAYER	7872	8266	10770	N/A	22
5130	ENDEAVOR WHEEL PULLDOWN FAUCET - LEVER SPRAYER	8056	8459	11023	N/A	22
5200	TRADITIONAL PREP SIZE PLP PULLDOWN FAUCET	2653	2784	3628	N/A	26
5210	TRADITIONAL PREP SIZE PLP PULLDOWN FAUCET - ANGLED SPOUT	2730	2865	3734	N/A	26
5300	CONTEMPORARY EXTENDED REACH PLP PULLDOWN FAUCET - TOGGLE SPRAYER	2947	3093	4032	4140	29
5400	CONTEMPORARY PLP PULLDOWN FAUCET - TOGGLE SPRAYER	2657	2789	3636	3733	29
5410	CONTEMPORARY PLP PULLDOWN FAUCET - ANGLED SPOUT - TOGGLE SPRAYER	2734	2871	3741	3842	30
5500	TRADITIONAL EXTENDED REACH PLP PULLDOWN FAUCET	2902	3046	3970	N/A	25
5600	TRADITIONAL PLP PULLDOWN FAUCET	2758	2898	3775	N/A	25
5610	TRADITIONAL PLP PULLDOWN FAUCET - ANGLED SPOUT	2841	2982	3887	N/A	25
5700	CONTEMPORARY EXTENDED REACH PLP PULLDOWN FAUCET - LEVER SPRAYER	3021	3171	4132	4245	29
5800	CONTEMPORARY PLP PULLDOWN FAUCET - LEVER SPRAYER	2902	3046	3970	4077	30
5810	CONTEMPORARY PLP PULLDOWN FAUCET - ANGLED SPOUT - LEVER SPRAYER	2991	3139	4092	4202	30
5900	CONTEMPORARY PREP SIZE PLP PULLDOWN FAUCET - TOGGLE SPRAYER	2644	2777	3619	3716	31

MODEL #	NAME	GRP 1	GRP 2	GRP 3	SS	PAGE
5910	CONTEMPORARY PREP SIZE PLP PULLDOWN FAUCET - ANGLED SPOUT - TOGGLE SPRAYER	2722	2859	3726	3826	31
5930	CONTEMPORARY PREP SIZE PLP PULLDOWN FAUCET - LEVER SPRAYER	2789	2930	3817	3921	31
5940	CONTEMPORARY PREP SIZE PLP PULLDOWN FAUCET - ANGLED SPOUT - LEVER SPRAYER	2874	3017	3933	4039	32
6100-12	TOWSON BRIDGE FAUCET - 12" ARTICULATED SPOUT - LEVER HANDLES	3462	3635	4735	N/A	87
6100-18	TOWSON BRIDGE FAUCET - 18" ARTICULATED SPOUT - LEVER HANDLES	3598	3778	4924	N/A	87
6150-12	TOWSON BRIDGE FAUCET - 12" ARTICULATED SPOUT - CROSS HANDLES	3666	3850	5016	N/A	87
6150-18	TOWSON BRIDGE FAUCET - 18" ARTICULATED SPOUT - CROSS HANDLES	3804	3995	5208	N/A	88
6200	ANNAPOLIS BRIDGE FAUCET - LEVER HANDLES	3284	3447	4492	N/A	88
6250	ANNAPOLIS BRIDGE FAUCET - CROSS HANDLES	3324	3490	4548	N/A	88
6300	HAMPTON BRIDGE FAUCET - LEVER HANDLES	2873	3017	3931	N/A	89
6350	HAMPTON BRIDGE FAUCET - CROSS HANDLES	3010	3160	4117	N/A	89
7000	DIGITAL HOT TANK	725	N/A	N/A	N/A	143
7600-12	HUNLEY BRIDGE FAUCET - 12" ARTICULATED SPOUT	3147	3305	4306	4422	89
7600-18	HUNLEY BRIDGE FAUCET - 18" ARTICULATED SPOUT	3420	3591	4680	4807	90
7800	PARCHE BRIDGE FAUCET	2600	2729	3556	3652	90
7825	FULTON BRIDGE FAUCET	2667	2800	3649	3748	90
8010-12	TOWSON TWO HANDLE KITCHEN FAUCET - 12" ARTICULATED SPOUT	2410	2529	3296	N/A	94
8010-18	TOWSON TWO HANDLE KITCHEN FAUCET - 18" ARTICULATED SPOUT	2561	2689	3505	N/A	94
8020	ANNAPOLIS TWO HANDLE KITCHEN FAUCET	1864	1958	2551	N/A	95
8030	HAMPTON TWO HANDLE KITCHEN FAUCET	1838	1930	2516	N/A	95
9010	INDUSTRIAL AIR SWITCH	453	476	620	636	133
9020	INDUSTRIAL SINGLE PORT AIR GAP	297	312	407	417	131
9030	INDUSTRIAL DUAL PORT AIR GAP	363	381	497	509	132
9065	INDUSTRIAL SOAP/LOTION DISPENSER	480	505	658	675	137
9065E	INDUSTRIAL SOAP/LOTION DISPENSER - EXTENDED SPOUT	504	530	691	709	137
9300	INDUSTRIAL EXTENDED REACH PLP PULLDOWN FAUCET - TOGGLE SPRAYER	2307	2422	3156	3242	35

MODEL #	NAME	GRP 1	GRP 2	GRP 3	SS	PAGE
9350	MODERN EXTENDED REACH PLP PULLDOWN FAUCET - TOGGLE SPRAYER	2220	2330	3037	3120	41
9400	INDUSTRIAL PLP PULLDOWN FAUCET - TOGGLE SPRAYER	2068	2172	2830	2907	35
9410	INDUSTRIAL PLP PULLDOWN FAUCET - ANGLED SPOUT - TOGGLE SPRAYER	2180	2288	2982	3062	36
9450	MODERN PLP PULLDOWN FAUCET - TOGGLE SPRAYER	1982	2081	2712	2785	41
9460	MODERN PLP PULLDOWN FAUCET - ANGLED SPOUT - TOGGLE SPRAYER	2093	2198	2883	2942	42
9700	INDUSTRIAL EXTENDED REACH PLP PULLDOWN FAUCET - LEVER SPRAYER	2687	2821	3676	3775	35
9750	MODERN EXTENDED REACH PLP PULLDOWN FAUCET - LEVER SPRAYER	2600	2731	3559	3654	41
9800	INDUSTRIAL PLP PULLDOWN FAUCET - LEVER SPRAYER	2445	2568	3345	3435	36
9810	INDUSTRIAL PLP PULLDOWN FAUCET - ANGLED SPOUT - LEVER SPRAYER	2549	2676	3488	3582	36
9850	MODERN PLP PULLDOWN FAUCET - LEVER SPRAYER	2358	2476	3227	3313	42
9860	MODERN PLP PULLDOWN FAUCET - ANGLED SPOUT - LEVER SPRAYER	2462	2588	3370	3460	42
9900	INDUSTRIAL PREP SIZE PLP PULLDOWN FAUCET - TOGGLE SPRAYER	2046	2149	2799	2874	37
9910	INDUSTRIAL PREP SIZE PLP PULLDOWN FAUCET - ANGLED SPOUT - TOGGLE SPRAYER	2051	2154	2806	2883	37
9930	INDUSTRIAL PREP SIZE PLP PULLDOWN FAUCET - LEVER SPRAYER	2415	2537	3305	3394	37
9940	INDUSTRIAL PREP SIZE PLP PULLDOWN FAUCET - ANGLED SPOUT	2421	2542	3312	3402	38
9950	MODERN PREP SIZE PLP PULLDOWN FAUCET - TOGGLE SPRAYER	1959	2057	2680	2752	43
9960	MODERN PREP SIZE PLP PULLDOWN FAUCET - ANGLED SPOUT - TOGGLE SPRAYER	1965	2063	2688	2761	43
9980	MODERN PREP SIZE PLP PULLDOWN FAUCET - LEVER SPRAYER	2328	2445	3185	3272	43
9990	MODERN PREP SIZE PLP PULLDOWN FAUCET - ANGLED SPOUT - LEVER SPRAYER	2335	2451	3194	3281	44
10200	FULTON INDUSTRIAL EXTENDED REACH PLP FAUCET - TOGGLE SPRAYER	2422	2542	3314	3404	47
10210	FULTON INDUSTRIAL PLP PULLDOWN FAUCET - TOGGLE SPRAYER	2172	2281	2971	3053	47
10220	FULTON INDUSTRIAL PLP PULLDOWN FAUCET - ANGLED SPOUT - TOGGLE SPRAY	2288	2402	3131	3215	48
10230	FULTON INDUSTRIAL PREP SIZE PLP PULLDOWN FAUCET - TOGGLE SPRAYER	2149	2256	2938	3018	49

MODEL #	NAME	GRP 1	GRP 2	GRP 3	SS	PAGE
10240	FULTON INDUSTRIAL PREP SIZE PLP PULLDOWN FAUCET - ANGLE SPOUT - TOGGLE SPRAYER	2167	2284	2972	3051	49
10250	FULTON INDUSTRIAL EXTENDED REACH PLP FAUCET - LEVER SPRAYER	2821	2961	3860	3965	47
10260	FULTON INDUSTRIAL PLP PULLDOWN FAUCET - LEVER SPRAYER	2568	2696	3512	3608	48
10270	FULTON INDUSTRIAL PLP PULLDOWN FAUCET - ANGLED SPOUT - LEVER SPRAY	2678	2810	3662	3761	48
10280	FULTON INDUSTRIAL PREP SIZE PLP PULLDOWN FAUCET - LEVER SPRAYER	2550	2677	3487	3582	49
10290	FULTON INDUSTRIAL PREP SIZE PLP PULLDOWN FAUCET - ANGLE SPOUT - LEVER SPRAYER	2555	2694	3505	3598	50
10300	FULTON MODERN EXTENDED REACH PLP FAUCET - TOGGLE SPRAYER	2330	2447	3189	3276	53
10310	FULTON MODERN PLP PULLDOWN FAUCET - TOGGLE SPRAYER	2080	2185	2846	2925	53
10320	FULTON MODERN PLP PULLDOWN FAUCET - ANGLED SPOUT - TOGGLE SPRAYER	2197	2308	3007	3089	54
10330	FULTON MODERN PREP SIZE PLP PULLDOWN FAUCET - TOGGLE SPRAYER	2057	2160	2813	2890	55
10340	FULTON MODERN PREP SIZE PLP PULLDOWN FAUCET - ANGLE SPOUT - TOGGLE SPRAYER	2075	2190	2849	2923	55
10350	FULTON MODERN EXTENDED REACH PLP FAUCET - LEVER SPRAYER	2730	2868	3737	3837	53
10360	FULTON MODERN PLP PULLDOWN FAUCET - LEVER SPRAYER	2476	2600	3387	3480	54
10370	FULTON MODERN PLP PULLDOWN FAUCET - ANGLED SPOUT - LEVER SPRAYER	2585	2716	3538	3634	54
10380	FULTON MODERN PREP SIZE PLP PULLDOWN FAUCET - LEVER SPRAYER	2445	2568	3344	3437	55
10390	FULTON MODERN PREP SIZE PLP PULLDOWN FAUCET - ANGLE SPOUT - LEVER SPRAYER	2465	2602	3384	3474	56
30101	MULTI-STAGE FILTRATION UNIT	457	N/A	N/A	N/A	144
30102	REPLACEMENT FILTRATION FILTER	159	N/A	N/A	N/A	144
141400	COUPLING - 1/4 X 1/4 - RED TUBE	31	N/A	N/A	N/A	N/A
516380	COUPLING - 5/16 X 3/8 - CLEAR TUBE	31	N/A	N/A	N/A	N/A
516516	COUPLING - 5/16 X 5/16	31	N/A	N/A	N/A	N/A
AS-414-S S	SAFETY VALVE LEAK DETECTION UNIT	209	N/A	N/A	N/A	144
HCK-100	CONTEMPORARY SMALL KNOB	12	16	23	27	152
HCK-101	CONTEMPORARY LARGE KNOB	24	28	42	62	153

MODEL #	NAME	GRP 1	GRP 2	GRP 3	SS	PAGE
HCK-102	CONTEMPORARY POST PULL	24	28	39	62	153
HCK-103	CONTEMPORARY T-PULL	28	32	44	53	153
HCP-030 0	CONTEMPORARY 3" CABINET PULL	75	99	155	205	158
HCP-035 0	CONTEMPORARY 3.5" CABINET PULL	78	103	160	210	158
HCP-040 0	CONTEMPORARY 4" CABINET PULL	79	105	169	215	158
HCP-050 0	CONTEMPORARY 5" CABINET PULL	82	106	175	220	158
HCP-060 0	CONTEMPORARY 6" CABINET PULL	85	108	179	225	158
HCP-080 0	CONTEMPORARY 8" CABINET PULL	89	115	180	230	158
HCP-1200	CONTEMPORARY 12" HEAVY DRAWER PULL	120	163	199	240	160
HCP-1201	CONTEMPORARY 12" APPLIANCE PULL	225	295	315	399	164
HCP-1800	CONTEMPORARY 18" APPLIANCE PULL	290	325	330	465	164
HCP-2400	CONTEMPORARY 24" APPLIANCE PULL	312	396	402	499	164
HCP-300 0	CONTEMPORARY 30" APPLIANCE PULL	385	465	535	599	164
HIK-200	INDUSTRIAL 3 SPOKE KNOB	77	97	106	N/A	153
HIK-201	INDUSTRIAL SMALL KNURLED KNOB	20	28	67	N/A	154
HIK-202	INDUSTRIAL LARGE KNURLED KNOB	32	40	99	N/A	154
HIP-0200	INDUSTRIAL 2" BIN PULL	274	317	498	N/A	159
HIP-0300	INDUSTRIAL 3" BIN PULL	322	385	525	N/A	159
HIP-0400	INDUSTRIAL 4" BIN PULL	374	463	552	N/A	159
HIP-0500	INDUSTRIAL 5" HANDLE PULL	299	346	504	N/A	158
HIP-0600	INDUSTRIAL 6" HANDLE PULL	323	376	524	N/A	158
HIP-0800	INDUSTRIAL 8" HANDLE PULL	352	408	546	N/A	158
HIP-1200	INDUSTRIAL 12" HEAVY DRAWER PULL	388	448	585	N/A	160
HIP-1201	INDUSTRIAL 12" APPLIANCE PULL	436	517	772	N/A	163
HIP-1800	INDUSTRIAL 18" APPLIANCE PULL	493	586	886	N/A	163
HIP-2400	INDUSTRIAL 24" APPLIANCE PULL	687	792	1055	N/A	163
HIP-3000	INDUSTRIAL 30" APPLIANCE PULL	780	893	1181	N/A	163

MODEL #	NAME	GRP 1	GRP 2	GRP 3	SS	PAGE
HMK-102	MODERN INDUSTRIAL POST PULL	38	42	110	N/A	154
HMK-103	MODERN INDUSTRIAL T-PULL	45	54	118	N/A	154
HMP-030 0	MODERN INDUSTRIAL 3" CABINET PULL	105	132	269	N/A	159
HMP-035 0	MODERN INDUSTRIAL 3.5" CABINET PULL	108	141	272	N/A	159
HMP-040 0	MODERN INDUSTRIAL 4" CABINET PULL	114	149	278	N/A	159
HMP-050 0	MODERN INDUSTRIAL 5" CABINET PULL	123	158	285	N/A	159
HMP-060 0	MODERN INDUSTRIAL 6" CABINET PULL	126	167	288	N/A	159
HMP-080 0	MODERN INDUSTRIAL 8" CABINET PULL	135	175	292	N/A	159
HMP-1200	MODERN INDUSTRIAL 12" HEAVY DRAWER PULL	165	205	299	N/A	160
HMP-1201	MODERN INDUSTRIAL 12" APPLIANCE PULL	365	425	475	N/A	164
HMP-1800	MODERN INDUSTRIAL 18" APPLIANCE PULL	405	515	525	N/A	164
HMP-240 0	MODERN INDUSTRIAL 24" APPLIANCE PULL	475	595	625	N/A	164
HMP-300 0	MODERN INDUSTRIAL 30" APPLIANCE PULL	528	647	710	N/A	164
HMP-1201 B	MODERN INDUSTRIAL 12" DOOR PULL, 2 PULLS BACK TO BACK	785	905	1005	N/A	164
HMP-1800 B	MODERN INDUSTRIAL 18" DOOR PULL, 2 PULLS BACK TO BACK	1865	1085	1105	N/A	164
HMP-240 0B	MODERN INDUSTRIAL 24" DOOR PULL, 2 PULLS BACK TO BACK	1005	1245	1305	N/A	164
HMP-300 0B	MODERN INDUSTRIAL 30" DOOR PULL, 2 PULLS BACK TO BACK	1111	1349	1475	N/A	164
HTK-001	TRADITIONAL SMALL PLAIN KNOB	46	51	80	N/A	151
HTK-002	TRADITIONAL LARGE PLAIN KNOB	48	53	82	N/A	151
HTK-003	TRADITIONAL SMALL DECORATIVE KNOB	52	57	85	N/A	151
HTK-004	TRADITIONAL LARGE DECORATIVE KNOB	53	58	87	N/A	151
HTK-005	TRADITIONAL POST PULL	54	59	115	N/A	152
HTK-006	TRADITIONAL SMALL T-PULL	56	61	135	N/A	152
HTK-007	TRADITIONAL LARGE T-PULL	57	64	149	N/A	152

MODEL #	NAME	GRP 1	GRP 2	GRP 3	SS	PAGE
HTP-0300	TRADITIONAL 3" CABINET PULL	90	104	265	N/A	158
HTP-0350	TRADITIONAL 3.5" CABINET PULL	91	108	275	N/A	158
HTP-0400	TRADITIONAL 4" CABINET PULL	93	111	282	N/A	158
HTP-0500	TRADITIONAL 5" CABINET PULL	96	115	288	N/A	158
HTP-0600	TRADITIONAL 6" CABINET PULL	98	117	290	N/A	158
HTP-0800	TRADITIONAL 8" CABINET PULL	102	123	292	N/A	158
HTP-1200	TRADITIONAL 12" HEAVY DRAWER PULL	105	129	296	N/A	159
HTP-1201	TRADITIONAL 12" APPLIANCE PULL	275	280	425	N/A	163
HTP-1800	TRADITIONAL 18" APPLIANCE PULL	428	506	698	N/A	163
HTP-2400	TRADITIONAL 24" APPLIANCE PULL	482	565	789	N/A	163
HTP-3000	TRADITIONAL 30" APPLIANCE PULL	598	699	855	N/A	163
9302	INDUSTRIAL 2 HANDLE PULL-DOWN KITCHEN FAUCET EXT. REACH, TOGGLE SPRAYER	1750	1971	2366	2484	59
9402	INDUSTRIAL 2 HANDLE PULL-DOWN KITCHEN FAUCET, TOGGLE SPRAYER	1715	1935	2331	2447	59
9412	INDUSTRIAL 2 HANDLE PULL-DOWN KITCHEN FAUCET, ANGLED SPOUT, TOGGLE SPRAYER	1718	1939	2460	2583	60
9702	INDUSTRIAL 2 HANDLE PULL-DOWN KITCHEN FAUCET, LEVER SPRAY, EXT. REACH, LEVER HANDLE	2117	2446	2599	2728	59
9802	INDUSTRIAL 2 HANDLE PULL-DOWN KITCHEN FAUCET, LEVER SPRAY, LEVER HANDLE	2040	2369	2833	2974	60
9812	INDUSTRIAL 2 HANDLE PULL-DOWN KITCHEN FAUCET, LEVER SPRAY, ANGLED SPOUT, LEVER HANDLE	2014	2343	2496	2620	60
9902	INDUSTRIAL PREP SIZE 2 HANDLE PULL-DOWN KITCHEN FAUCET, TOGGLE SPRAYER	1715	1935	2456	2578	61
9912	INDUSTRIAL PREP SIZE 2 HANDLE PULL-DOWN KITCHEN FAUCET, ANGLED SPOUT, TOGGLE SPRAYER	1722	1943	2456	2580	61
9932	INDUSTRIAL PREP SIZE 2 HANDLE PULL-DOWN KITCHEN FAUCET, LEVER SPRAY, LEVER HANDLE	2040	2369	2514	2639	61
9942	INDUSTRIAL PREP SIZE 2 HANDLE PULL-DOWN KITCHEN FAUCET, LEVER SPRAY, ANGLED SPOUT, LEVER HANDLE	2047	2376	2472	2595	62
10202	FULTON INDUSTRIAL EXTENDED REACH 2 HANDLE PLP FAUCET - TOGGLE SPRAYER	1900	2136	2497	2621	71
10212	FULTON INDUSTRIAL 2 HANDLE PLP PULLDOWN FAUCET - TOGGLE SPRAYER	1866	2102	2522	2648	71

MODEL #	NAME	GRP 1	GRP 2	GRP 3	SS	PAGE
10222	FULTON INDUSTRIAL 2 HANDLE PLP PULLDOWN FAUCET - ANGLED SPOUT- TOGGLE SPRAY	1748	1968	2489	2613	72
10232	FULTON INDUSTRIAL PREP SIZE 2 HANDLE PLP PULLDOWN FAUCET - TOGGLE SPRAYER	1745	1937	2546	2673	73
10242	FULTON INDUSTRIAL PREP SIZE 2 HANDLE PLP PULLDOWN FAUCET - ANGLE SPOUT - TOGGLE SPRAYER	1723	1843	2524	2650	73
10252	FULTON INDUSTRIAL EXTENDED REACH 2 HANDLE PLP FAUCET - LEVER SPRAYER	1890	2203	2518	2643	71
10262	FULTON INDUSTRIAL 2 HANDLE PLP PULLDOWN FAUCET - LEVER SPRAYER	2022	2365	2563	2691	72
10272	FULTON INDUSTRIAL 2 HANDLE PLP PULLDOWN FAUCET - ANGLED SPOUT - LEVER SPRAYER	1936	2265	2477	2599	72
10282	FULTON INDUSTRIAL PREP SIZE 2 HANDLE PLP PULLDOWN FAUCET - LEVER SPRAYER	2025	2326	2566	2694	73
10292	FULTON INDUSTRIAL PREP SIZE 2 HANDLE PLP PULLDOWN FAUCET - ANGLE SPOUT - LEVER SPRAYER	2003	2231	2544	2671	74
9352	MODERN EXTENDED REACH 2 HANDLE PLP PULLDOWN FAUCET - TOGGLE SPRAYER	1763	2288	2496	2650	65
9452	MODERN 2 HANDLE PLP PULLDOWN FAUCET - TOGGLE SPRAYER	1752	2038	2459	2620	65
9462	MODERN 2 HANDLE PLP PULLDOWN FAUCET - ANGLED SPOUT - TOGGLE SPRAYER	1672	1942	2463	2586	66
9752	MODERN EXTENDED REACH 2 HANDLE PLP PULLDOWN FAUCET - LEVER SPRAYER	1847	2160	2475	2598	65
9852	MODERN 2 HANDLE PLP PULLDOWN FAUCET - LEVER SPRAYER	1812	2125	2440	2562	66
9862	MODERN 2 HANDLE PLP PULLDOWN FAUCET - ANGLED SPOUT - LEVER SPRAYER	1816	2129	2444	2566	66
9952	MODERN PREP SIZE 2 HANDLE PLP PULLDOWN FAUCET - TOGGLE SPRAYER	1668	1939	2459	2581	67
9962	MODERN PREP SIZE 2 HANDLE PLP PULLDOWN FAUCET - ANGLED SPOUT - TOGGLE SPRAYER	1676	1946	2467	2590	67
9982	MODERN PREP SIZE 2 HANDLE PLP PULLDOWN FAUCET - LEVER SPRAYER	1812	2125	2440	2562	67
9992	MODERN PREP SIZE 2 HANDLE PLP PULLDOWN FAUCET - ANGLED SPOUT - LEVER SPRAYER	1819	2133	2447	2569	68
10302	FULTON MODERN EXTENDED REACH 2 HANDLE PLP FAUCET - TOGGLE	1759	1980	2501	2626	77

MODEL #	NAME	GRP 1	GRP 2	GRP 3	SS	PAGE
10312	FULTON MODERN 2 HANDLE PLP PULLDOWN FAUCET - TOGGLE SPRAYER	1696	1966	2486	2610	77
10322	FULTON MODERN 2 HANDLE PLP PULLDOWN FAUCET - ANGLED SPOUT - TOGGLE SPRAYER	1702	1972	2492	2616	78
10332	FULTON MODERN PREP SIZE 2 HANDLE PLP PULLDOWN FAUCET - TOGGLE SPRAYER	1699	1941	2490	2614	79
10342	FULTON MODERN PREP SIZE 2 HANDLE PLP PULLDOWN FAUCET - ANGLE SPOUT - TOGGLE SPRAYER	1679	1848	2470	2593	79
10352	FULTON MODERN EXTENDED REACH 2 HANDLE PLP FAUCET - LEVER SPRAYER	1853	2167	2481	2605	77
10362	FULTON MODERN 2 HANDLE PLP PULLDOWN FAUCET - LEVER SPRAYER	1839	2152	2467	2590	78
10372	FULTON MODERN 2 HANDLE PLP PULLDOWN FAUCET - ANGLED SPOUT - LEVER SPRAYER	1845	2158	2473	2596	78
10382	FULTON MODERN PREP SIZE 2 HANDLE PLP PULLDOWN FAUCET - LEVER SPRAYER	1842	2127	2470	2593	79
10392	FULTON MODERN PREP SIZE 2 HANDLE PLP PULLDOWN FAUCET - ANGLE SPOUT LEVER SPRAYER	1821	2033	2449	2571	80
AG210-1	LAV FAUCET & DRAIN W/ OVERFLOW	2392	2683	N/A	N/A	178
AG210-2	LAV FCT & DRAIN W/O OVERFLOW	2485	2776	N/A	N/A	178
AG221-1	THERMO TRIM	3341	3911	N/A	N/A	175
AG254-1	WHEEL SHOWER	5446	6053	N/A	N/A	175
AG231-1	DIVERTER	1277	1515	N/A	N/A	176
AG244-1	WALL MOUNT TUB FILLER	2178	2610	N/A	N/A	177
AG255-1	SLIDE BAR	3827	4218	N/A	N/A	176
AG250-1	WALL MOUNT SHOWER HEAD W/PLATE	3026	3459	N/A	N/A	175
AG245-1	FREESTANDING TUB FILLER	9432	10035	N/A	N/A	176
AG240-1	DECK MOUNT TUB FILLER W/HAND SPRAY	4032	4699	N/A	N/A	177
AG241-1	DECK MOUNT TUB FILLER W/O HAND SPRAY	3487	4400	N/A	N/A	177
AG280-1	LAV DRAIN W/OVERFLOW	190	222	N/A	N/A	178
AG281-1	LAV DRAIN W/O OVERFLOW	190	222	N/A	N/A	178
10120	THERMOSTATIC SHOWER VALVE (ROUGH-IN FOR AG221-1)	848	N/A	N/A	N/A	179

MODEL #	NAME	GRP 1	GRP 2	GRP 3	SS	PAGE
10121	DIVERTER CONTROL VALVE (ROUGH-IN FOR AG231-1)	391	N/A	N/A	N/A	180
10122	WALL MOUNT SHOWER ROUGH-IN (AG250-1, AG254-1)	247	N/A	N/A	N/A	179
10123	FREESTANDING TUB FILLER (ROUGH-IN FOR AG245-1)	890	N/A	N/A	N/A	180
10124	DECK MOUNTED TUB FILLER (ROUGH IN FOR AG240-1)	939	N/A	N/A	N/A	180
10124A	DECK MOUNTED TUB FILLER (ROUGH IN FOR AG241-1)	568	N/A	N/A	N/A	180
AG301-1	ROBE HOOK - SINGLE	498	559	N/A	N/A	179
AG302-1	ROBE HOOK - DOUBLE	624	713	N/A	N/A	179
AG307-1	TOILET PAPER HOLDER	1197	1310	N/A	N/A	178
AG308-1	8" TOWEL BAR	1029	1162	N/A	N/A	178
AG318-2	18" TOWEL BAR	1143	1280	N/A	N/A	178
AG324-1	24" TOWEL BAR	1154	1290	N/A	N/A	178
AG330-1	30" TOWEL BAR	1165	1305	N/A	N/A	178
RS256-1	INDUSTRIAL 8" RAIN HEAD	1053	1180	N/A	N/A	183
RS256-2	INDUSTRIAL 9.5" RAIN HEAD	1210	1335	N/A	N/A	183
RS256-3	INDUSTRIAL 12" RAIN HEAD	1532	1657	N/A	N/A	183
RS256-4	MODERN 8" RAIN HEAD	1040	1167	N/A	N/A	184
RS256-5	MODERN 9.5" RAIN HEAD	1197	1324	N/A	N/A	184
RS256-6	MODERN 12" RAIN HEAD	1520	1646	N/A	N/A	184

UNILATERAL MINIMUM RETAIL PRICE (UMRP)

This policy became effective on January 1st 2017, all distributors and dealers doing business with WATERSTONE on and after that date are bound to the terms and conditions of this policy.

Waterstone Faucets is dedicated to providing our distributors and dealers with the highest quality, most innovative products sold through superior sales and marketing support. With this company objective in mind, Waterstone Faucets is introducing its Unilateral Minimum Retail Price (UMRP) Policy in order to maintain proper positioning of our products in the marketplace, to define guidelines for the use of Waterstone patented, trademarked and copyrighted product and materials, and to solidify and preserve a consistent value for our distributors and dealers.

UNILATERAL POLICY GUIDELINES -

Each distributor and dealer remains free to determine for itself the resale prices at which it will sell and promote its products and each distributor or dealer is free to independently decide whether or not to follow the WATERSTONE UMRP policy. WATERSTONE does not ask for, nor will it accept, any assurance of compliance of agreement from a distributor or dealer regarding the UMRP policy. WATERSTONE is unilaterally implementing the Policy. WATERSTONE will determine whether or not distributors and dealers are in violation of the UMRP policy and will enforce the policy as it is warranted. All Decisions by WATERSTONE to take action for a violation of the UMRP Policy are final. There will be no negotiations.

The UMRP policy applies to discounted products, clearance items and closeouts. Waterstone has a very liberal return and repair policy. Products may be sent to us for repair to return them to their original saleable condition, therefore, the need for clearances and closeouts is unwarranted.

UMRP POLICY TERMS AND CONDITIONS -

WATERSTONE has established a Minimum Advertised Price (MAP) for all products. The Waterstone MAP is calculated at .75 times (25%) off current Waterstone Retail List Price in effect. This means that the advertised "Net Price" to the end user (The Waterstone Retail list price less all discounts, coupons, allowances, and free goods or services offered with Waterstone Products) must not be below the current WATERSTONE MAP. WATERSTONE may engage in monitoring of advertised prices of Product sales in all channels, whether directly or via the use of third parties. Third parties retained by WATERSTONE may engage in monitoring of Product sales by distributors and dealers to verify that the terms of this Policy are being upheld. WATERSTONE reserves the right to change the MAP on 30 days written notice.

The UMRP policy applies to any and all advertisements, quotes, bids, estimates and invoices in all media including, but not limited to, inserts, newspapers, magazines, catalogs, public signage, billboards, and any other print media, television, radio, email, internet websites or other commerce, flyers, posters, coupons, brochures, and use of hypertext transfer protocol or internal links to a web based shopping cart and any other electronic media.

At no time may a distributor or dealer make any statements or other indication on any advertisements that a price below WATERSTONE'S MAP can be obtained by contacting the distributor or dealer, visiting the distributor or dealer showroom, clicking through to another price on a website, or any other means. A distributor or dealer may not use any WATERSTONE name(s), trademark(s), logo(s), patent(s) or products names(s), in a way that is not in accordance with this Policy or violates WATERSTONE'S MAP. This includes all product images, brand logos and any and all copyrighted materials.

VIOLATIONS -

In the event that a distributor or dealer violates this policy:

FIRST VIOLATION – WATERSTONE will notify the offending distributor or dealer in writing of the violation. The distributor or dealer will have ten (10) calendar days to correct the violation of the UMRP Policy and comply with WATERSTONE MAP.

If the distributor or dealer fails to correct the violation within the provided time, WATERSTONE will decrease the discounted price at which the distributor or dealer purchases WATERSTONE products by 10 percent for a period of ninety (90) calendar days. Additionally, WATERSTONE will remove the distributor or dealer from all links and listing on WATERSTONE'S website, and the distributor or dealer will be suspended from all sales programs offered to the distributor or dealer including but not limited to rebates, early pay incentives, freight programs, and sales incentives. If at the end of the 90 day suspension period the distributor or dealer has complied with the policy and not otherwise violated the MAP, then the distributor or dealer will be reinstated to full status, and the suspended distributor or dealer programs will be re-started.

However, if the distributor or dealer continues to be in violation of the UMRP policy at the end of the ninety (90) day suspension period, it will be considered a second violation.

SECOND VIOLATION – At this time all pending orders will be immediately cancelled, and WATERSTONE will not accept any new orders. WATERSTONE will notify the distributor or dealer in writing and at its own discretion and without liability under any existing contracts or agreements, initiate the process to terminate the distributor or dealer authorization to sell WATERSTONE products.

TERMS AND CONDITIONS

PAYMENT TERMS:

Regular payment terms are Net 30 days, DOI with credit approval. Waterstone also accepts payments made by VISA, MASTERCARD, AMERICAN EXPRESS and DISCOVER credit cards. Starting October 1, 2022 – If you choose to pay your invoice(s) with a credit card, you'll be charged a 3% surcharge. We do not accept debit card payments.

Waterstone shall have the option to charge 1½% interest on all past due accounts monthly. In the event of legal action to collect any past due amounts, the buyer shall be responsible for all attorney collection fees, court costs or other fees reasonable and proper for such collection(s).

FREIGHT:

All orders are F.O.B. Murrieta, CA. In general, all goods are shipped UPS ground unless otherwise specified by the customers Purchase Order. Shipments that can be consolidated to a pallet size may be shipped via common carrier. Customer preferred shippers or method of shipment will be accommodated providing such preference is listed on the customers Purchase Order.

PRICING:

All prices and terms are subject to change without notice.

CLAIMS:

All claims for shortages or damages must be made within ten (10) days from receipt of merchandise. Claims for merchandise delivered damaged must be filed with the delivery carrier within 7 days. Request an immediate inspection by the carrier.

RETURNS:

All returns are subject to the terms and conditions of the Waterstone warranty. A RETURNED GOODS AUTHORIZATION number (RGA #) must be obtained by the customer from the Waterstone Customer Care Department prior to any merchandise return. The RGA # must appear on the return packing slip/document and a copy of the approved pending RGA form must be in the box with the returned unit. Upon inspection, Waterstone, at its option will either repair or replace the item if the defect falls under the guidelines of the warranty. New, unused and sealed merchandise in its original packaging of current design purchased within the last 12 months that is accepted by the Company for return is subject to a 35% restocking charge. If the product returned is damaged by the recipient or damaged in transit for return, Waterstone has the right to rescind the restock fee and charge up to the full purchase price of the unit. All credits provided for returned product or otherwise are only valid for 90 days from date of approval and issue by Waterstone. If unused by the recipient after 90 days the credit is null and void, and the RGA product will not be returned. Credits can only be used for Waterstone merchandise.

DEFAULT:

If a customer is in default under any order of contract with Waterstone, or if Waterstone at any time shall not be satisfied with its customer's financial condition or responsibility, Waterstone shall have the right, without prejudice, to legal remedy including suspending deliveries until such default or condition is remedied.

TITLE:

All merchandise is sold subject to these conditions and shall remain the property of Waterstone until paid for in full, with the provision that all risk of loss or damage to merchandise is assumed by the customer.

LIMITED LIFETIME FUNCTIONAL WARRANTY

Since 1999, Waterstone has manufactured the highest quality kitchen faucets in the USA. We support our workmanship with a Limited Lifetime Functional Warranty. All Waterstone products manufactured by Waterstone carry a Limited Lifetime Guarantee against functional defects in material or workmanship in a residential application. Waterstone products will be free from defects in material and manufacturing workmanship, however, any damage due to improper installation, product abuse, product misuse, improper maintenance, alterations or accidents by a contractor, service company, or homeowner, are excluded from this warranty. Proof of purchase, from the original consumer, must accompany all warranty claims.

In the event of a problem with the product, Waterstone has the option to repair or replace the defective part/product, at our discretion, and may require the product be returned for inspection. If the product should develop any leaks or functionality issues, Waterstone will provide the necessary parts, at no cost, in order to return the faucet to fully functional condition.

Waterstone is not responsible for any labor charges incurred by the purchaser to repair, replace, install or remove the product(s). Waterstone is not responsible for any indirect, incidental or consequential damages, losses, injury or costs, of any nature, relating to the product, except as provided by law. This warranty is in lieu of and excludes all other warranties, conditions and guarantees, whether expressed or implied, statutory or otherwise, including, without restriction, those of merchantability or of fitness for use.

This warranty is valid only when products are purchased through an Authorized Waterstone Dealer/Distributor. Waterstone will not honor this warranty if the products are purchased from any unauthorized dealer, third-party vendor or online seller. The warranty applies to Waterstone faucets installed in the United States of America, Canada and Mexico only.

Products not manufactured by Waterstone, but distributed by Waterstone will carry only the original manufacturer's warranty.

WARNING - Since 2005, Waterstone has continued to advise all of our customers against the installation of any brand of in-line water chiller unit with our faucets. Compressor style chiller units have been proven to arbitrarily exceed the standard household in-line pressure ratings, causing the faucet inlet connection line to burst and create the potential for water damage claims in the field.

INSTALLATION OR USE OF AN IN-LINE WATER CHILLER WITH A WATERSTONE FAUCET, OF ANY KIND, WILL VOID THE WARRANTY.

Waterstone will only recommend the installation of a water chiller in the vented side (in place of a hot tank) with one of our Hot Only or Hot and Cold Filtration Faucet models.

This warranty gives you specific legal rights, and you may also have other rights which vary from state/province to state/province. The above limitations or exclusions may not apply to you.

ORDER FULFILLMENT POLICY

1. The customer's order will be entered into the order fulfillment system on the day the order is received, providing the order is received by 2pm Pacific Standard Time.
2. An order confirmation will be faxed or emailed to the customer within one working day of the entry of the order into the order fulfillment system. The order confirmation will contain anticipated ship date information and a listing of all items and the customer's cost pricing of these items.
3. The factory will endeavor to ship all orders received as quickly and completely as possible in a single shipment.
4. The factory will ship a customer's order complete whenever the customer places such a request in the body of their purchase order. Without this specific written request, Waterstone will ship partial shipments as they become available.

DROP SHIP POLICY

WATERSTONE DROP SHIPMENT OUT OF REPRESENTATIVES REGION POLICY

1. Waterstone is committed to keeping our direct customers "selling field" as level and even as possible. Our customers invest in product displays, inventory, training of their sales staff, etc. Therefore, we wish to assist our customer's efforts to obtain excellent margins when selling our products.
2. Waterstone will accept all orders from our direct purchase customers in qualified credit status and ship those orders to the customer's immediate local trading area. Any customer may certainly re-ship our product(s) after they receive them at their location of business.
3. We will drop ship our product(s) for our direct purchase customer(s) within the geographic boundaries of their assigned Representatives Selling Region. We will not drop ship outside of these areas.

For warranty claims or replacement parts, contact Waterstone customer service:

1-888-304-0660

support@waterstoneco.com

Hours are from 6:00am to 5pm PST

Waterstone Faucets, LLC
41180 Raintree Court
Murrieta, CA 92562

CARE AND CLEANING

ATTENTION: Waterstone offers many finishes for its products. Every finish is unique and requires different techniques for care and cleaning. Find your product's finish in the sections below, and carefully read and follow directions for that finish.

CLEAR PROTECTIVE COATED FINISHES

ABOUT YOUR FINISH:

These finishes have a clear protective coating on them. Even though they have a protective coating, they are only considered semi-durable. If the outside clear coating is scratched or damaged in any way, the base metal finishes exposed will oxidize. Always wipe your fixture down with a clean soft cloth and keep it clean and dry after use.

CLEANING CAUTION:

Never use cleaners with bleach, abrasives, vinegar or acidic organic cleansers. Never use any type of abrasive pad, cloth or sponge. This can remove or dull the protective coating and damage the finish.

IMPORTANT NOTICE:

It is the responsibility of the customer to check for any material finish defects **BEFORE** installation.

SUGGESTED FINISH MAINTENANCE PROCEDURE:

1. Do not allow water spots to dry on the fixture. Keep the surface clean and dry after use.
2. Periodic cleaning can be done by using a mild diluted glass cleaner (we recommend Windex). Apply the mild cleaner to a soft clean cloth, and periodically wipe your fixture down to remove water spots and surface debris.

Antique Brass - AB
 Antique Copper - AC
 American Bronze - AMB
 Antique Pewter - AP
 Chardonnay - CD
 Classic Bronze - CLZ
 Dist. Antique Brass - DAB
 Dist. Antique Copper - DAC
 Dist. American Bronze - DAMB
 Dist. Antique Pewter - DAP
 Matte Antique Brass - MAB
 Matte Antique Copper - MAC
 Matte Antique Pewter - MAP
 Polished Brass - PB
 Polished Copper - PC
 Satin Brass - SB
 Satin Nickel - SN

POWDER COATED FINISHES

ABOUT YOUR FINISH:

These finishes are powder coated color finishes. They have **NO ADDITIONAL PROTECTIVE COATING**. These finishes are not considered durable finishes and can be scratched, chipped or scuffed. If the exterior color coating is damaged, the exposed metal base will oxidize. Always wipe your fixture down with a clean soft cloth and keep it clean and dry after use.

CLEANING CAUTION:

Never use cleaners with bleach, abrasives, vinegar or acidic organic cleansers. Never use any type of abrasive pad, cloth or sponge. This can remove, dull or damage the finish.

IMPORTANT NOTICE:

It is the responsibility of the customer to check for any material finish defects **BEFORE** installation.

SUGGESTED FINISH MAINTENANCE PROCEDURE:

1. Do not allow water spots to dry on the fixture. Keep the surface clean and dry after use.
2. Periodic cleaning can be done by using a mild diluted glass cleaner (we recommend Windex). Apply the mild cleaner to a soft clean cloth, and periodically wipe your fixture down to remove water spots and surface debris.
3. Never use cleaners with bleach, abrasives, or vinegar. Never use any type of abrasive pad or sponge.

Chocolate Bronze - CHB
 Graphite - GR
 Matte Black - MB
 Matte White - MW

CARE AND CLEANING

LIVING FINISHES

ABOUT YOUR FINISH:

These finishes are considered Living Finishes and have **NO PROTECTIVE COATING** on them. Living finishes are finishes that have a very shallow patina on their surface. Essentially, the finish is what nature would do to the surface over a long period of time. The finishes are intended to change with time and generally darken slightly where they are not being touched, and highlight where the high use points are on the fixture. These finishes are not durable, and are easily scratched or scuffed. Waterstone initially applies a wax to the finish surface to help protect and prevent the finish from exposure to air and oxidizing prior to installation.

CLEANING CAUTION:

Never use cleaners with bleach, abrasives, vinegar or acidic organic cleansers. In addition, hand oils, soaps, and acidic fluids can damage the finish. Never use any type of abrasive pad, cloth or sponge. This can remove, dull or damage the finish.

IMPORTANT NOTICE:

It is the responsibility of the customer to check for any material finish defects **BEFORE** installation. Waterstone does not warranty these finishes **AFTER** the fixture has been installed.

SUGGESTED FINISH MAINTENANCE PROCEDURE FOR ANTIQUE BRONZE, CARIBBEAN BRONZE, TUSCAN BRONZE AND UNLACQUERED POLISHED BRASS:

1. Do not allow water spots to dry on the fixture. Keep the surface clean and dry after use.
2. Periodic cleaning can be done by using a micro-crystalline wax (we recommend Renaissance Wax). Apply the wax with a soft non-abrasive tissue paper, and gently buff the wax with a soft clean cloth to help remove surface spots and add a protective coating to the finish.

SUGGESTED FINISH MAINTENANCE PROCEDURE FOR BLACK-OIL RUBBED BRONZE

1. Do not allow water spots to dry on the fixture. Keep the surface clean and dry after use.
2. Periodic cleaning can be done by applying mineral oil to a clean soft cloth and gently wiping down the finish surface to clean. Make sure not to rub too hard, in that you can remove too much of the surface patina surface with aggressive cleaning.
3. Once the mineral oil has been applied, with a clean soft dry cloth gently pat the finish surface to remove any excess oil on the fixture until the fixture no longer looks "wet".

*Antique Bronze - ABZ
Black-Oil Rubbed Bronze - ORB
Caribbean Bronze - CB
Tuscan Brass - TB
Unlacquered Polished Brass - UPB*

CARE AND CLEANING

PLATED FINISHES: CHROME / POLISHED NICKEL

ABOUT YOUR FINISH:

Polished Nickel is one of the most durable finishes Waterstone offers. The best general maintenance is regular cleaning. Always try and keep your finishes clean and dry. Trapped moisture on the surface of your finish can lead to staining. Nickel plated finishes are very tarnish resistant. However, they will tarnish over time from hand oils and exposure if not regularly cleaned and polished. They are not indestructible and can be scratched and marred.

CLEANING CAUTION:

Never use cleaners with bleach, abrasives, vinegar or acidic organic cleansers. Never use any type of abrasive pad, cloth or sponge. This can remove or dull the protective coating and damage the finish.

IMPORTANT NOTICE:

It is the responsibility of the customer to check for any material finish defects **BEFORE** installation.

SUGGESTED FINISH MAINTENANCE PROCEDURE:

Cleaning Supplies: isopropyl alcohol, Microfiber cloth.

1. Do not allow water spots to dry on the fixture. Keep the surface clean and dry after use.
2. Periodic cleaning can be done by applying isopropyl alcohol with a soft clean cloth to gently remove surface spots.

SUGGESTED PROCEDURE FOR CLOUDY, TARNISHED OR WATER SPOTTED FIXTURES:

Cleaning Supplies: Simichrome polish, Microfiber cloth (2), (Optional: Flitz Faucet Wax)

1. Prepare the location by following the maintenance procedure listed above
2. In a well ventilated area apply a small amount of polish to the trouble spot on the faucet.
3. Using the microfiber cloth polish until cloth turns black or trouble spot is removed, take care to remove all excess polish.
4. Buff Surface with clean microfiber cloth to a brilliant luster.
5. (Optional) Using clean cloth apply Flitz faucet wax to all areas and let dry to a haze
6. (Optional) Buff wax until haze is gone.

*Chrome - CH
Polished Nickel - PN*

PLATED FINISHES: BLACK NICKEL / SATIN CHROME

ABOUT YOUR FINISH:

These finishes are the most durable finishes Waterstone offers. The best general maintenance is regular cleaning. Trapped moisture on the surface of your finish can lead to staining. Chrome plated finishes are very tarnish resistant. However, they are not indestructible and can scratch and mar.

CLEANING CAUTION:

Never use cleaners with bleach, abrasives, vinegar or acidic organic cleansers. Never use any type of abrasive pad, cloth or sponge. This can remove or dull the protective coating and damage the finish.

IMPORTANT NOTICE:

It is the responsibility of the customer to check for any material finish defects **BEFORE** installation.

SUGGESTED FINISH MAINTENANCE PROCEDURE:

1. Do not allow water spots to dry on the fixture. Keep the surface clean and dry after use.
2. Periodic cleaning can be done by using a mild diluted glass cleaner (we recommend Windex). Apply the mild cleaner to a soft clean cloth, and periodically wipe your fixture down to remove water spots and surface debris.

*Black Nickel - BLN
Satin Chrome - SC*

CARE AND CLEANING

316 MARINE GRADE STAINLESS STEEL

ABOUT YOUR FINISH:

Waterstone's stainless steel fixtures are actually made of solid 316 stainless steel. This finish has **NO PROTECTIVE COATING** on it. Stainless steel is by its material nature very tarnish resistant, but by no means tarnish or stain proof. This finish will indeed oxidize naturally over time and react to its environment, and in a reaction to some chemical cleaners that have bleach in them rusting can be induced on the finish. Keep your stainless fixture wiped clean and dry, and use only a cleaner specifically made for stainless steel. Trapped moisture on the surface of your finish can lead to staining.

Stainless Steel - SS

CLEANING CAUTION:

Never use cleaners with bleach, abrasives, vinegar or acidic organic cleansers. Never use any type of abrasive pad, cloth or sponge. This can remove, dull or damage the finish.

IMPORTANT NOTICE:

It is the responsibility of the customer to check for any material finish defects **BEFORE** installation.

SUGGESTED FINISH MAINTENANCE PROCEDURE:

1. Do not allow water spots to dry on the fixture. Keep the surface clean and dry after use.
2. Periodic cleaning can be done by applying a "stainless steel cleaner" with a soft clean cloth to gently remove surface spots and brighten the finish.

PRECIOUS METALS

ABOUT YOUR FINISH:

These finishes are made with real precious metal gold plating on top of the brass fixture surface. These finishes are considered Living Finishes, have **NO PROTECTIVE COATING** and are extremely soft. Some or all of the gold plating will be removed if any type of polish is used. Additionally, the finish will wear away with time. The gold plating is considered very delicate and can be easily scratched or scuffed.

*Polished Gold - PG
Satin Gold - SG*

CLEANING CAUTION:

Never use cleaners with bleach, abrasives, vinegar or acidic organic cleansers. Never use any type of abrasive pad, cloth or sponge. This can remove, dull or damage the finish.

IMPORTANT NOTICE:

It is the responsibility of the customer to check for any material finish defects **BEFORE** installation. Waterstone does not warranty these finishes **AFTER** the fixture has been installed.

SUGGESTED FINISH MAINTENANCE PROCEDURE:

1. Do not allow water spots to dry on the fixture. Keep the surface clean and dry after use.
2. Periodic cleaning can be done with mild liquid soap only. Wipe gently with a soft cloth to clean.

FINISH WARRANTIES

For a warranty claim for finish, a valid dated bill of sale or receipt from purchase must accompany any warranty request. This warranty is for normal wear and tear of finish surface, the warranty will be void for unintended use damage, lack of cleaning or improper cleaning and maintenance techniques directly resulting in a damaged finish.

LIFETIME WARRANTY

Waterstone carries a lifetime warranty on the following finishes:

Chrome - CH
Stainless Steel - SS

7 YEAR WARRANTY

Waterstone carries a 7 year warranty for the original purchaser from the date of sale. Warranty applies to normal wear for the following finishes:

Antique Brass - AB
Antique Copper - AC
American Bronze - AMB
Antique Pewter - AP
Black Nickel - BLN
Chardonnay - CD
Chocolate Bronze - CHB
Classic Bronze - CLZ
Distressed Antique Brass - DAB
Distressed Antique Copper - DAC
Distressed American Bronze - DAMB
Distressed Antique Pewter - DAP
Graphite - GR
Matte Antique Brass - MAB
Matte Antique Copper - MAC
Matte Antique Pewter - MAP
Matte Black - MB
Matte White - MW
Polished Brass - PB
Polished Copper - PC
Polished Nickel - PN
Satin Brass - SB
Satin Chrome - SC
Satin Nickel - SN

NO WARRANTY

Waterstone does not offer a warranty on living or gold finishes. The rate of deterioration will vary either from exposure to chemicals, perspiration, climate conditions, or other factors. Tarnishing or excessive wear of these finishes is therefore, not a defect, but a normal process, which is unavoidable. Under these circumstances, products will not be repaired or replaced under warranty for normal tarnishing or wear finishes.

Antique Bronze - ABZ
Caribbean Bronze - CB
Black-Oiled Rubbed Bronze - ORB
Polished Gold - PG
Satin Gold - SG
Tuscan Brass - TB
Unlacquered Polished Brass - UPB

SPLIT FINISHES

Standard split finish warranty applies to the lesser of the two warranties.

Chrome - CH
Chardonnay - CD
Classic Bronze - CLZ
Matte Black - MB
Matte White - MW
Polished Brass - PB
Polished Nickel - PN
Satin Brass - SB
Satin Nickel - SN
Stainless Steel - SS
Unlacquered Polished Brass - UPB

Custom split finishes have no finish warranty and are not eligible for returns.

FINISH GROUPS

GROUP 1 - STANDARD FINISHES

Chrome **CH**

GROUP 2 - SPECIALTY FINISHES

Black Nickel **BLN**
 Chardonnay **CD**
 Chocolate Bronze **CHB**
 Classic Bronze **CLZ**
 Graphite **GR**
 Matte Black **MB**
 Matte White **MW**
 Polished Brass **PB**
 Polished Nickel **PN**
 Satin Brass **SB**
 Satin Chrome **SC**
 Satin Nickel **SN**
 Unlacquered Polished Brass **UPB**

GROUP 3 - ARTISAN FINISHES

Antique Brass **AB**
 American Bronze **AMB**
 Antique Bronze **ABZ**
 Antique Copper **AC**
 Antique Pewter **AP**
 Black Oiled Rubbed Bronze **ORB**
 Caribbean Bronze **CB**
 Distressed Antique Brass **DAB**
 Distressed Antique Copper **DAC**
 Distressed American Bronze **DAMB**
 Distressed Antique Pewter **DAP**
 Matte Antique Brass **MAB**
 Matte Antique Copper **MAC**
 Matte Antique Pewter **MAP**
 Polished Copper **PC**
 Tuscan Brass **TB**

316 MARINE GRADE STAINLESS STEEL

Stainless Steel **SS**

PRECIOUS METALS

Polished Gold **PG**
 Satin Gold **SG**

SPLIT FINISHES

Choose a primary and accent finish to create a two-tone faucet on select products. Create any combination of the finishes we offer for that faucet.

Standard split finishes are +10% of higher group price.
 Custom-designed split finishes are +40% of the higher group price.

LIVING FINISHES

Waterstone does not offer a warranty on living or gold finishes. The rate of deterioration will vary either from exposure to chemicals, perspiration, climate conditions, or other factors. Tarnishing or excessive wear of these finishes is, therefore, not a defect, but a normal process, which is unavoidable. Under these circumstances, products will not be repaired or replaced under warranty for normal tarnishing or wear finishes. Living finishes include:

- Antique Bronze**
- Black Oiled Rubbed Bronze**
- Caribbean Bronze**
- Tuscan Brass**
- Unlacquered Polished Brass**

GROUP 1



Chrome

STAINLESS STEEL



316 Stainless Steel

PRECIOUS METALS



Polished Gold



Satin Gold

GROUP 2



Black Nickel



Chocolate Bronze



Classic Bronze



Graphite



Matte Black



Matte White



Polished Brass



Polished Nickel



Satin Brass



Satin Chrome



Satin Nickel



Unlacquered Polished Brass*



Chardonnay

GROUP 3



Antique Brass



American Bronze



Antique Bronze*



Antique Copper



Antique Pewter



Black Oil Rubbed Bronze*



Caribbean Bronze*



Distressed Antique Brass



Distressed Antique Copper



Distressed American Bronze



Distressed Antique Pewter



Matte Antique Brass



Matte Antique Copper



Matte Antique Pewter



Polished Copper



Tuscan Brass*



SPLIT FINISHES AVAILABLE

* Living finish



MADE IN THE USA
★
SINCE 1988



P.O. BOX 1240 TEMECULA, CA 92593
888-304-0660 | www.waterstoneco.com

