

Optimize your
regrind, lower costs

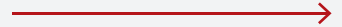

MCS Regrind

A sustainable and cost saving solution. Its unique closed-loop system automatically adjusts regrind and masterbatch dosing, ensuring optimal material efficiency and consistent product quality.

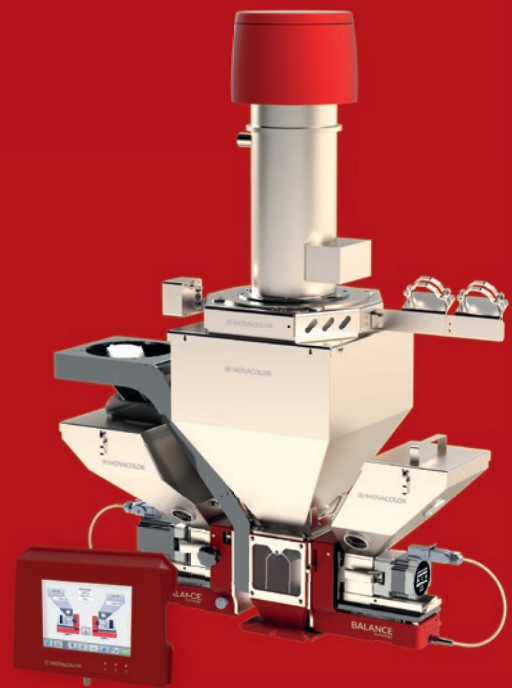

M | **MOVACOLOR**
modular dosing solutions

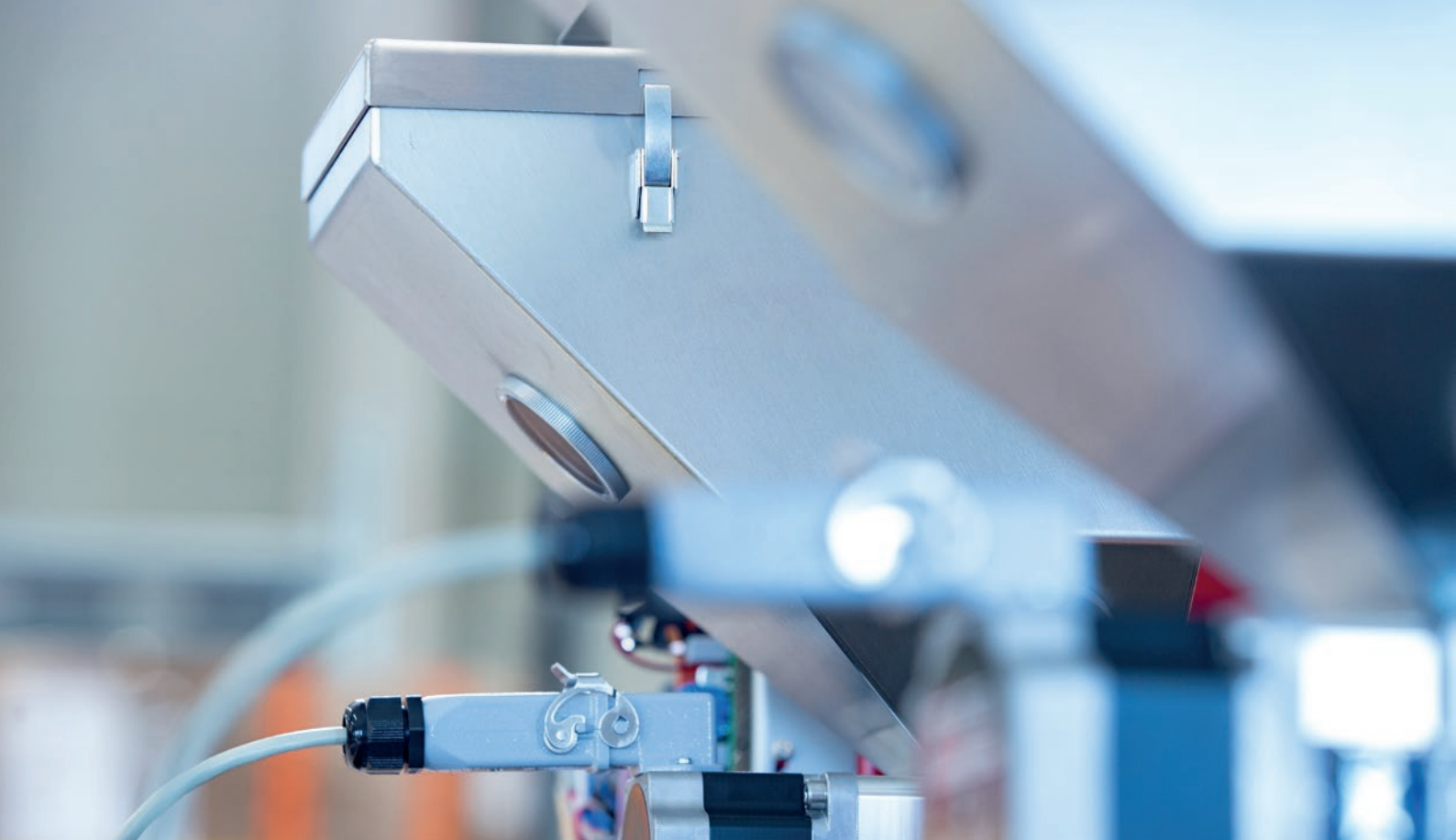

The Movacolor modular blending, dosing and measuring concept

Our mission is to support plastics producers in achieving their sustainability goals. We do this through our unique modular blending, dosing and measuring concept. This concept ensures plastics manufacturers can easily reduce waste, process recycled material and save costs.

Our solutions have an intuitive design and are made from robust stainless steel, making them endure throughout the years. Our solutions effortlessly integrate with Industry 4.0 technologies, allowing you to make your entire production line work together.

Our modular design allows flexibility in evolving needs by providing configuration possibilities, which helps us tailor our solutions to align with diverse plastics production processes.

Why Movacolor

- ✔ 35+ years of experience and knowledge in plastics blending, dosing and measuring
- ✔ 5 year warranty
- ✔ In-house engineering department
- ✔ Short delivery times
- ✔ Global product support
- ✔ Designed and assembled in the Netherlands

The MCS Regrind

The MCS Regrind is an advanced dosing system designed to simultaneously incorporate regrind material - such as rejects and sprues - and additives like colorants into the production process. Using Movacolor's gravimetric dosing technology, it features a dual-unit configuration where one unit doses regrind and the other doses additives. This setup ensures continuous loss-in-weight measurement and automatic adjustment of dosing rates, optimizing material usage while maintaining consistent product quality.



High-end stepper motors

Strong and removable motors for consistent feeding, minimum downtime, easy cleaning and quick dosing tool change.

Weighing frame

Welded steel weighing frame with single-point loadcell for accurately measuring the entire system.



(Optional) slide mechanism

Enabling efficient material calibration and cleaning.

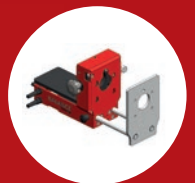

Balance-series dosing tools

Unique range of dosing cylinders and augers guaranteeing highest accuracy for each material and throughput.

Stainless-steel hopper with integrated dosing house

For maximum durability and minimum contamination of your material. Equipped with sight-glasses for checking material level.

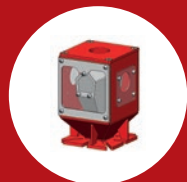

Unique neckpiece and insert

Static mixing and inline dosing for optimal material flow and blend homogeneity. Able to accommodate 6 feeders.

Discharge valve and dosing unit hand knob release

Enabling easy material change, maintenance and quick installation.



PTC

Intuitive 8" touchscreen with modern functionalities, able to manage up to 15 gravimetric solutions at multiple lines from one control screen.



Scan the QR code to find out more!

MCS Regrind: how it started

We saw that manufacturers often face challenges with high material costs and sustainability due to inefficient handling of regrind materials and overconsumption of expensive additives or colorants.

Traditional dosing systems struggle to adjust additive dosing based on the fluctuating availability of regrind material.

This inefficiency leads to increased production costs, waste of valuable additives, and a larger environmental footprint. Additionally, inconsistent use of regrind can compromise product quality, making it difficult to achieve both economic and sustainability goals.

MCS Regrind: the solution

The MCS Regrind addresses these challenges by automatically adjusting the dosing of additives in real-time according to the availability of regrind material.

Its innovative dual-unit system works in tandem: as more regrind becomes available, the system reduces the amount of additive used, ensuring optimal material consumption. Whether operating in closed-loop mode - feeding regrind directly from a grinder -

or in open-loop mode - drawing from a larger regrind storage tank - the MCS Regrind maximizes the use of regrind, minimizes additive waste, and maintains consistent product quality.

This fully automatic process not only reduces material costs but also supports sustainable production practices by reusing the maximum amount of regrind and preventing overconsumption of additives.



MCS Re grind benefits



Dose simultaneous, save costs

Efficiently dose masterbatch and regrinds simultaneously, significantly reducing material costs. Advanced and unique algorithms automatically adjust the dosing of additives or colorants based on the availability of re grind material.



Specialized re grind processing

Engineered for challenging materials, the MCS Re grind features high-torque motors, specialized augers, and neckpiece inserts that ensure smooth processing. Inline dosing prevents material layering and guarantees a homogenous blend, delivering consistent product quality.



Sustainable production

Maximize the use of re grind while minimizing the consumption of expensive additives or colorants. Unique dosing algorithms ensure optimal re grind usage, contributing to more sustainable production practices.



Cost-effective solution

In the area of 3-component systems, the MCS Re grind is a more advantageous investment compared to traditional batch blenders. It offers superior benefits, increased efficiency, and a faster return on investment.



Closed-loop re grind handling

Process up to 90% re grind directly in the production process, eliminating the need for re-drying and maximizing savings on additives. This closed-loop system ensures that granulated materials are seamlessly reintegrated.



Precision through balance technology

A single-point load cell ensures precise material measurement, tracking each shot dispensed and quickly adapting to changes in setpoints or material bulk density. This innovation maintains exceptional accuracy, even in high-vibration environments and at extremely low shot weights.



Compact design with minimal footprint

The compact size of MCS Re grind offers a significant space-saving advantage over traditional batch blenders. Sprues from the injection molding process are directly re-fed into the production cycle, eliminating the need for large intermediate storage hoppers.



Stop overdosing

Unlike conventional feeding screws that require 10-20% overdosing, our dosing cylinders provide pulse-free, highly accurate dosing for a wide range of materials and throughput capacities, effectively eliminating material waste.

Sustainable production and cost savings with MCS Regrind

Imagine the following situation; Jason, a toy manufacturer, produces colorful toy cars with a shot weight of 100 grams. Each car uses 80 grams of virgin material and 20 grams of colorant. After production, a small amount of plastic waste, called sprue, is left over - around 10 grams for every toy car produced. While this waste may seem

small, it quickly adds up. Jason wants to reduce waste, lower costs, and make his production process more sustainable, but he's unsure how to reuse the material without affecting product quality. By using MCS Regrind, Jason can reintegrate the 10 grams of sprue into his production mix. Here's how it works:

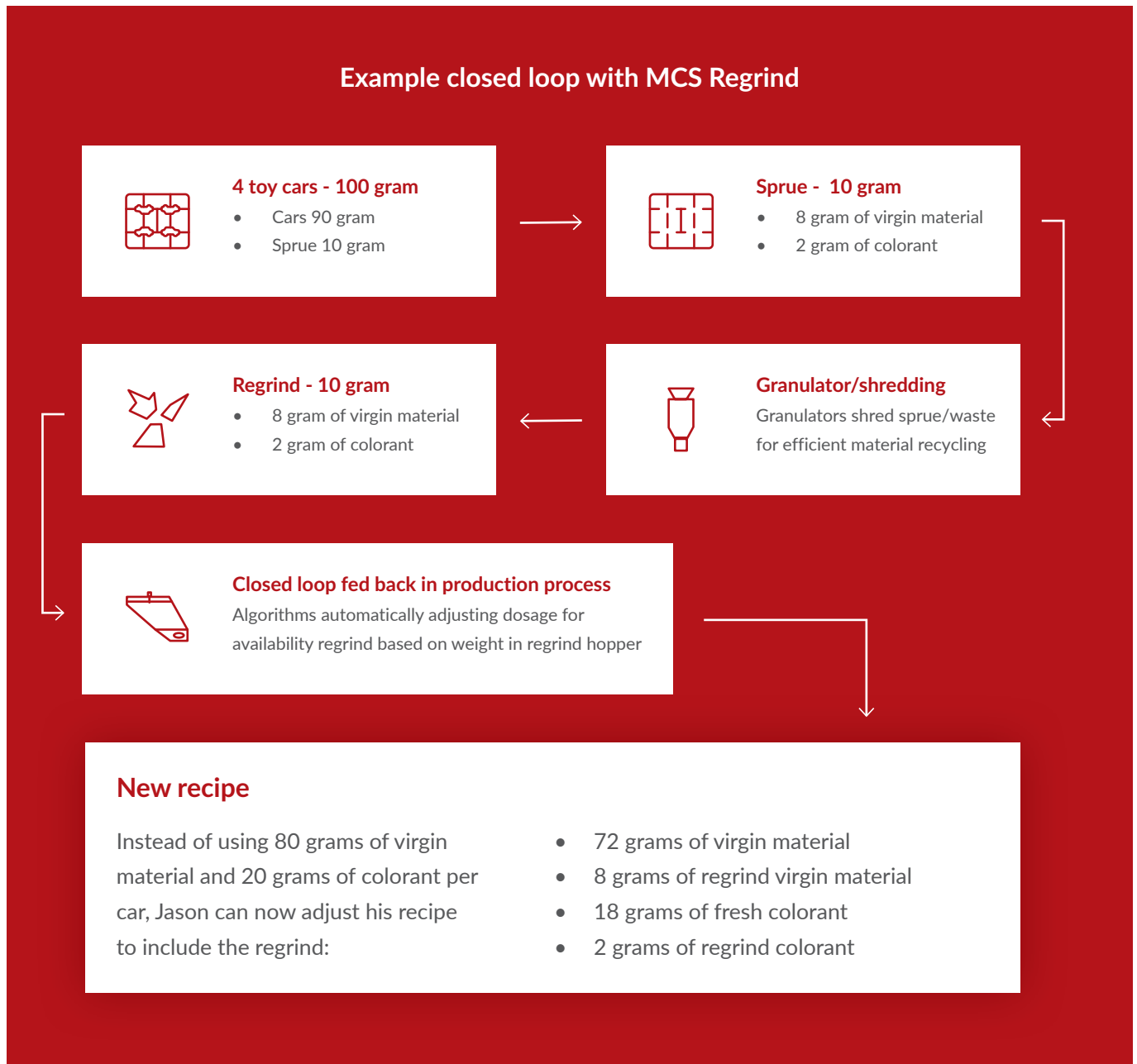

This results in:

- ✔ Lower production costs, as less virgin material is needed
- ✔ A more sustainable production cycle by cutting down on plastic waste

- ✔ No loss in quality for the final product

Thanks to MCS Regrind, Jason's production is now more sustainable, cost-efficient, and environmentally friendly.

Which process is right for your production line?

In-house recycling offers two primary approaches - direct and indirect.

Understanding how they function and their benefits can help you optimize your recycling efforts.

Direct recycling

In direct recycling, waste is handled immediately at the production site. The leftover material from the injection molding or extrusion process is ground directly at the machine using a grinder. This shredded plastic is automatically fed back into the production process, making it a closed-loop system. The recycling is instant, continuous, and requires minimal human intervention, reducing material waste and streamlining production.

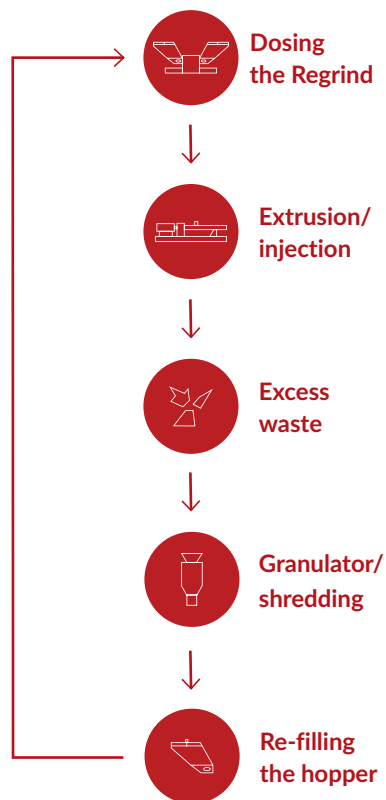

Benefit

Quick, closed-loop, minimal human oversight

Indirect recycling

In contrast, indirect recycling involves centralized waste collection. Residual material from various production machines is gathered in a central container and then transported to a central shredding area. Once shredded, the material is processed separately into an end product, often requiring additional steps.

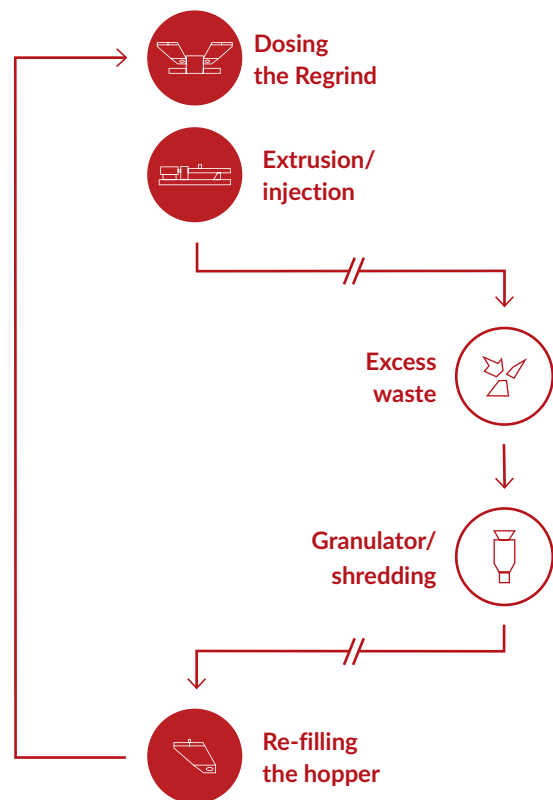

Benefit

Centralized, scalable, versatile

Solution

Both direct and indirect recycling have their advantages. Choosing the right approach depends on the scale of your operation, your production processes, and your sustainability goals.

Specifications

Feeding capacity	0.07 – 180 kg/h*
Max capacity of neckpiece	5.300 kg/h
Max percentage of additive	98%
Motor	LT: 0-200 rpm / HT: 0-200 rpm
Power supply	95-250 VAC, 50/60 Hz – by integrated automatic voltage selector. 300 watt maximum
Hopper capacity	6, 12 or 15 liter
Controller	PTC 8"full-color touchscreen
Processes	Injection molding, blow molding, extrusion
Materials	Granular, regrind, liquid, powder
Max material temperature	70° Celsius
Mounting and feeding	Neckpiece directly mountable on machine throat
Output signals	Hopper loader control, 2x 0-10 VDC or 4-20 mA Warning, 24 VDC 0.5A max Run, 230 VAC / 30 VDC 5A max Alarm, 230 VAC / 30 VDC 5A max
Input signals	Injection molding Timer mode: start dosing: 24 VDC or potential free Relay: start/stop dosing: 24 VDC or potential free Extrusion Tacho synchronization: 0-30 VDC Relay: start/stop dosing: 24 VDC or potential free Main material hopper sensor (1x) 24 VDC
Technology	Continuous loss-in-weight measuring and automatic material calibration
Dosing tools	Multiple augers and dosing cylinders
Recipes storage function	Max 1.000
Alarm function	Configurable alarms
Smart monitoring and reporting	Comprehensive logging, alarming, reporting and recipe management
Connectivity	Modbus TCP/IP, ProfiBus, ProfiNet, OPC UA, USB, remote support
Weight	18,7 kg (feeder) / 3,6 kg (controller)

*The maximum throughputs mentioned in our product leaflets and on our website are based on granular material with a bulk density of 0.8 kg/l and the most ideal materials, conditions, settings, and mix percentages.

MCS Regrind dimensions

MCS Regrind with ME Hopper loader

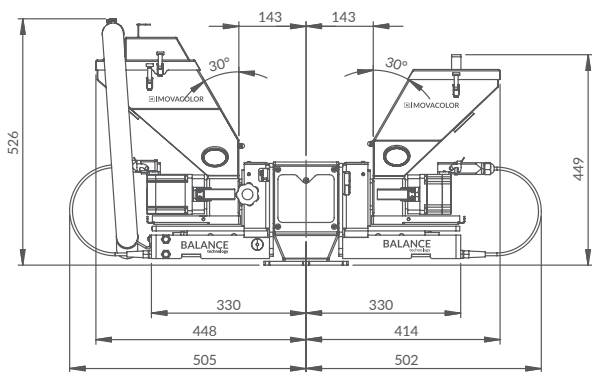

Left side

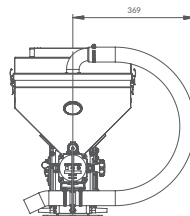

Right side

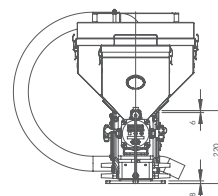

Top

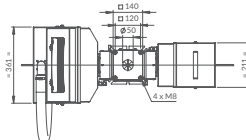

Bottom

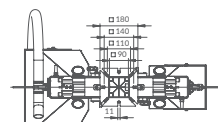

MCS Regrind with MFD Hopper loader

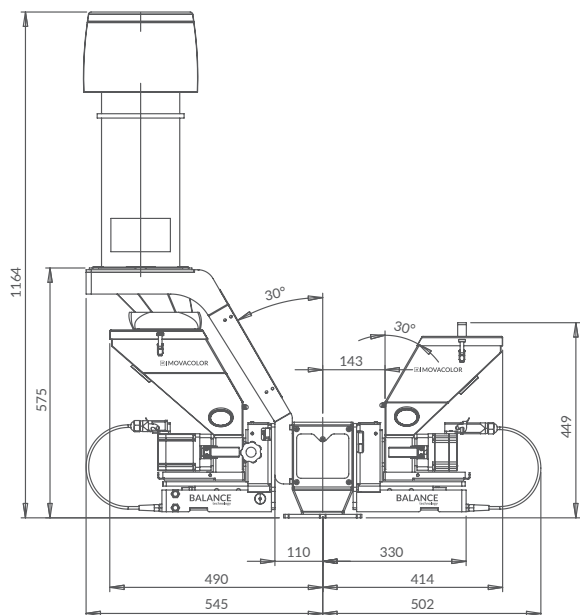

Left side

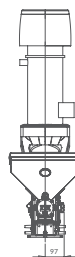

Right side

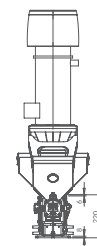

Top

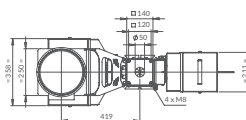

Bottom

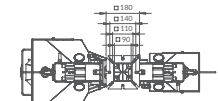

Optimize your additive dosing

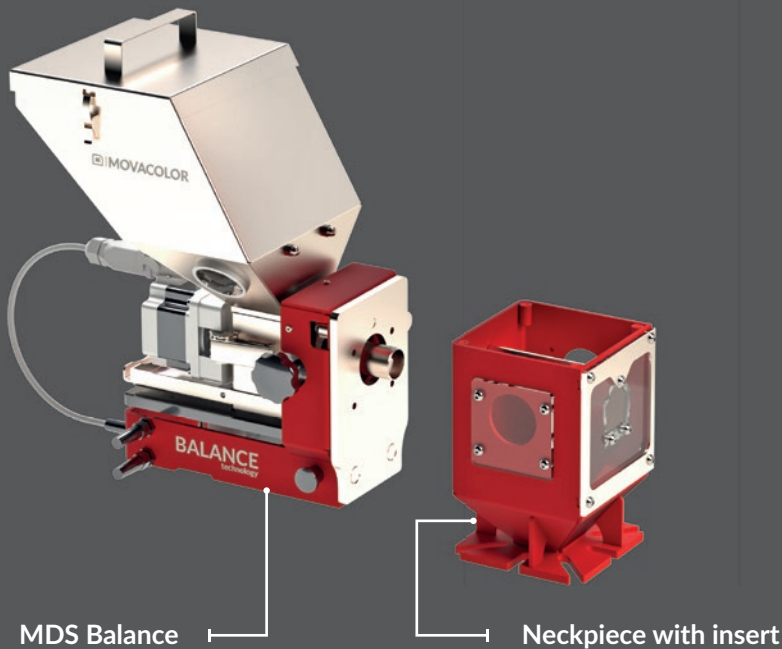

MDS Balance

Neckpiece with insert

Balance Technology

Single-point loadcell, ensuring precise measuring across its entire system, accommodating off-center loads.

Weighs total system, tracking each pellet dispensed and swiftly responds to changes in setpoint or material bulk density.

Innovative algorithm guarantees exceptional accuracy, even in high vibration environments and at extremely low shotweights.

Inline dosing

Improve shot-to-shot accuracy and blend homogeneity by feeding inline, directly into the machine's throat, in the center of the main material. This ensures full traceability and shot verification of your most critical additives. The neckpiece serves as a static mixer.



Dosing cylinders

Unique range of dosing cylinders for pulse-free, unparalleled dosing accuracy of a wide variety of materials and throughput capacities.



Modular and future ready - Intuitive control software technology for all Movacolor gravimetric solutions

PTC



Ergonomic designed 8" full-color portable touchscreen controller with modern functionalities for all plastics production processes.

Single-cable possibility making it portable up to 15 meters.



Capable of managing up to 15 gravimetric solutions at multiple lines from one control screen.



Different user-levels and Basic Operator Mode for simplified recipe selection and single-touch recipe starting.



Easy entering and memory to store up to 1.000 recipes.



Configuration wizard for quick start-up and intuitive GUI with self explanatory visuals.



Integrated hopper loading control synchronized with the dosing system.



Flexible universal communication protocols: OPC UA, ProfiBus, Modbus, ProfiNet.



Continuous data logging, process monitoring and recipe- and material file management through Smart software.



VNC remote support option for immediate trouble-shooting.

Also included in the PTC

- ✓ Large range of mounting options
- ✓ VNC remote operation option
- ✓ Backup, restore settings and export log files through USB memory stick
- ✓ Multilingual
- ✓ Special algorithms: closed-loop regrind handling and nodding head synchronization
- ✓ Event log and alarm history



5 year warranty

Movacolor products are designed and manufactured to the highest standards and deliver high-quality performance. In the unlikely event of a product failure, Movacolor will, subject to conditions*, ensure your product is serviced and repaired free of charge.



Global Support

Need help with (the installation of) your Movacolor product?

Our global support team will be happy to assist you.

Tailored blending, dosing or measuring systems, suited to your plastics production process.

Visit movacolor.com to find out more about our modular dosing concept and how you can configure your own dosing solution!

Americas

228 E 45TH ST - RM 9E
New York, NY 1001, United States
info@movacolor.com

APAC

Jln. Persiaran Bdr Utama 1 (HN)
47800 PJ Selangor, Malaysia
+60 102 082 560 | info@movacolor.com

EMEA

Wolkammersstraat 5
8601 VB Sneek, The Netherlands
+31 515 570 020 | info@movacolor.com