

Mobil Plastic®

MOBIL PLASTIC S.P.A.

50^o

Catalogo Generale

MOBIL PLASTIC S.P.A.
www.mobilplastic.it

Indice

Catalogo 2018



FERRAMENTA & MAGAZZINO
HARDWARE & STORAGE

9



BRICOLAGE & FAI DA TE
DO IT YOURSELF

51



PULIZIA &
RACCOLTA DIFFERENZIATA
CLEANING & WASTE COLLECTION

71



ENOLOGIA & AGRICOLTURA
HARDWARE & STORAGE

103



TRASPORTO LIQUIDI &
INDUSTRIA ALIMENTARE
LIQUID TRANSPORT & FOOD INDUSTRY

119



CASALINGHI
HOUSEHOLD

151

Dove siamo

Mobil Plastic

Via Robbio 31,
27030 Confienza (PV)
ITALIA



Google Map



Apple Map



Shoot and go !



COME RAGGIUNGERCI

Mobil Plastic s.p.a. è ubicata in località CONFIENZA (PV) a ca. 15 km da Novara, Vercelli e Mortara.

In posizione strategica rispetto alle grandi linee di comunicazione, la si può raggiungere sia dalla A4 (Torino – Venezia) uscita Novara Est, che dalla A21 (Piacenza – Torino) uscita Voghera, che dalla A26 (Gravellona – Voltri) uscita Vercelli Est.

HOW TO REACH US

Mobil Plastic s.p.a. is located in CONFIENZA (PV) about 15 km from Novara, Vercelli and Mortara.

In a strategic position with respect to the main transport network, it can be reached either from the A4 (Turin-Venice) Novara Est exit or from the A21 (Piacenza-Turin) Voghera exit or from the A26 (Gravellona-Voltri) Vercelli Est exit.

.....to be continued



1968

Verso la fine degli anni '60, gli anni che hanno segnato la storia industriale dell'Italia, e più precisamente nel 1968, viene fondata l'azienda Mobil Plastic.

Fin dai primi anni il successo è stato immediato, prima in Italia, per poi espandersi nei principali mercati europei di riferimento con la presenza a tutte le Fiere Internazionali più importanti del settore.

In the late '60s and more precisely in 1968, years that marked the industrial history in Italy, Mobil Plastic started its activity.

Since the early years, the company has made an instant success, first of all in Italy and then also in the most important European markets, attending all the best known international exhibitions in its sector.

1997

Nel pieno della sua continua espansione, nel 1997 avviene il passaggio generazionale alla guida della società. Subentrano infatti i figli del fondatore, Alberto e Pierangelo, i quali fin da subito pongono le basi per una ulteriore crescita applicando una rinnovata politica aziendale unitamente a moderne strategie commerciali.

Nuove ed innovative tecnologie di produzione ed una attenta e mirata ricerca e diversificazione, consentono, pochi anni dopo, l'apertura di una nuova unità produttiva all'estero.

In 1997, in the middle of its continuous expansion, the company generational handover took place.

The founder's sons, Alberto and Pierangelo, chose to follow an updated company policy together with new business strategies. Few years later, thanks to new production technologies, a focused research and diversification approaches, Mobil Plastic started a new production unit abroad.

2008

Il 2008 segna una ulteriore ed importante svolta con l'acquisizione di una storica azienda Italiana molto conosciuta con il marchio SSS, attiva da oltre 40 anni nel settore casalingo, enologico, industriale e più di recente anche nel settore ecologico.

L'importante investimento vede raddoppiare le dimensioni aziendali e i volumi di produzione imponendo alla società Mobil Plastic nuovi obiettivi, nuove strategie e nuove sfide commerciali.

2008 marks a further important turning point thanks to the takeover of a well-known Italian company famous for the "SSS" brand, which has worked for more than 40 years in the enology, households, industrial and, more recently, eco-friendly sector.

This important investment doubles the company dimensions and the production volumes, imposing to Mobil Plastic new goals, new strategies and new business challenges.

2018

Mobil Plastic compie 50 anni ed è sempre più una realtà leader nel suo settore merceologico.

E' affermata in tutta Europa con lo spirito dell'innovazione, di nuovi processi produttivi, del web e dei nuovi mercati; si apre una nuova era e nasce la nuova immagine della società in linea con i tempi. Ancora una volta, Mobil Plastic pone le basi per una ulteriore evoluzione e crescita e si propone al mercato come "partner" serio, affidabile e moderno.

Mobil Plastic celebrates 50 years of activity and nowadays it is a leading company on its market. It is a well-known company all over Europe thanks to its spirit of innovation, its tendency for new production processes, web market and other sectors. This is the beginning of a new era with a contemporary and up-to-date corporate image.

Ambiente

Mobil Plastic per l'Ambiente

La nostra Azienda si è impegnata per sostenere tutte le iniziative volte alla salvaguardia e alla tutela ambientale, infatti i nostri articoli sono prodotti con materiale riciclabile al 100%. Ogni singolo prodotto si attiene alle norme vigenti sulla sostenibilità dell'ambiente e, oltre a rispettare la natura, garantiamo qualità e durata ottimale dei nostri prodotti.

Autonomia Energetica

Grazie ai nostri impianti fotovoltaici siamo in grado di generare autonomamente buona parte dell'energia necessaria alla nostra produzione, risparmiando così preziose risorse ambientali senza inquinare.

Mobil Plastic for the Environment

Our company is supporting this initiative for the safeguard and the environmental protection, in fact our items are made of 100% recycled material. Each item is produced according to the rules in force on environmental sustainability, and besides respecting nature, we ensure reliability, quality and optimal duration of our products.

Energy Independence

Thanks to our photovoltaic systems, we are able to generate electricity, thus saving environmental resources.



FAI

CORPORATE
GOLDEN
DONOR

Noi sosteniamo il FAI

Mobil Plastic è Corporate Golden Donor FAI

Mobil plastic è membro Corporate Golden Donor FAI, associazione conosciuta in tutto il mondo. Essere membro Corporate Golden Donor FAI è segno di eccellenza ed è un modo concreto per contribuire ad una causa importante che Mobil Plastic abbraccia da anni con entusiasmo.

Mobil Plastic is Corporate Golden Donor FAI

Mobil Plastic is a FAI Corporate Golden Donor, association known all over the world. To be a FAI Corporate Golden Donor is a sign of excellence and gives a concrete contribution to an important cause that Mobil Plastic has joined for years with enthusiasm.



FERRAMENTA & MAGGAZZINO

Hardware & Storage



Serie 2000



Serie C500



Serie KOMBI



MADIA SYSTEM



MINI



MIDI



MAXI

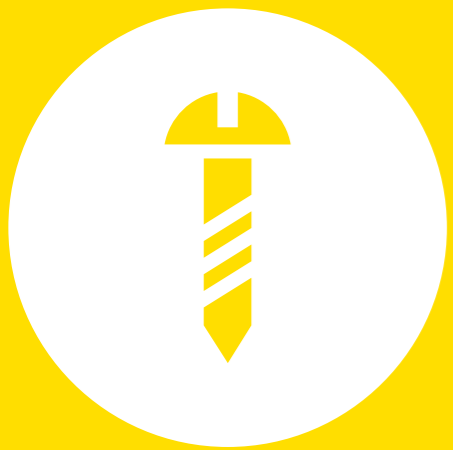

FERRAMENTA & MAGAZZINO

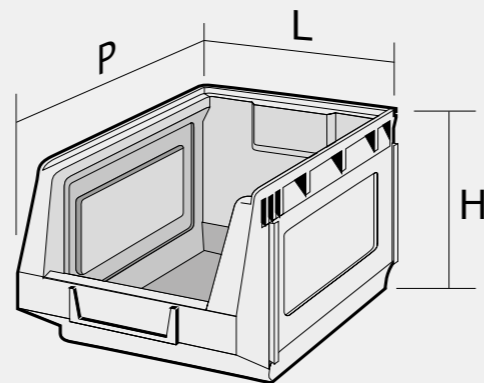

art	L	H	P	Capacità Capacity	Imballo pezzi Pack quantity
2001	103	55	90	0,4 l.	100
2001/B	103	62	120	0,7 l.	100
2002	103	83	165	1 l.	48
2002/L	103	83	240	2 l.	28
2003	145	125	240	3,5 l.	38
2003/L	145	125	335	6 l.	16
2004	207	165	345	10 l.	20
2005	303	190	485	30 l.	12
2005/S	363	250	580	52 l.	4

Serie 2000

Contenitori sovrapponibili in HDPE

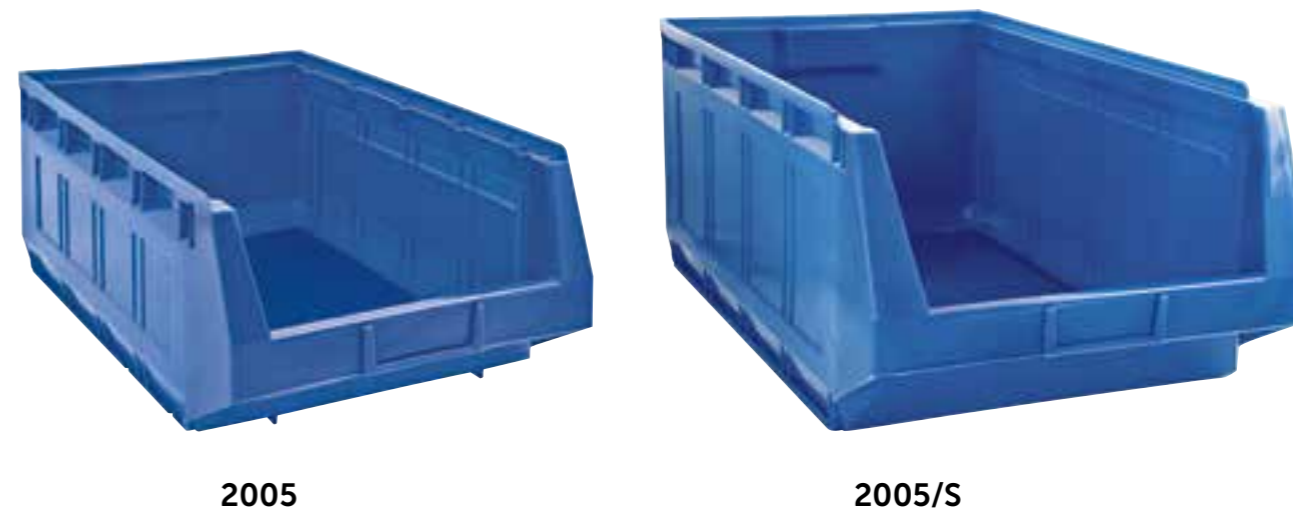
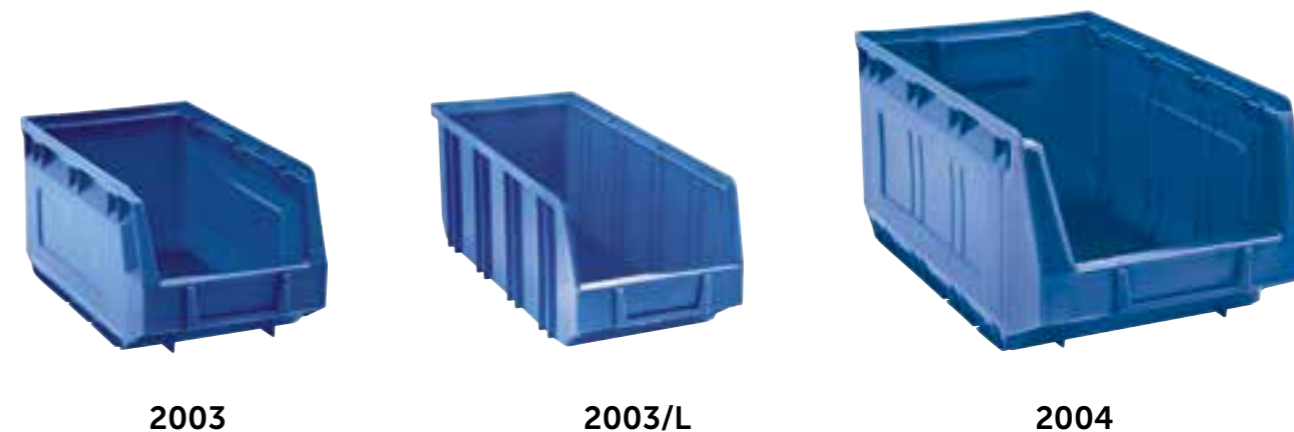
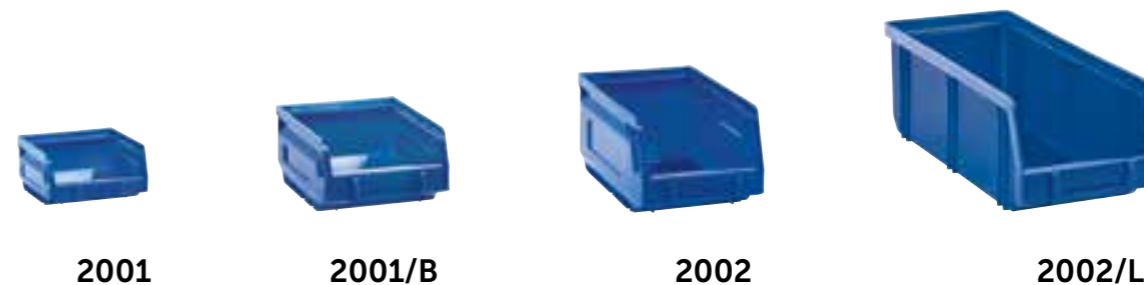

Coperchio SERIE 2000





FERRAMENTA & MAGAZZINO

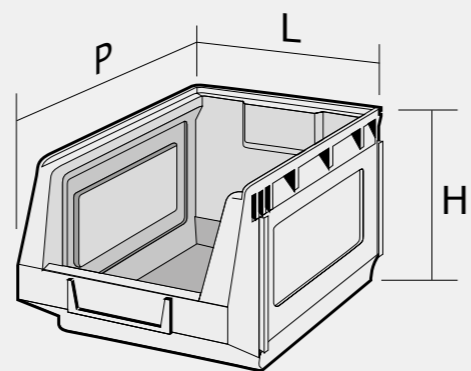

art	L	H	P	Capacità Capacity	Imballo pezzi Pack quantity
C 502	105	85	163	1	48
C 503	150	125	240	3,5	38
C 504	212	165	345	10	24
C 505	305	190	485	30	12
C 505/S	370	250	580	52	4

Componibili ad incastro laterale
Back and side interlocking system

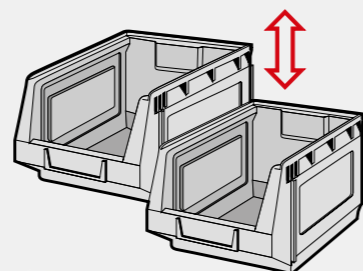

Serie C500

Contenitori sovrapponibili e componibili in HPDE



C 502



C 503



C 504



C 505



C 505/S

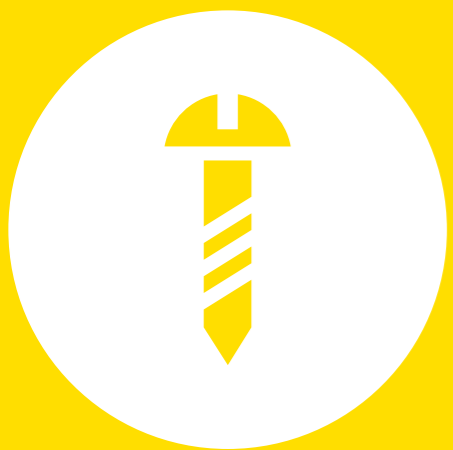

FERRAMENTA & MAGAZZINO

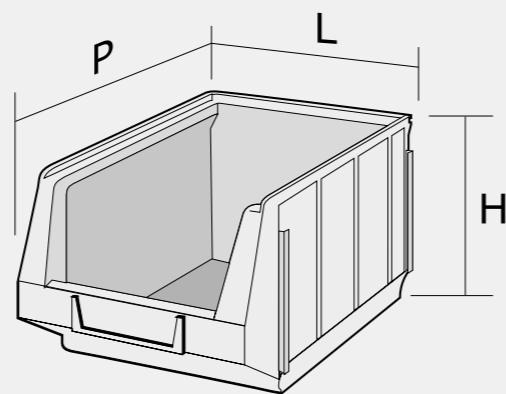

art	L	H	P	Capacità Capacity	Imballo pezzi Pack quantity
1 PST	103	53	95	0,4	100
2 K	108	75	167	1	48
3 K	151	128	240	3,5	38
3 KB	296	128	240	7	24
3 KBD	296	128	240	7	24
4 K	213	165	350	10	24
5 K	310	190	490	30	12
5 KD	310	190	490	30	12
5 KS	385	250	580	52	4
5 KSD	385	250	580	52	4
6 K	450	300	710	95	4
6 KD	450	300	710	95	4

Componibili ad incastro laterale e posteriore

Back and side interlocking system

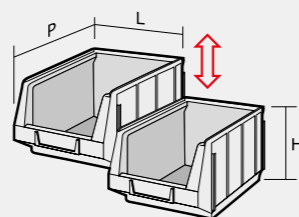

2 K - 3 K - 3 KB - 3 KBD - 4 K - 5 K - 5 KD
5 KD 5 KS - 5 KSD - 6 K - 6 KD

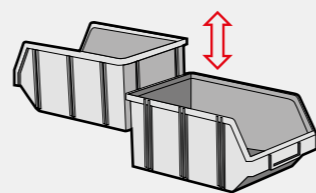

3 KB - 3 KBD - 4 K - 5 K - 5 KD
5 KS - 5 KSD - 6 K - 6 KD



PATELETTA 4 K - 5 K

Serie KOMBI

Contenitori sovrapponibili e componibili in PST AU



1 PST

2 K

3 K

3 KB



3 KBD



4 K



5 K



5 KD



5 KS



5 KSD



6 K



6 KD



FERRAMENTA & MAGAZZINO

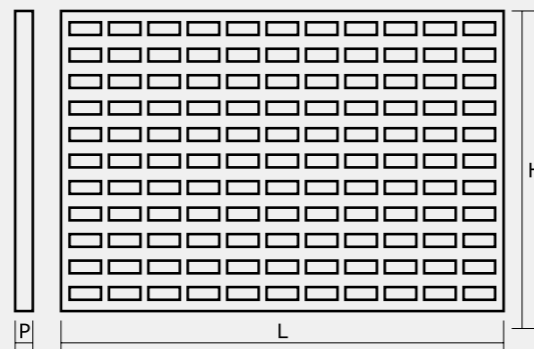
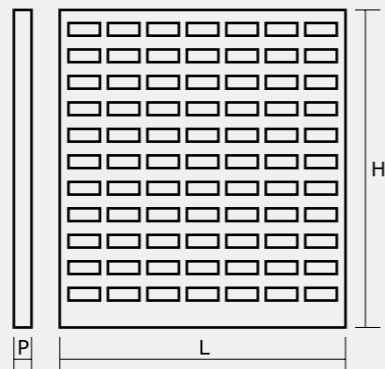

art	L	H	P	Imballo Pezzi Pack quantity
MP 90	1.000	455	15	2
MP 45	495	455	15	2

Pannelli flangiati portacontenitori in robusta lamiera stampata, verniciati a forno in polvere epossidica di colore rosso.

Flanged panel for bins constructed of sheet steel, epoxy powder coating.



PENSIL

Pannelli pensili per Serie 2000

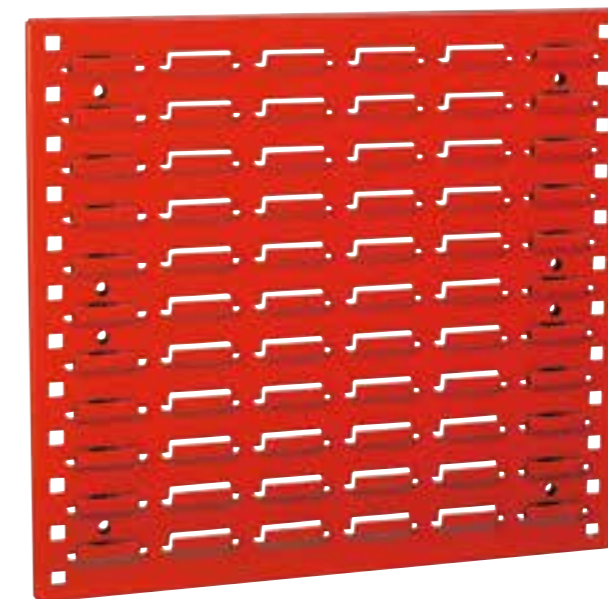

MP 45

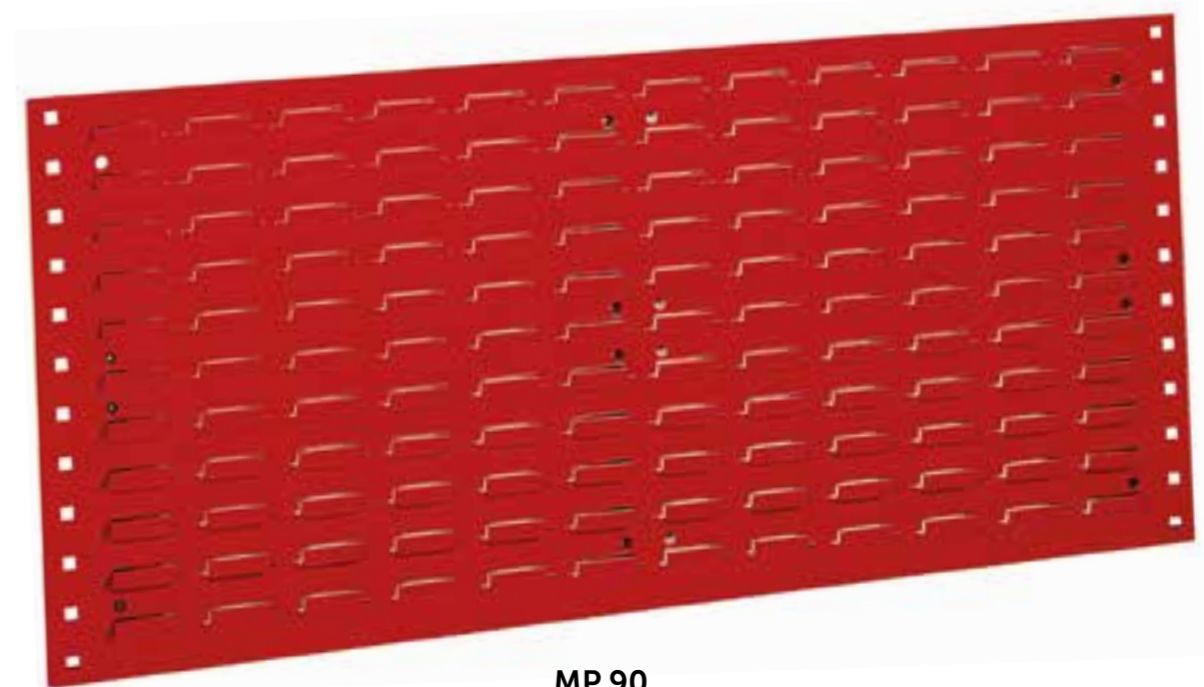

MP 90



FERRAMENTA & MAGAZZINO

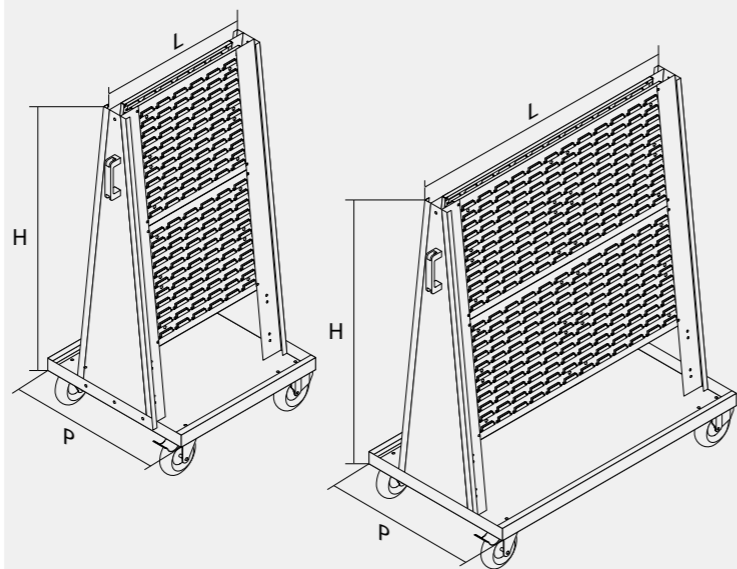

art	L	H	P	Imballo Pezzi Pack quantity
MP 30/C	610	1.300	610	1
MP 60	1.060	1.300	610	1

* KIT CONTENITORI SERIE 2000

KIT MP 30/C

Totale numero contenitori: 60

Total number of bins: 60

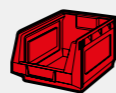

2003=
n.12

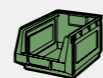

2002=
n.32



2001=
n.16

KIT MP 60

Totale numero contenitori: 120

Total number of bins: 120

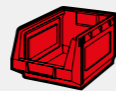

2003=
n.24

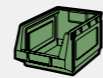

2002=
n.64



2001=
n.32

- * Ordinabili separatamente
- * To be order separately

CARRELLI

Portacontenitori serie 2000



MP 30/C
(prodotto privo di contenitori)
(item supplied without bins)

Robusti e pratici carrelli per esigenze di magazzinaggio mobile. Realizzati in lamiera elettrosaldata e verniciati a forno in polvere epossidica di colore rosso. Dotati di n. 4 ruote gommate di cui 2 piroettanti (una con fermo). Forniti smontati con schema e minuterie per l'assemblaggio.

Strong and practical trolleys for mobile storage. Made of electro-welded plate and oven painted with red epoxy powder. Equipped with nr. 4 gummed wheels, 2 of them are pirouetting (1 with brake). Supplied disassembled with a handbook, screw and bolts for assembly.



MP 60
(prodotto privo di contenitori)
(item supplied without bins)



FERRAMENTA & MAGAZZINO

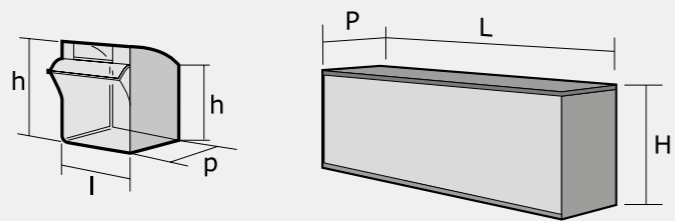

art	Cassetti Drawers	L	H	P	l	h	P	Imballo pezzi Pack quantity
MADIA 1	9	600	78	68	56	64/47	43	8
MADIA 2	6	600	112	96	88	98/70	65	4
MADIA 3	5	600	168	140	108	148/107	98	2
MADIA 4	4	600	206	178	138	190/134	127	1
MADIA 5	3	600	242	210	180	220/161	145	1

Gamma componibile di cassettiere in pst-au con cassetto ad apertura basculante ed estraibile. Tutti i modelli sono sovrapponibili tra loro.

Plastic interlocking modules with tilting and removable drawers. All modules are stackable.



Fermo per MADIA (1-2-3-4-5)
Locking for MADIA (1-2-3-4-5)

MADIA SYSTEM

Cassettiere MADIA



MADIA 1



MADIA 2



MADIA 3



MADIA 4



MADIA 5



FERRAMENTA & MAGAZZINO

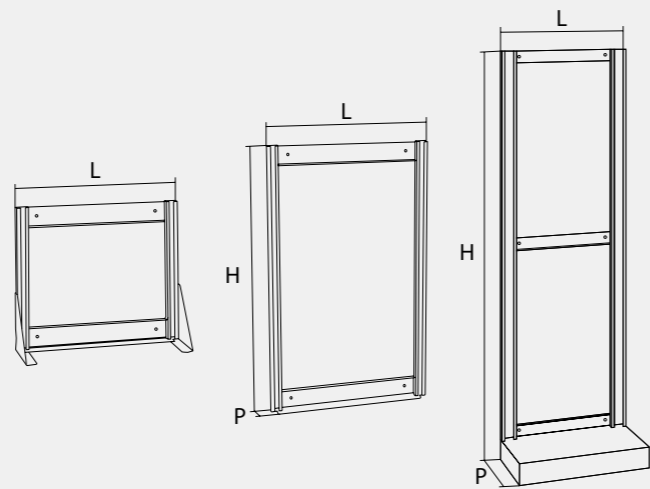

art	L	H	P	Imballo pezzi Pack quantity
MP 100	610	500	150	2
MP 125	600	1.000	40	1
MP 150	600	1.500 (UTILE 1.400)	205	1
MP 175	600	1.750 (UTILE 1.650)	205	1
MP 195	600	1.950 (UTILE 1.850)	205	1

Esempi allestimenti



MP 195



MP 175



MP 150



MP 125



MP 100

Esempio di incastro posteriore delle MADIA ad un telaio.

Example of MADIA back grooving on a frame.



MADIA SYSTEM

Telai espositori



MP 100

Pratico telaio da banco o da parete. Realizzato in lamiera elettrosaldata e verniciato a forno in polvere epossidica.

Practical frame for bench or shelf. Made of electro-welded plate and oven painted with epoxy powder.



MP 125

Robusto telaio per fissaggio a parete. Realizzato in lamiera elettrosaldata e verniciato a forno in polvere epossidica.

Strong frame for fixing on the wall. Made of electro-welded plate and oven painted with epoxy powder.



MP 150



MP 175



MP 195

Pratici e robusti telai espositori con base.

Realizzati in lamiera elettrosaldata e verniciati a forno in polvere epossidica. Forniti smontati con viteria per assemblaggio.

Practical and strong frames with base.

Made of electro-welded plate and oven painted with epoxy powder. Supplied disassembled with screw and bolts.



PRODOTTI IN
MATERIALE
RICICLABILE



FERRAMENTA & MAGAZZINO

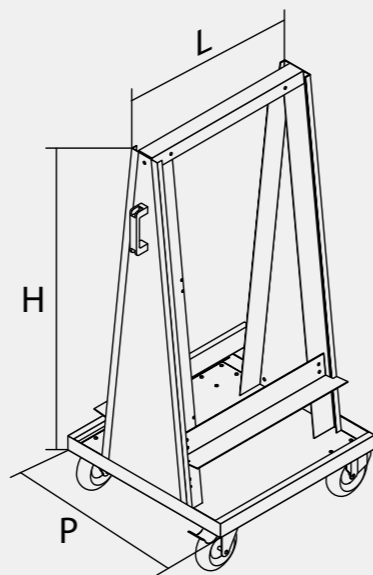

art	L	H	P	Imballo pezzi Pack quantity
MP 30/M	610	1.300	610	1

*** KIT MP 30/ M (madie per MP/30 M)**

Totale numero cassetti: 80
Total number of drawers: 80

CARTELLINI IN DOTAZIONE STANDARD
STANDARD TAGS INCLUDED

	Fronte Front	Retro Back
MADIA 1= n.2		
MADIA 2= n.4		
MADIA 3= n.6		
MADIA 4= n.2		

- * Ordinabile separatamente
- * To be order separately

MADIA SYSTEM

Carrello MADIA



MP 30/M
(prodotto privo di MADIA)
(item supplied without MADIA)

Robusto e pratico carrello per esigenze di magazzinaggio mobile.

Realizzato in lamiera elettrosaldata e verniciato a forno in polvere epossidica di colore rosso. Dotato di n. 4 ruote gommata di cui 2 piroettanti (una con fermo).

Strong and practical trolley for mobile storage.

Made of electro-welded plate and oven painted with red epoxy powder. Equipped with nr. 4 gummed wheels, 2 of them are pirouetting (1 with brake). Supplied disassembled with a handbook, screw and bolts for assembly.

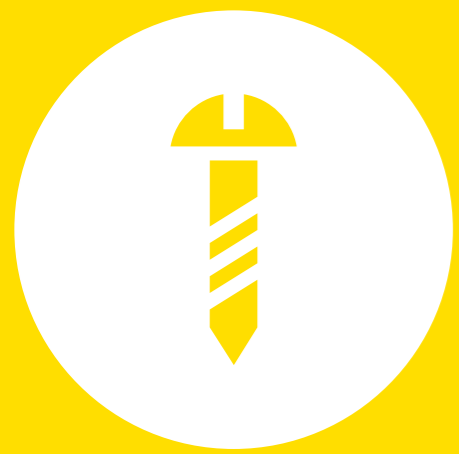

**FERRAMENTA &
MAGAZZINO**

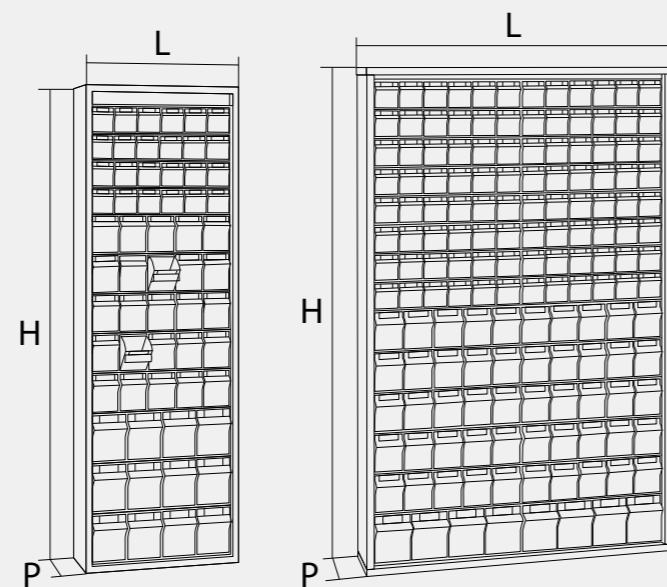

MP 200

4 x MADIA 2
5 x MADIA 3
3 x MADIA 4

Totale numero
cassetti: 61

Total number
of drawers: 61

MP 200/D

16 x MADIA 2
10 x MADIA 3
2 x MADIA 4

Totale numero
cassetti: 154

Total number
of drawers: 154

art	L	H	P	Imballo pezzi Pack quantity
MP 200	665	2.000	250	1
MP 200/D	1.265	2.000	250	1

Robusti scaffali in lamiera elettrosaldata.

Permettono l'allineamento dei cassetti Madia sul frontale. Verniciati a forno in polvere epossidica. Forniti già montati.

Strong frames made of electro-welded plate.

It allows the lining up of drawers on the front. Oven painted with epoxy powder. Supplied assembled.

(CARTELLINI IN DOTAZIONE)
(STANDARD TAGS INCLUDED)

MADIA SYSTEM

Scaffali



MP 200



MP 200/D

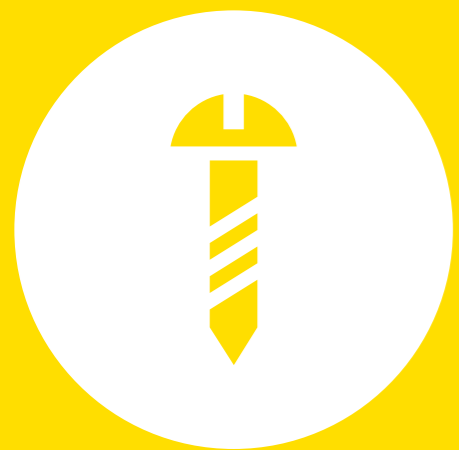

FERRAMENTA & MAGAZZINO



MP 400/1
(165 cassetti - drawers)



MP 400/1A
(170 cassetti - drawers)



MP 400/1B
(129 cassetti - drawers)

- Pannello scorrevole con n. 16 MADIA 2
Sliding panel with n. 16 MADIA 2
- Pannello scorrevole con n. 11 MADIA 3
Sliding panel with n. 11 MADIA 3
- Pannello fisso con n. 8 MADIA 4 e n. 1 MADIA 3
Fixed panel with n. 8 MADIA 4 and n. 1 MADIA 3
- Pannello fisso con n. 11 MADIA 3
Fixed panel with n. 11 MADIA 3

art	L	H	P	Imballo pezzi Pack quantity
MP 400/1	1.250	1.950	400	1

**Due pannelli fissi
Un pannello scorrevole**

**Two fixed panels
One sliding panel**

MADIA SYSTEM

Armadi

MP 400/1

Armadio a pannelli scorrevoli su cuscinetti a sfera. Struttura con n. 2 pannelli fissi affiancati sul fondo + n. 1 scorrevoli, realizzata in lamiera elettrosaldata con barre di rinforzo. Verniciata a forno con polvere epossidica. Fornito smontato con manuale di assemblaggio e viteria.

Cabinet with sliding panels on balls bearing. Frame equipped with n. 2 fixed panels placed side by side on the bottom + n. 1 sliding panels, made of electrowelded reinforced plate. Oven painted with epoxy powder. Supplied disassembled with a handbook for assembly and screw and bolts.

Portata singolo pannello: Kg 160 circa
Capacity of each panel: 160 Kg about

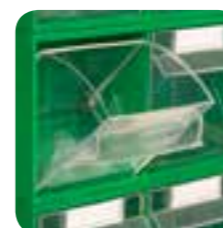

(CARTELLINI IN DOTAZIONE)
(STANDARD TAGS INCLUDED)

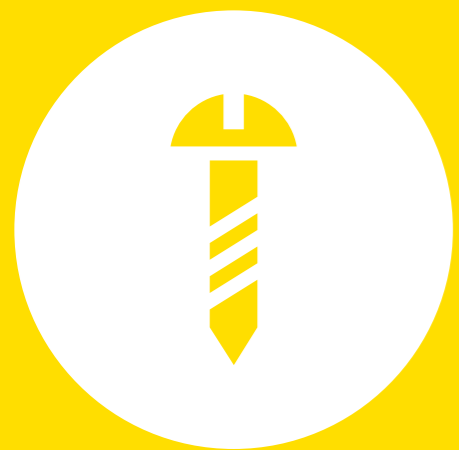

FERRAMENTA & MAGAZZINO



MP 400/2
(225 cassetti - drawers)

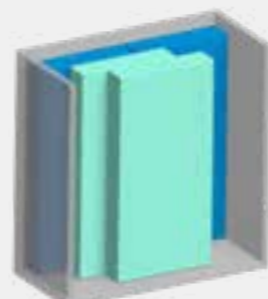

MP 400/2A
(220 cassetti - drawers)



MP 400/2B
(266 cassetti - drawers)

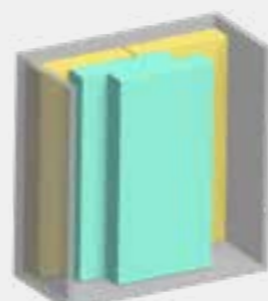

MP 400/2C
(184 cassetti - drawers)

- Pannello scorrevole con n. 16 MADIA 2
Sliding panel with n. 16 MADIA 2
- Pannello scorrevole con n. 11 MADIA 3
Sliding panel with n. 11 MADIA 3
- Pannello fisso con n. 8 MADIA 4 e n. 1 MADIA 3
Fixed panel with n. 8 MADIA 4 and n. 1 MADIA 3
- Pannello fisso con n. 11 MADIA 3
Fixed panel with n. 11 MADIA 3

art	L	H	P	Imballo pezzi Pack quantity
MP 400/2	1.250	1.950	600	1

**Due pannelli fissi
Due pannelli scorrevoli**

**Two fixed panels
Two sliding panels**

MADIA SYSTEM

Armadi

MP 400/2

Armadio a pannelli scorrevoli su cuscinetti a sfera. Struttura con n. 2 pannelli fissi affiancati sul fondo + n. 2 scorrevoli, realizzata in lamiera elettrosaldata con barre di rinforzo. Verniciata a forno con polvere epossidica. Fornito smontato con manuale di assemblaggio e viteria.

Cabinet with sliding panels on balls bearing. Frame equipped with n. 2 fixed panels placed side by side on the bottom + n. 2 sliding panels, made of electrowelded reinforced plate. Oven painted with epoxy powder. Supplied disassembled with a handbook for assembly and screw and bolts.

Portata singolo pannello: Kg 160 circa
Capacity of each panel: 160 Kg about



(CARTELLINI IN DOTAZIONE)
(STANDARD TAGS INCLUDED)



FERRAMENTA & MAGAZZINO

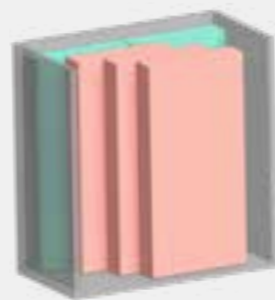

MP 400/3
(398 cassetti - drawers)



MP 400/3A
(480 cassetti - drawers)



MP 400/3B
(362 cassetti - drawers)

- Pannello scorrevole con n. 16 MADIA 2
Sliding panel with n. 16 MADIA 2
- Pannello fisso con n. 11 MADIA 3
Fixed panel with n. 11 MADIA 3
- Pannello fisso con n. 8 MADIA 4 e n. 1 MADIA 3
Fixed panel with n. 8 MADIA 4 and n. 1 MADIA 3
- Pannello fisso con n. 16 MADIA 2
Fixed panel with n. 16 MADIA 2

art	L	H	P	Imballo pezzi Pack quantity
MP 400/3	1.250	1.950	600	1

**Due pannelli fissi
Tre pannelli scorrevoli**

**Two fixed panels
Three sliding panels**

MADIA SYSTEM

Armadi

MP 400/3

Armadio a pannelli scorrevoli su cuscinetti a sfera. Struttura con n. 2 pannelli fissi affiancati sul fondo + n. 3 scorrevoli, realizzata in lamiera elettrosaldata con barre di rinforzo. Verniciata a forno con polvere epossidica. Fornito smontato con manuale di assemblaggio e viteria.

Cabinet with sliding panels on balls bearing. Frame equipped with n. 2 fixed panels placed side by side on the bottom + n. 3 sliding panels, made of electrowelded reinforced plate. Oven painted with epoxy powder. Supplied disassembled with a handbook for assembly and screw and bolts.

Portata singolo pannello: Kg 160 circa
Capacity of each panel: 160 Kg about

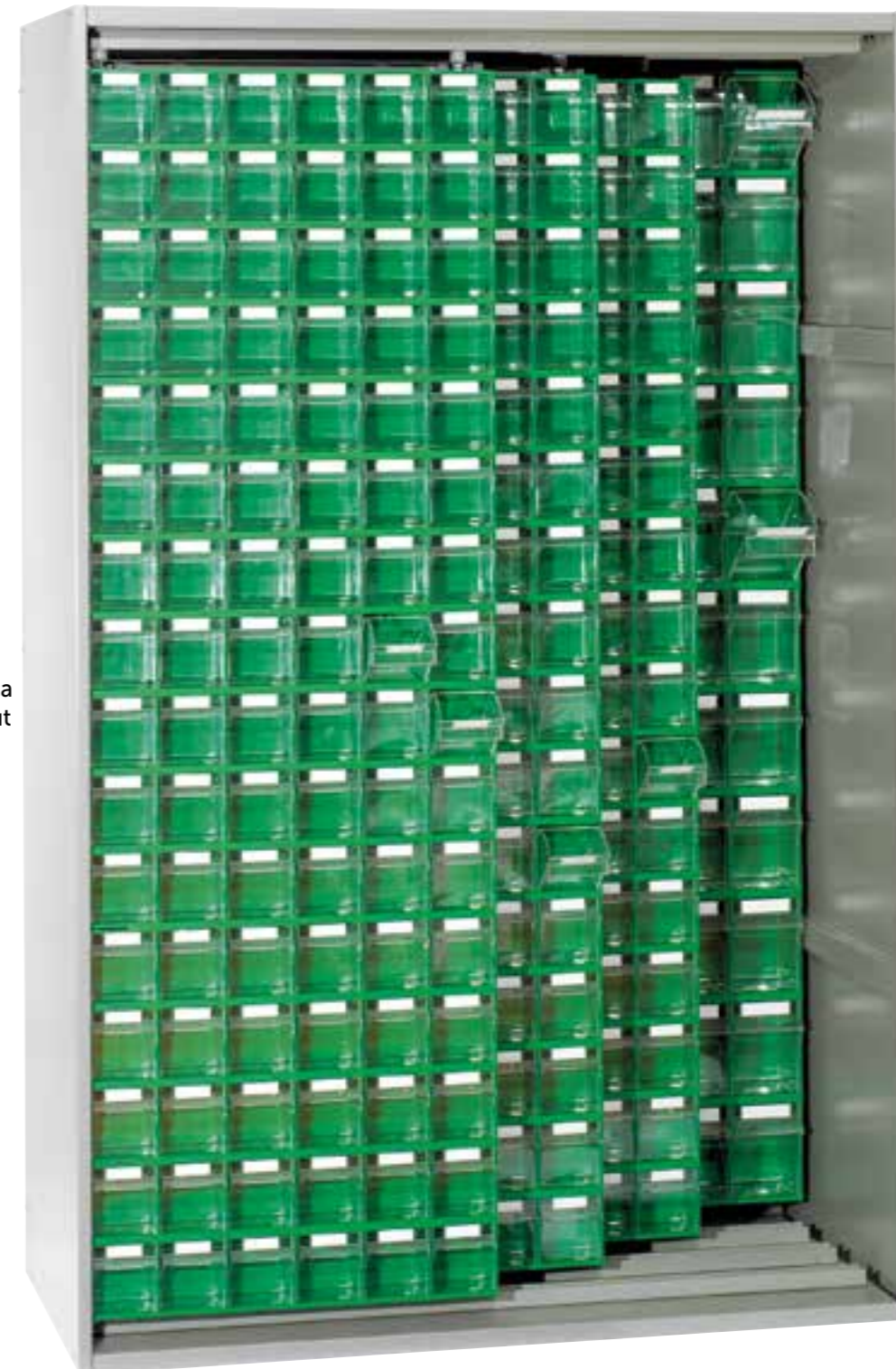

(CARTELLINI IN DOTAZIONE)
(STANDARD TAGS INCLUDED)

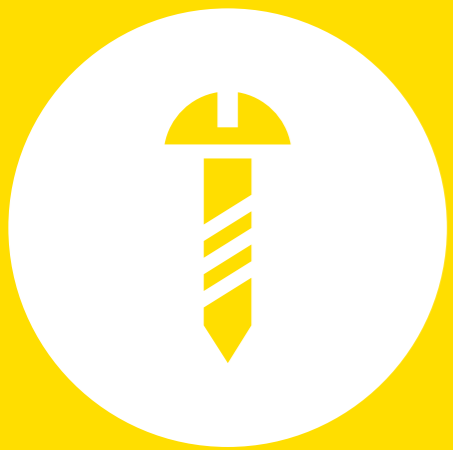

FERRAMENTA & MAGAZZINO

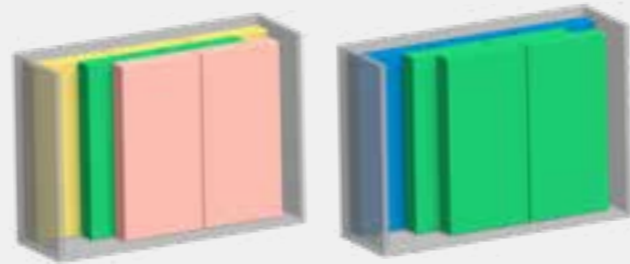

MP 600/4 (413 cassetti - drawers)
MP 600/4A (385 cassetti - drawers)

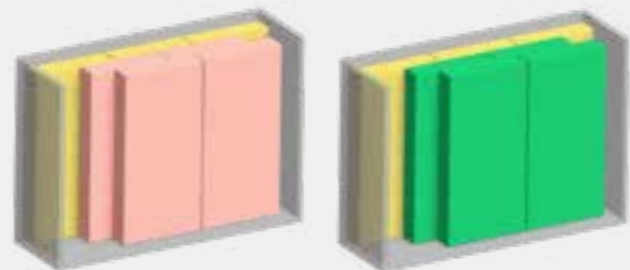

MP 600/4B (495 cassetti - drawers)
MP 600/4C (331 cassetti - drawers)

- Pannello scorrevole con n. 16 MADIA 2
Sliding panel with n. 16 MADIA 2
- Pannello scorrevole con n. 11 MADIA 3
Sliding panel with n. 11 MADIA 3
- Pannello fisso con n. 8 MADIA 4 e n. 1 MADIA 3
Fixed panel with n. 8 MADIA 4 and n. 1 MADIA 3
- Pannello fisso con n. 11 MADIA 3
Fixed panel with n. 11 MADIA 3

art	L	H	P	Imballo pezzi Pack quantity
MP 600/2	1.850	1.950	600	1

**Tre pannelli fissi
Quattro pannelli scorrevoli**

**Three fixed panels
Four sliding panels**

MADIA SYSTEM

Armadi

MP 600/4

Armadio a pannelli scorrevoli su cuscinetti a sfera. Struttura con n. 3 pannelli fissi affiancati sul fondo + n. 4 scorrevoli, realizzata in lamiera elettrosaldata con barre di rinforzo. Verniciata a forno con polvere epossidica. Fornito smontato con manuale di assemblaggio e viteria.

Cabinet with sliding panels on balls bearing. Frame equipped with n. 3 fixed panels placed side by side on the bottom + n. 4 sliding panels, made of electrowelded reinforced plate. Oven painted with epoxy powder. Supplied disassembled with a handbook for assembly and screw and bolts.

Portata singolo pannello: Kg 160 circa
Capacity of each panel: 160 Kg about



(CARTELLINI IN DOTAZIONE)
(STANDARD TAGS INCLUDED)

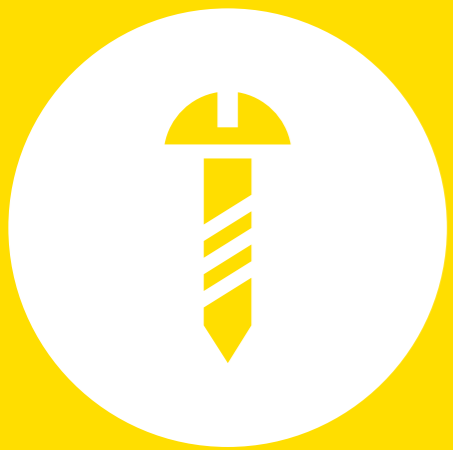

FERRAMENTA & MAGAZZINO

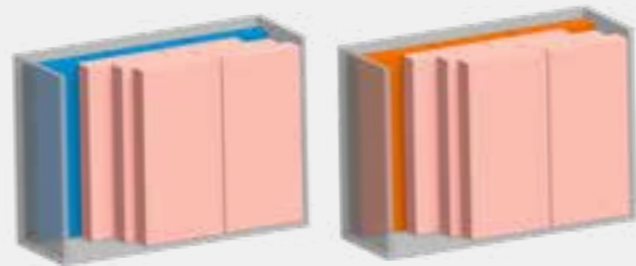

MP 600/6 (741 cassetti - drawers) **MP 600/6A** (864 cassetti - drawers)

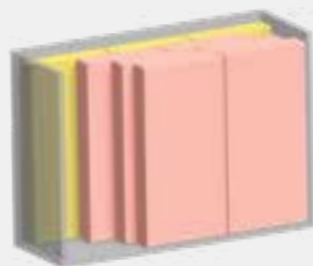

MP 600/6B (687 cassetti - drawers)

- Pannello scorrevole con n. 16 MADIA 2
Sliding panel with n. 16 MADIA 2
- Pannello fisso con n. 16 MADIA 2
Fixed panel with n. 16 MADIA 2
- Pannello fisso con n. 8 MADIA 4 e n. 1 MADIA 3
Fixed panel with n. 8 MADIA 4 and n. 1 MADIA 3
- Pannello fisso con n. 11 MADIA 3
Fixed panel with n. 11 MADIA 3

art	L	H	P	Imballo pezzi Pack quantity
MP 600/6	1.250	1.950	600	1

**Tre pannelli fissi
Sei pannelli scorrevoli**

**Three fixed panels
Six sliding panels**

MADIA SYSTEM

Armadi

MP 600/6

Armadio a pannelli scorrevoli su cuscinetti a sfera. Struttura con n. 3 pannelli fissi affiancati sul fondo + n. 6 scorrevoli, realizzata in lamiera elettrosaldata con barre di rinforzo. Verniciata a forno con polvere epossidica. Fornito smontato con manuale di assemblaggio e viteria.

Cabinet with sliding panels on balls bearing. Frame equipped with n. 3 fixed panels placed side by side on the bottom + n. 6 sliding panels, made of electrowelded reinforced plate. Oven painted with epoxy powder. Supplied disassembled with a handbook for assembly and screw and bolts.

Portata singolo pannello: Kg 160 circa
Capacity of each panel: 160 Kg about



(CARTELLINI IN DOTAZIONE)
(STANDARD TAGS INCLUDED)



FERRAMENTA & MAGAZZINO

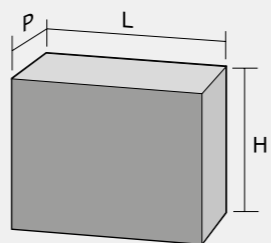

art	L	H	P	Imballo pezzi Pack quantity	Cassetti Drawers
A	225	169	133	6	24 cassetti: l. 48 - p. 114,5 - h. 24
T/A	225	169	133	6	24 cassetti: l. 48 - p. 114,5 - h. 24
A1	225	169	133	6	12 cassetti: l. 48 - p. 114,5 - h. 50
T/A1	225	169	133	6	12 cassetti: l. 48 - p. 114,5 - h. 50
B	225	169	133	6	12 cassetti: l. 103 -p. 114,5 - h. 24
T/B	225	169	133	6	12 cassetti: l. 103 -p. 114,5 - h. 24
C	225	169	133	6	6 cassetti: l. 103 -p. 114,5 - h. 50
T/C	225	169	133	6	6 cassetti: l. 103 -p. 114,5 - h. 50
D	225	169	133	6	3 cassetti: l. 214 -p. 114,5 - h. 50
T/D	225	169	133	6	3 cassetti: l. 214 -p. 114,5 - h. 50
M	225	169	133	6	4 cassetti: l. 48 - p. 114,5 - h. 24 2 cassetti: l. 48 - p. 114,5 - h. 50 2 cassetti: l. 103 -p. 114,5 - h. 24 1 cassetto: l. 103 -p. 114,5 - h. 50 1 cassetto: l. 214 -p. 114,5 - h. 50
T/M	225	169	133	6	4 cassetti: l. 48 - p. 114,5 - h. 24 2 cassetti: l. 48 - p. 114,5 - h. 50 2 cassetti: l. 103 -p. 114,5 - h. 24 1 cassetto: l. 103 -p. 114,5 - h. 50 1 cassetto: l. 214 -p. 114,5 - h. 50

VASCHETTA

BIANCO (BI)

art	L	H	P
A	47	22	37
B	37	22	27
C	56	46	51
A1	56	46	47
D	110	46	56

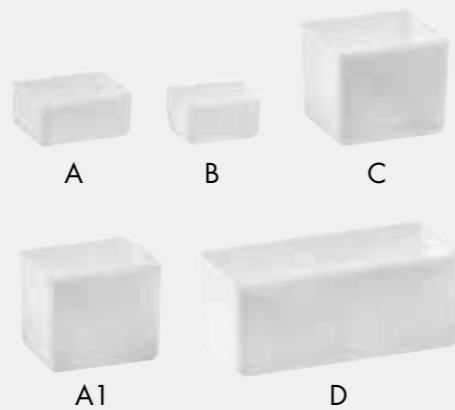

CARTELLINI IN DOTAZIONE STANDARD - TAGS INCLUDED



C-MINI

Cassettiere componibili MINI



A



A1



B



C



D



M



T/A



T/A1



T/B



T/C



T/D



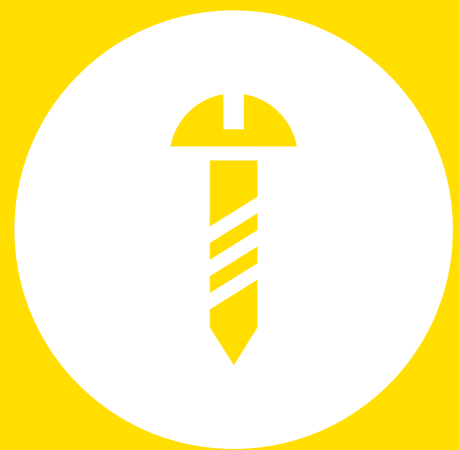

T/M

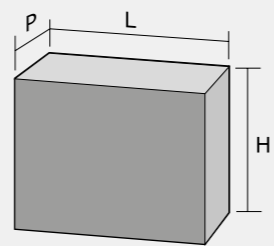

**FERRAMENTA &
MAGAZZINO**

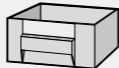
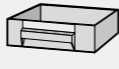

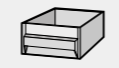
art	L	H	P	Imballo pezzi Pack quantity	Cassetti Drawers
T/42	225	225	225	8	2 cassetti: l. 212 - p. 198 - h. 103 
T/43	225	225	225	8	4 cassetti: l. 212 - p. 198 - h. 48 
T/44	225	225	225	8	4 cassetti: l. 101 - p. 198 - h. 103 
T/45	225	225	225	8	8 cassetti: l. 101 - p. 198 - h. 48 con 8 separatori estraibili 

CARTELLINI IN DOTAZIONE STANDARD
TAGS INCLUDED



C-MIDI

Cassettiere componibili MIDI



T/42



T/43



T/44



T/45

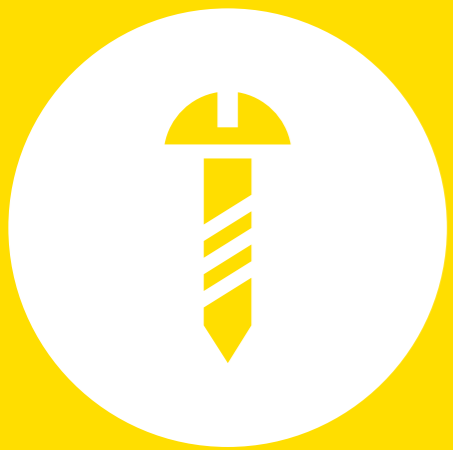

FERRAMENTA & MAGAZZINO

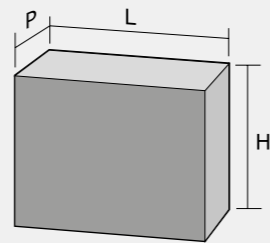

art	L	H	P	Imballo pezzi Pack quantity	Cassetti Drawers
*L	225	228	263	8	6 cassetti: l. 101 - p. 241 - h. 67 con 12 separatori estraibili trasparenti
*T/L	225	228	263	8	6 cassetti: l. 101 - p. 241 - h. 67 con 12 separatori estraibili trasparenti
*E	340	340	270	4	6 cassetti: l. 155 - p. 241 - h. 100
T/E	340	340	270	4	6 cassetti: l. 155 - p. 241 - h. 100
*F	562	228	390	4	4 cassetti: l. 266 - p. 357 - h. 100
T/F	562	228	390	4	4 cassetti: l. 266 - p. 357 - h. 100
H/3	562	228	390	4	6 cassetti: l. 266 - p. 358 - h. 65
T/3	562	228	390	4	6 cassetti: l. 266 - p. 358 - h. 65
*G	393	228	390	4	2 cassetti: l. 376 - p. 357 - h. 100
*F/T	562	228	390	4	4 cassetti: l. 266 - p. 357 - h. 100

* CARTELLINI E COPRI CARTELLINI IN DOTAZIONE STANDARD
* TAGS E TAGS COVER INCLUDED

Cassettiere MAXI
maggiore resistenza al carico,
corpo esterno per ogni cassetto.

Modules MAXI
High load resistance and bodies drawers.

ESPOSITORE
per F - G



H/3



L



E



F



F/T

Cassetti con separatore
longitudinale fisso.
Drawers with longitudinal
fixed divisor.

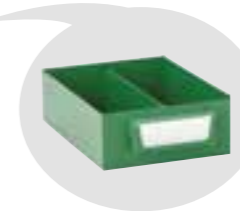

G



T/L



T/E



T/F



T/3

C-MAXI

Cassettiere componibili MAXI



FERRAMENTA & MAGAZZINO

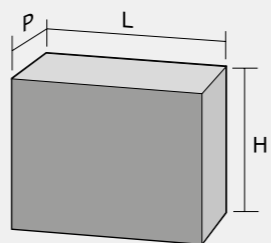

art	L	H	P	Imballo pezzi Pack quantity	Cassetti Drawers
MOBIL 1	225	450	323	4	4 cassetti: l. 210 - p. 289 - h. 103
MOBIL 101	225	450	323	4	4 cassetti: l. 210 - p. 289 - h. 103
MOBIL 2	169	228	323	8	2 cassetti: l. 155 - p. 289 - h. 103
MOBIL 102	169	228	323	8	2 cassetti: l. 155 - p. 289 - h. 103
MOBIL 3	562	228	390	4	4 cassetti: l. 266 - p. 360 - h. 103
MOBIL 103	562	228	390	4	4 cassetti: l. 266 - p. 360 - h. 103

CARTELLINI IN DOTAZIONE STANDARD
TAGS INCLUDED



MOBIL 1



MOBIL 2



MOBIL 1/T



Composizione da 4 cassetti con separatore
Longitudinale fisso e 4 separatori estraibili
Fixed divider and 4 movable dividers

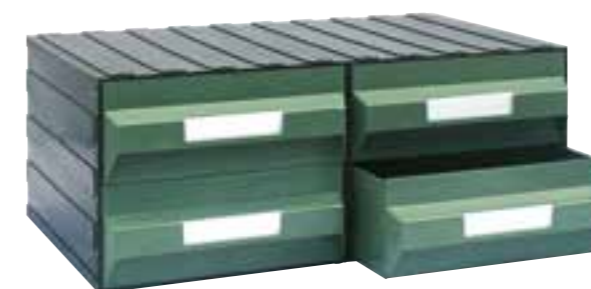

MOBIL 3



MOBIL 101



MOBIL 102



MOBIL 103

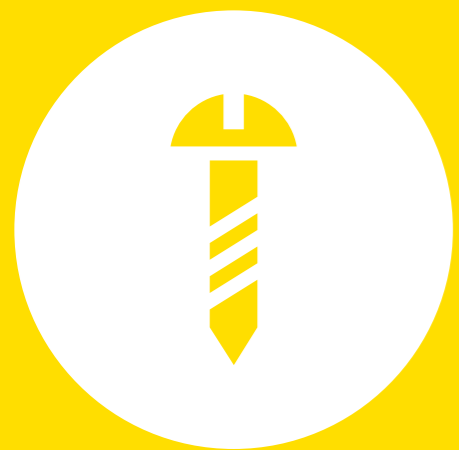

**FERRAMENTA &
MAGAZZINO**

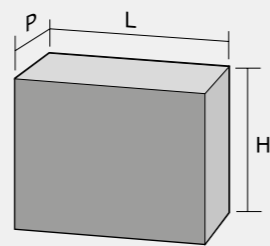

art	L	H	P	Imballo pezzi Pack quantity	Cassetti Drawers
S40	238	262	423	4	2 cassetti: l. 220 - p. 390 - h. 120
T40	238	262	423	4	2 cassetti: l. 220 - p. 390 - h. 120
S40/T	238	262	423	4	2 cassetti: l. 220 - p. 390 - h. 120

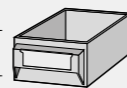

CARTELLINI IN DOTAZIONE STANDARD
TAGS INCLUDED

Cassettiere MAXI

struttura non compatibile con le altre serie, realizzata per utilizzo su scaffali 1000mm x 400mm

Modules MAXI

modules media structure not compatible with other series, designed for use on shelves 1000mm x 400mm

BASI per C-MAXI

art	L	H	P	Imballo pezzi Pack quantity
BASE E	165	70	250	6
BASE F	280	70	370	6
BASE G	390	70	370	6

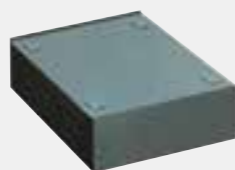

BASE E

Base E per composizioni E - T/ E
Base E for modules E - T/ E

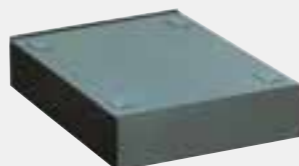

BASE F

Base F per composizioni F - F/ T - T/ F
H/ 3 - T/ 3 - MOBIL 3 - MOBIL 103
Base F for modules F - F/ T - T/ F
H/ 3 - T/ 3 - MOBIL 3 - MOBIL 103

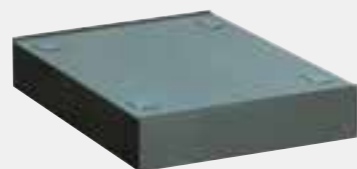

BASE G

Base G per composizione G
Base G for module G

C-MAXI

Cassettiere componibili MAXI



S40



T40



S40/T

con 3 separatori
estraibili
with 3 removable
dividers



4 cassetti affiancati consentono di utilizzare senza perdite di spazio la luce frontale nominale di 1.000 mm. e la profondità di 400 mm.

4 drawers, one close to the other, allow to exploit a linear space of 1.000 mm. and a width of 400 mm.

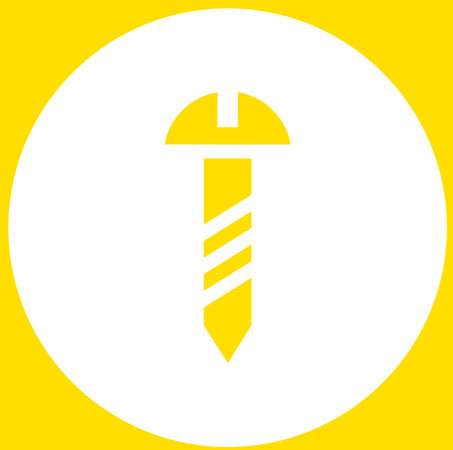

FERRAMENTA & MAGAZZINO

ESEMPI DI ALLESTIMENTO:

F1 - F2 - F3 per cassettiere: F - T/ F - F/ T - MOBIL 3 - MOBIL 103

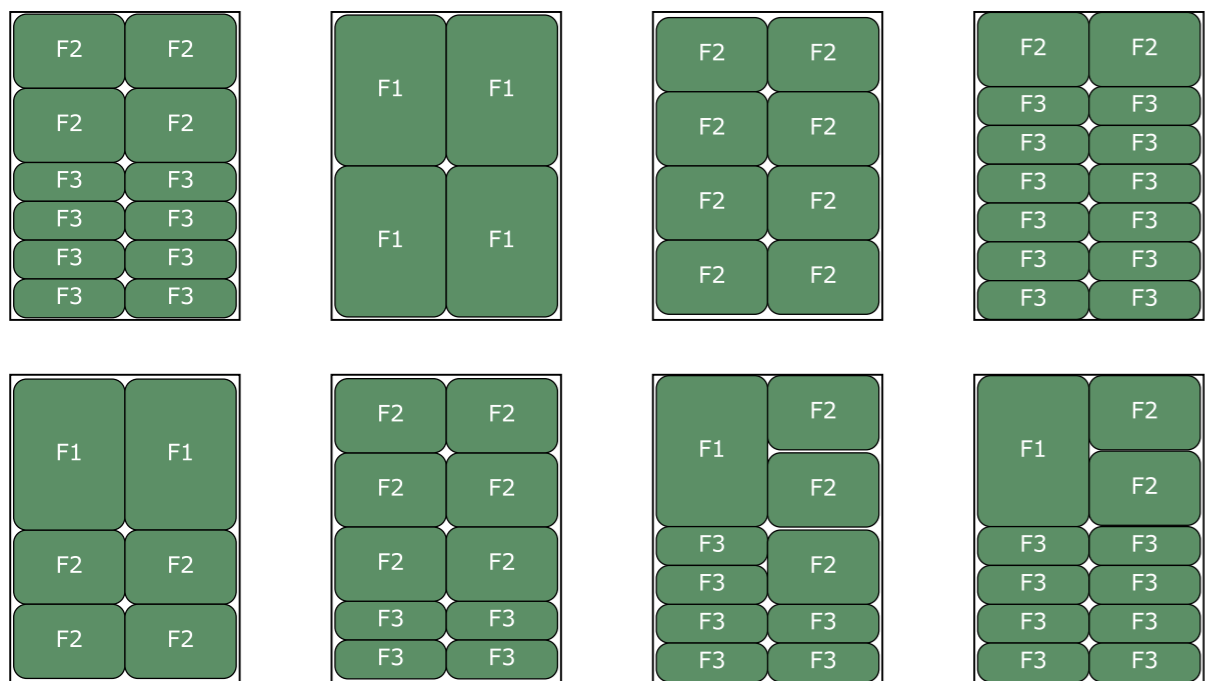

H1 - H2 - H3 per cassettiere: H/ 3 - T/ 3

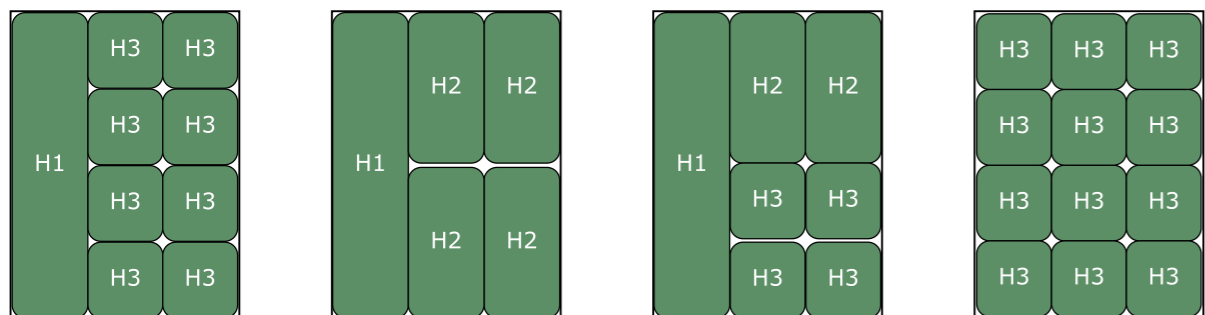

E per cassettiere: E- T/E

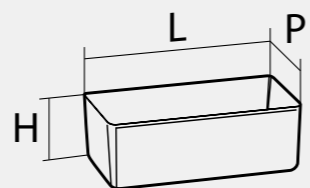
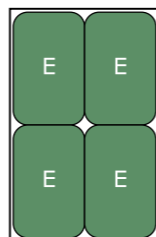

art	L	H	P
E	117	91	74
F1	175	91	129
F2	129	91	86
F3	129	91	45
G1	175	91	108
H1	355	55	88
H2	175	55	88
H3	87	55	88

C-MAXI

Vaschette



F1



F2



F3



H1



H2



H3



E



G1

BRICCOLAGE & FAI DA TE Do it yourself



MOPLA

52



CLASS

56



EASY BOX

62



ESPACE

64



**SCAFFALI
REGOLABILI**

66





SCAFFALI FISSI

68

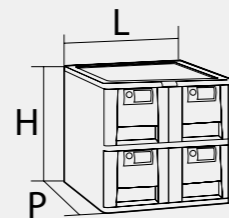

BRICOLAGE & FAI DA TE

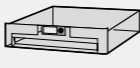

art	L	H	P	Imballo Pz. Pack Qty.	Cassetti Drawers
MOPLA 102	450	420	460	1	2 cassetti: l. 405 - p. 405 - h. 163 
MOPLA 104	450	420	460	1	4 cassetti: l. 180 - p. 405 - h. 163 
MOPLA 104 BIS	450	420	460	1	4 cassetti: l. 405 - p. 405 - h. 63 



ROTELLA CASSETTO GUIDA



BARILOTTO DI SCORRIMENTO



CHIUSURA CON CHIAVE



PIEDINO ANTISDRUCCIOLO



ELEMENTO DI CONNESSIONE ORIZZONTALE E VERTICALE



PORTA CARTELLINO INTERCAMBIABILE

MOPLA

Composizioni



MOPLA 102



MOPLA 104



MOPLA 104 BIS



BRICOLAGE & FAI DA TE

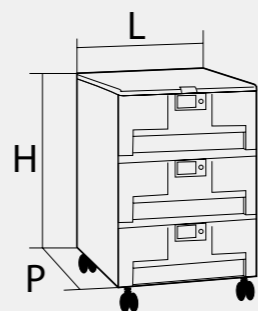

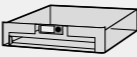
art	L	H	P	Imballo pezzi Pack quantity	Cassetti Drawers
MOPLA 203 R	450	695	460	1	3 cassetti: l. 405 - p. 405 - h. 163 
MOPLA 206 R	450	695	460	1	6 cassetti: l. 405 - p. 405 - h. 63 

Esempi allestimenti cassetti

La vaschetta M10 e le due vaschette M9 hanno posizione fissa e non modificabile (vedi illustrazione sotto).

I vani laterali A e B possono essere allestiti su misura con le vaschette M5 - M6 - M7 - M8.

Cup M10 and both cups M9 are fixed and cannot be removed (see picture below).

The side compartments A and B can be equipped with cups M5 - M6 - M7 - M8.

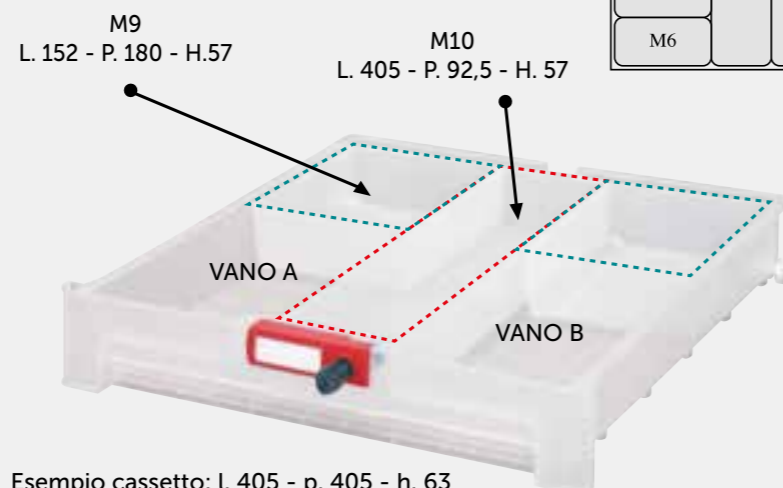
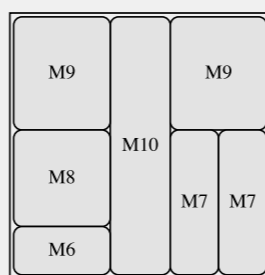
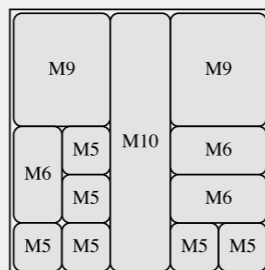

Esempio cassetto: l. 405 - p. 405 - h. 63

MOPLA

Cassettiere con ruote



MOPLA 203 R



MOPLA 206 R

Vaschette x MOPLA 206 R e 104 Bis

TRASPARENTE (TR)



M5
L. 75,5 - P. 75,5 - H.57



M6
L. 151 - P. 75,5 - H.57



M7
L. 228 - P. 75,5 - H.57



M8
L. 151 - P. 151 - H.57



M9
L. 152 - P. 180 - H.57



M10
L. 405 - P. 92,5 - H. 57



**BRICOLAGE
& FAI DA TE**

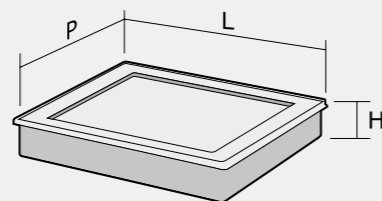

art	L	H	P	H utile	Imballo pezzi Pack quantity
CLASS 9	130	26	86	20,5	48
CLASS 9VA	130	26	86	19	48
CLASS 10	180	40	125	35,5	36
CLASS 11	268	50	125	45	24
CLASS 12	268	50	125	42,5	24
CLASS 13	268	50	188	45	18
CLASS 14	268	50	188	43	18



CLASS

Organizer



CLASS 9

CLASS 9VA
con 6 vaschette estraibili

CLASS 10

CLASS 11

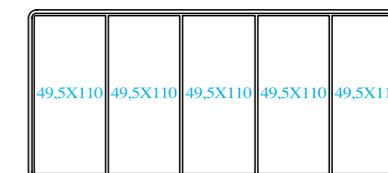
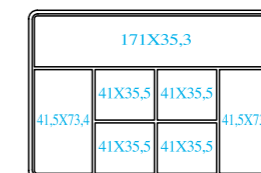
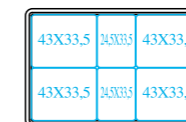
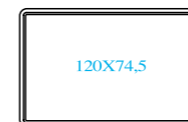

CLASS 12
con 10 vaschette estraibili

CLASS 13

CLASS 14
con 15 vaschette estraibili

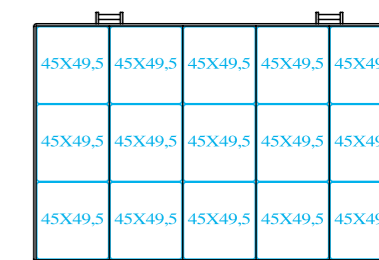
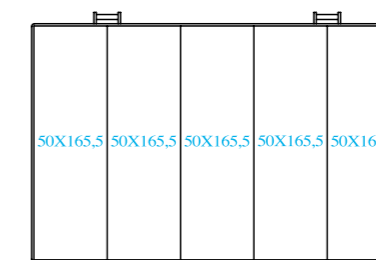

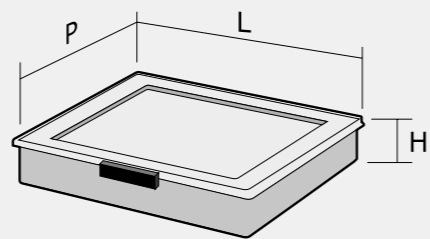

art	L	H	P	H utile	Imballo pezzi Pack quantity
CLASS 18	190	40	155	30	16
CLASS 19	190	40	155	27,5	16
CLASS 20	240	55	186	45	12
CLASS 22	240	55	186	42	12

CLASS

Organizer



CHIUSURA DI SICUREZZA
SECURITY CLOSURE



CLASS 18

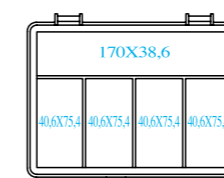

CLASS 19
Con 12 vaschette estraibili

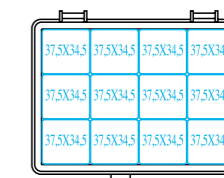

CLASS 20

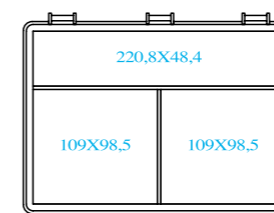

CLASS 22
con 8 vaschette estraibili

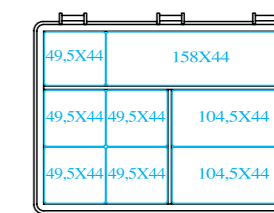



BRICOLAGE & FAI DA TE

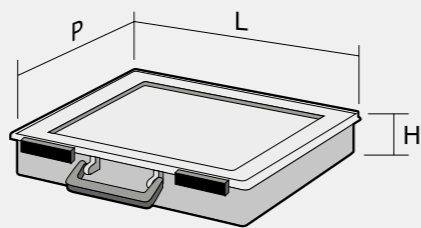

art	L	H	P	H utile	Imballo pezzi Pack quantity
CLASS 30	325	55	260	45	6
CLASS 31	325	55	260	45	6
CLASS 32	325	55	260	42	6
CLASS 41	400	70	340	56	5
CLASS 42	400	70	340	53	5

CLASS Organizer



CLASS 30

CLASS 31

CLASS 32
con 16 vaschette estraibili

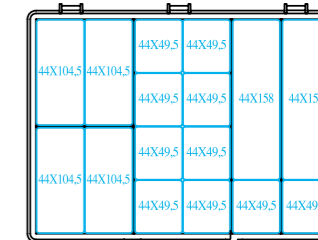
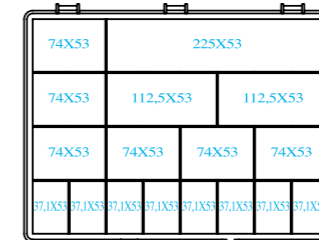
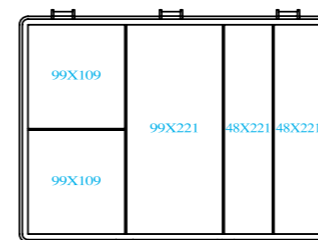

CLASS 41
con 12 divisori estraibili

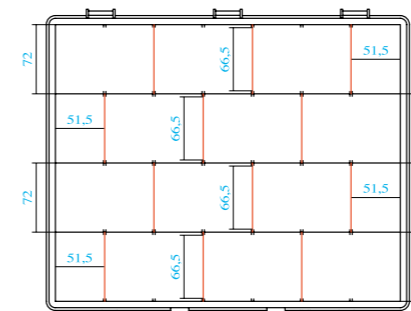

CLASS 42
con 10 vaschette estraibili

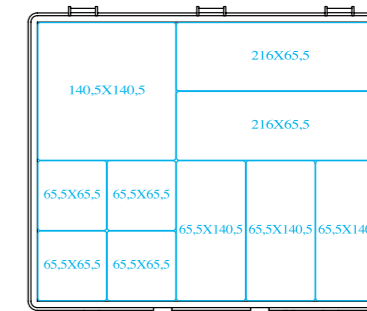

VASCHETTE CLASS

TRASPARENTE (TR)



CLASS 1
L. 55 - P. 50 - H. 45



CLASS 2
L. 110 - P. 50 - H. 45



CLASS 3
L. 165 - P. 50 - H. 45



CLASS 4
L. 40 - P. 43 - H. 30



CLASS 5
L. 76 - P. 76 - H. 57



CLASS 6
L. 152 - P. 76 - H. 57



CLASS 7
L. 228 - P. 76 - H. 57



CLASS 8
L. 152 - P. 152 - H. 57



BRICOLAGE & FAI DA TE

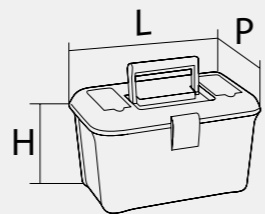

art	L	H	P	Imballo Pezzi Packing Pieces
EASY BOX 12	343	165	229	10
EASY BOX 12/A	343	205	229	8
EASY BOX 16	383	245	263	6
EASY BOX 20	483	267	272	6
EASY BOX 24	565	286	286	3



EASY BOX 16



EASY BOX 12/A



EASY BOX 12



EASY BOX 24



EASY BOX 20

EASY BOX

Portautensili



BRICOLAGE & FAI DA TE

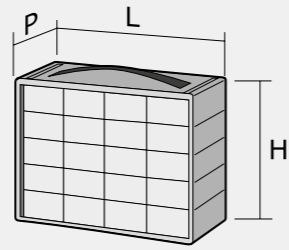

art	L	H	P	Imballo pezzi Pack quantity	Cassetti Drawers
ESPACE 12	220	180	150	12	12 cassetti: l. 60 - p. 137 - h. 37
ESPACE 20	290	225	150	10	20 cassetti: l. 60 - p. 137 - h. 37
ESPACE 30	365	270	150	4	30 cassetti: l. 60 - p. 137 - h. 37



ESPACE

Cassettiere



ESPACE 12
12 cassetti con 12 divisori estraibili



ESPACE 20
20 cassetti con 20 divisori estraibili



ESPACE 30
30 cassetti con 30 divisori estraibili



**BRICOLAGE
& FAI DA TE**

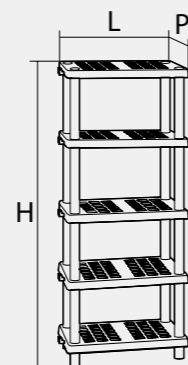

art	L	H	P	Imballo pezzi Pack quantity
TIDY 705	725	1.880	350	1
TIDY 805	825	1.880	400	1
TIDY 905	925	1.880	450	1



Scaffale modulare a 5 ripiani regolabili
in altezza anche a scaffale montato
5 Adjustable shelf unit
height also when assembled

5/10 MIN.
ASSEMBLING



WATER RESISTANT

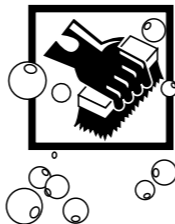

HIGH RESISTANCE
LOADED



TOOLS
NOT REQUIRED



SCAFFALI

Scaffali regolabili



TIDY 705



TIDY 805



TIDY 905





**BRICOLAGE
& FAI DA TE**

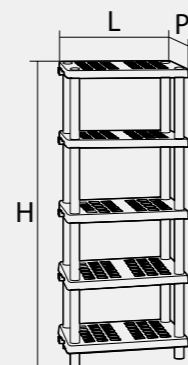

art	L	H	P	Imballo pezzi Pack quantity
TIDY 814	810	1.360	392	1
TIDY 414	392	1.360	392	1
TIDY 212	392	520	392	1

Scaffale modulare a 2 e 4 ripiani
2 and 4 shelf unit



5/10 MIN.
ASSEMBLING



WATER RESISTANT

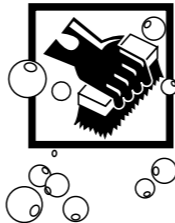

HIGH RESISTANCE
LOADED



TOOLS
NOT REQUIRED



SCAFFALI

Scaffali fissi



TIDY 212



TIDY 414



TIDY 814



PULIZIA & RACCOLTA DIFFERENZIATA

Cleaning & Waste collection



74

BIDONI CARELLATI



78

BIDONI CARELLATI
BICOLORE



80

BIDONE 80



82

BIDONE 100



84

BIDONE
CENTO PUSH



86

NELLO



88

ECO-AIR



90

ECO TOP



92

DUSTY



94

TRESPOLO



96

BIDONI INDUSTRIALI



100

ALTRO



PULIZIA & RACCOLTA DIFFERENZIATA



NELLO
80 litri

OTTANTA
80 litri

CENTO
100 litri

CENTO PUSH
100 litri

CONFRONTO BIDONI

Raccolta differenziata con ruote



1/120/5
120 litri

1/240/5
240 litri



PULIZIA & RACCOLTA DIFFERENZIATA



UNI EN 840
Certificato
Certified

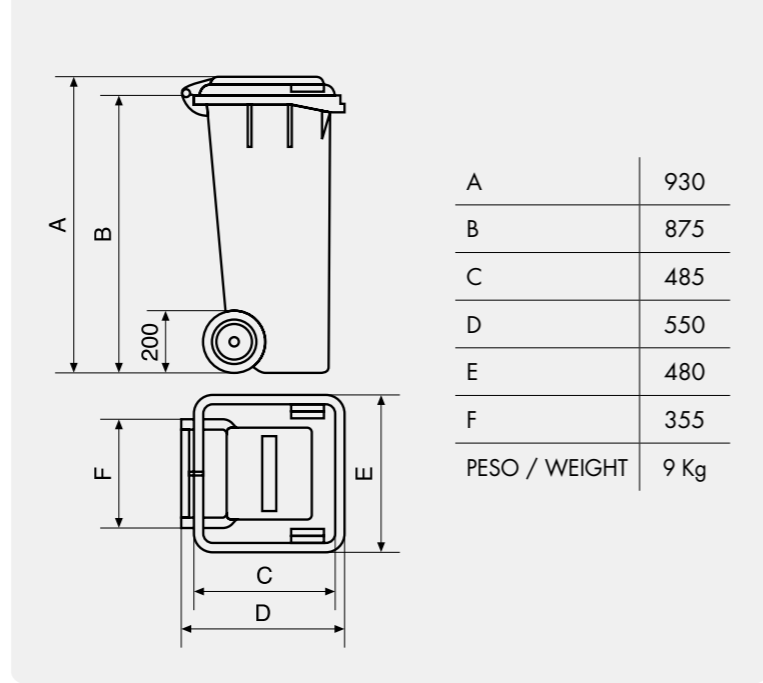

BIDONE PER LA RACCOLTA DIFFERENZIATA

Disponibile in 8 colori, con ruote piene da Ø 200 mm. Prodotto in polietilene ad alta densità di prima scelta (HD-PE), resistente agli agenti chimici, non attaccabile dai parassiti, non assorbe i liquidi, è lavabile e sterilizzabile. Fornito smontato.

WASTE BIN

Available in 8 colours. It is supplied with wheels - Ø 200 mm. Made in high quality polyethylene (HD-PE), chemical agents and parasite resistant, liquid proof, washable and sterilizable.



1/120/5
120 litri

BIDONI CARRELLATI

120 litri

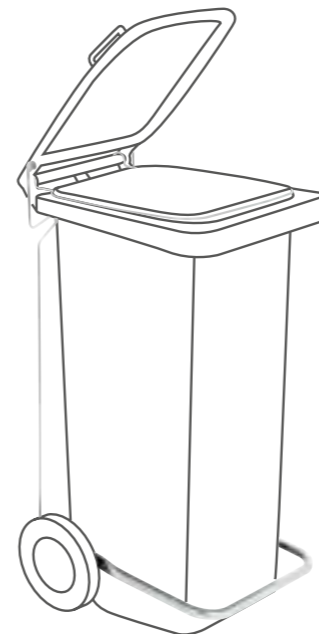

1204

Kit pedale + anello per bidone 120 l.
120 l. bin pedal and ring



1/ 120

Anello fermasacco per bidone 120 l.
120 l. bin ring



95/ 120

Sacchetti immondizia per bidone
raccolta differenziata 120 l.
Bin liners 120 l. waste bin



1/120/5
120 litri



PULIZIA & RACCOLTA DIFFERENZIATA



UNI EN 840
Certificato
Certified

BIDONE PER LA RACCOLTA DIFFERENZIATA

Disponibile in 8 colori, con ruote piene da Ø 200 mm. Prodotto in polietilene ad alta densità di prima scelta (HD-PE), resistente agli agenti chimici, non attaccabile dai parassiti, non assorbe i liquidi, è lavabile e sterilizzabile. Fornito smontato.

WASTE BIN

Available in 8 colours. It is supplied with wheels - Ø 200 mm. Made in high quality polyethylene (HD-PE), chemical agents and parasite resistant, liquid proof, washable and sterilizable.

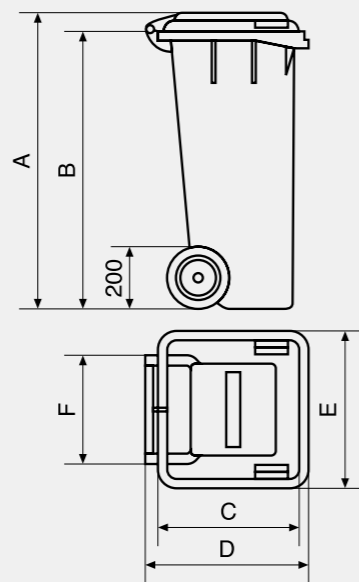

A	1070
B	995
C	655
D	730
E	580
F	420
PESO / WEIGHT	13 Kg

BIDONI CARRELLATI

240 litri

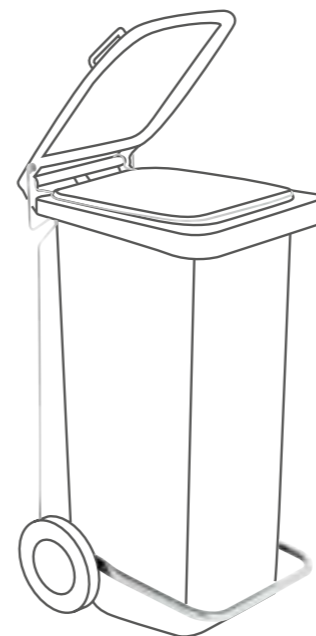

2404

Kit pedale + anello per bidone 240 l.
240 l. bin pedal and ring



1/240

Anello fermasacco per bidone 240 l.
240 l. bin ring



95/240

Sacchetti immondizia per bidone
raccolta differenziata 240 l.
Bin liners 240 l. waste bin



1/240/5
240 litri



1/240/5
240 litri



PULIZIA & RACCOLTA DIFFERENZIATA

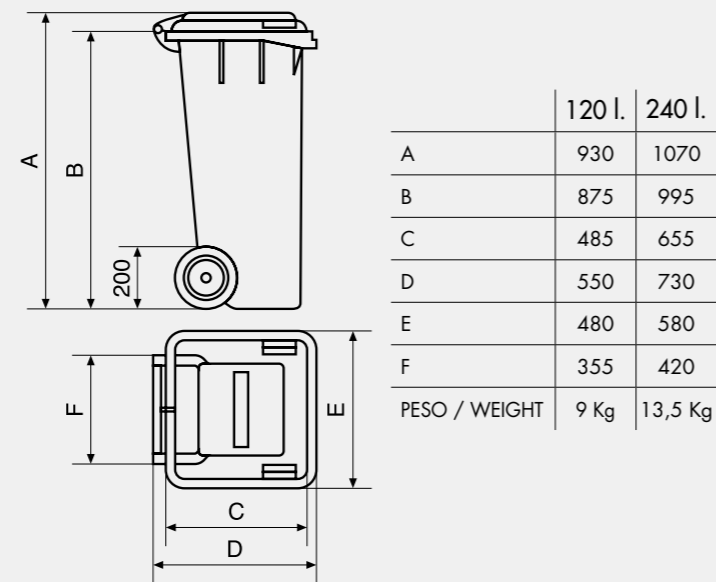

Adesivi in dotazione (non applicati)
Stickers supplied (not applied)

BIDONE BICOLORE PER LA RACCOLTA DIFFERENZIATA

Prodotto in polietilene ad alta densità di prima scelta (HD-PE), resistente agli agenti chimici, non attaccabile dai parassiti, non assorbe i liquidi, è lavabile e sterilizzabile. Disponibile con corpo grigio e coperchio rosso, blu, verde, e giallo.

BICOLORED WASTE BIN

Made in high quality polyethylene (HD-PE), chemical agents and parasite resistant, liquid proof, washable and sterilizable. Available with grey body and lids in red, blue, green and yellow colour.

BIDONI CARRELLATI

bicolor 120/240 litri

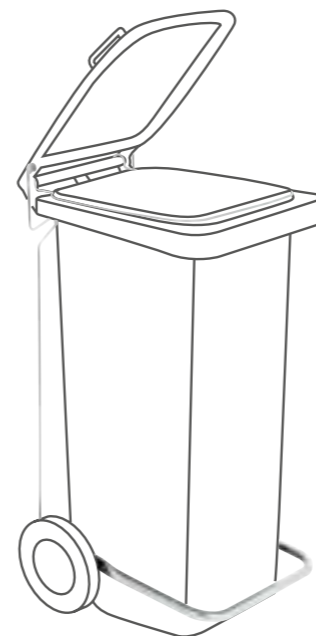

1204 - 2404

Kit pedale + anello per bidone 120 l. - 240 l.
120 l. - 240 l. bin pedal and ring



1/120 - 1/240

Anello fermasacchetto per bidone 120 l. - 240 l.
120 l. - 240 l. bin ring



UNI EN 840
Certificato
Certified



95/120 - 95/240

Sacchetti immondizia per bidone raccolta differenziata 120 l. - 240l.
Bin liners 120 l. - 240 l. waste bin



1/120/5
120 litri



1/240/5
240 litri



PULIZIA & RACCOLTA DIFFERENZIATA

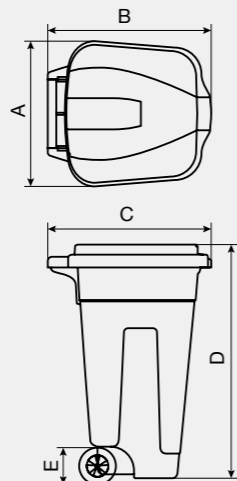

A	450
B	500
C	500
D	780
E	120
PESO / WEIGHT	3 Kg

Bidoni per la raccolta differenziata da 80 litri particolarmente adatti per utilizzo interno in tutti gli ambienti. Presente in 4 colori (giallo, verde, rosso e blu) con base grigia e una versione totalmente per utilizzi specifici

Waste Bin 100 l

Wheelie bins suitable for internal use in all locations (offices, industries, communities...)



Art. 804
Kit pedale optional
Pedal kit optional



BIDONE OTTANTA

80 litri



Maniglia ergonomica e rinforzata per facilitarne il trasporto

Ergonomic and thicker handle for an easy handling



Dotato di 4 ganci fermasacco

With 4 hooks keep bag



Bidone facilmente impilabile con ruote montate

Easy stackable bins with preassembled wheels



Alta scorrevolezza delle ruote antisdrucciolo ed estrema maneggevolezza nello spostamento

No-slip wheels and easy to manoeuvre



Ruote e assali premontati, meno errori e più facilità di spedizione con bloccaggio delle ruote per l'utilizzo finale
Wheels and axles already assembled, fast delivery and less problems. Wheels with brake for final use



OTTANTA
80 litri



PULIZIA & RACCOLTA DIFFERENZIATA

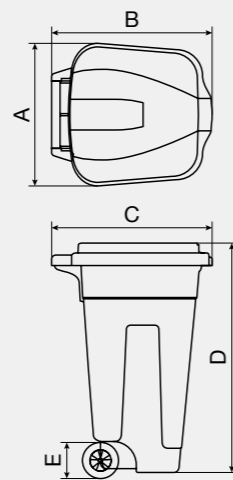

A	490
B	540
C	540
D	850
E	143
PESO / WEIGHT	3,70 Kg

Bidoni per la raccolta differenziata da 100 l particolarmente adatti per utilizzo interno in tutti gli ambienti. Presente in 4 colori (giallo, verde, rosso e blu) con base grigia.

Waste Bin 100 l

Wheelie bins suitable for internal use in all locations (offices, industries, communities...)



CENTO
100 litri

BIDONE CENTO

100 litri



Coperchi con chiusura a clip
Clip down lid



Maniglia ergonomica e rinforzata per facilitarne il trasporto
Ergonomic and thicker handle for an easy handling



Dotato di 4 ganci fermasacco
With 4 hooks keep bag



Bidone facilmente impilabile con ruote montate
Easy stackable bins with preassembled wheels



Alta scorrevolezza delle ruote antiscivolo ed estrema maneggevolezza nello spostamento
No-slip wheels and easy to manoeuvre



Ruote e assali premontati, meno errori e più facilità di spedizione con bloccaggio delle ruote per l'utilizzo finale
Wheels and axles already assembled, fast delivery and less problems. Wheels with brake for final use





PULIZIA & RACCOLTA DIFFERENZIATA

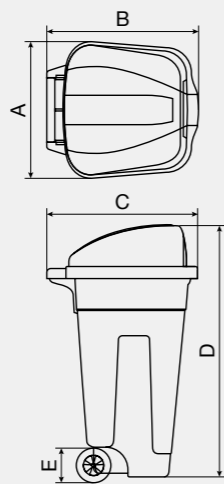

A	490
B	540
C	540
D	950
E	143
PESO / WEIGHT	3,86 Kg

Bidoni per la raccolta differenziata da 100 l
particolarmente adatti per utilizzo interno in tutti gli ambienti. Presente in 4 colori (giallo, verde, rosso e blu) con base grigia.

Waste Bin 100 l
Wheelie bins suitable for internal use in all locations (offices, industries, communities...)



BIDONE CENTO PUSH

100 litri



Coperchi con chiusura a clip
Clip down lid



Maniglia ergonomica e rinforzata per facilitarne il trasporto
Ergonomic and thicker handle for an easy handling



Dotato di 4 ganci fermasacchetto
With 4 hooks keep bag



Bidone facilmente impilabile con ruote montate
Easy stackable bins with preassembled wheels



Alta scorrevolezza delle ruote antiscivolo ed estrema maneggevolezza nello spostamento
No-slip wheels and easy to manoeuvre



Ruote e assali premontati, meno errori e più facilità di spedizione con bloccaggio delle ruote per l'utilizzo finale
Wheels and axles already assembled, fast delivery and less problems. Wheels with brake for final use



Campana basculante per bidone Cento Push
Flap lid for bin Cento Push



CENTO PUSH
100 litri



PULIZIA & RACCOLTA DIFFERENZIATA

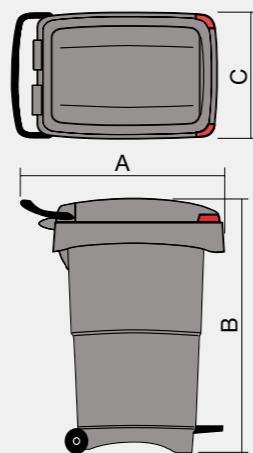

A	650
B	810
C	400
PESO / WEIGHT	6,20 Kg

Nello è un bidone di nuova concezione che si distingue innanzitutto per il felice connubio estetico-funzionale evidenziato da linee morbide e ben raccordate tra loro. Dotato di ruote e comoda maniglia per spostamenti veloci e sicuri, pedale di apertura e anello reggisacco. Si adatta agli ambienti di lavoro professionale e hobbistico, come officine, garage, laboratori industriali.

151-GRN completo di n. 8 tappi in 4 colori per una corretta identificazione della differenziata.

Nello is a new-concept bin, which combines beauty and functionality stressed by an elegant and harmonic design. Equipped with wheels and a handle for fast and safe movings, an opening pedal and a sac holder ring. It is suitable for internal use in all locations (workshops, garages, studios).

151-GRN includes a set of nr 8 cups in 4 different colours for a right waste separation and identification.



Fornito in kit d'assemblaggio
Supplied in assembly kit

BIDONE NELLO

80 litri





PULIZIA & RACCOLTA DIFFERENZIATA

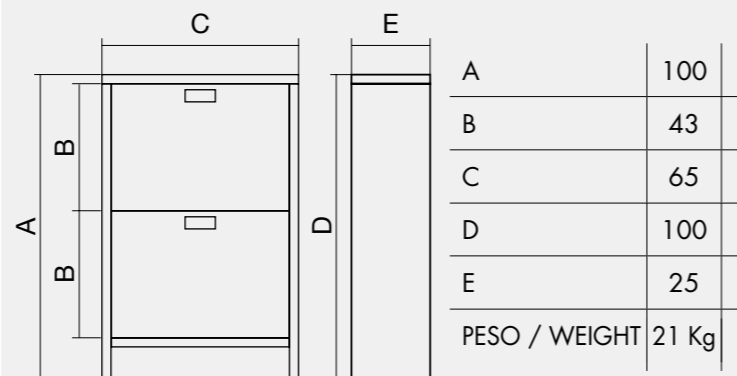

Mobiletto in lamiera elettrosaldata verniciato a forno in polvere epossidica

a due ribalte sovrapposte contenenti due secchi da 20 l ognuna.

A - Aerazione, ventilazione: il mobiletto è dotato di griglie di aerazione che hanno lo scopo di favorire la fermentazione dei residui organici e di smaltire l'odore sgradevole.

B - Robusti piedi, sollevato da terra per una agevole pulizia.

Cabinet in electro welded plate painted by epoxy powder oven.

with two superposed tilt drawers including two 20 l. buckets each.

A - Airing/ ventilation: the cabinet is equipped with grates that help fermentation of the organic refusal and discharge the unpleasant odours.

B - Strong feet, lifted base to allow an easy cleaning.

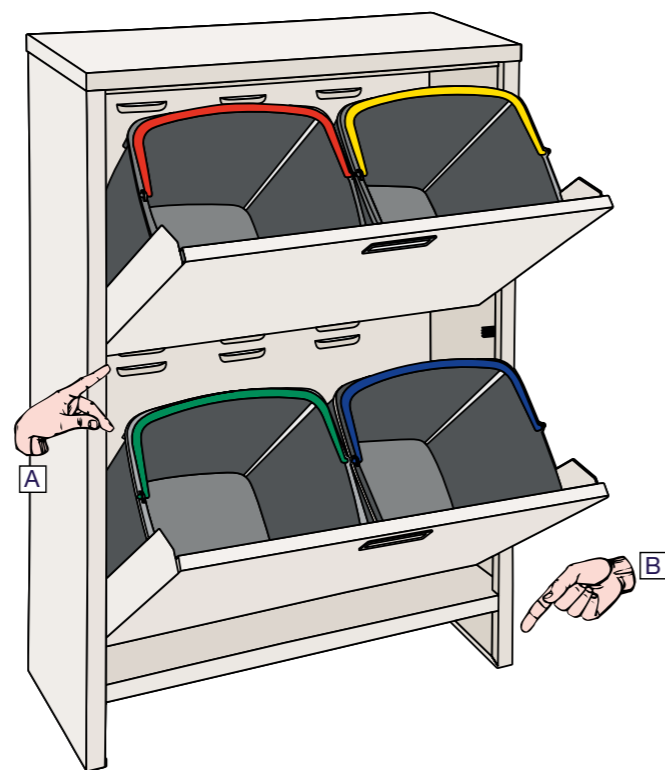

ECO-AIR 4

Mobiletto ventilato



100/4-GR
Completo di 4 secchi
Complete with 4 buckets



KIT 100/4-MIX
Ordinabile anche separatamente
To be order also separately



Aerazione, ventilazione
Airing, ventilation



PULIZIA & RACCOLTA DIFFERENZIATA

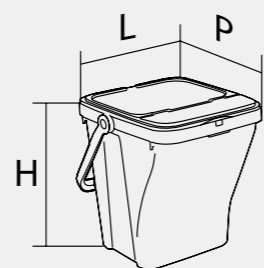

art	L	H	P	Imballo pezzi Pack quantity
26/35	390	425	420	4

ECO-TOP: contenitori portarifiuti in PP riciclabile 100% con sportello a becco con apertura e chiusura basculante - Ideali per raccolta differenziata

Resistenti al gelo e al calore, agli agenti chimici, ai raggi UV e all'invecchiamento, prodotti con stabilizzanti anti-UV

Totale assenza di spigoli vivi con superfici esterne ed interne completamente lisce, impilabili e sovrapponibili

Preso ergonomica sul fondo per facilitare lo svuotamento

Maniglia ergonomica e rinforzata con blocco in verticale

Coperchio con cerniere rinforzate e ribassate ad apertura 270°

ECO-TOP: waste bins in 100% recyclable PP with tilt opening and closing

Perfect for separate collection

Resistant to freezing and heating, chemical agents, UV rays and aging because produced with anti-UV stabilizers

No sharp edges with smooth internal and external surfaces stackable

Ergonomic grip on the bottom for easy emptying

Ergonomic and reinforced handle with vertical locking

Reinforced hinges on the cover with opening at 270°

PORTARIFIUTI ECO-TOP

35 litri



26/35





PULIZIA & RACCOLTA DIFFERENZIATA

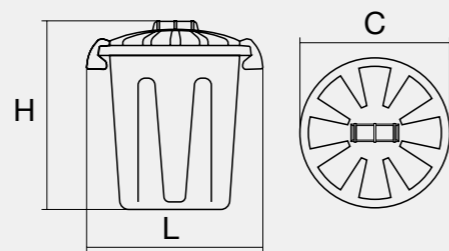

art	L	H	C	Imballo pezzi Pack quantity
105/25	400	450	360	5

Pratico bidone portarifiuti da 25 litri, con coperchio dotato di chiusura a clip

Realizzato in polipropilene (PP) riciclabile 100%

Design moderno, si adatta a tutti gli ambienti

Disponibile con bidone di colore grigio e 4 varianti di colore per il coperchio utili per la raccolta differenziata

Practical 25 liter waste bin, with lid equipped with clip closures

Made of 100% recyclable polypropylene (PP)

Modern design, adapts to all environments

Available with gray bin and 4 color variations for the lid useful for recycling



BIDONE DUSTY

25 litri



105/25



PULIZIA & RACCOLTA DIFFERENZIATA

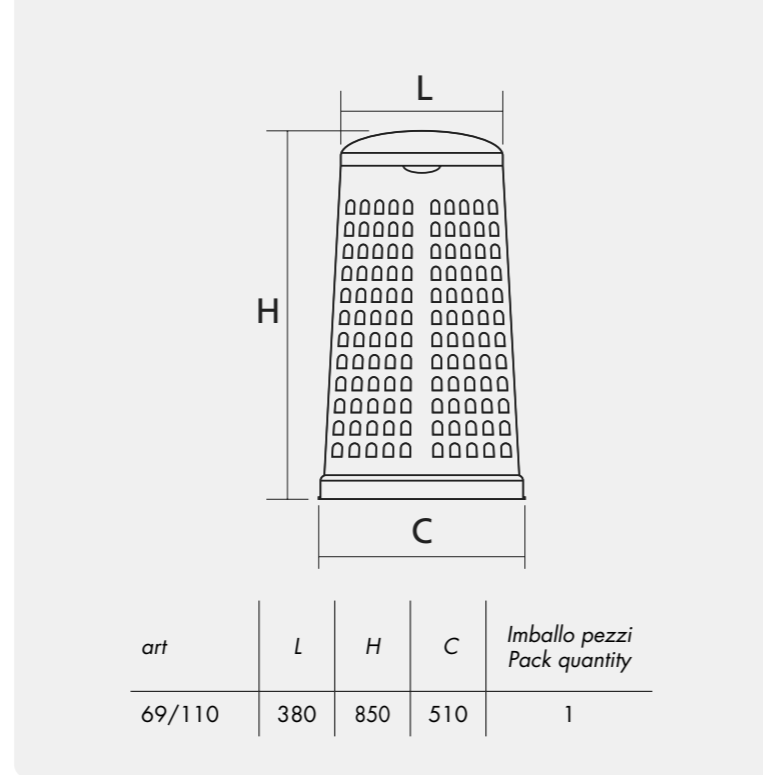

Trespolo leggero e facilmente sollevabile.
Pratico e semplice da utilizzare.
Lavabile e sterilizzabile.
Estremamente versatile per ogni tipo di rifiuto perchè prevede l'utilizzo del sacco raccogli immondizia, che viene fissato tramite l'anello ferma-sacco.
Ecologico, costruito in polietilene alta densità 100 % riciclabile.
Impilabile, occupa poco spazio in altezza.
È facilmente impilabile anche con il coperchio montato.

Lightweight and easily liftable mesh waste bin.
Practical and easy to use.
Washable and sterilizable.
Suitable for each kind of waste, bag tie to ensure the bin bag stays secure.
Ecological, made of 100 % recyclable PEHD.
Stackable, it takes up little space in height.
Easily stackable also with preassembled lid.



TRESPOLO

110 litri



69/110



PULIZIA & RACCOLTA DIFFERENZIATA

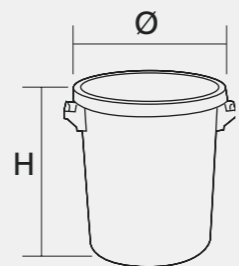

art.	Capacità Capacity	h	Ø
92/035	35 l.	41	39
92/050	50 l.	47	46
92/075	75 l.	57	48
92/100	100 l.	67	52
92/150	150 l.	71	62
92/200	200 l.	81	67
92/300	300 l.	89	76

BIDONI INDUSTRIALI

Da 35 a 300 litri



92/035

92/050

92/075

92/100



PP 27/035



PP 27/050



PP 27/075



PP 27/100

PP

GRIGIO (GR)



Art. 19/1
Carrello per bidone industriale 75-100 l.
 A seconda del lato in cui vengono montate le ruote è adatto al trasporto di bidoni da 75 litri o da 100 litri.

75-100 l. Industrial bin trolley
 You can fit the wheels in both sizes, one size is suitable for the 75 litres industrial bin and one for the 100 litres bin.

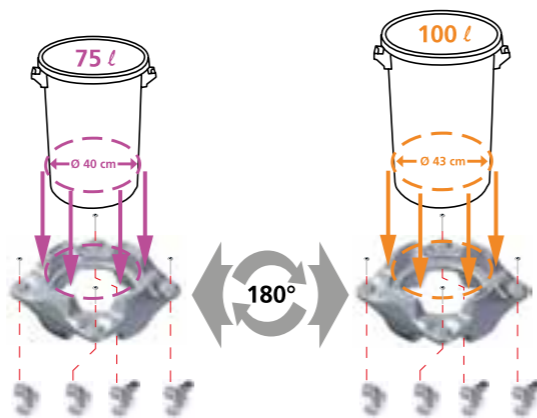

92/150



92/200



92/300



27/150



27/200



27/300



PULIZIA & RACCOLTA DIFFERENZIATA

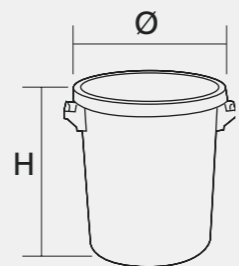

art.	Capacità Capacity	h	Ø
8/0035	35 l.	41	39
8/0050	50 l.	47	46
8/0075	75 l.	57	48
8/0100	100 l.	67	52
8/0150	150 l.	71	62
8/0200	200 l.	81	67

BIDONI INDUSTRIALI

Da 35 a 200 litri



8/0035



8/0050



8/0075



PP 77/035



PP 77/050



PP 77/075



8/0100



8/0150



8/0200



PP 77/100



77/150



77/200

PP

GRIGIO (GR)



Art. 19/1
Carrello per bidone industriale 75-100 l.
A seconda del lato in cui vengono montate le ruote è adatto al trasporto di bidoni da 75 litri o da 100 litri.

75-100 l. Industrial bin trolley
You can fit the wheels in both sizes, one size is suitable for the 75 litres industrial bin and one for the 100 litres bin.

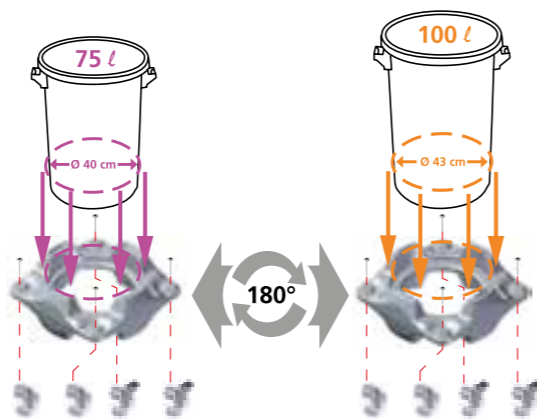



PULIZIA & RACCOLTA DIFFERENZIATA

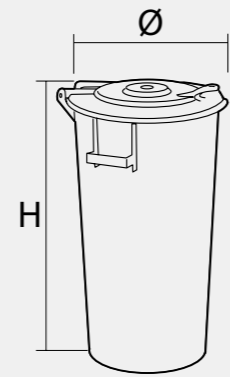

art.	Capacità Capacity	h	Ø
91/060	60 l.	60	45
91/080	80 l.	70	45
91/100	100 l.	88	45



●
NERO (NE)

ALTRO PULIZIA

Bidone con coperchio Bin with hinged lid



91/060



91/080



91/100



Cestino gettacarta Waste-paper basket

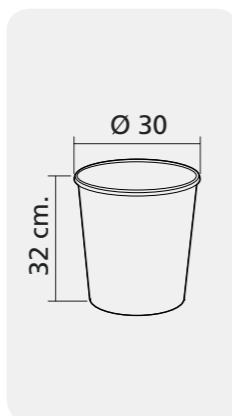

107/30

● NERO (NE) ● BRUNO RAME (BRR) ● GRIGIO (GR)



Alzaimmondizia con manico Standing dustpan

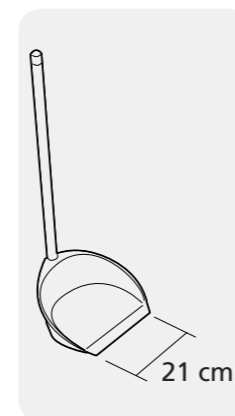

● BRUNO RAME (BRR)



Paletta polvere Dustpan



● BRUNO RAME (BRR)



ENOLOGIA & AGRICOLTURA

Enology & Agriculture



104

CASSE



106

MASTELLI CANTINA



108

BIDONI CANTINA



110

ALTRO ENOLOGIA



112

CANTINETTA
E CESTELLI



114

INNAFFIATOI



116

MASTELLI AGRICOLTURA



**ENOLOGIA &
AGRICOLTURA**

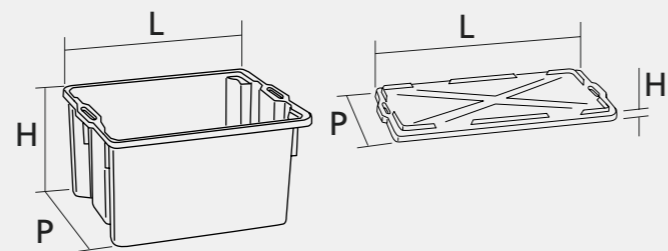

art.	L	H	P	Capacità Capacity
131/50	55	31	43	50 l.
131/65	63	34	44	65 l.
131/90	72	36	47	90 l.
133/50	57	3	43	-
133/65	65	3	45	-
133/90	75	3,5	47	-



CASSE

Inseribili e sovrapponibili



131/50

131/65

131/90



133/50 - 133/65 - 133/90
COPERCHIO PER CASSA
CRATE LID



ENOLOGIA & AGRICOLTURA

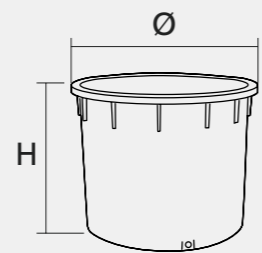

art.	H	Ø	Capacità Capacity	
2/0110	30	80	110 l.	sottotino
2/0275	35	110	275 l.	sottotino
2/0225	54	86	225 l.	
2/0350	71	95	350 l.	
2/0500	82	104	500 l.	
2/0700	90	115	700 l.	
2/1000	95	134	1000 l.	

MASTELLI CANTINA



17

Filtro svinarola per
rubinetto 1"

Wine filter 1" tap

PP



20/1

Rubinetto 1"

Tap 1"

PP



150

Maniglia per
mastello

Handle tub



2/0110

2/0275

2/0225

2/0350



2/0500

2/0700

2/1000



32/500

32/700



**ENOLOGIA &
AGRICOLTURA**

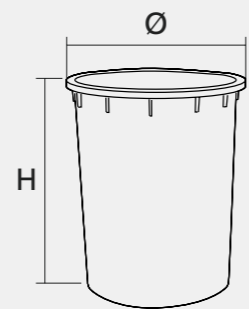

art.	Capacità Capacity	h	Ø
13/150	150 l.	71	62
13/200	200 l.	81	67
13/300	300 l.	89	76

BIDONI CANTINA



20/3/4

Rubinetto 3/ 4"

Tap 3/ 4"



13/150

13/200

13/300



32/150



32/200



32/300



ENOLOGIA & AGRICOLTURA



CESTO TONDO

ART. 53

Cesto tondo con manico in plastica
Round basket with plastic handle
15 L.



ART. 53/F

Cesto tondo con manico in ferro
Round basket with iron handle
15 L.



PRODOTTI IN MATERIALE RICICLABILE

CESTO OVALE

ART. 74

Cesto ovale con manico in plastica
Oval basket with plastic handle
20 L.



ART. 74/F

Cesto ovale con manico in ferro
Oval basket with iron handle
20 L.



PRODOTTI IN MATERIALE RICICLABILE

ALTRO ENOLOGIA

MASTELLO 2 MANICI



126



art.	H	Ø	Capacità Capacity
126	45	49	50 l.

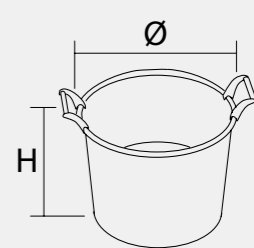

PRODOTTI IN MATERIALE RICICLABILE

TIRA OLIO



NEUTRO (N)

Art. 63

Tira olio
Oil-siphon
0,5 L.



PRODOTTI IN MATERIALE RICICLABILE



ENOLOGIA & AGRICOLTURA



Cantinetta a 6 posti
Six bottle holder

SOVRAPPONIBILE



BRUNO RAME (BRR)



PRODOTTI IN
MATERIALE
RICICLABILE

CANTINETTA & CESTELLI

Cestello porta bottiglie a
6 posti
Stackable six bottle crate



ROSSO (ROM)

VERDE (VET)



PRODOTTI IN
MATERIALE
RICICLABILE

Cestello porta bottiglioni
a 4 posti
Stackable four bottle crate



ROSSO (ROM)

VERDE (VET)



PRODOTTI IN
MATERIALE
RICICLABILE



ENOLOGIA & AGRICOLTURA



art.	Capacità Capacity
87/02	2 l.
87/04	4 l.
87/08	8 l.
87/12	12 l.
87/16	16 l.

Gamma di innaffiatoi estremamente robusti e dal design tradizionale, con riserva d'acqua e comoda impugnatura.

Range of extremely robust watering cans with a traditional design, water reserve and comfortable handle.



INNAFFIATOI



87/02



87/04



87/08



87/12



87/16



**ENOLOGIA &
AGRICOLTURA**

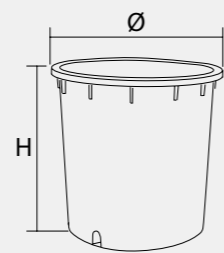

art.	H	Ø	Capacità Capacity
8/0110	30	80	110 l.
8/0225	54	86	225 l.
8/0350	71	95	350 l.
8/0500	82	104	500 l.
8/0700	90	115	700 l.
8/1000	95	134	1000 l.

MASTELLI AGRICOLTURA



17

Filtro svincola per
rubinetto 1"

Wine filter 1" tap

PP



20/1

Rubinetto 1"

Tap 1"

PP



150

Maniglia per
mastello

Handle tub



8/0110



8/0225



8/0350



8/0500



8/0700



8/1000



77/500



77/700

TRASPORTO LIQUIDI & INDUSTRIA ALIMENTARE

Liquid transport & food industry



120

TANICHE



122

FUSTINI A
BOTTICELLA



124

BIDONI COLLO
LARGO



126

TANICHE BENZINA



128

BIDONI INDUSTRIALI
PER ALIMENTI



132

CASSE ALIMENTARI
E FOODBOX



136

CASSETTE 60 X 40
E LIGHTBOX



140

MASTELLI



142

IMBUTI



144

SECCHI



146

CARAFFE



148

SESSOLE



TRASPORTO LIQUIDI & INDUSTRIA ALIMENTARE



art.	Capacità Capacity
125/01	1 l.
125/02	2 l.
125/03	3 l.
125/05	5 l.
* 125/10	10 l.
* 125/15	15 l.
* 125/20	20 l.
* 125/25	25 l.
* 125/30	30 l.
73/10	10 l.
73/20	20 l.
61	15 - 3,5 l.



* Versatore telescopico incluso
* Telescopic pourer included

TANICHE

Tanica Tank



125/01

125/02

125/03

125/05



125/10

125/15

125/20

125/25

125/30

Tanica due usi Tank double use



1,5 - 3,5 LITRI

Tanica con rubinetto Tank with tap



10 LITRI

20 LITRI



TRASPORTO LIQUIDI & INDUSTRIA ALIMENTARE

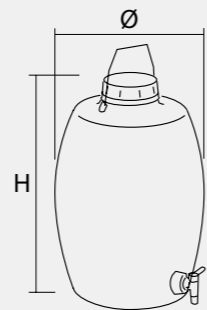

art.	Capacità Capacity	h	Ø
97/005	5 l.	28	18
97/010	10 l.	32	23
97/015	15 l.	37	27
97/020	20 l.	41	29
97/025	25 l.	44	32
97/050	50 l.	56	39
97/100	100 l.	71	49

PARTICOLARE



ACCESSORI ACCESSORIES



PP 20/1/4
Rubinetto 1/4"
Tap 1/4"

FUSTINI A BOTTICELLA



97/005

97/010

97/015

97/020



97/025

97/050

97/100



**TRASPORTO
LIQUIDI &
INDUSTRIA
ALIMENTARE**

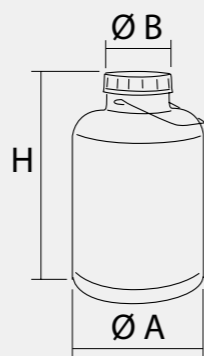

art.	Capacità Capacity	H	Ø A	Ø B
78/02	2 l.	21	14	10
78/05	5 l.	31	16	10
78/10	10 l.	35,5	21,5	11

BIDONI COLLO LARGO



78/02

78/05

78/10



TRASPORTO LIQUIDI & INDUSTRIA ALIMENTARE

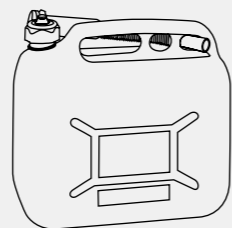

art.	Capacità Capacity
115/05	5 l.
115/10	10 l.

Beccuccio flessibile Pouring spout



Indicatore di livello V-stripe

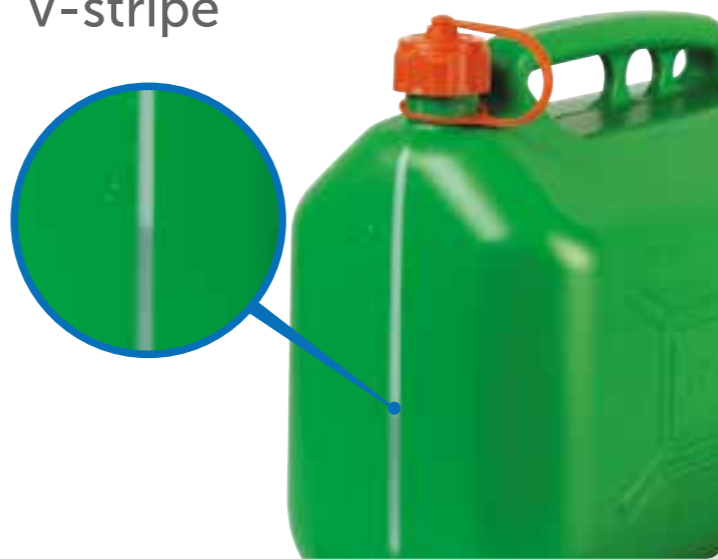

TANICHE BENZINA

Taniche per combustibili liquidi in polietilene alta densità rinforzato.
Dotate di travasatore flessibile avvitabile.
Tappo di chiusura ermetico con anello di sicurezza.
Omologazione UN a norma direttive CEE.
Con indicatore di livello

Jerry can for liquid fuel in reinforced high density polyethylene.
Provided with flexible screw pouring spout.
Sealed cap with safety ring.
All size are of UN approved standard and specification.
With level indicator



115/05

115/10



TRASPORTO LIQUIDI & INDUSTRIA ALIMENTARE

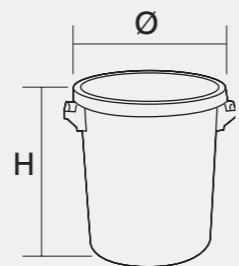

art.	Capacità Capacity	h	Ø
19/035	35 l.	41	39
19/050	50 l.	47	46
19/075	75 l.	57	48
19/100	100 l.	67	52
19/150	150 l.	71	62
19/200	200 l.	81	67
19/300	300 l.	89	76

BIDONI INDUSTRIALI

Da 35 a 300 litri



19/035

19/050

19/075

19/100



PP 59/035



PP 59/050



PP 59/075



PP 59/100



19/150

19/200

19/300

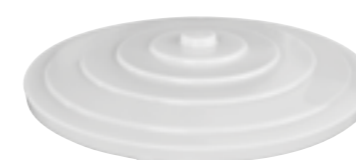

59/150



59/200



59/300

PP

GRIGIO (GR)



Art. 19/1
Carrello per bidone industriale 75-100 l.
A seconda del lato in cui vengono montate le ruote
è adatto al trasporto di bidoni da 75 litri o da 100
litri.

75-100 l. Industrial bin trolley
You can fit the wheels in both sizes, one size is
suitable for the 75 litres industrial bin and one for the
100 litres bin.

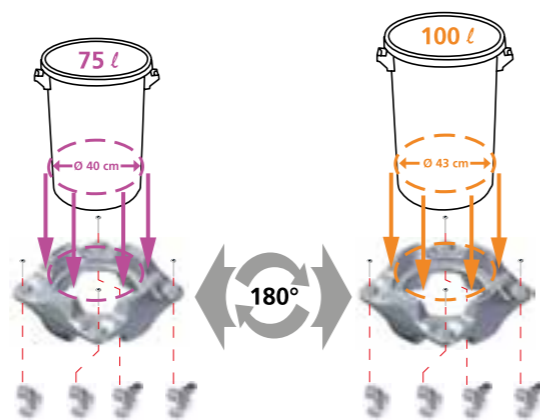



TRASPORTO LIQUIDI & INDUSTRIA ALIMENTARE

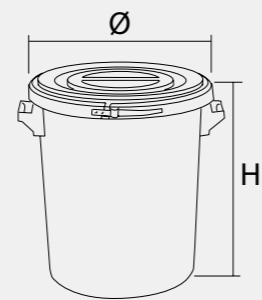

art.	Capacità Capacity	h	Ø
18/075	75 l.	57	48
18/100	100 l.	67	52

PP

GRIGIO (GR)



Art. 19/1
Carrello per bidone industriale 75-100 l.
A seconda del lato in cui vengono montate le ruote
è adatto al trasporto di bidoni da 75 litri o da 100
litri.

75-100 l. Industrial bin trolley
You can fit the wheels in both sizes, one size is
suitable for the 75 litres industrial bin and one for the
100 litres bin.

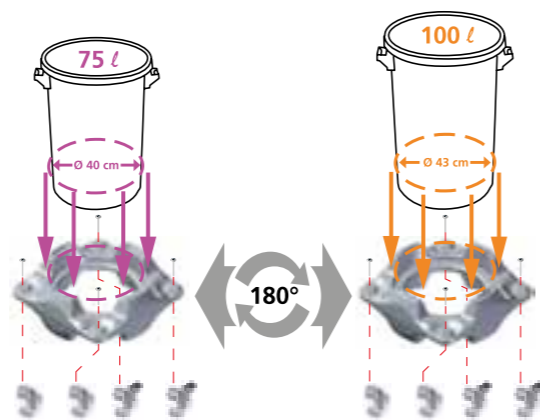

BIDONI INDUSTRIALI

Con chiusura ad anello



18/075



18/100

Contenitore con chiusura ad anello in metallo completo di
guarnizione. Articolo non a tenuta stagna

Metal ring closure bin complete of gasket.
Not leak-proof.





**TRASPORTO
LIQUIDI &
INDUSTRIA
ALIMENTARE**

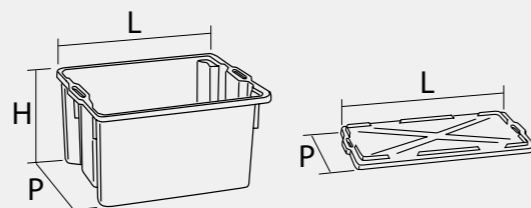

art.	L	H	P	Capacità Capacity
131/50	55	31	43	50 l.
131/65	63	34	44	65 l.
131/90	72	36	47	90 l.
132/50	55	31	43	50 l.
132/65	63	34	44	65 l.
133/50	57	3	43	-
133/65	65	3	45	-
133/90	75	3,5	47	-

CASSE

Inseribili e sovrapponibili



131/50

131/65

131/90



132/50



132/65



133/50 - 133/65 - 133/90
Coperchio per casse 131 - 132
Crate for lid 131 - 132



FOOD BOX

TRASPORTO LIQUIDI & INDUSTRIA ALIMENTARE

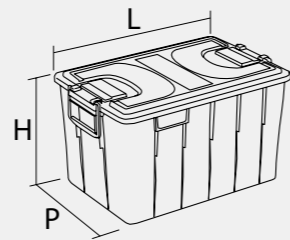

art.	L	H	P	Capacità Capacity
143/20	38	30	28	20 l.
143/40	58	26	38	40 l.
143/60	58	38	38	60 l.

Casse grandi e piccole tra loro sovrapponibili per facilitarne il trasporto, coperchio in dotazione con chiusura

Large and small crate can be put one on the other to facilitate transport, cover with enclosed closures



143/20



143/40



143/60



Porta targhetta
Tag holder



**TRASPORTO
LIQUIDI &
INDUSTRIA
ALIMENTARE**

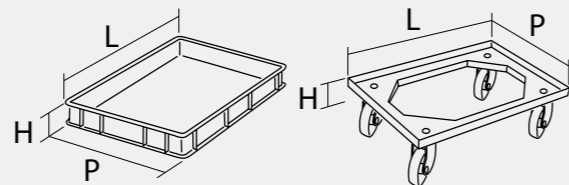

art.	L	H	P
4407	60	7	40
4410	60	10	40
4413	60	13	40
4400	60	-	40
5800	62	14	42



impilabili



temperatura
esercizio



CASSETTE

60 x 40



4407



4410



4413

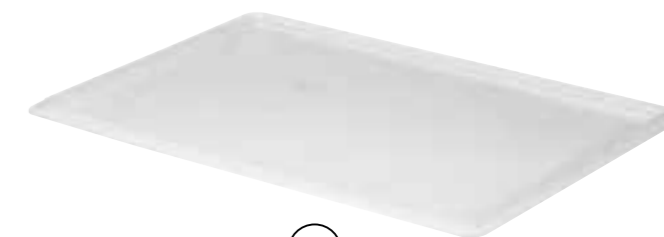

PP

4400

Coperchio per casse
Crate lid

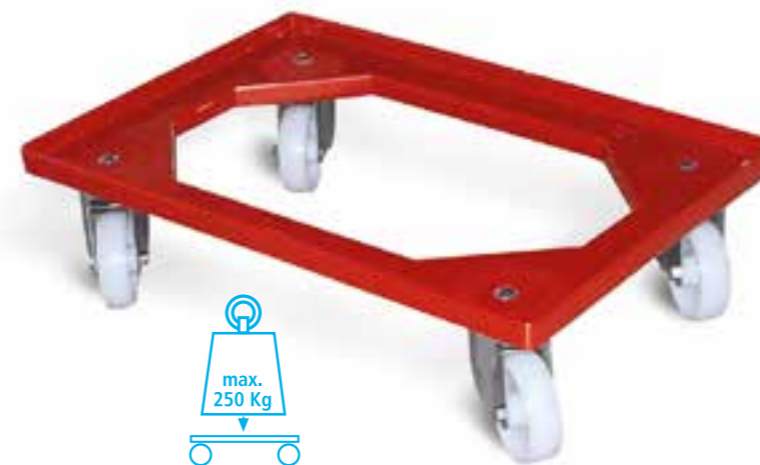

ABS

5800

Carrello per cassetta
Crate trolley



ROSSO BIDONE (ROB)



TRASPORTO LIQUIDI & INDUSTRIA ALIMENTARE

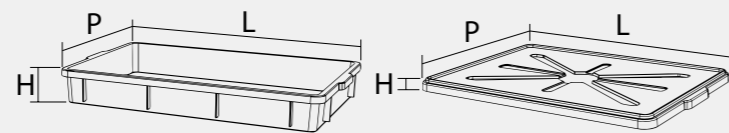

art.	L x P x H Esterne External	L x P x H Interne Internal	Capacità Capacity
5900	655 x 435 x 30	-	-
5908	650 x 425 x 85	600 x 400 x 80	19 l.
5911	650 x 425 x 115	600 x 400 x 110	25 l.



impilabili



temperatura
esercizio
-20 C°
+80 C°



LIGHTBOX

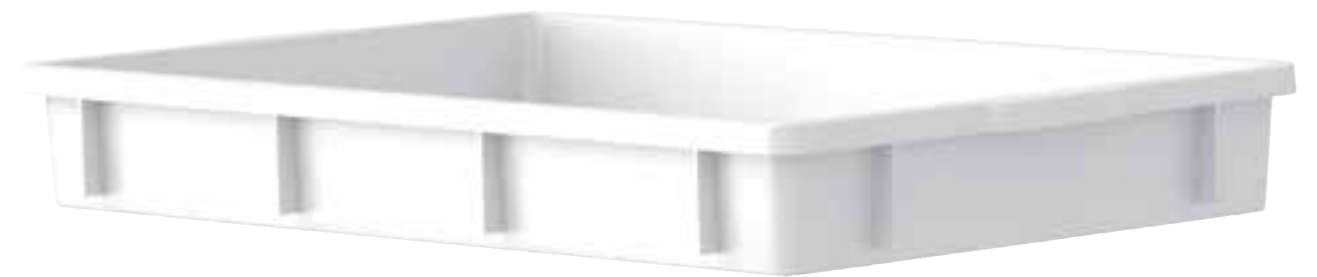

5908

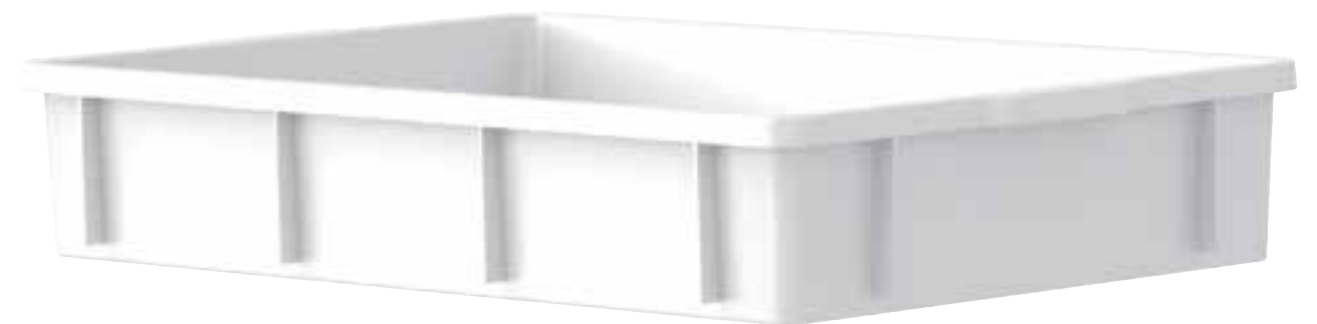

5911



5900

TRASPARENTE (TS)



BIANCO (BIM)

BIANCO (BIM)



PRODOTTI IN
MATERIALE
RICICLABILE



**TRASPORTO
LIQUIDI &
INDUSTRIA
ALIMENTARE**

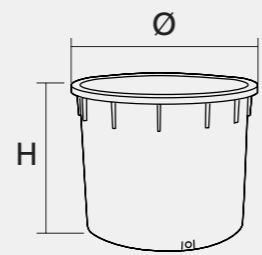

art.	H	Ø	Capacità Capacity	
7/0110	30	80	110 l.	sottotino
7/0275	35	110	275 l.	sottotino
7/0225	54	86	225 l.	
7/0350	71	95	350 l.	
7/0500	82	104	500 l.	
7/0700	90	115	700 l.	
7/1000	95	134	1000 l.	

17

**Filtro svinarola per
rubinetto 1"**

Wine filter 1" tap

PP



20/ 1

Rubinetto 1"

Tap 1"

PP



150

**Maniglia per
mastello**

Handle tub



MASTELLI



7/0110

7/0275

7/0225

7/0350



7/0500

7/0700

7/1000



59/500

59/700



IMBUTI

**TRASPORTO
LIQUIDI &
INDUSTRIA
ALIMENTARE**

Colalatte con filtro
Mix colander with strainer



35
Ø 27 cm.

Imbuto
Funnel



54
Ø 6 - 8 - 10 - 12 - 14 - 16 - 18 - 20 - 22 - 24 - 26 - 30 cm.



Imbuto con tubo flessibile e filtro
Funnel with flexible tube and filter



10/26
Ø 26 cm.

Imbuto con porta filtro
Funnel with filter-support



43
Ø 22 - 26 - 30 - 35 cm.



ART. 147/10
Filtro Ø 10 cm.
per imbuto Ø 22 cm.
Filter Ø 10 cm.
for funnel Ø 22 cm.



ART. 147/12
Filtro Ø 12 cm.
per imbuto Ø 26 - 30 - 35 cm.
Filter Ø 12 cm.
for funnel Ø 26 - 30 - 35 cm.



**TRASPORTO
LIQUIDI &
INDUSTRIA
ALIMENTARE**



art.	Capacità Capacity
65/12	12 l.
65/15	15 l.
65/18	18 l.

**SECCHIO INDUSTRIALE GRADUATO
GRADUATED INDUSTRIAL BUCKET**

SECCHI INDUSTRIALI



65/12



65/15



65/18



65 GRI	—
65 N	



**TRASPORTO
LIQUIDI &
INDUSTRIA
ALIMENTARE**



art.	Capacità Capacity
6/0500	0,5 l.
6/1000	1 l.
6/2000	2 l.
6/3000	3 l.
6/5000	5 l.

**CARAFFA GRADUATA
GRADUATED JUG**

CARAFFE



6/0500



6/1000



6/2000



6/3000



6/5000



**TRASPORTO
LIQUIDI &
INDUSTRIA
ALIMENTARE**



art.	cm.
136/19	19
136/24	24
136/29	29
136/34	34
136/38	38
136/42	42
31	43

**SESSOLA RETTANGOLARE
RECTANGULAR LARGE-SPOON**



31

SESSOLE



136/19



136/24



136/29



136/34



136/38



136/42

CASALINGHI

Household



152

**CATINI
BAGNI QUADRI**



154

**BAGNI OVALI
BAGNI TONDI**



156

MASTELLI 3 MANICI



158

SECCHI



160

**INSALATIERE
SCOLAPASTA**



CASALINGHI

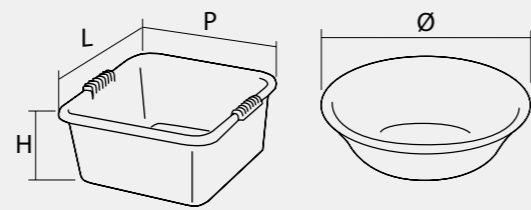

art.	L	H	P	Ø
52/24	-	-	-	24
52/26	-	-	-	26
52/28	-	-	-	28
52/30	-	-	-	30
52/32	-	-	-	32
52/34	-	-	-	34
52/36	-	-	-	36
52/38	-	-	-	38
21/30	30	15	30	-
21/32	32	15	32	-
21/34	34	17	34	-

**BAGNO QUADRO
SQUARE BASIN**



21/30

21 AZP	-
21 N	



21/32



21/34



PRODOTTI IN
MATERIALE
RICICLABILE

AZZURRO (AZP)

NEUTRO (N)

BAGNI E CATINI

**CATINI
BASIN**



52/24



52/26



52/28



52/30



52/32



52/34



52/36



52/38

BIANCO (BIM)



PRODOTTI IN
MATERIALE
RICICLABILE



CASALINGHI

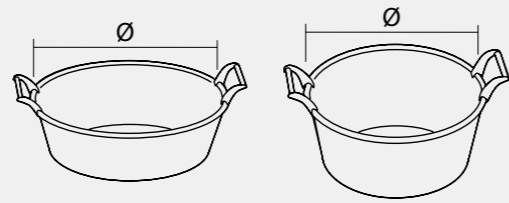

art.	L	H	P	Ø
47/45	-	-	-	45
47/50	-	-	-	50
47/55	-	-	-	55
47/60	-	-	-	60
47/65	-	-	-	65
47/70	-	-	-	70
47/80	-	-	-	80
41/32	-	-	-	32
41/34	-	-	-	34
41/36	-	-	-	36
41/40	-	-	-	40
41/45	-	-	-	45
41/50	-	-	-	50

47 AZP 41 AZP	—
47 N 41 N	

BAGNO TONDO
ROUND BASIN



BAGNI

BAGNO OVALE
OVAL BASIN





CASALINGHI

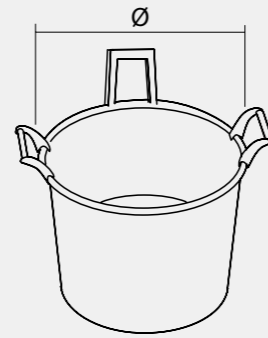

art.	Ø
82/45	45
82/50	50
82/55	55
82/60	60
82/65	65
82/70	70

MASTELLO 3 MANICI
THREE-HANDLE TUB



82 AZP	—
82 N	

MASTELLI 3 MANICI



82/45



82/50



82/55



82/60



82/65



82/70



CASALINGHI

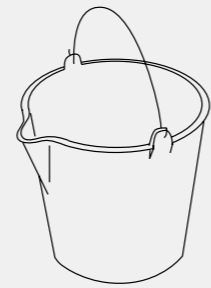

art.	Capacità Capacity
42/9	9 l.
42/12	12 l.
42/15	15 l.
39/7	7 l.
39/9	9 l.
39/12	12 l.
39/15	15 l.

**SECCHIO CON BECCO GRADUATO
GRADUATED BUCKET WITH POURING LIP**

42 AZP	—
42 N	



42/09

42/12

42/15

SECCHI

**SECCHIO NORMALE GRADUATO
GRADUATED BUCKET**



39/07



39/09



39/12



39/15

39 AZP	—
39 N	



CASALINGHI

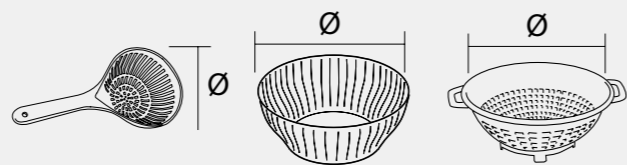

art.	Ø
50/16	16
50/18	18
50/20	20
50/22	22
50/24	24
50/26	26
50/28	28
50/30	30
50/32	32
50/34	34
109/22	22
109/26	26
109/30	30
12	18

INSALATIERE E SCOLAPASTA

INSALATIERA SALAD BOWL



50/16



50/18



50/20



50/22

SCOLAPASTA COLANDER



12



50/24



50/26



50/28



109/22

109/26

109/30



50/30



50/32



50/34

PERSONALIZZAZIONI

PRIVATE LABEL

Disponibilità a fornire su richiesta loghi personalizzati e/o colori non presenti a catalogo.

Prodotti in materiale autoestinguente a norma UL 94.

Quantità e prezzi da concordare.

For special requests of non-standard colours.

Items made of self-extinguishing materials as by UL 94.

Prices and quantities have to be agreed.



LEGENDA

LEGEND

Materiali / material



polipropilene / polypropylene



polistirolo / polystyrene



polietilene ad alta densità / high density polyethylene



polietilene a bassa densità / low density polyethylene



acrilonitrile-butadiene-stirene / acrylonitrile-butadiene-styrene

Simboli / Symbols



PRODOTTI IN MATERIALE
RICICLABILE



PRODOTTI IN MATERIALE
PER USO ALIMENTARE

tutti gli articoli contrassegnati dal simbolo alimentare, sono conformi alle direttive ce n. 1935/2004 e regolamenti d.m. n. 34 del 21-03-73

all items marked with the food use logo, are in conformity with n. 1935/2004 and d.m. n. 34/21-03-73

Colori / Colors

ARA = aragosta / bright orange

AZP = azzurro politene / polythene blue

BIL = bianco latte / milky white

BIM = bianco / white

BL = blu / blue

BLB = blu bidone / bin blue

BRB = bruno bidone / bin brown

BRR = bruno rame / copper brown

GI = giallo / yellow

GIA = giallo / yellow

GR = grigio / grey

GRB = grigio bidone / bin grey

GRC-BLB = grigio-blu / grey-blue

GRC-GIA = grigio-giallo / grey-yellow

GRC-ROB = grigio-rosso / grey-red

GRC-VES = grigio-verde / grey-green

GRB-BLB = grigio-blu / grey-blue

GRB-GIA = grigio-giallo / grey-yellow

GRB-ROB = grigio-rosso / grey-red

GRB-VES = grigio-verde / grey-green

GRI = grigio / grey

GRN = grigio-nero / grey-black

N = neutro / neutral

NE = nero / black

NER = nero / black

NO = nocciola / beige

RO = rosso / red

ROB = rosso bidone / bin red

ROM = rosso / red

TR = trasparente / transparent

TS = bianco trasparente / transparent white

VE = verde / green

VEB = verde bidone / bin green

VEI = verde industriale / industrial green

VES = verde scuro / dark green

VIN = vinaccia / grape red

VET = verde / green

Misure / Size

L - P - H

Misure massimo ingombro dell'articolo.

Maximum external dimensions of the article.

l - p - h

Misura utile interna del singolo cassetto.

Practical internal dimension of single drawer.

SERVIZIO CLIENTI

CUSTOMER SERVICE

• MOBIL PLASTIC offre un completo servizio di informazioni attraverso il suo Ufficio Commerciale e Marketing. Un contatto diretto, per informazioni e richieste di cataloghi, si può avere anche attraverso la e-mail info@mobilplastic.it e l'accesso al sito Internet www.mobilplastic.it

• MOBIL PLASTIC offers a complete information service by means of the Sales and Marketing Department. You can contact the company directly for information and catalogues by e-mail info@mobilplastic.it and Internet Web site www.mobilplastic.it

servizio
clienti
Tel. 0039 0384 674692



servizio
clienti
Fax. 0039 0384 674696

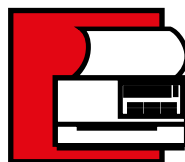

e-mail
info@mobilplastic.it



internet
www.mobilplastic.it



INFORMAZIONI

INFORMATION

I colori riprodotti hanno valore indicativo.

Le misure indicate hanno una tolleranza di ± 2 mm.

I colori ed i modelli potranno subire variazioni senza preavviso.

È possibile fornire per quantità e prezzi da stabilire: prodotti in colori fuori catalogo; prodotti in materiale autoestinguente a norma UL 94; prodotti personalizzati.

Per impieghi diversi da quelli tradizionali si suggerisce di chiedere esplicite indicazioni.

The reproduced colours have an indicative value.

The above-cited dimensions have a tolerance of ± 2 mm.

Colours and models can be subject to change without warning.

It is possible to supply the following in individually arranged quantities and prices: Goods in colours not in catalogue; Goods in self extinguishing materials conforming to the norms UL 94; Personalized products.

For specific and different uses other than those listed it is suggested to contact the company directly.