



WINNTEC

HD-Series

Wheel Service Essentials





Jack dimensions

- A** = Min. Height (mm)
- B** = Max. Height (mm)
- C** = Width (mm)
- D** = Length (mm)
- E** = Height (mm)

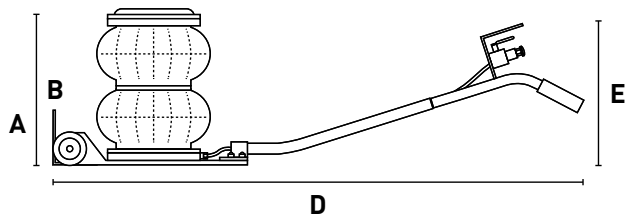
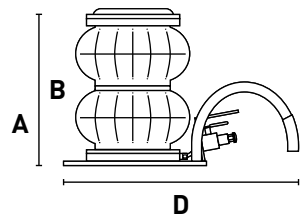
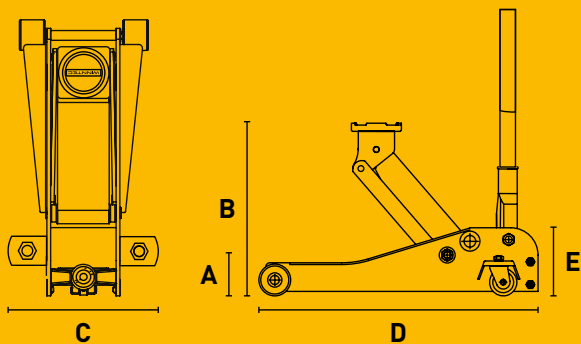

In compliance with NEN-EN 1494:2001+A1:2008 



Reaching new heights

Winntec (Est. 2002) is a manufacturer, esteemed developer and international supplier of high quality, efficient and reliable automotive workshop “essentials”, available in automotive and industrial markets in Europe, North America, Southern Africa and Pacific Asia. The ranges are “priced right” and backed up by outstanding customer service and support.

Whether you are a tire shop, an automotive workshop, body shop or car dealership, Winntec offers you solutions which are certified to the highest level of useful life (professional use and not occasional use) to ensure maximum value of your investment. All our products are consistently made of the best materials available and constructed and tested in accordance with the latest and most advanced techniques.

TURBO LIFT and **AUTO SHIFT** are just two of the amazing technologies that Winntec introduced during its first decade of existence. Both systems greatly reduce the risk of injury while dealing with heavy loads in and around the shop. In the years to come we will further intensify our focus on a safe workshop environment. We plan to bring you more innovative products in which ergonomics, ease of use and price remain in perfect balance.

FOR FURTHER INFORMATION AND CONTACT VISIT WINNTEC.NET



HD-Series



winntec.net



Heavy Duty Series

Y411350

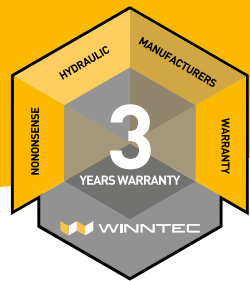

Main features

- Just 10 kg
- Nylon wheels
- PU pad



Light
as a
feather

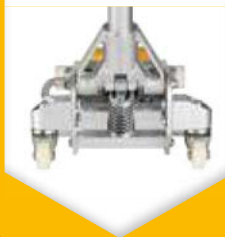

Y411350

Winntec's popular alloy floor jack has been dominating the European market for the last 10 years. The ball bearing-mounted rear swivel caster wheels and wide track front wheels provide easy maneuverability and jack stability under load. A newly designed saddle pad (as subscribed by several European car makers) protects the vehicles bodywork and components.

Thick frame side plates and a reinforced lift arm result in added strength. A bypass and overload valve prevent from over-extension of hydraulic ram and jack use beyond rated capacity. The 2-pc. handle with quick lock offers easy storage. Heavy duty nylon wheels keep the jack's general weight below 10kg.

Specifications

A =	80 mm
B =	375 mm
C =	236 mm
D =	501 mm
E =	140 mm
1,35 T	
10 kg	



Heavy Duty Series

Y412500



Main features

- Turbo Lifter System
- PU pad
- Handle bumper



High capacity
- 100% alloy

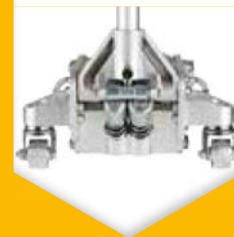

Y412500

A unique 100% alloy floor jack that combines a futuristic design with our widely known and respected TURBO LIFTER (fast to the load, fast with the load) pumping technology. Its solid rubber pad ensures optimal protection while lifting the vehicle. Thick frame side plates and a multiple reinforced lift arm result in maximum strength and safety while dealing with heavy loads up to 2.5 Ton.

This low profile jack comes with heat-treated chromed pump pistons and chromed main ram. A foam handle bumper protects the car's doors while lifting in small spaces. This jack easily handles the majority of cars and light commercial vehicles during road assistance service jobs.

Specifications

A =	95 mm
B =	487 mm
C =	348 mm
D =	677 mm
E =	160 mm
2,5 T	
25 kg	



Heavy Duty Series

Y420210



Main features

- Low profile
- Nylon wheels
- PU pad
- Handle bumper
- Foot pedal



Foot operated
- hold to run



Y420210

Light weight low profile jack with a minimum height of 85mm, fast reach foot pedal, rubber pad, nylon wheels, hold to run control and ergonomic handle.

Compact design ideal for working in tight spaces and transportation in service vehicles.

Specifications	
A =	85 mm
B =	490 mm
C =	370 mm
D =	725 mm
E =	180 mm
2 T	
36,5 kg	



Heavy Duty Series

Y420215

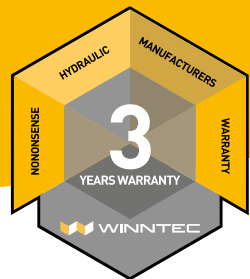

Main features

- Low profile
- PU tandem wheels
- PU pad
- Handle bumper
- Foot pedal



*Smooth
ride
limousine*



Y420215

Light weight low profile jack with a minimum height of 85mm, fast reach foot pedal, rubber pad, PU tandem wheels, hold to run control and ergonomic handle.

Polyurethane tandem rollers reduce noise and floor damage. The tandem system guarantees a comfortable ride on a bumpy surface.

Specifications

A = 85 mm

B = 490 mm

C = 370 mm

D = 795 mm

E = 180 mm

 **2 T**

 **37,2 kg**



Heavy Duty Series

Y420220



Main features

- Turbo Lifter System
- Light weight
- Nylon wheels
- PU pad
- Quick detach handle

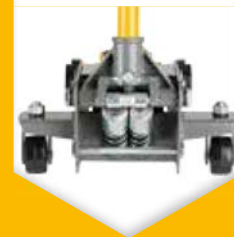



Undisputed
ALL-
rounder

Y420220

Light weight jack with a minimum height of just 115mm. Standard version comes with rubber pad, nylon wheels and a pump handle that can easily be (dis)assembled making this jack ideal for a large variety of (mobile) service jobs. Winntec's unique TURBO LIFTER system with professional release valve guarantees a fast lift to- & with the load.

The heat-treated chromed dual pump pistons (protected with jacket to prevent from intrusion of dirt) are placed at a 45° angle so a complete pumping stroke will always be utilized. Also the main ram has a chrome plating ensuring maximum lifespan.

Specifications	
A =	115 mm
B =	450 mm
C =	345 mm
D =	635 mm
E =	150 mm
 2 T	
 30 kg	



Heavy Duty Series

Y420250



Main features

- Turbo Lifter System
- PU wheels
- PU pad



Ultra
Low - 75
mm

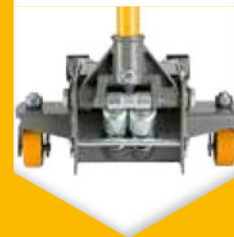

Y420250

Ultra low profile design combined with TURBO LIFTER technology. The PU wheels minimize noise and potential (showroom) floor damage. The jack starts at 75mm and reaches a impressive 510mm at maximum height.

A rubber grip and saddle are standard features. This low profile jack comes with heat-treated chromed pump pistons and chromed main ram.

Specifications

A =	75 mm
B =	510 mm
C =	343 mm
D =	686 mm
E =	140 mm
2 T	
32 kg	



Heavy Duty Series

Y420303



Main features

- Turbo Lifter system
- Steel wheels
- PU pad
- Extremely stable



Bigger,
stronger,
faster

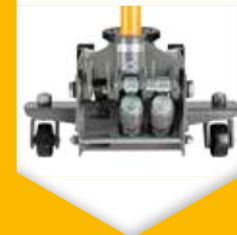

Y420303

This jack is equipped with Winntecs unique TURBO LIFTER system, rubber pad and handle bumper. The professional universal joint release valve makes it possible to lower the jack with load very precisely and free of any risks.

The heat-treated chromed pump pistons (protected with jacket to prevent from intrusion of dirt) are placed at a 45° angle so a complete pumping stroke will always be utilized. Also the main ram has a chrome plating which ensures maximum durability.

Specifications	
A =	130 mm
B =	490 mm
C =	380 mm
D =	730 mm
E =	160 mm
3 T	
41 kg	



Heavy Duty Series

Y420330



Main features

- Turbo Lifter System
- PU wheels
- PU pad



Excellent price-quality ratio

Y420330

Ideally configured for car dealers and universal workshops. The jack comes with noise reducing PU wheels, a rubber pad/grip and our TURBO LIFTER pump system. With a minimum height of 120mm and its compact size, this 3T jack is the right choice for car dealerships that look for attractive pricing, functionality and safety.

The release valve allows you to lower heavy loads in a controlled way. The main ram and both pistons are chrome plated. Winntec selected the best industrial grade seals and gaskets for its next best seller.

Specifications	
A =	120 mm
B =	450 mm
C =	344 mm
D =	618 mm
E =	160 mm
Weight	3 T (US)
Capacity	32 kg



HD-Series



HD-Series

Pneumatic Balloon Jacks

These pneumatic jacks have a internal telescopic stabilizer (ASTM-513 steel) providing lateral and vertical stability. A safety valve prevents from overinflation.

Lightweight Winntec balloon jacks are the preferred choice of tire shops and body shops as they can be easily placed on lifts. Moreover, these jacks lift extremely fast ensuring quick wheel changes.



Y422002

Main features

- Just 10 kg
- Ideal on 4 post lift
- PU pad
- Low profile
- 2 Stage



Specifications	
A =	100 mm
B =	295 mm
D =	450 mm
2 T	
14 kg	

Y422012

Main features

- PU pad
- Low profile
- Store upright
- 2 Stage



Long life
- High speed

Specifications	
A =	115 mm
B =	295 mm
D =	1100 mm
E =	280 mm
2 T	
15 kg	

Y422013

Main features

- PU pad
- Store upright
- 3 Stage



Specifications	
A =	145 mm
B =	420 mm
D =	1150 mm
E =	280 mm
3 T	
27 kg	



HD-Series

Jack Stands

All stands are packed in pairs and intended to be used as such.



Y450301 Main features

- Ratchet type
- Base with foot pads
- Positive lock/handle carrying



Specifications	
Min H =	305 mm
Max H =	450 mm
W =	185 mm
L =	209 mm
3 T	
pair	7 kg

Never compromise safety

Y451600 Main features

- Ratchet type
- Base with foot pads
- Positive lock/handle carrying



Specifications	
Min H =	395 mm
Max H =	625 mm
W =	263 mm
L =	293 mm
6 T	
pair	13,8 kg

Y452300 Main features

- Pin type
- Large PU support pad



Specifications	
Min H =	322 mm
Max H =	465 mm
Ø	254 mm
3 T	
pair	5,2 kg

Y452600 Main features

- Pin type
- Large PU support pad



Specifications	
Min H =	404 mm
Max H =	604 mm
Ø	341 mm
6 T	
pair	11,2 kg



HD-Series



winntec.net



HD-Series

Y472260V2



Y472260V2

Short version. Best in combination with low rise and mid rise tire service lifts. Allows operator to pick up heavy wheels off the floor. Delivered with foot step and sliding rollers that ensure a safe working distance from the vehicle.



Pick up off the floor

Specifications	
Height	1580 mm
Width	685 mm
Max	60 kg
Net	37,5 kg



HD-Series

Y472270 ERGO+



High Reach,
High Speed,
Highly
Ergonomic



Y472270 + Y471147HD





HD-Series



Y472270 ERGO+



Main features

- The professional's choice
- Attractively priced
- Maintenance free
- Fender protection

Specifications

Height	1800 mm
Width	685 mm
 Max weight	Max 60 kg
 Weight	42 kg

winntec.net



WHEEL ASSIST

Y472270 Wheel Assist

Best in combination with 2-post and other high rise lifts. Allows operator to install wheels at chest height. Delivered with quick install ramp, foot step and sliding rollers that ensure a safe working distance from the vehicle.

Operating as a standalone piece of workshop equipment, that doesn't require charging or linking up to a power source, the Winntec Wheel Assist has powerful gas springs that enable workshop technicians to quickly and easily remove and replace wheels while in an ergonomically correct position (chest height). This unique, patent pending product, guarantees an optimal balance between mechanical force and physical user input.

Intuitively it supports the technician, enabling them to precisely position the height of the wheel, guarding against injury during the numerous lifts required in the wheel fitting process. Designed for those heavier 25 kg plus wheels, the Winntec Wheel Assist will prove to be an essential piece of workshop equipment.



In compliance with NEN-EN 1494:2001+A1:2008 



HD-Series

Y471147HD



Main features

- Superior ergonomics
- Flat-free tires leave no stripes
- Handles tires and wheel assemblies



Undisputed choice of the professional



Y4711SPP optional extender & push pull kit

Y471147HD Smart Cart

Finally there's a product that really does the the job! This long life, light weight, high capacity cart allows the tire fitter to maneuver heavy wheel sets in the most ergonomic way with the help of its **patented tilting system**. The unique push-slide-secure automatic locking system eliminates the need for inefficient, wear sensitive, foot operated - or hand controlled jaws. The light yellow colored foam filled tires are maintenance free and leave no traces on the work shop floor. The cart has been developed in partnership with some of Europe's leading tire service chains. It comes in powdercoated steel (robotic welding) with high strength components and an exceptional 3 year warranty period. With just 20kg this lightweight cart handles most car and SUV wheelsets from 14" - 20" up to 200kg.

Specifications

Height = 1385 mm

Width = 610 mm

Depth = 695 mm

 **Weight** = 200 kg

 **Load** = 20 kg

In compliance with NEN-EN 1494:2001+A1:2008 



HD-Series

Y472269



Main features

- Aero alloy
- Avoiding (ceramic) brake disc damage
- Great add-on to Y472270

Perfect centering



Y472269 Wheel centering bolts

These wheel centering bolts simplify the heavy wheel / wheel spacer install process by holding the rim centered on the hub as you hand screw in your lug nuts. Just screw the wheel pin in to the top bolt hole and slide your rim over the pin on to the hub. You'll get perfect rim to hub alignment every time making the job faster, easier and safer.

Particularly useful when replacing the brake discs - the centering bolt ensures that the holes in the new disc are perfectly aligned with the holes in the wheel hub.

The four most common thread and pitch sizes are included in this set (M12x1.25, M12x1.50, M14x1.25, M14x1.50).



In compliance with CE



Mercedes-Benz
e

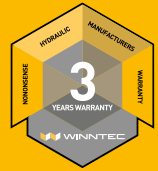

Uplifting Quality & Service!



Y411350



Y412500



Y420210



Y420215



Y420220



Y420250



Y420330



Y420303

We  **Jacks**
Lifting devices sold since 2002

In compliance with NEN-EN 1494:2001+A1:2008 **CE**