

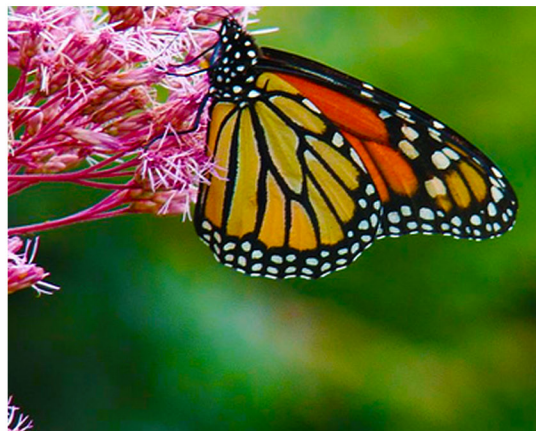

Native Plant Site Solutions for Backyard Habitat

A how-to guide for designers and homeowners
interested in enhancing wildlife habitat value in
urban and suburban areas





Acknowledgements

AUTHORS:

Kate Venturini Caitlin Chaffee

CONTRIBUTING EDITORS:

Bryan Harrison Hope Leeson

DESIGN:

Kaitlyn Lamb

ILLUSTRATIONS:

Bryan Harrison



PHOTOS:

Abe Lincoln	Doug McAbee	Kerry Wixted	Patrick Baker
Adele Medina	Gordon Peabody	Malcolm Mee	Sandy Richard
O'Dowd	Hope Leeson	Mark Darby	Toshiko Gunter
Alexey Seergev	James Van Gundy	Matt Lavin	Vicky Somma
Allison Cowan	Jason Sachs	Michael Saffle	
Bruce Barrett	John Funderburk	Nancy Houlihan	
Corey Raimond	Mary Funderburk	Nelson Chadwick	
Courtney Janiak	Ken Slade	Patricia Henschen	

Flickr Contributors: David_fallsguyd, Luigi FDV, Mike_tn

The content for this booklet was originally developed through a partnership between the URI Outreach Center and the RI Coastal Resources Management Council.



Purpose of the Booklet

This booklet can be used by landscape industry professionals and homeowners to assist in the addition and enhancement of wildlife habitat value on residential properties. The native plant collections described within are intended to replace impervious surfaces (i.e., pavement, compacted soil) and lawn areas in urban and suburban areas to reduce the volume of stormwater runoff generated on residential properties and enhance habitat value for native wildlife.

As development pressures increase in suburban and urban areas throughout Rhode Island (**Figure 1**), areas of native vegetation are converted to residential lots and replaced by driveways, structures, lawn areas and often, exotic landscape plants from Asia and Europe (**Figure 2**). When native vegetative cover is replaced, the amount and quality of habitat available to native wildlife such as pollinators, migratory birds and small mammals is diminished.

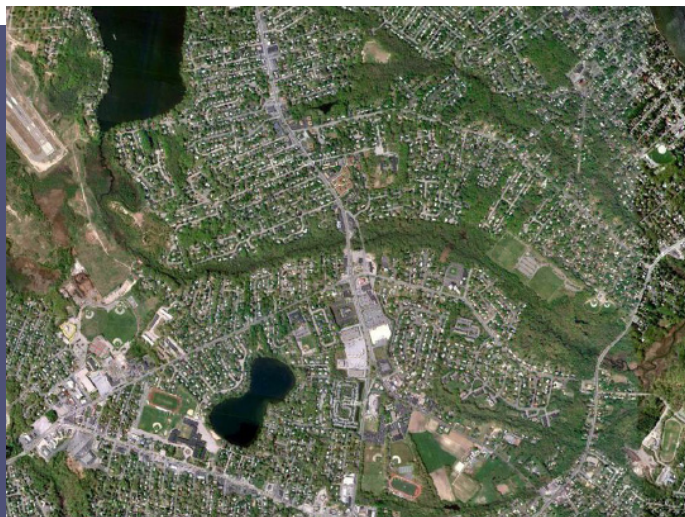

Figure 1: Loss of vegetative cover as a result of development in Warwick, RI

Incorporating collections of native plants with varying sizes, shapes, textures and value into the residential landscape provides food, water and shelter for native wildlife, and may even provide bridges between natural areas separated by development. This booklet provides nine examples of native plant collections, herein referred to as ‘models’ (**Figure 3**).



Figure 2 (left to right): Common invasive plants in Rhode Island, all native to Asia. Left-right, Oriental bittersweet, Butterfly bush, Burning bush

constrained urban lots and small and larger suburban lots, the models provide examples of a range of wildlife habitat pockets featuring plants native to Rhode Island and surrounding areas.



The Importance of Native Vegetation

The presence of native vegetation on residential properties is integral to the protection of biodiversity in Rhode Island. Native plants are those that have evolved in our climate in tandem with our native wildlife. They are adapted to Rhode Island’s climate and provide the preferred food, shelter and nesting structure for pollinators, migratory birds, mammals and other forms of wildlife. When planted where conditions mimic those of the habitat where they are naturally found, natives don’t require excess water, fertilizers or pesticides once they are established, thus conserving precious drinking water resources and protecting the quality of our surface water bodies from nutrient pollution.

In natural, undeveloped areas, it is common to find assemblages of plants repeated on the landscape that are tied to specific physical settings and support numerous organisms that are commonly found amongst them. These assemblages, or groupings of plants, are called native plant communities (Figure 4). Native plant communities contain associated plant species that form the natural vegetation of Rhode Island and surrounding areas and provide the preferred food and shelter for our native pollinators, migratory birds and mammals.

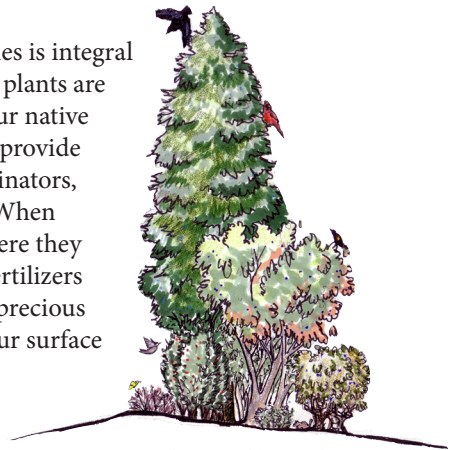

Figure 3: Rendering of layered native plant collection as habitat for wildlife.

Model Collections

The collections of native plants in this booklet were designed as models that mimic some of the functions that natural plant communities provide in our environment. It is important to note that natural plant communities play an important role in maintaining ecosystem balance, so areas with intact natural plant communities should be preserved as such. ***The models herein are NOT intended to replace native vegetation where it already exists, but rather enhance or expand it where native vegetation has been degraded or removed entirely.***

The nine models that follow are composed of a greater number and variety of native plants than commonly found in natural plant communities and are applicable on a variety of residential lot types (urban, suburban and/or rural); especially those with space constraints.



Example of A Natural Plant Community

Oak-Hickory Forest

Species Examples

- Red oak (*Quercus rubra*)
- Pignut hickory (*Carya glabra*)
- Shagbark hickory (*Carya ovata*)
- Witch hazel (*Hamamelis virginiana*)
- Flowering dogwood (*Cornus florida*)

Location: Sprague Farm, Glocester;
Canonchet Trail, Hopkinton;
Lincoln Woods State Park, Lincoln



Figure 4: Oak-Hickory Forest



Site assessment: What is it and how do I do it?

Whether you intend to use a model in this booklet or create your own design, site assessment should be an integral step in your process. Site assessment leads you in gathering information about the natural, built and social characteristics of the landscape, so that you can determine where native plants will thrive, and choose appropriate plants for your site's specific conditions. For example, because some plants prefer more sun and less soil moisture than others, it is important to determine the amount of sun exposure and soil moisture on your site prior to planting anything.

Follow the checklist in **Figure 6** to create a site assessment map (**Figure 5**) for your property. Begin with identifying the general location of buildings, pathways, driveways, septic tanks and utilities (i.e., built characteristics) and mark them on a blank piece of paper. Continue by gathering information about the natural environment (i.e., full sun and poor drainage areas) on your site and mark them on the map as well. Note that not everything in the checklist is necessary information

to collect for all sites, so use your judgment.

When you have completed the site assessment checklist, you will have enough information to begin selecting plants (or models) that will enhance habitat value on your site!

Once you have followed the site assessment checklist and collected all pertinent information, determine whether or not one or more of the models in this booklet are appropriate for your site and its conditions.

First, look to the information you collected about built characteristics, and consider

Native plant selection considerations

- RI native (or in some cases, New England)
- Habitat for native wildlife (i.e., shelter, food)
- Prolific fruit for migratory songbirds
- Value to beneficial insects
- Varying heights, shapes, textures
- Varying bloom times (i.e., flowering period)
- Complementary flower / bud / foliage color

the amount of available space and / or height restrictions on your site. For example, will the presence of utility lines limit the height of plants you select? If so, you might consider models that incorporate shrubs, herbaceous species and groundcovers only. Next, study the information you collected about natural characteristics and determine if they will influence your plant selection. For example, is available sun an issue? If so, look for models that include shade tolerant plants or design your collections with these plants.

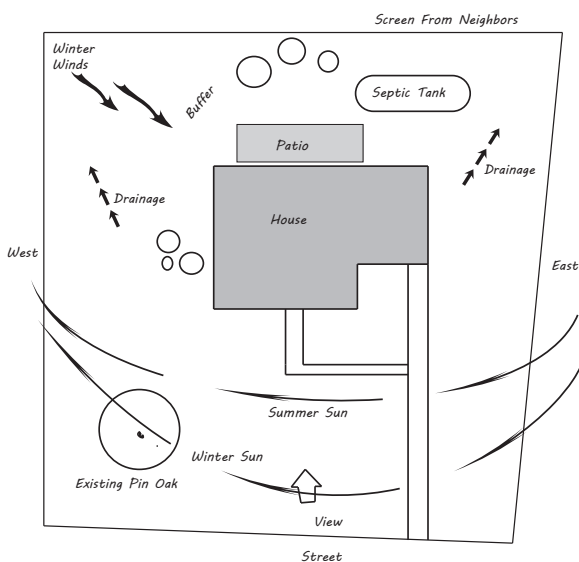

Figure 5: Site assessment map example including information about the natural and built elements of the site



Figure 7: Site Assessment Characteristics

This checklist lists common natural, built and social characteristics of the landscape that influence design decisions and plant selection. Follow the 'Source' column for instructions on how to collect information and see the 'Examples' column for specific examples of information you'll collect. Record any observations you don't mark on your map in the blank spaces in the chart.

Site Characteristic	Source	Examples
<i>Buildings and Infrastructure</i>	Mark general location of existing and proposed structures, paved areas, utility lines, etc.	- House, driveway, brick patio, septic system, wellhead, utility poles and wires
<i>Zones of Use</i>	Mark general location of property lines, easements and recreation areas	- Utility lines at 20' in front, town easement along roadway, lawn area between patio and large shade tree
<i>Plant Hardiness Zone</i>	Search by zip code at: planthardiness.ars.usda.gov/PHZMWeb	- Burrillville 02830: Zone 6a - Providence 02905: Zone 6b - Newport 02840: Zone 7a
<i>Sun / Shade Patterns</i>	Observe the duration of sun exposure throughout the day in selected areas on your site	- Full sun (6+ hours/day) in front yard - Partial sun (<6 hours/day) in backyard - Full shade (6+ hours/day) in side yard
<i>Prevailing Wind Direction</i>	Observe indications of high wind exposure on existing plants	- Stunted growth on back yard evergreens - Two leaning trees in side yard
<i>Soil pH</i>	Soil pH test forms available at: www.soiltest.uconn.edu	- 6.7 soil pH
<i>Soil Drainage</i>	Observe flooding and/or ponding areas; Conduct simple percolation test by digging 12"x12" hole and filling with water to observe drainage rate	- Standing water for more than 24 hours in back yard lawn after rain - Water didn't drain at least 2"/hour
<i>Erosion-prone areas</i>	Look for visible channels of eroded ground from a few inches to a foot deep and/or accumulation of sand and/or soil	- 6" deep channel running alongside house east to west - Pile of sand at base of backyard slope
<i>Vegetation and Wildlife</i>	Mark general location of existing plant species and identify type and nativity	- 2 Red maple (native, keep), 3 inkberry (native, keep) and bittersweet (invasive, remove) in backyard



Model Information

The nine model collections on the pages that follow were designed based on common site characteristics and habitat value associated with each species. The models are intended to serve as example planting plans, and can be used as they appear herein or modified to fit the particular needs of a site. Use the 'System Characteristics' for each model to match information gathered during site assessment. The following information is included in the 'System Characteristics' section for all models:

- Amount of space the native plant system model can cover (Maximum coverage area)
- Site characteristics tolerated by the plants composing each system (Site characteristics)
- Range of mature plant heights (Height range)
- Number of vegetative layers (Vegetative layers) and total number of species (Species total)
- Predominant flower, bud and/or foliage color (Predominant color)

Plant charts provide information about the native plants that comprise each model, as shown in the box to the right.

Plant Type

Common name

(Latin name)

Mature plant height and spread

Aesthetic interest and wildlife value

Migratory bird species value*

*Distinction of a native plant as one providing 'prolific fruit' is based on its presence in Susan Smith and Scott McWilliams's 'Recommended Plantings for Migratory Songbird Habitat Management'.



Cedar Waxwing

Distinction is broken down into three categories:

♣ ♣ ♣ = Highly recommended and preferred by migratory songbirds

♣ ♣ = Recommended and eaten by many migratory songbirds

♣ = Recommended and eaten by a few migratory songbirds



Blue Wild Indigo

Virginia Creeper

Eastern Red Cedar

Beach Pea

Shadbush

Model 1

System Characteristics:

- **Maximum coverage area** - 750 ft²
- **Site Characteristics** - Salt exposure, wind exposure, drought conditions and sandy soil
- **Mature plant height range** - 1-50'
- **Vegetative layers** - 4 (tree, shrub, herbaceous and groundcover)
- **Species Total** - 10
- **Predominant colors** - white, blue and purple

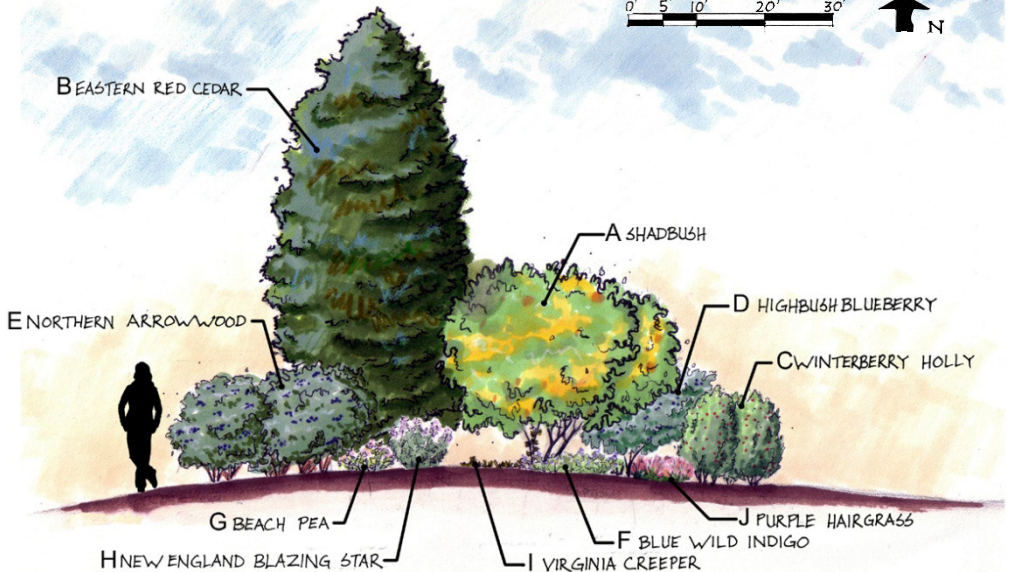
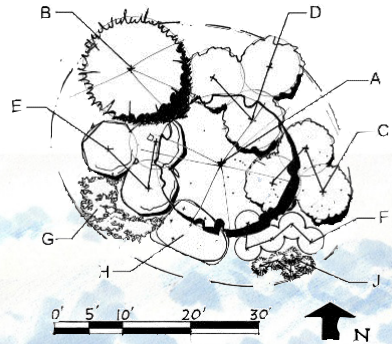



Winterberry Holly



Highbush Blueberry



Arrowwood



Purple Hairgrass

Plant Chart

Trees	Perennials/ Vines
<p>Shadbush (<i>Amelanchier canadensis</i>) 15-25' tree/large shrub White flowers in early spring and dark purple fruits June–July attract birds and small mammals. ☞☞☞ - Highly recommended to provide prolific fruit for migratory songbirds</p>	<p>Blue Wild Indigo (<i>Baptisia australis</i>) 2-3' x 3-4' perennial Violet blue flowers in mid-late spring and 2" long black seed pods attract beneficial insects and butterflies</p>
<p>Eastern Red Cedar (<i>Juniperus virginiana</i>) 40-50' x 8-20' tree Evergreen tree with grayish to reddish exfoliating bark and blue berry-like fruits September–March attract birds and small mammals</p>	<p>Beach Pea (<i>Lathyrus maritimus</i>) 1-3' x 1' vine Pink to lavender pea-like flowers bloom June – August and Vine; 2" seed pods follow bloom in fall; attracts beneficial insects</p>
Shrubs	Virginia Creeper
<p>Winterberry Holly (<i>Ilex verticillata</i>) 6-10' x 6-10' dioecious shrub (needs male plant to produce berries) Greenish white flowers April–July with red fruits from August–March attract birds and small mammals ☞ - Recommended to provide prolific fruit for migratory songbirds</p>	<p>(<i>Parthenocissus quinquefolia</i>) 30-50' climbing vine Vibrant fall foliage and bluish fruits August – February attract birds ☞☞☞ - Highly recommended to provide prolific fruit for migratory songbirds</p>
	Groundcovers/ Grasses
<p>Highbush Blueberry (<i>Vaccinium corymbosum</i>) 6-12' x 8-12' shrub White to pinkish flowers May–June, vibrant red fall foliage and dark blue fruits June–Sept. attract beneficial insects, birds and small mammals ☞☞☞ - Highly recommended to provide prolific fruit for migratory songbirds</p>	<p>Purple Hairgrass (<i>Muhlenbergia capillaris</i>) 2-3' x 1-2' Pink or purple flowers in late summer and feathery pink hue in fall. Clumping habitat provides winter cover; rake out in early spring</p>
<p>Arrowwood (<i>Viburnum dentatum</i>) 10 x 10' shrub White flowers June–August and bluish-black fruits August–November attract beneficial insects, birds and small mammals ☞☞☞ - Highly recommended to provide prolific fruit for migratory songbirds</p>	



Pagoda Dogwood

Sassafras

Red osier Dogwood

Bayberry

Virginia Rose

Model 2

System Characteristics:

- **Maximum coverage area** - 1,200 ft²
- **Site Characteristics** - Suitable for erosion-prone areas, plants tolerate full sun exposure, wet conditions and compacted soils
- **Mature plant height range** - 1-60'
- **Vegetative layers** - 4 (tree, shrub, herbaceous and groundcover)
- **Total Species:** 11
- **Predominant colors:** white, pink, purple and red

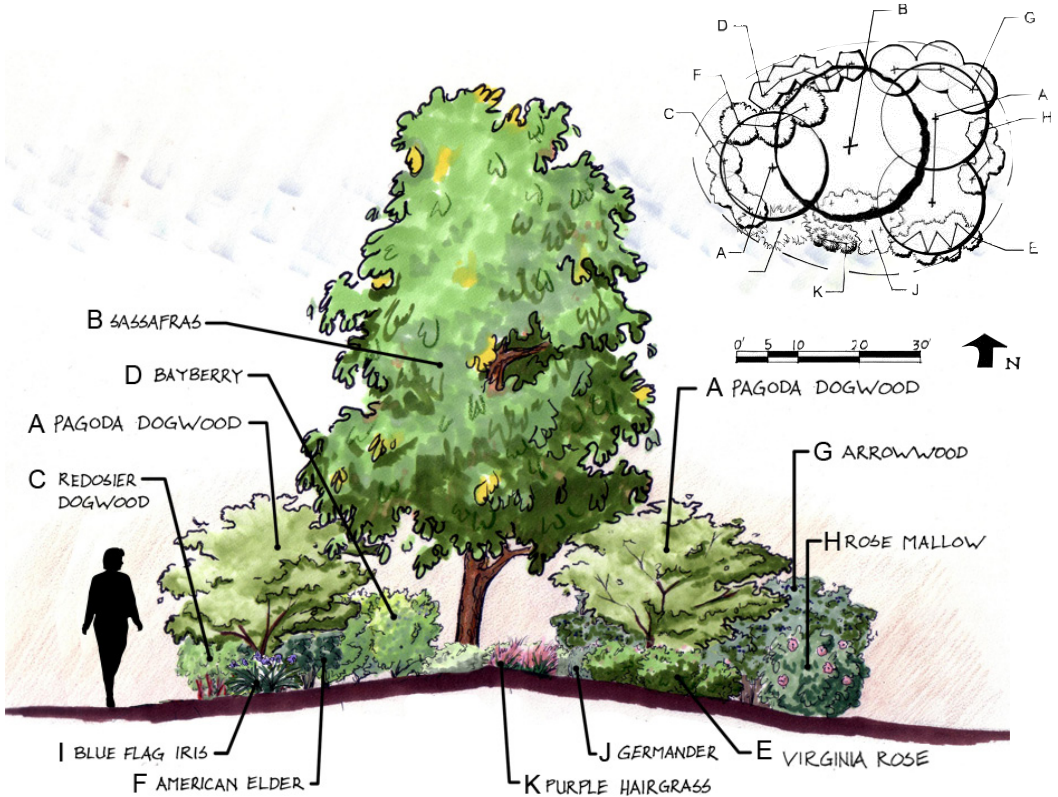



American Elder

Arrowwood

Rose Mallow

Blue Flag Iris

Germander

Purple Hairgrass

Plant Chart

Trees	<p>Arrowwood (<i>Viburnum dentatum</i>) 6-15' x 6-15' shrub White flowers June-Aug., reddish fall foliage and tiny bluish black fruits Aug.-Nov. attract beneficial insects, birds and small mammals ♣ ♣ ♣ -Highly recommended to provide prolific fruit for migratory songbirds</p>
<p>Pagoda Dogwood (<i>Cornus alterniflora</i>) 15-20' x 20-25' tree/large shrub White flower clusters May-June; three fruit colors, reddish purple fall foliage and bluish black fruits July-Sept. attract beneficial insects, birds and small mammals</p>	Perennials
<p>Sassafras (<i>Sassafras albidum</i>) 30-60' x 25-40' tree Greenish yellow flowers April-June; green leaves turn orange to scarlet in fall; and blue oil rich fruits Aug.-Oct. attract birds and small mammals</p>	<p>Rose Mallow (<i>Hibiscus moscheutos</i>) 3-8' x 3-5' perennial 6-12' red, pink or white flowers in late summer and attracts beneficial insects</p>
Shrubs / Vines	<p>Blue Flag Iris (<i>Iris versicolor</i>) 2-3' x 1-2' perennial Blue-violet to purple flowers and attracts beneficial insects</p>
<p>Red osier Dogwood (<i>Cornus sericea</i>) 7-9' x 7-9' shrub Small white flower clusters May-Aug. and red stems through winter. White fruits July-Oct. attract beneficial insects, birds and small mammals ♣ ♣ -Recommended to provide prolific fruit for many migratory songbirds</p>	<p>Germander (<i>Teucrium canadense</i>) 18-36" perennial Purple or cream-colored flower clusters June-Aug. and attracts beneficial insects</p>
<p>Bayberry (<i>Morella pensylvanica</i>) 5-7' x 5-7' shrub Billowed mounds and tiered branch habit with gray fruits on stem June-April that attract beneficial insects and birds; aromatic; nitrogen fixer ♣ -Recommended to provide prolific fruit for migratory birds</p>	Groundcovers / Grasses
<p>Virginia Rose (<i>Rosa virginiana</i>) 4-6' x 4-6' shrub Flush of pink flowers June-July; sporadic bloom for 6-8 wks. Scarlet fruits July-Aug. attract beneficial insects, birds and small mammals; persist through winter</p>	<p>Purple Hairgrass (<i>Muhlenbergia capillaris</i>) 2-3' x 1-2' grass Pink or purple flowers in late summer and feathery pink hue in fall. Clumping habitat provides winter cover; rake out in early spring</p>
<p>American Elder (<i>Sambucus canadensis</i>) 5-12' x 5-12' shrub Fragrant white flowers June-Aug. and purple fruits July-Sept. attract beneficial insects, birds and small mammals ♣ ♣ ♣ -Recommended to provide prolific fruit for many migratory songbirds</p>	



Beach Pea



New England Blazing Star



Blue Flag Iris



Bearberry



Sweet Gale

Model 3

System Characteristics:

- **Maximum coverage area** - 275 ft²
- **Site Characteristics** - Suitable for small or space-constrained lots, plants tolerate salt and wind exposure, excessive heat, drought conditions and sandy soil
- **Mature plant height** - does not exceed 7'
- **Vegetative layers** - 3 (shrub, herbaceous and groundcover)
- **Total Species** - 9
- **Predominant colors** - white, pink and purple

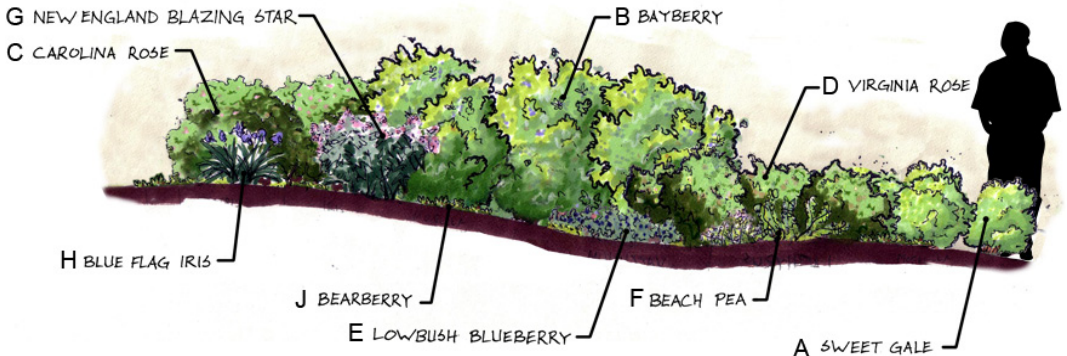
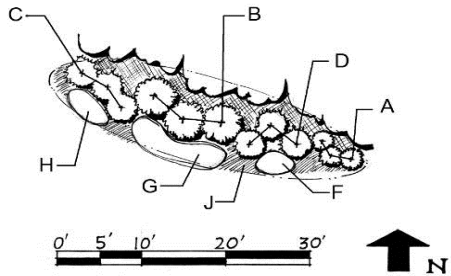



Bayberry



Carolina Rose



Virginia Rose

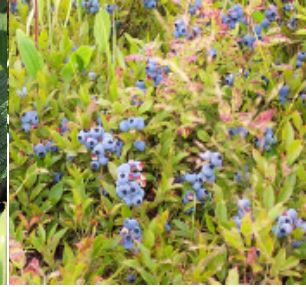

Lowbush Blueberry

Plant Chart

Shrubs	Perennials / Vines
<p>Sweet Gale (<i>Morella gale</i>) 2-4' x 2-4' shrub Dense branch habit; scarlet to orange fall foliage with black seed clusters that attract birds and small mammals; aromatic; may require supplemental water during dry periods.</p>	<p>Beach Pea (<i>Lathyrus maritimus</i>) 1-3' x 1' vine Pink to lavender pea-like flowers June-Aug. and 2" seed pods follow bloom in fall; attracts beneficial insects</p>
<p>Bayberry (<i>Morella pensylvanica</i>) 5-7' x 5-7' shrub Billowed mounds and tiered branch habit with gray fruits on stem June-April that attract beneficial insects and birds; aromatic; nitrogen fixer ♣ -Recommended to provide prolific fruit for migratory songbirds</p>	<p>New England Blazing Star (<i>Liatri scariosa var. novae-angliae</i>) 2-4' x 2-3' perennial Threatened species in RI. Dense spikes of purple flowers in Aug.-Sept. Attracts beneficial insects, butterflies, birds and small mammals</p>
<p>Carolina Rose (<i>Rosa carolina</i>) 4-5' x 5-6' shrub Fragrant pink flowers June-Aug. with reddish-orange fruits July-winter that attract beneficial insects, birds and small mammals</p>	<p>Blue Flag (<i>Iris versicolor</i>) 2-3' x 1-2' perennial Blue-violet to purple flowers and attracts beneficial insects; may require supplemental water during dry periods.</p>
<p>Virginia Rose (<i>Rosa virginiana</i>) 4-6' x 4-6' shrub Flush of pink flowers June-July; sporadic bloom for 6-8 wks. Scarlet fruits July-Aug. attract beneficial insects, birds and small mammals; persist through winter</p>	<p style="background-color: #2e5c3e; color: white; padding: 2px;">Groundcovers / Grasses</p> <p>Bearberry (<i>Arctostaphylos uva-ursi</i>) 1-4' x varies; groundcover White-pinkish flowers April-July; bronze winter foliage; evergreen; large bright to dark red fruits July-March attract birds</p>
<p>Lowbush Blueberry (<i>Vaccinium angustifolium</i>) 6-12" x 24" shrub Pinkish-white flowers April-June and orange-red fall color. Clustered blue fruits July-Sept. attract beneficial insects, birds and small mammals</p>	



Shadbush

Sweet Fern

Red osier Dogwood

Spicebush

Arrowwood

Model 4

System Characteristics:

- **Maximum coverage area** - 550 ft²
- **Site Characteristics** - Suitable for small or space-constrained lots and erosion-prone areas, plants tolerate full sun exposure, wet conditions and compacted soils
- **Mature plant height** - does not exceed 10' when *Amelanchier canadensis* is omitted; otherwise 15-25'
- **Vegetative layers** - 3 (shrub, herbaceous and groundcover)
- **Total Species** - 10
- **Predominant colors** - white, yellow and blue

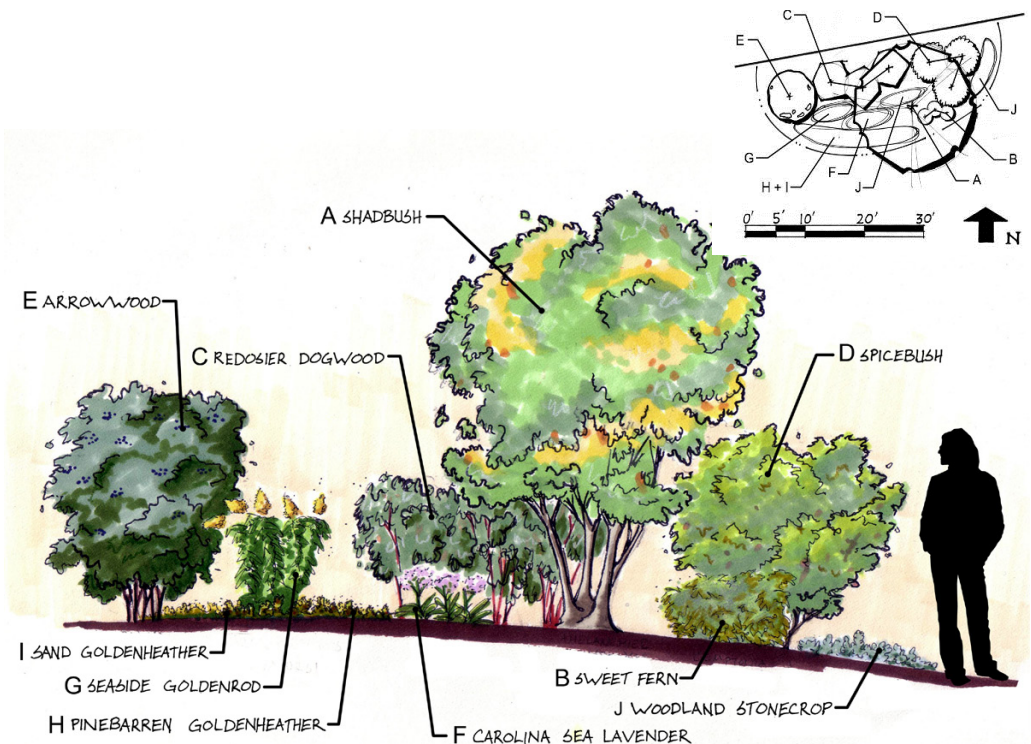



Carolina Sea Lavender



Seaside Goldenrod



Pine Barren Golden Heather



Sand Golden Heather



Woodland Stonecrop

Plant Chart

Perennials / Vines	Shrubs
<p>Carolina Sea Lavender <i>(Limonium carolinianum)</i> 3' x 3' perennial Lavender blue flowers mid-summer and attracts beneficial insects and butterflies; fragrant</p>	<p>Shadbush (<i>Amelanchier canadensis</i>) 15-25' tree/large shrub White flowers in early spring and dark purple fruits June-July attract birds and small mammals ☛☛☛ -Highly recommended to provide prolific fruit for migratory songbirds</p>
<p>Seaside Goldenrod (<i>Solidago sempervirens</i>) 4-6' perennial Golden yellow flowers in fall and attracts beneficial insects and butterflies</p>	<p>Sweet Fern (<i>Comptonia peregrina</i>) 2-4' x 2-4' shrub Brown catkin flowers May-Aug. and small olive brown fruits Aug.-Oct. attract butterflies and birds; fragrant foliage; slope stabilizer; nitrogen fixer</p>
Groundcovers / Grasses	<p>Red osier Dogwood (<i>Cornus sericea</i>) 7-9' x 7-9' shrub Small white flower clusters May-Aug. and red stems through winter. White fruits July-Oct. attract beneficial insects, birds and small mammals ☛☛ -Recommended to provide prolific fruit for many migratory songbirds</p>
<p>Pine Barren Golden Heather <i>(Hudsonia ericoides)</i> 7" x 3-4' groundcover Yellow flowers May-July; evergreen; mat-forming low growing shrub attracts beneficial insects and birds</p>	<p>Spicebush (<i>Lindera benzoin</i>) 7-9' x 2-6' shrub Small yellow flowers March-May before leaves and aromatic scarlet fruits July-Oct. attract beneficial insects and birds ☛☛ -Recommended to provide prolific fruit for many migratory songbirds</p>
<p>Sand Golden Heather (<i>Hudsonia tomentosa</i>) 6-10" x 3-4' groundcover Yellow flowers June-Aug.; evergreen; mat-forming low growing shrub seeds attract birds and small mammals</p>	<p>Arrowwood (<i>Viburnum dentatum</i>) 10' x 10' shrub White flowers June-August; reddish fall foliage and tiny bluish-black fruits August-Nov. attract beneficial insects, birds and small mammals</p>
<p>Woodland Stonecrop (<i>Sedum ternatum</i>) 4-8" x 12" groundcover Small white flowers April-June and blooms attract beneficial insects and butterflies</p>	



Sweet Pepperbush



Sweet Fern



Bayberry

Model 5

System Characteristics:

- **Maximum coverage area** - 300 ft²
- **Site Characteristics** - Suitable for large lots, steep slopes and erosion-prone areas, plants tolerate full sun exposure, wet conditions and compacted soils
- **Mature plant heights range** - 1-12'
- **Vegetative layers** - 3 (shrub, herbaceous and groundcover)
- **Total Species** - 7
- **Predominant colors** - white, orange and blue

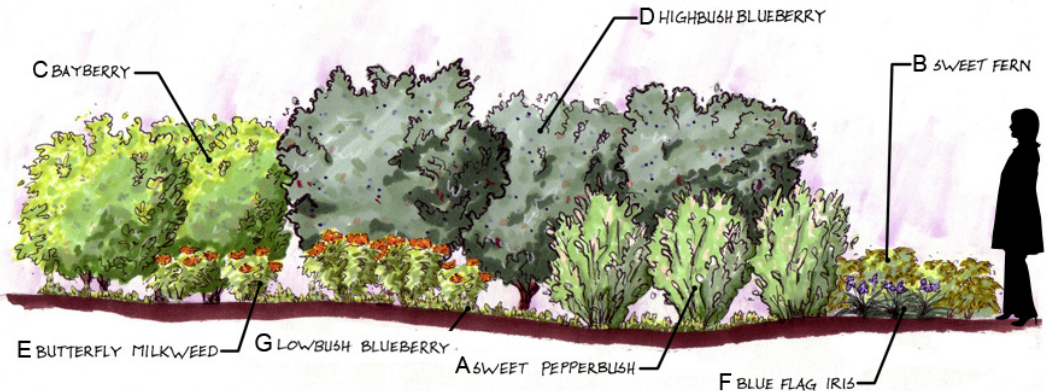
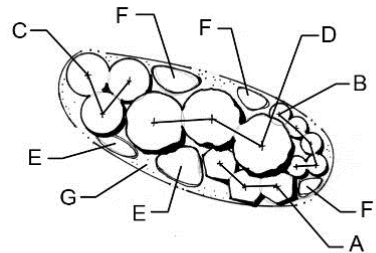



Highbush Blueberry



Butterfly Milkweed



Blue Flag Iris



Lowbush Blueberry

Plant Chart

Shrubs	Perennials / Vines
<p>Sweet Pepperbush (<i>Clethra alnifolia</i>) 4-6' x 4-8' shrub Ivory white flowers bloom July-Aug. and blooms attract beneficial insects and butterflies; fragrant</p>	<p>Butterfly Milkweed (<i>Asclepias tuberosa</i>) 1.5-3' x 2' perennial Orange to red-orange flowers bloom June-Aug.; attracts beneficial insects and butterflies; leaves are food source for monarch butterfly larvae</p>
<p>Sweet Fern (<i>Comptonia peregrina</i>) 2-4' x 2-4' shrub Brown catkin flowers May-Aug. and small olive brown fruits Aug.-Oct. attract butterflies and birds; fragrant foliage; slope stabilizer; nitrogen fixer</p>	<p>Blue Flag (<i>Iris versicolor</i>) 2-3' x 1-2' perennial Blue-violet to purple flowers and attracts beneficial insects</p>
<p>Bayberry (<i>Morella pensylvanica</i>) 5-7' x 5-7' shrub Billowed mounds and tiered branch habit with gray fruits on stem June-April that attract beneficial insects and birds; aromatic; nitrogen fixer ♣ -Recommended to provide prolific fruit for migratory songbirds</p>	Groundcovers / Grasses
<p>Highbush Blueberry (<i>Vaccinium corymbosum</i>) 6-12' x 8-12' shrub White to pinkish flowers May-June, vibrant fall foliage and dark blue fruits June-Sept. attract beneficial insects, birds, and small mammals ♣ ♣ ♣ -Highly recommended to provide prolific fruit for migratory songbirds</p>	<p>Lowbush Blueberry (<i>Vaccinium angustifolium</i>) 6-12" x 24" shrub Pinkish-white flowers April-June and orange-red fall color. Clustered blue fruits July-Sept. attract beneficial insects, birds and small mammals</p>



Sweet Fern



Joe Pye Weed



Swamp Azalea

Model 6

System Characteristics:

- **Maximum coverage area** - 80 ft²
- **Site Characteristics** - Suitable for small or space-constrained lots, steep slopes and erosion-prone areas, plants tolerate full sun exposure, wet conditions and compacted soils
- **Mature plant height range** - 1-8'
- **Vegetative layers** - 3 (shrub, herbaceous and groundcover)
- **Total Species** - 6
- **Predominant colors** - white, pink and purple

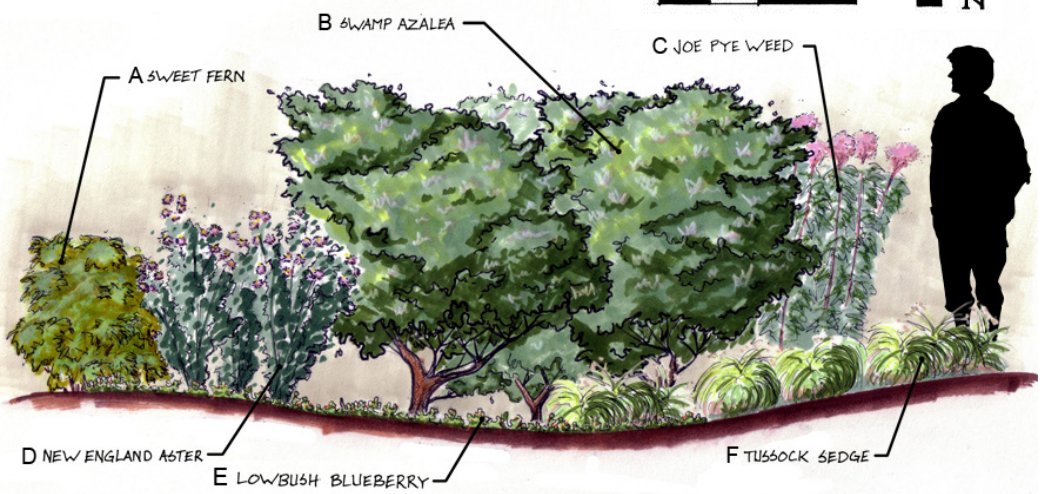
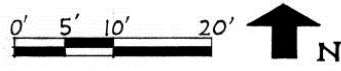
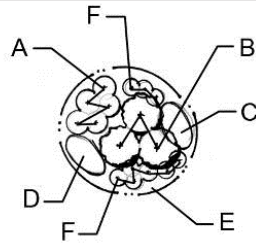



New England Aster

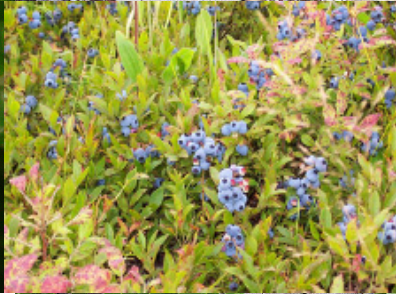

Lowbush Blueberry



Tussock Sedge

Plant Chart

Shrubs	Groundcovers / Grasses
<p>Sweet Fern (<i>Comptonia peregrina</i>) 2-4' x 2-4' shrub Brown catkin flowers May-Aug. and small olive brown fruits Aug.-Oct. attract butterflies and birds; fragrant foliage; slope stabilizer; nitrogen fixer</p>	<p>Lowbush Blueberry (<i>Vaccinium angustifolium</i>) 6-12" x 24" shrub Pinkish-white flowers April-June and orange-red fall color. Clustered blue fruits July-Sept. attract beneficial insects, birds and small mammals</p>
<p>Swamp Azalea (<i>Rhododendron viscosum</i>) 1-8' x 3-8' shrub White or pink flowers May-Aug. and attracts birds</p>	<p>Tussock Sedge (<i>Carex stricta</i>) 1-2' x 1.5-2' grass Greenish-brown blooms April-June and provides habitat for small birds; attracts butterflies and other birds</p>
Perennials / Vines	<p>New England Aster (<i>Symphotrichum novae-angliae</i>) 4-6' x 4' perennial Violet-purple or pinkish flowers Aug.-Sept. and attracts beneficial insects and butterflies; nectar source for Monarch butterfly</p>
<p>Joe Pye Weed (<i>Eupatorium purpureum</i>) 4-7' x 3' perennial Large domes of pink or purple flowers July-Sept. and sweet nectar attracts scores of beneficial insects and birds; fragrant</p>	



Sweet Fern



Inkberry



Creeping Juniper



Beach Pea

Model 7

System Characteristics:

- **Maximum coverage area** - 75 ft²
- **Site Characteristics** - Suitable for small or space-constrained lots, steep slopes and erosion-prone areas, plants tolerate full sun exposure and compacted soils
- **Mature plant height range** - 2"-6'
- **Vegetative layers** - 3 (shrub, herbaceous and groundcover)
- **Total Species** - 8
- **Predominant colors** - white, pink and purple

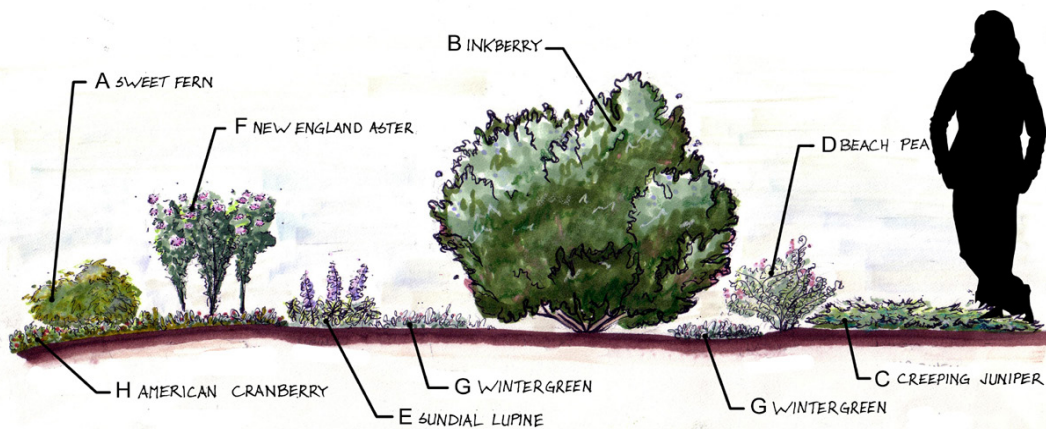
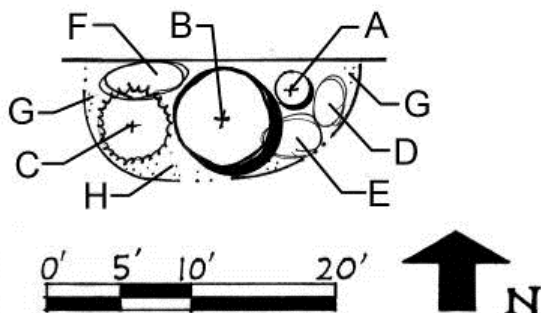



Sundial Lupine



New England Aster



Winter Green



American Cranberry

Plant Chart

Shrubs	
<p>Sweet Fern (<i>Comptonia peregrina</i>) 2-4' x 2-4' shrub Brown catkin flowers May-Aug. and small olive brown fruits Aug.-Oct. attract butterflies and birds; fragrant foliage; slope stabilizer; nitrogen fixer</p>	<p>Sundial Lupine (<i>Lupinus perennis</i>) 15-30" x 15-24" perennial Thin spikes of violet flowers in early summer and attracts beneficial insects, butterflies, birds and small mammals</p>
<p>Inkberry (<i>Ilex glabra</i>) 6-8' x 8-10' dioecious (needs male) shrub Evergreen; dense form and glossy black fruits fall-spring attract birds</p>	<p>New England Aster (<i>Symphyotrichum novae-angliae</i>) 4-6' x 4' perennial Violet-purple or pinkish flowers Aug.-Sept. and attracts beneficial insects and butterflies; nectar source for Monarch butterfly</p>
Groundcovers / Grasses	
<p>Creeping Juniper (<i>Juniperus horizontalis</i>) 1-2' x 6-8' shrub Dark blue foliage early Aug.-April; evergreen. Globular berry-like cones attract birds and small mammals; provides fruit used as seasoning and cooking</p>	<p>Wintergreen (<i>Gaultheria procumbens</i>) 3-5" x variable; groundcover Small pinkish white bell flowers May-Aug.; evergreen; pea-size fruits persist July-April and might attract small mammals; edible leaves and fruit for humans!</p>
Perennials / Vines	
<p>Beach Pea (<i>Lathyrus maritimus</i>) 1-3' x 1' vine Pink to lavender pea-like flowers June-Aug. and 2" seed pods follow bloom in fall; attracts beneficial insects</p>	<p>American Cranberry (<i>Vaccinium macrocarpon</i>) 2-6" x variable; groundcover Small pinkish-white trumpet flowers June-July; evergreen; dark red fruits persist early Sept.-late Nov.; attract birds</p>



Labrador Tea



Mountain Andromeda



Beach Plum

Model 8

System Characteristics:

- **Maximum coverage area** - 50 ft²
- **Site Characteristics** - Suitable for small or space-constrained lots, steep slopes and erosion-prone areas, plants tolerate full sun exposure and compacted soils
- **Mature plant height range** - 3"-6'
- **Vegetative layers** - 3 (shrub, herbaceous and groundcover)
- **Total Species** - 7
- **Predominant colors** - white, pink and purple

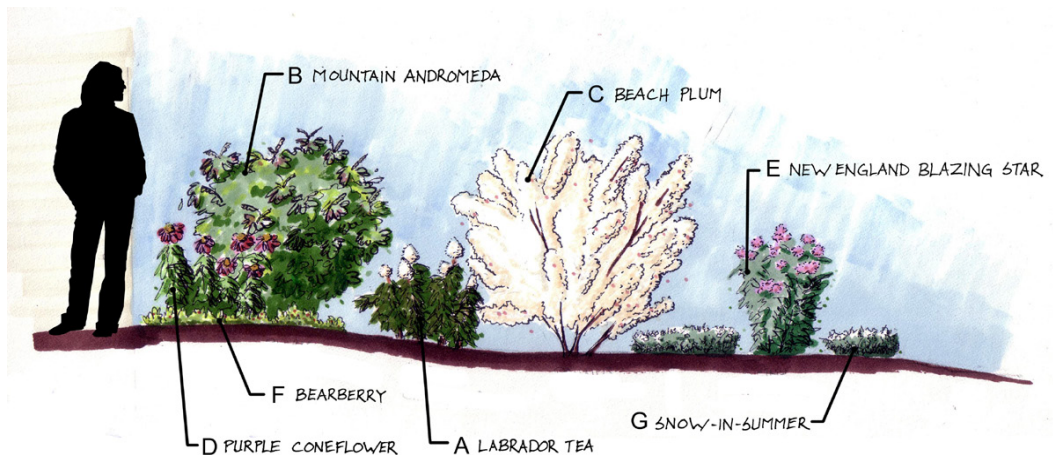
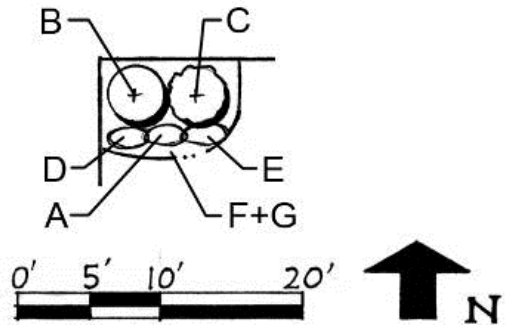

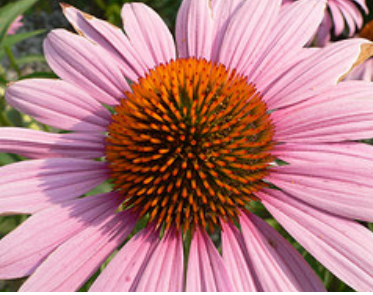

Coneflower



Snow-In-Summer



Bearberry

Plant Chart

Shrubs	Perennials / Vines
<p>Labrador Tea (<i>Ledum groenlandicum</i>) 2-4' x 2-4' shrub Evergreen; white flowers May-June, edible leaves used as tea, and attracts beneficial insects; will require supplemental water during dry periods</p>	<p>Coneflower (<i>Echinacea purpurea</i>) 2-4' x 2' perennial Tall perennial with dark rose flowers in summer; favorite nectar source for mid-season butterflies and seed source for Goldfinches</p>
<p>Mountain Andromeda (<i>Pieris floribunda</i>) 6' x 6' shrub Evergreen; small white bell flowers April-early May and brown fruits Sept.-April attract birds and small mammals</p>	Groundcovers / Grasses
<p>Beach Plum (<i>Prunus maritima</i>) 6' x 6' shrub White flowers in spring before foliage and edible red-purple fruits in Aug.; attracts beneficial insects, butterflies, birds and small mammals</p>	<p>Bearberry (<i>Arctostaphylos uva-ursi</i>) 1-4' x varies; groundcover White-pinkish flowers April-July; bronze winter foliage; evergreen; large bright to dark red fruits July-March attract birds</p>
	<p>Snow-in-Summer (<i>Cerastium tomentosum</i>) 3-6" x 12" groundcover White flowers in early summer and silvery leaves; attracts beneficial insects</p>



Winterberry Holly

Red osier Dogwood

Virginia Rose

Joe Pye Weed

Model 9

System Characteristics:

- **Maximum coverage area** - 80 ft²
- **Site Conditions** - Suitable for small or space-constrained lots and steep slopes, plants tolerate drought conditions and salt spray exposure
- **Mature plant heights range** - 1-10'
- **Vegetative layers** (shrub, herbaceous and groundcover)
- **Total Species** - 7
- **Predominant colors** - pink and purple with red fall/winter interest

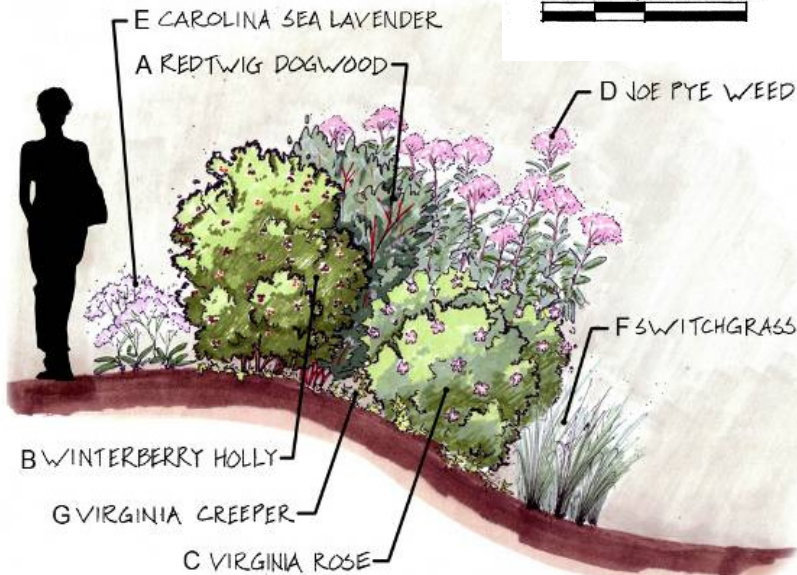
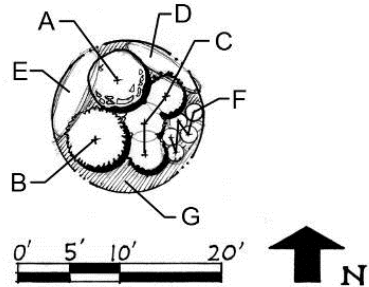



Carolina Sea Lavender



Coastal Switchgrass



Virginia Creeper

Plant Chart

Shrubs	
<p>Winterberry Holly (<i>Ilex verticillata</i>) 6-10' x 6-10' dioecious shrub (needs male plant to produce berries) Greenish white flowers April-July with red fruits from August-March attract birds and small mammals. Prolific red fruit persists into winter; may require supplemental water during dry periods ♣ -Recommended to provide prolific fruit for migratory songbirds</p>	<p>Carolina Sea Lavender (<i>Limonium carolinianum</i>) 3' x 3' perennial Lavender blue flowers mid-summer and attracts beneficial insects and butterflies; fragrant</p>
<p>Red osier Dogwood (<i>Cornus sericea</i>) 7-9' x 7-9' shrub Small white flower clusters May-Aug. and red stems through winter. White fruits July-Oct. attract beneficial insects, birds and small mammals ♣ ♣ -Recommended to provide prolific fruit for many migratory songbirds</p>	<p>Groundcovers / Grasses</p>
<p>Virginia Rose (<i>Rosa virginiana</i>) 4-6' x 4-6' shrub Flush of pink flowers June-July; sporadic bloom for 6-8 wks. Scarlet fruits July-Aug. attract beneficial insects, birds and small mammals; persist through winter</p>	<p>Virginia Creeper (<i>Parthenocissus quinquefolia</i>) 30-50' climbing vine Vibrant fall foliage and bluish fruits Aug.-Feb. attract birds; prune annually ♣ ♣ ♣ -Highly recommended to provide prolific fruit for migratory songbirds</p>
<p>Perennials</p>	<p>Coastal Switchgrass (<i>Panicum virgatum</i>) 3-6' x 2-3' Slender medium green leaves; flowers and leaves have good fall color and persist through winter and flower panicles held above clump open in midsummer</p>
<p>Joe Pye Weed (<i>Eupatorium purpureum</i>) 4-7' x 3' perennial Large domes of pink or purple flowers July-Sept. and sweet nectar attracts scores of beneficial insects and birds; fragrant</p>	



References

- Chase-Rowell, Lauren and Katherine Hartnett, Mary Tebo, and Marilyn Wyzga. 2007. *Integrated Landscaping: Following Nature's Lead*. Published by the University of New Hampshire Cooperative Extension, Durham, NH.
- Enser, R. W. and J.A. Lundgren. 2011. *Natural Communities of Rhode Island*. A joint project of the Rhode Island Department of Environmental Management Natural Heritage Program and The Nature Conservancy of Rhode Island. Web published by Rhode Island Natural History Survey, Kingston, RI. www.rinhs.org.



Shadbush stand, Trustom Pond Wildlife Refuge, South Kingstown, RI

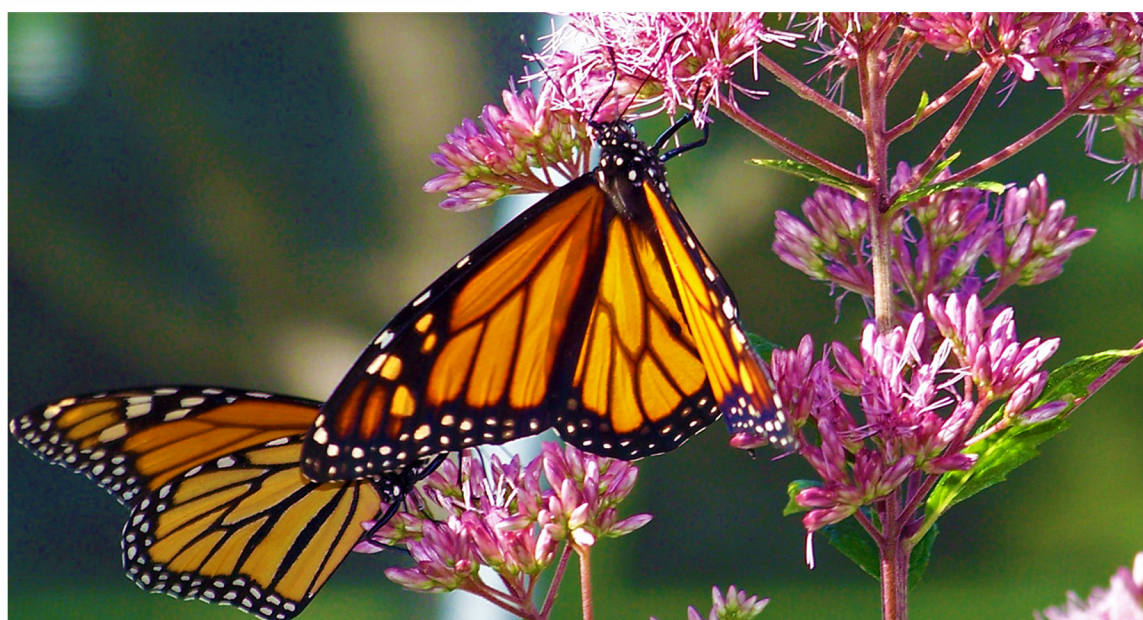
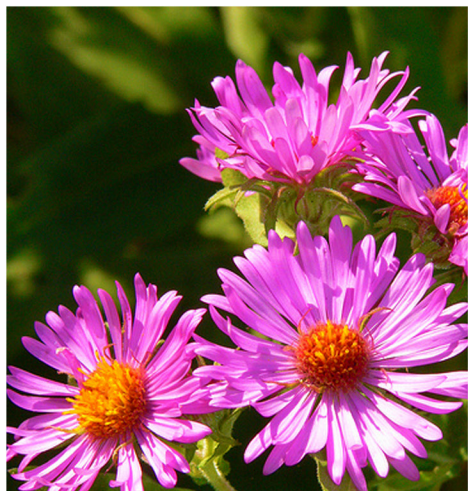

THE UNIVERSITY OF RHODE ISLAND
OUTREACH CENTER