

**Product
Catalog**





2023

Where the Customer Matters

**701 South 100 East
Provo, Ut 84606
801-852-8542**

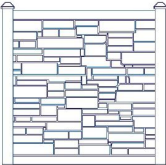
Royal Rock Collection

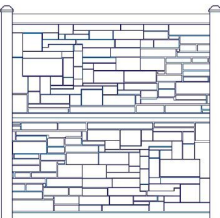
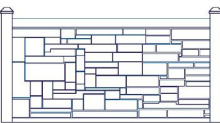
Fence Panels	Model	Description	Weight	Packaging (per pallet)
	FP72X72	Fence Panel 72"H x 71"W	60 lbs	22
	FP36X72	Fence Panel 36"H x 70"W	Discontinued	
	FP96X96	Fence Panel 96"H x 94.5"W (two 4'x8' panels stacked)	120 lbs	20
	FP48X96	Fence Panel 48"H x 94.5"W	60 lbs	20

Royal Rock Panel Detail

- Actual Panel Dimensions
72" High x 69.75" Wide
- Panel Weight
56 lbs
- Top & Bottom Rails
4"
- Tolerances
± 0.5"
- Product Warranty
25 Years

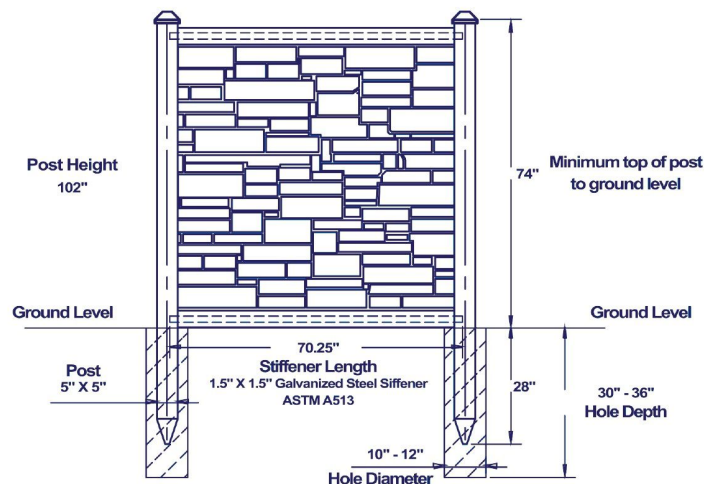
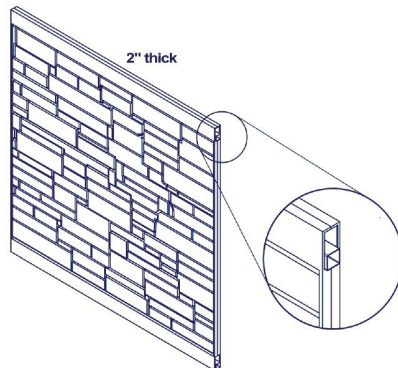

MADE OF
STRONG LLDPE



SUPERIOR WIND
RATING



BLOCKS 98% OF
DIRECT SOUND



IMPACT
RESISTANT

Royal Grain Collection

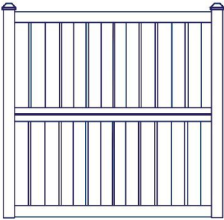
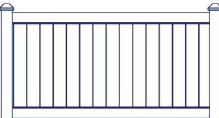
Fence Panels	Model	Description	Weight	Packaging (per pallet)
	WP72X72	Fence Panel 72"H x 70"W	67 lbs	22
	WP96X96	Fence Panel 96"H x 94.5"W (two 4'x8' panels stacked)	120 lbs	20
	WP48X96	Fence Panel 48"H x 96"W	60 lbs	20

Royal Grain Panel Detail

- Actual Panel Dimensions
72" High x 69.75" Wide
- Panel Weight
56 lbs
- Top & Bottom Rails
5"
- Tolerances
± 0.5"
- Product Warranty
25 Years

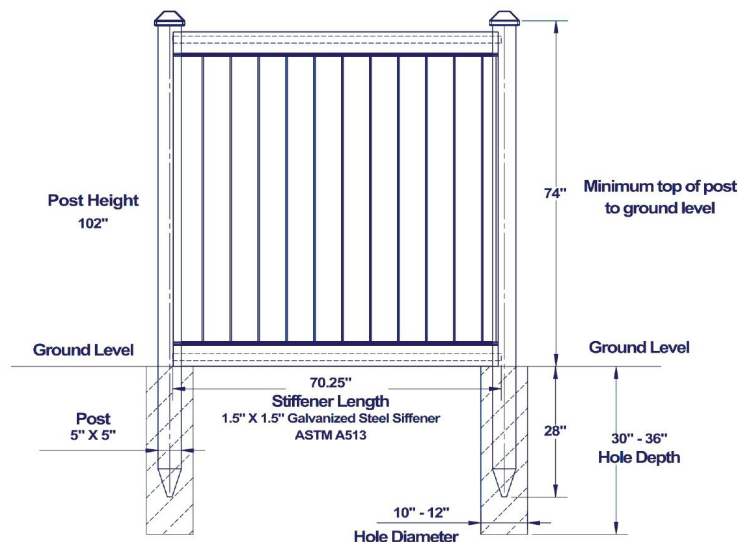
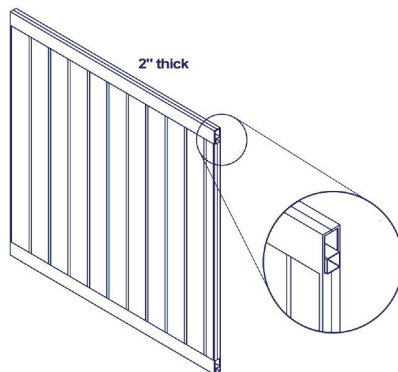

FADE RESISTANT



ECO-FRIENDLY



EASY INSTALLATION



MADE IN
THE USA

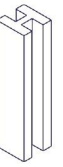

Posts	Model	Description	Weight	Packaging (per pallet)
		102" Line Post 5"x5" Outer Dimension 2"x2" Channel	28 lbs	24 posts
		102" End Post 5"x5" Outer Dimension 2"x2" Channel	31 lbs	16 posts
		102" Corner Post 5"x5" Outer Dimension 1"x2" Channel	25 lbs	16 posts
		102" Gate Post 5"x5" Outer Dimension 1"x2" Channel	52 lbs	8 posts
		142" Line Post 5"x5" Outer Dimension 2"x2" Channel	56 lbs	27 posts
		142" End Post 5"x5" Outer Dimension 2"x2" Channel	53 lbs	27 posts
	142" Gate Post 5"x5" Outer Dimension 2"x2" Channel	80 lbs	27 posts	

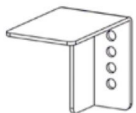

Panel Support Brackets

Posts: Posts include panel support brackets and screws. (LP) = two brackets & two 1.25" screws. (CP) = two brackets & two 1.25" screws & four 3" screws. (EP) and (GP) = one bracket, one 1.25" screws and two 3" screws
Price: \$0.66





Post Caps	Model	Description	Weight	Packaging
 Single Cap	SQ5X5 CAP	POST CAP 5" ID	.40 lbs	boxed w/pallet
 Double Inline	DC5X10CAP	DOUBLE INLINE CAP	.80 lbs	boxed w/pallet
 45 Degree Cap	45D5X10CAP	45 DEGREE CAP	.80 lbs	boxed w/pallet

Access Gates & Gate Hardware

Royal Rock Gates	Model	Description	Weight	Packaging
	GT72X72	Gate 70"H x 72"W	90 lbs	1 per box
	GT72X60	Gate 70"H x 60"W	87 lbs	1 per box
	GT72X48	Gate 70"H x 48"W	67 lbs	1 per box
	GT72X36	Gate 70"H x 36"W	55 lbs	1 per box
	GT48X48	Gate 48"H x 48"W	59 lbs	1 per box
	GT96X48	Gate 96"H x 48"W	110 lbs	1 per box

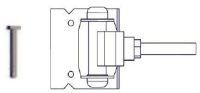
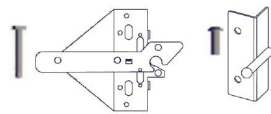
Royal Grain Gates	Model	Description	Weight	Packaging
	WT72X72	Gate 71"H x 72"W	90 lbs	1 per box
	WT72X60	Gate 71"H x 60"W	87 lbs	1 per box
	WT72X48	Gate 71"H x 48"W	67 lbs	1 per box
	WT72X36	Gate 71"H x 36"W	55 lbs	1 per box

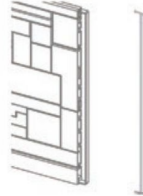
Hinges	Latch	Drop Rod	Cut Panel Support Bracket
 <p>Hinge Set (includes) 2 Hinges 8 Self-tapping Screws 1 Allen Wrench</p>	 <p>Latch & Striker Rod Set (includes) 1 Latch, 1 Striker Rod 2 Button Head Screws 6 Self-tapping Screws</p>	 <p>Drop Rod Set (includes) 1 Bracket 5 Screws 1 Pin</p>	 <p>For every 4'x8' cut fence panel, a support metal bracket is required.</p>

Inside-to-inside post spacing for gates

Gate Width	Single Opening	Double Drive w/3' Gate	Double Drive w/4' Gate	Double Drive w/5' Gate	Double Drive w/6' Gate
3ft Wide Gate	38.5"	76.0"	88.0"	100.0"	111.0"
4ft Wide Gate	50.5"	88.0"	100.0"	112.0"	123.0"
5ft Wide Gate	62.5"	100.0"	112.0"	124.0"	135.0"
6ft Wide Gate	73.5"	111.0"	123.0"	135.0"	146.0"

Concrete Mounting Brackets & Skirts

Concrete Surface Mounting Brackets & Cover Skirts

Royal Rock and Royal Grain can be installed on top of an eight inch minimum width, poured concrete wall or on a flat concrete surface. Our concrete mounting brackets are made with heavy steel plates and have vertical members.

They attach to the concrete with wedge anchors and are bolted to the posts. Mounting brackets are available for line, end, corner, and gate posts. Decorative skirts are used to cover the plates and anchor bolts for a finished look.

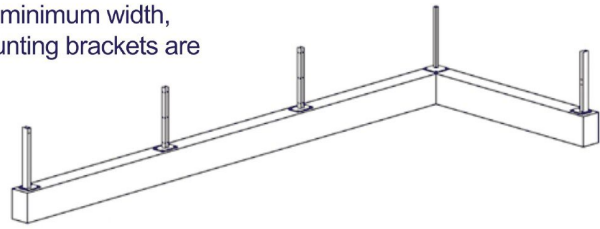

Minimum bolt size
1/2" by 4.5"

For 3'H 4'H 6'H		CMB-6-LP	24"H Concrete Mounting Bracket 8"x5" Base Plate	12 lbs
		CMB-6-EP	24"H Concrete Mounting Bracket 6.5"x5" Base Plate	12 lbs
		CMB-6-CP	24"H Concrete Mounting Bracket 7"x7" Base Plate	12 lbs
		CMB-6-GP	24"H Concrete Mounting Bracket 8"x5" Base Plate	15 lbs
For 8'H		CMB-8-LP	24"H Concrete Mounting Bracket 8"x5" Base Plate	14 lbs
		CMB-8-EP	24"H Concrete Mounting Bracket 8"x5" Base Plate	14 lbs
Skirts		LP-SKIRT	Line Post Skirt 10"x6"	0.5 lbs
		EP-SKIRT	End Post Skirt 10"x6"	0.5 lbs
		CP-SKIRT	Corner Post Skirt 9"x9"	0.5 lbs
		EP-SKIRT	Gate Post Skirt 10"x6"	0.5 lbs

Gap Fillers

1" & 2" Gap Fillers

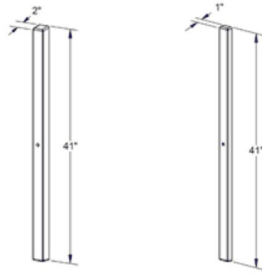

\$14.81 each

\$14.81 each

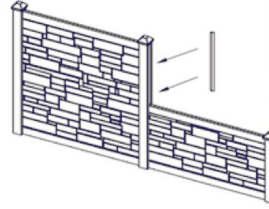

Gap Filler Uses		
Post Type	2" Gap Filler	1" Gap Filler
Line Post	X	
End Post	X	
Corner Post		X
Gate Post		X

Gap Fillers are used to cover the groove of a post when there is a change in elevation and/or transitioning between panel sizes.



Royal Rock Collection DESIGNER GRANITE COLORS



Beige Granite



Brown Granite



Dark Brown Granite



Gray Granite



Dark Gray Granite

Royal Grain Collection DESIGNER WOOD-GRAIN COLORS

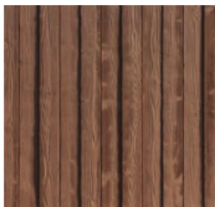

Red Cedar

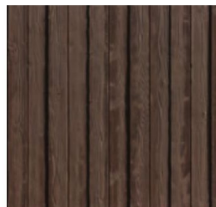

Walnut Brown



Nantucket Gray



Dark Gray Oak