

Drapery

Databook



Glydea® and Irismo™

Glydea® ULTRA 60 | Glydea® ULTRA 35 | Irismo™ 45 WireFree RTS | Irismo™ 35 Mini DC

Why Somfy?



Somfy is the leading global manufacturer of strong, quiet, motors with electronic and app controls for interior window coverings and exterior solar protections. Over 270 million users worldwide enjoy the more than 160 million motors produced since 1980. For 50 years, Somfy engineers have designed products for both the commercial and residential markets to motorize window coverings such as interior shades, wood blinds, draperies, awnings, rolling shutters, exterior solar screens and projection screens. Somfy motorization systems are easily integrated with security, HVAC and lighting systems, providing total home or building automation.

Somfy has a committed customer support team comprised of Somfy motor and control specialists available for assistance:

Somfy Corporate Headquarters

800-22-SOMFY (76639)

General Customer Service

877-210-5327

CustomerService_us@somfy.com

Standard Purchase Order

Ordering_us@somfy.com

Rush Purchase Order

ExpeditedShippingOrders_us@somfy.com

Accounting Inquiries

AccountsReceivable@somfy.com

Technical Support

877-233-0019

TechnicalSupport_us@somfy.com

Warranty Claim Requests

us_Return@somfy.com

- Somfy has a production capacity of more than 70,000 motors per day.
- Somfy motors have over 600 standards approvals worldwide.
- Somfy has certified over 100 patents since the year 2000.
- Every Somfy motor goes through an extensive quality assurance process including testing in extreme environmental conditions, for electrostatic discharge, mechanical shock, and high life cycle.
- Somfy has a network of 15,000 trained professional installers throughout the world.



Somfy operates in 60 countries, with 76 subsidiaries, and 60 agencies spread across 5 continents. With 8 production centers, Somfy is an efficient and reactive industry leader. Thanks to its strict quality standards, Somfy is able to satisfy the needs of over 270 million users worldwide.



Somfy understands that training and support are critical to success. Somfy's Expert Program has been developed to provide a platform for those who want to enhance their expertise of motorization and control solutions. Visit www.somfypro.com to learn more.

TABLE OF CONTENTS

INTRODUCTION.....	2
DRAPERY SYSTEMS AT A GLANCE	4
MOTOR FEATURES AND MAIN CHARACTERISTICS	6-11
Motor Summary and Comparison Charts.....	6-7
<u>WireFree Battery</u>	
Irismo™ 45 WireFree RTS	8
<u>Low Voltage (24V DC)</u>	
Irismo™ 35 Mini DC	9
<u>Line Voltage (120V AC)</u>	
Glydea® ULTRA 35.....	10
Glydea® ULTRA 60	11
INTEGRATION AND POWER ACCESSORIES	12-13
WIRING EXAMPLES.....	14-15
CONTROLS AND ACCESSORIES	16-17
Radio Technology Somfy® (RTS)	16-17
Wired Technology	17
TRACK COMPONENTS AND BRACKETS	18-19
PRODUCT DIMENSIONAL SPECIFICATIONS	20-21
Carrier Arm Dimensions	20
Wall Bracket Dimensions.....	20
Ceiling Bracket Dimensions	21
TRACK CONFIGURATIONS	22-23
TRACK SPECIFICATION CHARTS	24-25
FABRICATED TRACK OPTIONS	26
CUSTOM TRACK OPTIONS	27
BENT DRAPERY TRACK MEASUREMENT FORM	28
DIRECTIONS FOR CREATING A TEMPLATE FOR DRAPERY CURVES	29
DRAPERY ORDER FORM.....	30-31
ENGRAVING BUTTON ORDER FORM	32

Drapery Motor Range

This document presents the technical information and related accessories for Somfy's Glydea® ULTRA and Irismo™ motor ranges designed specifically for draperies. It provides detailed information to facilitate the specification of these motor solutions and presents information regarding options for specialty applications including bent and curved tracks. Information for Somfy's entire product range including motors, power sources, control interfaces etc. can be accessed at www.somfypro.com.

Innovative

The result of years of industry experience and expertise. Reliable motor solutions offer a superior user experience as well as a wide array of features and exemplifies Somfy's continued commitment to quality.

Adaptable

Designed for residential, commercial and hospitality markets, these ranges provide a convenient solution for glare reduction and privacy while also reducing energy costs and protecting interiors from damaging UV rays.

Flexible

Glydea® Ultra and Irismo™ are available for all drapery types including Pinch Pleat, Ripplefold® and Accordia®. Additionally, they have been designed to easily adapt to various control technologies including infrared, dry contact, Radio Technology Somfy® (RTS), RS485, Z-Wave® and Zigbee®.

Pinch Pleat

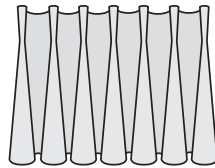

Ripplefold®

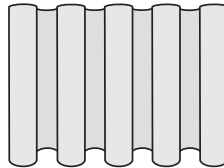

Accordia®

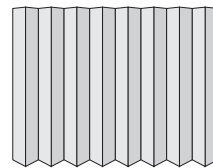

Compatible with various technologies:

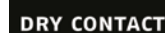

Aesthetic

- Clean, premium motor design with built-in control modules.
- Easy to conceal behind drapery fabric
- Adjustable limit setting provides precise alignment of drapery fabric.
- Advanced track design and swivel ceiling brackets minimize light gaps.
- Soft start and soft stop drapery motion
- Improved hardware design provides greater overlap and even stack back.

Easy Installation

- Spring loaded one-touch hardware (wall and ceiling mount)
- Motor can be installed to the right or left side of the drapery track.
- Automatic or adjustable limit setting
- Inverse (top mount) option allows the motor to be installed above the track.

Flexible

- Patented versatile master carrier reduces friction and is adaptable to various drapery types.
- Multiple built-in control options allow seamless integration with third-party systems.
- Adjustable drapery speed control

Ultra Quiet

- Motor design and advanced high-performance belt drive system provide quiet operation (<38dBA).



Somfy
DESIGNED FOR
SILENCE

Efficient

- Touch motion feature allows the user to activate the motorized drapery simply by pulling on the fabric.
- Manual override permits the drapery to be adjusted manually. This is ideal for power outages and also protects the fabric from damage.
- The “my” function allows user to set a preferred drapery opening which provides enhanced convenience.

Somfy quality

5 years international warranty.
International certifications.



Z-Wave® is a registered trademark of Zensys, Inc. and its subsidiaries.

Zigbee® is a registered trademark of Zigbee® Alliance.

Ripplefold® and Accordia® are registered trademarks of Kirsch.

Amazon, Alexa, and all related logos are trademarks of Amazon.com, Inc. or its affiliates.

All brands, products and trademarks are the property of their respective owners.

Drapery Systems at a Glance

The difference is in the details.



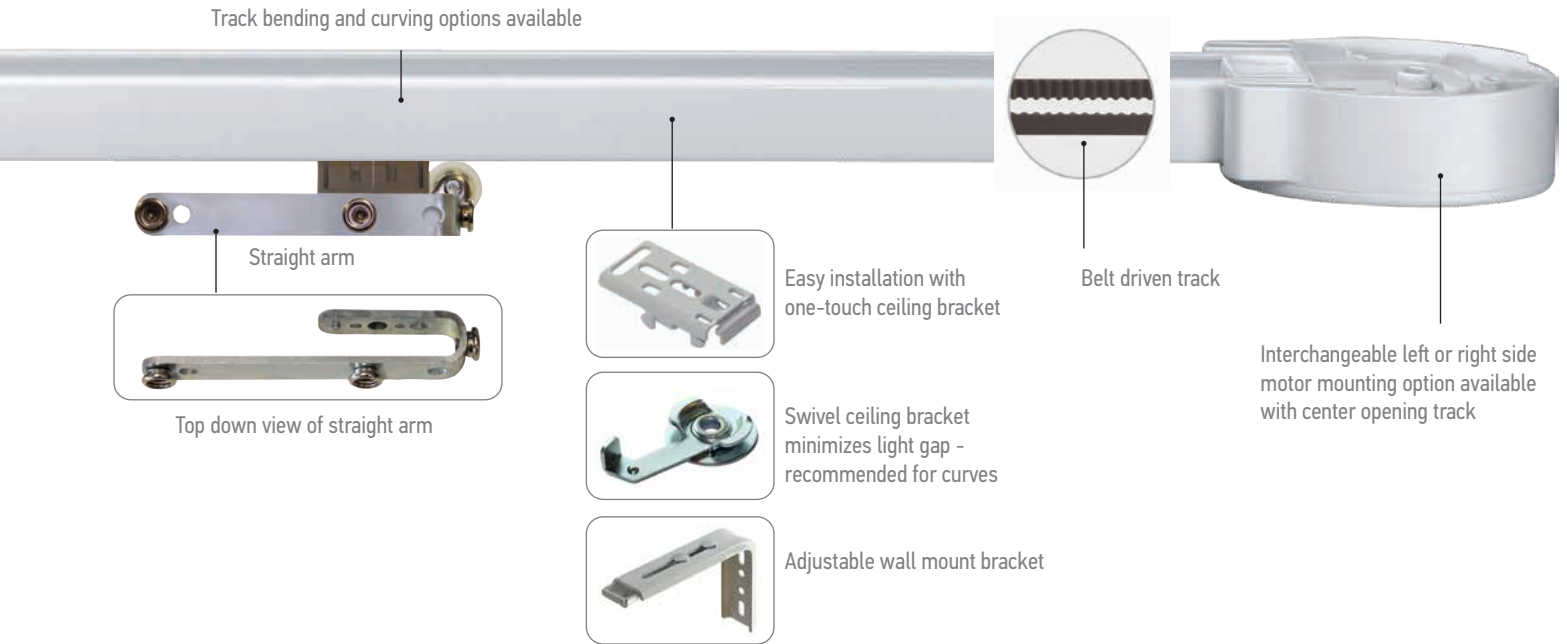

Any Style, Any Technology

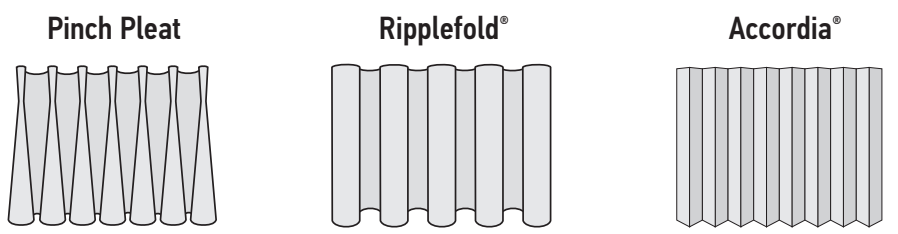

Built-in RTS, DCT and Wired technologies



Optional modules extend control to Zigbee, Z-wave and RS485



FEATURES OVERVIEW COMPARISON CHART

	WireFree 25.9V DC (Li-ion Rechargeable)	Low Voltage 24V DC	
	Irisimo™ 45 WireFree RTS	Irisimo™ 35 RTS	Irisimo™ 35 DCT
Motor unit main features			
Soft start	✓	✓	✓
Manual operation	✓	✓	✓
Automatic limits on end stop	✓	✓	✓
Soft stop	✓	✓	✓
Intermediate position	✓	✓	✓
Touch motion with 2 sensitivity settings	✓	✓	✓
Adjustable limits	✓	✓	✓
Speed control & adjustment	✓	✓	✓
Control options			
Dry contact input via RJ12 connector		✓	✓
Dry contact individual, group and master control		✓	✓
Radio Technology Somfy® RTS	✓	✓	
SDN RS485 digital technology (one-way communication)		✓	✓
Z-Wave® (one-way communication)		✓	✓
Zigbee® (one-way communication)		✓	✓
Tandem alternative	✓	✓	✓
Sun control	✓	✓	✓
Timer control	✓	✓	✓
Installation and setting features			
Settings with buttons on motor unit		✓	
Setting with normally open dry contact switch			✓
LED indicators	✓	✓	
Motor unit direction change	✓	✓	✓
Factory reset	✓	✓	✓
Inverse (top mount) mounting	✓	✓	✓
Audible sound Indicator	✓		
Tracks/Drapery Types			
One-way opening	✓	✓	✓
Center opening	✓	✓	✓
Asymmetric	✓	✓	✓
Multiple		✓	✓
Pinch pleat	✓	✓	✓
Ripplefold® with overlap arm	✓	✓	✓
Ripplefold® with butt arm	✓	✓	✓
Accordia®	✓	✓	✓

	Line Voltage 120V AC			
	Glydea® ULTRA 35		Glydea® ULTRA 60	
	DCT	RTS	DCT	RTS
Motor unit main features				
Soft start	✓	✓	✓	✓
Manual operation	✓	✓	✓	✓
Automatic limits on end stop	✓	✓	✓	✓
Soft stop	✓	✓	✓	✓
Intermediate position	✓	✓	✓	✓
Touch motion with 2 sensitivity settings	✓	✓	✓	✓
Adjustable limits	✓	✓	✓	✓
Speed control & adjustment	✓	✓	✓	✓
Control options				
Dry contact input via RJ12 connector	✓	✓	✓	✓
Dry contact individual, group and master control	✓	✓	✓	✓
Radio Technology Somfy® RTS	✓	✓	✓	✓
SDN RS485 digital technology (two-way communication)	✓	✓	✓	✓
Z-Wave® (one-way communication)				
Zigbee® (two-way communication)	✓		✓	
Tandem alternative	✓	✓	✓	✓
Sun control	✓	✓	✓	✓
Timer control	✓	✓	✓	✓
Installation and setting features				
Settings with buttons on motor unit	✓	✓	✓	✓
Setting with normally open dry contact switch	✓		✓	
LED indicators	✓	✓	✓	✓
Motor unit direction change	✓	✓	✓	✓
Factory reset	✓	✓	✓	✓
Inverse (top mount) mounting	✓	✓	✓	✓
Audible sound Indicator				
Tracks/Draperies Types				
One-way opening	✓	✓	✓	✓
Center opening	✓	✓	✓	✓
Asymmetric	✓	✓	✓	✓
Multiple	✓	✓	✓	✓
Pinch pleat	✓	✓	✓	✓
Ripplefold® with overlap arm	✓	✓	✓	✓
Ripplefold® with butt arm	✓	✓	✓	✓
Accordia®	✓	✓	✓	✓

Irismo™ 45 WireFree RTS

Technical Specifications

Motor part numbers

Irismo™ 45 WireFree RTS

Part# 1002353

Features overview

	Irismo™ 45 WireFree RTS
Motor unit main features	
Soft start	✓
Soft stop	✓
Manual operation	✓
Automatic limits on end stop	✓
Intermediate position	✓
Touch motion with 2 sensitivity settings	✓
Adjustable limits	✓
Speed control & adjustment	✓
Control options	
Radio Technology Somfy® RTS	✓
Tandem alternative	✓
Sun control	✓
Timer control	✓
Installation and setting features	
LED indicators	✓
Audible sound Indicator	✓
Motor unit direction change	✓
Factory reset/programming button	✓
Inverse mounting (top mount)	✓
Tracks/Draper Types	
One-way opening	✓
Center opening	✓
Asymmetric	✓
Pinch pleat	✓
Ripplefold® with overlap arm	✓
Ripplefold® with butt arm	✓
Accordia®	✓

Motorized track main characteristics

	Irismo™ 45 WireFree RTS
Power supply	25.9V DC
Average linear speed	4.9 in./s - 7.86 in./s
Rechargeable (Li-ion) battery capacity	2950 mAh
Motor sound level	<44 dBA
Certifications	CE
Track maximum length	33 ft. (10 m)
Maximum number of splices	2
Side opening max weight	99 lbs. (45 kg)
Center opening max weight	99 lbs. (45 kg)
Tandem alternative (see pages 23, 24, 26)	198 lbs. (90 kg)

Motor dimensions

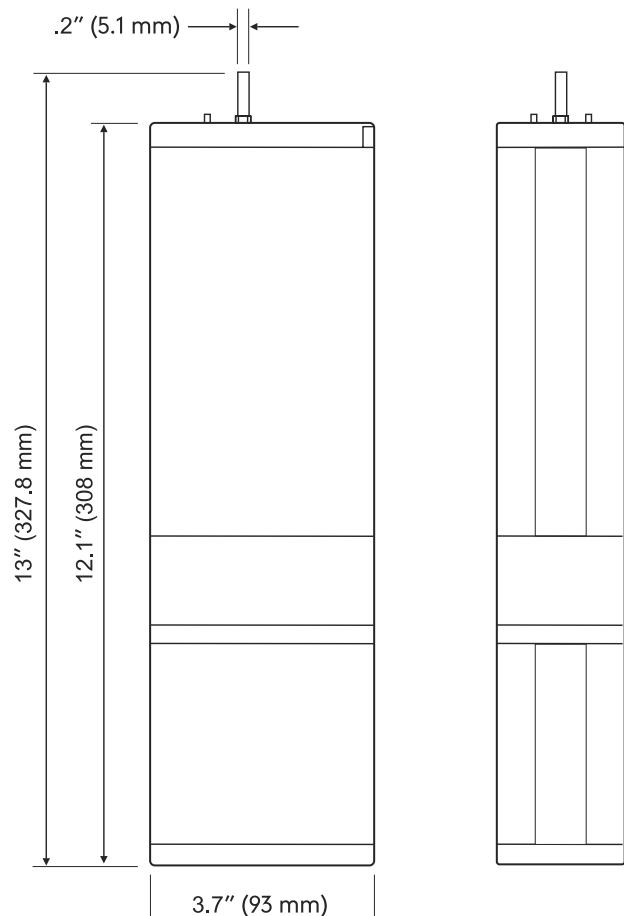

Irismo™ 35 Mini DC

Technical Specifications

Motor part numbers

Irismo™ 35 Mini DC RTS	Part# 1003004
Irismo™ 35 Mini DC DCT	Part# 1003003

Features overview

	Irismo™ 35 RTS	Irismo™ 35 DCT
Motor unit main features		
Soft start	✓	✓
Soft stop	✓	✓
Manual operation	✓	✓
Automatic limits on end stop	✓	✓
Intermediate position	✓	✓
Touch motion with 2 sensitivity settings	✓	✓
Adjustable limits	✓	✓
Speed control & adjustment	✓	✓
Control options		
Dry contact input via RJ12 connector	✓	✓
Radio Technology Somfy® RTS	✓	
Tandem alternative	✓	✓
SDN RS485 digital technology (one-way communication)	✓	✓
Z-Wave® (one-way communication)	✓	✓
Zigbee® (one-way communication)	✓	✓
Sun control	✓	✓
Timer control	✓	✓
Installation and setting features		
Settings with buttons on motor unit	✓	
Setting with normally open dry contact switch	✓	✓
LED indicators	✓	
Motor unit direction change	✓	✓
Factory reset	✓	✓
Inverse mounting (top mount)	✓	✓
Tracks/Drapery Types		
One-way opening	✓	✓
Center opening	✓	✓
Asymmetric	✓	✓
Multiple	✓	✓
Pinch pleat	✓	✓
Ripplefold® with overlap arm	✓	✓
Ripplefold® with butt arm	✓	✓
Accordia®	✓	✓

Motorized track main characteristics

	Irismo™ 35 RTS	Irismo™ 35 DCT
Power Supply	24V DC	
Power adaptor amperage	2 A	
Average linear speed	4.9 in./s - 7.86 in./s	
Power consumption	< 3 W (standby)	
Power adaptor cable length	13.2 ft. (4 m)	
Control connector type	RJ12	
DCT control circuit voltage	5V DC	
Motor sound level	<44 dBA	
Certifications	CE	
Track maximum length	32 ft. (9.7 m)	
Maximum number of splices	2	
Minimum bending radius	11.8 in. (30 cm)	
Minimum curving radius	118 in. (300 cm)	
Side opening max weight	77 lbs. (35 kg)	
Center opening max weight	77 lbs. (35 kg)	
Tandem alternative (see pages 23, 24, 26)	154 lbs. (70 kg)	

Motor dimensions

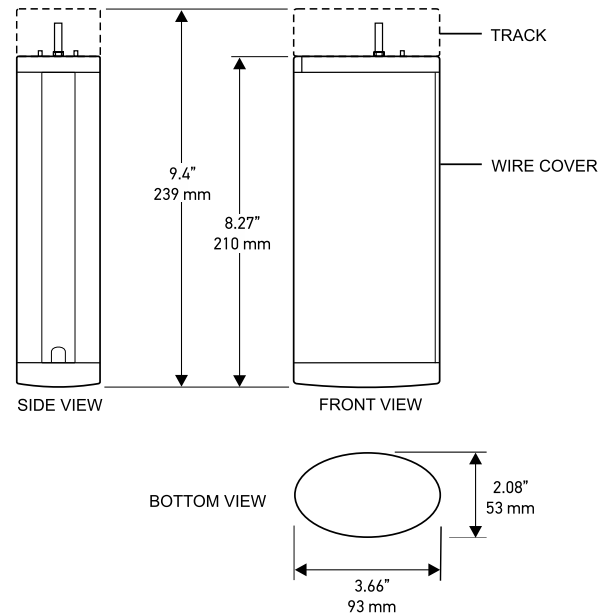

Glydea® ULTRA 35

Technical Specifications

Motor part numbers

Glydea® ULTRA 35 RTS motor (with 10' cable and molded NEMA plug)	Part# 1003152
Glydea® ULTRA 35 DCT motor (with 10' cable and molded NEMA plug)	Part# 1003151
Glydea® ULTRA 35 Wired Motor (5' long without plug)	Part# 1003153

Features overview

Glydea® ULTRA 35	
Motor unit main features	
Soft start	✓
Manual operation	✓
Automatic limits on end stop	✓
Soft stop	✓
Intermediate position	✓
Touch motion with 2 sensitivity settings	✓
Adjustable limits	✓
Speed control & adjustment	✓
Control options	
Dry contact input via RJ12 Connector	✓
Dry contact individual, group and master control	✓
Radio Technology Somfy® RTS	✓
SDN RS485 digital technology (two-way communication)	✓
Zigbee® (two-way communication)	✓
Tandem alternative	✓
Sun control	✓
Timer control	✓
Installation and setting features	
Settings with buttons on motor unit	✓
Setting with 3 normally open dry contact switch	✓
LED indicators	✓
Motor unit direction change	✓
Factory reset	✓
Inverse (top mount) mounting	✓
Tracks/Drapery Types	
One-way opening	✓
Center opening	✓
Asymmetric	✓
Multiple	✓
Pinch pleat	✓
Ripplefold® with overlap arm	✓
Ripplefold® with butt arm	✓
Accordia®	✓

Motorized track main characteristics

	Glydea® ULTRA 35
Power Supply	120V AC 50/60 HZ
Amperage	0.8 A
Average linear speed	4.9 in./s - 7.86 in. /s (silent: 2.95 in. /s)
Power consumption	96W (standby <1W)
Power cable type	3-wire cable with molded NEMA plug 4-wire cable (wired version only)
Control connector type (Dry Contact)	RJ12
DCT control circuit voltage	3.3 VDC
Motor sound level	<38 dBA at silent mode
Certifications	c TUV us, CE
Track maximum length	32 ft. (9.7 m)
Maximum number of splices	2
Minimum bending radius	11.8 in. (30 cm)
Minimum curving radius	118 in. (300 cm)
Side opening max weight	77 lbs. 35 kg.
Center opening max weight	77 lbs. 35 kg.
Tandem alternative (see pages 23, 24, 26)	154 lbs./ 70 kgs. 64 ft./ 19.4 m

Motor dimensions

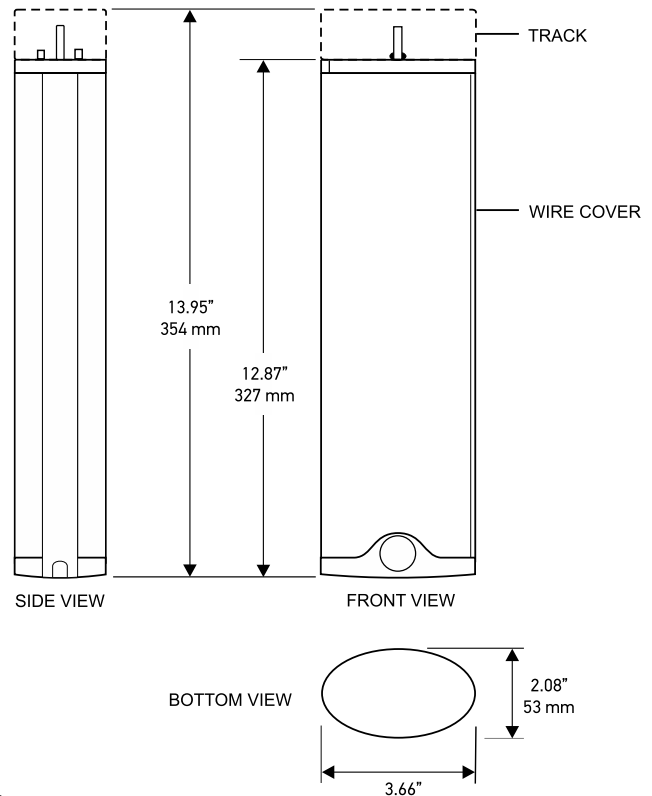

Glydea® ULTRA 60

Technical Specifications

Motor part numbers

Glydea® ULTRA 60 RTS motor (with 10' cable and molded NEMA plug)	Part# 1003159
Glydea® ULTRA 60 DCT motor (with 10' cable and molded NEMA plug)	Part# 1003158
Glydea® ULTRA 60 Wired motor (5' long without plug)	Part# 1003160

Features overview

Glydea® ULTRA 60	
Motor unit main features	
Soft start	✓
Manual operation	✓
Automatic limits on end stop	✓
Soft stop	✓
Intermediate position	✓
Touch motion with 2 sensitivity settings	✓
Adjustable limits	✓
Speed control & adjustment	✓
Control options	
Dry contact input via RJ12 Connector	✓
Dry contact individual, group and master control	✓
Radio Technology Somfy® RTS	✓
SDN RS485 digital technology (two-way communication)	✓
Zigbee® (two-way communication)	✓
Tandem alternative	✓
Sun control	✓
Timer control	✓
Installation and setting features	
Settings with buttons on motor unit	✓
Setting with 3 normally open dry contact switch	✓
LED indicators	✓
Motor unit direction change	✓
Factory reset	✓
Inverse (top mount) mounting	✓
Tracks/Draper Types	
One-way opening	✓
Center opening	✓
Asymmetric	✓
Multiple	✓
Pinch pleat	✓
Ripplefold® with overlap arm	✓
Ripplefold® with butt arm	✓
Accordia®	✓

Motorized track main characteristics

Glydea® ULTRA 60	
Power Supply	120V AC 50/60 HZ
Amperage	0.8 A
Average linear speed	4.9 in./s - 7.86 in. /s (silent: 2.95 in. /s)
Power consumption	96W (standby <1W)
Power cable type	3-wire cable with molded NEMA plug 4-wire cable (wired version only)
Control connector type (Dry Contact)	RJ12
DCT control circuit voltage	3.3 VDC
Motor sound level	<38 dBA at silent mode
Certifications	c TUV us, CE
Track maximum length	36 ft. (10.9 m)
Maximum number of splices	2
Minimum bending radius	11.8 in. (30 cm)
Minimum curving radius	118 in. (300 cm)
Side opening max weight	132 lbs. 60 kg.
Center opening max weight	132 lbs. 60 kg.
Tandem alternative (see pages 23, 24, 26)	264 lbs./ 120 kgs. 72 ft./ 21.8 m

Motor dimensions

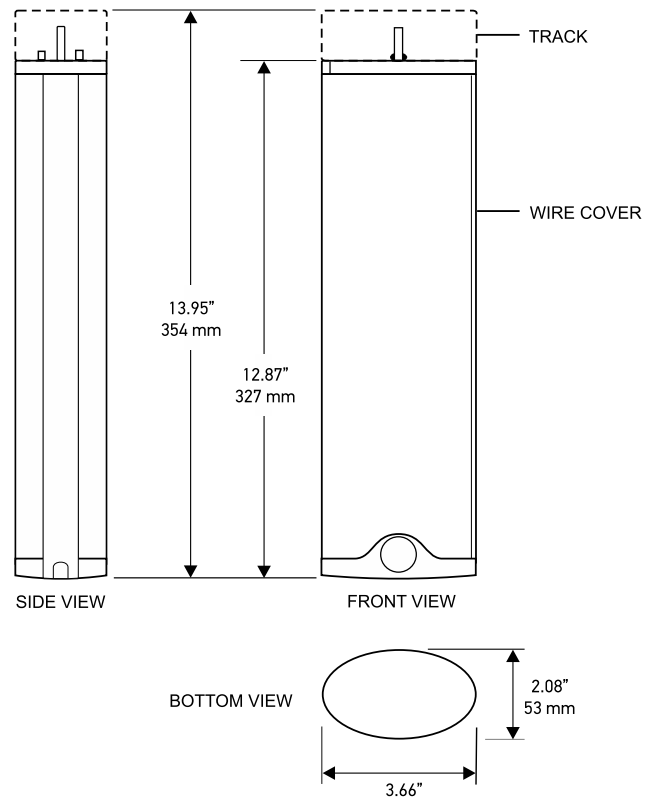

Irismo™ 35 Mini DC Drapery Motor, Integration and Power

IRISMO™ 35

Irismo™ 35 Mini DC



RTS 1003004
DCT 1003003

(24V DC power supply included)
(Optional 10 motor power panel available)

Please see pages 14 & 15 for wiring examples.
See below for power accessories.

INTEGRATION CONTROL MODULES FOR IRISMO™ 35 ONLY

Z-Wave®

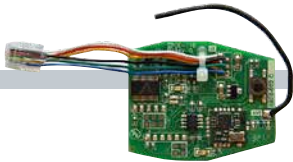

Easily integrates with Z-Wave® systems using the Z-Wave® plug-in module.

1870228

Zigbee®



Easily integrates with Zigbee® systems using the Zigbee® plug-in module.

1870221

RS485

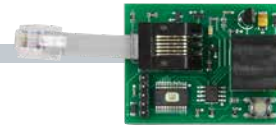

Easily integrates with Somfy Digital Network™ systems using the RS485 plug-in module.

1811129

CONTROL CARD ENCLOSURE FOR IRISMO™ 35

DC Control Card Enclosure



DC Control Card Enclosure

9021132

ENCLOSURE/CONTROL KITS

Z-Wave® Drapery Control Enclosure Kit

1870280

Zigbee® Drapery Control Enclosure Kit

1870281

SDN Irismo™ 35 24V Mini DC Control Enclosure Kit (includes cable for SDN & PoE)

1870282

POWER ACCESSORIES FOR IRISMO™ 35

Power Panel



The Power Panel for SDN is an SDN bus distribution component used to add 10 isolated motor ports and two isolated device ports to an SDN bus segment.

1870259

PoE Gateway



The SDN Power over Ethernet (PoE) Gateway is a low voltage power distribution and network-connected module that utilizes PoE (Power over Ethernet) technology to power and control the Somfy 24V RS485 motorization offer for shades and draperies.

1860326

Irismo™ 45 and Glydea Ultra® Drapery Motors, Integration and Power

IRISMO™ 45

Irismo™ 45 WireFree RTS



RTS 1002353

(Rechargeable Lithium-ion battery pack included)

Power Charger 1003080 &
Replacement Battery 9026476
(Sold Separately)

GLYDEA® ULTRA

Glydea® ULTRA 35 and Glydea® ULTRA 60



Glydea® ULTRA 35

RTS with 10' Plug	1003152
DCT with 10' Plug	1003151
Wired w/o Plug	1003153

Glydea® ULTRA 60

RTS with 10' Plug	1003159
DCT with 10' Plug	1003158
Wired w/o Plug	1003160

POWER ACCESSORIES FOR IRISMO™ 45

Plug-in Charger for Irismo™ 45



With 5 ft. cable - 20 AWG

1003080 (replaces 1002945)

INTEGRATION CONTROL MODULES FOR GLYDEA® ULTRA RTS & DCT MOTORS

RS485 Two-Way Module



RS485 Two-way Module for
Glydea® ULTRA Motors

1870275

Rechargeable Battery for Irismo™ 45



9026476 (replaces 9019741)

Zigbee® Module



Zigbee® Module for Glydea®
ULTRA Motors

9000043

Must use TaHoma® Interface (page 17).

Drapery Motor Wiring Examples



RTS RADIO CONTROL

Individual control



Group control



DRY CONTACT TECHNOLOGY (DCT) CONTROL

DRY CONTACT

The Dry Contact Control can be done through devices with 2 normally open contacts (open, close) or 3 normally open contacts (open, stop, close). For devices using 2 contacts, the stop command is achieved by closing the open and close contacts. For 3 devices, the stop can also be achieved with a specific stop button. Individual, group and master DCT controls can be achieved using a DCT Splitter and Diode boxes as shown below.

NUMBER OF DCT DRAPERY MOTORS AND LENGTH OF CONTROL LIMITATIONS

WIRE CROSS-SECTION	MAXIMUM LENGTH OF CABLE	MAXIMUM NUMBER OF MOTORS
Cat5 or Equal	328 ft. (100 m)	10
0.75 mm ²	656 ft. (200 m)	20

Individual control

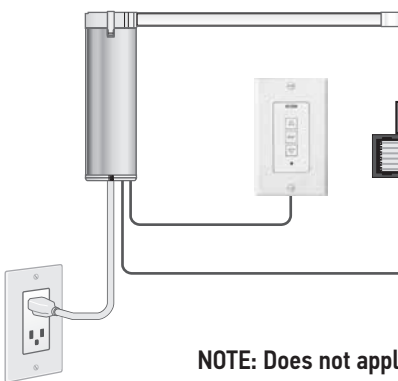

RJ12 SOCKET PIN OUT

For legacy motors

- 6) CW - CLOSE
- 5) STOP
- 4) +5V
- 3) GROUND COMMON
- 2) IR OUT
- 1) CCW - OPEN

For Glydea ULTRA

- 6) CW - CLOSE
- 5) STOP
- 4) NO USE
- 3) GROUND COMMON
- 2) NO USE
- 1) CCW-OPEN

Group control

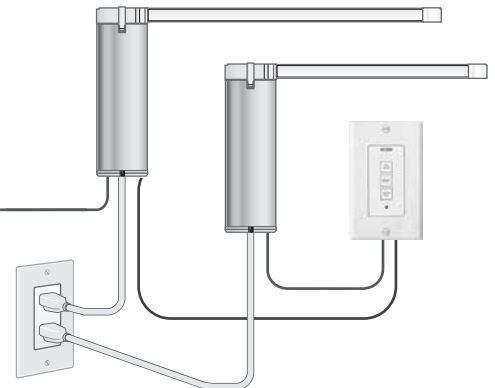

NOTE: Does not apply to Irismo™ 45 WireFree

WIRED CONTROL



Individual control

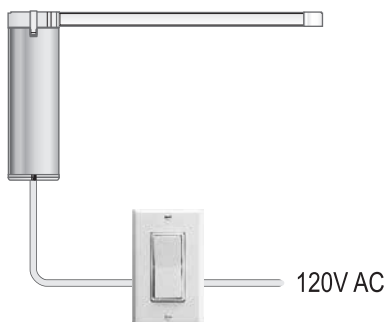

Brown	Dir1
Black	Dir2
Blue	Neutral
Green/Yellow	Ground

Group control

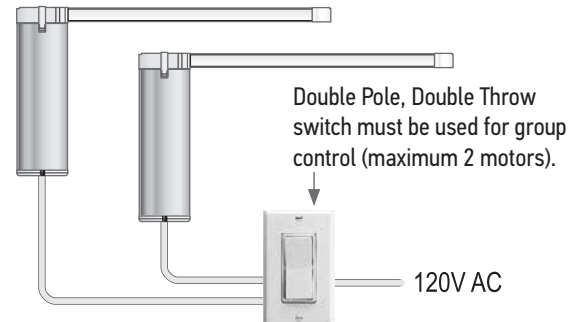

NOTES: Examples are for illustrative purposes. Additional components may be needed depending on your installation.
Applies to Glydea ULTRA range only.

Drapery Motor Wiring Examples



SOMFY DIGITAL NETWORK (SDN) WIRING EXAMPLES

Plug-in:

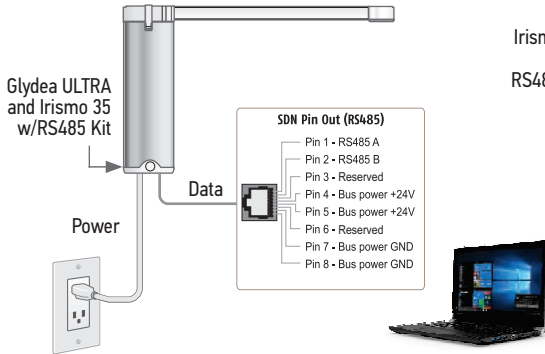

Power Panel:

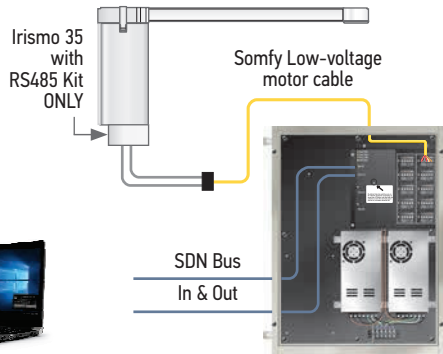

Power over Ethernet (PoE):

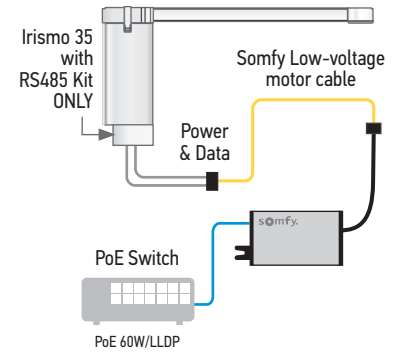

NOTES: Contact Somfy for additional details.

Z-WAVE® CONTROL



Individual control

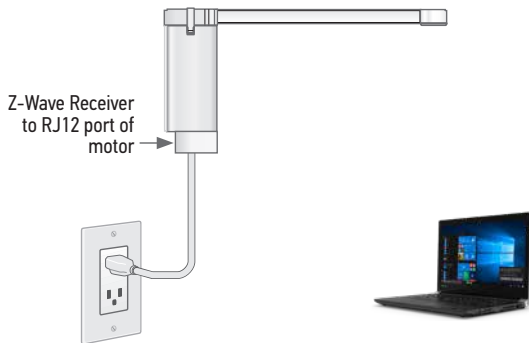

Group and individual control

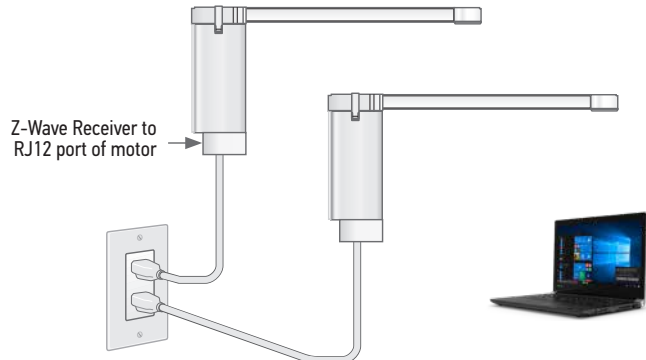

NOTES: Applies to Irismo 35 Mini DC only. Please see page 12 for more details.

ZIGBEE® CONTROL (GLYDEA ULTRA)

ZIGBEE® CONTROL (IRISMO 35 MINI DC)



Group and individual control

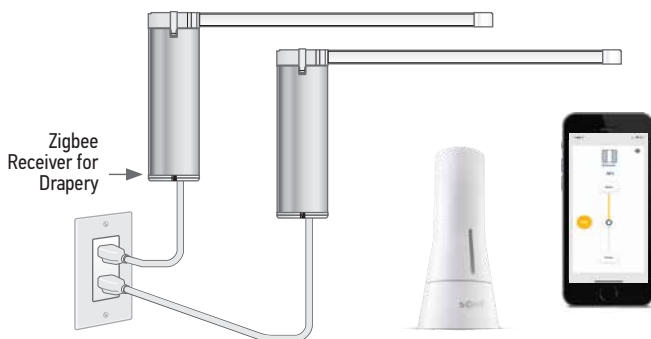

TaHoma is only compatible with Glydea ULTRA

Group and individual control

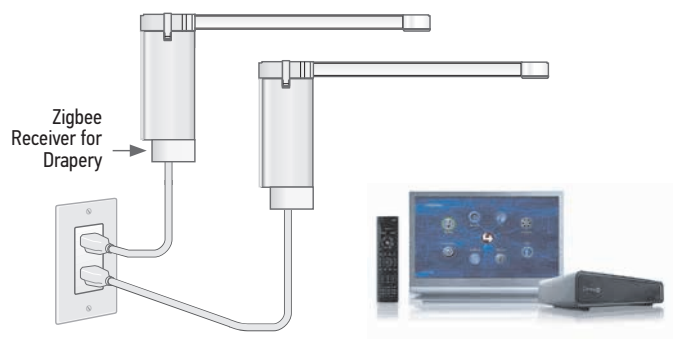

Irismo 35 is not compatible with TaHoma. Control TaHoma with third-party controls.

NOTES: Examples are for illustrative purposes. Additional components may be needed depending on your installation.

Does not apply to Irismo™ 45 WireFree

Drapery Controls and Accessories

Learn more about controls and accessories at www.somfy.com/controls

RADIO TECHNOLOGY SOMFY® (RTS)



TELIS HAND-HELD REMOTE COLLECTION



Situo 1 Channel
RTS Remote
1870571



Situo 5 Channel
RTS Remote
1870575



Telis 1 RTS Pure
1 Channel Remote
1810632



Telis 4 RTS Pure
5 Channel Remote
1810633



Telis 1 RTS Silver
1 Channel Remote
1810639



Telis 4 RTS Silver
5 Channel Remote
1810641



Telis 1 RTS Lounge
1 Channel Remote
1810650



Telis 4 RTS Lounge
5 Channel Remote
1810652



Situo 1 Channel
Zigbee Remote
1800194



Situo 4 Channel
Zigbee Remote
1800195



Telis 1 RTS Patio
1 Channel Remote
1810643



Telis 4 RTS Patio
5 Channel Remote
1810645



Telis 16 Channel RTS
Pure Remote with
On-Screen display
1811081



Telis 16 Channel RTS
Silver Remote with
On-Screen display
1811082



Telis 1 Chronis RTS
Pure Timer
1805237

DECOFLEX WIREFREE™ WALL SWITCHES



DecoFlex 1 Channel RTS
WireFree™ Wall Switch



DecoFlex 2 Channel RTS
WireFree™ Wall Switch



DecoFlex 3 Channel RTS
WireFree™ Wall Switch



DecoFlex 4 Channel RTS
WireFree™ Wall Switch



DecoFlex 5 Channel RTS
WireFree™ Wall Switch



Smoove® 1 RTS Pure



Smoove® 4 RTS Pure

- Wall Switches shown in white. Also available in black and ivory finishes.
- Shown assembled with printed channel buttons.
- Custom engraved buttons are also available.



Black



Ivory



Pure



Silver
Matte



Black



Light
Bamboo



Amber
Bamboo



Cherry



Walnut

- Battery-operated convenience
- Surface mounts with ease
- Frames available in 7 colors
- Double gang frame available (pure only)

INDOOR SENSORS



Sunis Indoor
WireFree™ RTS
9013707



ThermoSunis Indoor
WireFree™ RTS
9013708



DecoFlex WireFree™ RTS
Table Top Accessory Black
1811051*



DecoFlex WireFree™ RTS
Table Top Accessory Silver
1810972*



DecoFlex WireFree™ RTS
Table Top Accessory White
1811185*

*DecoFlex Switch sold separately from Table Top Accessory.

TABLE TOP ACCESSORIES

Drapery Controls and Accessories

Learn more about controls and accessories at www.somfy.com/controls

RADIO TECHNOLOGY SOMFY® (RTS)



WiFi TO RTS/ZIGBEE INTERFACES

16 CHANNEL INTERFACE

RTS REPEATER

ZRTSI II



myLink™ RTS Smartphone & Tablet Interface
1811403

Control window coverings, awnings, screens and rolling shutters using your tablet, smartphone or voice. Create timed events, scenes and more. Integration-ready for third-party control.

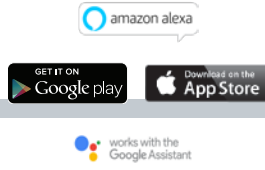

TaHoma® RTS/Zigbee Smartphone & Tablet Interface
1811731



Universal RTS Interface 16-Channel (Converts IR, RS232, RS485 to RTS)

1810872



RTS Repeater

1810791



Z-Wave® to RTS® Interface 2

1811265

SOMFY DIGITAL NETWORK (SDN)



SOMFY CONNECT™ LTI



Integrates Somfy RTS and Somfy Digital Network™ (SDN) motorized applications with RadioRA® 2, HomeWorks® QS, GRAFIC Eye® QS, and Quantum® control systems.
1870210

SOMFY CONNECT™

UNIVERSAL AUTOMATION INTERFACE (UAI) PLUS



Commission and integrate Somfy-powered SDN solutions over IP.

1870272

SOMFY CONNECT™

BMS INTERFACE



Provides communication between building management systems and SDN motorized shading systems.

1870249

WIRED TECHNOLOGY



DCT (DRY CONTACT TECHNOLOGY)

DRY CONTACT

DECORATOR PADDLE SWITCH



Maintained White
1800374
Double Pole,
Double Throw
1800375

For use with Glydea ULTRA wired motors only



Maintained Ivory
1800373
Double Pole,
Double Throw
1800376

DRY CONTACT SWITCH



White
1800219



Ivory
1800220

LIMIT SETTING TOOL



For use with Glydea ULTRA & Irismo DCT
9014599

Requires item #9015443
8 ft. Cable with RJ12 Plug

DRAPERY TRACK SPLITTER

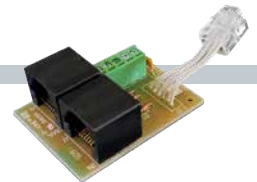

Splitter# 9015442
7ft Modular Cable.....# 9013346
25 ft. Modular Cable.....# 9013149

For group & individual control of DCT drapery motors

Drapery Components

COMMON TRACK COMPONENTS

Small Drive Pulley (white & bronze)



1782318



1782861

Drive Pulley (white & bronze)



1780945



1782873

Pulley Cover (white & bronze)



1780898



1782868

Straight Rail Joint



1782316

Heavy Duty Master Carrier



1781344

Silent Master Carrier

1782922

High Performance 10mm Belt



198' per roll
1782084

Track (white & bronze)



96' per carton (6 pcs. x 16')
1780899 per ft.



228' per carton (12 pcs x 19')
9025133 per ft.

RIPPLEFOLD® & ACCORDIA® TRACK COMPONENTS

Straight Arm Kit



1782321

For use with center opening draperies.

Overlap Arm Kit

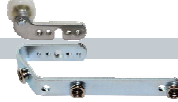

1782320

For use with one way and center opening draperies.

One Way Overlap Arm Kit



1780947

For use with tandem alternative straight arm.

Ripplefold® Butt Master Arms Kit



1780953

For use with center opening draperies only.

One Way Ripplefold® Butt Arm Kit



1782319

For use with Ripplefold one way opening and double track tandem alternative.

Straight Arm Kit



1782662

For use with tandem butted tracks alternative draperies (to be used together).

Ripplefold® and Accordia® Type Carriers

80% Fullness (White)

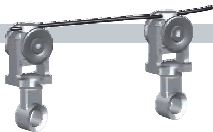

Carrier Spacing: 2 3/8"
Qty. per roll: 500
1780903

100% Fullness (White)

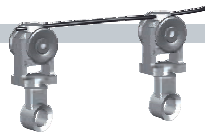

Carrier Spacing: 2 1/8"
Qty. per roll: 500
1780902

120% Fullness (White)

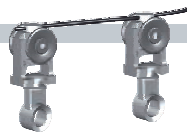

Carrier Spacing: 1 7/8"
Qty. per roll: 500
1780901

Ripple Snap Tape



100 yd. roll:
1782301
Per yd.
1782542

Ripple Return Snap



1780905

80% Fullness (Bronze)



Carrier Spacing: 2 3/8"
Qty. per roll: 500
1782872

100% Fullness (Bronze)

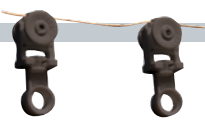

Carrier Spacing: 2 1/8"
Qty. per roll: 500
1782871

120% Fullness (Bronze)

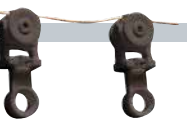

Carrier Spacing: 1 7/8"
Qty. per roll: 500
1782870



Bronze
1782863

Recommended for use with Somfy Ripple Snap Tape (ordered separately), but also adaptable to Kirsch and Graber snap tape.
Accordia® type carrier consists of Pinch Pleat carrier and Ripplefold® pendant.

Drapery Components

PINCH PLEAT TRACK COMPONENTS

Straight Arm Kit

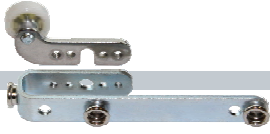

1782321

For use with center opening draperies.

Overlap Arm Kit

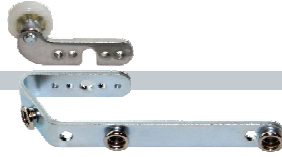

1782320

For use with one way and center opening draperies.

Pinch Pleat Return Hook



1780895

Bronze
1782862

Carrier

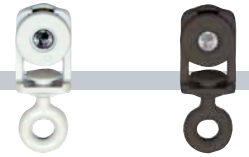

1781415

Silent Carrier (white only)
1782921

Bronze
1782869

One Way Overlap Arm Kit

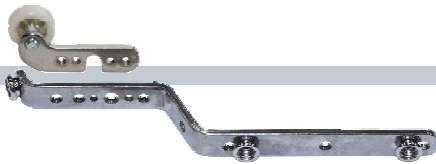

1780947

For use with one way opening draperies with pulley #1780945.

Straight Arm Kit



1782662

For use with tandem butted tracks alternative draperies (to be used together).

BRACKETS

One Touch Ceiling Bracket



1780907

Adjustable Wall Mount Bracket

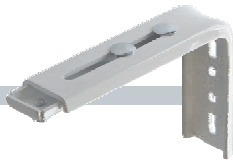

Projection 4.5" - 6"
1780909

Double Adjustable Wall Mount Bracket



Projection 8.75" - 10.25"
1780910

Swivel Ceiling Bracket



1780906



Bronze
1782865



Bronze
Projection 4.5" - 6"
1782866



Bronze
Projection 8.75" - 10.25"
1782867



Bronze
1782864

Adjustable Wall/Ceiling Mount Bracket Kit

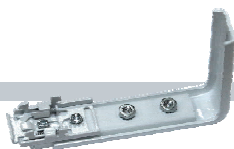

Projection 4.5" - 6"
1782054

Double Adjustable Wall/Ceiling Mount Bracket Kit

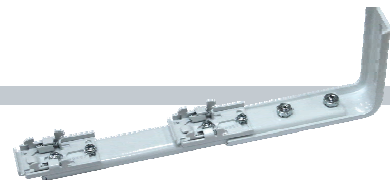

Projection 8.75" - 10.25"
1782053

Product Dimensional Specifications

CARRIER ARM DIMENSIONS

Overlap Arm - #1782320

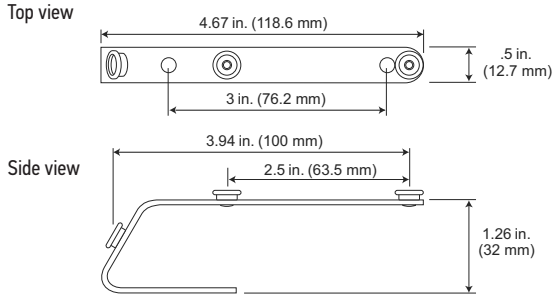

Overlap Arm - #1780947

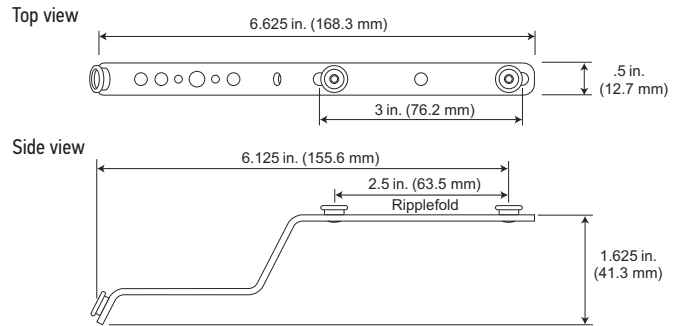

Straight Arm* - #1782321

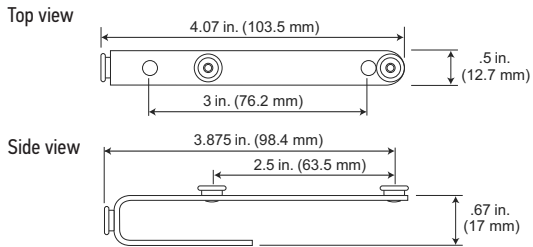

Straight Arm - #1782662

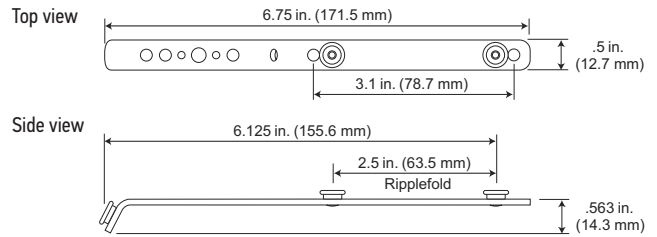

*For use with one-way opening with standard drive pulley.

One Way Butt Arm - #1782319

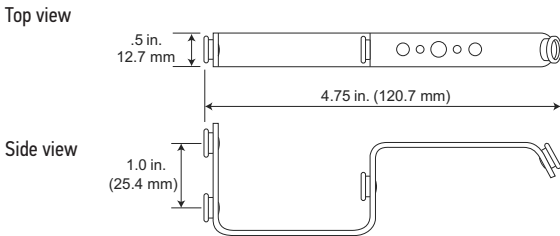

Butt Master Arm Center Opening - #1780953

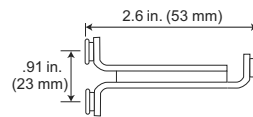

WALL BRACKET DIMENSIONS

Adjustable Wall Mount Bracket - #1780909 & 1782866

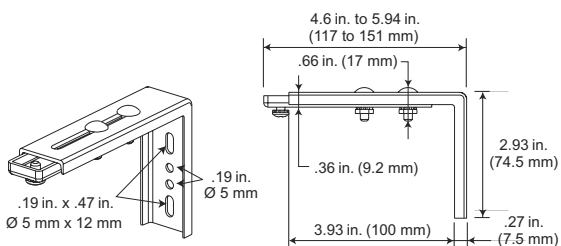

Double Adjustable Wall Mount Bracket - #1780910 & 1782867

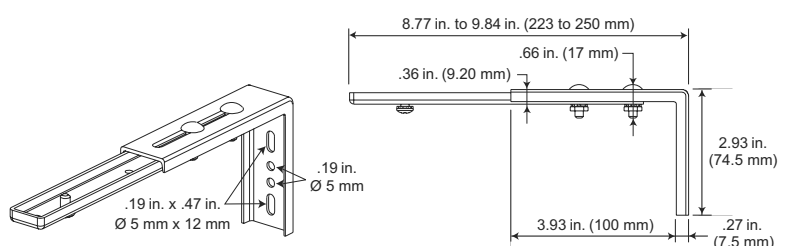

Product Dimensional Specifications

TRACK PROFILE

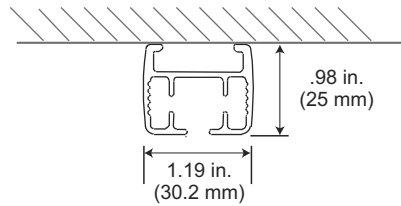

CEILING BRACKET DIMENSIONS

One Touch Ceiling Bracket - #1780907 & 1782865

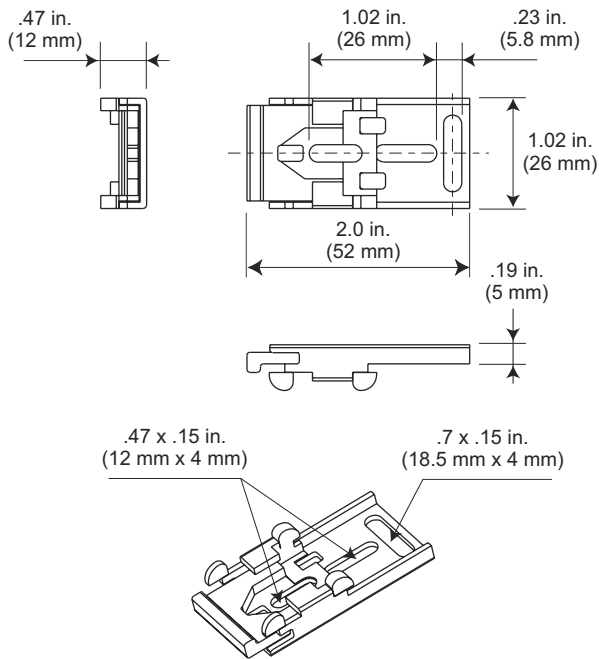

Carriers

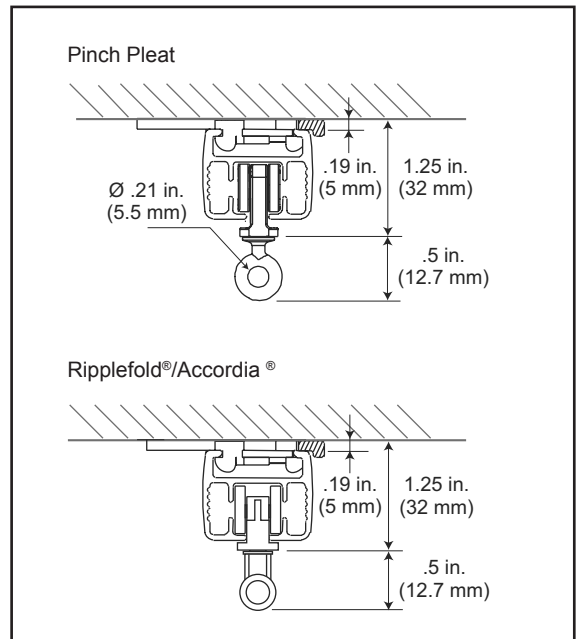

Swivel Ceiling Bracket - #1780906 & 1782864 (recommended for curved tracks)

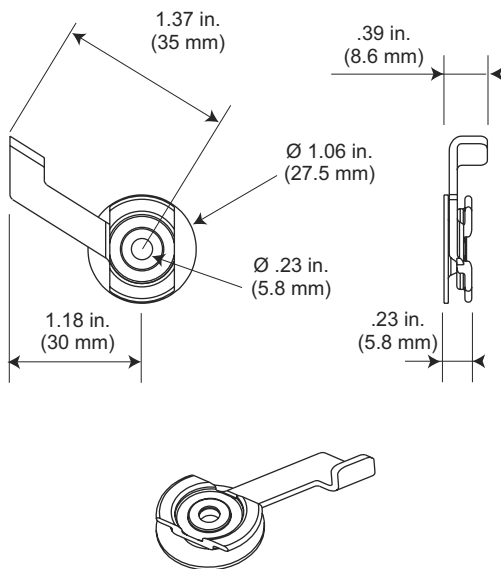

Carriers

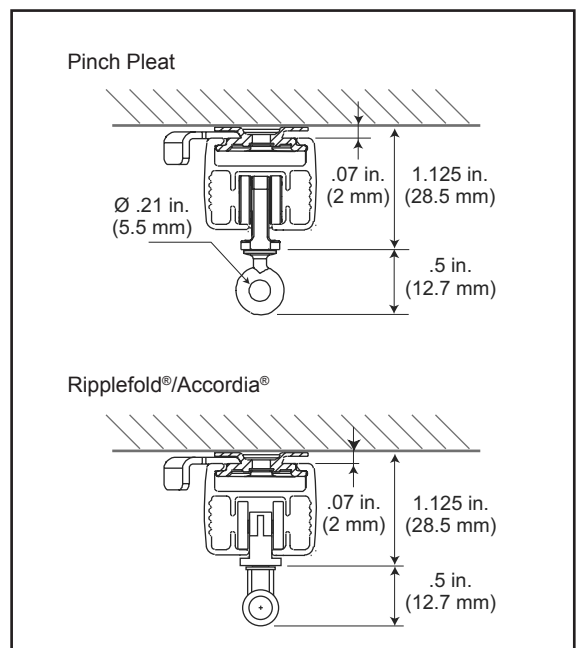

Track Configurations

RIPPLEFOLD® One Way Stacked

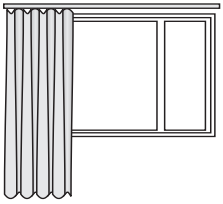

REQUIRED ARMS (1)



REQUIRED ARMS (1)



Bottom-up view of track and drape assembly

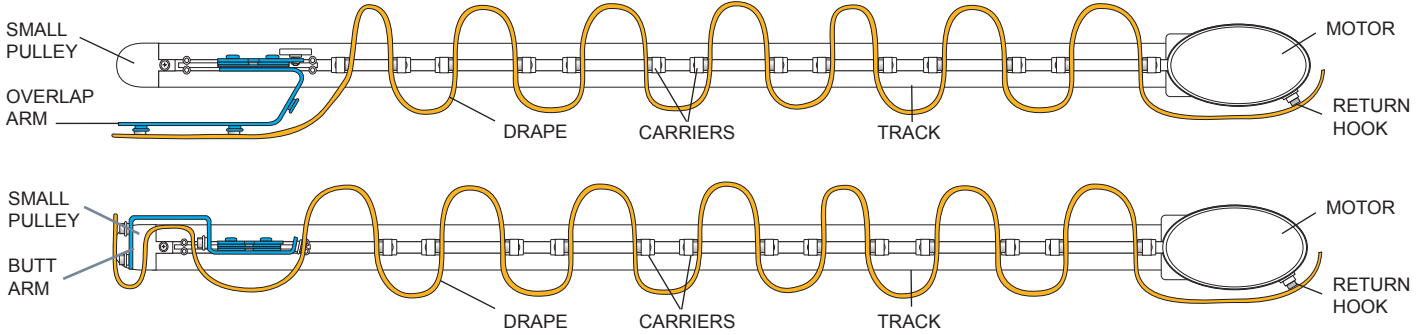

Center Opening

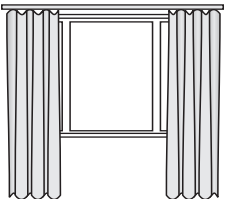

REQUIRED ARMS (1 each)



Bottom-up view of track and drape assembly

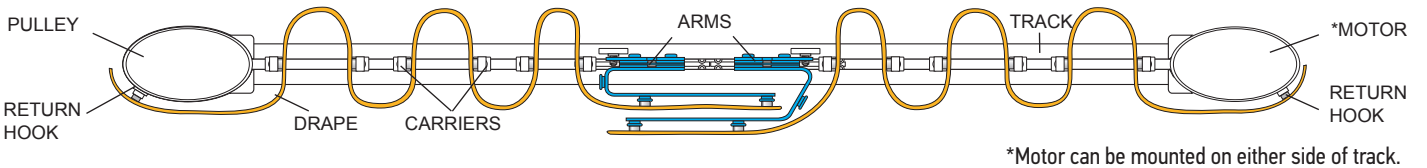

Center Opening with Butt Master Arms

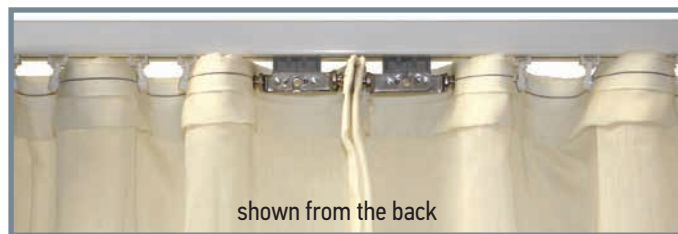
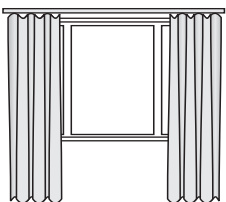

REQUIRED ARMS (2)



Bottom-up view of track and drape assembly

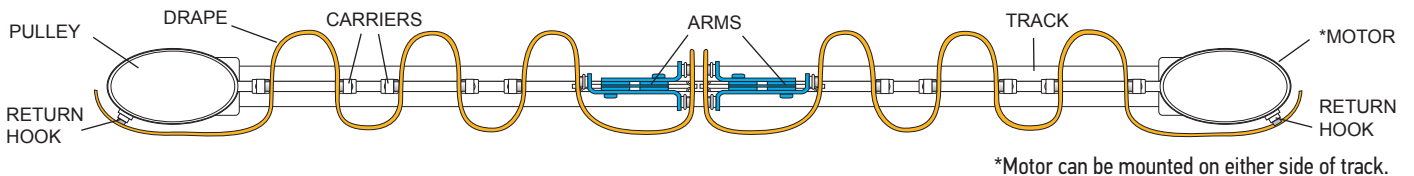

Track Configurations

PINCH PLEAT One Way Stacked

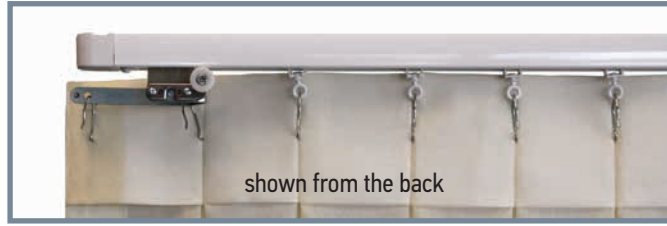
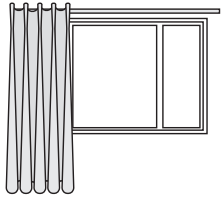

REQUIRED ARMS (1)

One Way Overlap Arm Kit - #1782320



Bottom-up view of track and drape assembly

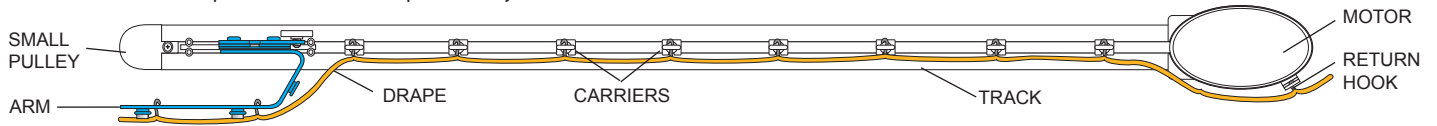

Center Opening

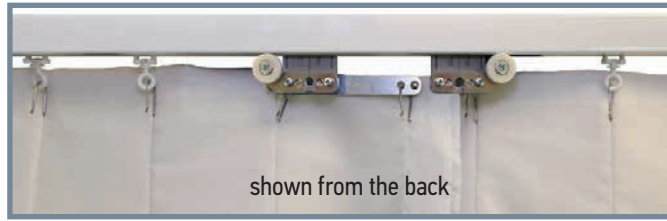
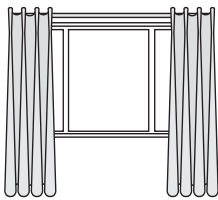

REQUIRED ARMS (1 each)

Straight Arm Kit - #1782321



Overlap Arm Kit - #1782320

Bottom-up view of track and drape assembly

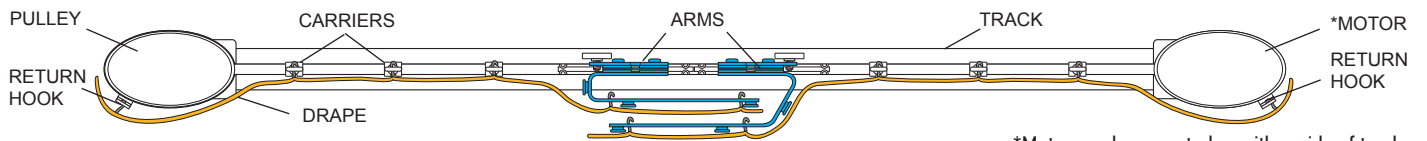

*Motor can be mounted on either side of track.

PINCH PLEAT AND RIPPLEFOLD® Two One Way Butted Tracks (tandem alternative)

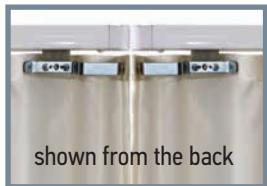
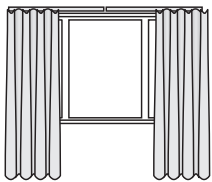

REQUIRED ARMS (2)

One Way Butt Arm Kit - #1782319



REQUIRED ARMS (2)

Straight Arm Kit - #1782662



Overlap Arm Kit - #1780947

Bottom-up view of track and drape assembly

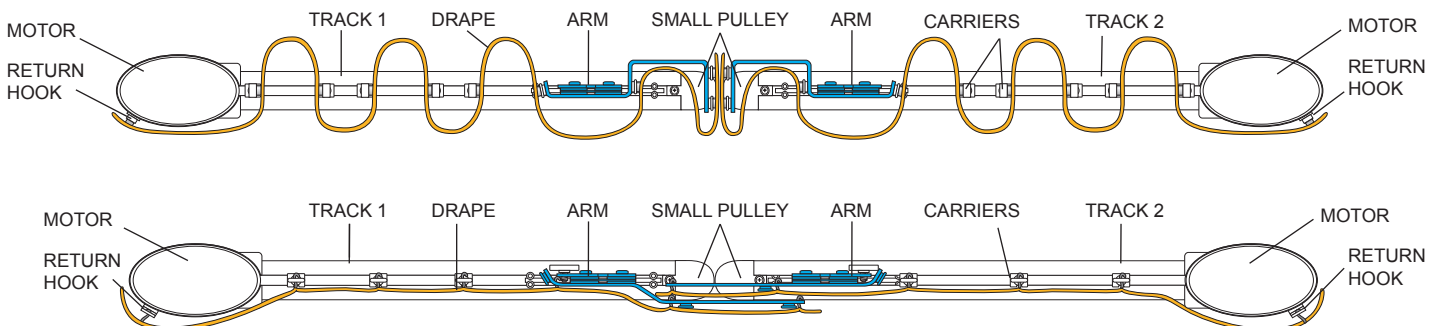

Technical Specifications

SELECTION CHARTS

*STACKING CHART - for reference only

Track Type	Glydea® 35e & Irismo™ 35 Mini DC			Irismo™ 45 WireFree RTS			Glydea® 60e		
	UP TO 10 FT.	UP TO 20 FT.	UP TO 32 FT.	UP TO 10 FT.	UP TO 20 FT.	UP TO 33 FT.	UP TO 10 FT.	UP TO 32 FT.	UP TO 36 FT.
A One Way	77 Lbs.			99 Lbs.			132 Lbs.		
B Center Opening	77 Lbs.			99 Lbs.			132 Lbs.		
C Asymetrical	77 Lbs.			99 Lbs.			132 Lbs.		
D One Way w/Bend R = 30 cm max (11.8")	77 Lbs.	55 Lbs.	44 Lbs.	99 Lbs.	99 Lbs.	77 Lbs.	100 Lbs.	100 Lbs.	77 Lbs.
E Center Opening w/Bend R = 30 cm max (11.8")	77 Lbs.	55 Lbs.	44 Lbs.	99 Lbs.	99 Lbs.	77 Lbs.	100 Lbs.	100 Lbs.	77 Lbs.
F One Way w/2 Bends R = 30 cm max (11.8")	33 Lbs.	22 Lbs.	-	77 Lbs.	66 Lbs.	44 Lbs.	77 Lbs.	55 Lbs.	-
G Center Opening w/2 Bends R = 30 cm max (11.8")	33 Lbs.	22 Lbs.	-	77 Lbs.	66 Lbs.	44 Lbs.	77 Lbs.	55 Lbs.	-
H One Way w/Continuous Curve R = 300 cm (118")	77 Lbs.	33 Lbs.	-	77 Lbs.	44 Lbs.	-	132 Lbs.	55 Lbs.	-
I Center Opening w/Continuous Curve R = 300 cm (118")	66 Lbs.	22 Lbs.	-	66 Lbs.	44 Lbs.	-	113 Lbs.	38 Lbs.	-

TRACK SIZES	RIPPLEFOLD® - inches carrier count - ()					
	ONE WAY 80%	ONE WAY 100%	ONE WAY 120%	CENTER OPENING 80%	CENTER OPENING 100%	CENTER OPENING 120%
	Butt Arm	Butt Arm	Butt Arm	Butt Arm	Butt Arm	Butt Arm
Up to 4 ft.	19.5 (20)	21.5 (24)	23.5 (28)	12.25 (20)	13.25 (24)	14.25 (28)
5 ft.	22 (25)	24.5 (30)	27 (35)	13.75 (26)	14.75 (30)	16.25 (36)
6 ft.	24.5 (30)	27.5 (36)	30.5 (42)	14.75 (30)	16.25 (36)	17.75 (42)
7 ft.	27 (35)	30.5 (42)	34 (49)	16.25 (36)	17.75 (42)	19.75 (50)
8 ft.	29.5 (40)	33.5 (48)	37.5 (56)	17.25 (40)	19.25 (48)	21.25 (56)
9 ft.	32 (45)	36.5 (54)	41 (63)	18.75 (46)	20.75 (54)	23.25 (64)
10 ft.	34.5 (50)	39.5 (60)	44.5 (70)	19.75 (50)	22.25 (60)	24.75 (70)
11 ft.	37 (55)	42.5 (66)	48 (77)	21.25 (56)	23.75 (66)	26.75 (78)
12 ft.	39.5 (60)	45.5 (72)	51.5 (84)	22.25 (60)	25.25 (72)	28.25 (84)
13 ft.	42 (65)	48.5 (78)	55 (91)	23.75 (66)	26.75 (78)	30.25 (92)
14 ft.	44.5 (70)	51.5 (84)	58.5 (98)	24.75 (70)	28.25 (84)	31.75 (98)
15 ft.	47 (75)	54.5 (90)	62 (105)	26.25 (76)	29.75 (90)	33.75 (106)
16 ft.	49.5 (80)	57.5 (96)	65.5 (112)	27.25 (80)	31.25 (96)	35.25 (112)
17 ft.	52 (85)	60.5 (102)	69 (119)	28.75 (86)	32.75 (102)	37.25 (120)
18 ft.	54.5 (90)	63.5 (108)	72.5 (126)	29.75 (90)	34.25 (108)	38.75 (126)
19 ft.	57 (95)	66.5 (114)	76 (133)	31.25 (96)	35.75 (114)	40.75 (134)
20 ft.	59.5 (100)	69.5 (120)	79.5 (140)	32.25 (100)	37.25 (120)	42.25 (140)
21 ft.	62 (105)	72.5 (126)	83 (147)	33.75 (106)	38.75 (126)	44.25 (148)
22 ft.	64.5 (110)	75.5 (132)	86.5 (154)	34.75 (110)	40.25 (132)	45.75 (154)
23 ft.	67 (115)	78.5 (138)	90 (161)	36.25 (116)	41.75 (138)	47.75 (162)
24 ft.	69.5 (120)	81.5 (144)	93.5 (168)	37.25 (120)	43.25 (144)	49.25 (168)
25 ft.	72 (125)	84.5 (150)	97 (175)	38.75 (126)	44.75 (150)	51.25 (176)
26 ft.	74.5 (130)	87.5 (156)	100.5 (182)	39.75 (130)	46.25 (156)	52.75 (182)
27 ft.	77 (135)	90.5 (162)	104 (189)	41.25 (136)	47.75 (162)	54.75 (190)
28 ft.	79.5 (140)	93.5 (168)	107.5 (196)	42.25 (140)	49.25 (168)	56.25 (196)
29 ft.	82 (145)	96.5 (174)	111 (203)	43.75 (146)	50.75 (174)	58.25 (204)
30 ft.	84.5 (150)	99.5 (180)	114.5 (210)	44.75 (150)	52.25 (180)	59.75 (210)
31 ft.	87 (155)	102.5 (186)	118 (217)	46.25 (156)	53.75 (186)	61.75 (218)
32 ft.	89.5 (160)	105.5 (192)	121.5 (224)	47.25 (160)	55.25 (192)	63.25 (224)
33 ft.	92 (165)	108.5 (198)	125 (231)	48.75 (166)	56.75 (198)	65.25 (232)
34 ft.	94.5 (170)	111.5 (204)	128.5 (238)	49.75 (170)	58.25 (204)	66.75 (238)
35 ft.	97 (175)	114.5 (210)	132 (245)	51.25 (176)	59.75 (210)	68.75 (246)
36 ft.	99.5 (180)	117.5 (216)	135.5 (252)	52.25 (180)	61.25 (216)	70.25 (252)

DUAL MOTOR TANDEM ALTERNATIVE (2 one way tracks)

Track Type		Irismo™ 45 WireFree RTS			Glydea® 60e			Glydea® 35e & Irismo™ 35 Mini DC		
		UP TO 10 FT.	UP TO 20 FT.	UP TO 33 FT.	UP TO 10 FT.	UP TO 32 FT.	UP TO 36 FT.	UP TO 10 FT.	UP TO 20 FT.	UP TO 32 FT.
J Center opening w/2 Straight	(1) Straight	99 Lbs.			132 Lbs.			77 Lbs.		
	(1) Straight	99 Lbs.			132 Lbs.			77 Lbs.		
K Center opening w/1 Bend	(1) 90° Bend	99 Lbs.	99 Lbs.	33 Lbs.	100 Lbs.	77 Lbs.	77 Lbs.	55 Lbs.	44 Lbs.	
	(1) Straight	99 Lbs.			132 Lbs.			77 Lbs.		
L Center opening w/2 Bends	(1) 90° Bend	99 Lbs.	99 Lbs.	77 Lbs.	100 Lbs.	77 Lbs.	77 Lbs.	55 Lbs.	44 Lbs.	
	(1) 90° Bend	99 Lbs.	99 Lbs.	77 Lbs.	100 Lbs.	77 Lbs.	77 Lbs.	55 Lbs.	44 Lbs.	
M Center opening w/2 Curves	(1) Curve	77 Lbs.	44 Lbs.	-	132 Lbs.	55 Lbs.	-	77 Lbs.	33 Lbs.	-
	(1) Curve	77 Lbs.	44 Lbs.	-	132 Lbs.	55 Lbs.	-	77 Lbs.	33 Lbs.	-

* Measurements do not consider drapery fabric and are calculated from end of pulley to front of master arm (shown here).

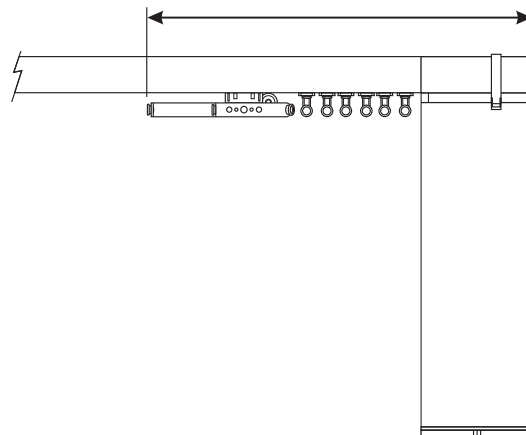

Technical Specifications

*STACKING CHART CONT'D - for reference only

TRACK SIZES	RIPPLEFOLD® - inches carrier count - ()									PINCH PLEAT - inches carrier count - ()		
	ONE WAY 80%	ONE WAY 100%	ONE WAY 120%	CENTER OPENING 80%		CENTER OPENING 100%		CENTER OPENING 120%		ONE WAY	CENTER OPENING	
	Overlap Arm	Overlap Arm	Overlap Arm	Overlap Arm	Straight Arm	Overlap Arm	Straight Arm	Overlap Arm	Straight Arm	Overlap Arm	Overlap Arm	Straight Arm
Up to 4 ft.	19.25 (20)	21.25 (24)	23.25 (28)	14 (10)	13.75 (10)	15 (12)	14.75 (12)	16.25 (14)	16 (14)	15.25 (12)	11.75 (6)	11.5 (6)
5 ft.	21.75 (25)	24.25 (30)	26.75 (35)	15.5 (13)	15.25 (13)	16.5 (15)	16.25 (15)	18.25 (18)	18 (18)	16.75 (15)	12.75 (8)	12.5 (8)
6 ft.	24.25 (30)	27.25 (36)	30.25 (42)	16.5 (15)	16.25 (15)	18 (18)	17.75 (18)	19.75 (21)	19.5 (21)	18.25 (18)	13.25 (9)	13 (9)
7 ft.	26.75 (35)	30.25 (42)	33.75 (49)	18 (18)	17.75 (18)	19.5 (21)	19.25 (21)	21.75 (25)	21.5 (25)	19.75 (21)	14.25 (11)	14 (11)
8 ft.	29.25 (40)	33.25 (48)	37.25 (56)	19 (20)	18.75 (20)	21 (24)	20.75 (24)	23.25 (28)	23 (28)	21.25 (24)	14.75 (12)	14.5 (12)
9 ft.	31.75 (45)	36.25 (54)	40.75 (63)	20.5 (23)	20.25 (23)	22.5 (26)	22.25 (26)	25.25 (32)	25 (32)	22.75 (27)	15.75 (14)	15.5 (14)
10 ft.	34.25 (50)	39.25 (60)	44.25 (70)	21.5 (25)	21.25 (25)	24 (30)	23.75 (30)	26.75 (35)	26.5 (35)	24.25 (30)	16.25 (15)	16 (15)
11 ft.	36.75 (55)	42.25 (66)	47.75 (77)	23 (28)	22.75 (28)	25.5 (33)	25.25 (33)	28.75 (39)	28.5 (39)	25.75 (33)	17.25 (17)	17 (17)
12 ft.	39.25 (60)	45.25 (72)	51.25 (84)	24 (30)	23.75 (30)	27 (36)	26.75 (36)	30.25 (42)	30 (42)	27.25 (36)	17.75 (18)	17.5 (18)
13 ft.	41.75 (65)	48.25 (78)	54.75 (91)	25.5 (33)	25.25 (33)	28.5 (39)	28.25 (39)	32.25 (46)	32 (46)	28.75 (39)	18.75 (20)	18.5 (20)
14 ft.	44.25 (70)	51.25 (84)	58.25 (98)	26.5 (35)	26.25 (35)	30 (42)	29.75 (42)	33.75 (49)	33.5 (49)	30.25 (42)	19.25 (21)	19 (21)
15 ft.	46.75 (75)	54.25 (90)	61.75 (105)	28 (38)	27.75 (38)	31.5 (45)	31.25 (45)	35.75 (53)	35.5 (53)	31.75 (45)	20.25 (23)	20 (23)
16 ft.	49.25 (80)	57.25 (96)	65.25 (112)	29 (40)	28.75 (40)	33 (48)	32.75 (48)	37.25 (56)	37 (56)	33.25 (48)	20.75 (24)	20.5 (24)
17 ft.	51.75 (85)	60.25 (102)	68.75 (119)	30.5 (43)	30.25 (43)	34.5 (51)	34.25 (51)	39.25 (60)	39 (60)	34.75 (51)	21.75 (26)	21.5 (26)
18 ft.	54.25 (90)	63.25 (108)	72.25 (126)	31.5 (45)	31.25 (45)	36 (54)	35.75 (54)	40.75 (63)	40.5 (63)	36.25 (54)	22.25 (27)	22 (27)
19 ft.	56.75 (95)	66.25 (114)	75.75 (133)	33 (48)	32.75 (48)	37.5 (57)	37.25 (57)	42.75 (67)	42.5 (67)	37.75 (57)	23.25 (29)	23 (29)
20 ft.	59.25 (100)	69.25 (120)	79.24 (140)	34 (50)	33.75 (50)	39 (60)	38.75 (60)	44.25 (70)	44 (70)	39.25 (60)	23.75 (30)	23.5 (30)
21 ft.	61.75 (105)	72.25 (126)	82.75 (147)	35.5 (53)	35.25 (53)	40.5 (63)	40.25 (63)	46.25 (74)	46 (74)	40.75 (63)	24.75 (32)	24.5 (32)
22 ft.	64.25 (110)	75.25 (132)	86.25 (154)	36.5 (55)	36.25 (55)	42 (66)	41.75 (66)	47.75 (77)	47.5 (77)	42.25 (66)	25.25 (33)	25 (33)
23 ft.	66.75 (115)	78.25 (138)	89.75 (161)	38 (58)	37.75 (58)	43.5 (69)	43.25 (69)	49.75 (81)	49.5 (81)	43.75 (69)	26.25 (35)	26 (35)
24 ft.	69.25 (120)	81.25 (144)	93.25 (168)	39 (60)	38.75 (60)	45 (72)	44.75 (72)	51.25 (84)	52 (84)	45.25 (72)	26.75 (36)	26.5 (36)
25 ft.	71.75 (125)	84.25 (150)	96.75 (175)	40.5 (63)	40.25 (63)	46.5 (75)	46.25 (75)	53.25 (88)	53 (88)	46.75 (75)	27.75 (38)	27.5 (38)
26 ft.	74.25 (130)	87.25 (156)	100.25 (182)	41.5 (65)	41.25 (65)	48 (78)	47.75 (78)	54.75 (91)	54.5 (91)	48.25 (78)	28.25 (39)	28 (39)
27 ft.	76.75 (135)	90.25 (162)	103.75 (189)	43 (68)	42.75 (68)	49.5 (81)	49.25 (81)	56.75 (95)	56.5 (95)	49.75 (81)	29.25 (41)	29 (41)
28 ft.	79.25 (140)	93.25 (168)	107.25 (196)	44 (70)	43.75 (70)	51 (84)	50.75 (84)	58.25 (98)	58 (98)	51.25 (84)	29.75 (42)	29.5 (42)
29 ft.	81.75 (145)	96.25 (174)	110.75 (203)	45.5 (73)	45.25 (73)	52.5 (87)	52.25 (87)	60.25 (102)	60 (102)	52.75 (87)	30.75 (44)	30.5 (44)
30 ft.	84.25 (150)	99.25 (180)	114.25 (210)	46.5 (75)	46.25 (75)	54 (90)	53.75 (90)	61.75 (105)	61.5 (105)	54.25 (90)	31.25 (45)	31 (45)
31 ft.	86.75 (155)	102.3 (186)	117.75 (217)	48 (78)	47.75 (78)	55.5 (93)	55.25 (93)	63.75 (108)	63.5 (108)	55.75 (93)	32.25 (47)	32 (47)
32 ft.	89.25 (160)	105.3 (192)	121.25 (224)	49 (80)	48.75 (80)	57 (96)	56.75 (96)	65.25 (112)	65 (112)	57.25 (96)	32.75 (48)	32.5 (48)
33 ft.	91.75 (165)	108.3 (198)	124.75 (231)	50.5 (83)	50.25 (83)	58.5 (99)	58.25 (99)	67.25 (116)	67 (116)	58.75 (99)	33.75 (50)	33.5 (50)
34 ft.	94.25 (170)	111.3 (204)	128.25 (238)	51.5 (85)	51.25 (85)	60 (102)	59.75 (102)	68.75 (118)	68.5 (118)	60.25 (102)	34.25 (51)	34 (51)
35 ft.	96.75 (175)	114.3 (210)	131.75 (245)	53 (86)	52.75 (86)	61.5 (105)	61.25 (105)	70.75 (123)	70.5 (123)	61.75 (105)	35.25 (53)	35 (53)
36 ft.	99.25 (180)	117.3 (216)	135.25 (252)	54 (90)	53.75 (90)	63 (108)	62.75 (108)	72.25 (126)	72 (126)	63.25 (108)	35.75 (54)	35.5 (54)

Drapery Fabricated Track Options*

AVAILABLE CARRIER ARMS

Carrier arms are included with fabricated motorized drapery tracks per the opening type.

ONE WAY OPENING

Overlap Arm - For use with one way opening Pinch Pleat, one way Ripplefold® and Accordia® draperies.
Qty 1 per drapery track.

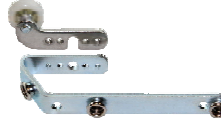

One Way Overlap Arm Kit
1782320

CENTER OPENING

Overlap Arm - For use with center opening Pinch Pleat, Ripplefold® and Accordia® draperies.
Qty 1 Overlap Arm per drapery track.
Qty 1 Straight Arm per drapery track.



Overlap Arm Kit
1782320
&
Straight Arm Kit
1782321

CENTER OPENING BUTT MASTER

Butt Master Arm - For use with Ripplefold® and Accordia® center opening draperies only.
Qty 2 per drapery track required.



or (optional)
Butt Master Arms
1780953

ONE WAY OPENING OR TWO MOTOR TANDEM

One Way Butt Arm - For use with Ripplefold® one way draperies and 2 motor tandem alternative.
Qty 1 per drapery track required.

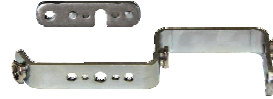

One Way Butt Arm Kit
1782319

TWO MOTOR TANDEM ALTERNATIVE

Overlap Arm/ Straight Arm - For use with Pinch Pleat and 2 motor tandem alternative. Qty 1 per drapery track required.

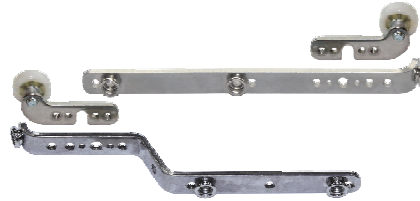

Straight Arm Kit
1782662
&
Overlap Arm Kit
1780947

***Fabricated tracks are available upon request.
For more information, please contact Somfy sales.**

AVAILABLE CARRIERS

Carriers are included with fabricated motorized drapery tracks.

PINCH PLEAT DRAPERIES

Pinch Pleat Carriers: Somfy includes a quantity of 3 carriers per foot. Additional carriers can be ordered if necessary.



Carrier
1781415



Bronze
1782869

Pinch Pleat Return Hook:

Qty 2 for One Way Draw (included)
Qty 4 for Center Opening (included)



Return Hook
1780895



Bronze
1782862

RIPPLEFOLD®/ACCORDIA® DRAPERIES

****Somfy Ripplefold®/Accordia® Type Carriers:** The quantity of carriers needed depends on the desired fullness, reference the chart below to determine the needed quantity and standard spacing. Each carrier comes complete with pendant. See page 24-25 for Somfy's carrier count.

Item # (white)	Item # (bronze)	Fullness	**Carrier Spacing
1780903	1782872	80%	2 3/8" / 5 per ft. (included)
1780902	1782871	100%	2 1/8" / 6 per ft. (included)
1780901	1782870	120%	1 7/8" / 7 per ft. (included)

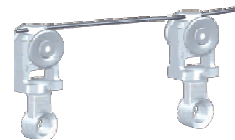

Carrier and Pendant



****Note: Quantity per ft. is included with each fabricated track. Fullness must be specified when order is placed.**

Recommended for use with Somfy Ripple Snap Tape (ordered separately), but also adaptable to Kirsch and Graber snap tape.

Ripple Snap Tape:



(100 yd. roll) 1782301
(per yd.) 1782542

Return Snap:

Qty 2 for One Way Draw (included)
Qty 4 for Center Opening (included)



Return Snap
1780905



Bronze
1782863

Custom Track Options

Tandem Alternative

Tandem alternative RTS motorized systems utilize two drapery motors and are used for draperies that exceed the maximum single motor capacity. Tandem systems are also available with dry contact control technologies and require additional accessories.

See pages 23 & 24 for track configurations and specification details



Top Mount

Drapery motors can be installed above the drapery track depending on your project needs. This option provides the ability to conceal the motor in a drop ceiling or under a valance and requires an additional kit.

Top Mount Kit
#1780908

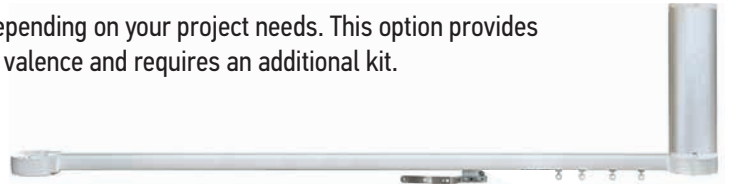

Glystro® Conversion Kit

The Glystro® conversion kit is designed to allow adaptation to Somfy's current drapery tracks to previous Glystro® drapery tracks and associated hardware.



#1782106

Bends (Not compatible with Irismo™ 45 WireFree RTS)

Tracks with bends are ideal for bay and corner windows. Track bends are available at a fixed radius of 11.8 in. For more information on how to measure for a bend, please see page 28.

Bent Drapery Track Measurement Form required for all orders.

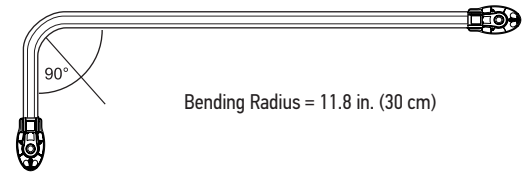

Curves (Not compatible with Irismo™ 45 WireFree RTS)

Custom curves are ideal for bow windows and other special applications. For additional information on how to measure for a curve, and how to make a template, please see [Directions for Creating a Template for Drapery Curves](#) page 29.

Templates are required for accuracy for all orders.

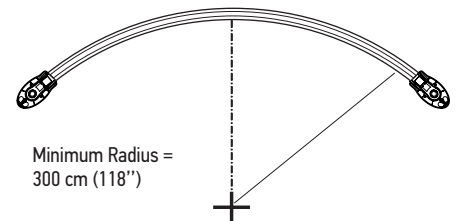

BRACKET MOUNTING RECOMMENDATIONS (TOP VIEW OF TRACK)

Somfy recommends 1 bracket by each pulley and 1 bracket every 24 in. Also, 1 bracket should be placed on each side of a splice if used.

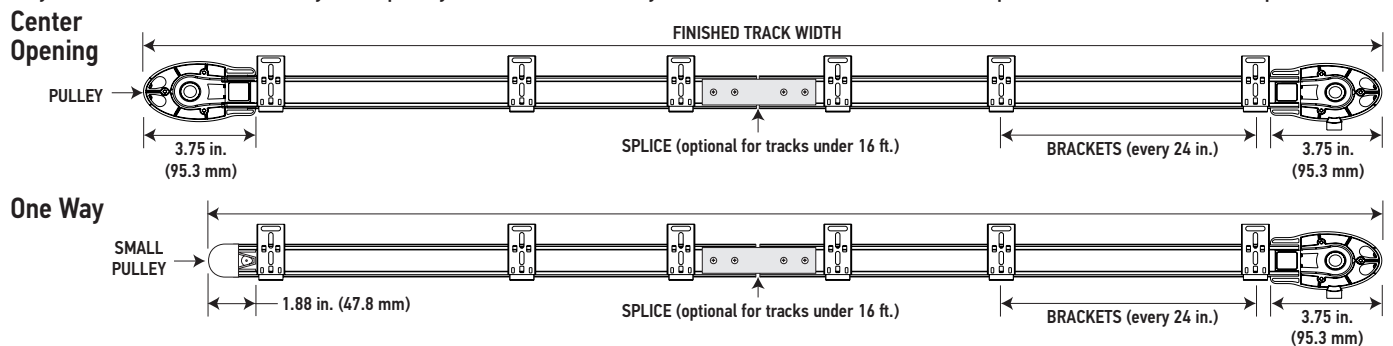

Bent Drapery Track Measurement Form

1. Choose the design that best fits your room setup.
2. Measure the wall and degrees of all angles as in examples shown below.
 - Make sure to provide the return measurement "R" (distance from wall to front of drapery track as shown in red). The bent track measurement form represents wall measurements, therefore the "R" dimension MUST BE specified for accurate track fabrication. If "R" dimension IS NOT specified, drapery track will be fabricated according to dimensions (A, B, C, D, etc.) provided.
 - Return dimensions will not be considered, and measurements will be calculated from center of each bend.
 - When fabricating drapery, please add an additional 1.5 inches of drapery fabric to the anticipated return size.
3. Provide all measurements by filling out order form and submitting to Somfy.

NOTE: The following dimensions are shown from top view of the track and show various wall designs.

STYLE 1 MEASUREMENT

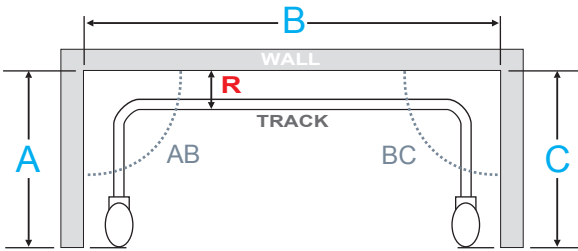

STYLE 2 MEASUREMENT

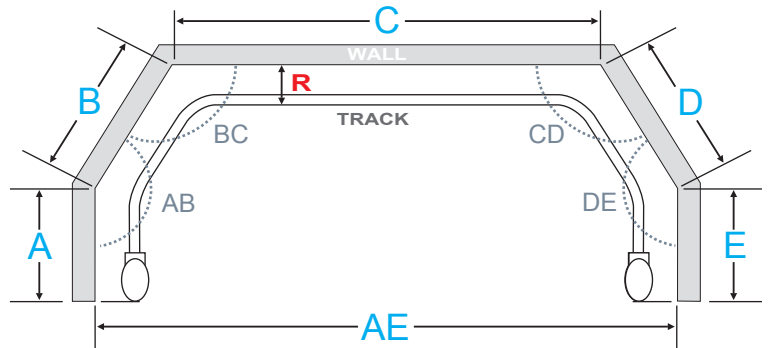

STYLE 3 MEASUREMENT

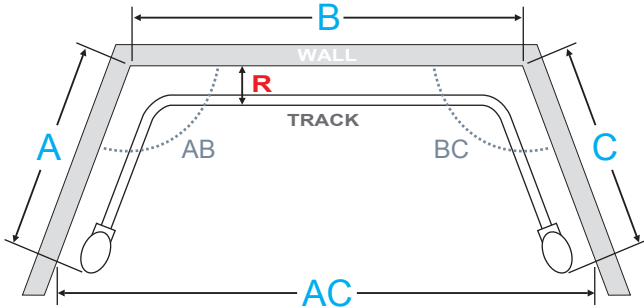

STYLE 4 MEASUREMENT

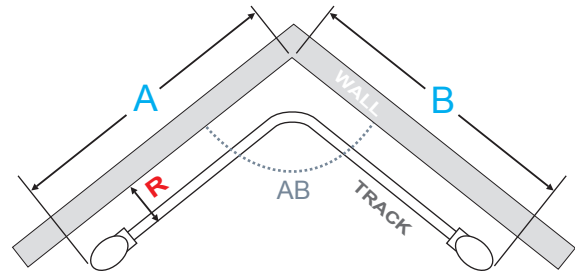

STYLE 5 MEASUREMENT *

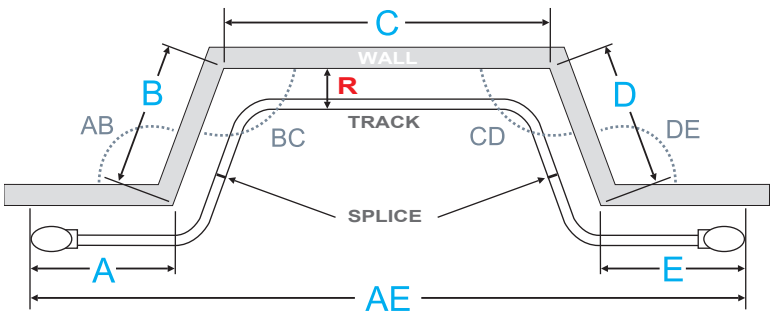

* Splices are required for this style.

TRACK 1

"R" Dimension _____
 Style _____ Degree of
 A _____ Bend
 B _____ AB _____
 C _____ BC _____
 D _____ CD _____
 E _____ DE _____
 AC _____
 AE _____

TRACK 2

"R" Dimension _____
 Style _____ Degree of
 A _____ Bend
 B _____ AB _____
 C _____ BC _____
 D _____ CD _____
 E _____ DE _____
 AC _____
 AE _____

NOTE: Irismo™ 45 WireFree RTS is not compatible with bends and curves.

Directions for Creating a Template for Drapery Curves

What you need: • Large piece of construction paper • Tape Measure • Marker • Tape

- 1** Start with a large piece of construction paper that exceeds the depth and length of the curve.
 - 2** Place the paper on the floor or ceiling depending on the orientation of the curve.
 - 3** Secure the paper with tape.
 - 4** Clearly define the stacking side, motor placement, pocket depth and center line of track with the marker.
 - 5** Mark the radius of the curve.
- Please call Somfy for specialty curving applications. Depending on your particular application, your project may require special attention.
- 6** Please provide as much detail as possible and all templates must include the following:
 - Indicate "room side"
 - Note how the template was created
 - Purchase order number
 - Template created on the floor facing up (See Figure 1) *preferred method*
 - Template created on the ceiling facing down (See Figure 2)
 - Customer name
 - Company name and account number
 - 7** Note the distance from the wall or the window to the center of the track.
NOTE: be sure to clear all possible obstructions such as handles, sills etc.
 - 8** Identify the following measurement points:
 - Placement of motor
 - Exact stopping point of track on template
 - Total measurement of curve (See Figure 4-"C")

FIGURE 1: TEMPLATE ON THE FLOOR FACING UP

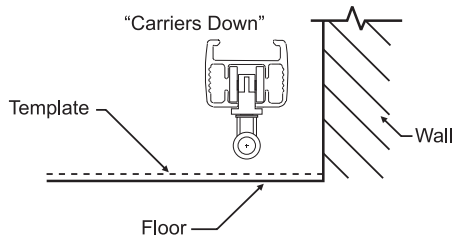

FIGURE 2: TEMPLATE ON CEILING FACING DOWN

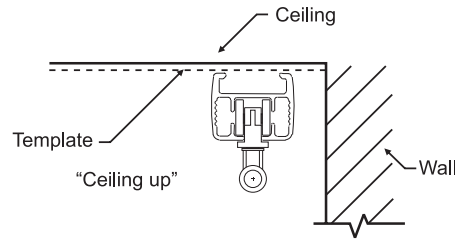

FIGURE 3: CRITICAL DIMENSIONS OF A CURVED TRACK

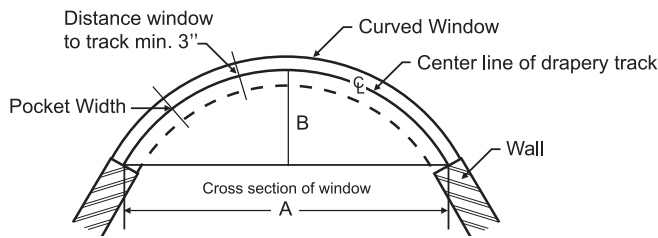
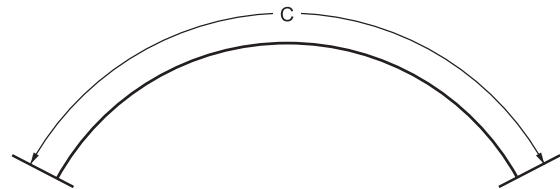

FIGURE 4: TOTAL MEASUREMENT OF CURVE



Template Submission Instructions

- Attach a copy of the purchase order to the template.
- Roll up template and place in a mailing tube.

DO NOT FOLD TEMPLATE

NOTE: When mailing, be sure to:

- Get a tracking number
- Include your return address
- Include your purchase order number on the label

Mail to:

Somfy Systems, Inc.
121 Herrod Blvd.
Dayton, NJ 08810
Attn: Drapery Department

Acceptable materials for making templates:

- Kraft Paper • Butcher Paper • Construction Paper

Somfy will not accept template made from the following materials:

- Newspaper • Plastic • Wax Paper • Fabric • Tissue Paper
- Roofing Paper • Existing Arch Shades • Wrapping Paper

NOTE: If the material used to make a template stretches, tears easily, will not lay flat or will mark the fabric - IT WILL NOT BE USED.

NOTE: Irisimo™ 45 WireFree RTS is not compatible with bends and curves.

Drapery Order Form

Date of Order: _____ Account # _____ P.O. # _____ Sidemark: _____

Special Shipping Directions: _____

SOLD TO:

Business Name: _____
 Address: _____
 City: _____ State: _____ Zip: _____
 Phone: _____ Fax #: _____
 Email: _____
 Ordered By: _____
 Signature: _____

SHIP TO:

Business Name: _____
 Address: _____
 City: _____ State: _____ Zip: _____
 Contact Name: _____
 Phone: _____ Fax #: _____
 Email: _____

ORDER DETAIL: Please see next page for glossary and definition of terms.

Item #	Room	QTY.	1	2	3	4	5	6	7	8	9	10		11	12
			Motor Part No.	Width (in.)	Tandem	Motor Side	*Track Type	Track Color	Stack (L/R/S)	**If Bent: # of bends	Carrier Type	Part #	QTY.	Butt Master	Splice
ex.	Living Room	1	1003152	144	Y/N	L	F	WHT/BRZ	S	2	RF80	1780907	7	NO	X
1															
2															
3															
4															
5															
6															

* For curved tracks, Somfy requires a template be provided. Please see [Directions for Creating a Template for Drapery Curves](#) for template information.

** For bent tracks, Somfy does not require a template. Please include the [Bent Drapery Tracks Measurement Form](#) for exact measurements per angle and return.

NOTE: Somfy includes a center splice every 16' of track. Please indicate in the "SPECIAL INSTRUCTIONS" section if your requirements differ from Somfy's standard.

CONTROLS: In the space provided below, please list the part number(s) for the control(s) you desire.

Given the nature of custom motorization products, control options and compatibility varies dramatically. If you would like further assistance with control options, simply note it in the field below and one of our customer service specialists will contact you upon the submission of your order.

SPECIAL INSTRUCTIONS

Please send to: e-mail: ordering_us@somfy.com Fax: 609-495-8117

(Continued on next page)

1	Motor	Part Number
	Glydea® ULTRA 35 Motor RTS with 10' Plug	1003152
	Glydea® ULTRA 35 Motor DCT with 10' Plug	1003151
	Glydea® ULTRA 60 Motor RTS with 10' Plug	1003159
	Glydea® ULTRA 60 Motor DCT with 10' Plug	1003158
	Glydea® ULTRA 35 Wired Motor with 10' Plug	1003153
	Glydea® ULTRA 60 Wired Motor with 10' Plug	1003160
	Irismo™ 35 (Mini DC) RTS	1003004
	Irismo™ 35 (Mini DC) DCT	1003003
	Irismo™ 45 WireFree RTS	1002353

2 Width (Inches)
 Motorized drapery tracks are custom built according to the specified width. Please note that the finished track width is measured pulley end to pulley end. For bent and curved tracks please provide the total of all wall measurements. When fabricating your drapery please add 1.5" to your return.

3 Tandem Y=Yes N=No
 Tandem motorized systems utilize two drapery motors. Items needed for tandem systems should be noted in the Special Instructions Section of the order form.
Tandem alternative = 2 one way tracks
Requires Glydea ULTRA DCT or IRISMO 35 DCT motors.

4 Motor Side
L=Left Side R=Right Side
 Choose the motor side best suited for your installation.

5 Track Type
A-I See below O=Other
 NOTE: Somfy requires a template for all curved tracks. Add an "S" after Track Type for Silent Master Carrier option (ie., "A-S"). Please see *Directions for Creating a Template for Drapery Curves* for necessary information.

A One way	D One way w/Bend R = 30 cm max (11.8")	G Center Opening w/2 Bends R = 30 cm max (11.8")
B Center Opening	E Center Opening w/Bend R = 30 cm max (11.8")	H One Way w/ Continuous Curve R = 300 cm max (118")
C Asymmetrical	F One way w/ 2Bends R = 30 cm max (11.8")	I Center Opening w/Continuous Curve R = 300 cm max (118")

6 Track Color - White or Bronze

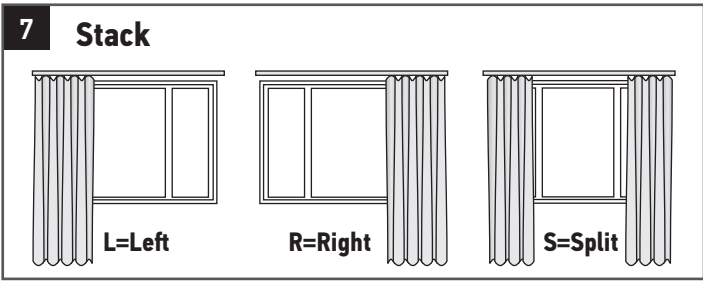

8 If Bent: # of Bends
1=1 Bend, 2=2 Bends, 3=3 Bends, etc
 NOTE: Somfy requires exact angle measurements for all bent tracks. Please submit completed and signed **Bent Drapery Track Measurement Form** with all bent track orders.

9 Carrier/Runner Type
1=1 Bend, 2=2 Bends, 3=3 Bends, etc
 SPP=Silent Pinch Pleat (QTY of 3 per foot included)
 PP=Pinch Pleat (QTY of 3 per foot included)
 RF80 = RippleFold® 80% fullness (QTY of 5 per foot spaced every 2 3/8" included)
 RF100 = RippleFold® 100% fullness (QTY of 6 per foot spaced every 2 1/8" included)
 RF120 = RippleFold® 120% fullness (QTY of 7 per foot spaced every 1 7/8" included)

10 Brackets
 NOTE: Brackets are not included and must be ordered separately.

Part Numbers	White	Bronze
One Touch Ceiling Bracket (not recommended for curved tracks).....	# 1780907	# 1782865
4.5"-6" Wall Mount Bracket.....	# 1782054	# 9025621
8.75"-10.25" Double Wall Mount Bracket.....	# 1782053	# 9025622
Swivel Ceiling Bracket (strongly recommended for curved tracks)....	# 1780906	# 1782864

Somfy recommends one (1) bracket by each pulley and one (1) bracket every 24". Additionally, one (1) bracket should be placed on each side of a splice if used.

11 Butt Master
Y=Yes N=No
 Only available for RippleFold® center opening systems. Quantity 2 required; please note item numbers in **Special Instructions Section** of the order form item #1780953.

12 Splice
X=Special splice instructions
 Somfy includes a center splice every 16ft of track. Please indicate in the Special Instructions Section if your requirements differ from Somfy's standard.

DECOFLEX RTS, SDN & DRY CONTACT

Button Engraving Order Form

Customer Name: _____ Customer #: _____

SHIPPING

Shipping Information

Ship to: Default Shipping Address Drop Ship

Name: _____

Address: _____

City: _____ State: _____ Zip: _____

Phone: _____

Project Information

Project Name: _____

Installer Name/Company: _____

P/O #: _____ Order #: _____

Area: _____

Room: _____

STYLE

Button Color

WHITE
#9018259

IVORY
#9018260

BLACK
#9018261

Switch Type

RTS

Somfy Digital Network (SDN) RS485

Dry Contact

Available in White only

ENGRAVING OPTIONS

Buttons (A-F) 9 Characters Maximum (including spaces)	QTY.
A	
B	
C	
D	
E	
F	
G	
H	

NOTE:

***(F):** Command Button by default is labeled STOP on the DecoFlex Range of keypads.

G and **H** buttons by default are labeled as follows:

(G = down ▽ icon) WHITE - #9018263 IVORY - #9018264 BLACK - #9018265

(H = up ▲ icon): WHITE - #9018267 IVORY - #9018268 BLACK - #9018269

If you prefer they can be substituted with an associated command

NAME (UP, DOWN, LOWER, etc.) up to 5 characters.

DecoFlex RTS

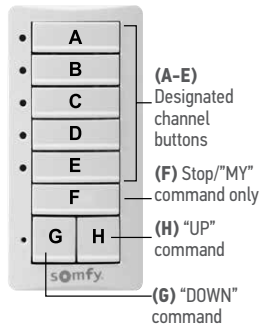

DecoFlex SDN (Standalone or Group)

(A-H) Programmable buttons for individual or groups of SDN RS485 motors

NOTE: Pre-labeled with STOP, up and down arrows

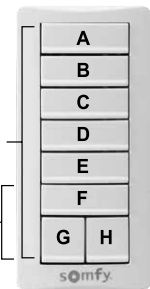

DecoFlex Dry Contact

(A-C) Programmable intermediate position buttons

(F) Stop/'MY' command only

(G) "DOWN" command

(H) "UP" command

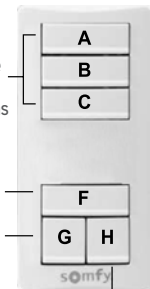

Engraving Options - Default option will be used if nothing is selected.

Character Types: (choose one)

ALL LETTERS CAPITALIZED (Default)

First Letters Capitalized

As written in above section

Payment terms of your account will apply.

All engraved switches are custom made and are non-cancellable.

Please send form to: Fax # 609-495-8117 or e-mail to: Ordering_us@somfy.com

SOMFY SYSTEMS INC
121 Herrod Blvd.
Dayton, NJ 08810
Phone: (800) 22-SOMFY
NJ: (609) 395-1300
Fax: (609) 495-8118
somfysystems.com

Florida
1200 SW 35th Ave.
Boynton Beach, FL 33426
Phone: (877) 227-6639
Fax: (561) 995-7502

California
15301 Barranca Parkway
Irvine, CA 92618-2201
Phone: (877) 727-6639
Fax: (949) 727-3775

SOMFY ULC
SOMFY Canada Division
5178 Everest Drive
Mississauga, Ontario L4W2R4
CN: (905) 564-6446
Fax: (905) 238-1491

© Copyright Somfy Systems, Inc. 5/2020

P-0013

SOMFY® is the leading global manufacturer of strong, quiet motors with electronic and app controls for interior window coverings and exterior solar protections. Over 270 million users worldwide enjoy the more than 170 million motors produced by Somfy. During the past 50 years, Somfy engineers have designed products for both the commercial and residential markets to motorize window coverings such as interior shades, wood blinds, draperies, awnings, rolling shutters, exterior solar screens and projection screens. Somfy motorization systems are easily integrated with security, HVAC and lighting systems providing total home or building automation.

SOMFY SYSTEMS INC
SOMFY NORTH AMERICAN HEADQUARTERS

121 Herrod Blvd.
Dayton, NJ 08810
T: (800) 22-SOMFY (76639)
NJ: (609) 395-1300
F: (609) 395-1776

FLORIDA

1200 SW 35th Ave.
Boynton Beach, FL 33426
T: (800) 22-SOMFY (76639)
F: (561) 995-7502

CALIFORNIA

15301 Barranca Parkway
Irvine, CA 92618-2201
T: (800) 22-SOMFY (76639)
F: (949) 727-3775

SOMFY ULC

SOMFY Canada Division

5178 Everest Drive
Mississauga, Ontario L4W2R4
T: 1-800-66-SOMFY (76639)
CN: (905) 564-6446
F: (905) 238-1491

www.somfypro.com

A BRAND OF **SOMFY** GROUP

© Copyright Somfy Systems, Inc. 6/2020
Images: © SAS/Childeric