



CLOSET LOGIC+

STORAGE SOLUTIONS

# SYS 1 | 2 TEM 3 | 4

A VISUAL ORGANIZING SYSTEM.  
SYSTEM 1234 IS A MODERN AESTHETIC CENTERED ON VERSATILE COMPOSITIONS THAT EXPRESS ORDERLY STORAGE IN YOUR HOME.



# CONTENTS

DIFFERENT SPACES .....	4
PLANNING .....	6
DESIGN .....	7
COMPONENTS .....	8
WARDROBE RAILS .....	10
SHELVING .....	11
DRAWER STORAGE .....	12
ACCESSORIES .....	13
ISLAND SPACES .....	14
SELECTIONS .....	16

# DIFFERENT SPACES

1234 IS AN ORGANIZING SYSTEM THAT'S FUNCTIONAL IN SMALL SPACES AND LARGE EMPHASIZING ITS ROLE OF UNIVERSAL APPLICATION. THE DESIGN RANGE MAXIMIZES STORAGE UTILITY BY CAPTURING ALL OF THE AVAILABLE SPACE WHILE PRESERVING FLEXIBILITY TO READILY ADJUST OVER THE COURSE OF TIME. 1234 REPRESENTS A VERY FUNCTIONAL CHOICE.

1234 IS DEVELOPED TO MEET THE NEED FOR DURABLE CLOSET PRODUCTS ENGINEERED FOR GREATER WEIGHT CAPACITY, YET AFFORDABLE PRICING. STORAGE VERSATILITY, VISIBILITY AND RETRIEVAL HAVE NEVER BEEN EASIER IN A CLOSET SYSTEM.

SIMPLY 1234

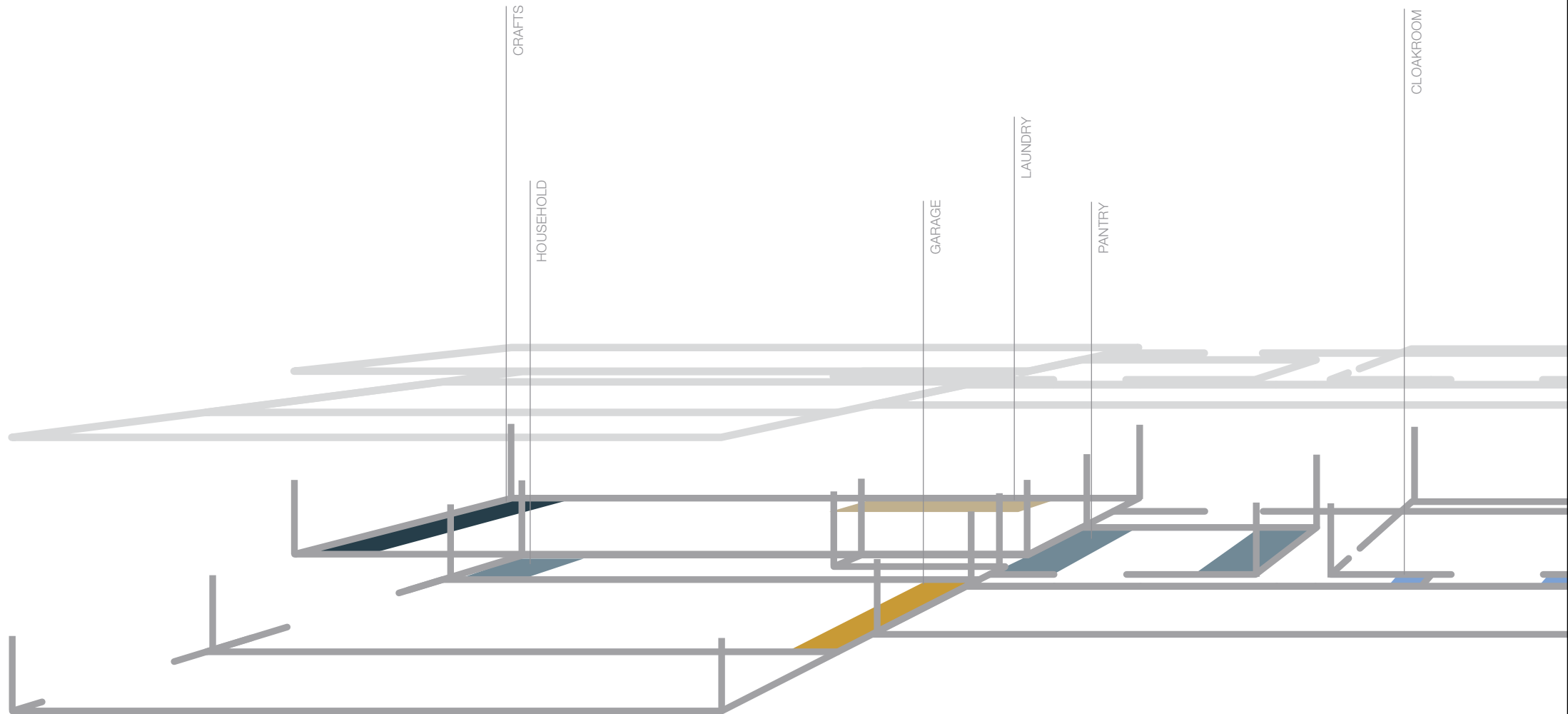

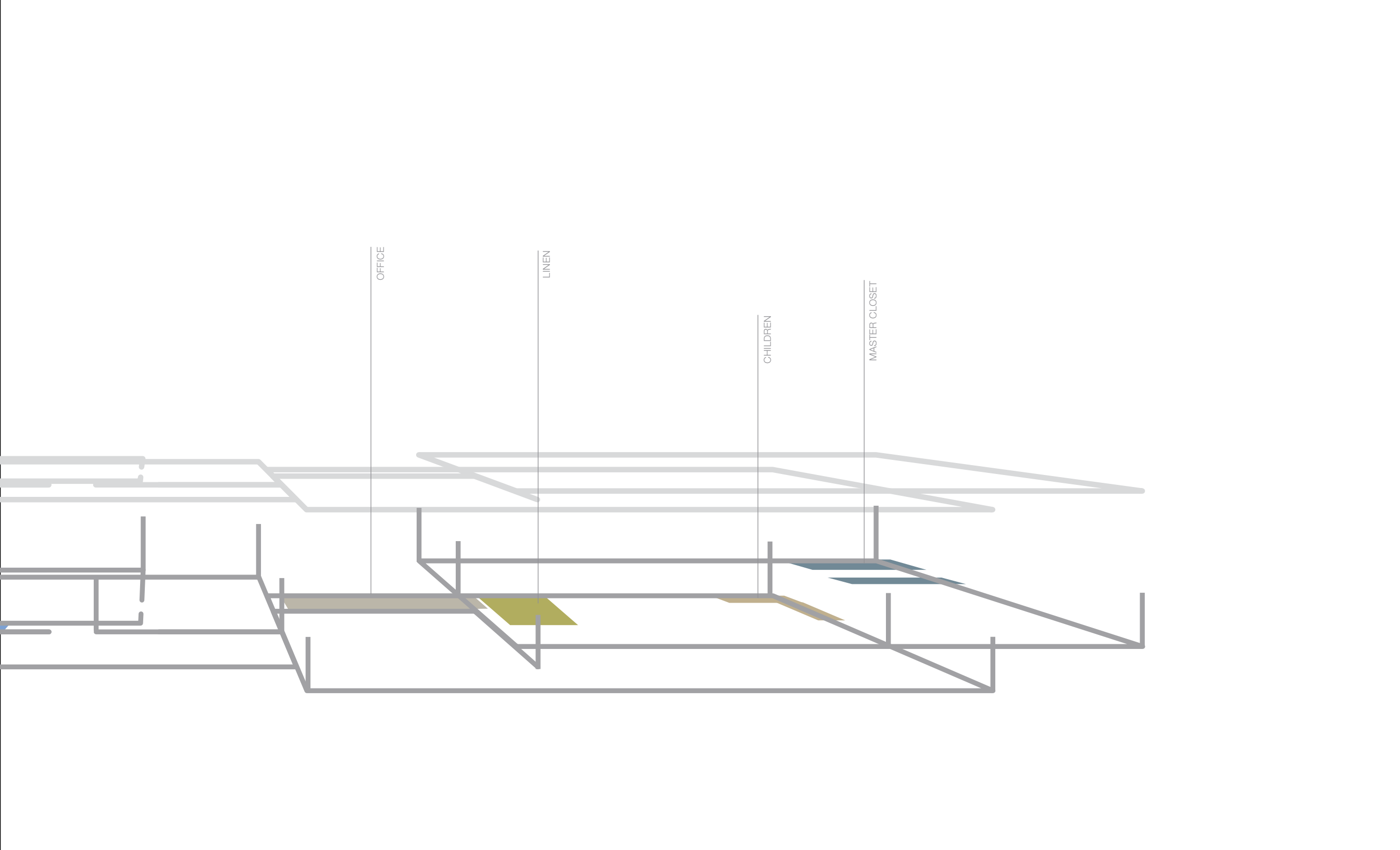

OFFICE

LINEN

CHILDREN

MASTER CLOSET

# SP

SORT  
 PURGE  
 ASSIGN  
 CLUSTER  
 EQUALIZE

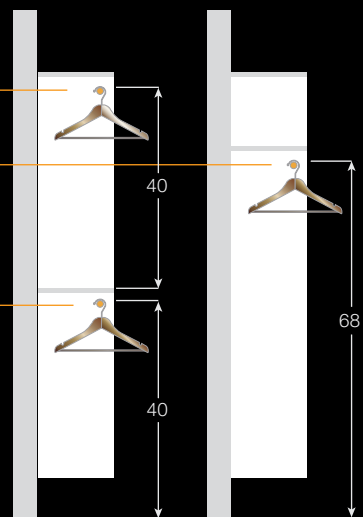
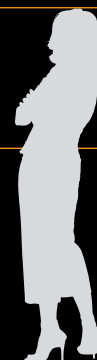

ITEM	WIDTH	LENGTH
FIVE MEN'S SUIT COATS	12"	38"
SIX MEN'S SHIRTS (ON HANGERS)	12"	38"
MAN'S SHIRT (FOLDED)	8"	14"
MAN'S PANTS (ON STRAIGHT HANGERS)		44"
MAN'S PANTS (FOLDED ON HANGERS)		27"
MAN'S DRESS HAT:	6"	11"
MAN'S SHOES	9"	12"

ITEM	WIDTH	LENGTH
WOMAN'S DRESS		68"
WOMAN'S ROBE		52"
WOMAN'S DRESS		50"
WOMAN'S JACKET		36"
WOMAN'S BLOUSE (ON HANGER)		34"
WOMAN'S BLOUSE (FOLDED)	10"	13"
WOMAN'S SKIRT		36"
WOMAN'S SHOES	6"	9-1/2"
SWEATER (FOLDED)	10"	14"
BOOTS	9"	12"

## PLANNING

# 1234 DESIGN

1234 IS A MODERN AESTHETIC, ELEGANT, AND STRAIGHT FORWARD. 1234 MINIMALISM PROVIDES A CLEAN WAY TO ORGANIZE WITH FORM AND STRUCTURE.

COMPONENTS ARE ASSIGNED AND POSITIONED AND THE ALIGNMENTS WITHIN THE COMPOSITION EXPRESS INTERNAL COHERENCE AND SENSE OF ORDER. THE FORMS CREATE VISUAL COHERENCE THROUGH VISUAL STRUCTURE.

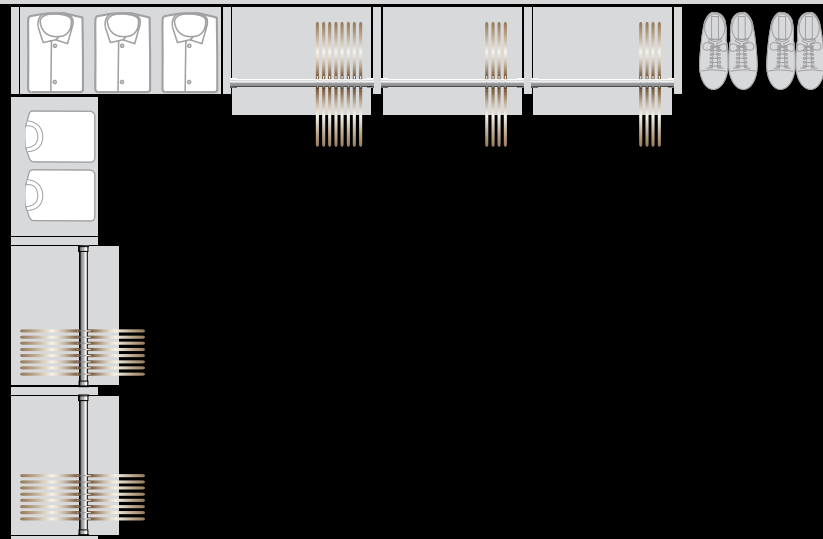

DRAWERS

# ACE

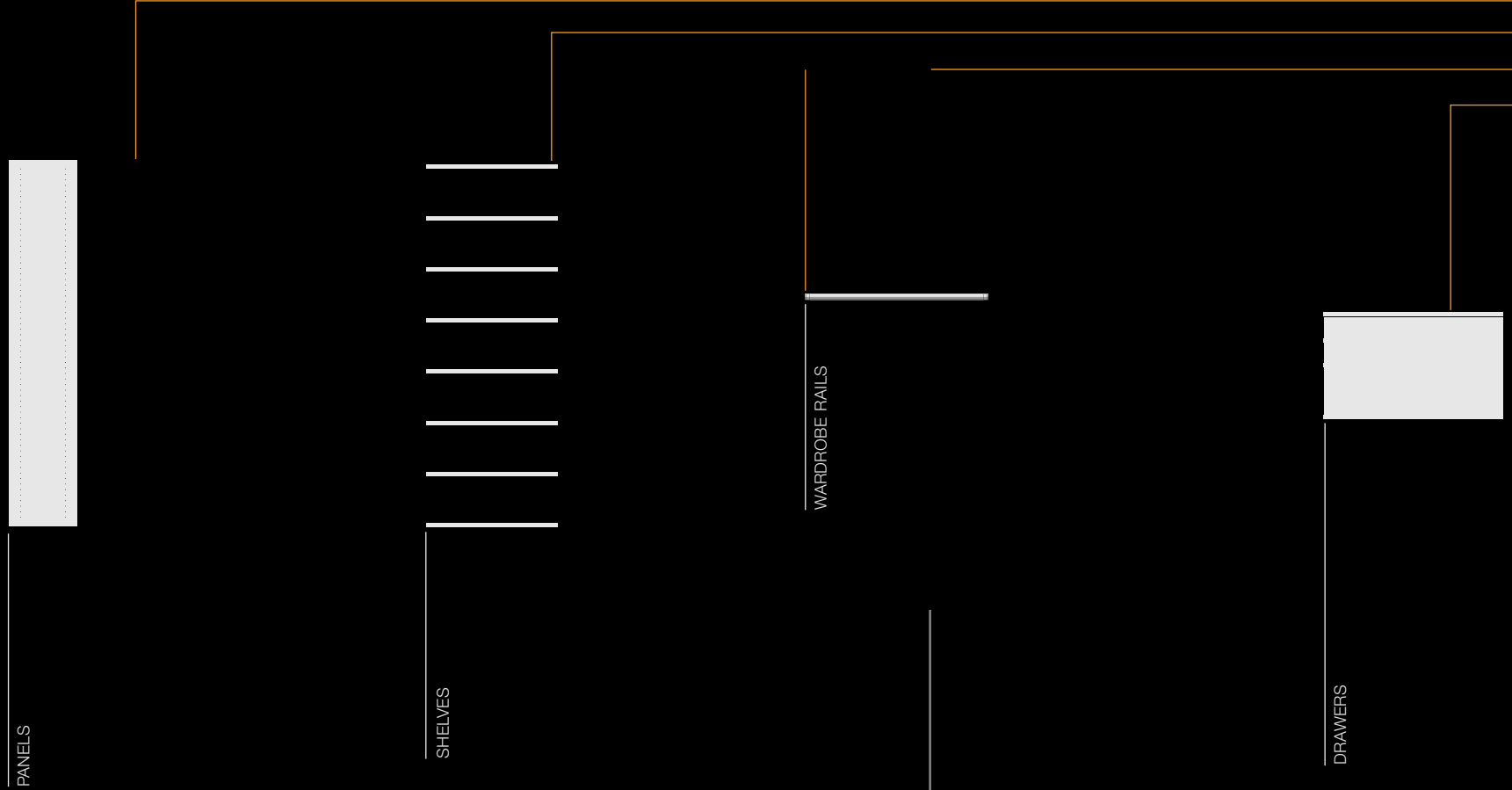

# SYSTEM 1234



## 1234 COMPONENTS

1234 INCLUDES FOUR BASIC ELEMENTS - SUSPENSION PANELS, DRAWERS, SHELVES, AND WARDROBE RAILS - TO ASSIGN, ARRANGE, AND COMPOSE A STORAGE SOLUTION. SUSPENSION PANELS ARE 76" HIGH TO CAPTURE THE MOST AVAILABLE STORAGE SPACE AND FIFTEEN STANDARD LEVELS ARE AVAILABLE FOR IMPROVED CONTROL OF STORAGE.

TWO OR MORE SUSPENSION PANELS CREATE STORAGE COLUMNS. COLUMNS CAN INCLUDE ONE OR MULTIPLE COMPONENT TYPES FOR MULTIPLE OPTIONS. ACCESSORIES ARE ADDED AND EXTEND THE FUNCTIONAL RANGE OF THE PRODUCT LINE.

# CREATE ATE



# H A

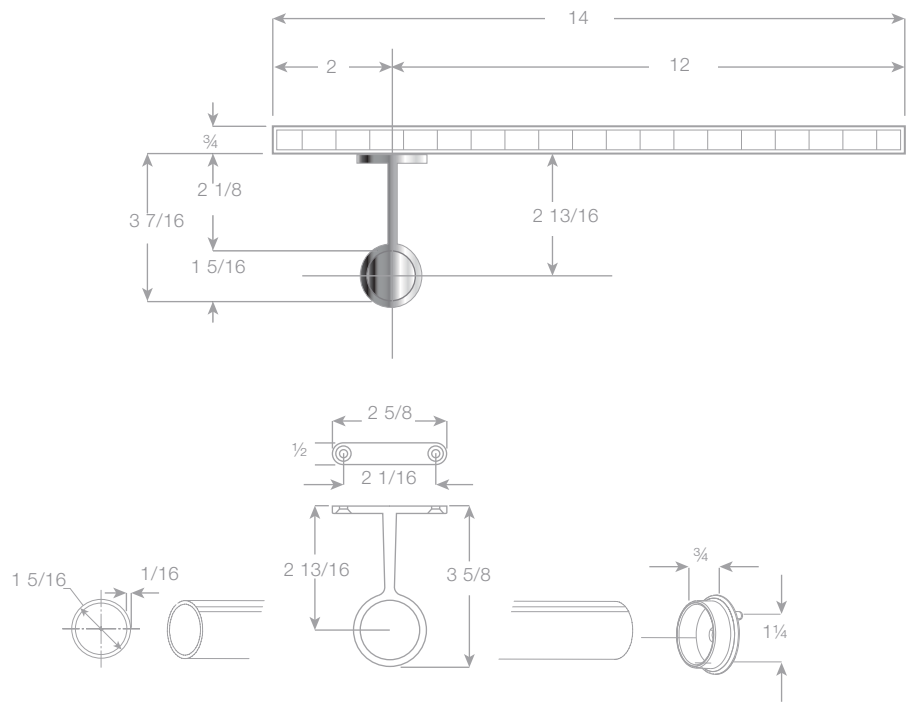

CUSTOM WIDTHS

# N G

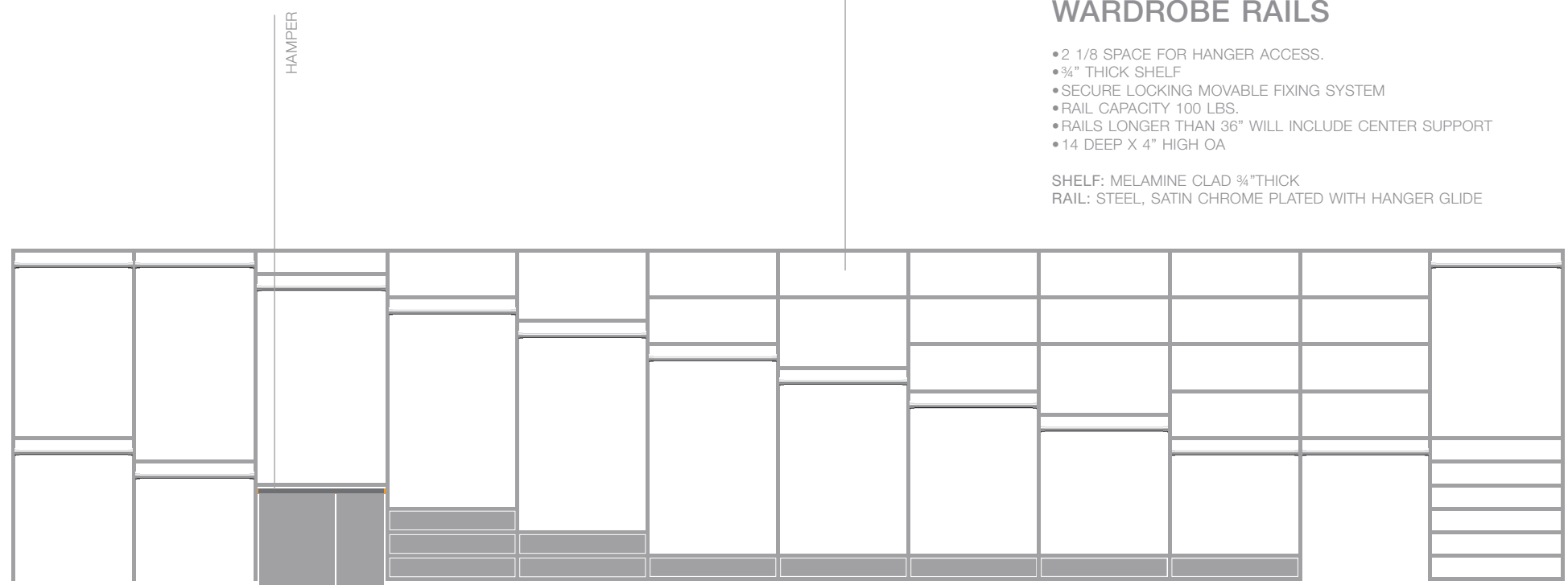

## WARDROBE RAILS

- 2 1/8" SPACE FOR HANGER ACCESS.
- 3/4" THICK SHELF
- SECURE LOCKING MOVABLE FIXING SYSTEM
- RAIL CAPACITY 100 LBS.
- RAILS LONGER THAN 36" WILL INCLUDE CENTER SUPPORT
- 14" DEEP X 4" HIGH OA

SHELF: MELAMINE CLAD 3/4" THICK  
 RAIL: STEEL, SATIN CHROME PLATED WITH HANGER GLIDE

# SORT

CUSTOM WIDTHS

30", 200 TIES, 60 SCARVES OR 60 BELTS

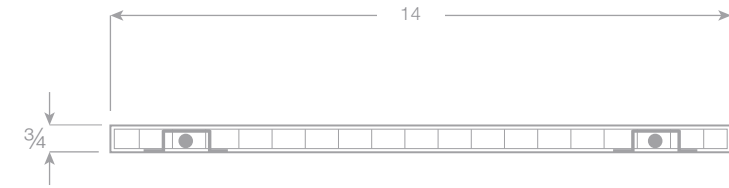

# FOLD



30", 45 PAIR OF SHOES

8 STANDARD LEVELS

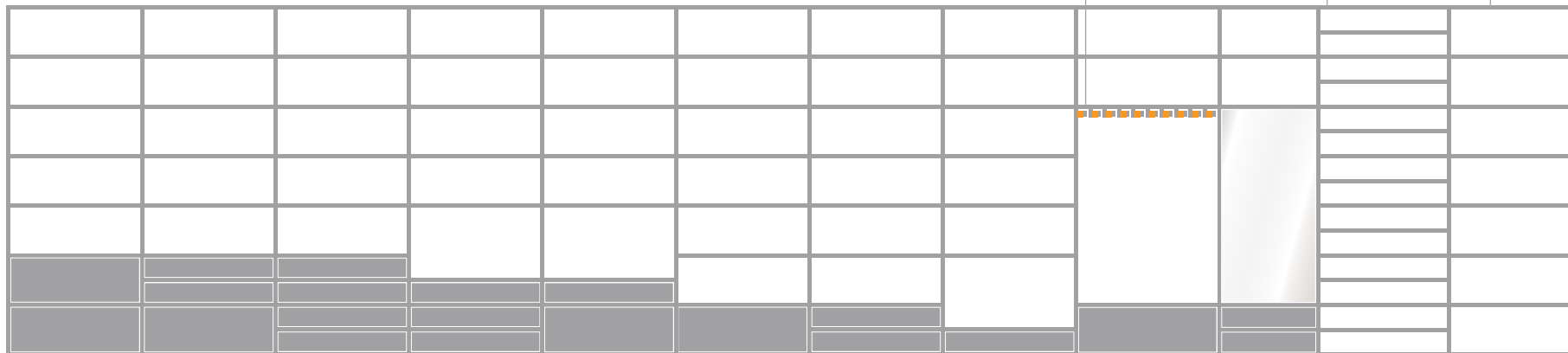

10 2

## SHELVING

14 DEEP  
FIXED IN PLACE WITH LOCKING MECHANISM  
SHELF: MELAMINE CLAD 3/4" THICK

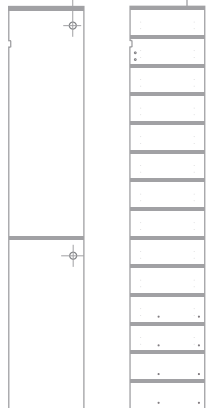

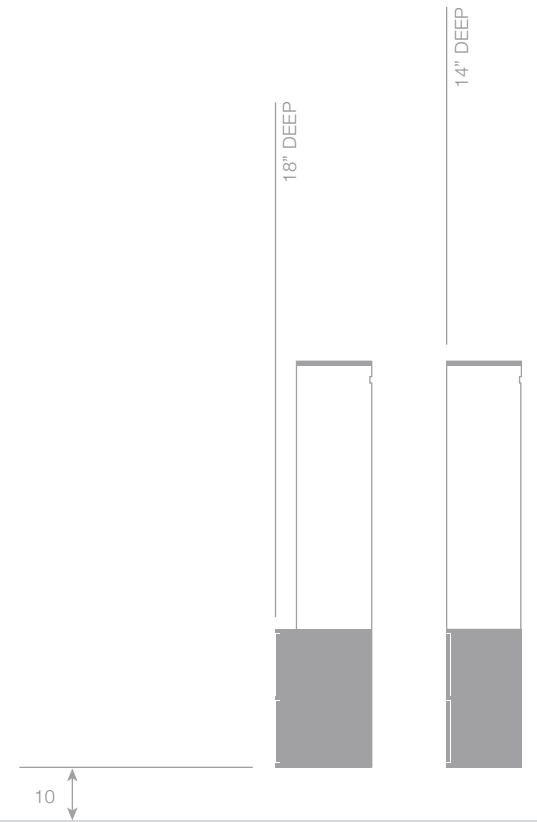
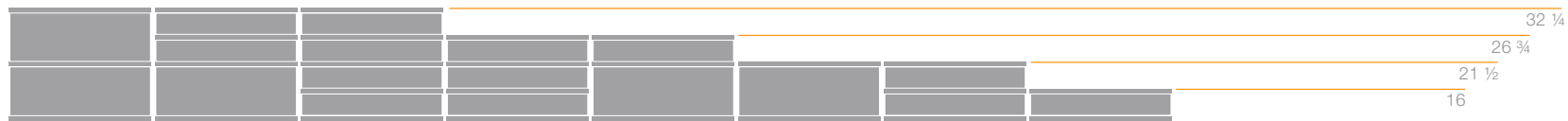

## DRAWER UNITS

DRAWERS ARE AVAILABLE IN 4 AND 8 INCH STORAGE DEPTHS AND IN ANY WIDTH UP TO 42 INCHES. AESTHETIC ALIGNMENT WITH ADJOINING DRAWER UNITS AND SHELVES IS ASSURED. ALL SAME SIZE DRAWERS ARE INTERCHANGEABLE.

PACK

# ACCESSORIES



BELTS



VALET



TIES



SHOE RAIL



SCARVES



HAMPERS



## BELT

6 HOOK LENGTH, 14 1/8"  
 DIMENSIONS (W X H): 2 3/16" X 1 11/16"  
 FINISH/COLOR, POLISHED CHROME



## TIE RACK

20 HOOK LENGTH, 14 1/8"  
 DIMENSIONS (W X H), 2 3/16" X 1 11/16"  
 FINISH/COLOR, POLISHED CHROME



## SCARF

• 6 HOOKS, 14 1/8"  
 • 3/4" EXTENSION SLIDE  
 DIMENSIONS (W X H), 2 3/8" X 1 11/16"  
 FINISH/COLOR, POLISHED CHROME



## VALET

• FOR CLOTHES HANGERS AND HANGING GARMENT BAGS  
 LENGTH: 14 1/4"  
 DIMENSIONS (W X H): 1 1/16" X 1 7/8"  
 FINISH/COLOR, POLISHED CHROME



## SHOE

LENGTH  
 • 10 15/16"  
 • 17"  
 • 23"  
 • 29"

## HAMPER

WIDTH	# OF BAGS	BAG SIZE
18"	1	1 LARGE
24"	2	2 SMALL
30"	2	1 LARGE, 1 SMALL

• FULL EXTENSION SLIDES AND REMOVABLE BAGS  
 • BUILT-IN HANDLES MAKE IT EASY TO REMOVE THE BAGS  
 DIMENSIONS (D X H), 14" X 21 1/2"  
 FINISH/COLOR, POLISHED CHROME

33 1/2

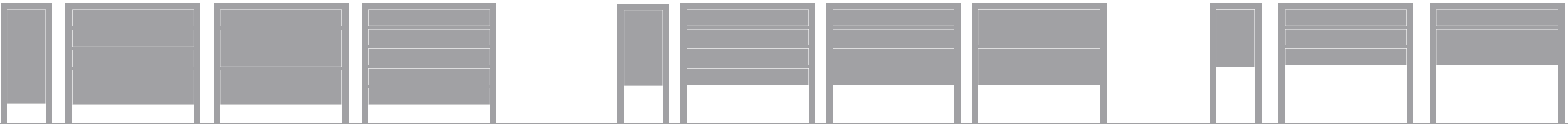

LAYOUT	HEIGHT	DEPTH			
		14	18	21	24
LAYOUT	33 1/2	14	18	21	24
SEATING	28 1/8		18	21	24
PACKING	22 3/8		18	21	24
BENCH	17		18	21	24

PACK



ISLANDS

ISLAND DRESSERS



# STAND

SEPARATES OR UNITIZED

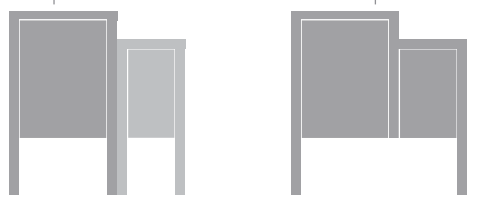

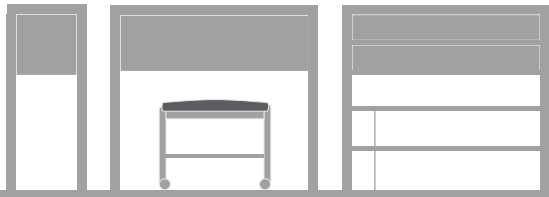

28 1/8

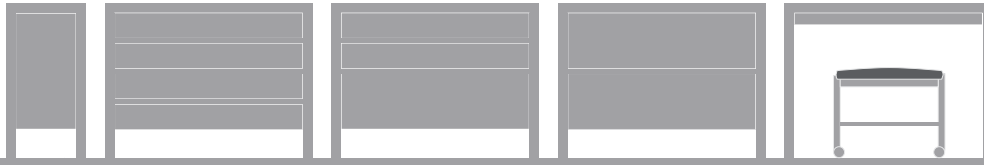

27 3/4



4 DEPTHS  
24  
21  
18  
14

ADJUSTABLE SHELVES

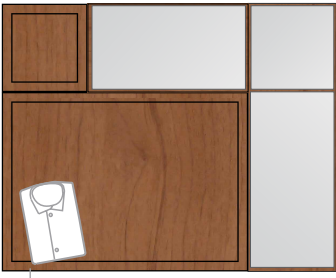
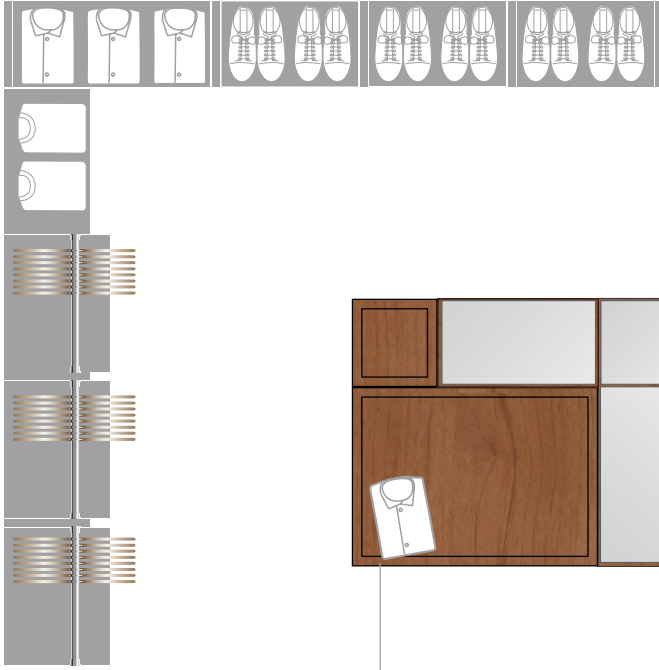

MARBLE  
LEATHER  
LAMINATE  
WOOD

INSERT WORKTOPS

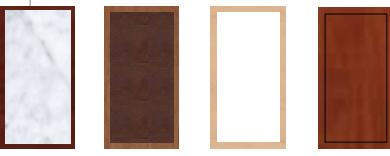

BENCH

17

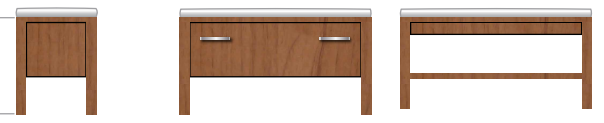

WORKTOP SEATING

# SIT

# SELECTIONS

## BENCH CUSHIONS



- SEAT CUSHION
- RECTANGLE: SQUARE CORNERS
  - EDGE: BOXED
  - THICKNESS: 3"

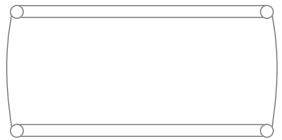

## WORKTOP INSERTS: MARBLE



## WORKTOP INSERTS: LEATHER





HARDWARE

---

BP195026 KNOB



BP5301626 KNOB



BP2701726 PULL



PANEL FINISHES: WOOD

---

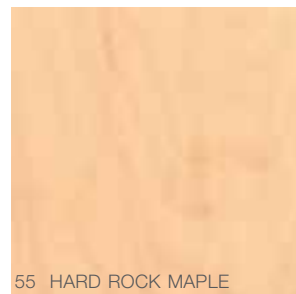

55 HARD ROCK MAPLE

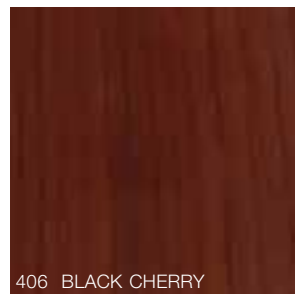

406 BLACK CHERRY

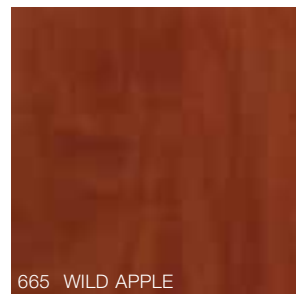

665 WILD APPLE

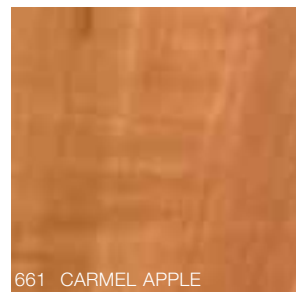

661 CARMEL APPLE



404 MAHOGANY IMPRESSIONS

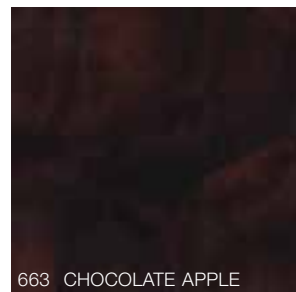

663 CHOCOLATE APPLE

PANEL FINISHES: SOLID COLOR

---

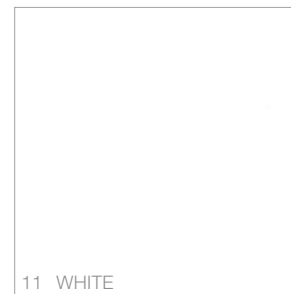

11 WHITE



14 ANTIQUE WHITE



16 ALMOND



108 FOLKSTONE

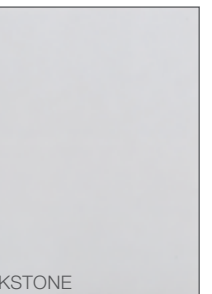

108 FOLKSTONE



06 BLACK

JOLIET CABINET  
www.jolietcabinet.com

Sales  
Design  
Manufacturing  
Service

405 W. Caton Farm Road  
Lockport, Illinois 60441  
Telephone 815.727.4096





