



61B850P

**PARTS
MANUAL**



52" MID-CUT SECTION

52" MID-CUT DECK ASSEMBLY

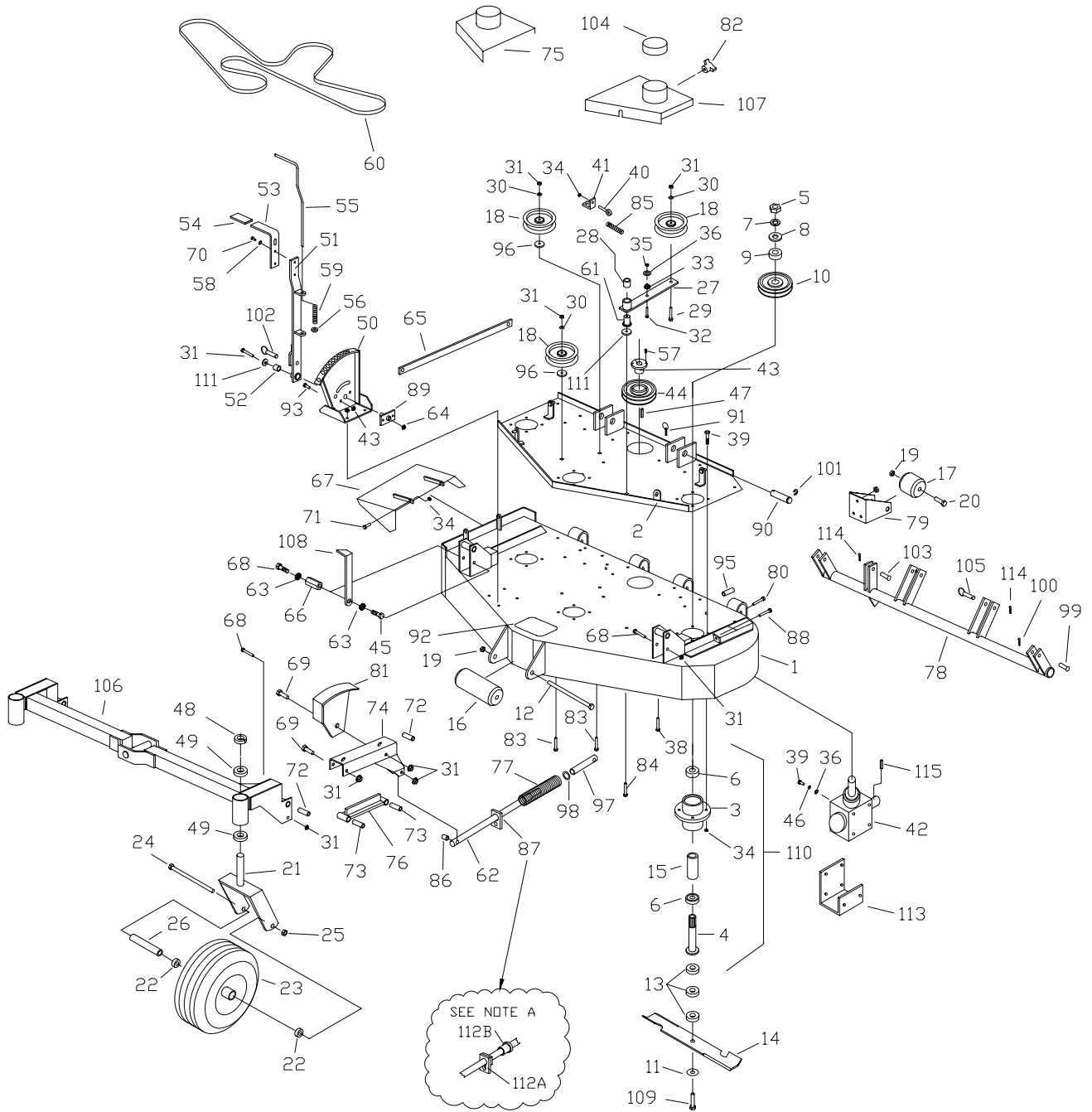

52" Mid-Cut Deck Assembly

#	PART NO.	QTY	DESCRIPTION
1	582139	1	DECK WELDMENT 52 MC
2	582020	1	52" SUB-PLATE WELDMENT
3	583111	3	SPINDLE HOUSING
4	583112	3	SPINDLE SHAFT
5	104511	3	3/4"-16 HEX NUT
6	363350	6	BEARING - BLADE SPINDLE
7	105010	3	3/4" LOCK WASHER
8	105269	3	3/4" SAE FLAT WASHER
9	583110	3	PULLEY SPACER
10	583107	3	PULLEY - SPINDLE 5 3/4"
11	583108	3	5/8" SPRING DISC WASHER
12	100351	1	5/8"-11 X 8 1/2" HEX BOLT
13	583109	9	BLADE SPACER
14	823004	3	18" HI LIFT BLADE
15	583113	3	BEARING SPACER TUBE
16	603023	1	ANTI-SCALP ROLLER
17	523084	2	REAR DECK ROLLER
18	523329	3	FLOATING IDLER - FLAT
19	104261	3	5/8"-11 NYLOC NUT
20	100346	2	5/8"-11 X 4 1/2" HEX BOLT
21	822088	2	WIDE WHEEL YOKE
22	363187	4	1" FLANGE BEARING
23	823220	2	WIDE TAIL TIRE (COMPLETE)
23A	823339	X	TIRE (13 X 6.5 X 6)
23B	823338	X	FRONT RIM W/ VALVESTEM
24	100352	2	5/8"-11 X 9" HEX BOLT
25	104261	2	5/8"-11 NYLOC NUT
26	823245	2	AXLE TUBE <WTW>
27	822144	1	DECK IDLER ARM W/BUSHING
28	363007	1	3/4 FLANGE BUSHING
29	107511	1	3/8"-16 X 2" CARRIAGE BOLT
30	105260	8	3/8" FLAT WASHER
31	104257	16	3/8"-16 NYLOC NUT
32	100275	1	5/16"-18 X 1 1/2" HEX BOLT
33	109001	2	5/16"-18 WHIZLOCK NUT
34	104256	36	5/16"-18 NYLOC NUT
35	109007	2	3/8"-16 WHIZLOCK NUT
36	105258	9	5/16" FLAT WASHER
37	107503	10	5/16"-18 X 3/4" CARRIAGE BOLT
38	107509	5	5/16"-18 X 1" CARRIAGE BOLT
39	100274	12	5/16"-18 X 1 1/4" HEX BOLT
40	363080	1	EYEBOLT - RIGHT
41	523094	1	SPRING MOUNT - DECK
42	583087	1	DECK GEAR BOLX
43	523371	1	3/4" TAPER BUSHING
44	363216	1	TAPER LOCK SHEAVE
45	100291	1	3/8"-16 X 3/4" HEX BOLT
46	105005	4	5/16" LOCK WASHER
47	107255	1	3/16" X 1" KEY
48	363145	2	1" CLAMP COLLAR

52" Mid-Cut Deck Assembly

#	PART NO.	QTY	DESCRIPTION
49	363187	2	1" FLANGE BEARING
50	582021	1	HEIGHT ADJUSTMENT BRACKET
51	822141	1	DECK HEIGHT BAR W/BUSHING
52	253059	1	ENGAGEMENT BUSHING
53	822062	1	DECK HEIGHT HANDLE W/GRIP
54	823312	1	GRIP
55	823149	1	HANDLE ROD
56	823093	1	3/8" CLAMP COLLAR
57	100252	6	1/4"-20 X 3/4" HEX BOLT
58	105004	2	1/4" LOCK WASHER
59	523028	1	ASSIST SPRING
60	823243	1	52" FC DECK BELT
61	423175	1	PUMP IDLER PIVOT
62	823155	2	CASTER ROD
63	105006	2	3/8" LOCK WASHER
64	100297	1	3/8"-16 X 2 1/4" HEX BOLT
65	582128	1	LIFT BAR WELDMENT 52 MC
66	583422	1	NUT-CUT GAGE
67	482017	1	GRASS DEFLECTOR
68	100300	4	3/8"-16 X 3" HEX BOLT
69	100301	4	3/8"-16 X 3 1/4" HEX BOLT
70	100251	2	1/4"-20 X 5/8" HEX BOLT
71	100273	2	5/16"-18 X 1" HEX BOLT
72	823330	4	CASTER ARM PIVOT
73	823090	4	CASTER BAR PIVOT
74A	582053	1	LEFT HAND CASTER ARM
74B	582051	1	RIGHT HAND CASTER ARM
75	582141	1	BELT SHIELD 52 MC RIGH HAND
76	582059	2	CASTER BAR WELDMENT
77	823150	2	COMPRESSION SPRING
78	822040	1	DECK TUBE WELDMENT
79	583074	2	ROLLER MOUNT
80	100298	2	3/8"-16 X 2 1/2" HEX BOLT
81	582176	1	CUT GAGE WELDMENT
82	753028	4	KNOB
83	107516	2	3/8"-16 X 2 1/4" CARRIAGE BOLT
84	107513	3	3/8"-16 X 3" CARRIAGE BOLT
85	593074	1	IDLER SPRING
86	823153	2	CASTER ROD SPACER
87	823159	2	SPRING SLIDE (SEE NOTE A)
88	100030	2	3/8"-16 X 3" TAP BOLT
89	822132	1	DECK HEIGHT PIVOT
90	823333	2	DECK ATTACH PIN
91	108001	3	3/16" QUICK PIN
92	823200	1	STEP TREAD
93	107502	2	1/4"-20 X 3/4" CARRIAGE BOLT
94	104255	2	1/4"-20 NYLOC NUT
95	823314	2	TUBE SADDLE SPACER
96	483017	2	RIGHT HAND IDLER SPACER

52" Mid-Cut Deck Assembly

#	PART NO.	QTY	DESCRIPTION
97	823157	2	CASTER ROD END
98	105260	2	5/8" HEAVY WASHER
99	823210	2	1/2" X 2" CLEVIS PIN
100	106763	2	1/8" COTTER PIN
101	108510	4	7/8" E-RING
102	109026	1	1/2" X 2" DETENT PIN
103	823209	1	1/2" X 1 1/2" CLEVIS PIN
104	363161	2	BELT COVER CAP
105	823211	2	1/2" X 2 1/2" RING PIN
106	582136	1	FRONT AXLE 52 MC
107	582143	1	BELT SHIELD 52 MC LEFT HAND
108	583420	1	POINTER CUT GAGE
109	100358	3	5/8"-11 x 2 1/4" HEX BOLT
110	583106	3	BLADE SPINDLE ASSY
111	373089	1	3/8" RETAINING WASHER
112A	592006	1	SPRING RETAINER
112B	363007	1	FLANGE BUSHING
113	593096	1	GEAR BOX TRUSS
114	106778	2	3/16 X 1 1/2" COTTLER PIN
115	107255	1	KEY - 3/16" X 1"

NOTES:

- A PREFORMANCE UPGRADE FOR DECK SPRING ASSY. REQUIRES ITEM 112.
BOTH SIDES NEED BE UPGRADED AT THE SAME TIME.

52" Mid-Cut Mainframe Assembly

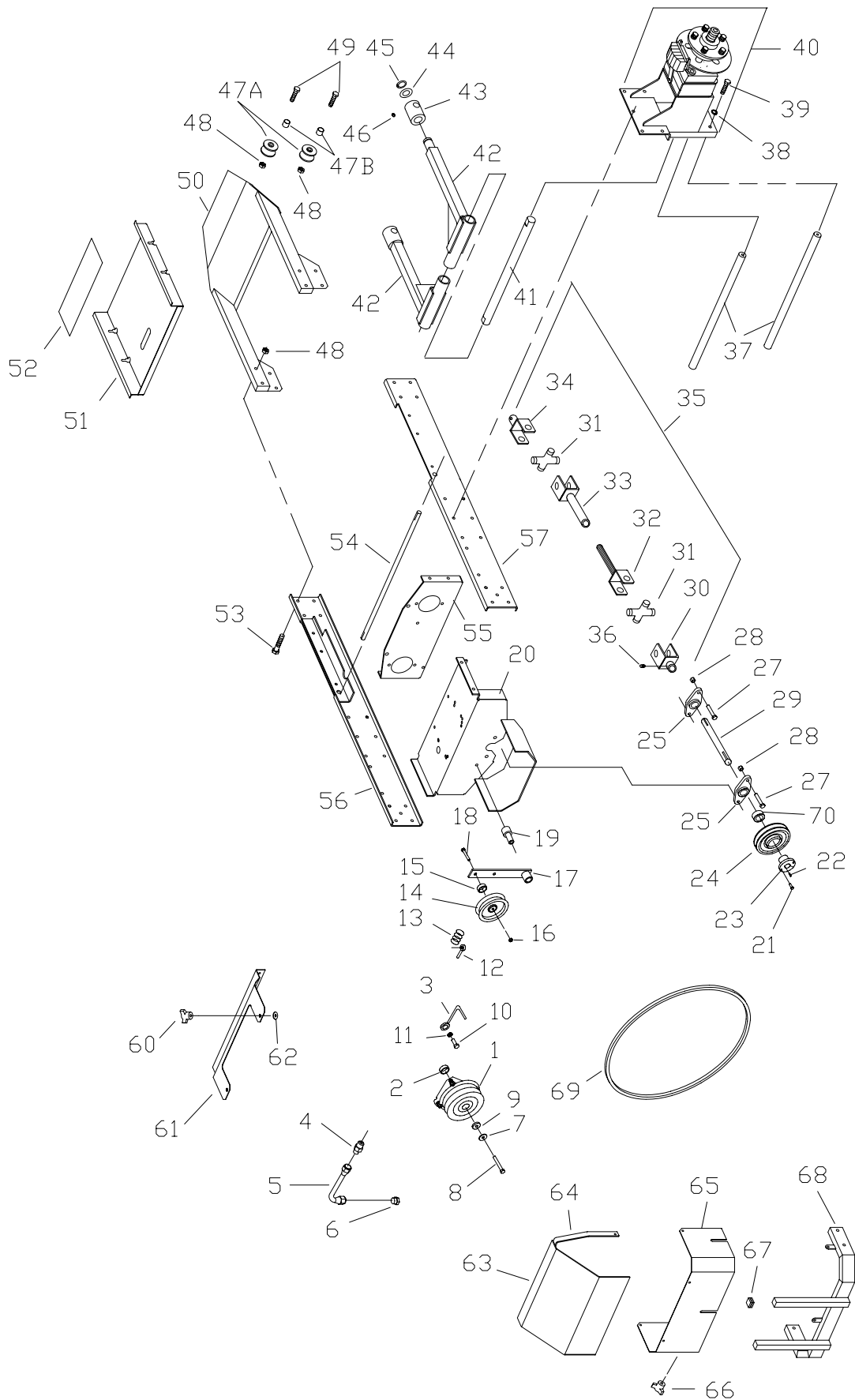

52" Mid-Cut Mainframe Assembly

22 HP KAW
23/25 HP KAW
27 HP KAW

#	PART NO.	QTY	DESCRIPTION			
1A	523370	1	ELECTRIC CLUTCH - MS	X		
1B	823165	1	ELECTRIC CLUTCH - MS		X	
1C	583518	1	ELECTRIC CLUTCH - MS			X
2	523322	2	CLUTCH SPACER			
3	363075	1	ROUND BELT GUIDE			
4	523063	1	ENGINE DRAIN ADAPTER			
5	523064	1	ENGINE DRAIN LINE			
6	523065	1	ENGINE DRAIN PLUG			
7	753027	1	3/8" DISC SPRING WASHER			
8	109019	1	10MM-1.5 X 30MM HEX BOLT			
9	423068	1	CLUTCH WASHER			
10	100512	2	5/16"-24 X 1" HEX BOLT			
11	363226	4	DISC SPRING WASHER			
12	363080	1	RIGHT EYEBOLT			
13	593074	1	IDLER SPRING - HH			
14	483025	1	RIGHT HAND IDLER PULLEY			
15	483017	1	RIGHT HAND IDLER SPACER			
16	104257	30	3/8"-16 NYLOC NUT			
17	422025	1	TENSIONER W/BUSHING			
X	523111	X	BUSHING (SERVICE)			
18	100297	1	3/8"-16 X 2 1/4" HEX BOLT			
19	823030	1	IDLER PIVOT			
20	582043	1	ENGINE BASE			
21	100252	2	1/4"-20 X 3/4" HHCS			
22	107259	1	1/4" X 1/4" X 1" KEY			
23	363215	1	TAPER LOCK HUB			
24	363216	1	TAPER LOCK SHEAVE			
25	823032	2	2 BOLT FLANGE BEARING			
27	100311	4	7/16"-14 X 1 1/4" HEX BOLT			
28	104258	4	7/16"-14 NYLOC NUT			
29	583080	1	1" POWER SHAFT - MC			
30	523414	1	1" YOKE			
31	523415	2	CROSS			
32	593075	1	YOKE SHAFT			
33	583481	1	YOKE TUBE			
34	823372	1	3/4" YOKE			
35	593064	1	COMPLETE PTO SHAFT			
36	103295	2	3/8"-16 X 1/2" SET SCREW			
37	823066	2	BRACE ROD - LOWER			
38	105006	6	3/8" LOCKWASHER			
39	100292	23	3/8"-16 X 1" HEX BOLT			
40			SEE HYDRAULIC ILLUSTRATION			
41	823050	1	DECK ARM SHAFT			
42	822036	2	DECK ARM			
43	822090	2	DCK ARM SWVL W/ZERK			
44	823015	4	DECK ARM WASHER			
45	108502	2	SNAP RING			
46	111004	12	1/4"-28 GREASE ZERK			
47	583120	2	FRONT PIVOT ROLLER (REF ONLY)			

52" Mid-Cut Mainframe Assembly

22 HP KAW
23/25 HP KAW
27 HP KAW

#	PART NO.	QTY	DESCRIPTION			
47A	583464	2	FRONT ROLLER			
47B	583490	2	FRONT ROLLER TUBE			
49	100298	2	3/8"-16 X 2 1/2" HEX BOLT			
50	582006	1	FRONT FRAME			
51	582029	1	FOOT PLATE			
52	823042	3	FOOT PLATE TREAD			
53	100295	4	3/8"-16 X 1 3/4" HEX BOLT			
54	823140	1	PARK SHAFT			
55			SEE HYDRAULIC ILLUSTRATION			
56	582041	1	LEFT HAND FRAME RAIL			
57	582039	1	RIGHT HAND FRAME RAIL			
60	583168	2	KNOB 5/16" STUD			
61	582078	1	FRONT GUARD - KAW			
62	109030	2	5/16" RETAINING CLIP			
63	822146	1	REAR COVER			
64	823335	2	REAR COVER STRAP			
65	583221	1	REAR COVER - KAW			
66	753028	2	KNOB			
67	583191	2	1" SQ. TUBE PLUG			
68	582061	1	ENGINE GUARD - REAR			
69A	523374	1	CLUTCH BELT	X		
69B	823267	1	CLUTCH BELT		X	
69C	583517	1	CLUTCH BELT			X
70	363145	1	1" CLAMP COLLAR			

NOTE:

- A CONTACT ENGINE MFG FOR ALL ENGINE & RADIATOR PARTS NOT SHOWN. **ENCORE MFG DO NOT SERVICE THESE PARTS!**

52" Mid-Cut Seat Frame Assembly

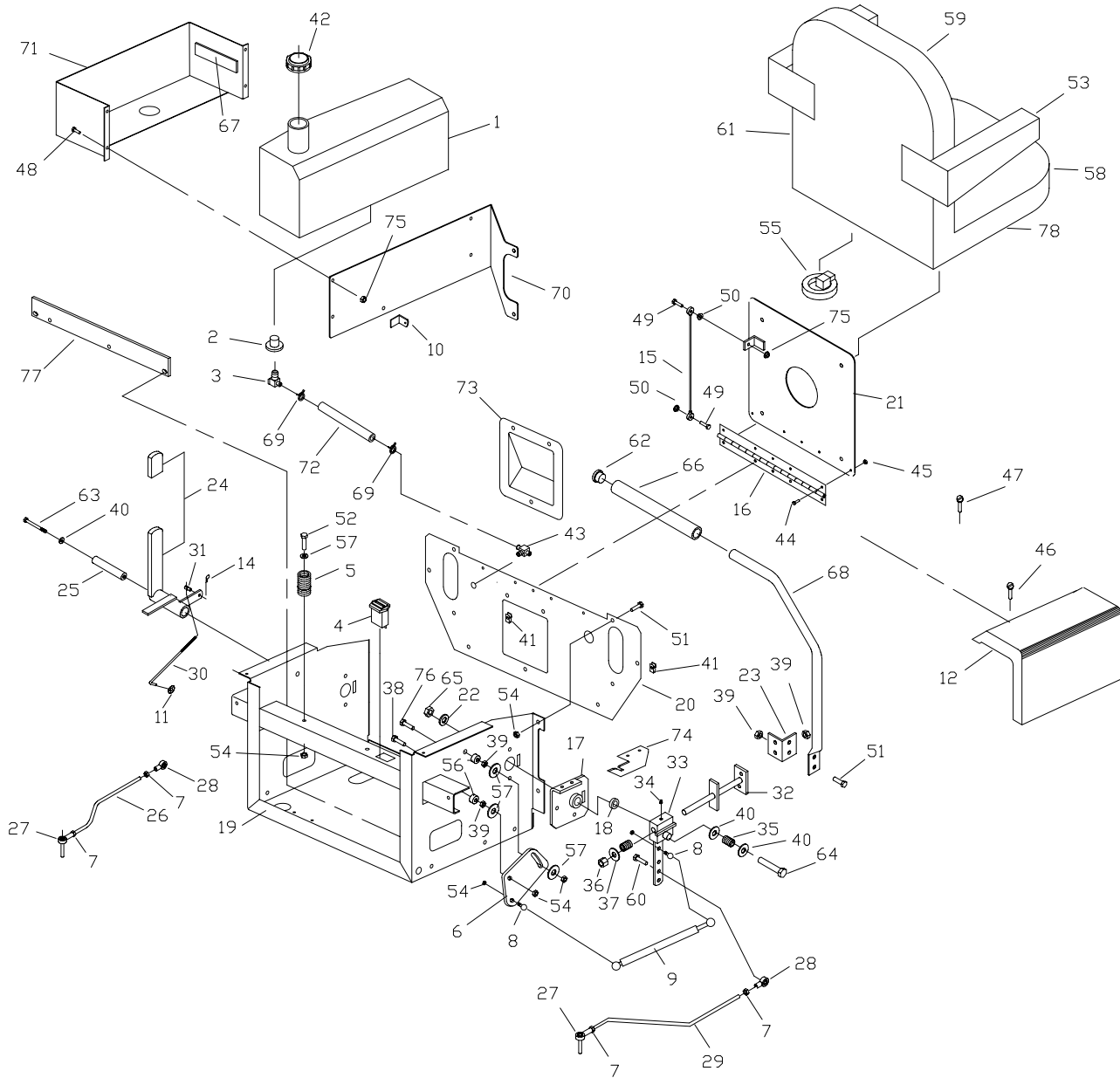

52" Mid-Cut Seatframe Assembly - ZP Series

#	PART NO.	QTY	DESCRIPTION			
1	583154	2	FUEL TANK			
2	393042	2	GROMMET			
3	583183	2	FUEL TANK ADAPTER			
4	523283	1	HOUR METER			
5	523278	2	SEAT SPRING			
6	583438	2	ADJUSTMENT PLATE			
7	104752	4	5/16"-24 JAM NUT			
8	823221	4	10MM BALL STUD			
9	583415	2	DAMPENER CONTROL			
10	583046	2	TANK MOUNT			
11	153045	2	5/16" PUSH NUT			
12A	583065	1	RIGHT FENDER			
12B	583064	1	FENDER - LEFT - MC			
13	104257	2	3/8"-16 NYLOC NUT			
14	363165	1	HAIR PIN COTTER			
15	523044	1	SEAT CABLE			
16	523105	1	SEAT HINGE			
17A	582110	1	LEFT HAND PIVOT W/BUSHING			
17B	582109	1	RIGHT HAND PIVOT W/BUSHING			
18	253059	2	ENGAGEMENT BUSHING			
19	822054	1	SEAT FRAME WELDMENT			
20	583028	1	FRONT - SEAT FRAME			
21	822058	1	SEAT PLATE			
22	373089	2	RETAINING WASHER			
23	523222	2	CONTROL LEVER ANGLE			
24	582048	1	PARK LEVER W/GRIP			
25	363105	1	IDLER BUSHING (PLTD)			
26	583140	1	LEFT HAND DRIVE ROD			
27	423160	2	5/16"-24 BALL STUD			
28	453082	2	5/16" ROD END (M)			
29	583138	1	RIGHT HAND DRIVE ROD			
30	823132	1	PARK BRAKE LINK			
31	363029	2	5/16" ROD SWIVEL			
32A	582084	1	LEFT HAND PIVOT			
32B	582082	1	RIGHT HAND PIVOT			
33	822075	2	DRIVE BLOCK W/ZERK			
34	111004	2	1/4"-24 ZERK			
35	363024	4	COMPRESSION SPRING			
36	104259	4	1/2"-13 NYLOC NUT			
37	105264	2	1/2" FLAT WASHER			
38	100275	2	5/16"-18 X 1 1/2" HEX BOLT			
39	109001	8	5/16"-18 WHIZ LOCK NUT			
40	105260	6	3/8" FLAT WASHER			
41	109015	8	1/4"-20 NUT CLIP			
42	363257	2	FUEL CAP w/GASKET			
43	583050	1	FUEL VALVE			
44	101039	5	#10-28 X 5/8" SCREW			
45	104252	4	#10-28 NYLOC NUT			
46	103004	2	1/4" X 14 3/4" SELF TAPPING SCREW			
47	102000	7	#12-24 THREADED CUTTING SCREW			

52" Mid-Cut Seatframe Assembly - ZP Series

#	PART NO.	QTY	DESCRIPTION
48	100252	8	1/4"-20 X 3/4" HEX BOLT
49	100254	8	1/4"-20 X 1" HEX BOLT
50	109000	8	1/4"-20 WHIZ LOCK NUT
51	100271	8	5/16"-18 X 3/4" HEX BOLT
52	100273	2	5/16"-18 X 1" HEX BOLT
53	583091	2	ARM REST PAD KIT
53A	583242	1	ARM REST PAD - LEFT
53B	583243	1	ARM REST PAD - RIGHT
54	104256	20	5/16"-24 NYLOC NUT
55	523030	1	SEAT SWITCH
56	363113	4	WHEEL PULLEY SPACER (PLTD)
57	105258	11	5/16" FLAT WASHER
58	583089	1	SEAT CUSHION
59	583090	1	BACK CUSHION
60	100274	2	5/16"-18 X 1 1/4" HEX BOLT
61	583077	1	SEAT - LT. GRAY W/LOGO
62	523033	2	HANDLE PLUG
63	100303	1	3/8"-16 X 4" HEX BOLT
64	100305	2	3/8"-16 X 4 1/2" HEX BOLT
65	104257	3	3/8"-16 NYLOC NUT
66	523032	2	HANDLE GRIP
67	363201	4	FUEL TANK PAD
68	523017	2	HANDLE
68A	522100	X	HANDLE ASSY W/GRIP (COMPLETE)
69	363098	5	FUEL LINE CLAMP
70A	583054	1	BACK PLATE LH - TANK
70B	583052	1	BACK PLATE RH - TANK
71A	582065	1	FUEL TANK SADDLE - LH
71B	582045	1	FUEL TANK SADDLE - RH
72A	583186	1	FUEL LINE LH
72B	583185	1	FUEL LINE RH
73	583037	1	CONTROL PANEL
74A	583254	1	RH LEVER LOCK
74B	583256	1	LH LEVER LOCK
75	104255	2	1/4"-20 NYLOC NUT
76	107520	2	5/16"-18 X 3/4" HEX BOLT
77	583188	1	BATTERY MOUNT
78	583519		FULL SUSPENSION SEAT

52" Mid-Cut Small Pump Hydro Assembly

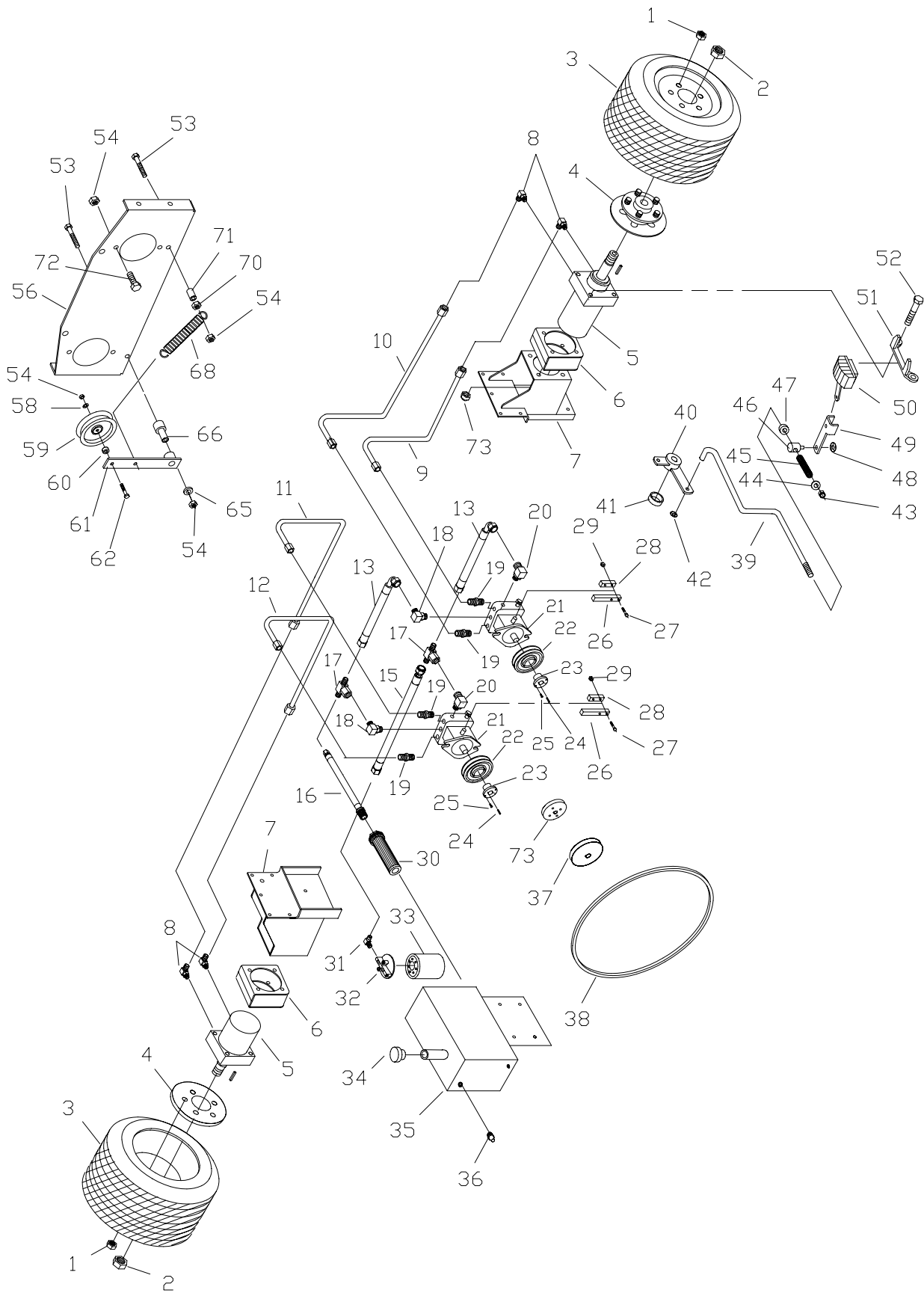

52" Mid-Cut Small Hydro Pump Assembly

22 HP KAW
23/25 HP KAW
27 HP KAW

#	PART NO.	QTY	DESCRIPTION			
1	103023	10	LUG NUT			
2	104511	2	WHEEL NUT			
3	583055	2	DRIVE WHEEL (COMPLETE)			
3A	583059	X	DRIVE TIRE (24 X 12 X 12)			
3B	583487	X	BAR LUG TIRE (23 X 10.5 X 12)			
3C	583058	X	RIM W/ VALVESTEM			
4	582008	2	WHEEL HUB			
5	583325	2	WHEEL MOTOR - MP14			
5A	583520	X	SEAL KIT - MP14			
7	582002	1	RIGHT HAND MOTOR MOUNT			
7	582004	1	LEFT HAND MOTOR MOUNT			
8	523058	4	90 DEGREE MOTOR ADAPTER			
9	583379	1	RIGHT HAND OUTSIDE LINE - STEEL(52")			
10	583378	1	RIGHT HAND INSIDE LINE - STEEL(52")			
11	583380	1	LEFT HAND INSIDE LINE - STEEL(52")			
12	583381	1	LEFT HAND OUTSIDE LINE - STEEL(52")			
13	583241	2	PUMP TO PUMP HOSE			
15	423066	1	PUMP TO FILTER HOSE(52")			
16	453129	1	PUMP TO TANK SUPPLY HOSE			
17	453106	2	SWIVEL TEE			
18	583391	2	90 DEGREE INLET ADAPTER			
19	583126	4	STRAIGHT ADAPTER			
20	453074	2	90 DEGREE ADAPTER			
21	453087	2	PUMP- 10L			
21A	453146	X	PUMP SEAL KIT - 10L			
22	583382	2	PUMP PULLEY			
23	423178	2	15 MM TAPER HUB			
24	453102	2	PUMP KEY			
25	100252	2	1/4"-20 X 3/4" HEX BOLT			
26	823104	2	CONTROL BAR			
27	100257	4	1/4"-20 X 1 3/4" HEX BOLT			
28	453090	2	CLAMP BAR			
29	104255	6	1/4"-20 NYLOC NUT			
30	583132	1	SUCTION SCREEN			
31	583129	1	FILTER ADAPTER(52")			
32	423064	1	FILTER HEAD			
33	423063	1	HYDRO OIL FILTER (NO CROSS REF AVAIL)			
34	583406	1	OIL BREATHER CAP(52")			
35A	583384	1	OIL TANK(52")			
35B	582149	1	OIL TANK MOUNT(52")			
36	423065	1	OIL EYE			
37	583217	1	PUMP PULLEY - KAW			
38	583385	1	PUMP BELT SML PUMP	X	X	X
39	583390	2	BRAKE ROD(52")			
40	422049	1	BRAKE CRANK			
41	373086	1	BLADE SPACER			
42	104256	6	5/16" PUSH NUT			
43	104256	20	5/16" NYLOC NUT			
44	105258	2	5/16" FLAT WASHER			
45	523024	2	DECK DR. SPRING			

52" Mid-Cut Small Hydro Pump Assembly

22 HP KAW
23/25 HP KAW
27 HP KAW

#	PART NO.	QTY	DESCRIPTION			
46	423130	2	PARK BRAKE SWIVEL			
47	523112	2	5/16" CLAMP COLLAR			
48	363177	2	3/8" PUSH NUT			
49	583190	2	BRAKE ARM			
50A	583038	1	RIGHT HAND BRAKE CALIPER			
50B	583039	1	LEFT HAND BRAKE CALIPER			
50C	583511	X	BRAKE PAD KIT			
51	583040	2	CALIPER MOUNT			
52	100339	8	1/2"-13 X 6" HEX BOLT			
53	100300	2	3/8"-16 X 3" HEX BOLT			
54	104257	32	3/8" NYLOC NUT			
56	583328	1	PUMP PLATE -MCBDP10			
58	105260	13	3/8" FLAT WASHER			
59	823351	1	PUMP DRIVE IDLER			
60	523277	1	IDLER SPACER			
61	422025	1	TENSIONER W/BUSHING			
X	523111	X	BUSHING (SERVICE)			
62	107501	2	3/8"-16 X 2" CARRIAGE BOLT			
65	373089	2	RETAINING WASHER			
66	423175	1	IDLER PIVOT			
68	583144	1	PUMP IDLER SPRING			
70	109007	2	3/8"-16 WHIZLOCK NUT			
71	393070	1	IDLER SPACER			
73	583274	1	FRONT DRIVE ADAPTER			

52" Mid-Cut Electrical Section

22 HP KAW
23/25 HP KAW
27 HP KAW

#	PART NO.	QTY	DESCRIPTION			
1	523037	1	CHOKE CABLE			
2	101039	6	#10 - 24 X 5/8" PAN HEAD BOLT			
3	104252	6	#10-24 NYLOC NUT			
4A	583212	1	WIRE HARNESS	X		
4B1	583177	1	WIRE HARNESS		X	
4B2	583495	1	ENGINE WIRE HARNESS		X	
4C	583484	1	ENGINE WIRE HARNESS			X
5	523145	1	20 AMP FUSE			
6	523146	1	15 AMP FUSE			
7	523147	1	10 AMP FUSE			
8	523042	2	RELAY			
9	423027	1	IGNITION SWITCH ASSEMBLY			
10	823193	1	NEUTRAL SWITCH			
11	823194	1	ALARM			
12	423142	1	12 VOLT BATTERY			
13	423172	2	BATTERY HOLD DOWN			
14	423011	1	BATTERY HOLD DOWN ANGLE			
15	423158	3	TERMINAL INSULATOR			
X	823199	1	BATTERY BOOT - POS.			
16	109017	2	1/4"-20 WING NUT			
17	523031	1	PTO SWITCH			
18	101252	2	#5-40 X 1" SCREW			
19	104520	2	#5-40 NUT			
20	523038	1	THROTTLE CABLE			
21	523034	1	PARK BRAKE SWITCH			
22	823196	1	POSITIVE CABLE			
23	823197	1	NEGATIVE CABLE			
24	523036	3	WARNING LIGHT			
25	583030	1	BACK PLATE CONTROL PANEL			
26	423030	1	SAFETY MODULE		X	X

**61” MID-CUT
GAS ENGINE
OPTION
SECTION**

61" Mid-Cut Deck Assembly

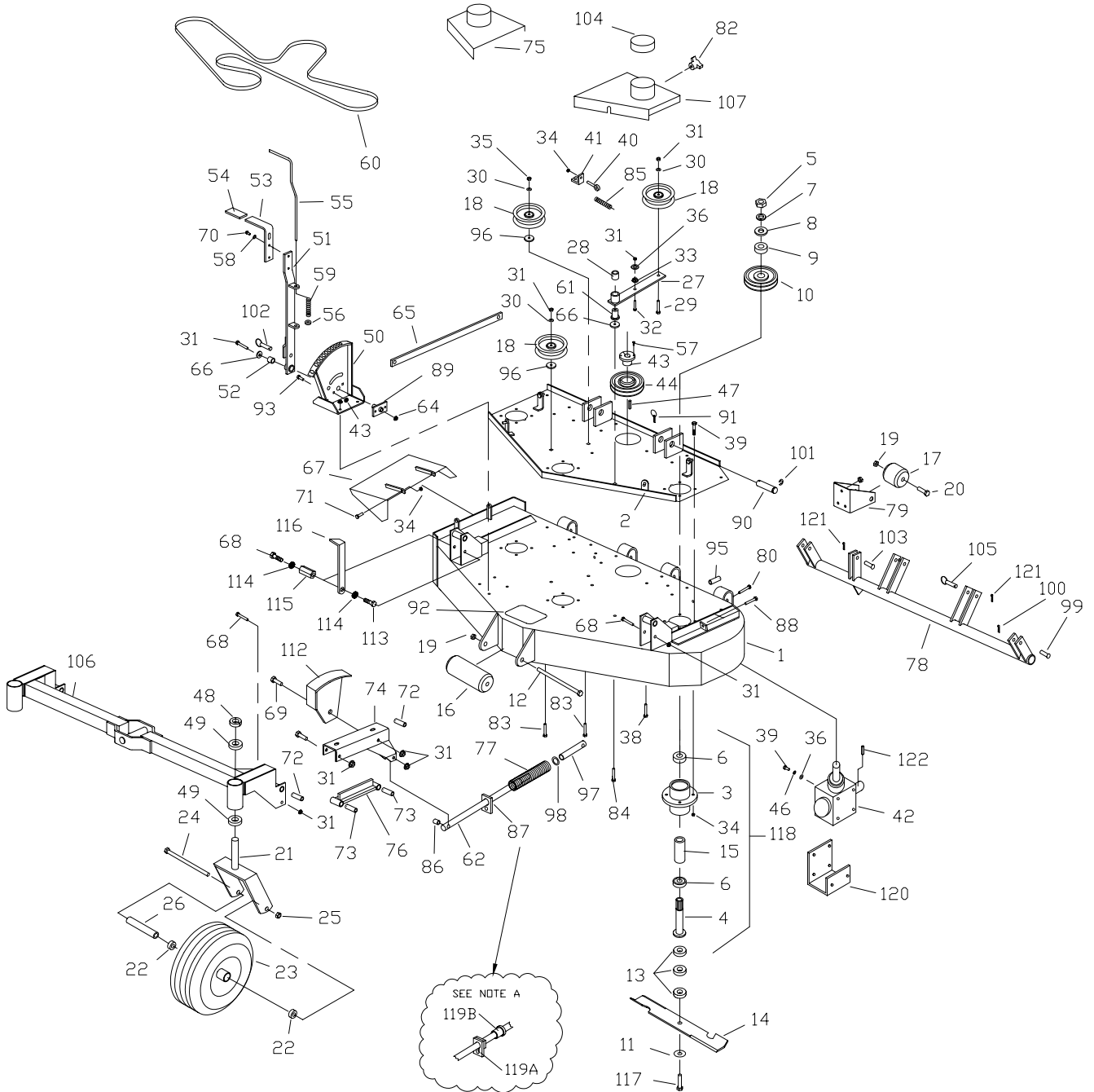

61" Mid-Cut Deck Assembly

#	PART NO.	QTY	DESCRIPTION
1	582016	1	61" MC DECK WLDMNT
2	582012	1	61" MC DECK CHANNEL
3	583111	3	SPINDLE HOUSING
4	583112	3	SPINDLE SHAFT
5	104511	3	3/4"-16 HEX NUT
6	363350	6	BEARING - BLADE SPINDLE
7	105010	3	3/4" LOCK WASHER
8	105269	3	3/4" SAE FLAT WASHER
9	583110	3	PULLEY SPACER
10	583107	3	SPINDLE PULLEY - 5 3/4"
11	583108	3	5/8" SPRING DISC WASHER
12	100351	1	5/8"-11 X 8 1/2" HEX BOLT
13	583109	9	BLADE SPACER
14	823006	3	21.0" HI LIFT BLADE
15	583113	3	BEARING SPACER TUBE
16	603023	1	ANTI-SCALP ROLLER
17	523084	2	REAR DECK ROLLER
18	523329	3	FLTG. IDLER - FLAT
19	104261	3	5/8"-11 NYLOC NUT
20	100346	2	5/8"-11 X 4 1/2" HEX BOLT
21	822088	2	WIDE TAIL WHEEL STRUT
22	363187	4	1" BEARING
23	823220	2	WIDE TIRE ASSY (COMPLETE)
23A	823339	X	TIRE (13 X 6.5 X 6)
23B	823338	X	FRONT RIM W/ VALVESTEM
24	100352	2	5/8"-11 X 9" HEX BOLT
25	104261	2	5/8"-11 NYLOC NUT
26	823245	2	AXLE TUBE
27	822144	1	DECK IDLER ARM W/BUSHING
28	363007	1	3/4 FLNG. BUSHING
29	107511	1	3/8"-16 X 2" CARRIAGE BOLT
30	105260	8	3/8" FLAT WASHER
31	104257	16	3/8"-16 NYLOC NUT
32	100275	1	5/16"-18 X 1 1/2" HEX BOLT
33	109001	2	5/16"-18 WHIZLOCK NUT
34	104256	36	5/16"-18 NYLOC NUT
35	109007	2	3/8"-16 WHIZLOCK NUT
36	105258	9	5/16" FLAT WASHER
37	107503	10	5/16"-18 X 3/4" CARRIAGE BOLT
38	107509	5	5/16"-18 X 1" CARRIAGE BOLT
39	100274	12	5/16"-18 X 1 1/4" HEX BOLT
40	363080	1	RIGHT EYE BOLT
41	523094	1	SPRING MT.-DECK
42	583087	1	DECK - GEAR BOX
43	523371	1	3/4" TAPER HUB
44	523096	1	5" TAPERED PULLEY
46	105005	4	5/16" LOCK WASHER
47	107255	1	3/16" X 1" KEY
48	363145	2	1" CLAMP COLLAR
49	363187	2	1" FLANGE BEARING

61" Mid-Cut Deck Assembly

#	PART NO.	QTY	DESCRIPTION				
50	582021	1	HEIGHT ADJUSTMENT BRACKET				
51	822141	1	DECK HEIGHT BAR W/BUSHING				
52	253059	1	ENGAGEMENT BUSHING				
53	822062	1	DECK HEIGHT HANDLE W/GRIP				
54	823312	1	GRIP				
55	823149	1	HANDLE ROD				
56	823093	1	3/8" CLAMP COLLAR				
57	100252	6	1/4"-20 X 3/4" HEX BOLT				
58	105004	2	1/4" LOCK WASHER				
59	523028	1	ASSIST SPRING				
60	823242	1	61" DECK BELT				
61	423175	1	PUMP IDLER PIVOT				
62	823155	2	CASTER ROD				
64	100297	1	3/8"-16 X 2 1/4" HEX BOLT				
65	582063	1	LIFT ARM WELDMENT				
66	373089	1	3/8 STD RETAINING WASHER				
67	582025	1	GRASS DEFLECTOR - 61				
68	100300	4	3/8"-16 X 3" HEX BOLT				
69	100301	4	3/8"-16 X 3 1/4" HEX BOLT				
70	100251	2	1/4"-20 X 5/8" HEX BOLT				
71	100273	2	5/16"-18 X 1" HEX BOLT				
72	823330	4	CASTER ARM PIVOT				
73	823090	4	CASTER BAR PIVOT				
74A	582053	1	LEFT HAND CASTER ARM				
74B	582051	1	RIGHT HAND CASTER ARM				
75	582055	1	RIGHT HAND BELT SHIELD				
76	582059	2	CASTER BAR WELDMENT				
77	823150	2	HEAVY COMPRESSION SPRING				
78	822124	1	61" DECK TUBE WELDMENT				
79	583074	2	ROLLER MOUNT				
80	100298	2	3/8"-16 X 2 1/2" HEX BOLT				
82	753028	4	KNOB				
83	107516	2	3/8"-16 X 2 1/4" CARRIAGE BOLT				
84	107513	3	3/8"-16 X 3" CARRIAGE BOLT				
85	593074	1	SPRING - FLTG. IDLER				
86	823153	2	CASTER ROD SPACER				
87	823159	2	SPRING SLIDE				
88	100030	2	3/8"-16 X 3" TAP BOLT				
89	822132	1	DECK HEIGHT PIVOT				
90	823333	2	DECK ATTACH PIN				
91	108001	3	3/16" QUICK PIN				
92	823200	1	STEP TREAD				
93	107502	2	1/4"-20 X 3/4" CARRIAGE BOLT				
94	104255	2	1/4"-20 NYLOC NUT				
95	823314	2	TUBE SADDLE SPACER				
96	483017	2	RIGHT HAND IDLER SPACER				
97	823157	2	CASTER ROD END				
98	109025	2	5/8" HEAVY WASHER				
99	823210	2	1/2" X 2" CLEVIS PIN				

61" Mid-Cut Deck Assembly

#	PART NO.	QTY	DESCRIPTION
100	106763	2	1/8" COTTER PIN
101	108510	4	7/8" E-RING
102	109026	1	1/2" X 2" DETENT PIN
103	823209	1	1/2" X 1 1/2" CLEVIS PIN
104	363161	2	BELT SHIELD CAP
105	823211	2	1/2" X 2 1/2" RING PIN
106	582010	1	FRONT AXLE
107	582057	1	LEFT HAND BELT SHIELD
112	582176	1	CUT GAGE WELDMENT
113	100291	1	3/8"-16 X 3/4" HEX BOLT
114	105006	2	3/8" LOCK WASHER
115	583422	1	NUT - CUT GAGE
116	583420	1	POINTER - CUT GAGE
117	100358	3	5/8"-11 X 2 1/4" HEX BOLT
118	583106	3	BLADE SPINDLE ASSY
119A	592006	1	SPRING RETAINER
119B	363007	1	FLANGE BUSHING
120	593096	1	GEAR BOX TRUSS
121	106778	2	3/16 X 1 1/2" COTTER PIN
122	107255	1	KEY - 3/16" X 1"

NOTES:

- A PREFORMANCE UPGRADE FOR DECK SPRING ASSY. REQUIRES ITEM 119.
BOTH SIDES NEED BE UPGRADED AT THE SAME TIME.

61" Mid-Cut Mainframe Assembly

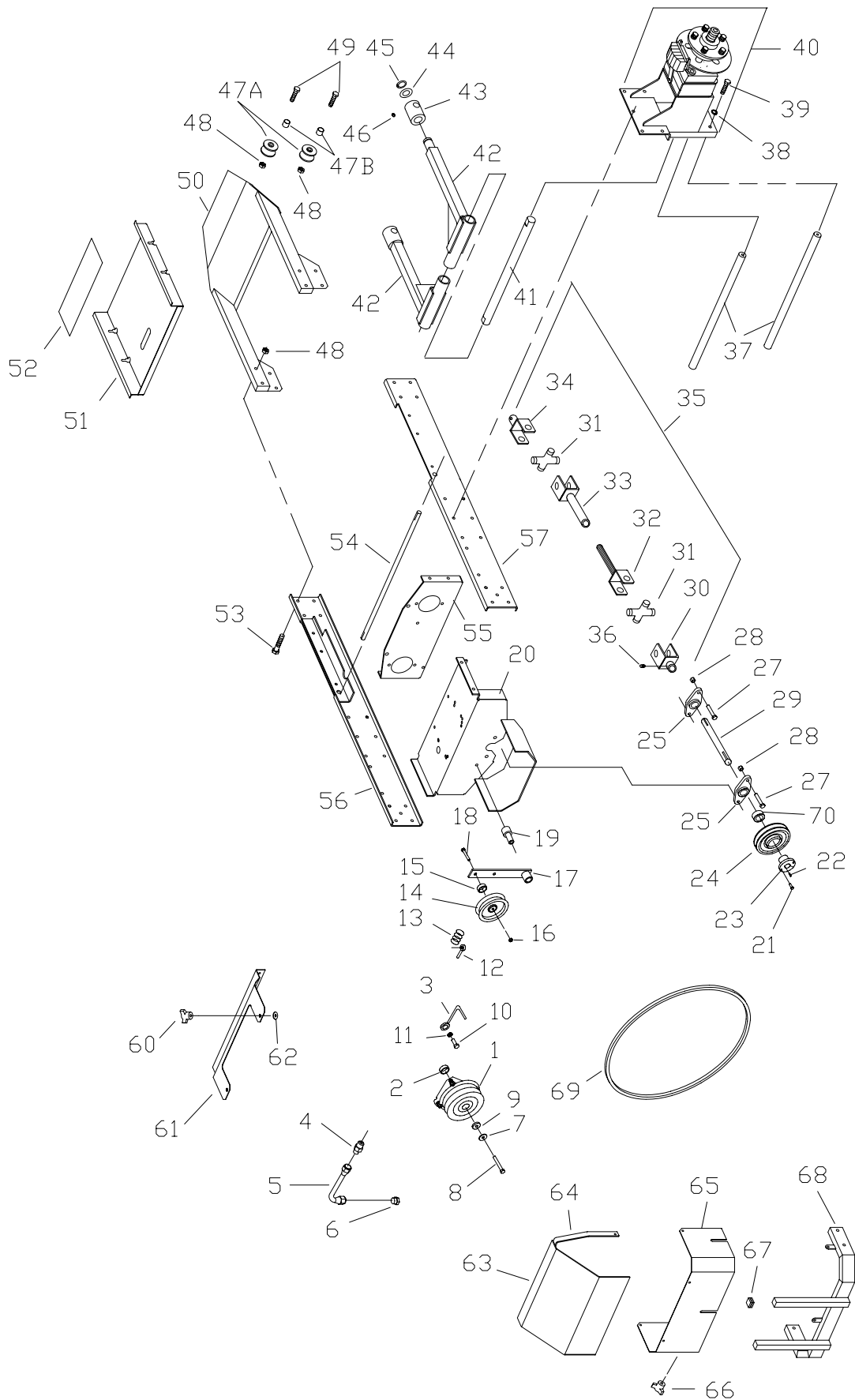

61" Mid-Cut Mainframe Assembly

22 HP KAW
23/25 HP KAW
27 HP KAW
31 HP BRIGGS

#	PART NO.	QTY	DESCRIPTION	22 HP KAW	23/25 HP KAW	27 HP KAW	31 HP BRIGGS
1A	523370	1	ELECTRIC CLUTCH - MS	X			
1B	823165	1	ELECTRIC CLUTCH - MS		X		
1C	583518	1	ELECTRIC CLUTCH - MS			X	
1E	583308	1	ELECTRIC CLUTCH - MS				X
2	523322	2	CLUTCH SPACER				
3	363075	1	ROUND BELT GUIDE				
4	523063	1	ENGINE DRAIN ADAPTER				
5	523064	1	ENGINE DRAIN LINE				
6	523065	1	ENGINE DRAIN PLUG				
7	753027	1	3/8" DISC SPRING WASHER				
8	109019	1	10MM-1.5 X 30MM HEX BOLT				
9	423068	1	CLUTCH WASHER				
10	100512	2	5/16"-24 X 1" HEX BOLT				
11	363226	4	DISC SPRING WASHER				
12	363080	1	RIGHT EYEBOLT				
13	593074	1	IDLER SPRING - HH				
14	483025	1	RIGHT HAND IDLER PULLEY				
15	483017	1	RIGHT HAND IDLER SPACER				
16	104257	30	3/8"-16 NYLOC NUT				
17	422025	1	TENSIONER W/BUSHING				
X	523111	X	BUSHING (SERVICE)				
18	100297	1	3/8"-16 X 2 1/4" HEX BOLT				
19	823030	1	IDLER PIVOT				
20A	582043	1	ENGINE BASE - KAW	X	X	X	
20B	582163	1	ENGINE BASE 31 GAS BRIGGS				X
21	100503	2	1/4" X 3/4" HEX BOLT				
22	107259	1	1/4" X 1/4" X 1" KEY				
23	363215	1	TAPER LOCK HUB				
24	363216	1	TAPER LOCK SHEAVE				
25	823032	2	2 BOLT FLANGE BEARING				
27	100311	4	7/16"-14 X 1 1/4" HEX BOLT				
28	104258	4	7/16"-14 NYLOC NUT				
29	583080	1	1" POWER SHAFT - MC				
30	523414	1	1" YOKE				
31	523415	2	CROSS				
32	593075	1	YOKE SHAFT				
33	583481	1	YOKE TUBE				
34	823372	1	3/4" YOKE				
35	593064	1	COMPLETE PTO SHAFT				
36	103295	2	3/8"-16 X 1/2" SET SCREW				
37	823066	2	BRACE ROD - LOWER				
38	105006	6	3/8" LOCKWASHER				
39	100292	23	3/8"-16 X 1" HEX BOLT				
40			SEE HYDRAULIC ILLUSTRATION				
41	823050	1	DECK ARM SHAFT				
42	822036	2	DECK ARM				
43	822090	2	DCK ARM SWVL W/ZERK				
44	823015	4	DECK ARM WASHER				
45	108502	2	SNAP RING				
46	111004	12	1/4"-28 GREASE ZERK				

61" Mid-Cut Mainframe Assembly

22 HP KAW
23/25 HP KAW
27 HP KAW
31 HP BRIGGS

#	PART NO.	QTY	DESCRIPTION	22 HP KAW	23/25 HP KAW	27 HP KAW	31 HP BRIGGS
47	583120	2	FRONT PIVOT ROLLER (REF ONLY)				
47A	583464	2	FRONT ROLLER				
47B	583490	2	FRONT ROLLER TUBE				
49	100298	2	3/8"-16 X 2 1/2" HEX BOLT				
50	582006	1	FRONT FRAME				
51	582029	1	FOOT PLATE				
52	823042	3	FOOT PLATE TREAD				
53	100295	4	3/8"-16 X 1 3/4" HEX BOLT				
54	823140	1	PARK SHAFT				
55			SEE HYDRAULIC ILLUSTRATION				
56	582041	1	LEFT HAND FRAME RAIL				
57	582039	1	RIGHT HAND FRAME RAIL				
60	583168	2	KNOB 5/16" STUD				
61	582078	1	FRONT GUARD - KAW				
62	109030	2	5/16" RETAINING CLIP				
63	822146	1	REAR COVER				
64	823335	2	REAR COVER STRAP				
65	583221	1	REAR COVER - KAW				
66	753028	2	KNOB				
67	583191	2	1" SQ. TUBE PLUG				
68	582061	1	ENGINE GUARD - REAR				
69A	523374	1	CLUTCH BELT	X			X
69B	823267	1	CLUTCH BELT		X		
69C	583517	1	CLUTCH BELT			X	
70	363145	1	1" CLAMP COLLAR				

NOTE:

- A CONTACT ENGINE MFG FOR ALL ENGINE & RADIATOR PARTS NOT SHOWN. **ENCORE MFG DO NOT SERVICE THESE PARTS!**

61" Mid-Cut Seatframe Assembly - ZP Series

#	PART NO.	QTY	DESCRIPTION				
1	583154	2	FUEL TANK				
2	393042	2	GROMMET				
3	583183	2	FUEL TANK ADAPTER				
4	523283	1	HOUR METER				
5	523278	2	SEAT SPRING				
6	583438	2	ADJUSTMENT PLATE				
7	104752	4	5/16"-24 JAM NUT				
8	823221	4	10MM BALL STUD				
9	583415	2	DAMPENER CONTROL				
10	583046	2	TANK MOUNT				
11	153045	2	5/16" PUSH NUT				
12A	583065	1	RIGHT FENDER				
12B	583064	1	FENDER - LEFT - MC				
13	104257	2	3/8"-16 NYLOC NUT				
14	363165	1	HAIR PIN COTTER				
15	523044	1	SEAT CABLE				
16	523105	1	SEAT HINGE				
17A	582110	1	LEFT HAND PIVOT W/BUSHING				
17B	582109	1	RIGHT HAND PIVOT W/BUSHING				
18	253059	2	ENGAGEMENT BUSHING				
19	822054	1	SEAT FRAME WELDMENT				
20	583028	1	FRONT - SEAT FRAME				
21	822058	1	SEAT PLATE				
22	373089	2	RETAINING WASHER				
23	523222	2	CONTROL LEVER ANGLE				
24	582048	1	PARK LEVER W/GRIP				
25	363105	1	IDLER BUSHING (PLTD)				
26	583140	1	LEFT HAND DRIVE ROD				
27	423160	2	5/16"-24 BALL STUD				
28	453082	2	5/16" ROD END (M)				
29	583138	1	RIGHT HAND DRIVE ROD				
30	823132	1	PARK BRAKE LINK				
31	363029	2	5/16" ROD SWIVEL				
32A	582084	1	LEFT HAND PIVOT				
32B	582082	1	RIGHT HAND PIVOT				
33	822075	2	DRIVE BLOCK W/ZERK				
34	111004	2	1/4"-24 ZERK				
35	363024	4	COMPRESSION SPRING				
36	104259	4	1/2"-13 NYLOC NUT				
37	105264	2	1/2" FLAT WASHER				
38	100275	2	5/16"-18 X 1 1/2" HEX BOLT				
39	109001	8	5/16"-18 WHIZ LOCK NUT				
40	105260	6	3/8" FLAT WASHER				
41	109015	8	1/4"-20 NUT CLIP				
42	363257	2	FUEL CAP w/GASKET				
43	583050	1	FUEL VALVE				
44	101039	5	#10-28 X 5/8" SCREW				
45	104252	4	#10-28 NYLOC NUT				
46	103004	2	1/4" X 14 3/4" SELF TAPPING SCREW				
47	102000	7	#12-24 THREADED CUTTING SCREW				

61" Mid-Cut Seatframe Assembly - ZP Series

#	PART NO.	QTY	DESCRIPTION				
48	100252	8	1/4"-20 X 3/4" HEX BOLT				
49	100254	8	1/4"-20 X 1" HEX BOLT				
50	109000	8	1/4"-20 WHIZ LOCK NUT				
51	100271	8	5/16"-18 X 3/4" HEX BOLT				
52	100273	2	5/16"-18 X 1" HEX BOLT				
53	583091	2	ARM REST PAD KIT				
53A	583242	1	ARM REST PAD - LEFT				
53B	583243	1	ARM REST PAD - RIGHT				
54	104256	20	5/16"-24 NYLOC NUT				
55	523030	1	SEAT SWITCH				
56	363113	4	WHEEL PULLEY SPACER (PLTD)				
57	105258	11	5/16" FLAT WASHER				
58	583089	1	SEAT CUSHION				
59	583090	1	BACK CUSHION				
60	100274	2	5/16"-18 X 1 1/4" HEX BOLT				
61	583077	1	SEAT - LT. GRAY W/LOGO				
62	523033	2	HANDLE PLUG				
63	100303	1	3/8"-16 X 4" HEX BOLT				
64	100305	2	3/8"-16 X 4 1/2" HEX BOLT				
65	104257	3	3/8"-16 NYLOC NUT				
66	523032	2	HANDLE GRIP				
67	363201	4	FUEL TANK PAD				
68	523017	2	HANDLE				
68A	522100	X	HANDLE ASSY W/GRIP (COMPLETE)				
69	363098	5	FUEL LINE CLAMP				
70A	583054	1	BACK PLATE LH - TANK				
70B	583052	1	BACK PLATE RH - TANK				
71A	582065	1	FUEL TANK SADDLE - LH				
71B	582045	1	FUEL TANK SADDLE - RH				
72A	583186	1	FUEL LINE LH				
72B	583185	1	FUEL LINE RH				
73	583037	1	CONTROL PANEL				
74A	583254	1	RH LEVER LOCK				
74B	583256	1	LH LEVER LOCK				
75	104255	2	1/4"-20 NYLOC NUT				
76	107520	2	5/16"-18 X 3/4" HEX BOLT				
77	583188	1	BATTERY MOUNT				
78	583519		FULL SUSPENSION SEAT				

61" Mid-Cut Small Hydro Pump Assembly

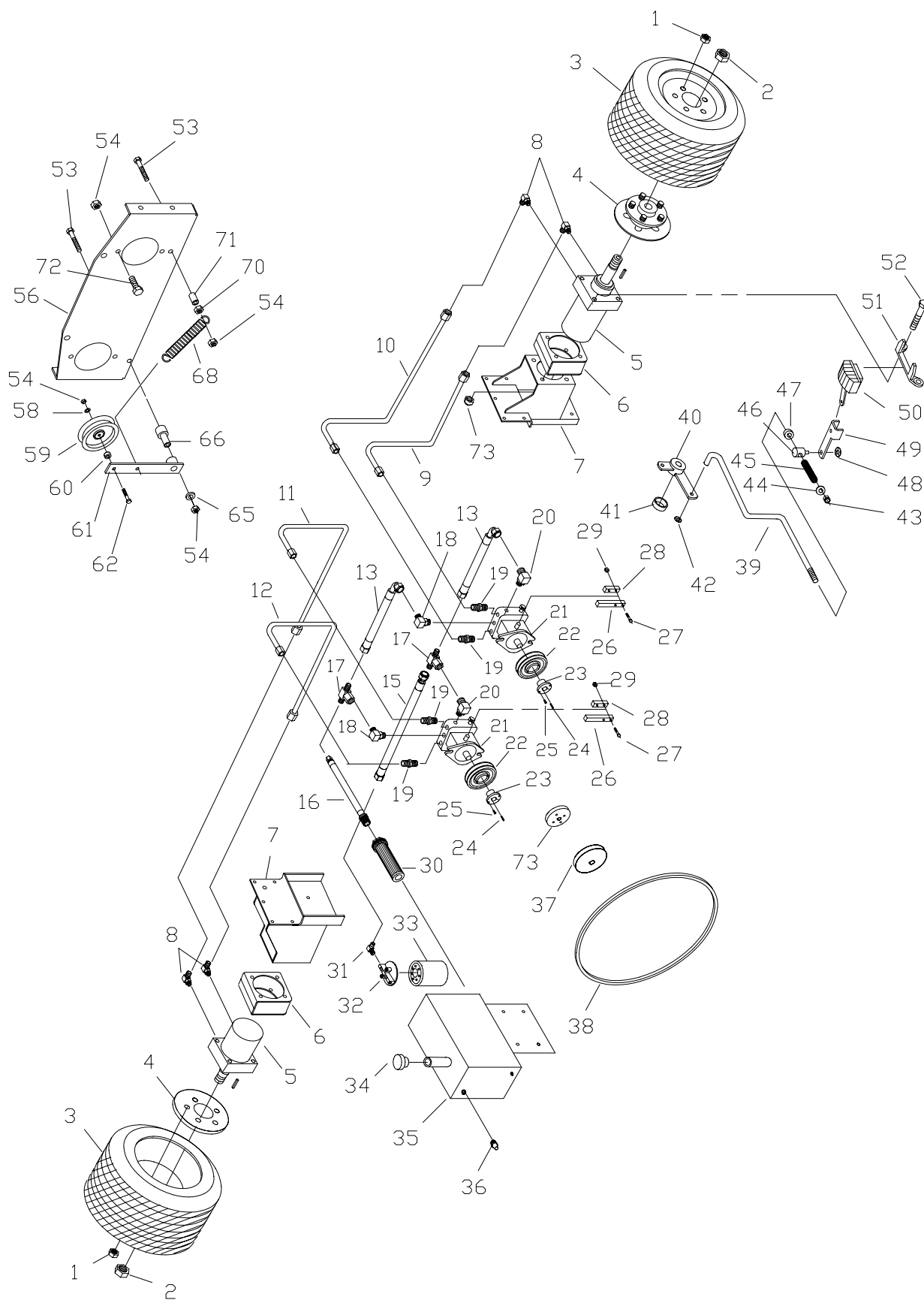

61" Mid-Cut Small Hydro Pump Assembly

22 HP KAW
23/25 HP KAW
27 HP KAW

#	PART NO.	QTY	DESCRIPTION			
1	103023	10	LUG NUT			
2	104511	2	WHEEL NUT			
3	583055	2	DRIVE WHEEL (COMPLETE)			
3A	583059	X	DRIVE TIRE (24 X 12 X 12)			
3B	583487	X	BAR LUG TIRE (23 X 10.5 X 12)			
3C	583058	X	RIM W/ VALVESTEM			
4	582008	2	WHEEL HUB			
5	583325	2	WHEEL MOTOR - MP14			
5A	583520	X	SEAL KIT - MP14			
6	582031	2	MOTOR SPACER			
7	582002	1	RIGHT HAND MOTOR MOUNT			
7	582004	1	LEFT HAND MOTOR MOUNT			
8	523058	4	90 DEGREE MOTOR ADAPTER			
9	583397	1	RIGHT HAND OUTSIDE LINE(61")			
10	583396	1	RIGHT HAND INSIDE LINE(61")			
11	583398	1	LEFT HAND INSIDE LINE(61")			
12	583399	1	LEFT HAND OUTSIDE LINE(61")			
13	583241	2	PUMP TO PUMP HOSE			
15	423126	1	PUMP TO FILTER HOSE(61")			
16	453129	1	PUMP TO TANK SUPPLY HOSE			
17	453106	2	SWIVEL TEE			
18	583391	2	90 DEGREE INLET ADAPTER			
19	583126	4	STRAIGHT ADAPTER			
20	453074	2	90 DEGREE ADAPTER			
21	453087	2	PUMP-10L			
21A	453146	X	PUMP SEAL KIT - 10L			
22	583382	2	PUMP PULLEY			
23	423178	2	15 MM TAPER HUB			
24	453102	2	PUMP KEY			
25	100252	2	1/4"-20 X 3/4" HEX BOLT			
26	823104	2	CONTROL BAR			
27	100257	4	1/4"-20 X 1 3/4" HEX BOLT			
28	453090	2	CLAMP BAR			
29	104255	6	1/4"-20 NYLOC NUT			
30	583132	1	SUCTION SCREEN			
31	583442	1	FILTER ADAPTER(61")			
32	423064	1	FILTER HEAD			
33	423063	1	HYDRO OIL FILTER (NO CROSS REF AVAIL)			
34	423165	1	OIL BREATHER CAP(61")			
35	583049	1	OIL TANK(61")			
36	423065	1	OIL EYE			
37	583217	1	PUMP PULLEY - KAW			
38	583385	1	PUMP BELT SML PUMP	X	X	X
39A	583042	1	RIGHT HAND BRAKE ROD(61")			
39B	583044	1	LEFT HAND BRAKE ROD(61")			
40	422049	1	BRAKE CRANK			
41	373086	1	BLADE SPACER			
42	104256	6	5/16" PUSH NUT			
43	104256	20	5/16" NYLOC NUT			
44	105258	2	5/16" FLAT WASHER			

61" Mid-Cut Small Hydro Pump Assembly

22 HP KAW
23/25 HP KAW
27 HP KAW

#	PART NO.	QTY	DESCRIPTION				
45	523024	2	DECK DR. SPRING				
46	423130	2	PARK BRAKE SWIVEL				
47	523112	2	5/16" CLAMP COLLAR				
48	363177	2	3/8" PUSH NUT				
49	583190	2	BRAKE ARM				
50A	583038	1	RIGHT HAND BRAKE CALIPER				
50B	583039	1	LEFT HAND BRAKE CALIPER				
50C	583511	X	BRAKE PAD KIT				
51	583040	2	CALIPER MOUNT				
52	100339	8	1/2"-13 X 6" HEX BOLT				
53	100300	2	3/8"-16 X 3" HEX BOLT				
54	104257	32	3/8" NYLOC NUT				
56	583328	1	PUMP PLATE -MCBDP10				
58	105260	13	3/8" FLAT WASHER				
59	823351	1	PUMP DRIVE IDLER				
60	523277	1	IDLER SPACER				
61	422025	1	TENSIONER W/BUSHING				
X	523111	X	BUSHING (SERVICE)				
62	107501	2	3/8"-16 X 2" CARRIAGE BOLT				
65	373089	2	RETAINING WASHER				
66	423175	1	IDLER PIVOT				
68	583144	1	PUMP IDLER SPRING				
70	109007	2	3/8"-16 WHIZLOCK NUT				
71	393070	1	IDLER SPACER				
73	583274	1	FRONT DRIVE ADAPTER				

61" Mid-Cut Large Hydro Pump Assembly

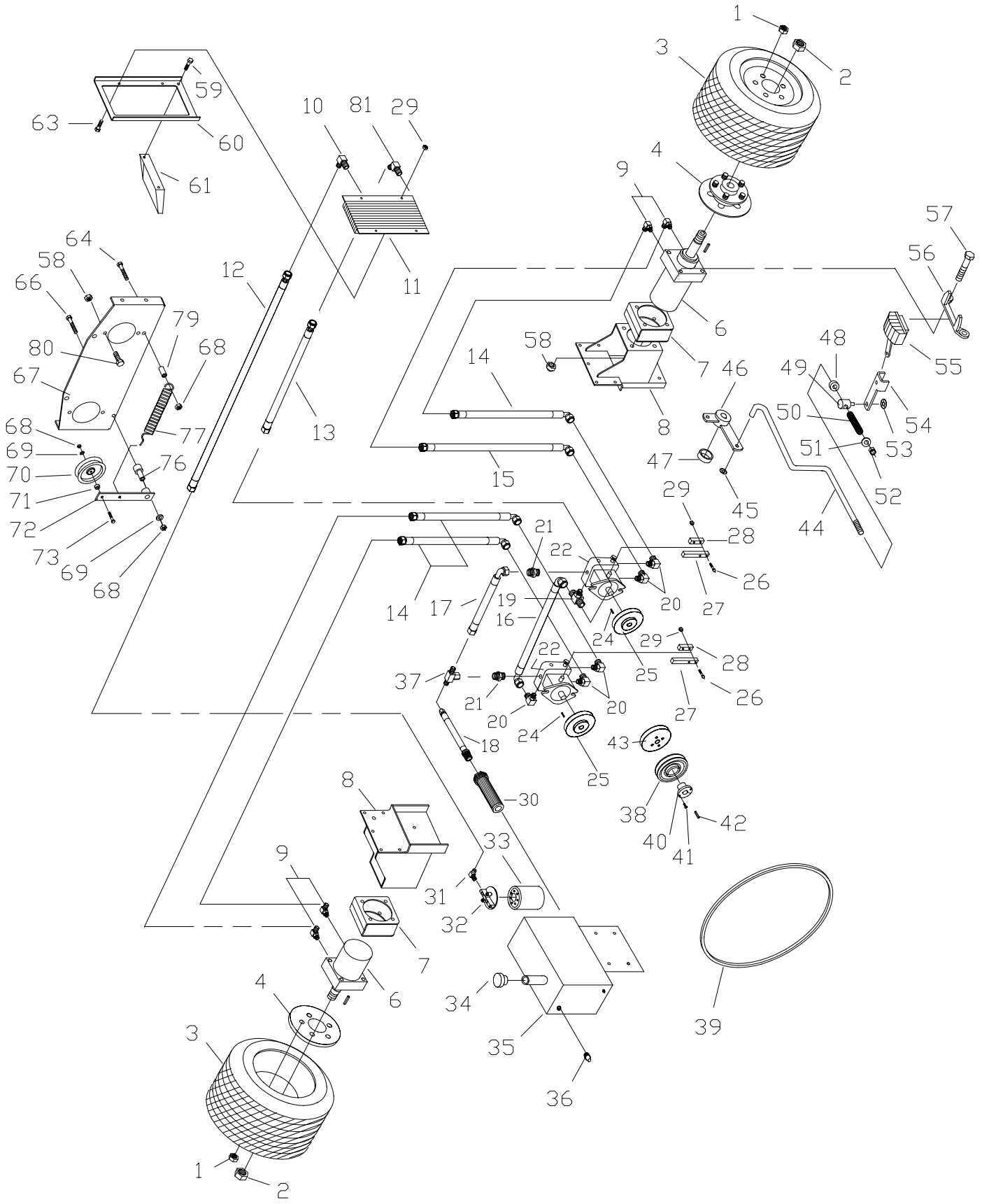

61" Mid-Cut Large Hydro Pump Assembly

31 HP BRIGGS

#	PART NO.	QTY	DESCRIPTION				
1	103023	10	1/2" LUG NUT				
2	104511	2	3/4"-16 HEX NUT				
3	583055	2	DRIVE WHEEL ASSY				
3A	583059	X	DRIVE TIRE (24 X 12 X 12)				
3B	583487	X	BAR LUG TIRE (23 X 10.5 X 12)				
3C	583058	X	RIM W/ VALVESTEM				
4	582008	2	WHEEL HUB				
6	583022	2	LARGE WHEEL MOTOR - MP24				
6A	583520	X	SEAL KIT - MP24				
7	582031	2	MOTOR SPACER				
8A	582002	1	RIGHT HAND MOTOR MOUNT				
8B	582004	1	LEFT HAND MOTOR MOUNT				
9	523058	4	RETURN ADPT.				
10	583214	2	OIL COOLER ADAPTER				
11	583201	1	OIL COOLER				
12	583216	1	COOLER TO FILTER HOSE				
13	583215	1	PUMP TO COOLER HOSE				
14	583376	3	21" HOSE				
15	583375	1	26 3/4" HOSE				
16	583124	1	PUMP TO PUMP RETURN HOSE				
17	583131	1	PUMP TO PUMP SUPPLY HOSE				
18	583130	1	TANK TO PUMP SUCTION HOSE				
19	583127	1	SUPPLY TEE				
20	453113	5	PUMP ELBOW				
21	583126	2	STRAIGHT ADAPTER				
22	583081	2	LARGE V-PUMP (BDP-21LH)				
22A	583377	X	PUMP SEAL KIT - 21L				
24	453102	2	PUMP KEY (5MM)				
25	583092	2	PUMP PULLEY				
26	100257	4	1/4"-20 X 1 3/4" HEX BOLT				
27	823104	2	PUMP CONTROL BAR				
28	453090	2	CLAMP BAR				
29	104255	6	1/4"-20 NYLOC NUT				
30	583132	1	SUCTION SCREEN				
31	583129	1	FILTER ADAPTER				
32	423064	1	FILTER HEAD				
33	423063	1	OIL FILTER				
34	423165	1	OIL BREATHER CAP				
35	583049	1	OIL TANK				
36	423065	1	OIL EYE				
37	523128	1	TENSIONER SWIVEL				
38	583217	1	PUMP DRIVE PULLEY (ENGINE)			X	
39	823026	1	PUMP BELT			X	
40	363215	1	TAPER LOCK HUB				
41	100252	2	1/4"-20 X 3/4" HEX BOLT				
42	107258	2	1/4" X 1/4" X 3/4" KEY				
43	583274	1	FRONT DRIVE ADAPTER				
44A	583042	1	RIGHT HAND BRAKE ROD				
44B	583044	1	LEFT HAND BRAKE ROD				
45	153045	3	5/16" PUSH NUT				

61" Mid-Cut Large Hydro Pump Assembly

31 HP BRIGGS

#	PART NO.	QTY	DESCRIPTION				
46	422049	1	BRAKE CRANK				
47	373086	1	BLADE SPACER				
48	523112	2	5/16" CLAMP COLLAR				
49	423130	2	PARK BRAKE SWIVEL				
50	523024	2	DECK DR. SPRING				
51	105258	2	5/16" FLAT WASHER				
52	104256	20	5/16" NYLOC NUT				
53	363177	2	3/8" PUSH NUT				
54	583190	2	BRAKE ARM				
55A	583038	1	RIGHT HAND BRAKE CALIPER				
55B	583039	1	LEFT HAND BRAKE CALIPER				
55C	583511	1	BRAKE PAD KIT				
56	583040	2	CALIPER MOUNT BRACKET				
57	100339	8	1/2"-13 X 6" HEX BOLT (61")				
58	104261	12	1/2"-13 NYLOC NUT				
59	100273	16	5/16"-18 X 1" HEX BOLT				
60	583204	1	OIL COOLER CHANNEL				
61	582167	1	OIL COOLER MOUNT - 3 CYL				
63	100252	6	1/4"-20 3/4" HEX BOLT				
64	100300	2	3/8"-16 X 3" HEX BOLT				
66	100303	2	3/8"-16 X 4" HEX BOLT				
67	582076	1	PUMP PLATE				
68	104257	32	3/8" NYLOC NUT				
69	105260	13	3/8" FLAT WASHER				
70	823351	1	PUMP DRIVE IDLER				
71	523277	1	IDLER SPACER				
72	422025	1	TENSIONER W/BUSHING				
X	523111	X	BUSHING (SERVICE)				
73	107501	2	3/8"-16 X 2" CARRIAGE BOLT				
76	823030	2	PUMP IDLER SUPPORT				
77	583144	1	PUMP IDLER SPRING				
79	393070	1	DRIVE IDLER BUSHING				
80	100327	4	1/2"-13 X 1 1/2" HEX BOLT				
81	583444	1	OIL COOLER ADAPTER 45 DEGREE				

61" Mid-Cut Electrical Section - Gas

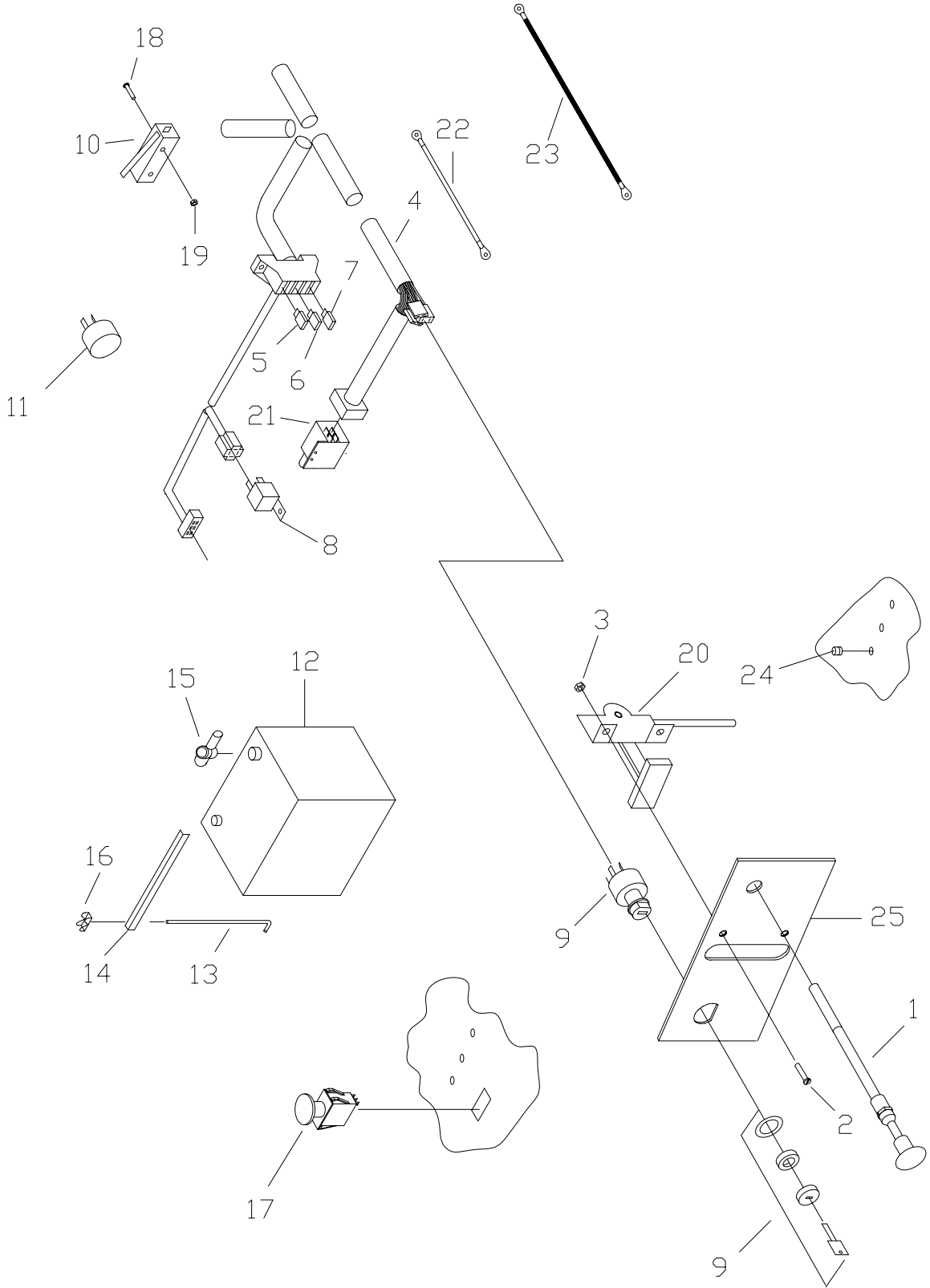

61" Mid-Cut Electrical Section - Gas

22 HP KAW
23/25 HP KAW
27 HP KAW
31 HP BRIGGS

#	PART NO.	QTY	DESCRIPTION	22 HP KAW	23/25 HP KAW	27 HP KAW	31 HP BRIGGS
1A	523037	1	CHOKE CABLE	X	X	X	
AB	583161	1	CHOKE CABLE				X
2	101039	6	#10 - 24 X 5/8" PAN HEAD BOLT				
3	104252	6	#10-24 NYLOC NUT				
4A	583212	1	WIRE HARNESS	X			
4B1	583177	1	WIRE HARNESS		X		
4B2	583495	1	ENGINE WIRE HARNESS		X		
4C	583484	1	WIRE HARNESS			X	
4D1	583277	1	WIRE HARNESS				
4D2	583276	1	ENGINE WIRE HARNESS				
4E1	583317	1	WIRE HARNESS				X
4E2	583319	1	ENGINE WIRE HARNESS				X
5	523145	1	20 AMP FUSE				
6	523146	1	15 AMP FUSE				
7	523147	1	10 AMP FUSE				
8	523042	2	RELAY				
9	423027	1	IGNITION SWITCH ASSEMBLY				
10	823193	1	NEUTRAL SWITCH				
11	823194	1	ALARM				
12	423142	1	12 VOLT BATTERY				
13	423172	2	BATTERY HOLD DOWN				
14	423011	1	BATTERY HOLD DOWN ANGLE				
15	423158	3	TERMINAL INSULATOR				
	823199	1	BATTERY BOOT - POS.				
16	109017	2	1/4"-20 WING NUT				
17	523031	1	PTO SWITCH				
18	101252	2	#5-40 X 1" SCREW				
19	104520	2	#5-40 NUT				
20A	523038	1	THROTTLE CABLE	X	X	X	
20B	583057	1	THROTTLE CABLE				X
21	523034	1	PARK BRAKE SWITCH				
22	823196	1	POSITIVE CABLE				
23	823197	1	NEGATIVE CABLE				
24	523036	3	WARNING LIGHT				
25	583030	1	BACK PLATE CONTROL PANEL				
26	423030	1	SAFETY MODULE		X	X	

**61” MID-CUT
DIESEL ENGINE
OPTION
SECTION**

61" Mid-Cut Deck Assembly

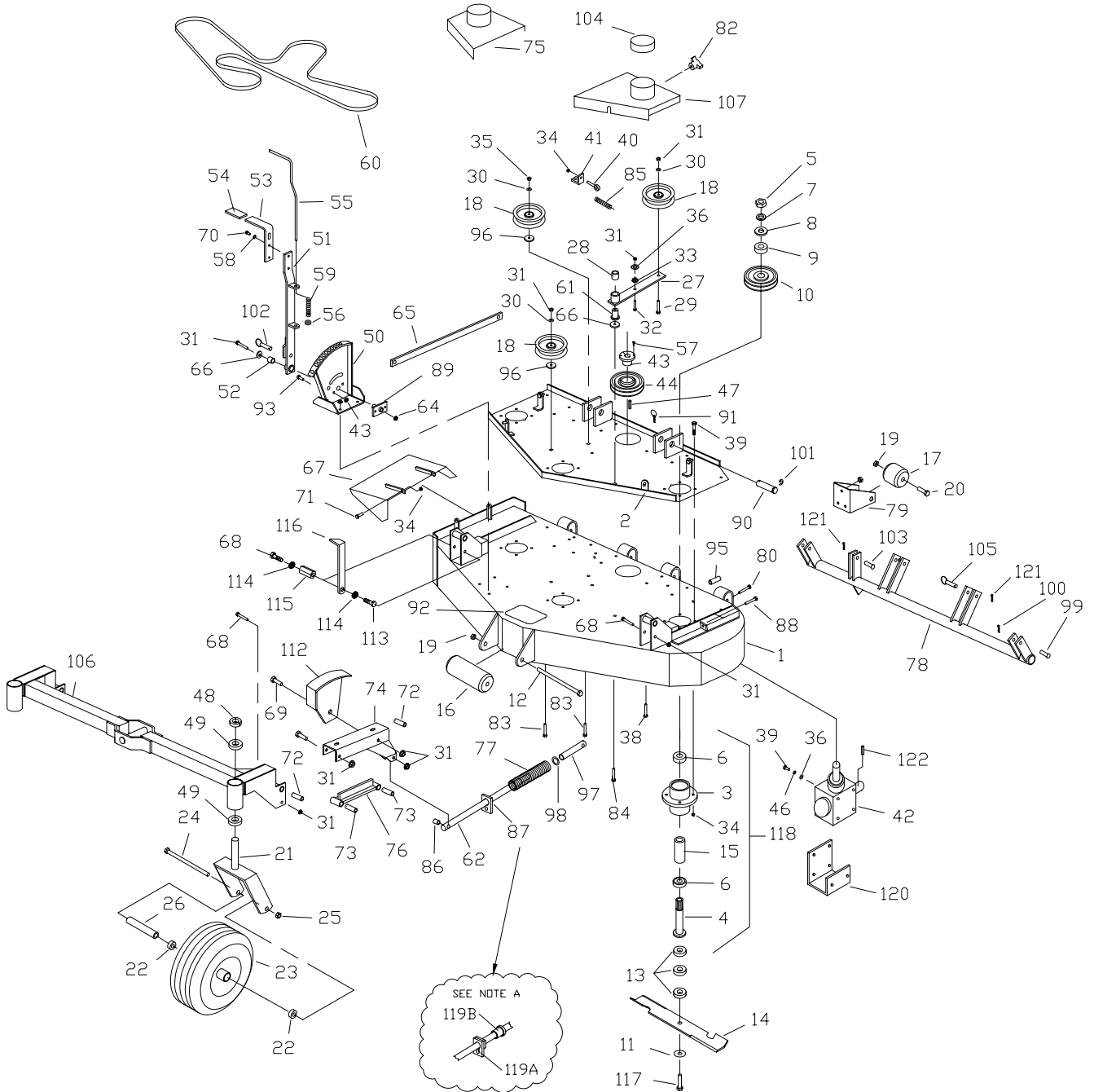

61" Mid-Cut Deck Assembly

#	PART NO.	QTY	DESCRIPTION				
1	582016	1	61" MC DECK WLDMNT				
2	582012	1	61" MC DECK CHANNEL				
3	583111	3	SPINDLE HOUSING				
4	583112	3	SPINDLE SHAFT				
5	104511	3	3/4"-16 HEX NUT				
6	363350	6	BEARING - BLADE SPINDLE				
7	105010	3	3/4" LOCK WASHER				
8	105269	3	3/4" SAE FLAT WASHER				
9	583110	3	PULLEY SPACER				
10	583107	3	SPINDLE PULLEY - 5 3/4"				
11	583108	3	5/8" SPRING DISC WASHER				
12	100351	1	5/8"-11 X 8 1/2" HEX BOLT				
13	583109	9	BLADE SPACER				
14	823006	3	21.0" HI LIFT BLADE				
15	583113	3	BEARING SPACER TUBE				
16	603023	1	ANTI-SCALP ROLLER				
17	523084	2	REAR DECK ROLLER				
18	523329	3	FLTG. IDLER - FLAT				
19	104261	3	5/8"-11 NYLOC NUT				
20	100346	2	5/8"-11 X 4 1/2" HEX BOLT				
21	822088	2	WIDE TAIL WHEEL STRUT				
22	363187	4	1" BEARING				
23	823220	2	WIDE TIRE ASSY (COMPLETE)				
23A	823339	X	TIRE (13 X 6.5 X 6)				
23B	823338	X	FRONT RIM W/ VALVESTEM				
24	100352	2	5/8"-11 X 9" HEX BOLT				
25	104261	2	5/8"-11 NYLOC NUT				
26	823245	2	AXLE TUBE				
27	822144	1	DECK IDLER ARM W/BUSHING				
28	363007	1	3/4 FLNG. BUSHING				
29	107511	1	3/8"-16 X 2" CARRIAGE BOLT				
30	105260	8	3/8" FLAT WASHER				
31	104257	16	3/8"-16 NYLOC NUT				
32	100275	1	5/16"-18 X 1 1/2" HEX BOLT				
33	109001	2	5/16"-18 WHIZLOCK NUT				
34	104256	36	5/16"-18 NYLOC NUT				
35	109007	2	3/8"-16 WHIZLOCK NUT				
36	105258	9	5/16" FLAT WASHER				
37	107503	10	5/16"-18 X 3/4" CARRIAGE BOLT				
38	107509	5	5/16"-18 X 1" CARRIAGE BOLT				
39	100274	12	5/16"-18 X 1 1/4" HEX BOLT				
40	363080	1	RIGHT EYE BOLT				
41	523094	1	SPRING MT.-DECK				
42	583087	1	DECK - GEAR BOX				
43	523371	1	3/4" TAPER HUB				
44	523096	1	5" TAPERED PULLEY				
46	105005	4	5/16" LOCK WASHER				
47	107255	1	3/16" X 1" KEY				
48	363145	2	1" CLAMP COLLAR				
49	363187	2	1" FLANGE BEARING				

61" Mid-Cut Deck Assembly

#	PART NO.	QTY	DESCRIPTION				
50	582021	1	HEIGHT ADJUSTMENT BRACKET				
51	822141	1	DECK HEIGHT BAR W/BUSHING				
52	253059	1	ENGAGEMENT BUSHING				
53	822062	1	DECK HEIGHT HANDLE W/GRIP				
54	823312	1	GRIP				
55	823149	1	HANDLE ROD				
56	823093	1	3/8" CLAMP COLLAR				
57	100252	6	1/4"-20 X 3/4" HEX BOLT				
58	105004	2	1/4" LOCK WASHER				
59	523028	1	ASSIST SPRING				
60	823242	1	61" DECK BELT				
61	423175	1	PUMP IDLER PIVOT				
62	823155	2	CASTER ROD				
64	100297	1	3/8"-16 X 2 1/4" HEX BOLT				
65	582063	1	LIFT ARM WELDMENT				
66	373089	1	3/8 STD RETAINING WASHER				
67	582025	1	GRASS DEFLECTOR - 61				
68	100300	4	3/8"-16 X 3" HEX BOLT				
69	100301	4	3/8"-16 X 3 1/4" HEX BOLT				
70	100251	2	1/4"-20 X 5/8" HEX BOLT				
71	100273	2	5/16"-18 X 1" HEX BOLT				
72	823330	4	CASTER ARM PIVOT				
73	823090	4	CASTER BAR PIVOT				
74A	582053	1	LEFT HAND CASTER ARM				
74B	582051	1	RIGHT HAND CASTER ARM				
75	582055	1	RIGHT HAND BELT SHIELD				
76	582059	2	CASTER BAR WELDMENT				
77	823150	2	HEAVY COMPRESSION SPRING				
78	822124	1	61" DECK TUBE WELDMENT				
79	583074	2	ROLLER MOUNT				
80	100298	2	3/8"-16 X 2 1/2" HEX BOLT				
82	753028	4	KNOB				
83	107516	2	3/8"-16 X 2 1/4" CARRIAGE BOLT				
84	107513	3	3/8"-16 X 3" CARRIAGE BOLT				
85	593074	1	SPRING - FLTG. IDLER				
86	823153	2	CASTER ROD SPACER				
87	823159	2	SPRING SLIDE				
88	100030	2	3/8"-16 X 3" TAP BOLT				
89	822132	1	DECK HEIGHT PIVOT				
90	823333	2	DECK ATTACH PIN				
91	108001	3	3/16" QUICK PIN				
92	823200	1	STEP TREAD				
93	107502	2	1/4"-20 X 3/4" CARRIAGE BOLT				
94	104255	2	1/4"-20 NYLOC NUT				
95	823314	2	TUBE SADDLE SPACER				
96	483017	2	RIGHT HAND IDLER SPACER				
97	823157	2	CASTER ROD END				
98	109025	2	5/8" HEAVY WASHER				
99	823210	2	1/2" X 2" CLEVIS PIN				

61" Mid-Cut Deck Assembly

#	PART NO.	QTY	DESCRIPTION				
100	106763	2	1/8" COTTER PIN				
101	108510	4	7/8" E-RING				
102	109026	1	1/2" X 2" DETENT PIN				
103	823209	1	1/2" X 1 1/2" CLEVIS PIN				
104	363161	2	BELT SHIELD CAP				
105	823211	2	1/2" X 2 1/2" RING PIN				
106	582010	1	FRONT AXLE				
107	582057	1	LEFT HAND BELT SHIELD				
112	582176	1	CUT GAGE WELDMENT				
113	100291	1	3/8"-16 X 3/4" HEX BOLT				
114	105006	2	3/8" LOCK WASHER				
115	583422	1	NUT - CUT GAGE				
116	583420	1	POINTER - CUT GAGE				
117	100358	3	5/8"-11 X 2 1/4" HEX BOLT				
118	583106	3	BLADE SPINDLE ASSY				
119A	592006	1	SPRING RETAINER				
119B	363007	1	FLANGE BUSHING				
120	593096	1	GEAR BOX TRUSS				
121	106778	2	3/16 X 1 1/2" COTTER PIN				
122	107255	1	KEY - 3/16" X 1"				

NOTES:

- A PREFORMANCE UPGRADE FOR DECK SPRING ASSY. REQUIRES ITEM 119.
BOTH SIDES NEED BE UPGRADED AT THE SAME TIME.

61" Mid-Cut Mainframe Assembly

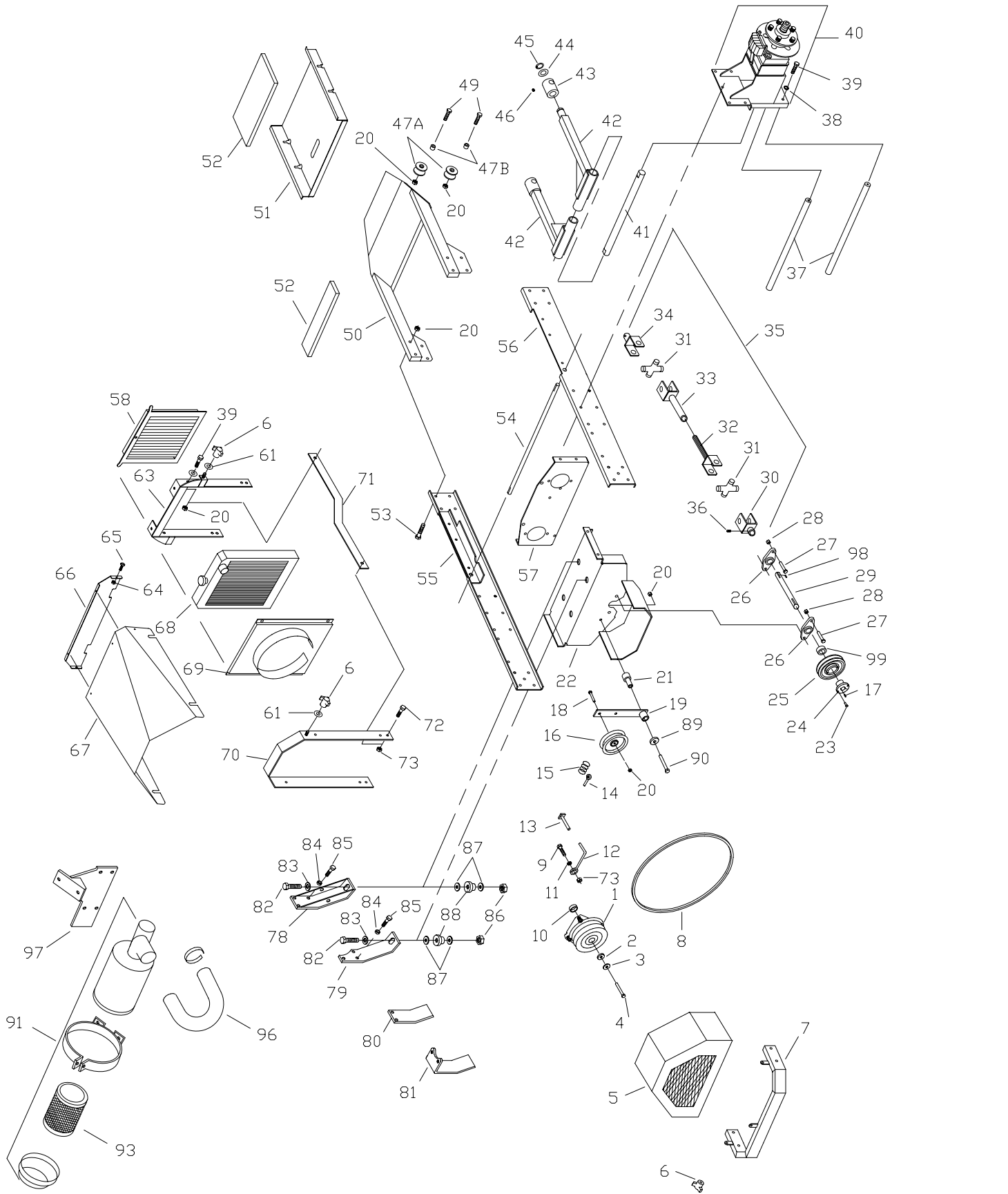

61" Mid-Cut Mainframe Assembly

#	PART NO.	QTY	DESCRIPTION
1	583308	1	CLUTCH - 200 FT/LBS
2	373089	1	RETAINER WASHER
3	423069	2	7/16" SPRING DISC WASHER
4	100534	1	7/16"-20 X 1 1/4" HEX BOLT
5	582157	1	CLUTCH COVER - IL3
6	753028	7	KNOB
7	582132	1	ENGINE GUARD
8	523374	1	CLUTCH BELT
9	100273	16	5/16"-18 X 1" HEX BOLT
10	823248	2	CLUTCH SPACER 9/32
11	105258	6	5/16" FLAT WASHER
12	363075	1	ROUND BELT GUIDE
13	582169	1	CLUTCH STOP
14	363080	1	RIGHT EYE BOLT
15	593074	1	IDLER SPRING HH
16	483025	1	RIGHT HAND IDLER PULLEY
17	107259	1	1/4" X 1/4" X 1" KEY
18	100294	6	3/8"-16 X 1 1/2" HEX BOLT
19	422025	1	TENSIONER W/BUSHING
	523111	X	BUSHING (SERVICE)
20	104257	32	3/8"-16 NYLOC NUT
21	823030	1	PUMP IDLER SUPPORT
22	582165	1	ENGINE BASE 26 DSL MC
23	100503	2	1/4" X 3/4" HEX BOLT
24	363215	1	TAPER LOCK HUB
25	363216	1	TAPER LOCK SHEAVE
26	823032	2	2-BOLT FLANGE BEARING
27	100311	4	7/16"-14 X 1 1/4" HEX BOLT
28	104258	4	7/16"-14 NYLOC NUT
29	583271	1	POWER SHAFT - MC - DSL
30	523414	1	1" YOKE
31	523415	2	CROSS & BEARING
32	593075	1	YOKE SHAFT
33	583481	1	YOKE TUBE
34	823372	1	3/4" YOKE
35	593064	1	DRIVE SHAFT MC
36	103295	2	3/8"-16 X 1/2" SET SCREW
37	823066	2	BRACE ROD - LOWER
38	105006	6	3/8" LOCK WASHER
39	100292	23	3/8"-16 X 1" HEX BOLT
40			SEE HYDRAULIC ILLUSTRATION
41	823050	1	DECK ARM SHAFT
42	822036	2	DECK ARM
43	822090	2	DECK SWIVEL W/ZERK
44	823015	4	DECK ARM WASHER
45	108502	2	SNAP RING
46	111004	12	1/4"-28 GREASE ZERK
47	583464	2	FRONT ROLLER - MC
47A	583464	2	FRONT ROLLER
47B	583490	2	FRONT ROLLER TUBE

61" Mid-Cut Mainframe Assembly

#	PART NO.	QTY	DESCRIPTION
49	100298	2	3/8"-16 X 2 1/2" HEX BOLT
50	582006	1	FRONT FRAME
51	582029	1	FOOT PLATE
52	583374	1	FOOT REST PAD LARGE
52	583373	1	FOOT REST PAD SMALL
53	100295	4	3/8"-16 X 1 3/4" HEX BOLT
54	823140	1	PARK SHAFT
55	582124	1	LEFT HAND FRAME RAIL
56	582126	1	RIGHT HAND FRAME RAIL
57			SEE HYDRAULIC ILLUSTRATION
58	583301	1	RADIATOR SCREEN
61	105260	13	3/8" FLAT WASHER
63	582159	1	RADIATOR MOUNT
64	104252	15	#10-24 NYLOC NUT
65	101039	17	#10-24 X 5/8" SCREW
66	583010	1	FRONT ENGINE COVER - IL3
67	583296	1	ENGINE COVER
68	SEE NOTE A	1	RADIATOR ASSY.
69	583476	1	FAN SHROUD
70	582161	1	HOOD BRACE
71	583356	2	HOOD SIDE BRACE
72	100271	4	5/16"-18 X 3/4" HEX BOLT
73	104256	5	4/16"-18 NYLOC NUT
78	583250	2	ENGINE MOUNT FRONT
79	582116	2	ENGINE MOUNT - 3 CYL.
80	582151	1	FUEL PUMP MOUNT
81	582134	1	FUEL FILTER MOUNT
82	100327	4	1/2"-13 X 1 1/2" HEX BOLT
83	105264	4	1/2" FLAT WASHER
84	105005	6	5/16" LOCK WASHER
85	109031	6	M8-1.25 X 20MM HEX BOLT
86	104259	4	1/2"-13 NYLOC NUT
87	583478	8	WASHER-ISO MOUNT
88	583303	4	ISO BUSHING
89	373089	1	RETAINING WASHER
90	100300	2	3/8"-16 X 3" HEX BOLT
91	583364	1	AIR CLEANER ASSY 90 DEGREE
93	583298	1	AIR FILTER ELEMENT
96	583369	1	AIR FILTER HOSE U-SHAPE
97	582153	1	AIR FILTER MOUNT
98	107258		POWER SHAFT KEY
99	363145	1	1" CLAMP COLLAR

NOTE:

A CONTACT ENGINE MFG FOR ALL ENGINE & RADIATOR PARTS SHOWN. **ENCORE MFG DO NOT SERVICE THESE PARTS!**

61" Mid-Cut Seatframe Assembly

#	PART NO.	QTY	DESCRIPTION
1	583154	2	FUEL TANK - MC
2	393042	4	GROMMET
3	583183	4	FUEL TANK ADAPTER
4	523283	1	HOUR METER
5	523278	2	SEAT SPRING
6	583438	2	ADJUSTMENT PLATE
7	104752	4	5/16"-24 JAM NUT
8	823221	4	10MM BALL STUD
9	583415	2	DAMPENER CONTROL
10	583046	2	BACK PLATE TAB
11	153045	2	5/16" PUSH NUT
12A	583065	1	RIGHT FENDER
12B	583064	1	LEFT FENDER
14	363165	1	HAIR PIN COTTER
15	523044	1	SEAT CABLE
16	523105	1	SEAT HINGE
17A	582110	1	LEFT HAND PIVOT W/BUSHING
17B	582109	1	RIGHT HAND PIVOT W/BUSHING
18	253059	2	ENGAGEMENT BUSHING
19	822054	1	SEAT FRAME WELDMENT
20	583028	1	FRONT - SEAT FRAME
21	822058	1	SEAT PLATE
22	373089	2	RETAINING WASHER
23	523222	2	CONTROL LEVER ANG.E
24	582048	1	PARK LEVER W/GRIP
25	363105	1	IDLER BUSHING
26	583140	1	PUMP CONTROL LINK - LH
27	453082	2	5/16"-24 ROD END - MALE
28	423160	2	5/16" ROD END MALE
29	583138	1	PUMP CONTROL LINK - RH
30	823132	1	PARK BRAKE LINK
31	363029	2	5/16" ROD SWIVEL
32A	582084	1	LH NEUTRAL LOCK PIVOT
32B	582082	1	RH NEUTRAL LOCK PIVOT
33	822075	2	DRIVE BLOCK W/ZERK
34	111004	2	1/4"-24 ZERK
35	363024	4	COMPRESSION SPRING
36	104259	4	1/2"-13 NYLOC NUT
37	105264	2	1/2" FLAT WASHER
38	100275	2	5/16"-18 X 1 1/2" HEX BOLT
39	109001	8	5/16"-18 WHIZLOCK NUT
40	105260	6	3/8" FLAT WASHER
41	109015	8	1/4"-20 NUT CLIP
42	583463	2	DIESEL FUEL CAP - LARGE
43	583302	1	FUEL VALVE - DIESEL
44	101039	5	#10-28 X 5/8" SCREW
45	104252	4	#10-28 NYLOC NUT
46	103004	2	1/4"-14 X 3/4" SCREW
47	102000	7	#12-24 CUTTING SCREW
48	100252	8	1/4"-20 X 3/4" HEX BOLT

61" Mid-Cut Seatframe Assembly

#	PART NO.	QTY	DESCRIPTION
49	100004	8	1/4"-20 X 1" HEX BOLT
50	109000	8	1/4"-20 WHIZLOCK NUT
51	100271	8	5/16"-18 X 3/4" HEX BOLT
52	100273	2	5/16"-18 X 1" HEX BOLT
53	583091	2	ARM REST PAD KIT
53A	583242	1	ARM REST PAD - LEFT
53B	583243	1	ARM REST PAD - RIGHT
54	104256	20	5/16"-24 NYLOC NUT
55	523030	1	SEAT SWITCH
56	363113	4	WHEEL PULLEY SPACER
57	105258	11	5/16" FLAT WASHER
58	583089	1	SEAT CUSHION
59	583090	1	BACK CUSHION
60	100274	2	5/16"-18 X 1 1/4" HEX BOLT
61	583077	1	SEAT
62	523033	2	HANDLE PLUG
63	100303	1	3/8"-16 X 4" HEX BOLT
64	100305	2	3/8"-16 X 4 1/2" HEX BOLT
65	104257	3	3/8"-16 NYLOC NUT
66	523032	2	HANDLE GRIP
67	363201	4	TANK PAD
68	523017	2	HANDLE
68A	522100	X	HANDLE ASSY W/GRIP (COMPLETE)
69	363098	10	FUEL LINE CLAMP
70A	583054	1	TANK BACK PLATE - LH
70B	583052	1	TANK BACK PLATE - RH
71A	582065	1	FUEL TANK SADDLE LEFT HAND
71B	582045	1	FUEL TANK SADDLE RIGHT HAND
72A	583186	1	FUEL LINE LEFT HAND
72B	583185	1	FUEL LINE RIGHT HAND
73	583037	1	CONTROL PANEL
74A	583254	1	RIGHT HAND LEVER LOCK
74B	583256	1	LEFT HAND LEVER LOCK
75	104255	2	1/4"-20 NYLOC NUT
76	107520	2	5/16"-18 X 3/4" HEX BOLT
78	583401	1	BATTERY MOUNT-31 GAS/27 DIESEL ONLY

61" Mid-Cut Large Hydro Pump Assembly

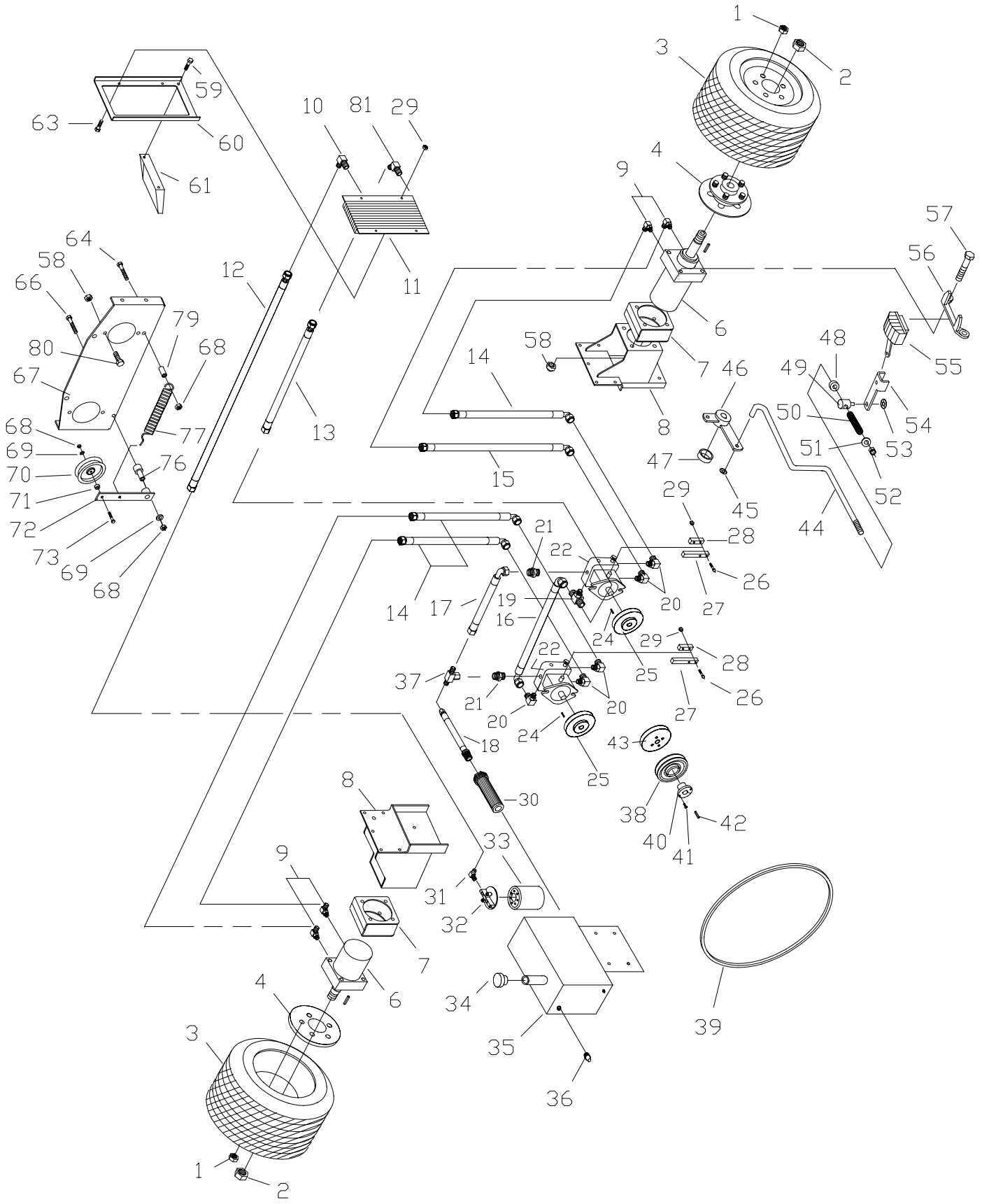

61" Mid-Cut Large Hydro Pump Assembly

#	PART NO.	QTY	DESCRIPTION
1	103023	10	1/2" LUG NUT
2	104511	2	3/4"-16 HEX NUT
3	583055	2	DRIVE WHEEL ASSY
3A	583059	X	DRIVE TIRE (24 X 12 X 12)
3B	583487	X	BAR LUG TIRE (23 X 10.5 X 12)
3C	583058	X	RIM W/ VALVESTEM
4	582008	2	WHEEL HUB
6	583022	2	LARGE WHEEL MOTOR - MP24
6A	583520	X	SEAL KIT - MP24
7	582031	2	MOTOR SPACER
8A	582002	1	RIGHT HAND MOTOR MOUNT
8B	582004	1	LEFT HAND MOTOR MOUNT
9	523058	4	RETURN ADPT.
10	583214	2	OIL COOLER ADAPTER
11	583201	1	OIL COOLER
12	583216	1	COOLER TO FILTER HOSE
13	583215	1	PUMP TO COOLER HOSE
14	583376	3	21" HOSE
15	583375	1	26 3/4" HOSE
16	583124	1	PUMP TO PUMP RETURN HOSE
17	583131	1	PUMP TO PUMP SUPPLY HOSE
18	583130	1	TANK TO PUMP SUCTION HOSE
19	583127	1	SUPPLY TEE
20	453113	5	PUMP ELBOW
21	583126	2	STRAIGHT ADAPTER
22	583081	2	LARGE V-PUMP (BDP-21LH)
22A	583377	X	PUMP SEAL KIT - 21L
24	453102	2	PUMP KEY (5MM)
25	583092	2	PUMP PULLEY
26	100257	4	1/4"-20 X 1 3/4" HEX BOLT
27	823104	2	PUMP CONTROL BAR
28	453090	2	CLAMP BAR
29	104255	6	1/4"-20 NYLOC NUT
30	583132	1	SUCTION SCREEN
31	583129	1	FILTER ADAPTER
32	423064	1	FILTER HEAD
33	423063	1	OIL FILTER
34	423165	1	OIL BREATHER CAP
35	583049	1	OIL TANK
36	423065	1	OIL EYE
37	523128	1	TENSIONER SWIVEL
38	583217	1	PUMP DRIVE PULLEY (ENGINE)
39	823026	1	PUMP BELT
40	363215	1	TAPER LOCK HUB
41	100252	2	1/4"-20 X 3/4" HEX BOLT
42	107258	2	1/4" X 1/4" X 3/4" KEY
43	583274	1	FRONT DRIVE ADAPTER
44A	583042	1	RIGHT HAND BRAKE ROD
44B	583044	1	LEFT HAND BRAKE ROD
45	153045	3	5/16" PUSH NUT

61" Mid-Cut Large Hydro Pump Assembly

#	PART NO.	QTY	DESCRIPTION
46	422049	1	BRAKE CRANK
47	373086	1	BLADE SPACER
48	523112	2	5/16" CLAMP COLLAR
49	423130	2	PARK BRAKE SWIVEL
50	523024	2	DECK DR. SPRING
51	105258	2	5/16" FLAT WASHER
52	104256	20	5/16" NYLOC NUT
53	363177	2	3/8" PUSH NUT
54	583190	2	BRAKE ARM
55A	583038	1	RIGHT HAND BRAKE CALIPER
55B	583039	1	LEFT HAND BRAKE CALIPER
55C	583511	1	BRAKE PAD KIT
56	583040	2	CALIPER MOUNT BRACKET
57	100339	8	1/2"-13 X 6" HEX BOLT (61")
58	104261	12	1/2"-13 NYLOC NUT
59	100273	16	5/16"-18 X 1" HEX BOLT
60	583204	1	OIL COOLER CHANNEL
61	582167	1	OIL COOLER MOUNT - 3 CYL
63	100252	6	1/4"-20 3/4" HEX BOLT
64	100300	2	3/8"-16 X 3" HEX BOLT
66	100303	2	3/8"-16 X 4" HEX BOLT
67	582076	1	PUMP PLATE
68	104257	32	3/8" NYLOC NUT
69	105260	13	3/8" FLAT WASHER
70	823351	1	PUMP DRIVE IDLER
71	523277	1	IDLER SPACER
72	422025	1	TENSIONER W/BUSHING
X	523111	X	BUSHING (SERVICE)
73	107501	2	3/8"-16 X 2" CARRIAGE BOLT
76	823030	2	PUMP IDLER SUPPORT
77	583144	1	PUMP IDLER SPRING
79	393070	1	DRIVE IDLER BUSHING
80	100327	4	1/2"-13 X 1 1/2" HEX BOLT
81	583444	1	OIL COOLER ADAPTER 45 DEGREE

61" Mid-Cut Small Hydro Pump Assembly

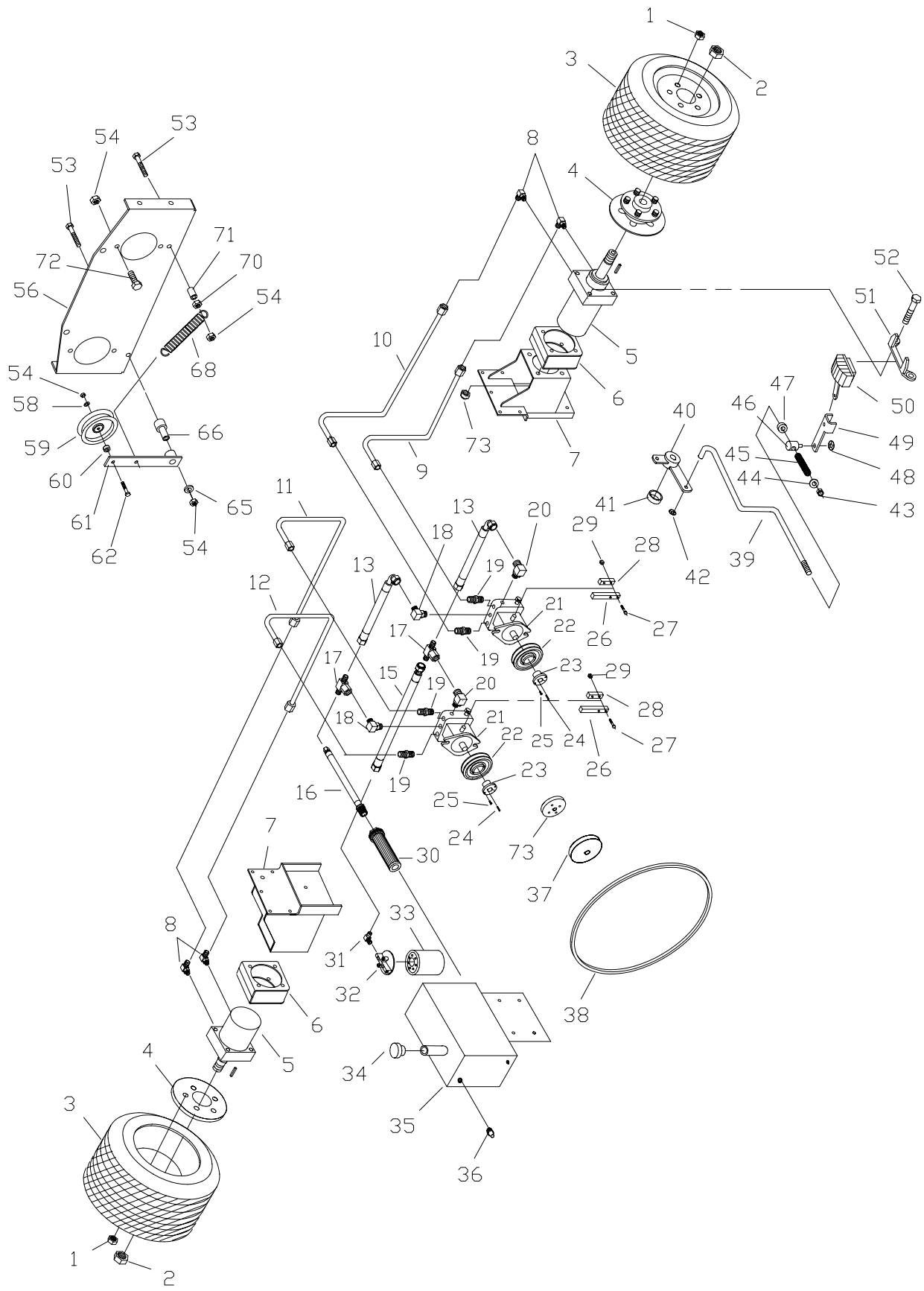

61" Mid-Cut Small Hydro Pump Assembly

#	PART NO.	QTY	DESCRIPTION
1	103023	10	LUG NUT
2	104511	2	WHEEL NUT
3	583055	2	DRIVE WHEEL (COMPLETE)
3A	583059	X	DRIVE TIRE (24 X 12 X 12)
3B	583487	X	BAR LUG TIRE (23 X 10.5 X 12)
3C	583058	X	RIM W/ VALVESTEM
4	582008	2	WHEEL HUB
5	583325	2	WHEEL MOTOR - MP14
5A	583520	X	SEAL KIT - MP14
6	582031	2	MOTOR SPACER
7	582002	1	RIGHT HAND MOTOR MOUNT
7	582004	1	LEFT HAND MOTOR MOUNT
8	523058	4	90 DEGREE MOTOR ADAPTER
9	583397	1	RIGHT HAND OUTSIDE LINE(61")
10	583396	1	RIGHT HAND INSIDE LINE(61")
11	583398	1	LEFT HAND INSIDE LINE(61")
12	583399	1	LEFT HAND OUTSIDE LINE(61")
13	583241	2	PUMP TO PUMP HOSE
15	423126	1	PUMP TO FILTER HOSE(61")
16	453129	1	PUMP TO TANK SUPPLY HOSE
17	453106	2	SWIVEL TEE
18	583391	2	90 DEGREE INLET ADAPTER
19	583126	4	STRAIGHT ADAPTER
20	453074	2	90 DEGREE ADAPTER
21	453087	2	PUMP-10L
21A	453146	X	PUMP SEAL KIT - 10L
22	583382	2	PUMP PULLEY
23	423178	2	15 MM TAPER HUB
24	453102	2	PUMP KEY
25	100252	2	1/4"-20 X 3/4" HEX BOLT
26	823104	2	CONTROL BAR
27	100257	4	1/4"-20 X 1 3/4" HEX BOLT
28	453090	2	CLAMP BAR
29	104255	6	1/4"-20 NYLOC NUT
30	583132	1	SUCTION SCREEN
31	583442	1	FILTER ADAPTER(61")
32	423064	1	FILTER HEAD
33	423063	1	HYDRO OIL FILTER (NO CROSS REF AVAIL)
34	423165	1	OIL BREATHER CAP(61")
35	583049	1	OIL TANK(61")
36	423065	1	OIL EYE
37	583217	1	PUMP PULLEY
38	583385	1	PUMP BELT SML PUMP
39A	583042	1	RIGHT HAND BRAKE ROD(61")
39B	583044	1	LEFT HAND BRAKE ROD(61")
40	422049	1	BRAKE CRANK
41	373086	1	BLADE SPACER
42	104256	6	5/16" PUSH NUT
43	104256	20	5/16" NYLOC NUT
44	105258	2	5/16" FLAT WASHER

61" Mid-Cut Small Hydro Pump Assembly

#	PART NO.	QTY	DESCRIPTION
45	523024	2	DECK DR. SPRING
46	423130	2	PARK BRAKE SWIVEL
47	523112	2	5/16" CLAMP COLLAR
48	363177	2	3/8" PUSH NUT
49	583190	2	BRAKE ARM
50A	583038	1	RIGHT HAND BRAKE CALIPER
50B	583039	1	LEFT HAND BRAKE CALIPER
50C	583511	X	BRAKE PAD KIT
51	583040	2	CALIPER MOUNT
52	100339	8	1/2"-13 X 6" HEX BOLT
53	100300	2	3/8"-16 X 3" HEX BOLT
54	104257	32	3/8" NYLOC NUT
56	583328	1	PUMP PLATE -MCBDP10
58	105260	13	3/8" FLAT WASHER
59	823351	1	PUMP DRIVE IDLER
60	523277	1	IDLER SPACER
61	422025	1	TENSIONER W/BUSHING
X	523111	X	BUSHING (SERVICE)
62	107501	2	3/8"-16 X 2" CARRIAGE BOLT
65	373089	2	RETAINING WASHER
66	423175	1	IDLER PIVOT
68	583144	1	PUMP IDLER SPRING
70	109007	2	3/8"-16 WHIZLOCK NUT
71	393070	1	IDLER SPACER
73	583274	1	FRONT DRIVE ADAPTER

61" Mid-Cut Electrical Section - Diesel

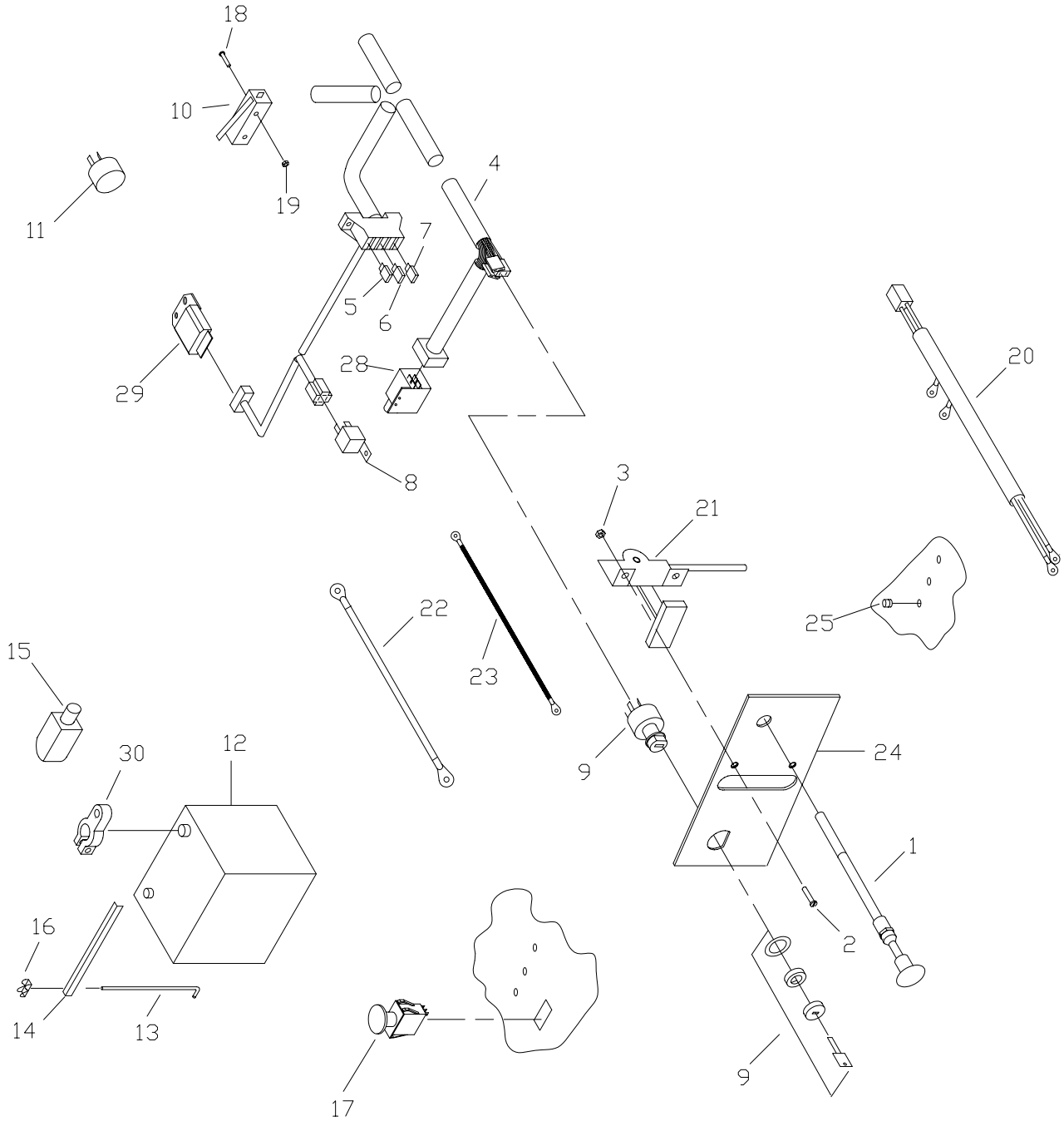

61" Mid-Cut

Electrical Section - Diesel

#	PART NO.	QTY	DESCRIPTION
1	X	0	CHOKE CABLE (NOT INSTALLED)
2	101039	6	#10-24 X 5/8" PAN HEAD BOLT
3	104252	6	#10-24 NYLOC NUT
4	583277	1	WIRE HARNESS - 950D-MC
5	583502	1	30 AMP FUSE
6	523146	1	15 AMP FUSE
7	523147	1	10 AMP FUSE
8	523042	3	RELAY
9	423027	1	IGNITION SWITCH ASSEMBLY
10	363164	1	BLADE SWITCH
11	823194	1	ALARM
12	523050	1	12 VOLT BATTERY
13	423172	2	BATTERY HOLD DOWN
14	583403	1	BATTERY ANGLE - IL3
15	583409	1	POSITIVE BATTERY BOOT
16	109017	2	1/4"-20 WING NUT
17	523031	1	PTO SWITCH
18	101252	2	#5-40 X 1" SCREW
19	104520	2	#5-40 NUT
20	583276	1	ENGINE WIRE HARNESS DSL
21	583057	1	THROTTLE CONTROL
22	823196	1	POSITIVE CABLE
23	823197	1	NEGATIVE CABLE
24	583037	1	CONTROL PANEL
25	523036	3	WARNING LIGHT
26	583411	1	ELECTRIC LIFT SWITCH
27	583412	1	ELECTRIC LIFT HARNESS
28	523034	1	PARK SWITCH
29	583423	1	TIME DELAY MODULE
30	583429	2	BATTERY TERMINAL

52-61" Mid-Cut Decals



1

ENCORE

2,3,4

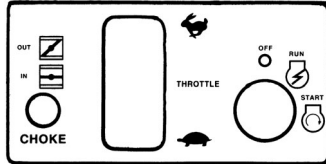

8



5

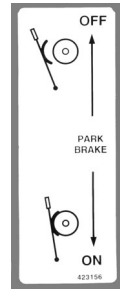

6

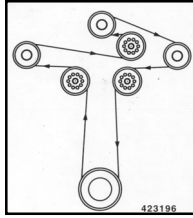

7



9

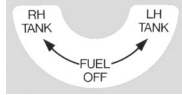

12

PROWLER

14,21

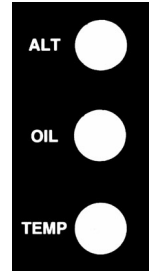

10

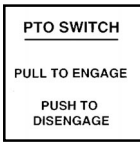

11

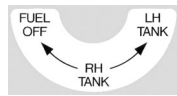

17

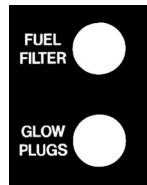

18

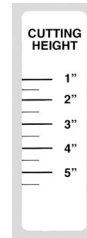

19



15

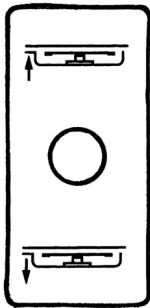

16



23



24



20

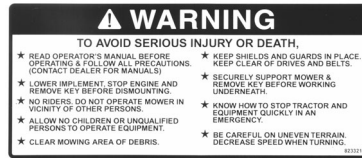

25



26

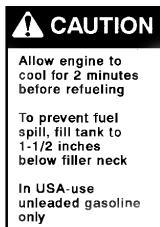

22



28



29



27



30



31

52" & 61" Mid-Cut Decal List

#	PART NO.	DESCRIPTION
1	363023	DANGER DECAL
2	363231	LARGE ENCORE LABEL
3	363243	ENCORE DECAL
4	363265	SMALL ENCORE LABEL
5	423155	RIDER CAUTION DECAL
6	423156	PARK LEVER DECAL
7	423196	BELT ROUTING DECAL
8	423197	CONTROL DECAL
9	453010	OIL DECAL
10	523020	LIGHT DECAL
11	523021	PTO DECAL
12	583023	LABEL – FUEL VALVE - GAS
13	583076	PROWLER DECAL (Large Cat Decal)
14	583088	PROWLER - BLK DECAL
15A	523493	PRO-52" DECAL
15B	583192	PRO-61" DECAL
16	583232	DECAL – UP- DOWN
17	583280	FUEL VALVE LABEL – DSL
18	583372	GLOW PLUG DECAL
19	583416	CUT GAGE DECAL
20	583441	DIESEL LABEL
21	583443	PROWLER DECAL - RED
22	823318	FUEL TANK DECAL
23	823319	TIP OVER – WARNING
24	823320	BATTERY - WARNING DECAL
25	823321	OPERATING - WARNING
26	823322	ROTATING PARTS – DANGER
27	823323	ROTATING PARTS - WARNING
28	823324	SHIELD - DANGER
29	823325	THROWN OBJECTS - DANGER
30	823326	DISCHARGE - WARNING
31	823327	DISCHARGE - DANGER

**PROWLER
MID-CUT
ELECTRICAL
SCHEMATIC
SECTION**

52-61" Mid-Cut Electrical Schematics

583177 WIRE HARNESS
ELECTRICAL DRAWING

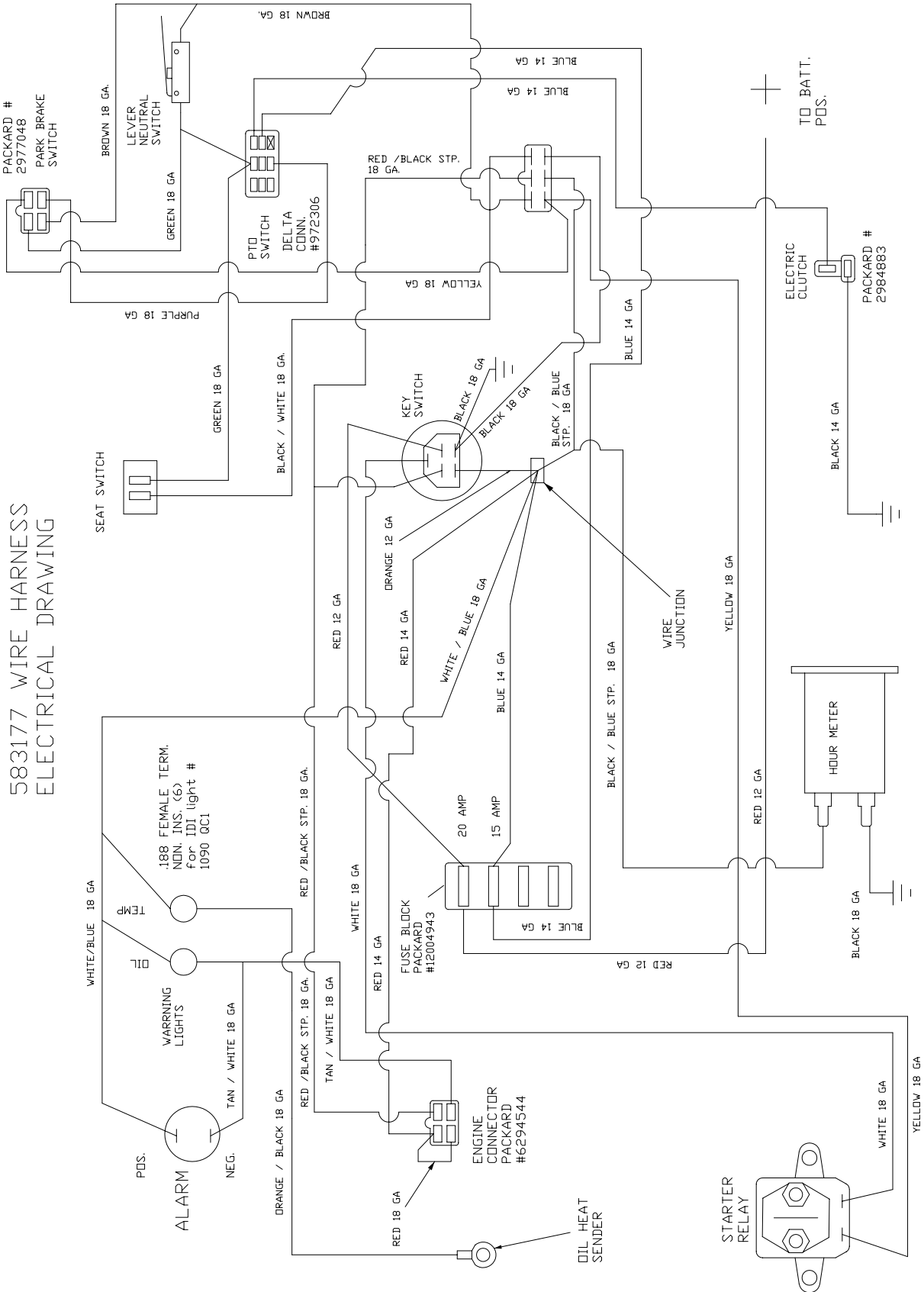

52-61" Mid-Cut Electrical Schematics

ENCORE MFG. CO., INC.
 583276 ENGINE WIRE
 HARNESS
 1 REQD./ 950D
 - electrical diagram -

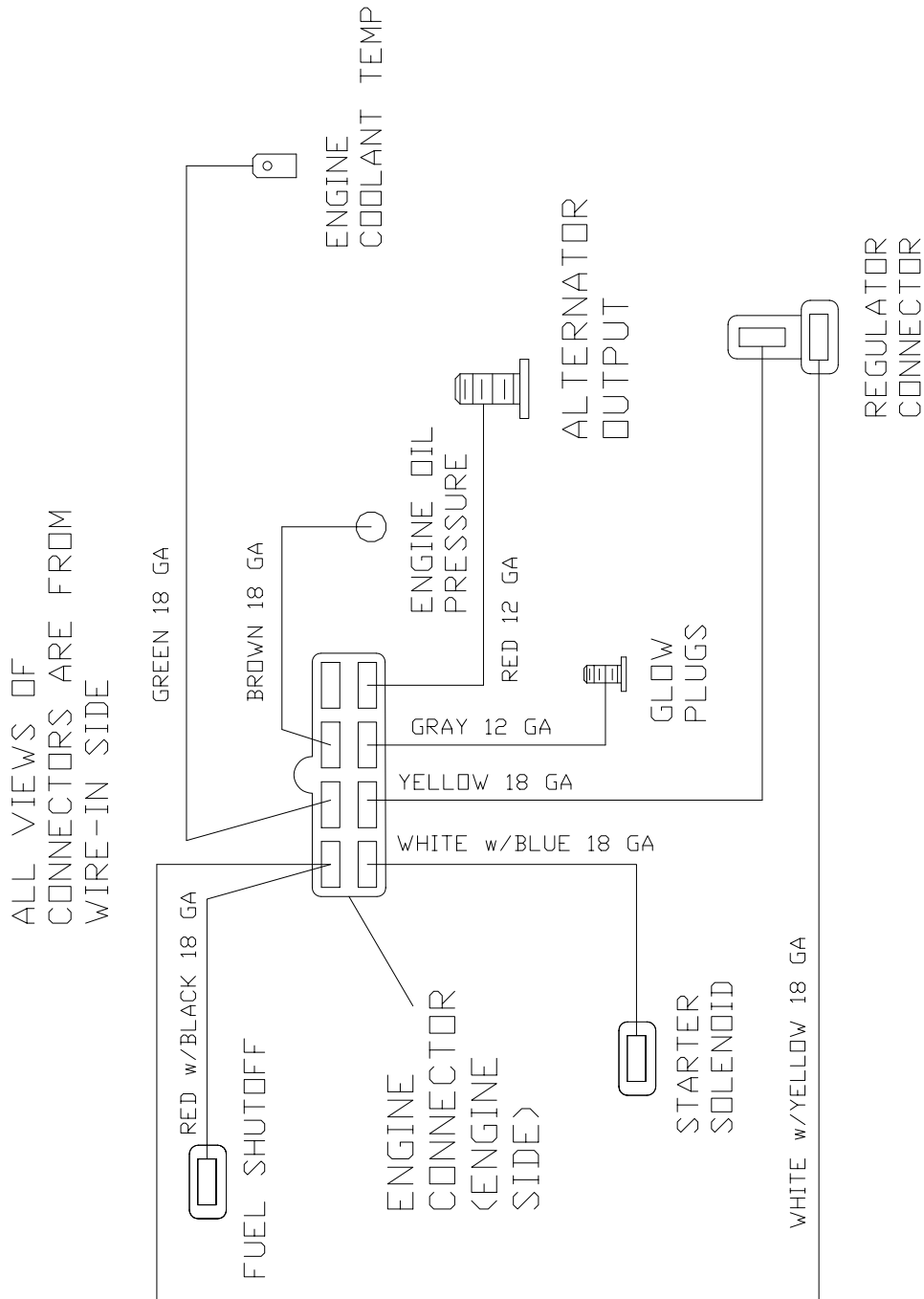

ENCORE MFG. CO., INC.
 583276 ENGINE WIRE
 HARNESS
 1 REQD./ 950D
 - electrical diagram -

52-61" Mid-Cut Electrical Schematics

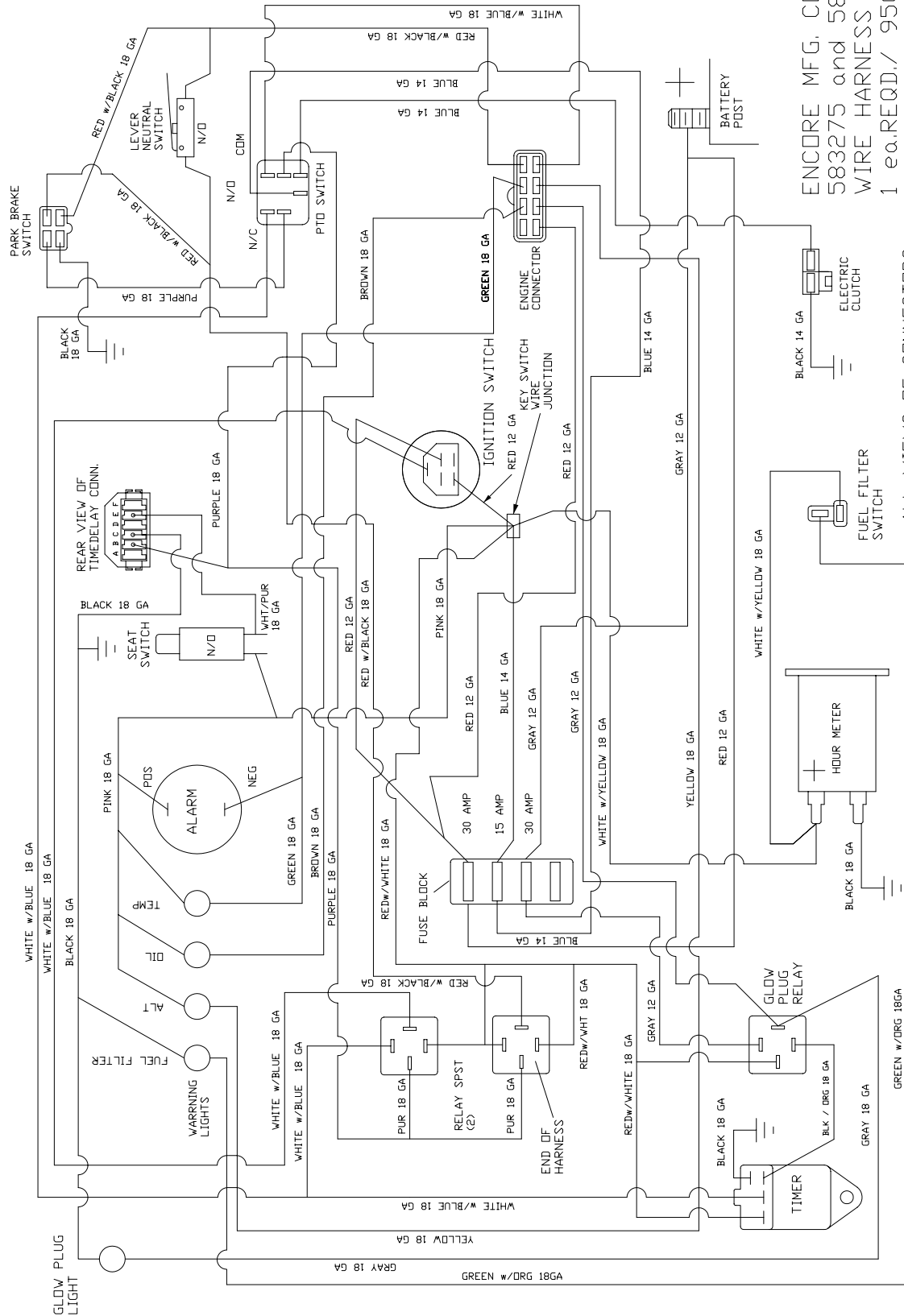

ENCORE MFG. CO., INC.
 583275 and 583277
 WIRE HARNESS
 1 ea. REQD./ 950D FC & MC
 - electrical diagram -

ALL VIEWS OF CONNECTORS
 ARE FROM WIRE-IN SIDE

52-61" Mid-Cut Electrical Schematics

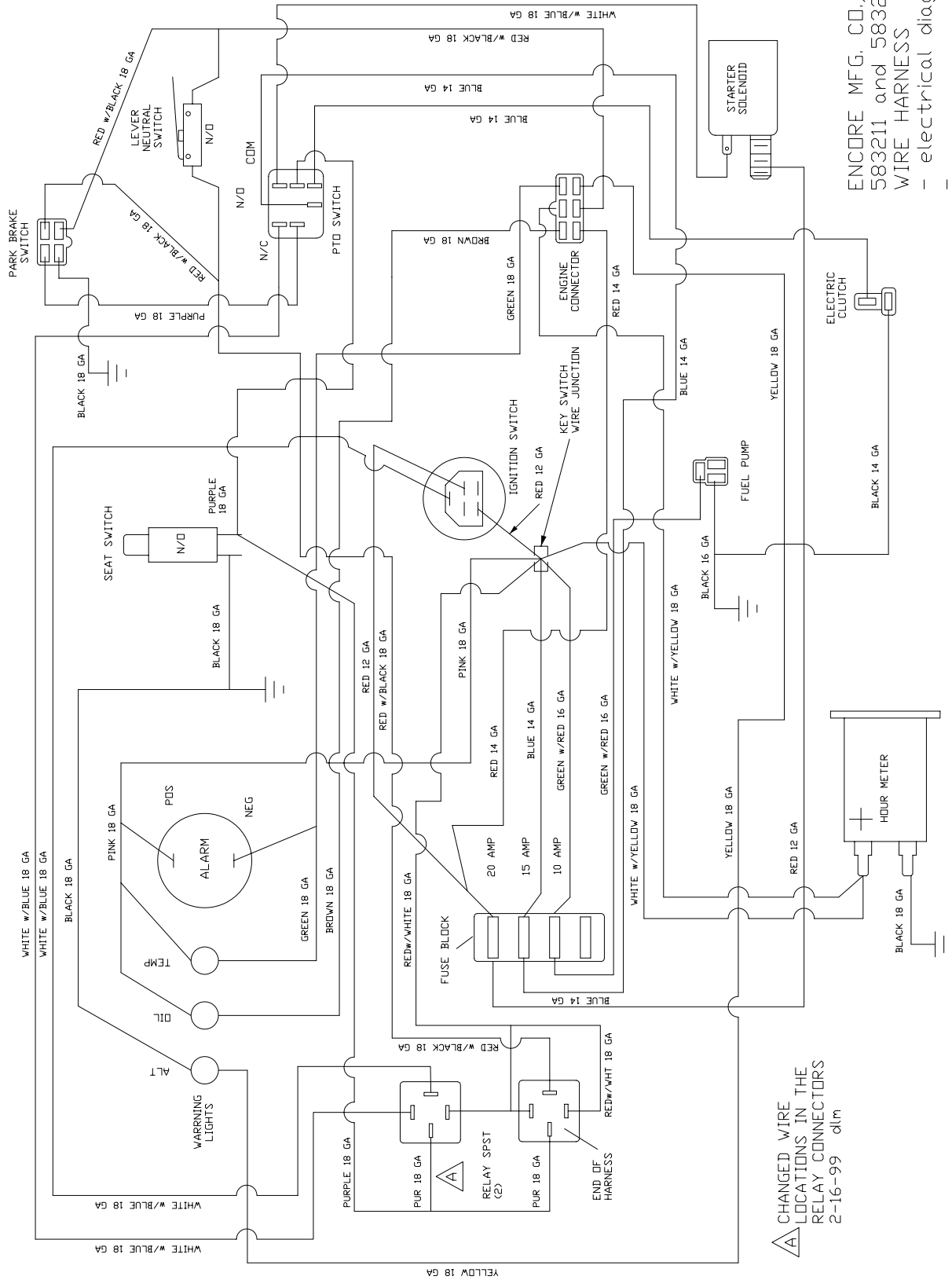

52-61" Mid-Cut Electrical Schematics

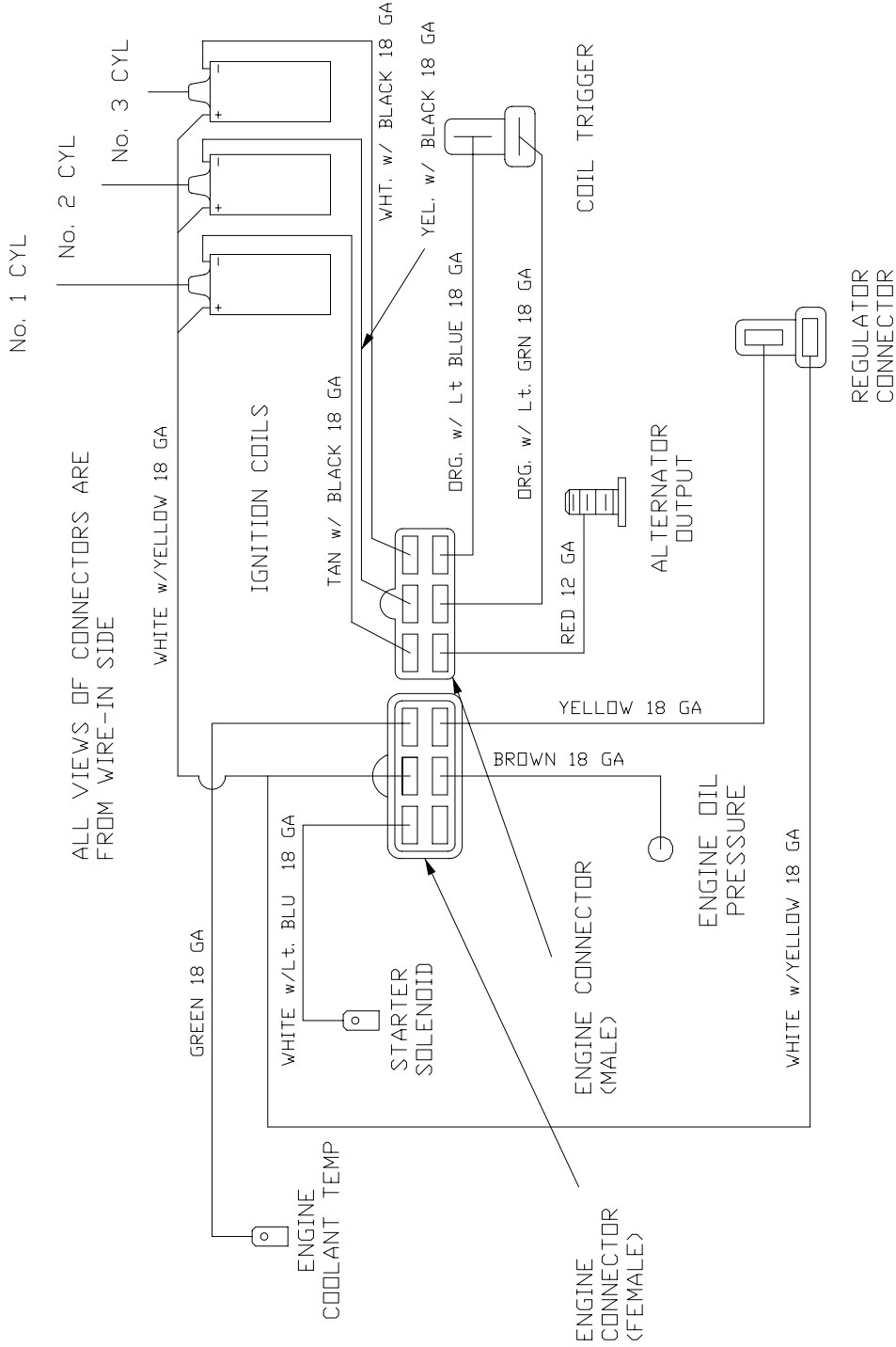

ENCORE MFG. CO., INC.
 583319 ENGINE WIRE HARNESS
 1 REQD./ 950G
 - electrical diagram -

52-61" Mid-Cut Electrical Schematics

ENCORE MFG. CO., INC.
583495 ENGINE WIRE HARNESS
1 REQD./ 700

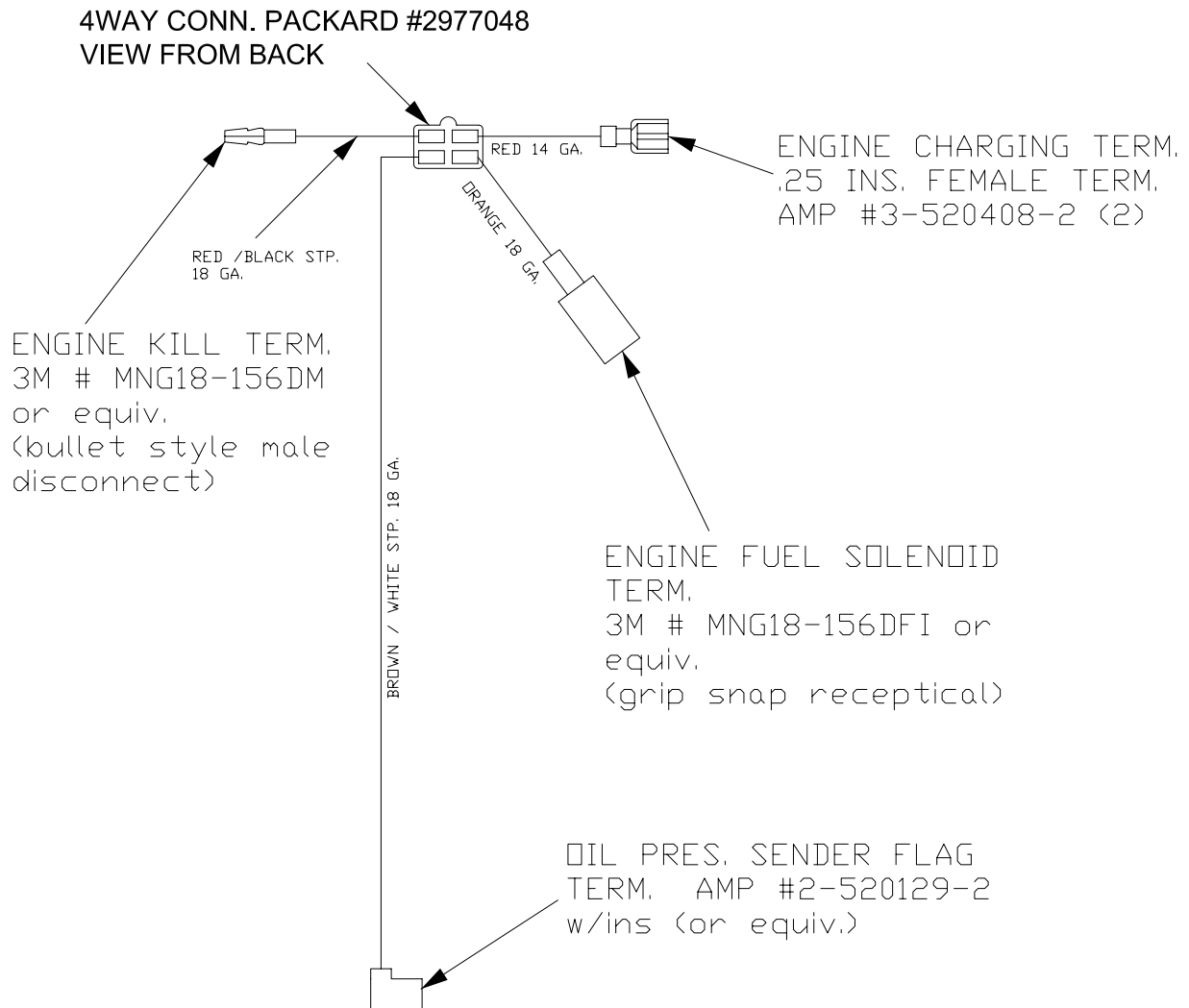

Notes:

