

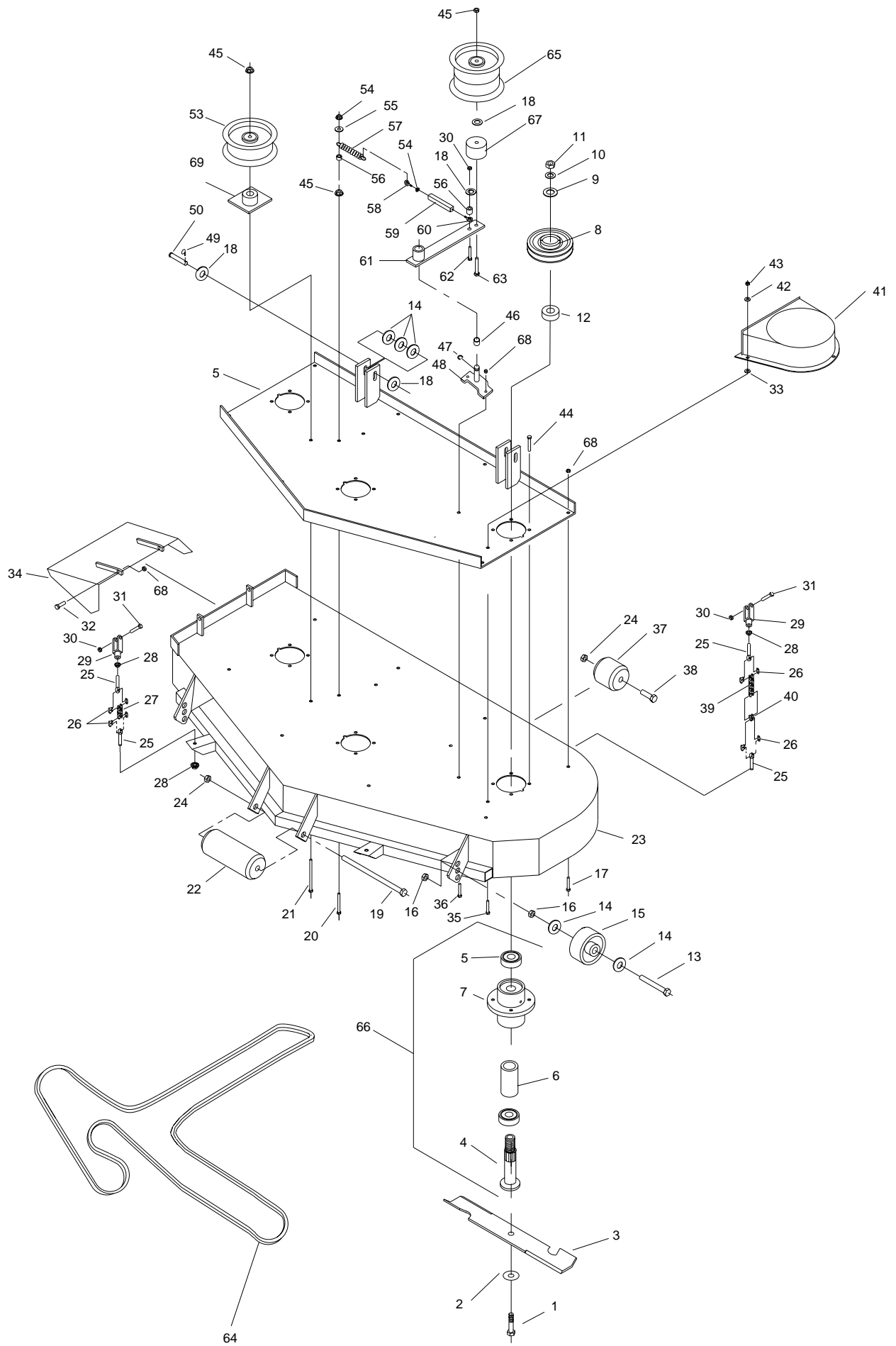

42B18Z

**PARTS
MANUAL**





Z42

Deck Assembly

#	PART NO.	QTY.	NAME		
1	100355	3	5/8-11 X 1 1/4 HHCS		
2	583108	3	5/8 DISC SPRING WASHER		
3	423029	3	14.25" H.L. BLADE		
4	583112	3	SPINDLE SHAFT		
5	363350	6	SPINDLE BEARING		
6	583113	3	BEARING SPACER TUBE		
7	583111	3	SPINDLE HOUSING		
8	423262	3	5" HEX PULLEY		
9	105269	3	3/4 FLAT WASHER SAE		
10	105010	3	3/4 LOCK WASHER		
11	104511	3	3/4 HEX NUT		
12	583110	3	PULLEY SPACER		
13	100335	2	1/2-13 X 4" LG		
14	105264	9	1/2 STD FLAT WASHER		
15	423023	2	DECK ROLLER		
16	104509	4	1/2-13 HEX NUT		
17	107503	9	5/16-18 X 3/4 CARRIAGE BOLT		
18	105260	5	3/8 STD FLAT WASHER		
19	100352	1	5/8-11 X 9" LG		
20	107508	1	5/16-18 X 2 CARRIAGE BOLT		
21	107506	2	3/8-16 X 3 1/4 CARRIAGE BOLT		
22	603023	1	FRONT ANTISCALP ROLLER		
23	422094	1	42" DECK		
24	104261	2	5/8 -11 NYLOC		
25	523125	8	ANCHOR STUD		
26	523123	8	CONNECTOR LINK		
27	423180	2	FRONT LIFT CHAIN		
28	109008	8	3/8-24 WHIZLOCK		
29	363192	4	LARGE YOKE		
30	104257	4	3/8-16 NYLOC		
31	100294	4	3/8-16 X 1 1/2"		
32	100273	2	5/16-18 X 1 HHCS		
33	109011	6	1/4" RETAINING CLIP		
34	422070	1	GRASS DEFLECTOR		
35	107510	6	1/4-20 X 1 CARRIAGE BOLT		
36	107509	2	5/16-18 X 1 CARRIAGE BOLT		
37	523084	1	REAR DECK ROLLER		
38	100346	1	5/8-11 X 4 1/2		
39	423181	2	REAR LEFT CHAIN		
40	423199	2	#40 HALF LINK		
41	423076	1	LEFT BELT GUARD		
41	423077	1	RIGHT BELT GUARD		
42	105256	6	1/4 STD FLAT WASHER		

Z42

Deck Assembly

#	PART NO.	QTY.	NAME		
43	104255	6	1/4-20 NYLOC		
44	100274	12	5/16-18 X 1 1/4 HHCS		
45	109007	4	3/8-16 WHIZLOCK NUT		
46	363089	3	BRONZE BUSHING		
47	108509	1	E-RING		
48	522104	1	OFFSET PIVOT		
49	106763	2	1/8" COTTER PIN		
50	523242	2	7/16 CLEVIS PIN-LONG		
51	422002	1	42" SUB-PLATE W/DMT		
53	523329	2	FLAT IDLER		
54	109001	2	5/16-18 WHIZLOCK		
55	105258	1	5/16 STD FLAT WASHER		
56	363174	2	EYEBOLT SPACER		
57	523327	1	FLOATING IDLER SPRING		
58	363080	1	EYEBOLT-RIGHT		
59	363172	1	TURNBUCKLE BODY		
60	363082	1	EYEBOLT-LEFT		
61	422108	1	TENSIONER W/BUSHING		
62	100293	1	3/8-16 X 1 1/4 HHCS		
63	100300	1	3/8-16 X 3 HHCS		
64	423018	1	DECK DRIVE BELT		
65	373068	1	ENGAGEMENT IDLER		
66	583106	3	SPINDLE ASSEMBLY		
67	483017	1	RT HAND IDLER SPACER		
68	104256	6	5/16-18 NYLOC NUT		
69	422105	1	IDLER MOUNT WELDMENT		

Notes:

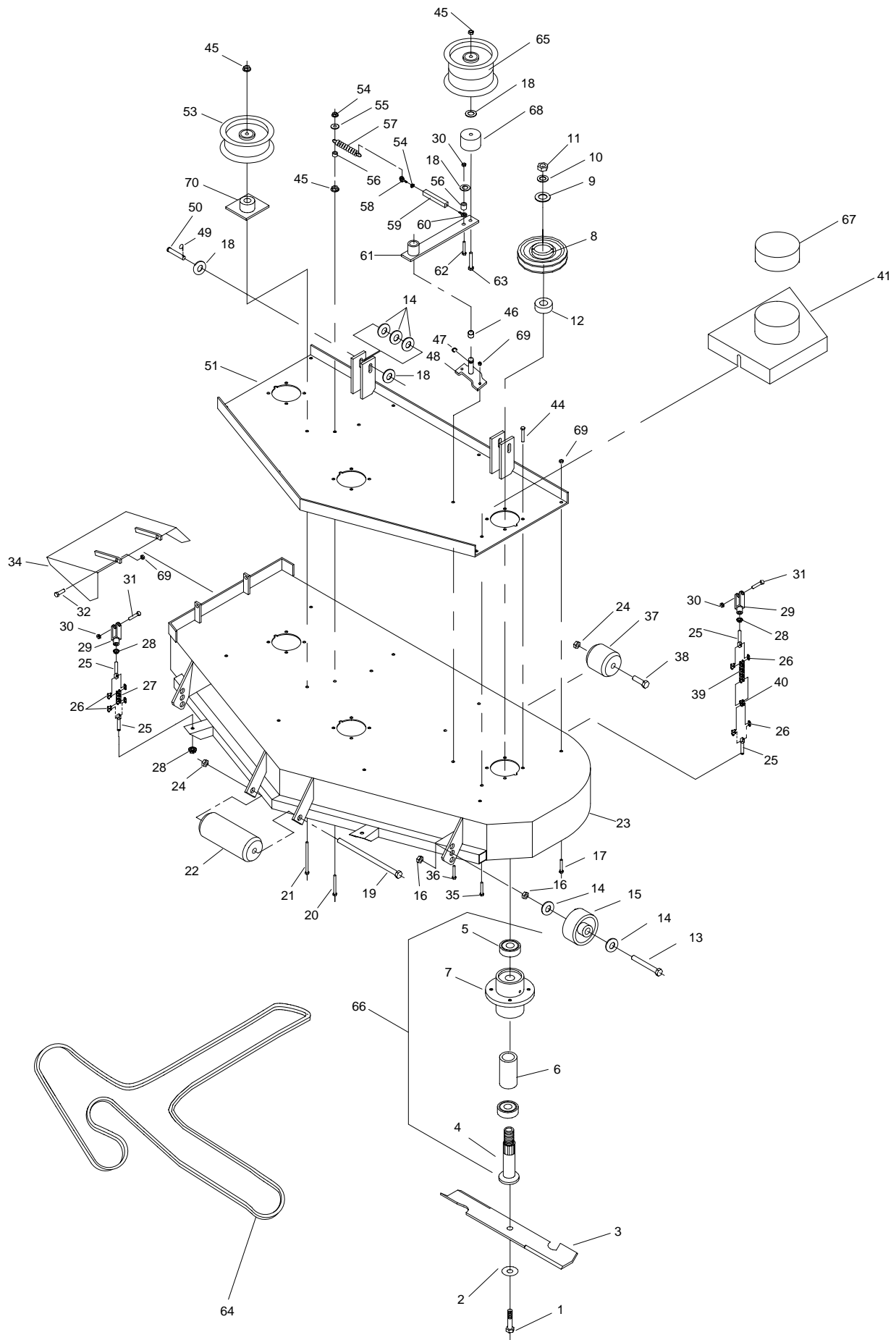

Z48

Deck Assembly

#	PART NO.	QTY.	NAME		
1	100355	3	5/8-11 X 1 1/4 HHCS		
2	583108	3	5/8 DISC SPRING WASHER		
3	483035	3	16" BLADE		
4	583112	3	SPINDLE SHAFT		
5	363350	6	SPINDLE BEARING		
6	583113	3	BEARING SPACER TUBE		
7	583111	3	SPINDLE HOUSING		
8	483078	3	5.75" HEX PULLEY		
9	105269	3	3/4 FLAT WASHER SAE		
10	105010	3	3/4 LOCK WASHER		
11	104511	3	3/4 HEX NUT		
12	583110	3	PULLEY SPACER		
13	100335	2	1/2-13 X 4" LG		
14	105264	9	1/2 STD FLAT WASHER		
15	423023	2	DECK ROLLER		
16	104509	4	1/2-13 HEX NUT		
17	107503	9	5/16-18 X 3/4 CARRIAGE BOLT		
18	105260	5	3/8 STD FLAT WASHER		
19	100352	1	5/8-11 X 9" LG		
20	107508	1	5/16-18 X 2 CARRIAGE BOLT		
21	107506	2	3/8-16 X 3 1/4 CARRIAGE BOLT		
22	603023	1	FRONT ANTISCALP ROLLER		
23	482026	1	48" DECK		
24	104261	2	5/8" - 11 NYLOC		
25	523125	8	ANCHOR STUD		
26	523123	8	CONNECTOR LINK		
27	423180	2	FRONT LIFT CHAIN		
28	109008	8	3/8-24 WHIZLOCK		
29	363192	4	LARGE YOKE		
30	104257	4	3/8-16 NYLOC		
31	100294	4	3/8-16 X 1 1/2"		
32	100273	2	5/16-18 X 1 HHCS		
33	109011	6	1/4" RETAINING CLIP		
34	482017	1	GRASS DEFLECTOR		
35	107510	6	1/4-20 X 1 CARRIAGE BOLT		
36	107509	2	5/16-18 X 1 CARRIAGE BOLT		
37	523084	1	REAR DECK ROLLER		
38	100346	1	5/8-11 X 4 1/2		
39	423181	2	REAR LEFT CHAIN		
40	423199	2	#40 HALF LINK		
41	482030	1	LEFT BELT GUARD		
41	482032	1	RIGHT BELT GUARD		
42	105256	6	1/4 STD FLAT WASHER		

Z48

Deck Assembly

#	PART NO.	QTY.	NAME		
43	104255	6	1/4-20 NYLOC		
44	100274	12	5/16-18 X 1 1/4 HHCS		
45	109007	4	3/8-16 WHIZLOCK NUT		
46	363089	3	BRONZE BUSHING		
47	108509	1	E-RING		
48	522104	1	OFFSET PIVOT		
49	106763	2	1/8" COTTER PIN		
50	523242	2	7/16 CLEVIS PIN-LONG		
51	482028	1	48" SUB-PLATE W/DMT		
53	523329	2	FLAT IDLER		
54	109001	2	5/16-18 WHIZLOCK		
55	105258	1	5/16 STD FLAT WASHER		
56	363174	2	EYEBOLT SPACER		
57	523327	1	FLOATING IDLER SPRING		
58	363080	1	EYEBOLT-RIGHT		
59	363172	1	TURNBUCKLE BODY		
60	363082	1	EYEBOLT-LEFT		
61	422108	1	TENSIONER W/BUSHING		
62	100293	1	3/8-16 X 1 1/4 HHCS		
63	100300	1	3/8-16 X 3 HHCS		
64	483053	1	DECK DRIVE BELT		
65	373068	1	ENGAGEMENT IDLER		
66	583106	3	SPINDLE ASSEMBLY		
67	363161	1	BELT COVER CAP		
68	483017	1	RT HAND IDLER SPACER		
69	104256	6	5/16-18 NYLOC NUT		
70	422105	1	IDLER MOUNT WELDMENT		

Notes:

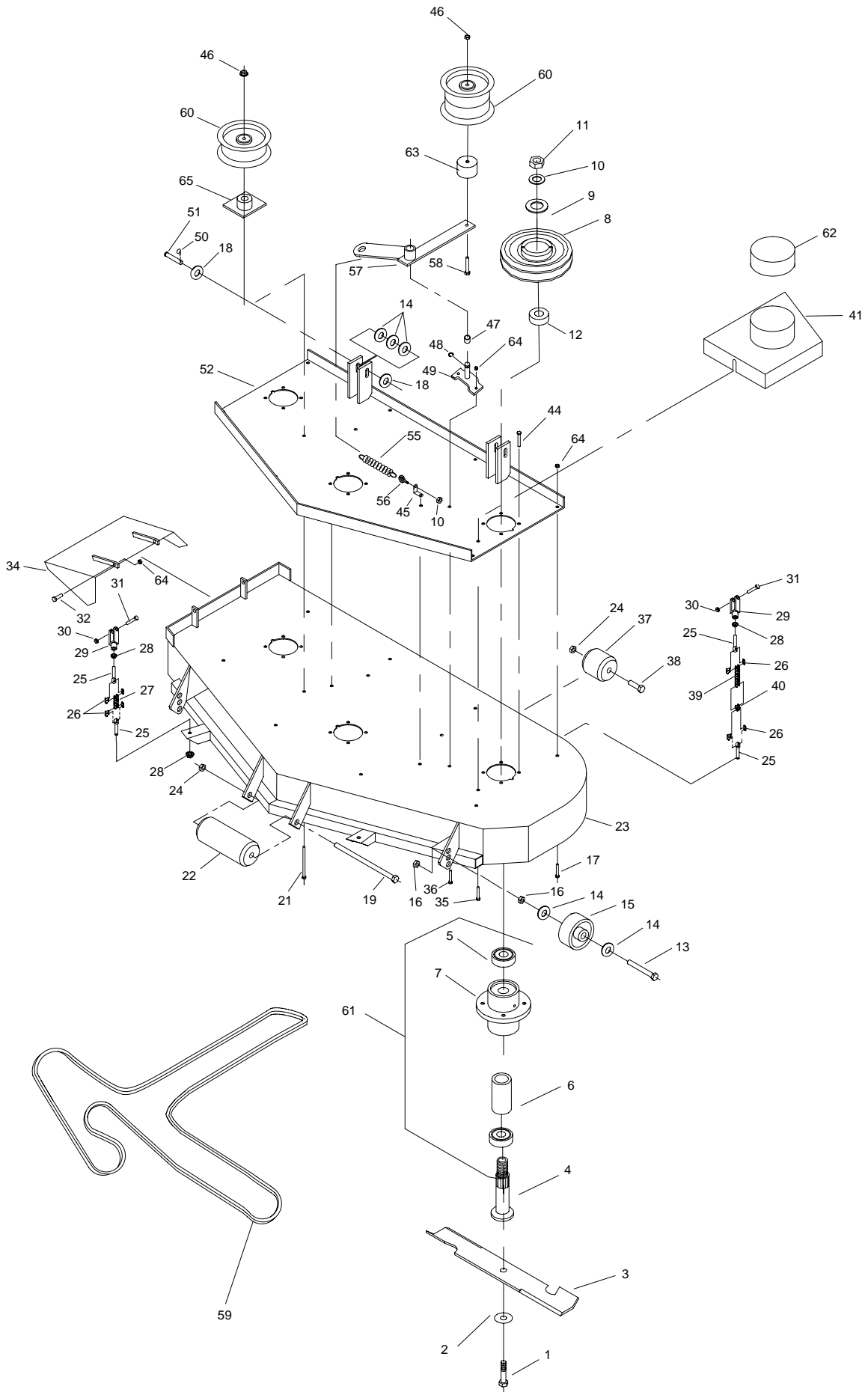

Z52

Deck Assembly

#	PART NO.	QTY.	NAME		
1	100355	3	5/8-11 X 1 1/4 HHCS		
2	583108	3	5/8 DISC SPRING WASHER		
3	823004	3	18" BLADE		
4	583112	3	SPINDLE SHAFT		
5	363350	6	SPINDLE BEARING		
6	583113	3	BEARING SPACER TUBE		
7	583111	3	SPINDLE HOUSING		
8	523496	3	6.25" HEX PULLEY		
9	105269	3	3/4 FLAT WASHER SAE		
10	105010	3	3/4 LOCK WASHER		
11	104511	3	3/4 HEX NUT		
12	583110	3	PULLEY SPACER		
13	100335	2	1/2-13 X 4" LG		
14	105264	9	1/2 STD FLAT WASHER		
15	423023	2	DECK ROLLER		
16	104509	4	1/2-13 HEX NUT		
17	107503	9	5/16-18 X 3/4 CARRIAGE BOLT		
18	105260	5	3/8 STD FLAT WASHER		
19	100352	1	5/8-11 X 9" LG		
20	107508	1	5/16-18 X 2 CARRIAGE BOLT		
21	107506	2	3/8-16 X 3 1/4 CARRIAGE BOLT		
22	603023	1	FRONT ANTISCALP ROLLER		
23	522150	1	52" DECK		
24	104261	2	5/8" - 11 NYLOC		
25	523125	8	ANCHOR STUD		
26	523123	8	CONNECTOR LINK		
27	423180	2	FRONT LIFT CHAIN		
28	109008	8	3/8-24 WHIZLOCK		
29	363192	4	LARGE YOKE		
30	104257	4	3/8-16 NYLOC		
31	100294	4	3/8-16 X 1 1/2"		
32	100273	2	5/16-18 X 1 HHCS		
33	109011	6	1/4" RETAINING CLIP		
34	582025	1	GRASS DEFLECTOR		
35	107510	6	1/4-20 X 1 CARRIAGE BOLT		
36	107509	2	5/16-18 X 1 CARRIAGE BOLT		
37	523084	1	REAR DECK ROLLER		
38	100346	1	5/8-11 X 4 1/2		
39	423181	2	REAR LEFT CHAIN		
41A	522156	1	LEFT BELT GUARD		
41B	522154	1	RIGHT BELT GUARD		
42	105256	6	1/4 STD FLAT WASHER		
43	104255	6	1/4-20 NYLOC		

Z52

Deck Assembly

#	PART NO.	QTY.	NAME		
44	100274	12	5/16-18 X 1 1/4 HHCS		
45	523094	1	SPRING MOUNT DECK		
46	109007	4	3/8-16 WHIZLOCK NUT		
47	363089	3	BRONZE BUSHING		
48	108509	1	E-RING		
49	522104	1	OFFSET PIVOT		
50	106763	2	1/8" COTTER PIN		
51	523242	2	7/16 CLEVIS PIN-LONG		
52	522152	1	52" SUB-PLATE W/DMT		
54	523329	2	FLAT IDLER		
55	523327	1	FLOATING IDLER SPRING		
56	363080	1	EYEBOLT-RIGHT		
57	522164	1	TENSIONER W/BUSHING		
58	100300	1	3/8-16 X 3 HHCS		
59	523472	1	DECK DRIVE BELT		
60	373068	1	ENGAGEMENT IDLER		
61	583106	3	SPINDLE ASSEMBLY		
62	363161	1	BELT COVER CAP		
63	373089	1	RT HAND IDLER SPACER		
64	104256	6	5/16-18 NYLOC NUT		
65	422105	1	IDLER MOUNT WELDMENT		

Notes:

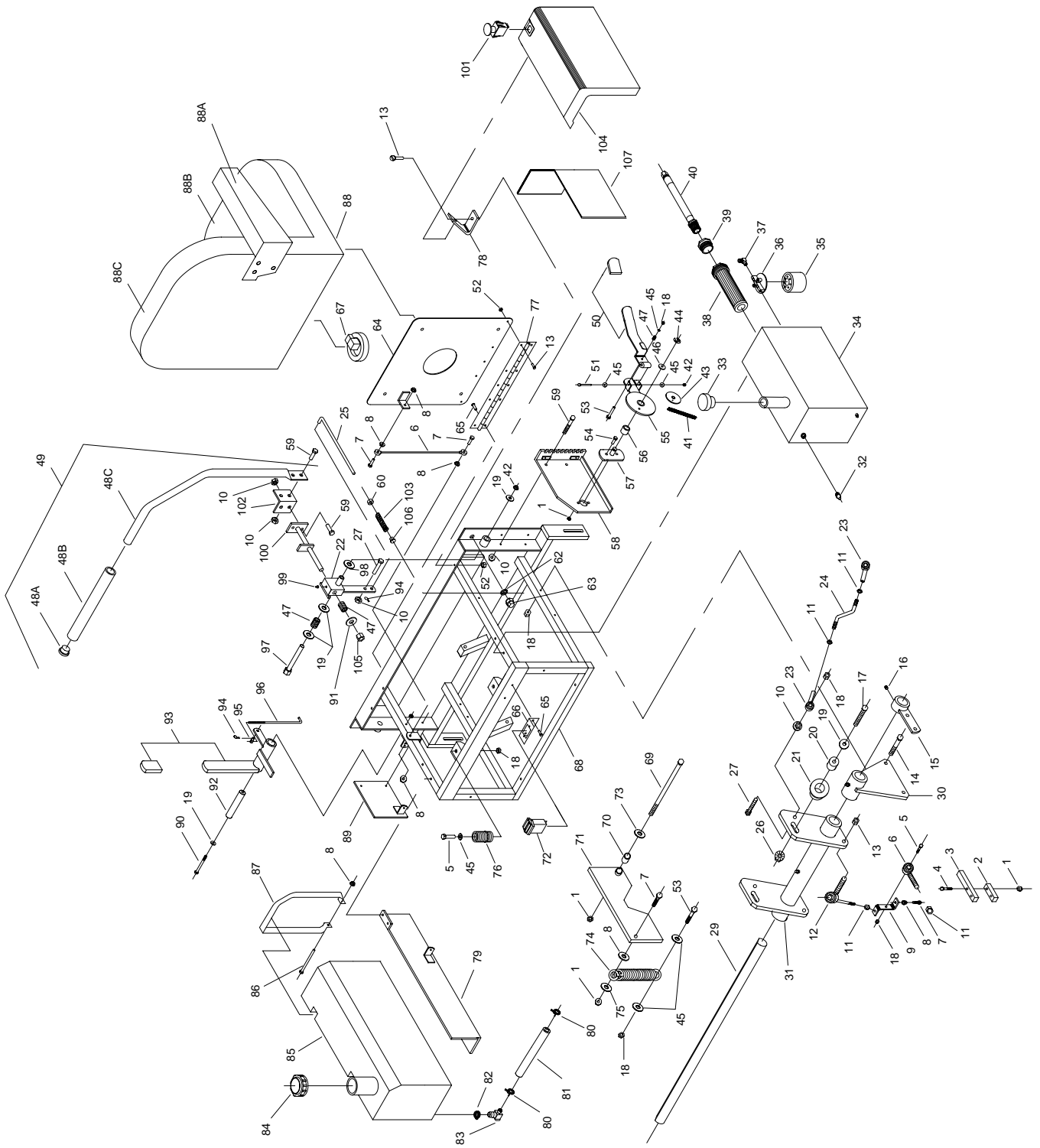

Z42 - Z48 - Z52

Seat Frame Assembly

#	PART NO.	QTY.	NAME		
1	104255	7	1/4-20 NYLOC		
2	453090	2	CLAMP BAR		
3	453092	2	PUMP CONTROL BAR		
4	100257	4	1/4-20 X 1 3/4 HHCS		
5	100273	2	5/16-18 X 1 HHCS		
6	453082	2	.312 ROD END (M)		
7	100004	4	1/4-20 X 1 HHCS		
8	109000	4	1/4-20 WHIZ		
9	453148	2	VERTICAL PUMP LINK		
10	109001	2	5/16 WHIZ		
11	104752	2	5/16-24 JAM NUT UNF		
12	423160	2	5/16-24 MALE ROD END		
13	101039	7	#10-24 X 5/8 PANHEAD		
14	100276	4	5/16-18 X 1 3/4 HHCS		
15	422049	2	BRAKE CRANK		
16	100501	2	1/4-28 1/2		
17	100293	2	3/8-16 X 1 1/4 HHCS		
18	104256	12	5/16-18 NYLOC		
19	105260	9	3/8 STD FLAT WASHER		
20	523143	2	BEARING SPACER		
21	523142	2	NEUTRAL BEARING		
22	522061	2	BI DIRECTIONAL BLACK W/ZERK		
23	453081	4	5/16 ROD END (F)		
24	423124	2	PUMP DRIVE ROD		
25	423126	2	ASSIST ROD		
26	109007	2	3/8 WHIZ LOCK		
27	100274	4	5/16-18 X 1 1/4 HHCS		
28	-	-	-----		
29	423182	1	CONTROL TUBE SHAFT		
30	422021	2	PIVOT PLATE W/ZERK		
31	422019	2	PUMP CONTROL W/ZERK		
32	423065	1	OIL EYE		
33	423165	1	OIL BREATHER CAP		
34	423250	1	OIL TANK		
35	423063	1	OIL FILTER		
36	423064	1	FILTER HEAD		
37	423067	1	RETURN 90 DEGREE ADAPTER		
38	583132	1	SUCTION SCREEN		
39	453128	1	REDUCER BUSHING		
40	453129	1	HOSE TANK TO PUMP		
41	523122	1	LIFT CHAIN		
42	104257	3	3/8 NYLOC		
43	423115	1	DECK LEFT SUPPORT		

Z42 - Z48 - Z52

Seat Frame Assembly

#	PART NO.	QTY.	NAME		
44	108500	1	E-RING FOR 5/8 DIA		
45	105258	7	5/16 STD FLAT WASHER		
46	109025	1	5/8 HEAVY FLAT WASHER-PLTD		
47	363024	5	COMPRESSION SPRING		
48A	523033	2	HANDLE PLUG		
48B	523032	2	HANDLE GRIP		
48C	523017	2	HANDLE		
49	522100	2	HANDLE ASSEMBLY		
50	422031	1	LEFT LEVER W/GRIP		
51	100297	1	3/8-16 X 2 1/4 HHCS		
52	104252	7	#10-24 NYLOC		
53	100277	2	5/16-18 X 2 HHCS		
54	100254	2	1/4-20 X 1 HHCS		
55	422052	1	LIFT SPROCKET W/BUSHING		
56	253059	1	ENGAGEMENT BUSHING		
57	362033	1	BELL CRANK MOUNT		
58	422058	1	LIFT BRACKET W/LDMT		
59	100271	12	5/16-18 X 3/4 HHCS		
60	523112	2	5/16 CLAMP COLLAR		
61	523044	1	SEAT CABLE		
62	363087	1	TRANS SHAFT SPACER		
63	363208	1	OPC SWITCH		
64	422099	1	SEAT PLATE		
65	102000	13	SELF TAPPING SCREW #12-24 X 5/8		
66	523014	1	HOUR METER MOUNT		
67	523030	1	SEAT SWITCH		
68	422101	1	SEAT FRAME		
69	100263	1	1/4-20 X 3 1/4 HHCS		
70	523144	2	NEUTRAL PIVOT BUSHING		
71	422033	1	LEFT NEUTRAL ARM		
71	422035	1	RIGHT NEUTRAL ARM		
72	523283	1	HOUR METER		
73	253025	2	RETAINING WASHER		
74	423060	2	NEUTRAL ARM SPRING		
75	105256	2	1/4 - STP FLAT WASHER		
76	523278	2	SEAT SPRING		
77	523105	1	SEAT HINDGE		
78	423184	2	FRONT FENDER MOUNT		
79	422096	1	FUEL TANK BRACKET		
80	363098	2	GAS LINE CLAMP		
81	363228	1	SHORT FUEL LINE		
82	363269	1	FUEL VALVE CLAMP		
83	363031	1	FUEL SHUT-OFF VALVE		

Z42 - Z48 - Z52

Seat Frame Assembly

#	PART NO.	QTY.	NAME		
84	363257	1	FUEL CAP W/GASKET		
85	423163	1	GAS TANK		
86	101317	2	1/4-20 4 1/2 MACH SCREW		
87	363202	2	TANK BAND		
88	423246	1	SEAT		
88A	593097		ARM REST PADS		
89	422060	1	NEUTRAL ASSIST BRKT		
90	100305	1	3/8-16 X 4 1/2 HHCS		
91	105264	2	1/2 STD FLAT WASHER PLTD		
92	363105	1	IDLER BUSHING		
93	422028	1	BRAKE LEVER W/GRIP		
94	363165	3	#2 HAIR PIN		
95	363029	1	.312 ROD SWIVEL		
96	363142	1	BRAKE LINKAGE		
97	100303	2	3/8-16 X 4 HHCS		
98	105267	2	5/8 SAE WASHER		
99	111004	2	1/4-28 ZERK		
100	522095	1	LH PIVOT ROD WLDMT		
100	522060	1	RH PIVOT ROD WLDMT		
101	523031	1	PTO SWITCH		
102	523222	2	CONTROL LEVER ANGLE		
103	523028	2	ASSIST SPRINGS		
104	423235	1	RIGHT FENDER		
104	423236	1	LEFT FENDER		
105	104259	2	1/2-13 NYLOC		
106	363159	2	NYLON BUSHING		
107A	423242	1	RIGHT FENDER SKIRT		
107B	423244	1	LEFT FENDER SKIRT		

Notes:

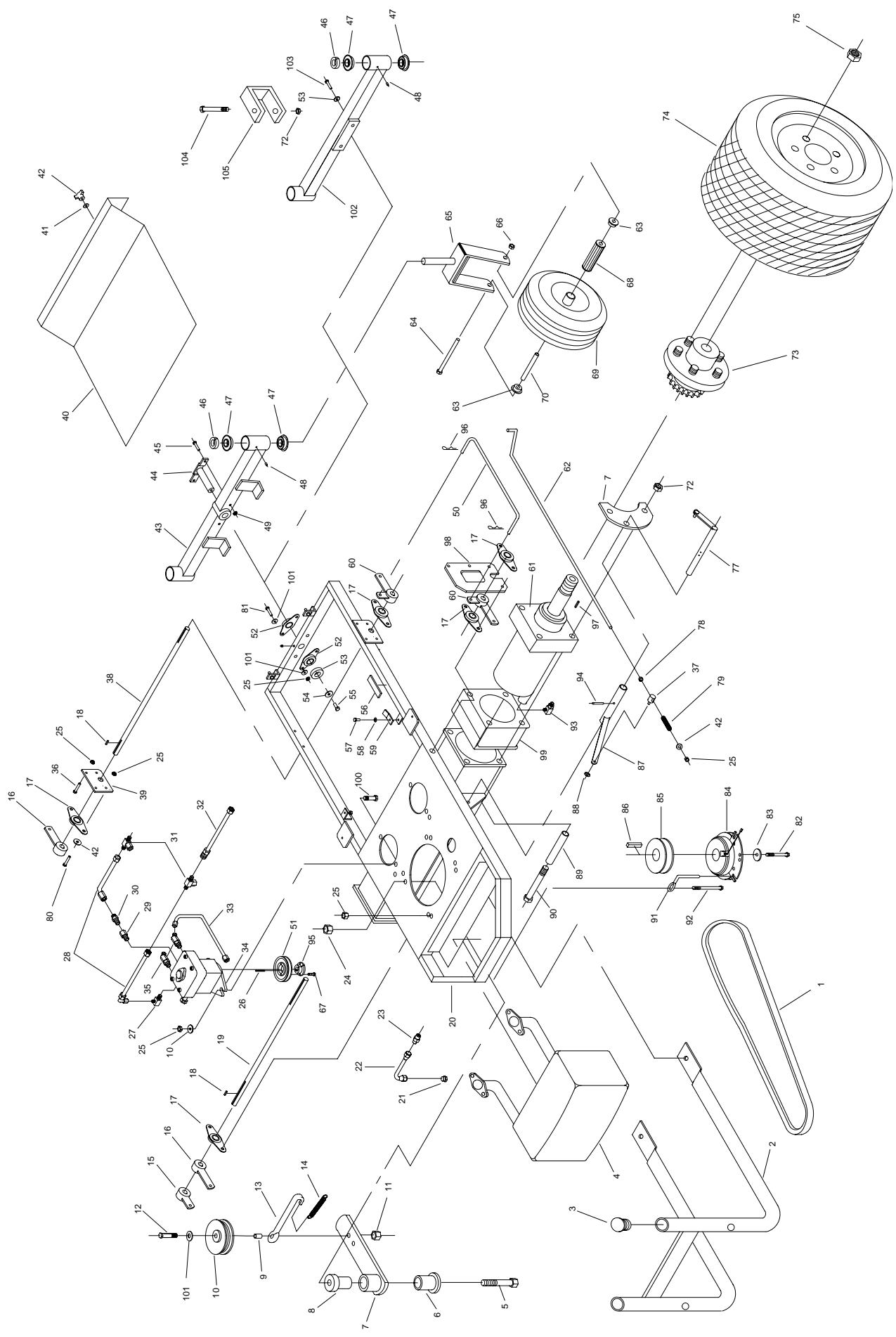

Z42 -Z48 - Z52

Main Frame Assembly

Z48 & Z52 ONLY

Z52 ONLY

#	PART NO.	QTY.	NAME		
1	423272	1	PUMP BELT - Z		
2	422068	1	SKID BRACKET		
3	523033	2	HANDLE PLUG		
4A	423019	1	MUFFLER W/DEFLECTOR (B&S 16,18,20 HP)		
4B	423278	1	MUFFLER W/DEFLECTOR (KAW 17 HP)		
4C	483089	1	MUFFLER W/DEFLECTOR (KAW 19,21 HP)		
5	100300	1	3/8"-16 X 3" HEX BOLT		
6	523111	1	3/4" PLASTIC BUSHING		
7	422025	1	TENSIONER WELDMENT		
8	423175	1	PUMP IDLER PIVOT		
9	363174	1	EYEBOLT SPACER		
10	523328	1	FLAT IDLER		
11	109007	1	3/8"-16 WHIZLOCK NUT		
12	100295	1	3/8"-16 X 1 3/4" HEX BOLT		
13	423122	1	PUMP TENSION ROD		
14	553007	1	IDLER SPRING		
15	422056	1	SPRING ASSIST ARM		
16	422041	2	DECK LIFT ARM		
17	423140	5	3/4" 2 BOLT BEARING		
18	107255	5	3/16" X 3/16" X 1" MACHINED KEY		
19	423096	1	REAR DECK LIFT SHAFT		
20	422008	1	MAIN FRAME WELDMENT		
21	523065	1	ENGINE DRAIN PLUG		
22	523064	1	ENGINE DRAIN LINE		
23	423070	1	OIL DRAIN ADAPTOR		
24	104256	8	5/16" - 18 NYLOC NUT		
25	104257	7	3/8" - 16 NYLOC NUT		
26	453102	2	PUMP KEY		
27	453074	2	90 DEGREE ADAPTER		
28	453127	2	PUMP TO PUMP FEED LINE		
29	453111	2	PUMP INLET ADAPTOR		
30	453110	2	PUMP INLET CONNECTOR		
31	453106	2	SWIVEL TEE		
32	423066	1	RETURN HOSE		
33A	423035	2	OUTSIDE LINE		
33B	423036	1	RIGHT HAND INSIDE LINE		
33C	423037	1	LEFT HAND INSIDE LINE		
33D	483063	1	LEFT HAND INSIDE LINE	X	
33E	483064	1	LEFT HAND OUTSIDE LINE	X	
33F	483065	1	RIGHT HAND INSIDE LINE	X	
33G	483066	1	LEFT HAND INSIDE LINE	X	
34	453087	2	PUMP V (BDP-10L)		
35	423031	1	45 DEGREE PRESSURE ADAPTOR		

Z42 -Z48 - Z52

Main Frame Assembly

Z48 & Z52 ONLY

Z52 ONLY

#	PART NO.	QTY.	NAME		
36	100276	6	5/16"-18 X 1 3/4" HEX BOLT		
37	423130	2	PARK BRAKE SWIVEL		
38	423098	1	FRONT DECK LIFT SHAFT		
39	423194	2	BEARING MOUNT PLATE		
40	423042	1	FLOOR PAN		
41	105258	6	5/16" FLAT WASHER		
42	753028	2	KNOB		
43	422010	1	FRONT AXLE		
44	422014	1	ROCKER AXLE PIN		
45	100258	2	1/4"-20 X 2" HEX BOLT		
46	423071	2	7/8" CLAMP COLLAR		
47	423109	4	7/8" FLANGE BEARING		
48	111001	2	1/8" NPT GREASE ZERK		
49	109000	2	1/4"-20 WHIZLOCK NUT		
50	423120	1	DECK LIFT ROD		
51	423177	2	PUMP PULLEY		
52	423141	2	1" 2 BOLT BEARING		
53	373089	1	RETAINING WASHER		
54	753027	1	3/8" DISC SPRING WASHER		
55	100292	1	3/8"-16 X 1" HEX BOLT		
56	363201	5	TANK PAD		
57	100252	2	1/4"-20 X 3/4" HEX BOLT		
58	104255	2	1/4"-20 NYLOC NUT		
59	363297	2	SELF FORMING CLIP		
60	422043	2	DECK LIFT CRANK		
61A	453153	2	WHEEL MOTOR	X	
61B	423034	2	REAR PORT WHEEL MOTOR (Z42)		
62	423128	2	PARK BRAKE LINK		
63	423201	4	BEARING RETAINER		
64	100339	2	1/2"-13 X 6"		
65	422016	2	FRONT CASTER YOKE		
66	104259	2	1/2"-13 NYLOC NUT		
67	100252	1	1/4"-20 X 3/4" HEX BOLT		
68	423200	2	WHEEL BEARING		
69	423103	2	FRONT CASTER COMPLETE		
70	363307	2	FRONT AXLE TUBE		
71	423162	2	BRAKE MOUNT BRACKET		
72	104259	8	1/2"-13 NYLOC NUT		
73	423082	2	WHEEL HUB W/SPROCKET		
74A	523306	2	20" WHEEL & TIRE ASSY		
74B	823183	2	WHEEL & TIRE ASSY	X	
75	103023	10	LUG NUT 1/2"-20 UNF		
76	104511	2	3/4"-16 UNF HEX NUT		

Z42 -Z48 - Z52

Main Frame Assembly

Z48 & Z52 ONLY

Z52 ONLY

#	PART NO.	QTY.	NAME		
77A	422082	1	RIGHT HAND BRAKE CLAW		
77B	422084	1	LEFT HAND BRAKE CLAW		
77C	482039	1	LEFT HAND BRAKE CLAW	X	
77D	482037	1	RIGHT HAND BRAKE CLAW	X	
78	523112	2	5/16" CLAMP COLLAR		
79	523024	1	DECK DRIVE SPRING		
80	100271	6	5/16"-18 X 3/4" HEX BOLT		
81	100299	2	3/8"-16 X 2 3/4" HEX BOLT		
82	100536	1	7/16"-20 X 3" HEX BOLT		
83	423069	1	7/16" DISC SPRING WASHER		
84	423285	1	ELECTRIC CLUTCH		
85	423231	1	ENGINE PULLEY		
86	107258	1	1/4" X 1/4" X 3/4"		
87A	422037	2	BRAKE ARM WELDMENT		
87B	482022	2	BRAKE ARM WELDMENT	X	
88	363177	2	3/8" PUSH NUT		
89	423193	8	MOTOR SUPPORT TUBE		
90A	100340	8	1/2"-13 X 6 1/2" HEX BOLT		
90B	100344	8	1/2"-13 X 9 1/2" HEX BOLT		
91	373070	2	BELT GUIDE LONG		
92	100277	1	5/16"-18 X 2" HEX BOLT		
93A	453113	4	PUMP ELBOW		
93B	523058	4	RETURN ADAPTOR	X	
94	103016	2	3/32" X 1" GROOVE		
95	423178	2	TAPER LOCK HUB		
96	363165	2	#2 HAIR COTTER PIN		
97	107012	2	#808 WOODRUFF KEY		
98	423216	1	BRACE PLATE		
99	452026	2	MOTOR EXTENSION	X	
100	100293	4	3/8"-16 X 1 1/4" HEX BOLT		
101	105259	5	3/8" FLAT WASHER		
102	522158	1	FRONT AXLE		X
103	100307	2	3/8"-16 X 5 1/2 HEX BOLT		X
104	100334	2	1/2"-13 X 3 1/2" HEX BOLT		X
105	523481	2	AXLE MOUNT		X

SERVICE KITS

#	PART NO.	QTY.	NAME
A	453154	X	WHEEL MOTOR SEAL KIT
B	453146	X	10L PUMP SEAL KIT

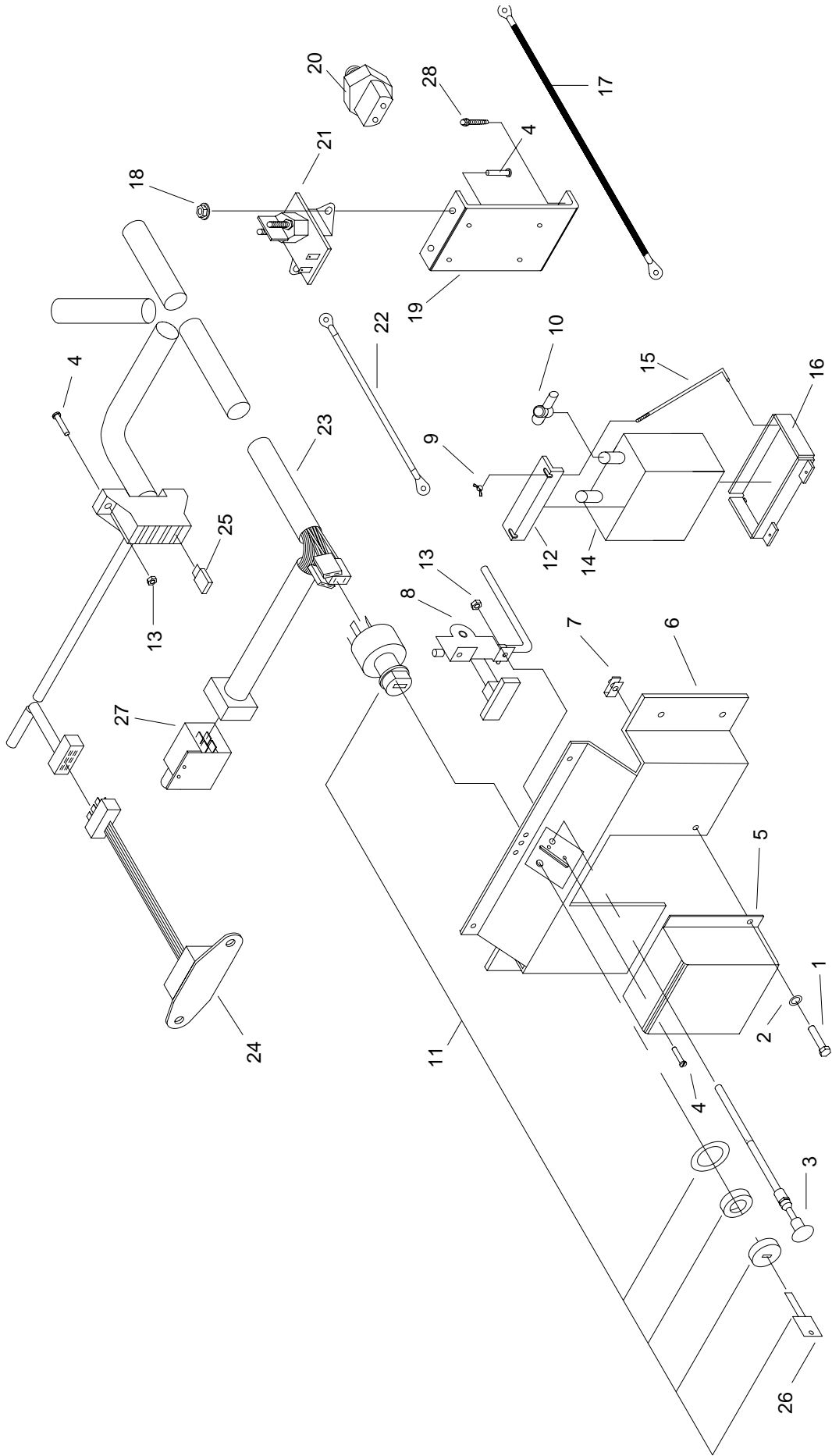

Z42 - Z48 - Z52

Electrical Controls

BRIGGS
KAWASKI

#	PART NO.	QTY.	NAME	BRIGGS	KAWASKI
1	100251	2	1/4 X 5/8 HEX HD BOLT		
2	105256	2	1/4 STD FLAT WASHER		
3	423153	1	CHOKE CABLE		
4	101039	9	#10-24 X 5/8 MACH SCREW		
5	423075	1	BATTERY COVER		
6	423044	1	SEAT PANEL		
7	109015	2	1/4-20 NUT CLIP		
8A	423254	1	THROTTLE CONTROL		X
8B	523038	1	THROTTLE CONTROL	X	
9	109012	2	1/4-20 LOCKING WING NUT		
10	423158	3	TERMINAL INSULATOR		
11	423027	1	IGNITION SWITCH ASSY		
12	423011	1	HOLD-DOWN ANGLE		
13	104252	7	#10-24 NYLOC NUT		
14	423142	1	BATTERY, 12V		
15	423172	2	BATTERY HOLD-DOWN		
16	422064	1	BATTERY TRAY		
17	423118	1	NEGATIVE CABLE		
18	109003	2	#10-24 WIZLOCK NUT		
19	423132	1	ELECTRIC PANEL		
20	363208	1	OPC SWITCH		
21	423017	1	STARTER RELAY		
22A	423116	1	POSITIVE CABLE SHORT		
22B	423117	1	POSITIVE CABLE LONG		
23A	423078	1	WIRE HARNESS (BRIGGS)	X	
23B	423237	1	WIRE HARNESS (KAW)		X
24	423030	1	SAFETY MODULE		
25A	523145	1	20 AMP FUSE		
25B	523146	1	15 AMP FUSE		
26	423209	SERVICE	IGNITION KEY		
27	523034	1	PARK BRAKE SWITCH		
28	102000	2	#12-24 X 5/8 SELF TAPPING SCREW		

Notes:

42B350Z , 48B450Z , 52B550Z

423078 WIRE HARNESS
ELECTRICAL DRAWING

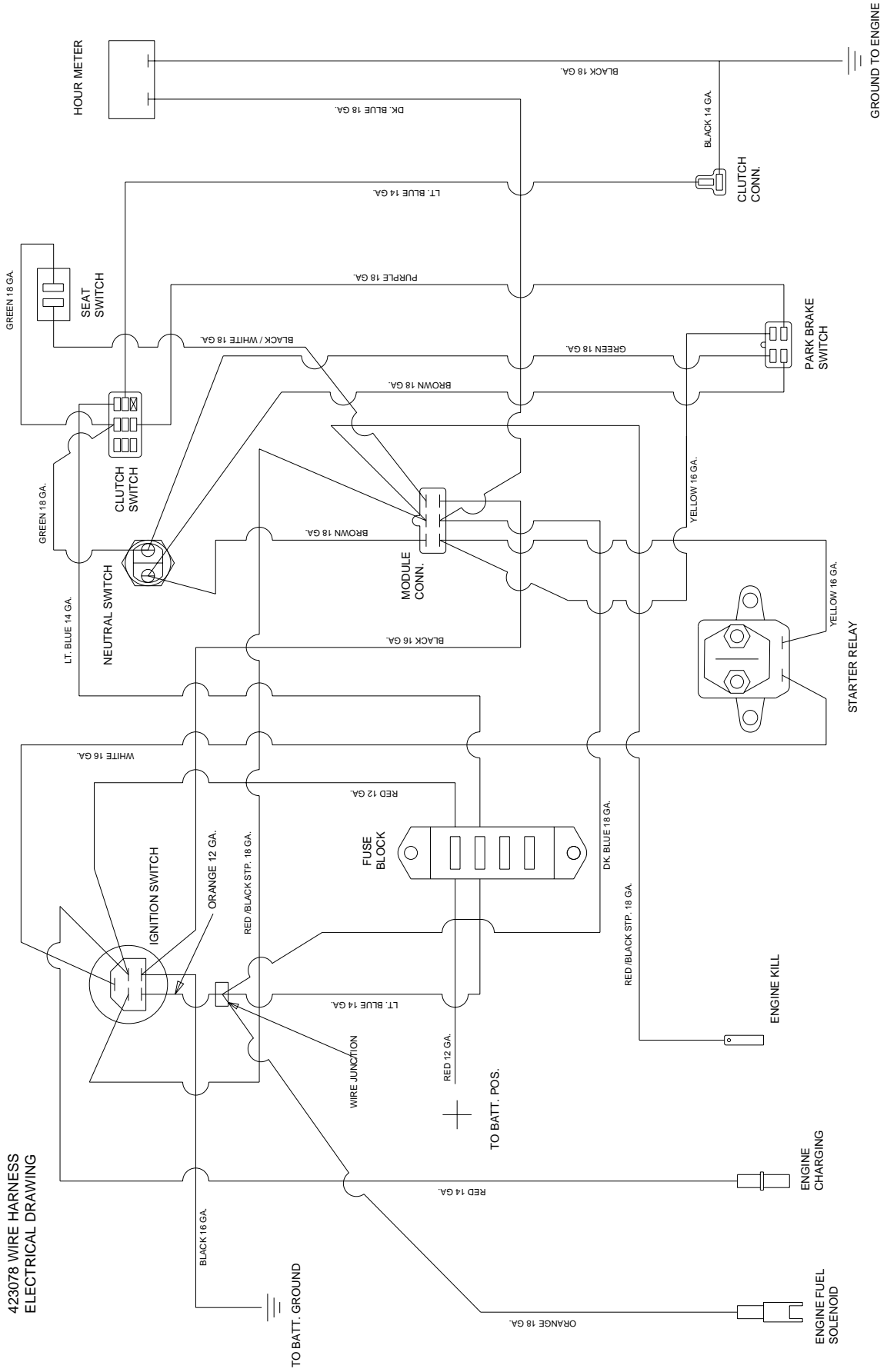

42K450Z , 48K550Z , 52K650Z

423237 WIRE HARNESS
ELECTRICAL DRAWING

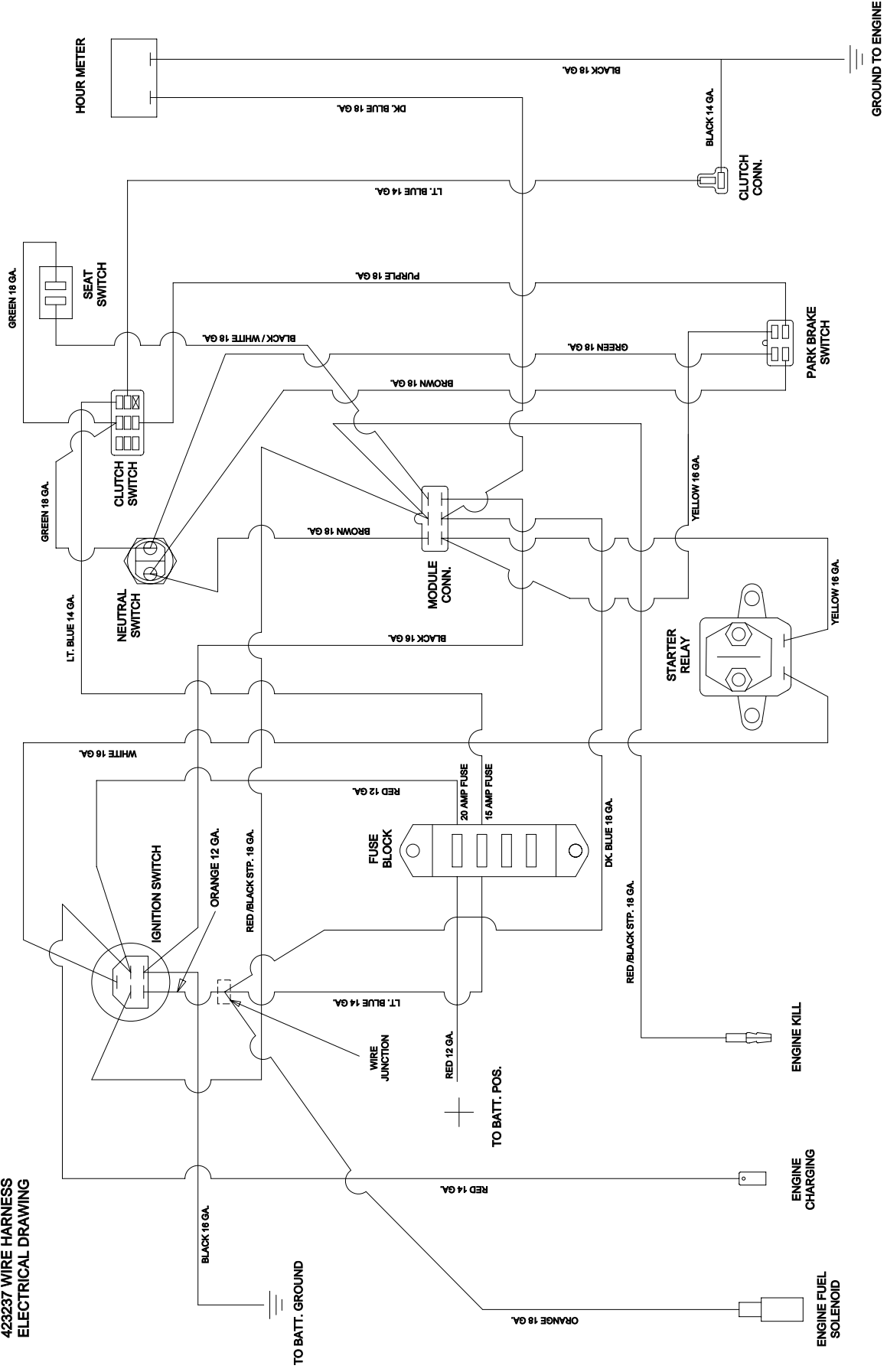

Z42 - Z48 - Z52

Decal List

#	PART NO.	QTY.	NAME		
1	423255	2	Z42 DECAL		
2	483077	2	Z48 DECAL		
3	523495	2	Z52 DECAL		
4	363214	1	PRO-LINE DECAL		
5	423155	1	RIDER CAUTION DECAL		
6	423156	1	PARK LEVER DECAL		
7	423157	1	CUTTING HEIGHT DECAL		
8	523021	1	PTO DECAL		
9	423196	1	BELT ROUTING DECAL		
10	363023	2	DANGER DECAL		
11	363001	1	CAUTION DECAL		
12	363290	1	REFUEL CAUTION LABEL		
13	453010	1	OIL DECAL		
14	453009	1	ENCORE W/LOGO		
15	423197	1	CONTROL DECAL		

Notes:

Notes:

Notes:

Notes:

Notes:

