

Z Series Grass Catcher



Instructional / Parts Manual

Part Number: 151020 (154017 & 154026) &
Drive Kits (152030, 152031,
152032)

January 2004



ENCORE
POWER EQUIPMENT

Table of Contents

- Z RIDER GRASS CATCHER TWO PACKAGED ITEMS LIST
 - 154017 BLOWER ASSEMBLY BOX ITEMS A - 1
 - 154026 CATCHER HOOD BOX ITEMS WITH BOLT BAG CONTENTS
 - Z SERIES DRIVE KITS A - 2

- ASSEMBLY INSTRUCTION B - 1

- PARTS MANUAL
 - BLOWER ASSEMBLY C - 1
 - HOOD ASSEMBLY C - 3
 - COUNTER BALANCE ASSEMBLY C - 5

Z RIDER GRASS CATCHER TWO PACKAGED ITEMS

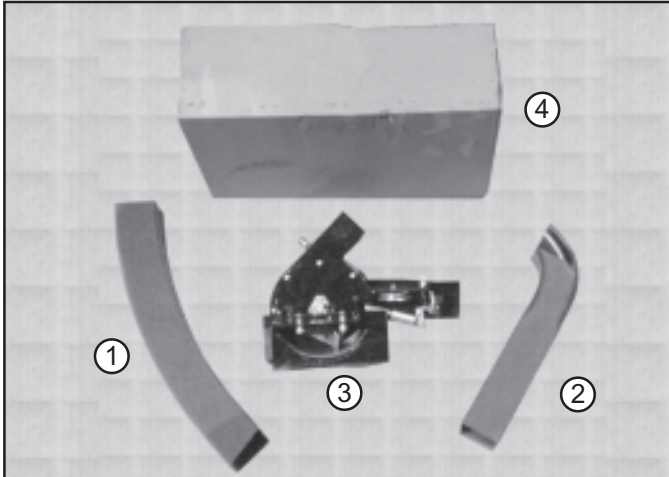

154017 BLOWER ASSY BOXED (BOX 1 OF 2)

#	PART #	QTY	PART NAME
1	153120	1	LOWER CHUTE
2	153121	1	UPPER CHUTE
3	NA	1	BLOWER ASSY.
4	NA	1	Z CATCHER BLOWER BOX

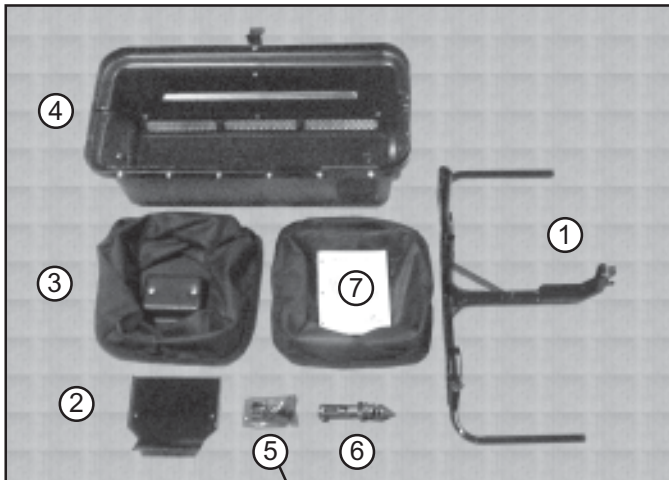

154026 CATCHER HOOD BOXED (BOX 2 OF 2)

#	PART #	QTY	PART NAME
1	152052	1	BAG FRAME w/ LATCH
2	153156	1	GRASS CATCHER BRACE
3	153171	2	SEWN BAG w/FRAME
4	NA	1	HOOD ASSY
5	NA	1	GRASS CATCHER BOLT BAG
6	NA	1	COUNTER BALANCE ASSY
7	933167	1	ASSEMBLY / PARTS MANUAL

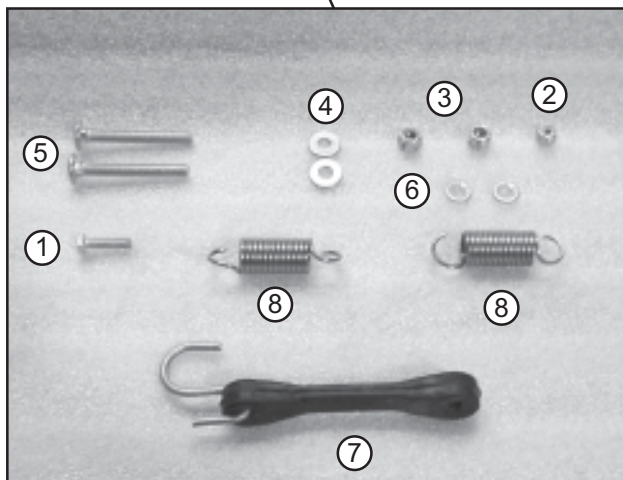

BOLT BAG

#	PART #	QTY	PART NAME
1	100254	1	1/4-20 X 1 HHCS
2	104255	1	1/4-20 NYLOC NUT
3	104256	2	5/16-18 NYLOC NUT
4	105256	2	1/4 STD. FLATWASHER
5	107512	2	5/16-18 X 2-1/2 CARR. HD. BOLT
6	153045	2	5/16 PUSH NUT
7	153050	1	TUBE TIE DOWN
8	523048	2	PUMP IDLER SPRING

Z RIDER GRASS CATCHER DRIVE KITS

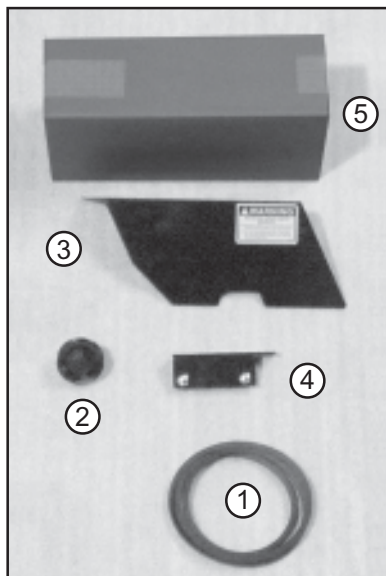

152030 Z42 DRIVE KIT

#	PART #	QTY	PART NAME
1	153062	1	BLOWER DRIVE BELT (A71)
2	153129	1	Z42 DRIVE PULLEY 3"
3	104256	2	5/16-18 NYLOC NUT
3	107258	2	5/16 STD. FLATWASHER
3	107503	2	5/16-18 X 3/4 CARR. HD. BOLT
3	109030	2	5/16 RETAINING CLIP
3	153144	1	BELT GUARD Z42
3	823323	1	ROTATING PARTS DECAL
4	153146	1	BELT GUARD MOUNT Z42
5	NA	1	BOX – DRIVE GUARD

This Drive Kit is used on the follow unit(s):
42K17Z

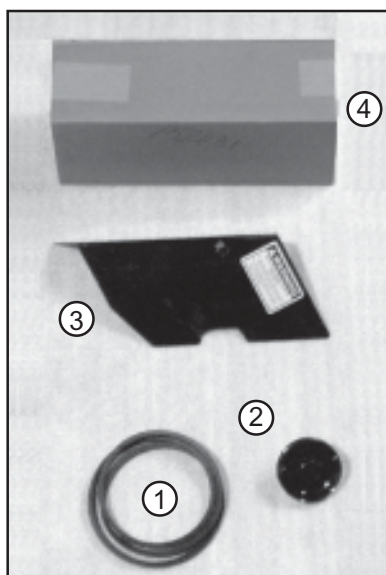

152031 Z48 DRIVE KIT

#	PART #	QTY	PART NAME
1	153062	1	BLOWER DRIVE BELT (A71)
2	153130	1	Z48 DRIVE PULLEY 4"
3	153082	1	BLOWER BELT GUARD
3	823323	1	ROTATING PARTS DECAL
4	NA	1	BOX – DRIVE GUARD

This Drive Kit is used on the follow unit(s):
48K19Z

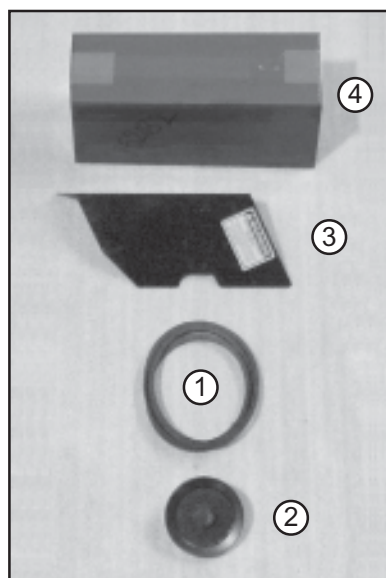

152032 Z52 DRIVE KIT

#	PART #	QTY	PART NAME
1	153158	1	DRIVE BELT – Z52 (A79)
2	153131	1	Z52 DRIVE PULLEY 5-1/2"
3	153082	1	BLOWER BELT GUARD
3	823323	1	ROTATING PARTS DECAL
4	NA	1	BOX – DRIVE GUARD

This Drive Kit is used on the follow unit(s):
52K21Z

ASSEMBLY INSTRUCTION

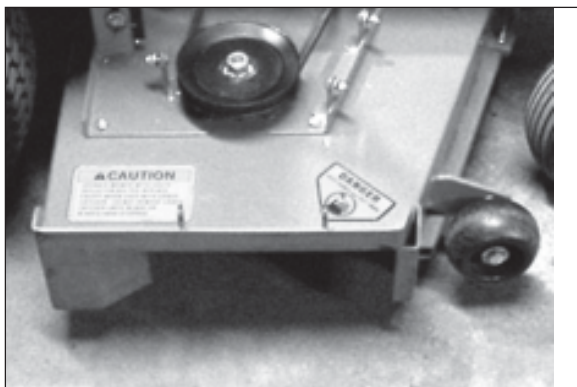

Figure 1
Using 1/2" wrench, remove the discharge cover and the RH deck belt shield from the deck.

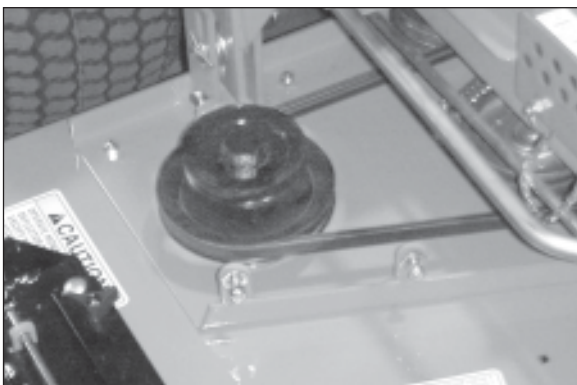

Figure 2
Remove retaining nut on RH spindle using a 1-1/8" socket and replace with threaded drive pulley supplied in the drive kit. Add loctite to the threads and tighten down drive pulley using 1-1/4" socket. Torque to 90 ft-lbs.

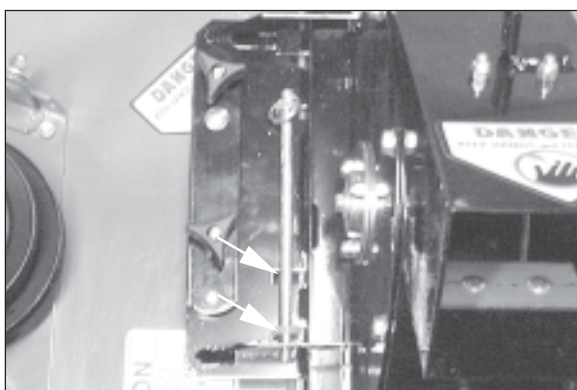

Figure 3
Install blower assembly using rear slots for the Z52 and the front slots for the Z42 & Z48. Slide the blower retaining pin through mount tabs and tighten blower against retaining pin by tightening the elevator knobs mounted on the blower.

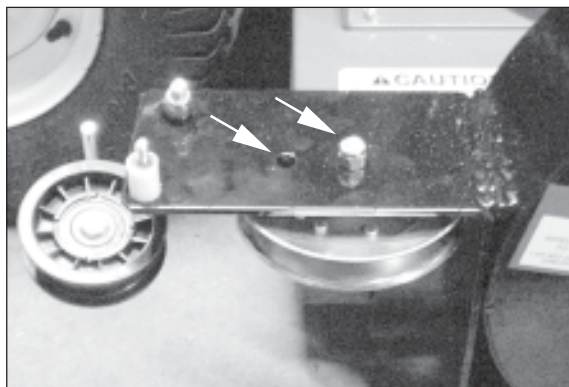

Figure 4
Using a 7/16" socket, remove the blower belt shield to locate the stationary V-idler. Make certain the V-idler is mounted in the appropriate hole. Use the front hole for the Z48 & Z52 and the rear hole for the Z42.

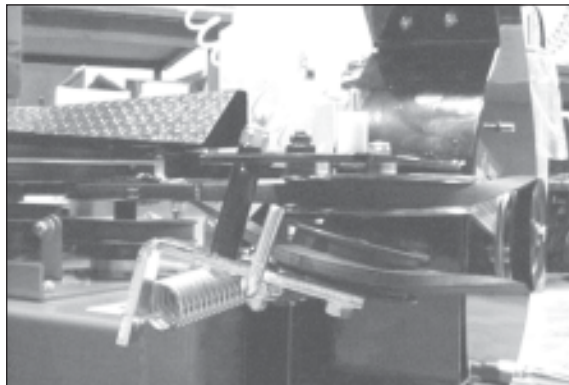

Figure 5
Install the blower drive belt by feeding the belt between the tensioner idler mount and the stationary V-idler. With the "V" portion of the belt riding inside the stationary V-idler, route the belt around towards the blower pulley. Wrap the belt clockwise over the top of the blower pulley giving it a half twist as it comes off the bottom and back towards the tensioner pulley making certain the backside of the belt rides against the tensioner idler. Finish by looping the belt over the drive pulley on the deck in a clockwise direction.

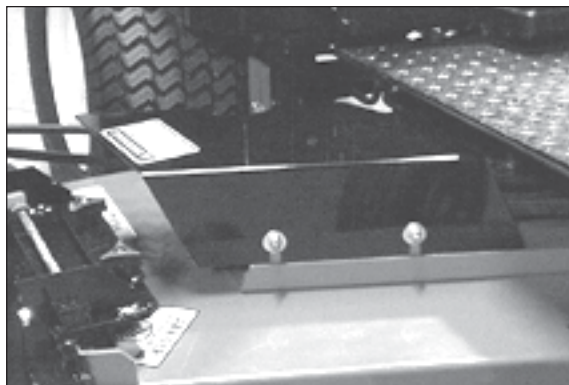

Figure 6

ASSEMBLY INSTRUCTION

Install the spindle pulley guard found in the drive kit using the existing 5/16" washers and nyloc nuts. Note: *There is an adapter bracket for the Z42 that must be installed prior to mounting this guard.*



Figure 7
Remove the left front deck lift chain assembly and L-bracket by loosening the 3/8" whizlock nut and bolt from the deck mount tab and loosening the 3/8" nyloc nut and bolt that secures the chain assembly to the deck lift crank.

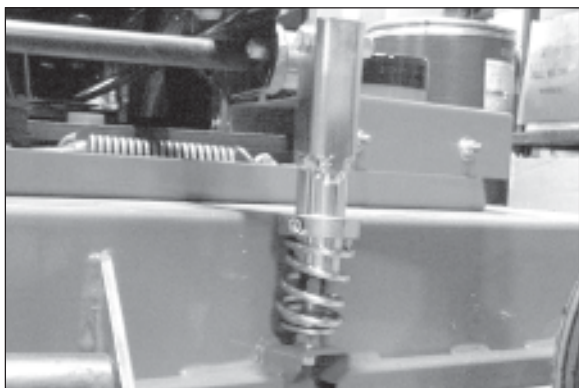

Figure 8
Install the counter balance assembly supplied in the hood box. Push down on the deck and slide clamp collar down onto the spring until there is resistance. Tighten down clamp collar.

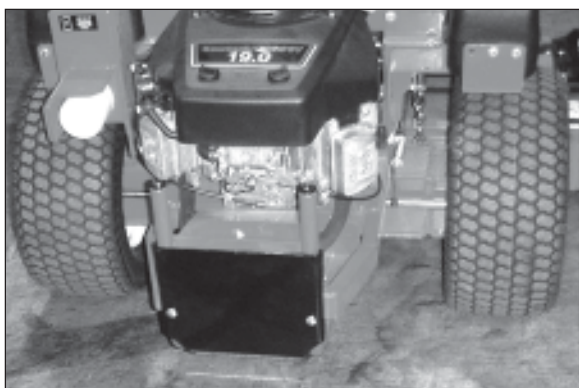

Figure 9
Remove the 5/16" bolts that secure the skid bars to the rear frame. Mount the grass catcher brace

supplied in the hood box to the rear skid bars using the 5/16" x 2-1/2" carriage bolts supplied in the bolt bag. Use the existing 5/16" nyloc nuts.

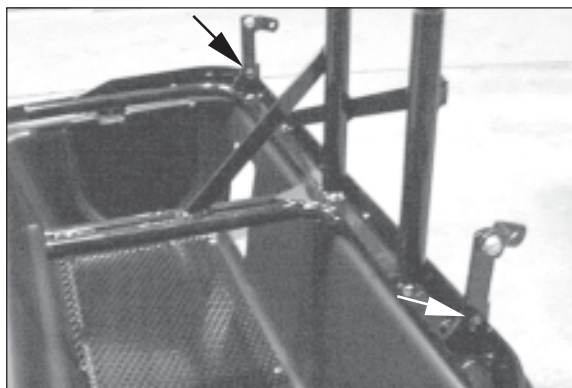

Figure 10
Lay the catcher hood on the floor upside down and slide pins on the catcher frame through the holes on the catcher hood. Secure into place using the 5/16" push nuts supplied in the bolt bag.

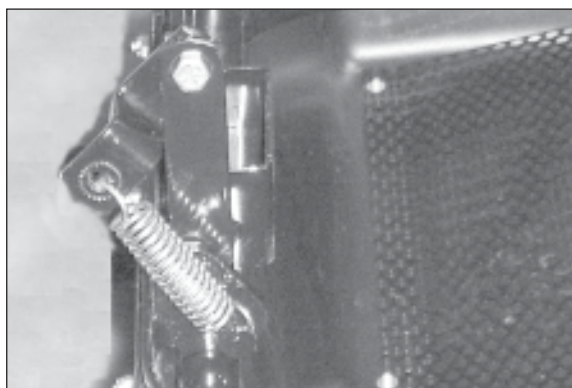

Figure 11
Mount tension springs supplied in the bolt bag onto the hood spring "Z" bracket and catcher frame pin.



Figure 12
Slide the assembled hood and frame onto the rear skid bars. Let the assembly slide all the way down to the grass catcher brace.

ASSEMBLY INSTRUCTION



Figure 13
Install the grass bags by sliding the mounting hook into the hanger mount.



Figure 14
Close the grass catcher hood & secure the hood latch.



Figure 15
Slide the upper grass tube into the opening of the catcher hood.

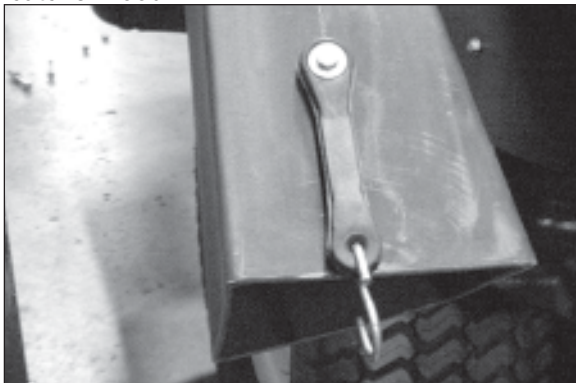

Figure 16

Fasten the tie down strap to the lower discharge tube using the 1/4" bolt, washers, and nut supplied in bolt bag.

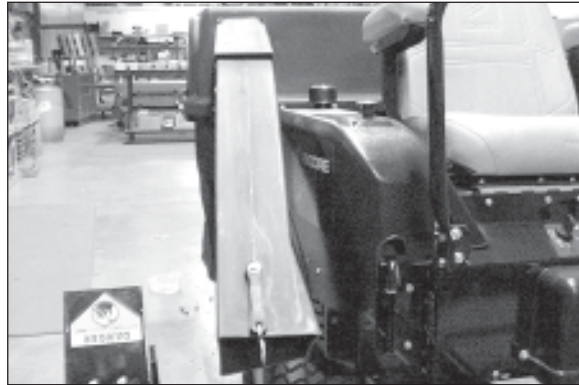

Figure 17
Slide the lower tube into the upper tube as illustrated.

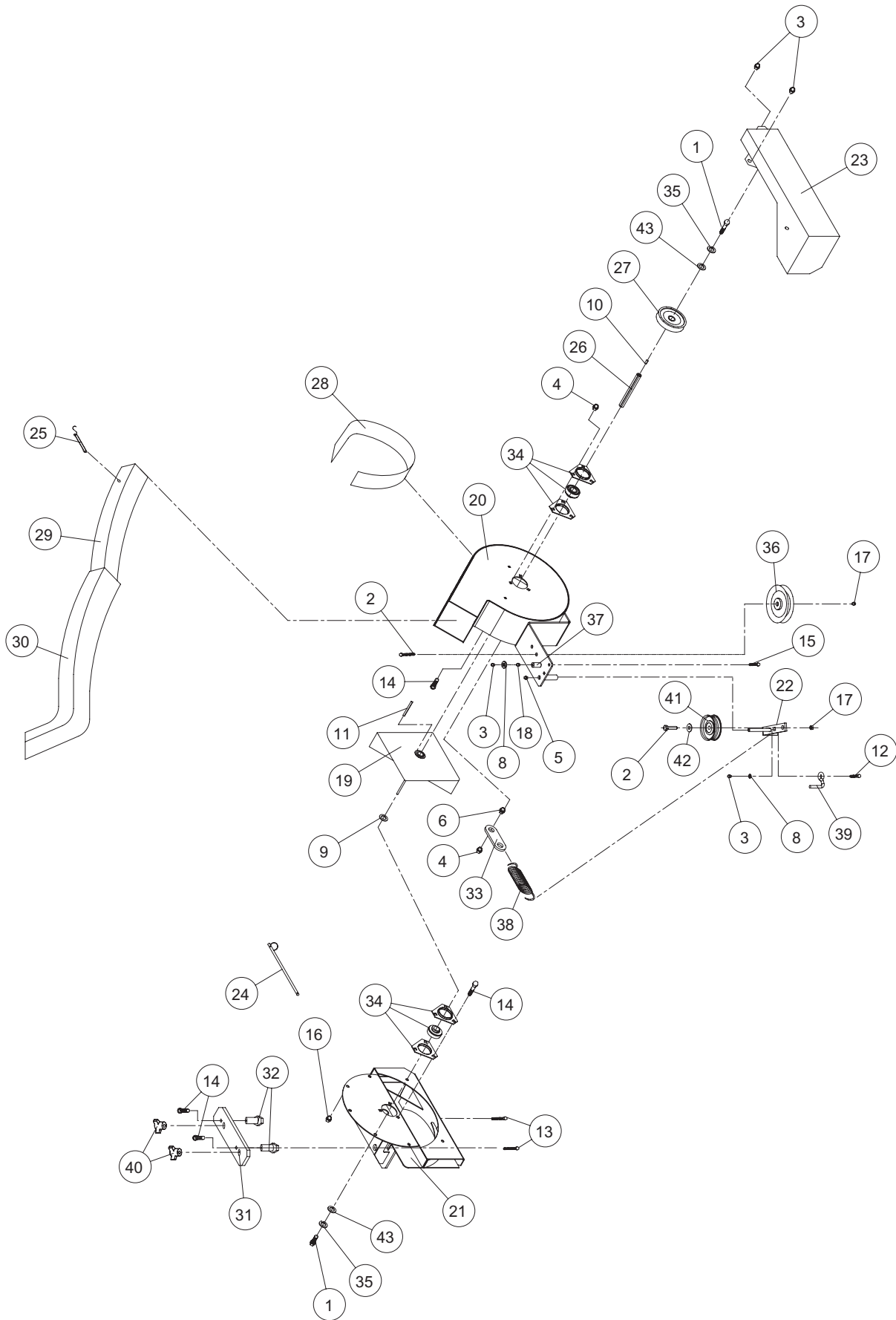

Figure 18
Attach the lower discharge tube to the blower assembly by hooking the tie down strap to the eyelet on the blower.



Figure 19
This completes the installation of your new Encore grass catcher system. Note that when engaging the PTO switch; always make certain the unit is running 3/4 to full throttle so as to prevent stalling.

Z RIDER GRASS CATCHER BLOWER ASSY - 154015



Z RIDER GRASS CATCHER BLOWER ASSY - 154015

#	PART NO.	QTY	DESCRIPTION
1	100273	2	5/16-18 X 1 HHCS
2	100294	2	3/8"-16 X 1 1/2" HEX BOLT
3	104255	8	1/4"-20 NYLOC NUT
4	104256	7	5/16-18 NYLOC NUT
5	104257	1	3/8"-16 NYLOC NUT
6	104751	1	5/16-18 JAM NUT
7	-----	--	-----
8	105256	3	1/4" FLAT WASHER
9	105269	1	3/4 SAE FLATWASHER
10	107253	1	3/16" X 3/16" X 1/2" KEY
11	107266	1	3/16 X 3/16 X 2 MACH. KEY
12	107510	1	1/4"-20 X 1" CARRIAGE BOLT
13	107520	2	5/16"-18 X 1 3/4" TAP BOLT
14	107522	8	5/16"-18 X 5/8" CARRIAGE BOLT
15	107523	1	1/4"-20 X 1 1/2" CARRIAGE BOLT
16	109001	4	5/16"-18 WHIZLOCK NUT
17	109007	2	3/8"-16 WHIZLOCK NUT
18	109011	3	1/4 RETAINING CLIP
19	152016	1	IMPELLER
20	152020	1	HOUSING WELDMENT
21	152022	1	MOUNT WELDMENT
22	152024	1	IDLER ARM
23	152027	1	BELT COVER
24	153046	1	RING PIN
25	153050	1	BLOWER TIE DOWN
26	153066	1	DRIVE SHAFT
27	153072	1	PULLEY(DRIVEN)
28	153110	1	BLOWER LINER
29	153120	1	LOWER BLOWER TUBE
30	153121	1	UPPER BLOWER TUBE
31	153133	1	ADAPTER STRAP
32	153135	2	ADAPTER RAM
33	153138	1	SPRING MOUNT
34	153216	2	TRIANGLE FLANGE BEARING
35	363226	2	5/16 DISC SPRING WASHER
36	483025	1	IDLER PULLEY
37	523144	1	PIVOT BUSHING
38	523327	1	SPRING
39	553025	1	BELT GUIDE
40	753028	2	KNOB
41	823351	1	DRIVE IDLER
42	105259	1	3/8 SAE FLATWASHER
43	105258	2	IMPELLER SHAFT WASHER

Z RIDER GRASS CATCHER HOOD ASSY - 154026

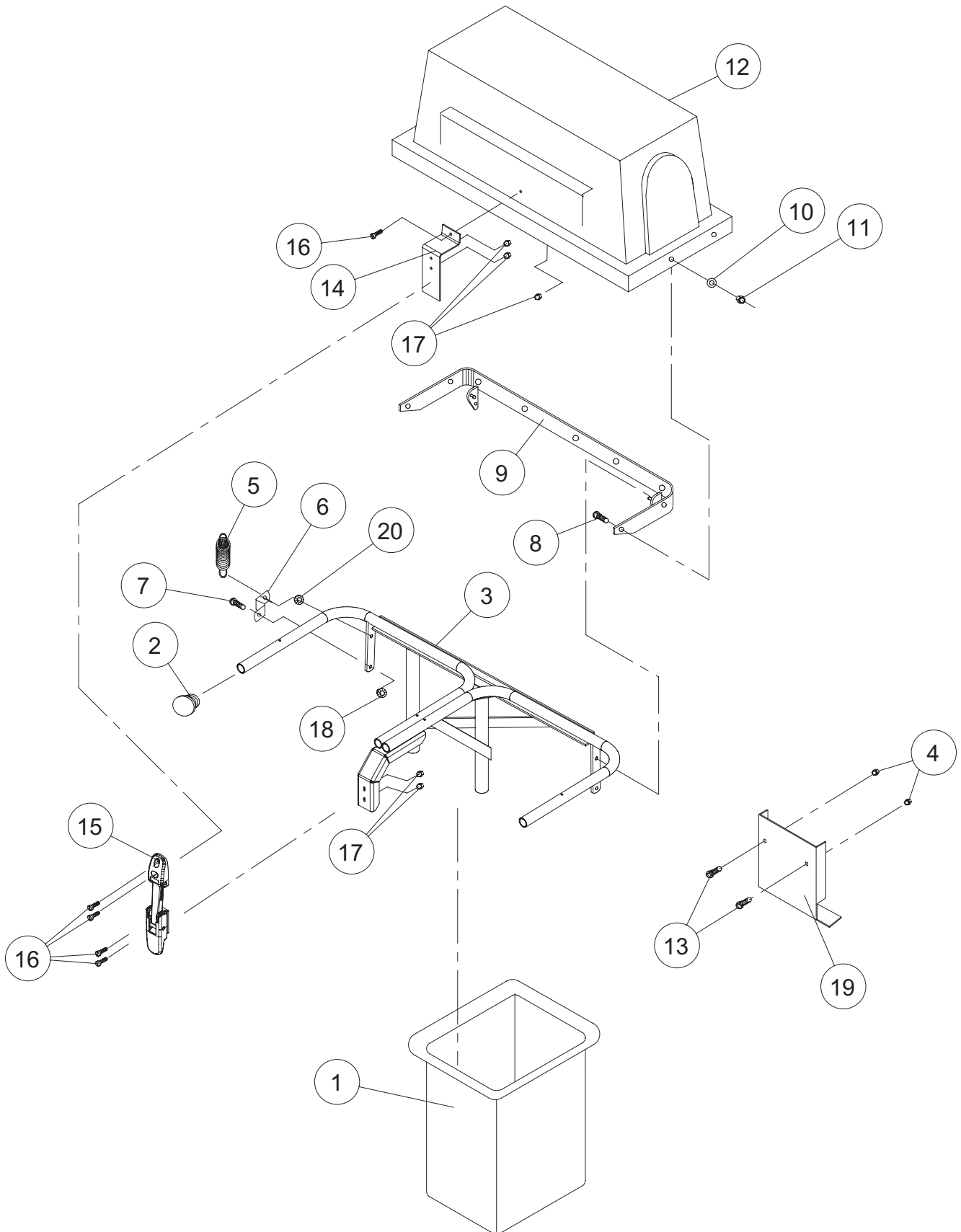

Z RIDER GRASS CATCHER HOOD ASSY - 154026

#	PART NO.	QTY	DESCRIPTION
1	153171	2	SEWN BAG w/FRAME
2	523033	4	HANDLE PLUG
3	152052	1	BAG FRAME w/ LATCH
4	104256	2	5/16"-18 NYLOC NUT
5	523048	2	SPRING
6	153056	2	HOOD SPRING BRACKET
7	100271	2	5/16"-18 X 3/4" HEX BOLT
8	107502	10	1/4"-20 X 3/4" CARRIAGE BOLT
9	152009	1	HOOD STRAP
10	105256	10	1/4" FLAT WASHER
11	104255	10	1/4"-20 NYLOC NUT
12	153059	1	BLOWER HOOD
13	107512	1	5/16" X 2 1/2" CARRIAGE BOLT
14	153188	1	UPPER LATCH MOUNT
15	153218	1	HOOD LATCH
16	101039	5	#10-24 X 5/8" LG PAN HD SCREW
17	104252	5	#10-24 HEX NYLOCK NUT
18	109001	2	5/16"-18 WHIZLOCK NUT
19	153156	1	GRASS COLLECTOR BRACE
20	153045	2	5/16" PUSH NUT

OPTIONS:

522169	1	WEIGHT BRACKET KIT
821017	1	FC WEIGHT KIT (60 lb. weight)

Z RIDER GRASS CATCHER COUNTER BALANCE ASSY

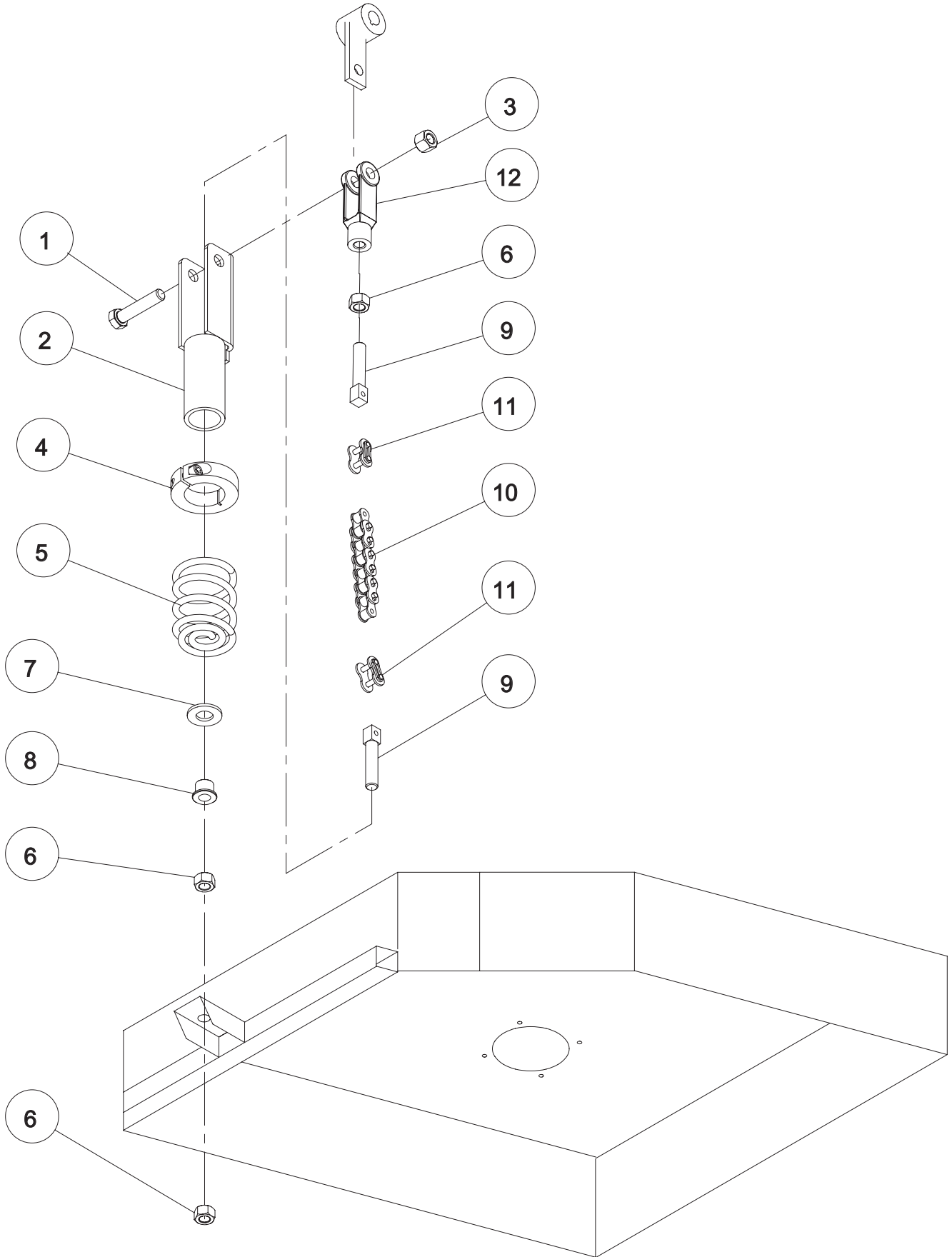

Z RIDER GRASS CATCHER COUNTER BALANCE ASSY

#	PART NO.	QTY	DESCRIPTION
1	100295	1	3/8"-16 X 1 3/4" LG HHCS
2	152029	1	COUNTER BALANCE WLDMT
3	104257	1	3/8" NYLOC NUT
4	153162	1	SPRING CLAMP
5	523278	1	SPRING
6	109008	3	3/8" UNF WHIZLOCK
7	105264	1	1/2" STD FLATWASHER
8	123044	1	PIN BUSHING
9	523125	2	ANCHOR STUD
10	423180	1	FRONT LIFT CHAIN
11	523123	2	CONNECTOR LINK
12	363192	1	LARGE YOKE

NOTE: ONLY SOLD AS INDIVIDUAL PARTS

Notes:

Notes:

