



72K28A

**PARTS
MANUAL**

PROWLER
72K27L
SECTION

72" MID-CUT DECK ASSEMBLY

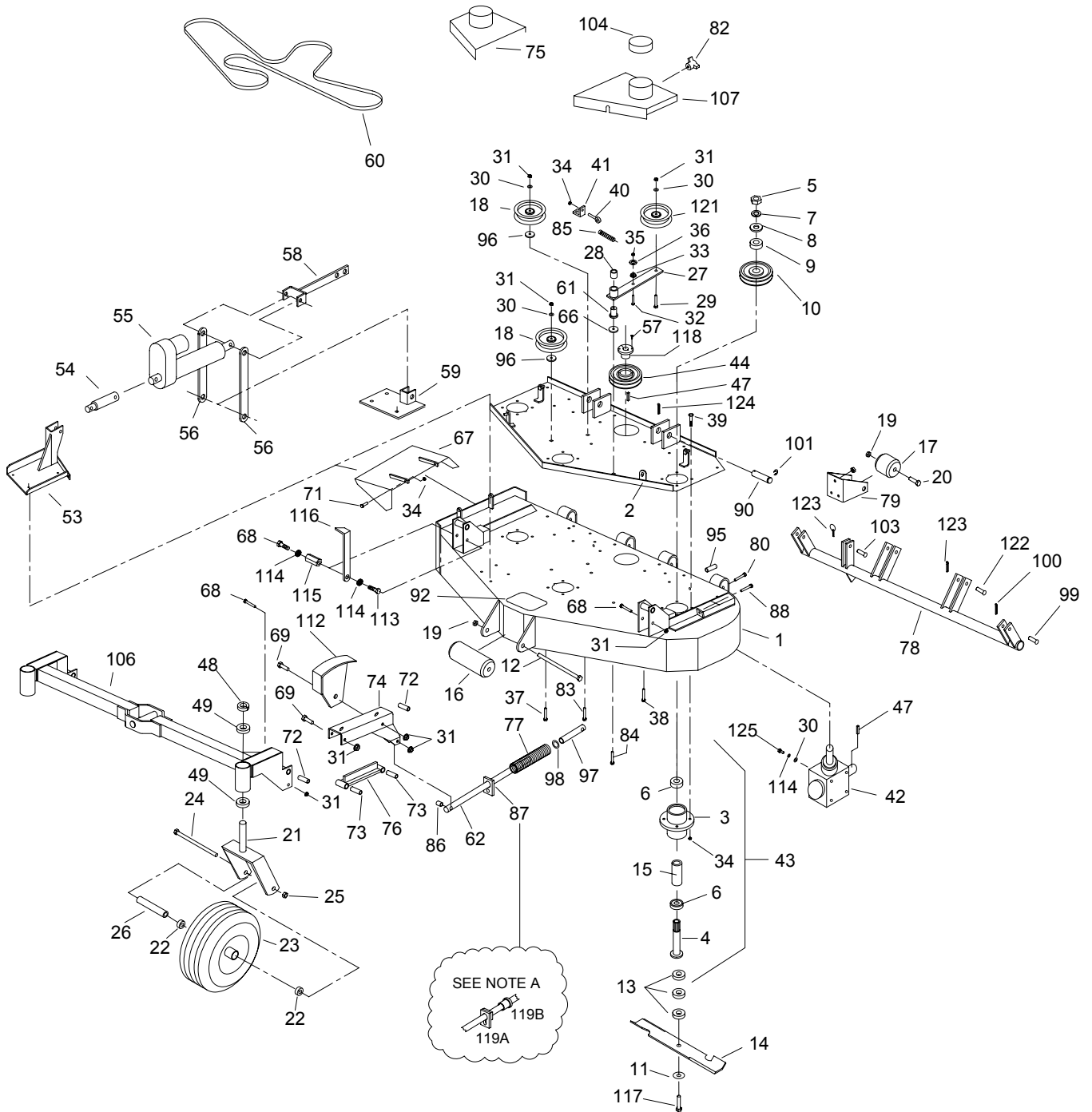

72" Mid-Cut Deck Assembly

#	PART NO.	QTY	DESCRIPTION
1	582096	1	72" MC DECK WELDMENT
2	582098	1	72" DECK CHANNEL
3	583111	3	SPINDLE HOUSING
4	583112	3	SPINDLE SHAFT
5	104511	3	3/4"-16 HEX NUT
6	363350	6	BEARING - BLADE SPINDLE
7	105010	3	3/4" LOCK WASHER
8	105269	3	3/4" SAE FLAT WASHER
9	583110	3	PULLEY SPACER
10	583107	3	PULLEY - SPINDLE 5 3/4"
11	583108	3	5/8" SPRING DISC WASHER
12	100351	1	5/8"-11 X 8 1/2" HEX BOLT
13	583109	9	BLADE SPACER
14	583287	3	25" OFFSET BLADE
15	583113	3	BEARING SPACER TUBE
16	603023	1	ANTI-SCALP ROLLER
17	523084	2	REAR DECK ROLLER
18	583162	2	6" FLAT IDLER
19	104261	3	5/8"-11 NYLOC NUT
20	100346	2	5/8"-11 X 4 1/2" HEX BOLT
21	822088	2	WIDE TAIL WHEEL STRUT
22	363187	4	1" BEARING
23	823220	2	WIDE TAIL WHEEL (COMPLETE)
23A	823339	X	TIRE (13 X 6.5 X 6)
23B	823338	X	FRONT RIM W/ VALVESTEM
24	100352	2	5/8"-11 X 9" HEX BOLT
25	104261	2	5/8"-11 NYLOC NUT
26	823245	2	AXLE TUBE (WTW)
27	822144	1	DECK IDLER ARM W/BUSHING
28	523111	1	3/4" PLASTIC BUSHING
29	107511	1	3/8"-16 X 2" CARRIAGE BOLT
30	105260	8	3/8" FLAT WASHER
31	104257	16	3/8"-16 NYLOC NUT
32	100275	1	5/16"-18 X 1 1/2" HEX BOLT
33	109001	2	5/16"-18 WHIZLOCK NUT
34	104256	36	5/16"-18 NYLOC NUT
35	109007	2	3/8"-16 WHIZLOCK NUT
36	105258	9	5/16" FLAT WASHER
37	107503	10	5/16"-18 X 3/4" CARRIAGE BOLT
38	107509	5	5/16"-18 X 1" CARRIAGE BOLT
39	100274	12	5/16"-18 X 1 1/4" HEX BOLT
40	363080	1	EYEBOLT - RIGHT

72" Mid-Cut Deck Assembly

#	PART NO.	QTY	DESCRIPTION
41	523094	1	SPRING MOUNT - DECK
42	583166	1	GEAR BOX LARGE
43	583106	3	BLADE SPINDLE ASSY
44	583447	1	6" TAPER LOCK SHEAVE
46	105005	4	5/16" LOCK WASHER
47	107255	1	3/16" X 1" KEY
48	363145	2	1" CLAMP COLLAR
49	363187	2	1" FLANGE BEARING
53	582182	1	MC LIFT RISER WELDMENT
54	583236	1	ACTUATOR EXTENSION
55	583294	1	ELECTRIC ACTUATOR
56	583499	2	E.L. PIVOT ARM
57	100252	6	1/4"-20 X 3/4" HEX BOLT
58	582217	1	E.L. RAM WELDMENT
59	582215	1	E.L. PIVOT MOUNT WELDMENT
60	583153	1	72" DECK BELT
61	423175	1	PUMP IDLER PIVOT
62	583474	2	CASTER ROD
66	373089	1	3/8" RETAINING WASHER
67	582108	1	DEFLECTOR SHIELD 72"
68	100300	4	3/8"-16 X 3" HEX BOLT
69	100301	4	3/8"-16 X 3 1/4" HEX BOLT
71	100273	2	5/16"-18 X 1" HEX BOLT
72	823330	4	CASTER ARM PIVOT
73	823090	4	CASTER BAR PIVOT
74A	582053	1	LEFT HAND CASTER ARM
74B	582051	1	RIGHT HAND CASTER ARM
75	582100	1	RIGHT HAND BELT SHIELD
76	582059	2	CASTER BAR WELDMENT
77	823150	2	SPRING
78	582112	1	72" DECK TUBE WELDMENT
79	583074	2	ROLLER MOUNT
80	100298	2	3/8"-16 X 2 1/2" HEX BOLT
82	753028	4	KNOB
83	107516	2	3/8" X 2 1/4" CARRIAGE BOLT
84	107513	3	3/8"-16 X 3" CARRIAGE BOLT
85	593074	1	FLOATING IDLER SPRING
86	823153	2	SPACER - DECK
87	823159	2	SPRING SLIDE
88	100030	2	3/8"-16 X 3" TAP BOLT
90	823333	2	DECK ATTACH PIN
91	108001	3	3/16" QUICK PIN

72" Mid-Cut Deck Assembly

#	PART NO.	QTY	DESCRIPTION
92	823200	1	STEP TREAD
95	823314	2	TUBE SADDLE SPACER
96	483017	2	RIGHT HAND IDLER SPACER
97	583472	2	CASTER ROD END
98	109025	2	5/8" HEAVY WASHER
99	823210	2	1/2" X 2" CLEVIS PIN
100	106763	2	1/8" COTTER PIN
101	108510	4	7/8" E-RING
103	823209	2	1/2" X 1 1/2" CLEVIS PIN
104	363161	3	BELT SHIELD CAP
106	582090	1	FRONT AXLE - 72MC
107	582102	1	BELT SHIELD LEFT HAND 72"
112	582176	1	CUT GAGE WELDMENT
113	100291	1	3/8"-16 X 3/4" HEX BOLT
114	105006	2	3/8" LOCKWASHER
115	583422	1	NUT-CUT GAGE
116	583420	1	POINTER CUT GAGE
117	100358	3	5/8"-11 X 2 1/4" HEX BOLT
118	363215	1	1" TAPER LOCK HUB
119A	592006	1	SPRING RETAINER
119B	593176	1	LIFT SPRING CUP
121	523329	1	FLOATING IDLER - FLAT
122	823211	2	1/2" X 2 1/2" RING PIN
123	106778	3	3/16" X 1 1/2" COTTER PIN
124	108001	2	3/16" QUICK PIN
125	100293	4	3/8"-16 X 1 1/4" HHCS

NOTES:

- A PREFORMANCE UPGRADE FOR DECK SPRING ASSY. REQUIRES
ITEM 119. BOTH SIDES NEED BE UPGRADED AT THE SAME TIME.

72" MID-CUT MAINFRAME ASSEMBLY

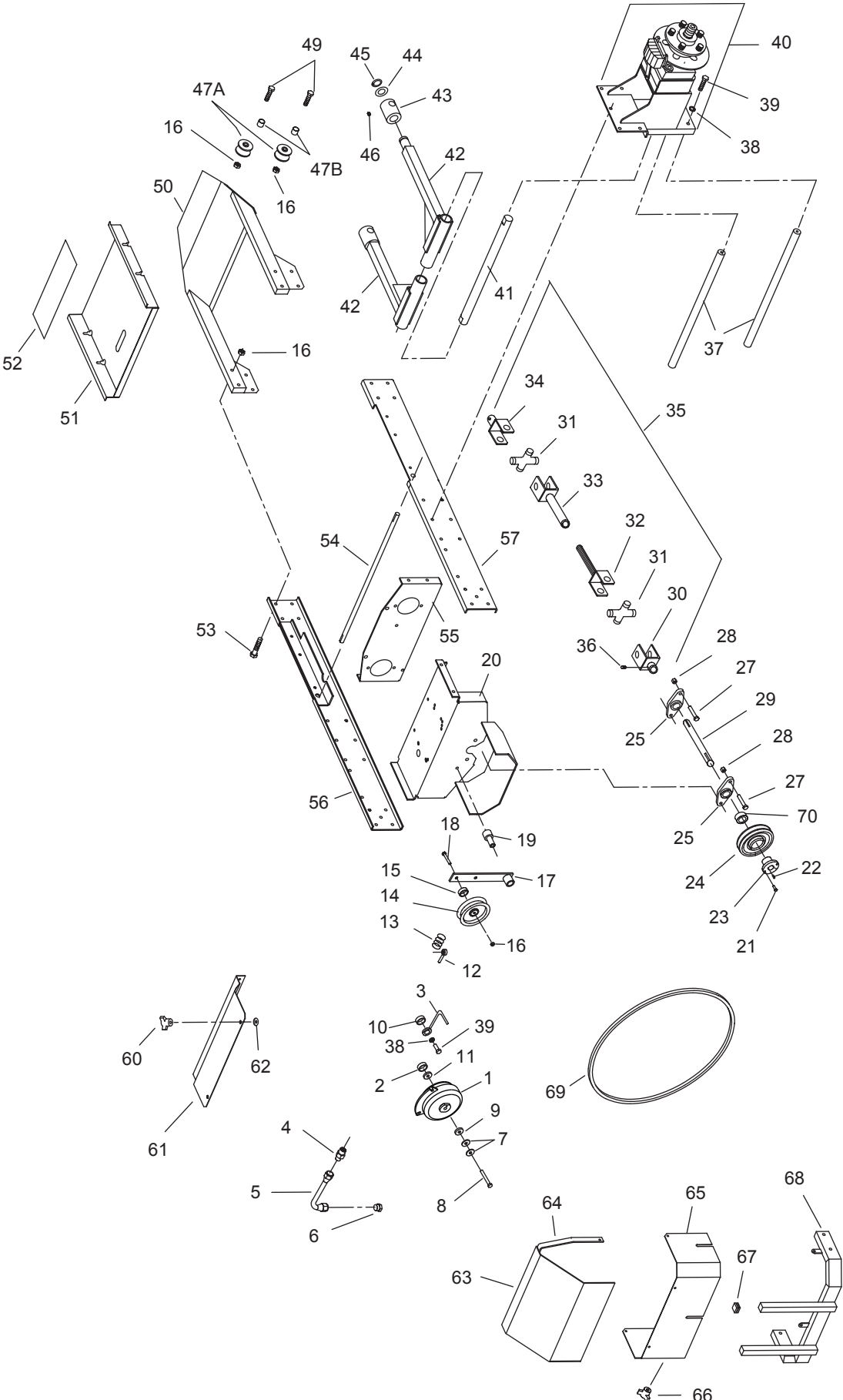

72" Mid-Cut Mainframe Assembly

#	PART NO.	QTY	DESCRIPTION
1	823165	1	ELECTRIC CLUTCH A/C KAW, KOHLER
2	583494	1	CLUTCH SPACER 9/32
3	363075	1	ROUND BELT GUIDE
4	523063	1	ENGINE DRAIN ADAPTER
5	523064	1	ENGINE DRAIN LINE
6	523065	1	ENGINE DRAIN PLUG
7	423069	2	SPRING DISC. WASHER - 7/16
8	100532	1	7/16-20 X 1-1/2 HHCS
9	423068	1	CLUTCH WASHER
10	363097	1	SPACER-TURNBUCKLE
11	823248	1	CLUTCH SPACER
12	363080	1	RIGHT EYEBOLT
13	593074	1	IDLER SPRING - HH
14	483025	1	RIGHT HAND IDLER PULLEY
15	483017	1	RIGHT HAND IDLER SPACER
16	104257	30	3/8"-16 NYLOC NUT
17	422025	1	TENSIONER W/BUSHING
X	523111	X	BUSHING (SERVICE)
18	100297	1	3/8"-16 X 2 1/4" HEX BOLT
19	823030	1	IDLER PIVOT
20	582043	1	ENGINE BASE - KAW
21	100503	2	1/4" X 3/4" HEX BOLT
22	107259	1	1/4" X 1/4" X 1" KEY
23	363215	1	TAPER LOCK HUB
24	363216	1	TAPER LOCK SHEAVE
25	823032	2	2 BOLT FLANGE BEARING
27	100311	4	7/16"-14 X 1 1/4" HEX BOLT
28	104258	4	7/16"-14 NYLOC NUT
29	583080	1	1" POWER SHAFT - MC
30	523414	1	1" YOKE
31	523415	2	CROSS
32	593075	1	YOKE SHAFT
33	583481	1	YOKE TUBE
34	823372	1	3/4" YOKE
35	593064	1	COMPLETE PTO SHAFT
36	103295	2	3/8"-16 X 1/2" SET SCREW
37	823066	2	BRACE ROD - LOWER
38	105006	7	3/8" LOCKWASHER
39	100292	24	3/8"-16 X 1" HEX BOLT
40			SEE HYDRAULIC ILLUSTRATION
41	823050	1	DECK ARM SHAFT
42	822036	2	DECK ARM

72" Mid-Cut Mainframe Assembly

#	PART NO.	QTY	DESCRIPTION
43	822090	2	DCK ARM SWVL W/ZERK
44	823015	4	DECK ARM WASHER
45	108502	2	SNAP RING
46	111004	12	1/4"-28 GREASE ZERK
47	583120	2	FRONT PIVOT ROLLER (REF ONLY)
47A	583464	2	FRONT ROLLER
47B	583490	2	FRONT ROLLER TUBE
49	100298	2	3/8"-16 X 2 1/2" HEX BOLT
50	582092	1	FRONT FRAME
51	593079	1	FOOT PLATE
52	823042	3	FOOT PLATE TREAD
53	100295	4	3/8"-16 X 1 3/4" HEX BOLT
54	823140	1	PARK SHAFT
55			SEE HYDRAULIC ILLUSTRATION
56	582041	1	LEFT HAND FRAME RAIL
57	582039	1	RIGHT HAND FRAME RAIL
60	583168	2	KNOB 5/16" STUD
61	583010	1	FRONT ENGINE COVER - IL3
62	109030	2	5/16" RETAINING CLIP
63	822146	1	REAR COVER
64	823335	2	REAR COVER STRAP
65	583504	1	REAR COVER - KAW
66	753028	2	KNOB
67	583191	2	1" SQ. TUBE PLUG
68	582061	1	ENGINE GUARD - REAR
69	583517	1	CLUTCH BELT
70	363145	1	1" CLAMP COLLAR

NOTES:

- A CONTACT ENGINE MFG FOR ALL ENGINE & RADIATOR PARTS NOT SHOWN. ENCORE MFG DO NOT SERVICE THESE PARTS!

MUFFLER COMPONENTS - NOT SHOWN

PART #	DESCRIPTION
593282	MUFFLER
623428	SHIELD, MUFFLER INNER
623430	SHIELD, MUFFLER OUTER
100252	1/4-20 X 3/74 HHCS
105256	1/4 STD FLATWASHER
109015	1/4-20 NUT CLIP
483098	EXHAUST GASKET

72" MID-CUT SEATFRAME ASSEMBLY

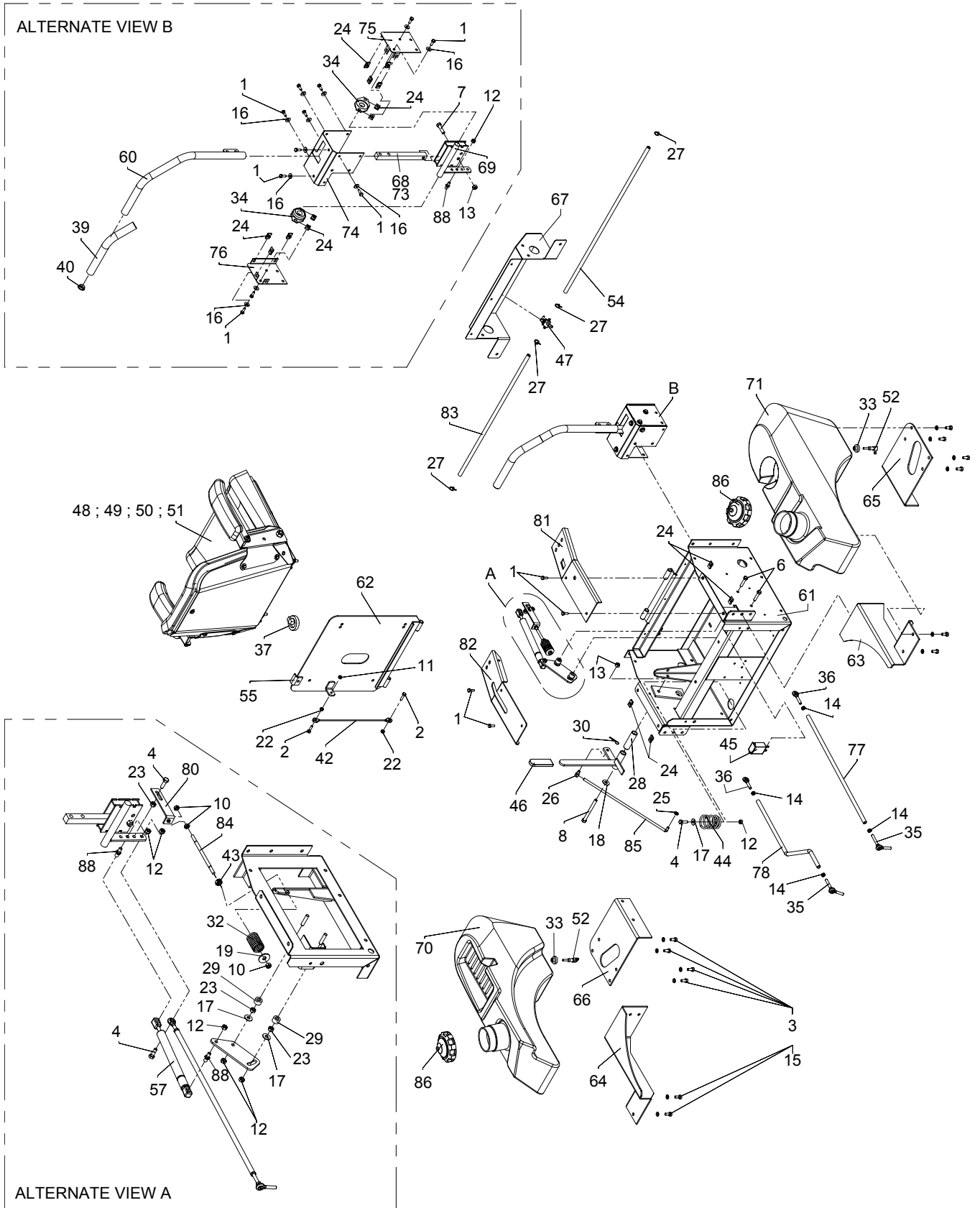

72" Mid-Cut Seatframe Assembly

#	PART NO.	QTY	DESCRIPTION
1	100252	28	1/4-20 X 3/4 HHCS
2	100254	8	1/4"-20 X 1" HEX BOLT
3	100271	19	5/16-18 X 3/4 HHCS
4	100273	8	5/16-18 X 1 HHCS
5	100274	4	5/16-18 X 1-1/4 TAP BOLT
6	100275	2	5/16-18 X 1-1/2 HHCS
7	100294	2	3/8-16 – 1-1/2 HHCS
8	100303	2	3/8-16 X 4 HHCS
9	102000	3	#12-24 X 5/8 SELF TAP. SCREW
10	104253	2	5/16-24 NYLOC NUT
11	104255	2	1/4"-20 NYLOC NUT
12	104256	33	5/16-18 NYLOC NUT
13	104257	3	3/8"-16 NYLOC NUT
14	104752	4	5/16-24 JAM NUT
15	105005	10	5/16 LOCKWASHER - HEAV
16	105256	28	1/4 STD. FLATWASHER
17	105258	4	5/16 STD. FLATWASHER
18	105260	1	3/8 WASHER - STD FLAT
19	105261	2	3/8 ANS. TYPE B FLATWASHER
20	107503	2	5/16-18 X 3/4 CARR. BOLT
21	107520	2	5/16-18 X 1-3/4 CARR BOLT
22	109000	8	1/4"-20 WHIZ LOCK NUT
23	109001	4	5/16-18 WHIZLOCK NUT
24	109015	24	1/4-20 NUT CLIP
25	153045	1	5/16 PUSH NUT
26	363029	1	.312 ROD SWIVEL
27A	363098	2	GAS LINE CLAMP
27B	363098	4	FUEL LINE CLAMP
28	363105	1	BUSHING
29	363113	4	SPACER
30	363165	1	#3 ISSCO HAIRPIN COTTER (#2)
32	373054	2	SPRING
33	393042	2	GROMMET
34	423140	4	3/4 ID 2 BOLT BEARING
35	423160	2	5/16-24 BALL STUD
36	453082	2	5/16 ROD END
37	523030	1	SEAT SWITCH
38	523031	1	PTO SWITCH
39	523032	2	HANDLE GRIP
40	523033	2	HANDLE PLUG
41	523034	1	PARK SWITCH
42	523044	1	SEAT CABLE

72" Mid-Cut Seatframe Assembly

#	PART NO.	QTY	DESCRIPTION
43	523112	2	5/16 CLAMP COLLAR
44	523278	2	SEAT SPRING
45	523283	1	HOUR METER
46	582048	1	PARK LEVER w/ GRIP
47	583050	1	FUEL VALVE
48	583077	1	SEAT LT. GREY W/TRACK
49	583089	1	SEAT CUSHION
50	583090	1	BACK CUSHION
51A	593097	1	ARM REST PAD - LH
51B	593097	1	ARM REST PAD - RH
52	583183	2	FUEL TANK ADAPTER
53	583184	1	FUEL LINE
54	583186	1	FUEL LINE – 29"
55	583224	1	SEAT STOP
56	583401	1	BATTERY MOUNT
57	583415	2	DAMPENER
58	583438	2	ADJUSTMENT PLATE
60A	592041	1	CONTROL HANDLE - RH
60B	592042	1	CONTROL HANDLE - LH
61	592008	1	SEAT FRAME WELDMENT
62	592010	1	SEAT PLATE WELDMENT
63	592012	1	RH REAR TANK MT.
64	592014	1	LH REAR TANK MT.
65	592016	1	FRONT TANK MOUNT – RH
66	592018	1	FRONT TANK MOUNT – LH
67	592020	1	CONTROL PANEL
68	592060	2	HANDLE BAR W/STOP
69A	592024	2	CONTROL PIVOT RIGHT
69B	592026	1	CONTROL PIVOT LEFT
70	593001	1	FUEL TANK/FENDER - LH
71	593002	1	FUEL TANK/FENDER - RH
72	593008	2	1-1/2" GROMMET
73	593010	2	HANDLE MOUNT BAR
74A	593022	2	RH CONTROL MOUNT
74B	593024	1	LH CONTROL MOUNT
75	593026	2	RH CONTROL COVER
76	593028	2	LH CONTROL COVER
77	593032	1	RH CONTROL LINK
78	593034	1	LH CONTROL LINK
79	593048	1	SWITCH MOUNT – NEUTRAL
80	593058	2	NEUTRAL INDICATOR
81	593067	1	RH TANK PANEL

72" Mid-Cut Seatframe Assembly

#	PART NO.	QTY	DESCRIPTION
82	593068	1	LH TANK PANEL
83	603032	1	FUEL LINE – 24"
84	823127	2	NEUTRAL LINK
85	823132	1	PARK BRAKE LINK
86	823179	2	FUEL CAP - LARGE
87	823194	1	ALARM
88	823221	4	BALL STUD

NOTES:

72" MID-CUT SMALL HYDRO PUMP ASSEMBLY

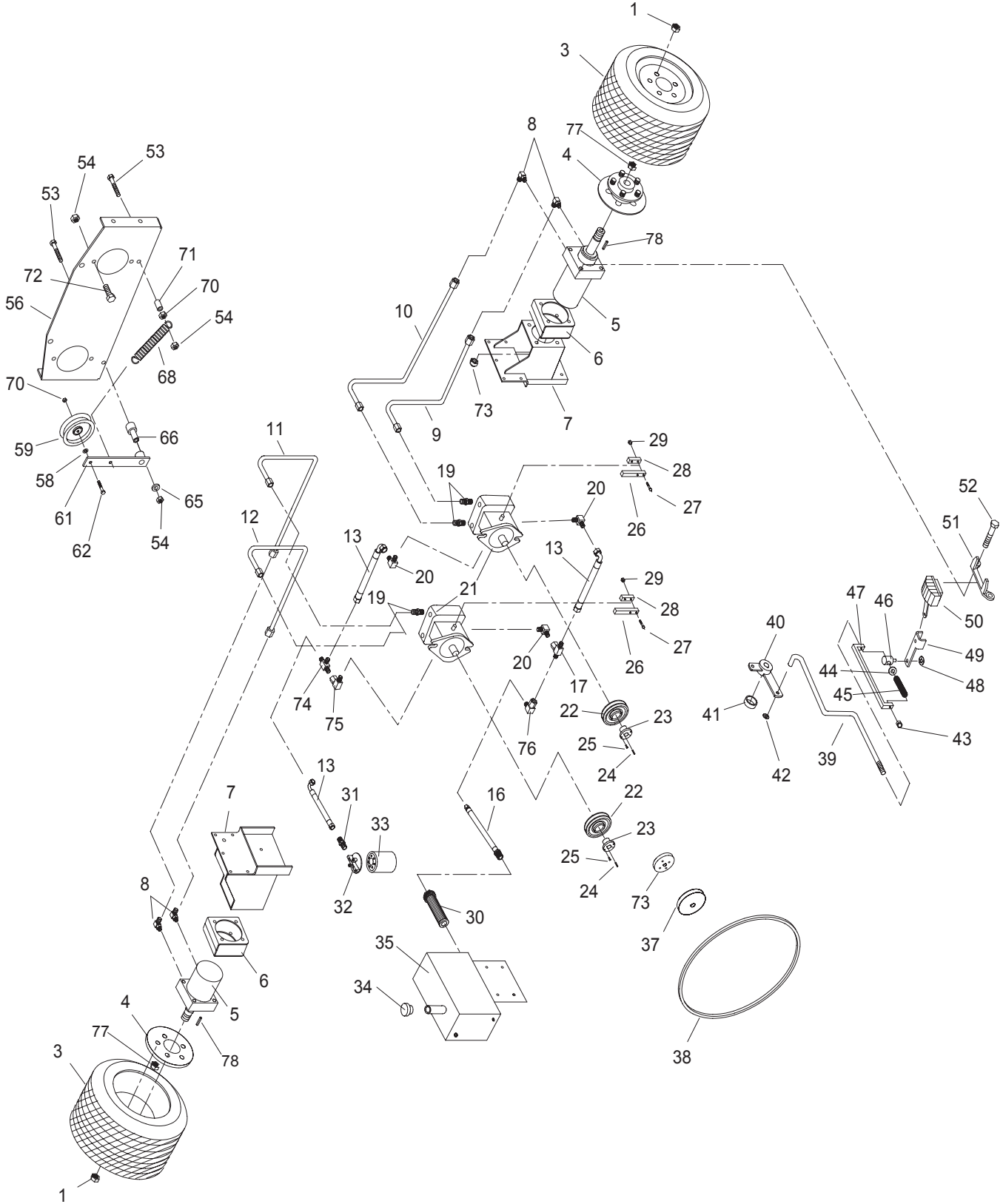

72" Mid-Cut Small Hydro Pump Assembly

#	PART NO.	QTY	DESCRIPTION
1	103023	10	LUG NUT
3	583055	2	DRIVE WHEEL ASSY (COMPLETE)
3A	583059	X	DRIVE TIRE (24 X 12 X 12)
3B	583487	X	BAR LUG TIRE (23 X 10.5 X 12)
3C	583058	X	RIM W/ VALVESTEM
4	582008	2	WHEEL HUB
5	583325	2	WHEEL MOTOR
6	582031	4	MOTOR SPACER
7A	582002	1	RIGHT HAND MOTOR MOUNT
7B	582004	1	LEFT HAND MOTOR MOUNT
8	523058	4	90 DEGREE MOTOR ADAPTER
9	583462	2	HOSE WHEEL DRIVE SHORT MC 72 (21" LG)
10	583461	1	HOSE WHEEL DRIVE LONG MC 72 (26 3/4" LG)
13	583241	2	PUMP TO PUMP HOSE
16	453129	1	PUMP TO TANK SUPPLY HOSE
17	453106	1	SWIVEL TEE
19	583126	4	STRAIGHT ADAPTER
20	453074	3	90 DEGREE ADAPTER
21	583491	2	PUMP-V (10A)
21A	583514	X	PUMP SEAL KIT - (10A)
22	583382	2	PUMP PULLEY
23	423178	2	TAPER HUB
24	453102	2	PUMP KEY
25	100252	2	1/4"-20 X 3/4" HEX BOLT
26	823104	2	CONTROL BAR
27	100257	4	1/4"-20 X 1 3/4" HEX BOLT
28	453090	2	CLAMP BAR
29	104255	6	1/4"-20 NYLOC NUT
30	583132	1	SUCTION SCREEN
31	583442	1	FILTER ADAPTER (61" & 72")
32	423064	1	FILTER HEAD
33	423063	1	HYDRO OIL FILTER (NO CROSS REF AVAIL)
34	423165	1	OIL BREATHER CAP (61" & 72")
35	583049	1	OIL TANK (61" & 72")
36	423065	1	OIL EYE
37	583217	1	PUMP DRIVE PULLEY
38	583385	1	PUMP BELT
39A	583042	1	RIGHT HAND BRAKE ROD (61" & 72")
39B	583044	1	LEFT HAND BRAKE ROD (61" & 72")
40	422049	1	BRAKE CRANK
41	373086	1	SPACER
42	104256	6	5/16" PUSH NUT

72" Mid-Cut Small Hydro Pump Assembly

#	PART NO.	QTY	DESCRIPTION
43	593116	2	BRAKE SPRING NUT
44	105257	2	5/16" FLAT SAE WASHER
45	523024	2	SPRING
46	423130	2	PARK BRAKE SWIVEL
47	593114	2	PARK BRAKE STRAP
48	363177	2	3/8" PUSH NUT
49	583460	2	BRAKE ARM
50A	583038	1	RIGHT HAND BRAKE CALIPER
50B	583039	1	LEFT HAND BRAKE CALIPER
50C	583511	X	BRAKE PAD KIT
51	583040	2	CALIPER MOUNT
52	100343	8	1/2"-13 X 9" HEX BOLT
53	100300	2	3/8"-16 X 3" HEX BOLT
54	104257	32	3/8" NYLOC NUT
56	583328	1	PUMP PLATE
58	105260	13	3/8" FLAT WASHER
59	823351	1	FLAT IDLER
61	422025	1	TENSIONER W/BUSHING
61A	523111	X	BUSHING (SERVICE)
62	100294	2	3/8"-16 X 1 1/2 HHCS
65	373089	2	RETAINING WASHER
66	393070	1	IDLER PIVOT
68	583144	1	PUMP IDLER SPRING
70	109007	2	3/8"-16 WHIZLOCK NUT
71	523277	1	SPACER
72	100293	1	3/8" -16 X 1 1/4" HHCS
73	583218	1	PULLEY ADAPTER
74	453020	1	CROSS ADAPTER
75	453076	1	90 DEG SWIVEL
76	453109	1	SWIVEL ELBOW
77	593181	2	WHEEL MOTOR SHAFT NUT - TJ
78	107013	2	KEY, 5/16 X 1.0 (1001) WOODRUFF

72" MID-CUT ELECTRICAL SECTION

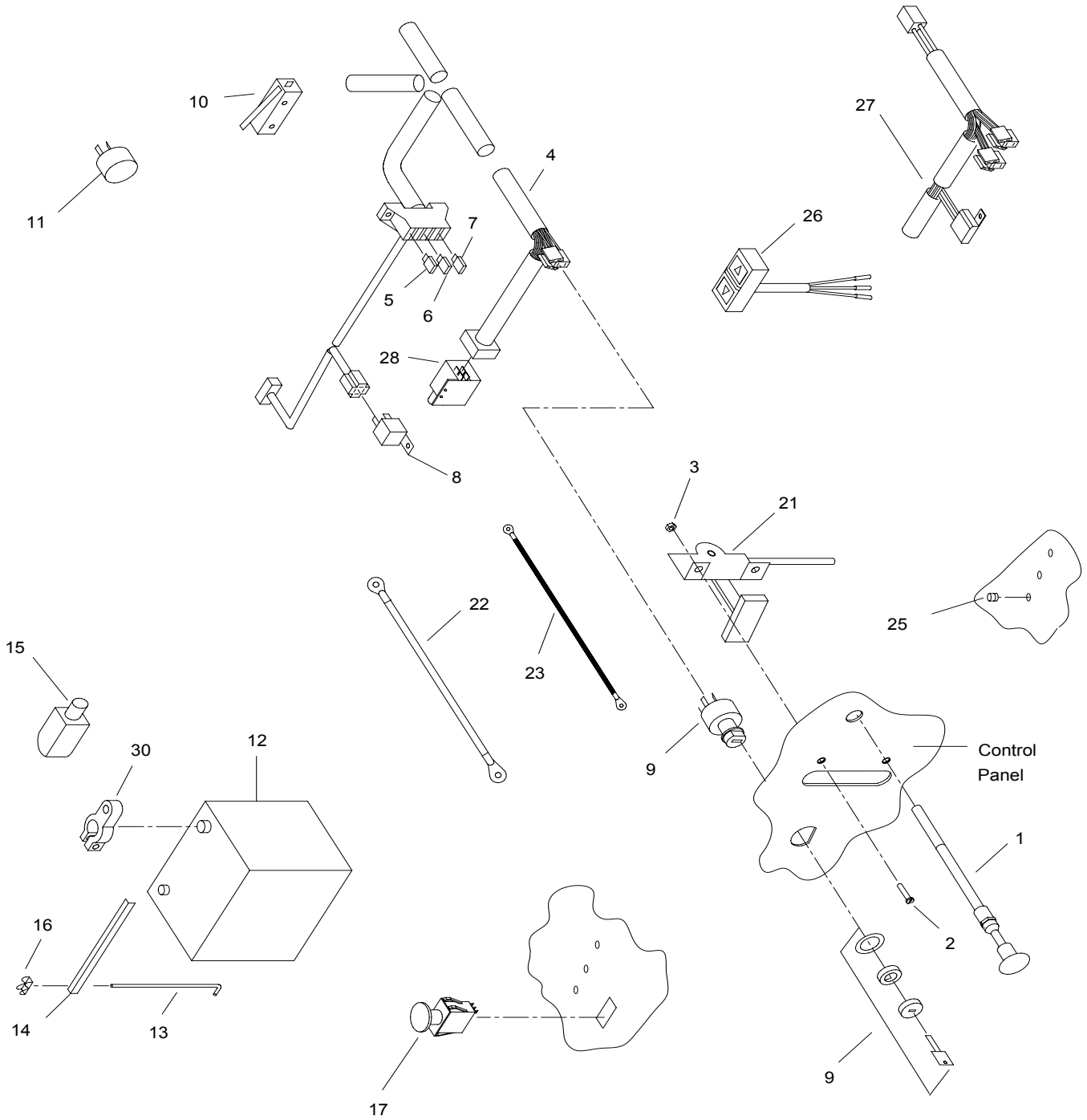

72" Mid-Cut

Electrical Section - Gas

#	PART NO.	QTY	DESCRIPTION
1	593044	1	CHOKE CABLE
2	101039	6	#10-24 X 5/8" PAN HEAD BOLT
3	104252	6	#10-24 NYLOC NUT
4	593049	1	WIRE HARNESS
5	523145	1	20 AMP FUSE
6	523146	1	15 AMP FUSE
7	523147	1	10 AMP FUSE
9	423027	1	IGNITION SWITCH ASSEMBLY
10	593041	1	NEUTRAL SWITCH
11	823194	1	ALARM
12	423142	1	12 VOLT BATTERY
13	423172	2	BATTERY HOLD DOWN
14	423011	1	BATTERY ANGLE
15	423158	1	TERMINAL INSULATOR
16	109017	2	1/4"-20 WING NUT
17	523031	1	PTO SWITCH
21	593043	1	THROTTLE CONTROL
22	823196	1	POSITIVE CABLE
23	823197	1	NEGATIVE CABLE
25	523036	3	WARNING LIGHT
26	583411	1	ELECTRIC LIFT SWITCH
27	583412	1	ELECTRIC LIFT HARNESS
28	523034	1	PARK SWITCH
32	583351	2	ELECTRIC LIFT RELAY (5 PRONG)
33	583238	1	RELAY MOUNT

NOTES:

**PROWLER
72B27LD
SECTION**

72" MID-CUT DECK ASSEMBLY

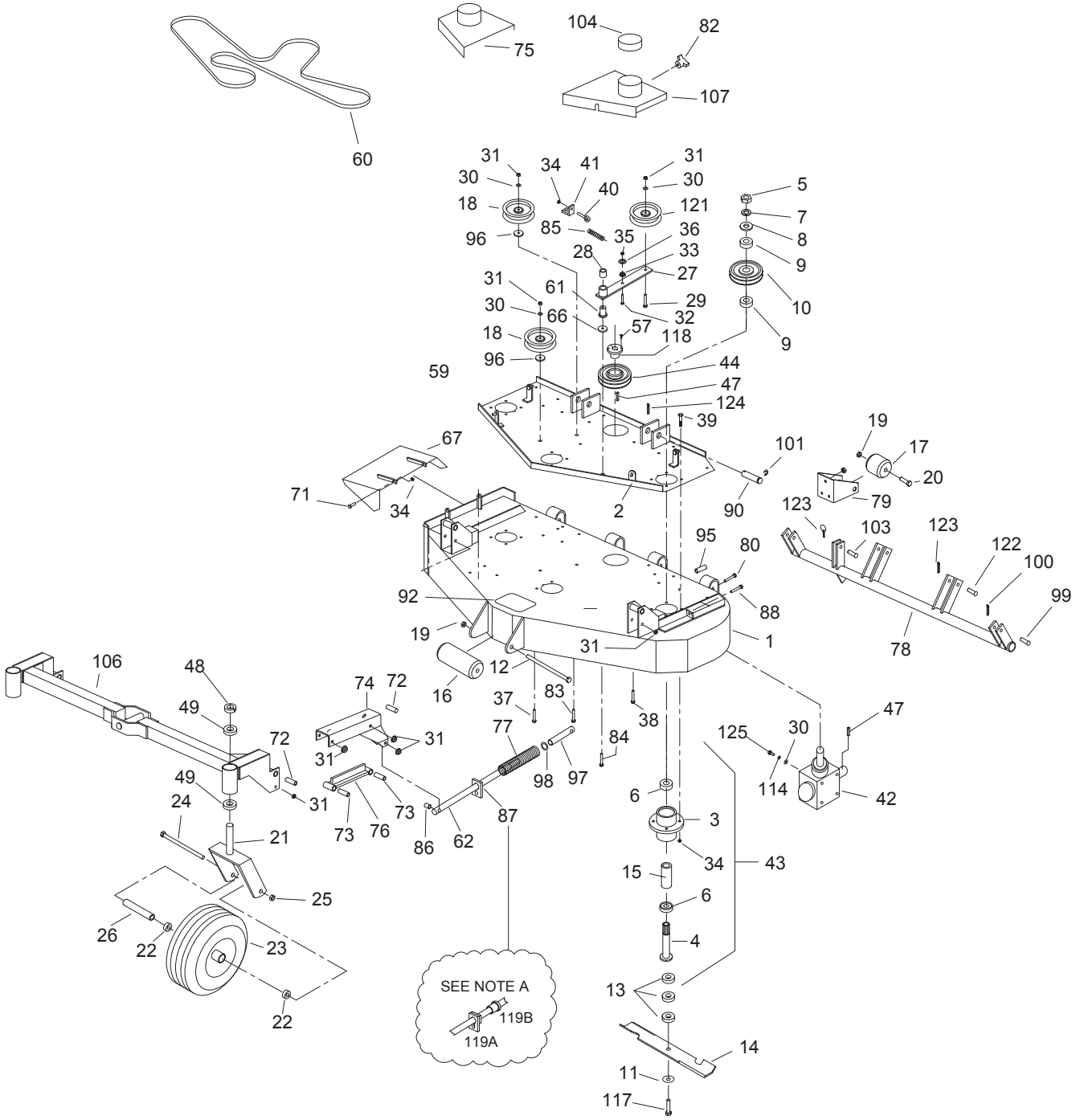

72" Mid-Cut Deck Assembly

#	PART NO.	QTY	DESCRIPTION
1	582096	1	72" MC DECK WELDMENT
2	582098	1	72" DECK CHANNEL
3	583111	3	SPINDLE HOUSING
4	583112	3	SPINDLE SHAFT
5	104511	3	3/4"-16 HEX NUT
6	363350	6	BEARING - BLADE SPINDLE
7	105010	3	3/4" LOCK WASHER
8	105269	3	3/4" SAE FLAT WASHER
9	583110	3	PULLEY SPACER
10	583107	3	PULLEY - SPINDLE 5 3/4"
11	583108	3	5/8" SPRING DISC WASHER
12	100351	1	5/8"-11 X 8 1/2" HEX BOLT
13	583109	9	BLADE SPACER
14	583287	3	25" OFFSET BLADE
15	583113	3	BEARING SPACER TUBE
16	603023	1	ANTI-SCALP ROLLER
17	523084	2	REAR DECK ROLLER
18	583162	2	6" FLAT IDLER
19	104261	3	5/8"-11 NYLOC NUT
20	100346	2	5/8"-11 X 4 1/2" HEX BOLT
21	822088	2	WIDE TAIL WHEEL STRUT
22	363187	4	1" BEARING
23	823220	2	WIDE TAIL WHEEL (COMPLETE)
23A	823339	X	TIRE (13 X 6.5 X 6)
23B	823338	X	FRONT RIM W/ VALVESTEM
24	100352	2	5/8"-11 X 9" HEX BOLT
25	104261	2	5/8"-11 NYLOC NUT
26	823245	2	AXLE TUBE (WTW)
27	822144	1	DECK IDLER ARM W/BUSHING
28	523111	1	3/4" PLASTIC BUSHING
29	107511	1	3/8"-16 X 2" CARRIAGE BOLT
30	105260	8	3/8" FLAT WASHER
31	104257	16	3/8"-16 NYLOC NUT
32	100275	1	5/16"-18 X 1 1/2" HEX BOLT
33	109001	2	5/16"-18 WHIZLOCK NUT
34	104256	36	5/16"-18 NYLOC NUT
35	109007	2	3/8"-16 WHIZLOCK NUT
36	105258	9	5/16" FLAT WASHER
37	107503	10	5/16"-18 X 3/4" CARRIAGE BOLT
38	107509	5	5/16"-18 X 1" CARRIAGE BOLT
39	100274	12	5/16"-18 X 1 1/4" HEX BOLT
40	363080	1	EYEBOLT - RIGHT

72" Mid-Cut Deck Assembly

#	PART NO.	QTY	DESCRIPTION
41	523094	1	SPRING MOUNT - DECK
42	583166	1	GEAR BOX LARGE
43	583106	3	BLADE SPINDLE ASSY
44	583447	1	6" TAPER LOCK SHEAVE
46	105005	4	5/16" LOCK WASHER
47	107255	1	3/16" X 1" KEY
48	363145	2	1" CLAMP COLLAR
49	363187	2	1" FLANGE BEARING
53	582182	1	MC LIFT RISER WELDMENT
54	583236	1	ACTUATOR EXTENSION
55	583294	1	ELECTRIC ACTUATOR
56	583499	2	E.L. PIVOT ARM
57	100252	6	1/4"-20 X 3/4" HEX BOLT
58	582217	1	E.L. RAM WELDMENT
59	582215	1	E.L. PIVOT MOUNT WELDMENT
60	583153	1	72" DECK BELT
61	423175	1	PUMP IDLER PIVOT
62	583474	2	CASTER ROD
66	373089	1	3/8" RETAINING WASHER
67	582108	1	DEFLECTOR SHIELD 72"
68	100300	4	3/8"-16 X 3" HEX BOLT
69	100301	4	3/8"-16 X 3 1/4" HEX BOLT
71	100273	2	5/16"-18 X 1" HEX BOLT
72	823330	4	CASTER ARM PIVOT
73	823090	4	CASTER BAR PIVOT
74A	582053	1	LEFT HAND CASTER ARM
74B	582051	1	RIGHT HAND CASTER ARM
75	582100	1	RIGHT HAND BELT SHIELD
76	582059	2	CASTER BAR WELDMENT
77	823150	2	SPRING
78	582112	1	72" DECK TUBE WELDMENT
79	583074	2	ROLLER MOUNT
80	100298	2	3/8"-16 X 2 1/2" HEX BOLT
82	753028	4	KNOB
83	107516	2	3/8" X 2 1/4" CARRIAGE BOLT
84	107513	3	3/8"-16 X 3" CARRIAGE BOLT
85	593074	1	FLOATING IDLER SPRING
86	823153	2	SPACER - DECK
87	823159	2	SPRING SLIDE
88	100030	2	3/8"-16 X 3" TAP BOLT
90	823333	2	DECK ATTACH PIN
91	108001	3	3/16" QUICK PIN

72" Mid-Cut Deck Assembly

#	PART NO.	QTY	DESCRIPTION
92	823200	1	STEP TREAD
95	823314	2	TUBE SADDLE SPACER
96	483017	2	RIGHT HAND IDLER SPACER
97	583472	2	CASTER ROD END
98	109025	2	5/8" HEAVY WASHER
99	823210	2	1/2" X 2" CLEVIS PIN
100	106763	2	1/8" COTTER PIN
101	108510	4	7/8" E-RING
103	823209	2	1/2" X 1 1/2" CLEVIS PIN
104	363161	3	BELT SHIELD CAP
106	582090	1	FRONT AXLE - 72MC
107	582102	1	BELT SHIELD LEFT HAND 72"
112	582176	1	CUT GAGE WELDMENT
113	100291	1	3/8"-16 X 3/4" HEX BOLT
114	105006	2	3/8" LOCKWASHER
115	583422	1	NUT-CUT GAGE
116	583420	1	POINTER CUT GAGE
117	100358	3	5/8"-11 X 2 1/4" HEX BOLT
118	363215	1	1" TAPER LOCK HUB
119A	592006	1	SPRING RETAINER
119B	593176	1	LIFT SPRING CUP
121	523329	1	FLOATING IDLER - FLAT
122	823211	2	1/2" X 2 1/2" RING PIN
123	106778	3	3/16" X 1 1/2" COTTER PIN
124	108001	2	3/16" QUICK PIN
125	100293	4	3/8"-16 X 1 1/4" HHCS

NOTES:

- A PREFORMANCE UPGRADE FOR DECK SPRING ASSY. REQUIRES ITEM 119. BOTH SIDES NEED BE UPGRADED AT THE SAME TIME.

72" MID-CUT MAINFRAME ASSEMBLY

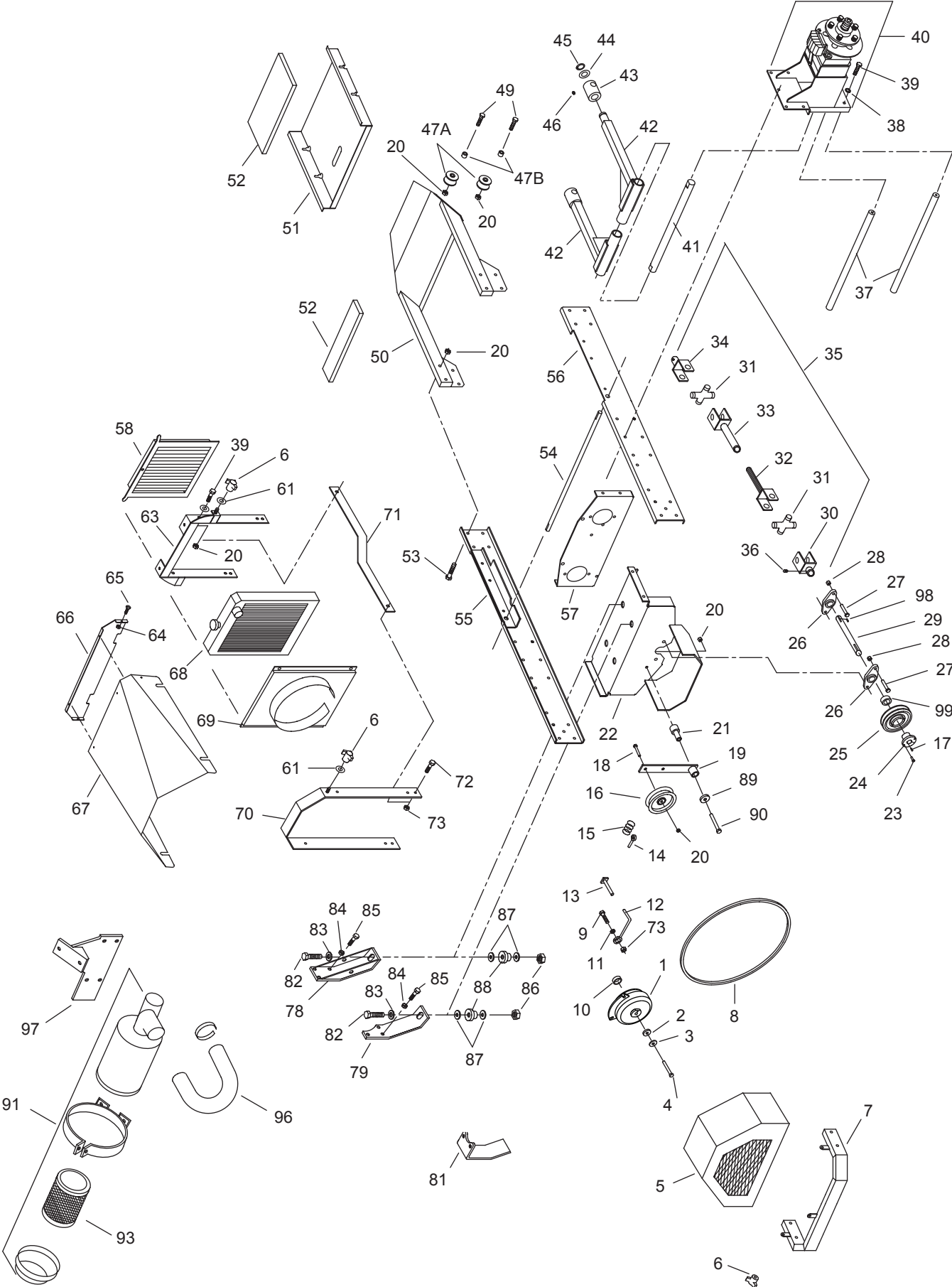

72" Mid-Cut Mainframe Assembly

#	PART NO.	QTY	DESCRIPTION
1	823165	1	ELECTRIC CUUTCH A/C KAW. KOHLER
2	373089	1	RETAINER WASHER
3	423069	2	7/16" SPRING DISC WASHER
4	100534	1	7/16"-20 X 1 1/4" HEX BOL T
5	582157	1	CLUTCH COVER - IL3
6	753028	7	KNOB
7	582132	1	ENGINE GUARD
8	523374	1	CLUTCH BEL T
9	100273	16	5/16"-18 X 1" HEX BOL T
10	823248	2	CLUTCH SPACER 9/32
11	105258	6	5/16" FLAT WASHER
12	363075	1	ROUND BEL T GUIDE
13	582169	1	CLUTCH STOP
14	363080	1	RIGHT EYE BOL T
15	593074	1	IDL ER SPRING HH
16	483025	1	RIGHT HAND IDL ER PUL LEY
17	107259	1	1/4" X 1/4" X 1" KEY
18	100294	6	3/8"-16 X 1 1/2" HEX BOL T
19	422025	1	TENSIONER W/BUSHING
X	523111	X	BUSHING (SERVICE)
20	104257	32	3/8"-16 NYLOC NUT
21	823030	1	PUMP IDL ER SUPPORT
22	582165	1	ENGINE BASE 26 DSI MC
23	100503	2	1/4" X 3/4" HEX BOL T
24	363215	1	TAPER LOCK HUB
25	523507	1	TAPER LOCK SHEAVE
26	823032	2	2-BOL T FLANGE BEARING
27	100311	4	7/16"-14 X 1 1/4" HEX BOL T
28	104258	4	7/16"-14 NYLOC NUT
29	583271	1	POWER SHAFT - MC - DSI
30	523414	1	1" YOKE
31	523415	2	CROSS & BEARING
32	593075	1	YOKE SHAFT
33	583481	1	YOKE TUBE
34	823372	1	3/4" YOKE
35	593064	1	DRIVE SHAFT MC
36	103295	2	3/8"-16 X 1/2" SET SCREW
37	823066	2	BRACE ROD - LOWER
38	105006	6	3/8" LOCK WASHER
39	100292	23	3/8"-16 X 1" HEX BOL T
40			SEE HYDRAULIC ILLUSTRATION
41	823050	1	DECK ARM SHAFT

72" Mid-Cut Mainframe Assembly

#	PART NO.	QTY	DESCRIPTION
42	822036	2	DECK ARM
43	822090	2	DECK SWIVEL W/ZERK
44	823015	4	DECK ARM WASHER
45	108502	2	SNAP RING
46	111004	12	1/4"-28 GREASE ZERK
47	583464	2	FRONT ROLLER - MC
47A	583464	2	FRONT ROLLER
47B	583490	2	FRONT ROLLER TUBE
49	100298	2	3/8"-16 X 2 1/2" HEX BOLT
50	582092	1	FRONT FRAME
51	593079	1	FOOT PLATE
52A	583374	1	FOOT REST PAD LARGE
52B	583373	1	FOOT REST PAD SMALL
53	100295	4	3/8"-16 X 1 3/4" HEX BOLT
54	823140	1	PARK SHAFT
55	582126	1	LEFT HAND FRAME RAIL
56	582124	1	RIGHT HAND FRAME RAIL
57			SEE HYDRAULIC ILLUSTRATION
58	583301	1	RADIATOR SCREEN
61	105260	13	3/8" FLAT WASHER
63	582159	1	RADIATOR MOUNT
64	104252	15	#10-24 NYLOC NUT
65	101039	17	#10-24 X 5/8" SCREW
66	583010	1	FRONT ENGINE COVER - IL3
67	583296	1	ENGINE COVER
68	SEE NOTE A	1	RADIATOR ASSY.
69	583476	1	FAN SHROUD
70	582161	1	HOOD BRACE
71	583356	2	HOOD SIDE BRACE
72	100271	4	5/16"-18 X 3/4" HEX BOLT
73	104256	5	4/16"-18 NYLOC NUT
78	583250	2	ENGINE MOUNT FRONT
79	582116	2	ENGINE MOUNT - 3 CYL.
81	582134	1	FUEL FILTER MOUNT
82	100327	4	1/2"-13 X 1 1/2" HEX BOLT
83	105264	4	1/2" FLAT WASHER
84	105005	6	5/16" LOCK WASHER
85	109031	6	M8-1.25 X 20MM HEX BOLT
86	104259	4	1/2"-13 NYLOC NUT
87	583478	8	WASHER-ISO MOUNT
88	583303	4	ISO BUSHING
89	373089	1	RETAINING WASHER

72" Mid-Cut Mainframe Assembly

#	PART NO.	QTY	DESCRIPTION
90	100300	2	3/8"-16 X 3" HEX BOLT
91	583297	1	AIR CLEANER ASSY
93	583298	1	AIR FILTER ELEMENT
96	583369	1	AIR FILTER HOSE U-SHAPE
97	582153	1	AIR FILTER MOUNT
98	107258		POWER SHAFT KEY
99	363145	1	1" CLAMP COLLAR

NOTES:

- A CONTACT ENGINE MFG FOR ALL ENGINE & RADIATOR PARTS SHOWN. **ENCORE MFG DO NOT SERVICE THESE PARTS!**

72" Mid-Cut Seatframe Assembly

#	PART NO.	QTY	DESCRIPTION
1	100252	28	1/4-20 X 3/4 HHCS
2	100254	8	1/4"-20 X 1" HEX BOLT
3	100271	19	5/16-18 X 3/4 HHCS
4	100273	8	5/16-18 X 1 HHCS
5	100274	4	5/16-18 X 1-1/4 TAP BOLT
6	100275	2	5/16-18 X 1-1/2 HHCS
7	100294	2	3/8-16 – 1-1/2 HHCS
8	100303	2	3/8-16 X 4 HHCS
9	102000	3	#12-24 X 5/8 SELF TAP. SCREW
10	104253	2	5/16-24 NYLOC NUT
11	104255	2	1/4"-20 NYLOC NUT
12	104256	33	5/16-18 NYLOC NUT
13	104257	3	3/8"-16 NYLOC NUT
14	104752	4	5/16-24 JAM NUT
15	105005	10	5/16 LOCKWASHER - HEAV
16	105256	28	1/4 STD. FLATWASHER
17	105258	4	5/16 STD. FLATWASHER
18	105260	1	3/8 WASHER - STD FLAT
19	105261	2	3/8 ANS. TYPE B FLATWASHER
20	107503	2	5/16-18 X 3/4 CARR. BOLT
21	107520	2	5/16-18 X 1-3/4 CARR BOLT
22	109000	8	1/4"-20 WHIZ LOCK NUT
23	109001	4	5/16-18 WHIZLOCK NUT
24	109015	24	1/4-20 NUT CLIP
25	153045	1	5/16 PUSH NUT
26	363029	1	.312 ROD SWIVEL
27	363098	8	GAS LINE CLAMP - DSL
28	363105	1	BUSHING
29	363113	4	SPACER
30	363165	1	#3 ISSCO HAIRPIN COTTER (#2)
32	373054	2	SPRING
33	393042	2	GROMMET
34	423140	4	3/4 ID 2 BOLT BEARING
35	423160	2	5/16-24 BALL STUD
36	453082	2	5/16 ROD END
37	523030	1	SEAT SWITCH
38	523031	1	PTO SWITCH
39	523032	2	HANDLE GRIP
40	523033	2	HANDLE PLUG
41	523034	1	PARK SWITCH
42	523044	1	SEAT CABLE
43	523112	2	5/16 CLAMP COLLAR

72" Mid-Cut Seatframe Assembly

#	PART NO.	QTY	DESCRIPTION
44	523278	2	SEAT SPRING
45	523283	1	HOUR METER
46	582048	1	PARK LEVER w/ GRIP
47	583302	1	FUEL VALVE - DSL
48	583077	1	SEAT LT. GREY W/TRACK
49	583089	1	SEAT CUSHION
50	583090	1	BACK CUSHION
51A	583242	1	ARM REST PAD - LH
51B	583243	1	ARM REST PAD - RH
52	583183	2	FUEL TANK ADAPTER
55	583224	1	SEAT STOP
56	583401	1	BATTERY MOUNT
57	583415	2	DAMPENER
58	583438	2	ADJUSTMENT PLATE
60	592002	1	CONTROL HANDLE - RH
60	592004	1	CONTROL HANDLE - LH
61	592008	1	SEAT FRAME WELDMENT
62	592010	1	SEAT PLATE WELDMENT
63	592012	1	RH REAR TANK MT.
64	592014	1	LH REAR TANK MT.
65	592016	1	FRONT TANK MOUNT - RH
66	592018	1	FRONT TANK MOUNT - LH
67	592020	1	CONTROL PANEL
68	592060	2	HANDLE MOUNT WELDMNT-LH
69A	592024	2	CONTROL PIVOT RIGHT
69B	592026	1	CONTROL PIVOT LEFT
70	593001	1	FUEL TANK/FENDER - LH
71	593002	1	FUEL TANK/FENDER - RH
72	593008	2	1-1/2" GROMMET
73	593010	2	HANDLE MOUNT BAR
74A	593022	2	RH CONTROL MOUNT
74B	593024	1	LH CONTROL MOUNT
75	593026	2	RH CONTROL COVER
76	593028	2	LH CONTROL COVER
77	593032	1	RH CONTROL LINK
78	593034	1	LH CONTROL LINK
79	593048	1	SWITCH MOUNT - NEUTRAL
80	593058	2	NEUTRAL INDICATOR
81	593067	1	RH TANK PANEL
82	593068	1	LH TANK PANEL
84	823127	2	NEUTRAL LINK
85	823132	1	PARK BRAKE LINK

72" Mid-Cut Seatframe Assembly

#	PART NO.	QTY	DESCRIPTION
87	823194	1	ALARM
86	583463	2	DEISEL CAP - LARGE
88	823221	4	BALL STUD
89	583480	1	FUEL LINE - ILS (1/4 X 13")
90	583435	1	FUEL LINE - RETURN DSL (1/4 X 66")
91	583184	2	FUEL LINE - ENG (1/4 X 58")
92	523045	1	FUEL LINE - (5/16 X 15")
93	583186	2	FUEL LINE - (1/4 X 29")
94	603032	2	FUEL LINE - (1/4 X 24")

NOTES:

72" MID-CUT SMALL HYDRO PUMP ASSEMBLY

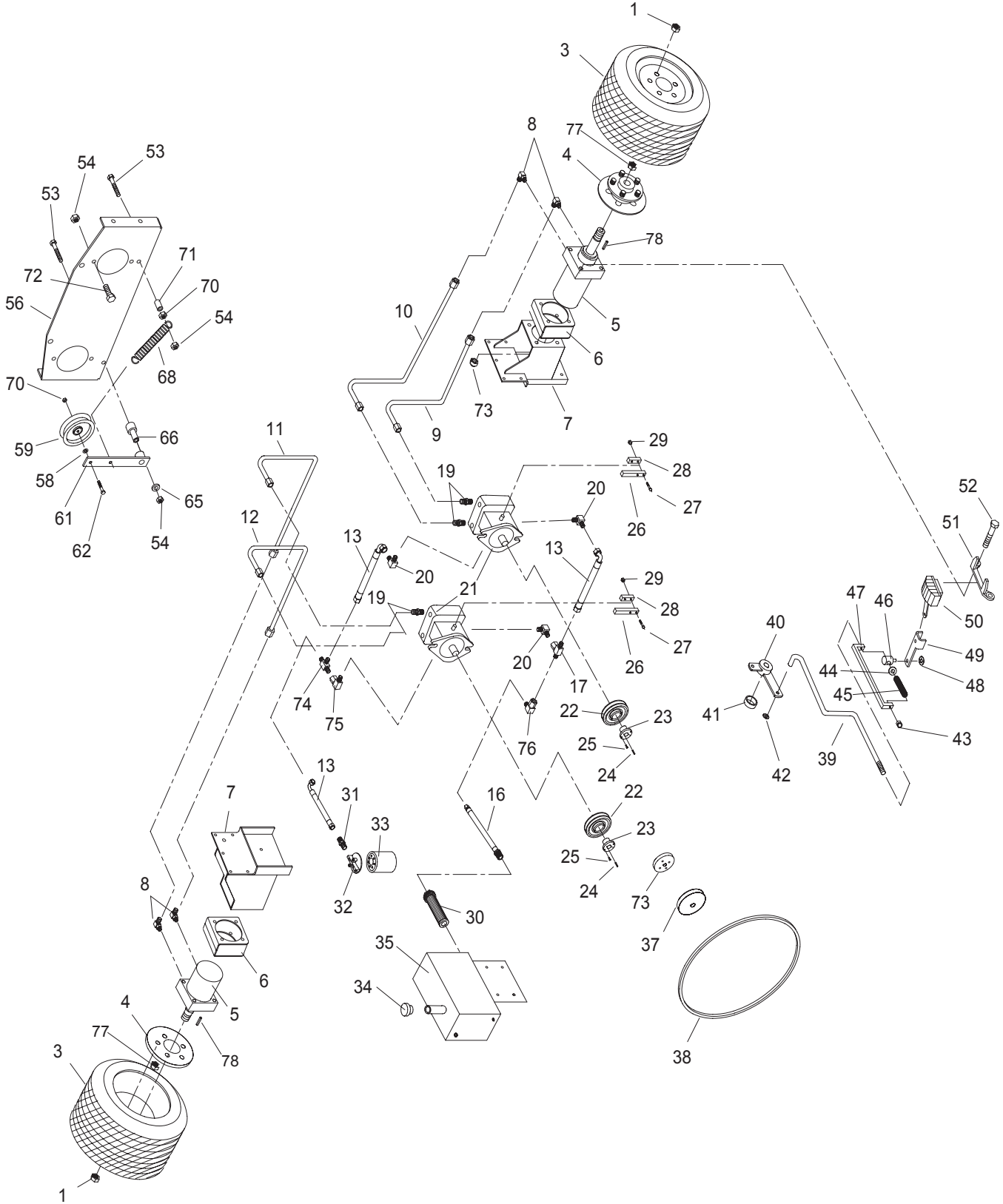

72" Mid-Cut Small Hydro Pump Assembly

#	PART NO.	QTY	DESCRIPTION
1	103023	10	LUG NUT
3	583055	2	DRIVE WHEEL ASSY (COMPLETE)
3A	583059	X	DRIVE TIRE (24 X 12 X 12)
3B	583487	X	BAR LUG TIRE (23 X 10.5 X 12)
3C	583058	X	RIM W/ VALVESTEM
4	582008	2	WHEEL HUB
5	583325	2	WHEEL MOTOR
6	582031	4	MOTOR SPACER
7A	582002	1	RIGHT HAND MOTOR MOUNT
7B	582004	1	LEFT HAND MOTOR MOUNT
8	523058	4	90 DEGREE MOTOR ADAPTER
9	583462	3	HOSE WHEEL DRIVE SHORT MC 72 (21" LG)
10	583461	1	HOSE WHEEL DRIVE LONG MC 72 (26 3/4" LG)
13	583241	2	PUMP TO PUMP HOSE
16	453129	1	PUMP TO TANK SUPPLY HOSE
17	453106	2	SWIVEL TEE
19	583126	4	STRAIGHT ADAPTER
20	453074	3	90 DEGREE ADAPTER
21	583491	2	PUMP-V (10A)
21A	583514	X	PUMP SEAL KIT - (10A)
22	583382	2	PUMP PULLEY
23	423178	2	TAPER HUB
24	453102	2	PUMP KEY
25	100252	2	1/4"-20 X 3/4" HEX BOLT
26	823104	2	CONTROL BAR
27	100257	4	1/4"-20 X 1 3/4" HEX BOLT
28	453090	2	CLAMP BAR
29	104255	6	1/4"-20 NYLOC NUT
30	583132	1	SUCTION SCREEN
31	583442	1	FILTER ADAPTER (61" & 72")
32	423064	1	FILTER HEAD
33	423063	1	HYDRO OIL FILTER (NO CROSS REF AVAIL)
34	423165	1	OIL BREATHER CAP (61" & 72")
35	583049	1	OIL TANK (61" & 72")
36	423065	1	OIL EYE
37	583200	1	PUMP DRIVE PULLEY
38	583385	1	PUMP BELT
39A	583042	1	RIGHT HAND BRAKE ROD (61" & 72")
39B	583044	1	LEFT HAND BRAKE ROD (61" & 72")
40	422049	1	BRAKE CRANK
41	373086	1	SPACER
42	104256	6	5/16" PUSH NUT

72" Mid-Cut Small Hydro Pump Assembly

#	PART NO.	QTY	DESCRIPTION
43	593116	2	BRAKE SPRING NUT
44	105257	2	5/16" FLAT SAE WASHER
45	523024	2	SPRING
46	423130	2	PARK BRAKE SWIVEL
47	593114	2	PARK BRAKE STRAP
48	363177	2	3/8" PUSH NUT
49	583460	2	BRAKE ARM
50A	583038	1	RIGHT HAND BRAKE CALIPER
50B	583039	1	LEFT HAND BRAKE CALIPER
50C	583511	X	BRAKE PAD KIT
51	583040	2	CALIPER MOUNT
52	100343	8	1/2"-13 X 9" HEX BOLT
53	100300	2	3/8"-16 X 3" HEX BOLT
54	104257	32	3/8" NYLOC NUT
56	583328	1	PUMP PLATE
58	105260	13	3/8" FLAT WASHER
59	823351	1	FLAT IDLER
61	422025	1	TENSIONER W/BUSHING
61A	523111	X	BUSHING (SERVICE)
62	100294	2	3/8"-16 X 1 1/2 HHCS
65	373089	2	RETAINING WASHER
66	393070	1	IDLER PIVOT
68	583144	1	PUMP IDLER SPRING
70	109007	2	3/8"-16 WHIZLOCK NUT
71	523277	1	SPACER
72	100293	1	3/8" -16 X 1 1/4" HHCS
73	583218	1	PULLEY ADAPTER
74	453020	1	CROSS ADAPTER
75	453076	1	90 DEG SWIVEL
76	453109	1	SWIVEL ELBOW
77	593181	2	WHEEL MOTOR SHAFT NUT - TJ
78	107013	2	KEY, 5/16 X 1.0 (1001) WOODRUFF

72" MID-CUT ELECTRICAL SECTION

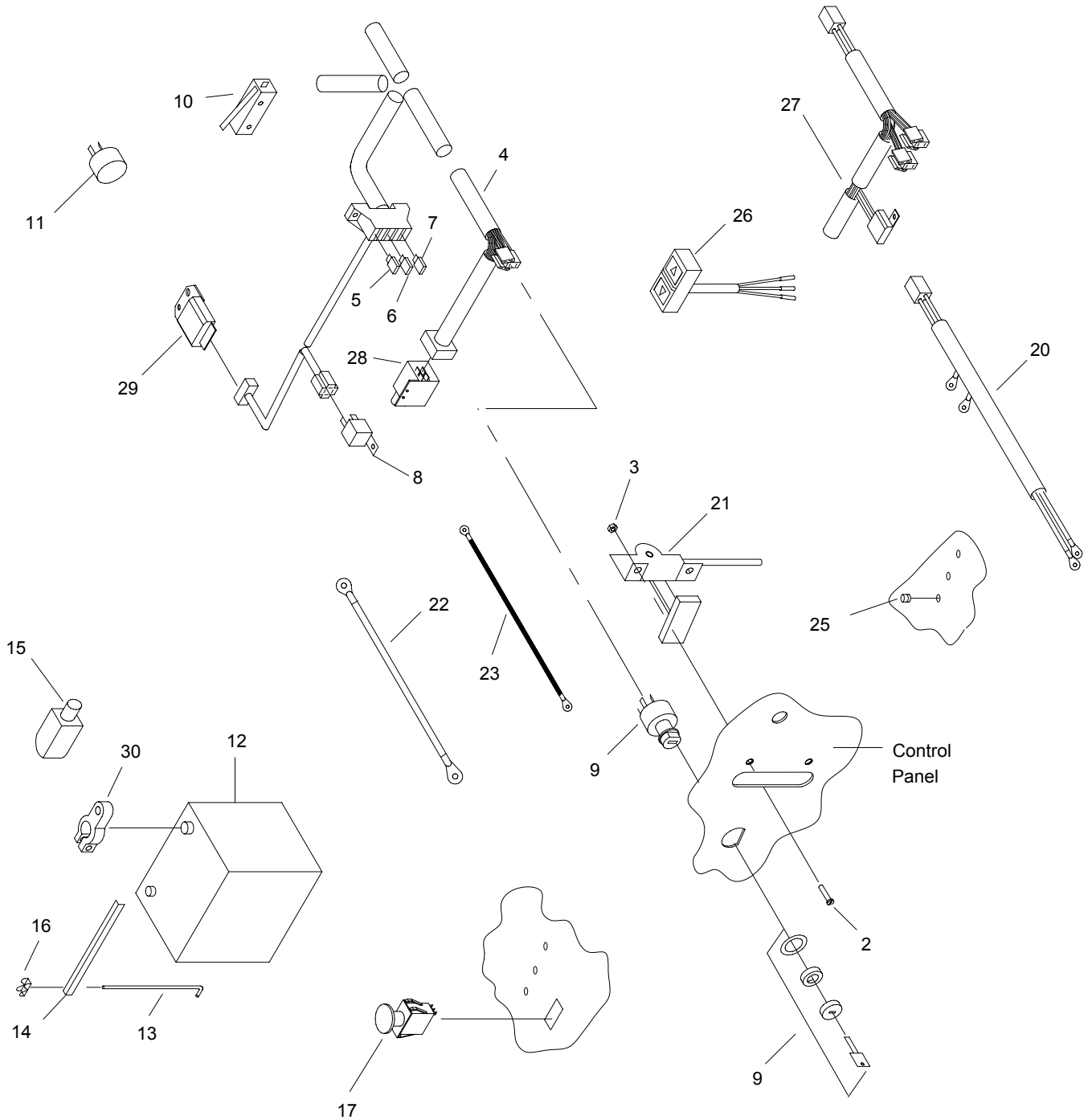

72" Mid-Cut

Electrical Section - Diesel

#	PART NO.	QTY	DESCRIPTION
2	101039	6	#10-24 X 5/8" PAN HEAD BOLT
3	104252	6	#10-24 NYLOC NUT
4	593051	1	WIRE HARNESS - 950D-MC
5	583502	1	30 AMP FUSE
6	523146	1	15 AMP FUSE
7	523147	1	10 AMP FUSE
8	523042	3	RELAY
9	423027	1	IGNITION SWITCH ASSEMBLY
10	593041	1	NEUTRAL SWITCH
11	823194	1	ALARM
12	523050	1	12 VOLT BATTERY
13	423172	2	BATTERY HOLD DOWN
14	583403	1	BATTERY ANGLE - IL3
15	583409	1	POSITIVE BATTERY BOOT
16	109017	2	1/4"-20 WING NUT
17	523031	1	PTO SWITCH
20	583276	1	ENGINE WIRE HARNESS DSL
21	593045	1	THROTTLE CONTROL
22	823196	1	POSITIVE CABLE
23	823197	1	NEGATIVE CABLE
25	523036	5	WARNING LIGHT
26	583411	1	ELECTRIC LIFT SWITCH
27	583412	1	ELECTRIC LIFT HARNESS
28	523034	1	PARK SWITCH
29	583423	1	TIME DELAY MODULE
30	583429	2	BATTERY TERMINAL
31	583351	2	ELECTRIC LIFT RELAY (5 PRONG)
32	583238	1	RELAY MOUNT

NOTES:

PROWLER
72K27L & 72B27LD
WIRE DIAGRAMS
SECTION

ENCORE PART #: 593049
 WIRE HARNESS FOR 52K27L ; 27 HP KAWASAKI
 WIRE HARNESS FOR 61K27L ; 27 HP KAWASAKI
 WIRE HARNESS FOR 72K27L ; 27 HP KAWASAKI

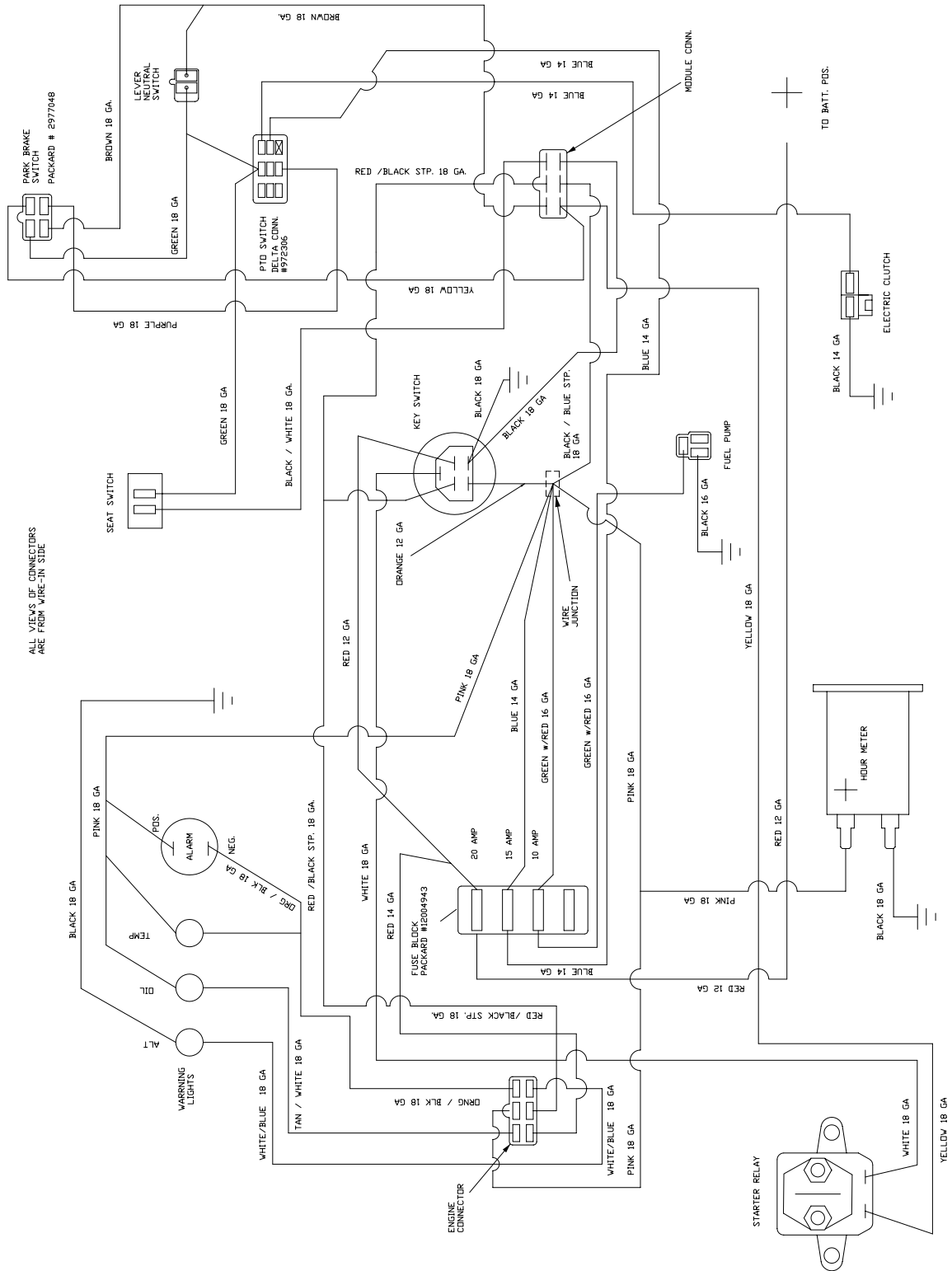

ENCORE PART #: 593051
 WIRE HARNESS FOR 61B27LD ; 27 HP BRIGGS - DIESEL
 WIRE HARNESS FOR 72B27LD ; 27 HP BRIGGS - DIESEL

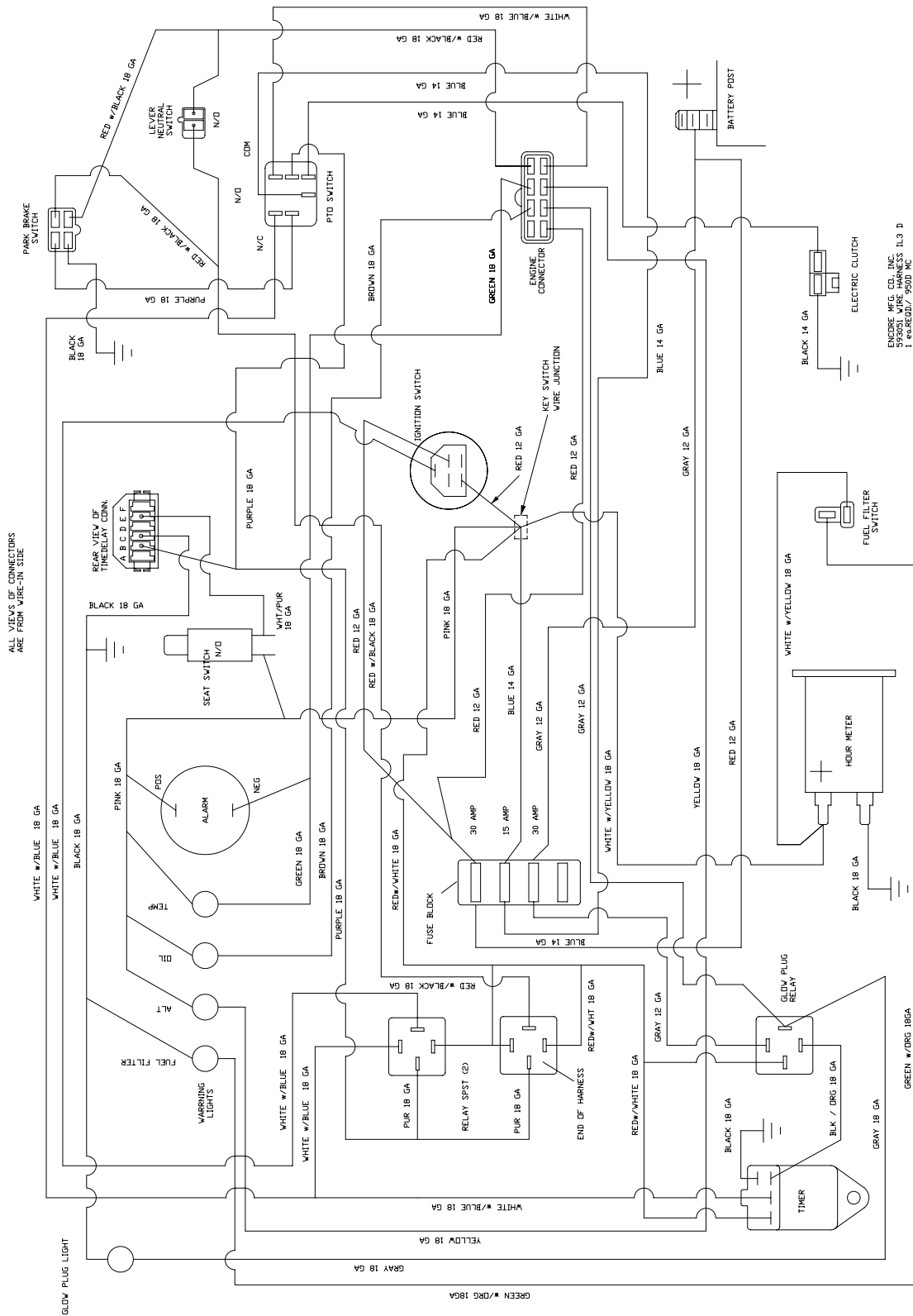

ALL VIEWS OF CONNECTORS ARE
FROM WIRE-IN SIDE

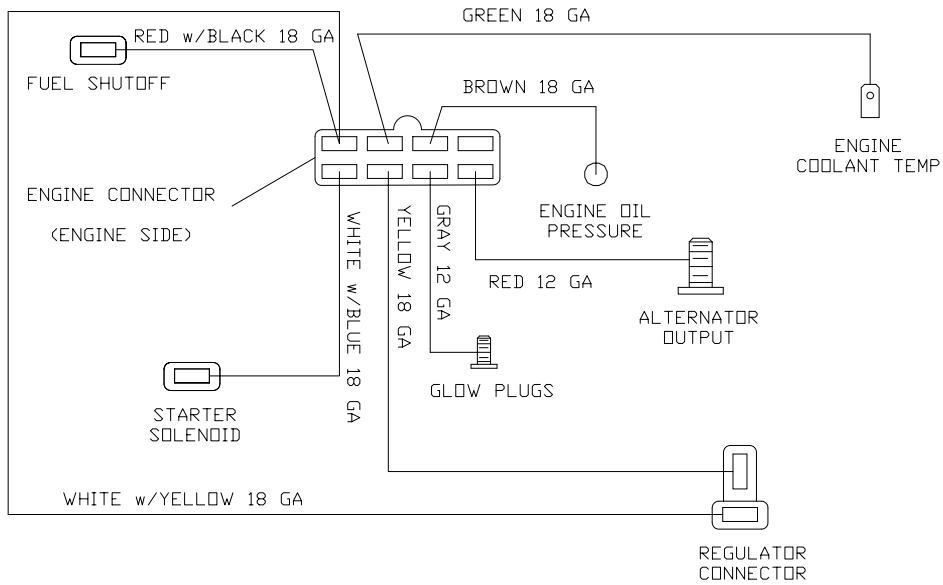

ENCORE PART #: 583276

ENGINE WIRE HARNESS FOR 61B850P ; 26 HP BRIGGS - DIESEL

ENGINE WIRE HARNESS FOR 72B850P ; 26 HP BRIGGS - DIESEL

ENGINE WIRE HARNESS FOR 72B850ZP ; 26 HP BRIGGS - DIESEL

ENGINE WIRE HARNESS FOR B850PFC ; 26 HP BRIGGS - DIESEL

ENGINE WIRE HARNESS FOR 61B27LD ; 27 HP BRIGGS - DIESEL

ENGINE WIRE HARNESS FOR 72B27LD ; 27 HP BRIGGS - DIESEL

72" MID-CUT DECALS



1

ENCORE

2,3,4

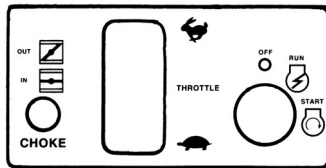

5

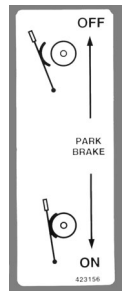

6

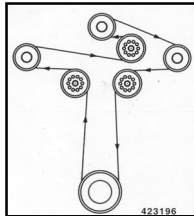

7

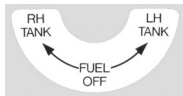

12

PROWLER

14,21

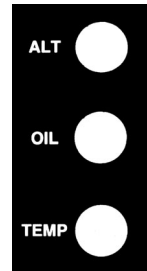

10

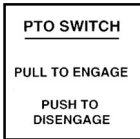

11

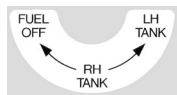

17

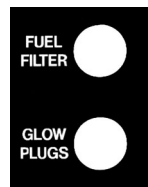

18

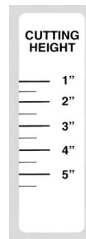

19

PRO 72

15

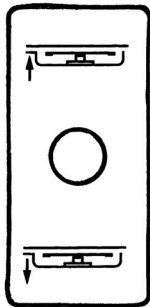

16



23



24

DIESEL

20

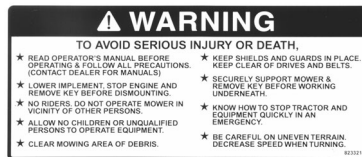

25



26

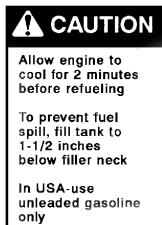

22



28



29



27



30



31

72" Mid-Cut

Decal List

#	PART NO.	DESCRIPTION
1	363023	DANGER DECAL
2	363231	LARGE ENCORE LABEL
3	363243	ENCORE DECAL
4	363265	SMALL ENCORE LABEL
5	423155	RIDER CAUTION DECAL
6	423156	PARK LEVER DECAL
7	423196	BELT ROUTING DECAL
8	423197	CONTROL DECAL
9	453010	OIL DECAL
10	523020	LIGHT DECAL
11	523021	PTO DECAL
12	583023	LABEL – FUEL VALVE - GAS
13	XXXXXX	MOLDED INTO TANK (No Decal Replacement)
14	583088	PROWLER - BLK DECAL
15	583193	PRO-72" DECAL
16	583232	DECAL – UP- DOWN
17	583280	FUEL VALVE LABEL – DSL
18	583372	GLOW PLUG DECAL
19	583416	CUT GAGE DECAL
20	583441	DIESEL LABEL
21	583443	PROWLER DECAL - RED
22	823318	FUEL TANK DECAL
23	823319	TIP OVER – WARNING
24	823320	BATTERY - WARNING DECAL
25	823321	OPERATING - WARNING
26	823322	ROTATING PARTS – DANGER
27	823323	ROTATING PARTS - WARNING
28	823324	SHIELD - DANGER
29	823325	THROWN OBJECTS - DANGER
30	823326	DISCHARGE - WARNING
31	823327	DISCHARGE - DANGER

Notes:

