



61K27L

PARTS  
MANUAL

# **52" MID-CUT SECTION**



# 52" Mid-Cut Deck Assembly

#	PART NO.	QTY	DESCRIPTION			
1	582139	1	DECK WELDMENT 52 MC			
2	582020	1	52" SUB-PLATE WELDMENT			
3	583111	3	SPINDLE HOUSING			
4	583112	3	SPINDLE SHAFT			
5	104511	3	3/4"-16 HEX NUT			
6	363350	6	BEARING - BLADE SPINDLE			
7	105010	3	3/4" LOCK WASHER			
8	105269	3	3/4" SAE FLAT WASHER			
9	583110	3	PULLEY SPACER			
10	583107	3	PULLEY - SPINDLE 5 3/4"			
11	583108	3	5/8" SPRING DISC WASHER			
12	100351	1	5/8"-11 X 8 1/2" HEX BOLT			
13	583109	9	BLADE SPACER			
14	823004	3	18" HI LIFT BLADE			
15	583113	3	BEARING SPACER TUBE			
16	603023	1	ANTI-SCALP ROLLER			
17	523084	2	REAR DECK ROLLER			
18	523329	3	FLOATING IDLER - FLAT			
19	104261	3	5/8"-11 NYLOC NUT			
20	100346	2	5/8"-11 X 4 1/2" HEX BOLT			
21	822088	2	WIDE WHEEL YOKE			
22	363187	4	1" FLANGE BEARING			
23	823220	2	WIDE TAIL TIRE ( COMPLETE )			
23A	823339	X	TIRE ( 13 X 6.5 X 6 )			
23B	823338	X	FRONT RIM W/ VALVESTEM			
24	100352	2	5/8"-11 X 9" HEX BOLT			
25	104261	2	5/8"-11 NYLOC NUT			
26	823245	2	AXLE TUBE <WTW>			
27	822144	1	DECK IDLER ARM W/BUSHING			
28	523111	1	3/4 PLASTIC BUSHING			
29	107511	1	3/8"-16 X 2" CARRIAGE BOLT			
30	105260	8	3/8" FLAT WASHER			
31	104257	16	3/8"-16 NYLOC NUT			
32	100275	1	5/16"-18 X 1 1/2" HEX BOLT			
33	109001	2	5/16"-18 WHIZLOCK NUT			
34	104256	36	5/16"-18 NYLOC NUT			
35	109007	2	3/8"-16 WHIZLOCK NUT			
36	105258	9	5/16" FLAT WASHER			
37	107503	10	5/16"-18 X 3/4" CARRIAGE BOLT			
38	107509	5	5/16"-18 X 1" CARRIAGE BOLT			
39	100274	12	5/16"-18 X 1 1/4" HEX BOLT			
40	363080	1	EYEBOLT - RIGHT			

# 52" Mid-Cut Deck Assembly

#	PART NO.	QTY	DESCRIPTION			
41	523094	1	SPRING MOUNT - DECK			
42	583087	1	DECK GEAR BOLX			
43	523371	1	3/4" TAPER BUSHING			
44	363216	1	TAPER LOCK SHEAVE			
45	100291	1	3/8"-16 X 3/4" HEX BOLT			
46	105005	4	5/16" LOCK WASHER			
47	107255	1	3/16" X 1" KEY			
48	363145	2	1" CLAMP COLLAR			
49	363187	2	1" FLANGE BEARING			
50	582021	1	HEIGHT ADJUSTMENT BRACKET			
51	822141	1	DECK HEIGHT BAR W/BUSHING			
52	253059	1	ENGAGMENT BUSHING			
53	822062	1	DECK HEIGHT HANDLE W/GRIP			
54	823312	1	GRIP			
55	823149	1	HANDLE ROD			
56	823093	1	3/8" CLAMP COLLAR			
57	100252	6	1/4"-20 X 3/4" HEX BOLT			
58	105004	2	1/4" LOCK WASHER			
59	523028	1	ASSIST SPRING			
60	823243	1	52" FC DECK BELT			
61	423175	1	PUMP IDLER PIVOT			
62	823155	2	CASTER ROD			
63	105006	2	3/8" LOCK WASHER			
64	100297	1	3/8"-16 X 2 1/4" HEX BOLT			
65	582128	1	LIFT BAR WELDMENT 52 MC			
66	583422	1	NUT-CUT GAGE			
67	482017	1	GRASS DEFLECTOR			
68	100300	4	3/8"-16 X 3" HEX BOLT			
69	100301	4	3/8"-16 X 3 1/4" HEX BOLT			
70	100251	2	1/4"-20 X 5/8" HEX BOLT			
71	100273	2	5/16"-18 X 1" HEX BOLT			
72	823330	4	CASTER ARM PIVOT			
73	823090	4	CASTER BAR PIVOT			
74A	582053	1	LEFT HAND CASTER ARM			
74B	582051	1	RIGHT HAND CASTER ARM			
75	582141	1	BELT SHIELD 52 MC RIGH HAND			
76	582059	2	CASTER BAR WELDMENT			
77	823150	2	COMPRESSION SPRING			
78	822040	1	DECK TUBE WELDMENT			
79	583074	2	ROLLER MOUNT			
80	100298	2	3/8"-16 X 2 1/2" HEX BOLT			
81	582176	1	CUT GAGE WELDMENT			

# 52" Mid-Cut Deck Assembly

#	PART NO.	QTY	DESCRIPTION			
82	753028	4	KNOB			
83	107516	2	3/8"-16 X 2 1/4" CARRIAGE BOLT			
84	107513	3	3/8"-16 X 3" CARRIAGE BOLT			
85	593074	1	IDLER SPRING			
86	823153	2	CASTER ROD SPACER			
87	823159	2	SPRING SLIDE ( SEE NOTE A )			
88	100030	2	3/8"-16 X 3" TAP BOLT			
89	822132	1	DECK HEIGHT PIVOT			
90	823333	2	DECK ATTACH PIN			
91	108001	2	3/16" QUICK PIN			
92	823200	1	STEP TREAD			
93	107502	2	1/4"-20 X 3/4" CARRIAGE BOLT			
94	104255	2	1/4"-20 NYLOC NUT			
95	823314	2	TUBE SADDLE SPACER			
96	483017	2	RIGHT HAND IDLER SPACER			
97	823157	2	CASTER ROD END			
98	105260	2	5/8" HEAVY WASHER			
99	823210	2	1/2" X 2" CLEVIS PIN			
100	106763	2	1/8" COTTER PIN			
101	108510	4	7/8" E-RING			
102	109026	1	1/2" X 2" DETENT PIN			
103	823209	1	1/2" X 1 1/2" CLEVIS PIN			
104	363161	2	BELT COVER CAP			
105	823211	2	1/2" X 2 1/2" RING PIN			
106	582136	1	FRONT AXLE 52 MC			
107	582143	1	BELT SHIELD 52 MC LEFT HAND			
108	583420	1	POINTER CUT GAGE			
109	100358	3	5/8"-11 x 2 1/4" HEX BOLT			
110	583106	3	BLADE SPINDLE ASSY			
111	373089	1	3/8" RETAINING WASHER			
112A	592006	1	SPRING RETAINER			
112B	593176	1	LIFT SPRING CUP			
113	593096	1	GEAR BOX TRUSS			
114	106778	2	3/16 X 1 1/2" COTTLE PIN			
115	107255	1	KEY - 3/16" X 1"			

## NOTES:

- A     PREFORMANCE UPGRADE FOR DECK SPRING ASSY. REQUIRES ITEM 112.  
BOTH SIDES NEED BE UPGRADED AT THE SAME TIME.

# 52" MID-CUT MAINFRAME ASSEMBLY

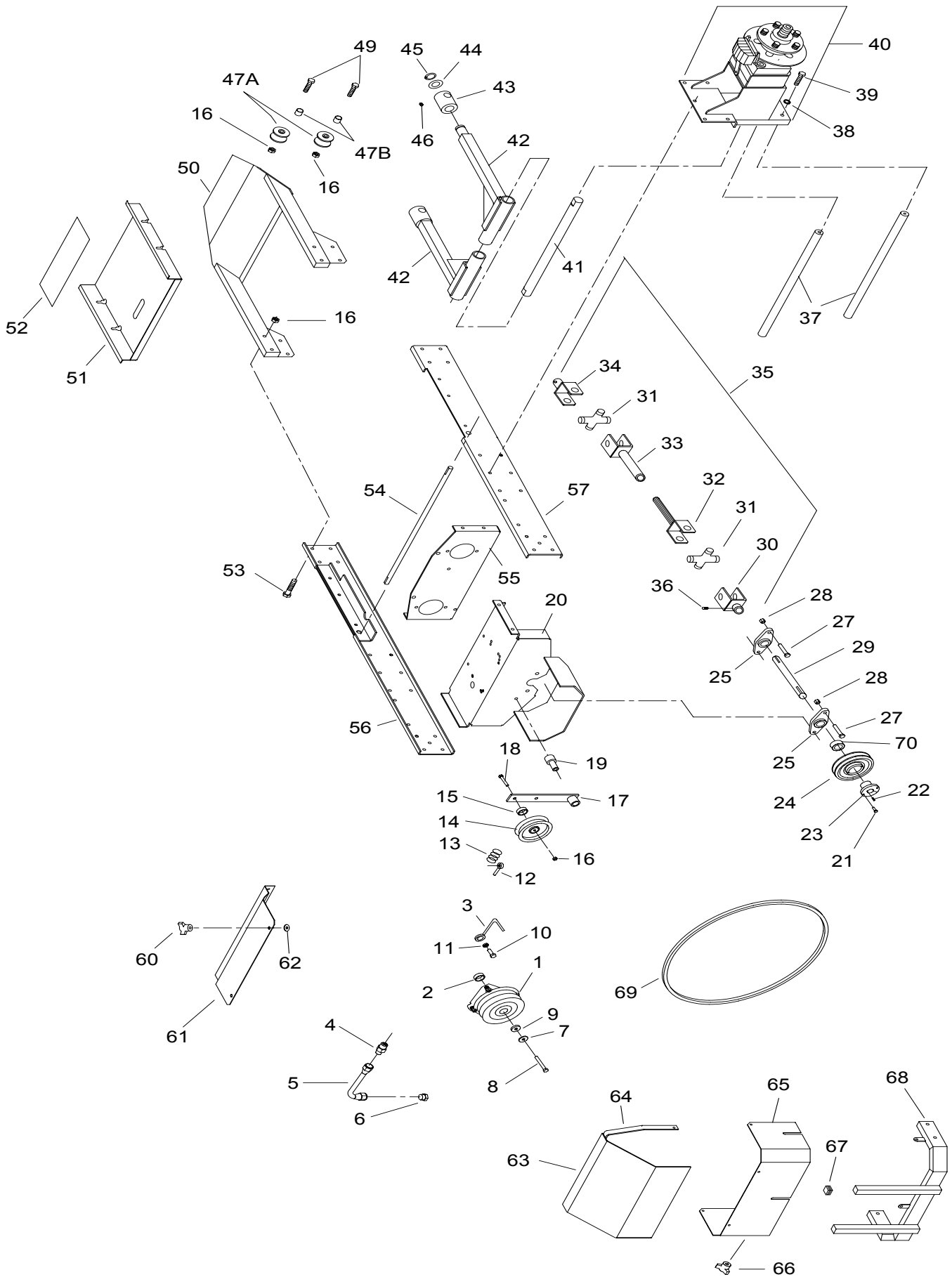

# 52" Mid-Cut Mainframe Assembly

23 HP KAW  
25 HP KAW  
27 HP KAW

#	PART NO.	QTY	DESCRIPTION	23 HP KAW	25 HP KAW	27 HP KAW
1A	823165	1	ELECTRIC CLUTCH - MS	X	X	
1B	583518	1	ELECTRIC CLUTCH - MS			X
2	523322	2	CLUTCH SPACER			
3	363075	1	ROUND BELT GUIDE			
4	523063	1	ENGINE DRAIN ADAPTER			
5	523064	1	ENGINE DRAIN LINE			
6	523065	1	ENGINE DRAIN PLUG			
7	753027	1	3/8" DISC SPRING WASHER			
8	109019	1	10MM-1.5 X 30MM HEX BOLT			
9	423068	1	CLUTCH WASHER			
10	100512	2	5/16"-24 X 1" HEX BOLT			
11	363226	4	DISC SPRING WASHER			
12	363080	1	RIGHT EYEBOLT			
13	593074	1	IDLER SPRING - HH			
14	483025	1	RIGHT HAND IDLER PULLEY			
15	483017	1	RIGHT HAND IDLER SPACER			
16	104257	30	3/8"-16 NYLOC NUT			
17	422025	1	TENSIONER W/BUSHING			
X	523111	X	BUSHING ( SERVICE )			
18	100297	1	3/8"-16 X 2 1/4" HEX BOLT			
19	823030	1	IDLER PIVOT			
20	582043	1	ENGINE BASE	X	X	X
21	100252	2	1/4"-20 X 3/4" HHCS			
22	107259	1	1/4" X 1/4" X 1" KEY			
23	363215	1	TAPER LOCK HUB			
24A	523096	1	TAPER LOCK SHEAVE	X	X	
24B	363216	1	TAPER LOCK SHEAVE			X
25	823032	2	2 BOLT FLANGE BEARING			
27	100311	4	7/16"-14 X 1 1/4" HEX BOLT			
28	104258	4	7/16"-14 NYLOC NUT			
29	583080	1	1" POWER SHAFT - MC			
30	523414	1	1" YOKE			
31	523415	2	CROSS			
32	593075	1	YOKE SHAFT			
33	583481	1	YOKE TUBE			
34	823372	1	3/4" YOKE			
35	593064	1	COMPLETE PTO SHAFT			
36	103295	2	3/8"-16 X 1/2" SET SCREW			
37	823066	2	BRACE ROD - LOWER			
38	105006	6	3/8" LOCKWASHER			
39	100292	23	3/8"-16 X 1" HEX BOLT			
40			SEE HYDRAULIC ILLUSTRATION			

# 52" Mid-Cut Mainframe Assembly

23 HP KAW  
25 HP KAW  
27 HP KAW

#	PART NO.	QTY	DESCRIPTION			
41	823050	1	DECK ARM SHAFT			
42	822036	2	DECK ARM			
43	822090	2	DCK ARM SWVL W/ZERK			
44	823015	4	DECK ARM WASHER			
45	108502	2	SNAP RING			
46	111004	12	1/4"-28 GREASE ZERK			
47	583120	2	FRONT PIVOT ROLLER (REF ONLY)			
47A	583464	2	FRONT ROLLER			
47B	583490	2	FRONT ROLLER TUBE			
49	100298	2	3/8"-16 X 2 1/2" HEX BOLT			
50	582006	1	FRONT FRAME			
51	593078	1	FOOT PLATE			
52	823042	3	FOOT PLATE TREAD			
53	100295	4	3/8"-16 X 1 3/4" HEX BOLT			
54	823140	1	PARK SHAFT			
55			SEE HYDRAULIC ILLUSTRATION			
56	582041	1	LEFT HAND FRAME RAIL			
57	582039	1	RIGHT HAND FRAME RAIL			
60	583168	2	KNOB 5/16" STUD			
61A	592036	1	CENTER COVER A //C	X	X	
61B	583010	1	FRONT ENGINE COVER			X
62	109030	2	5/16" RETAINING CLIP			
63	822146	1	REAR COVER			
64	823335	2	REAR COVER STRAP			
65	583504	1	REAR COVER - KAW			
66	753028	2	KNOB			
67	583191	2	1" SQ. TUBE PLUG			
68	582061	1	ENGINE GUARD - REAR			
69A	823267	1	CLUTCH BELT	X	X	
69B	583517	1	CLUTCH BELT			X
70	363145	1	1" CLAMP COLLAR			

## NOTES:

- A CONTACT ENGINE MFG FOR ALL ENGINE & RADIATOR PARTS NOT SHOWN. **ENCORE MFG DO NOT SERVICE THESE PARTS!**

# 52" MID-CUT SEATFRAME ASSEMBLY

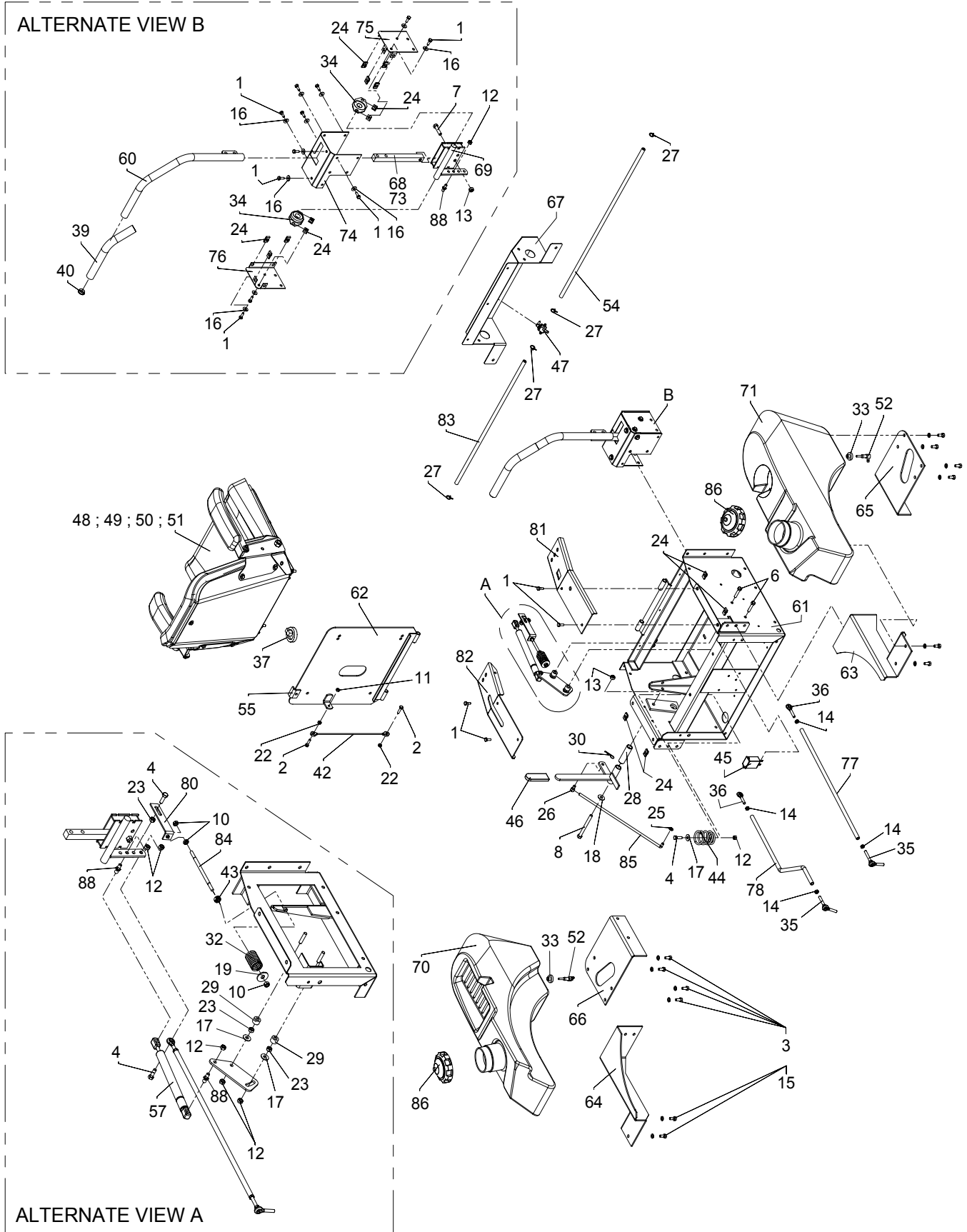

# 52" Mid-Cut Seatframe Assembly

23 HP KAW  
25 HP KAW  
27 HP KAW

#	PART NO.	QTY	DESCRIPTION			
1	100252	28	1/4-20 X 3/4 HHCS			
2	100254	8	1/4"-20 X 1" HEX BOLT			
3	100271	19	5/16-18 X 3/4 HHCS			
4	100273	8	5/16-18 X 1 HHCS			
5	100274	4	5/16-18 X 1-1/4 TAP BOLT			
6	100275	2	5/16-18 X 1-1/2 HHCS			
7	100294	2	3/8-16 – 1-1/2 HHCS			
8	100303	2	3/8-16 X 4 HHCS			
9	102000	3	#12-24 X 5/8 SELF TAP. SCREW			
10	104253	2	5/16-24 NYLOC NUT			
11	104255	2	1/4"-20 NYLOC NUT			
12	104256	33	5/16-18 NYLOC NUT			
13	104257	3	3/8"-16 NYLOC NUT			
14	104752	4	5/16-24 JAM NUT			
15	105005	10	5/16 LOCKWASHER - HEAV			
16	105256	28	1/4 STD. FLATWASHER			
17	105258	4	5/16 STD. FLATWASHER			
18	105260	1	3/8 WASHER - STD FLAT			
19	105261	2	3/8 ANS. TYPE B FLATWASHER			
20	107503	2	5/16-18 X 3/4 CARR. BOLT			
21	107520	2	5/16-18 X 1-3/4 CARR BOLT			
22	109000	8	1/4"-20 WHIZ LOCK NUT			
23	109001	4	5/16-18 WHIZLOCK NUT			
24	109015	24	1/4-20 NUT CLIP			
25	153045	1	5/16 PUSH NUT			
26	363029	1	.312 ROD SWIVEL			
27A	363098	2	GAS LINE CLAMP			
27B	363098	4	FUEL LINE CLAMP			
28	363105	1	BUSHING			
29	363113	4	SPACER			
30	363165	1	#3 ISSCO HAIRPIN COTTER (#2)			
32	373054	2	SPRING			
33	393042	2	GROMMET			
34	423140	4	3/4 ID 2 BOLT BEARING			
35	423160	2	5/16-24 BALL STUD			
36	453082	2	5/16 ROD END			
37	523030	1	SEAT SWITCH			
38	523031	1	PTO SWITCH			
39	523032	2	HANDLE GRIP			
40	523033	2	HANDLE PLUG			
41	523034	1	PARK SWITCH			
42	523044	1	SEAT CABLE			

# 52" Mid-Cut Seatframe Assembly

23 HP KAW  
25 HP KAW  
27 HP KAW

#	PART NO.	QTY	DESCRIPTION			
43	523112	2	5/16 CLAMP COLLAR			
44	523278	2	SEAT SPRING			
45	523283	1	HOUR METER			
46	582048	1	PARK LEVER w/ GRIP			
47	583050	1	FUEL VALVE			
48	583077	1	SEAT LT. GREY W/TRACK			
49	583089	1	SEAT CUSHION			
50	583090	1	BACK CUSHION			
51	593097	1	ARM REST PAD - LH			
51	593097	1	ARM REST PAD - RH			
52	583183	2	FUEL TANK ADAPTER			
53	583184	1	FUEL LINE			
54	583186	1	FUEL LINE – 29"			
55	583224	1	SEAT STOP			
56	583401	1	BATTERY MOUNT			
57	583415	2	DAMPENER			
58	583438	2	ADJUSTMENT PLATE			
60A	592041	1	CONTROL HANDLE - RH			
60B	592042	1	CONTROL HANDLE - LH			
61	592008	1	SEAT FRAME WELDMENT			
62	592010	1	SEAT PLATE WELDMENT			
63	592012	1	RH REAR TANK MT.			
64	592014	1	LH REAR TANK MT.			
65	592016	1	FRONT TANK MOUNT – RH			
66	592018	1	FRONT TANK MOUNT – LH			
67	592020	1	CONTROL PANEL			
68	592060	2	HANDLE MOUNT WELDMNT-LH			
69	592024	2	CONTROL PIVOT RIGHT			
69	592026	1	CONTROL PIVOT LEFT			
70	593001	1	FUEL TANK/FENDER - LH			
71	593002	1	FUEL TANK/FENDER - RH			
72	593008	2	1-1/2" GROMMET			
73	593010	2	HANDLE MOUNT BAR			
74A	593022	2	RH CONTROL MOUNT			
74B	593024	1	LH CONTROL MOUNT			
75	593026	2	RH CONTROL COVER			
76	593028	2	LH CONTROL COVER			
77	593032	1	RH CONTROL LINK			
78	593034	1	LH CONTROL LINK			
79	593048	1	SWITCH MOUNT – NEUTRAL			
80	593058	2	NEUTRAL INDICATOR			
81	593067	1	RH TANK PANEL			

# 52" Mid-Cut Seatframe Assembly

23 HP KAW  
25 HP KAW  
27 HP KAW

#	PART NO.	QTY	DESCRIPTION			
82	593068	1	LH TANK PANEL			
83	603032	1	FUEL LINE – 24"			
84	823127	2	NEUTRAL LINK			
85	823132	1	PARK BRAKE LINK			
86	823179	2	FUEL CAP - LARGE			
87	823194	1	ALARM			
88	823221	4	BALL STUD			

**NOTES:**

# 52" MID-CUT SMALL HYDRO PUMP ASSEMBLY

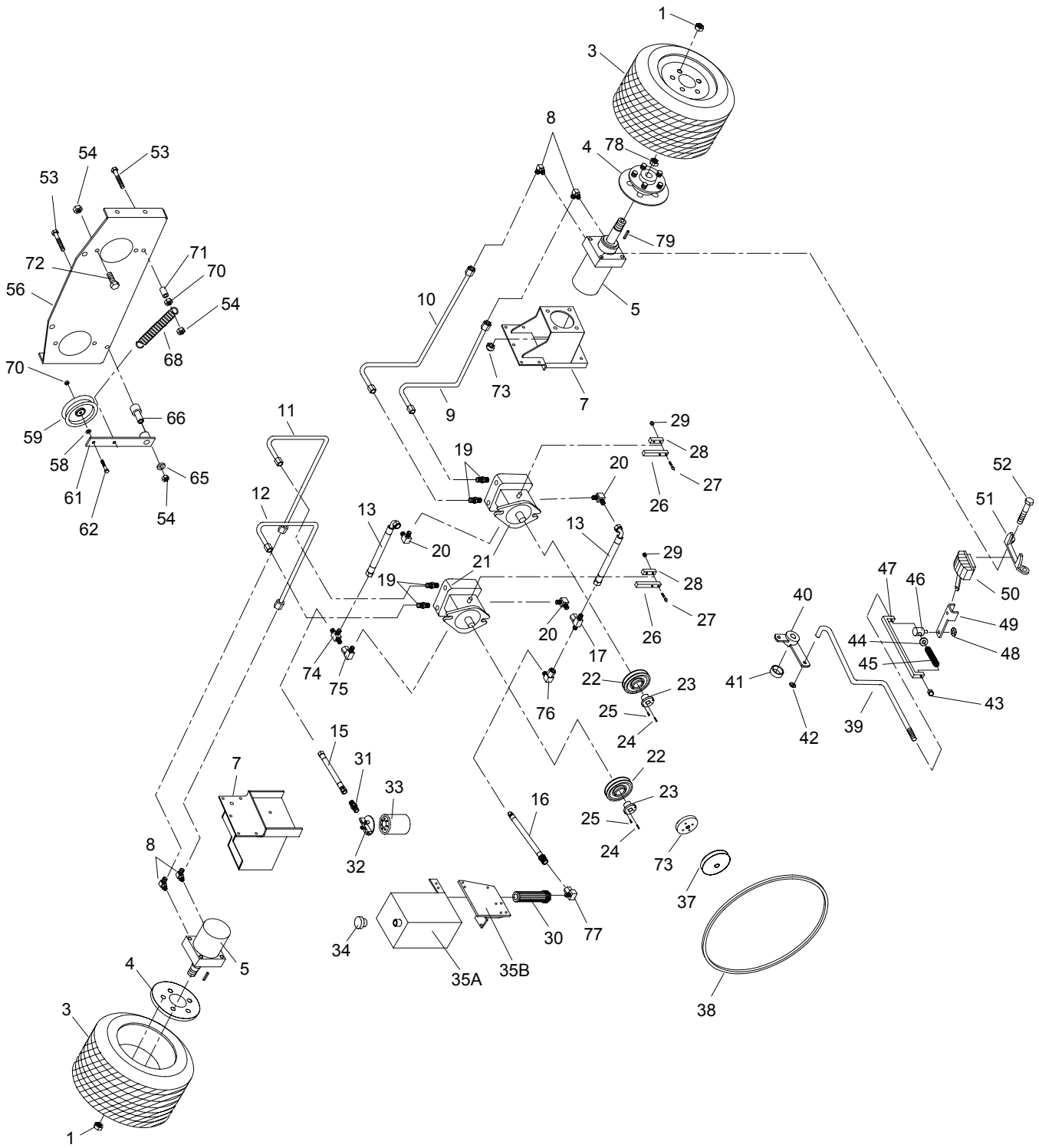

# 52" Mid-Cut Small Hydro Pump Assembly

23 HP KAW  
25 HP KAW  
27 HP KAW

#	PART NO.	QTY	DESCRIPTION			
1	103023	10	LUG NUT			
3	583055	2	DRIVE WHEEL ( COMPLETE )			
3A	583059	X	DRIVE TIRE ( 24 X 12 X 12 )			
3B	583487	X	BAR LUG TIRE ( 23 X 10.5 X 12 )			
3C	583058	X	RIM W/ VALVESTEM			
4	582008	2	WHEEL HUB			
5	583325	2	WHEEL MOTOR - MP14			
5A	583520	X	SEAL KIT - MP14			
7	582002	1	RIGHT HAND MOTOR MOUNT			
7	582004	1	LEFT HAND MOTOR MOUNT			
8	523058	4	90 DEGREE MOTOR ADAPTER			
9	583379	1	RIGHT HAND OUTSIDE LINE - STEEL(52")			
10	583378	1	RIGHT HAND INSIDE LINE - STEEL(52")			
11	583380	1	LEFT HAND INSIDE LINE - STEEL(52")			
12	583381	1	LEFT HAND OUTSIDE LINE - STEEL(52")			
13	583241	2	PUMP TO PUMP HOSE			
15	593073	1	PUMP TO FILTER HOSE(52")			
16	453126	1	PUMP TO TANK SUPPLY HOSE			
17	453106	1	SWIVEL TEE			
19	583126	4	STRAIGHT ADAPTER			
20	453074	3	90 DEGREE ADAPTER			
21	583491	2	PUMP- 10A W / RELIEF			
21A	583514	X	PUMP SEAL KIT - 10L			
22	583382	2	PUMP PULLEY			
23	423178	2	15 MM TAPER HUB			
24	453102	2	PUMP KEY			
25	100252	2	1/4"-20 X 3/4" HEX BOLT			
26	823104	2	CONTROL BAR			
27	100257	4	1/4"-20 X 1 3/4" HEX BOLT			
28	453090	2	CLAMP BAR			
29	104255	6	1/4"-20 NYLOC NUT			
30	583132	1	SUCTION SCREEN			
31	423067	1	FILTER ADAPTER(52")			
32	423064	1	FILTER HEAD			
33	423063	1	HYDRO OIL FILTER			
34	583406	1	OIL BREATHER CAP(52")			
35A	583384	1	OIL TANK(52")			
35B	582149	1	OIL TANK MOUNT(52")			
36	423065	1	OIL EYE			
37	583200	1	PUMP DRIVE PULLEY	X	X	
37	583217	1	PUMP PULLEY - KAW			X
38	583385	1	PUMP BELT SML PUMP	X	X	X

# 52" Mid-Cut Small Hydro Pump Assembly

23 HP KAW  
25 HP KAW  
27 HP KAW

#	PART NO.	QTY	DESCRIPTION			
39	583390	2	BRAKE ROD(52")			
40	422049	1	BRAKE CRANK			
41	373086	1	BLADE SPACER			
42	104256	6	5/16" PUSH NUT			
43	593116	2	BRAKE SPRINT NUT			
44	105257	2	5/16" SAE FLAT WASHER			
45	523024	2	DECK DR. SPRING			
46	423130	2	PARK BRAKE SWIVEL			
47	593114	2	PARK BRAKE STRAP			
48	363177	2	3/8" PUSH NUT			
49	583190	2	BRAKE ARM			
50A	583038	1	RIGHT HAND BRAKE CALIPER			
50B	583039	1	LEFT HAND BRAKE CALIPER			
50C	583511	X	BRAKE PAD KIT			
51	583040	2	CALIPER MOUNT			
52	100339	8	1/2"-13 X 6" HEX BOLT			
53	100300	2	3/8"-16 X 3" HEX BOLT			
54	104257	32	3/8" NYLOC NUT			
56	583328	1	PUMP PLATE -MCBDP10			
58	105260	13	3/8" FLAT WASHER			
59	823351	1	PUMP DRIVE IDLER			
61	422025	1	TENSIONER W/BUSHING			
X	523111	X	BUSHING ( SERVICE )			
62	100294	2	3/8"- 16 X 1 1/2 HHCS			
65	373089	2	RETAINING WASHER			
66	423175	1	IDLER PIVOT			
68	583144	1	PUMP IDLER SPRING			
70	109007	2	3/8"-16 WHIZLOCK NUT			
71	393070	1	IDLER SPACER			
72	100293	1	3/8" - 16 X 1 1/4 HHCS			
73A	583218	1	PULLEY ADAPTER			X
73B	583508	1	FRONT DRIVE	X	X	
74	453020	1	CROSS ADAPTER			
75	453076	1	90 DEG SWIVEL			
76	453109	1	SWIVEL ELBOW			
77	593072	1	SUPPLY ADAPTER			
78	593181	2	WHEEL MOTOR SHAFT NUT			
79	107013	2	KEY, 5/16 X 1.0 (1001) WOODRUFF			

NOTES:

# 52" MID-CUT ELECTRICAL SECTION

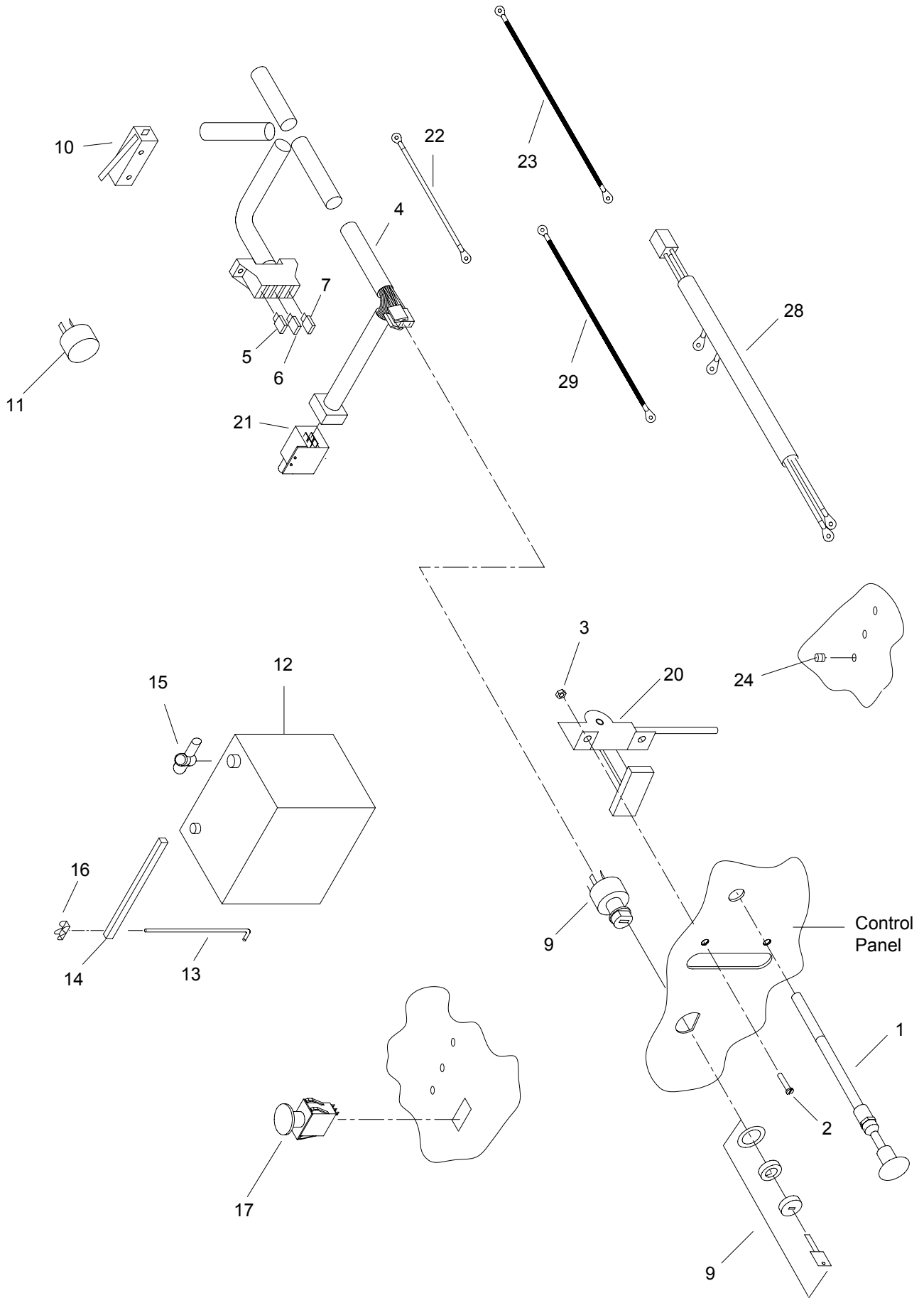

# 52" Mid-Cut Electrical Section

23 HP KAW  
25 HP KAW  
27 HP KAW

#	PART NO.	QTY	DESCRIPTION			
1	593044	1	CHOKE CABLE			
2	101039	6	#10 - 24 X 5/8" PAN HEAD BOLT			
3	104252	6	#10-24 NYLOC NUT			
4A	593050	1	WIRE HARNESS	X	X	
4B	593049	1	WIRE HARNESS			X
5	523145	1	20 AMP FUSE			
6	523146	1	15 AMP FUSE			
7	523147	1	10 AMP FUSE			
9	423027	1	IGNITION SWITCH ASSEMBLY			
10	593041	1	NEUTRAL SWITCH			
11	823194	1	ALARM			
12	423142	1	12 VOLT BATTERY			
13	423172	2	BATTERY HOLD DOWN			
14	423011	1	BATTERY HOLD DOWN ANGLE			
15	423158	3	TERMINAL INSULATOR			
X	823199	1	BATTERY BOOT - POS.			
16	109017	2	1/4"-20 WING NUT			
17	523031	1	PTO SWITCH			
20	593043	1	THROTTLE CABLE			
21	523034	1	PARK BRAKE SWITCH			
22	823196	1	POSITIVE CABLE			
23	823197	1	NEGATIVE CABLE			
24	523036	1	WARNING LIGHT	X	X	
24	523036	3	WARNING LIGHT			X
26	423030	1	SAFETY MODULE	X	X	X
27	423017	1	STARTER RELAY	X	X	X
28	583495	1	ENGINE WIRE HARNESS			X
29	423117	1	POSITIVE CABLE - LONG	X	X	

NOTES:

**61" MID-CUT  
GAS  
SECTION**

# 61" MID-CUT DECK ASSEMBLY

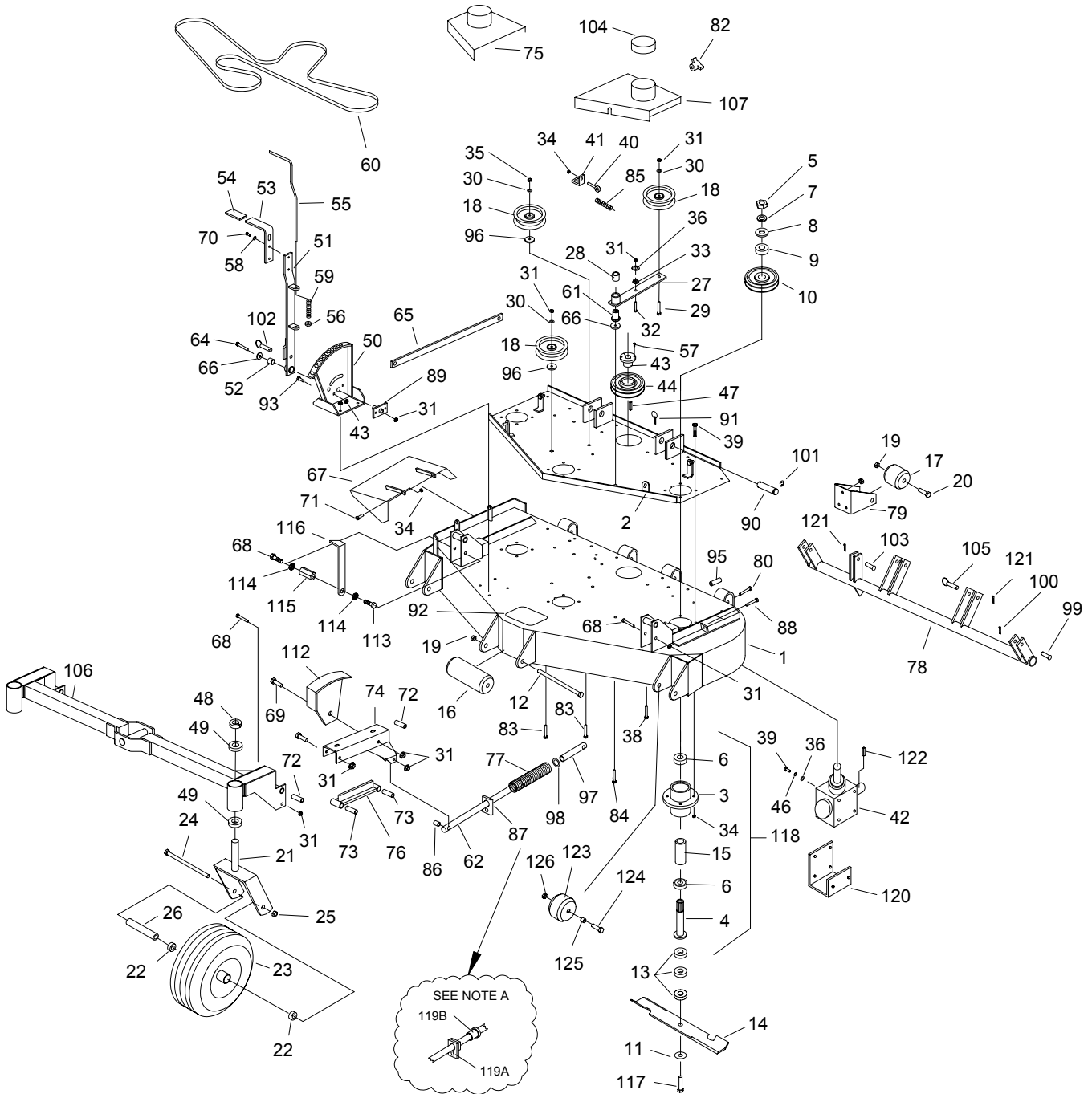

# 61" Mid-Cut Deck Assembly

#	PART NO.	QTY	DESCRIPTION
1	582016	1	61" MC DECK WLDMNT
2	582012	1	61" MC DECK CHANNEL
3	583111	3	SPINDLE HOUSING
4	583112	3	SPINDLE SHAFT
5	104511	3	3/4"-16 HEX NUT
6	363350	6	BEARING - BLADE SPINDLE
7	105010	3	3/4" LOCK WASHER
8	105269	3	3/4" SAE FLAT WASHER
9	583110	3	PULLEY SPACER
10	583107	3	SPINDLE PULLEY - 5 3/4"
11	583108	3	5/8" SPRING DISC WASHER
12	100351	1	5/8"-11 X 8 1/2" HEX BOLT
13	583109	9	BLADE SPACER
14	823006	3	21.0" HI LIFT BLADE
15	583113	3	BEARING SPACER TUBE
16	603023	1	ANTI-SCALP ROLLER
17	523084	2	REAR DECK ROLLER
18	523329	3	FLTG. IDLER - FLAT
19	104261	3	5/8"-11 NYLOC NUT
20	100346	2	5/8"-11 X 4 1/2" HEX BOLT
21	822088	2	WIDE TAIL WHEEL STRUT
22	363187	4	1" BEARING
23	823220	2	WIDE TIRE ASSY ( COMPLETE )
23A	823339	X	TIRE ( 13 X 6.5 X 6 )
23B	823338	X	FRONT RIM W/ VALVESTEM
24	100352	2	5/8"-11 X 9" HEX BOLT
25	104261	2	5/8"-11 NYLOC NUT
26	823245	2	AXLE TUBE
27	822144	1	DECK IDLER ARM W/BUSHING
28	523111	1	3/4 PLASTIC BUSHING
29	107511	1	3/8"-16 X 2" CARRIAGE BOLT
30	105260	8	3/8" FLAT WASHER
31	104257	16	3/8"-16 NYLOC NUT
32	100275	1	5/16"-18 X 1 1/2" HEX BOLT
33	109001	2	5/16"-18 WHIZLOCK NUT
34	104256	36	5/16"-18 NYLOC NUT
35	109007	2	3/8"-16 WHIZLOCK NUT
36	105258	9	5/16" FLAT WASHER
37	107503	10	5/16"-18 X 3/4" CARRIAGE BOLT
38	107509	5	5/16"-18 X 1" CARRIAGE BOLT
39	100274	12	5/16"-18 X 1 1/4" HEX BOLT
40	363080	1	RIGHT EYE BOLT

# 61" Mid-Cut Deck Assembly

#	PART NO.	QTY	DESCRIPTION
41	523094	1	SPRING MT.-DECK
42	583087	1	DECK - GEAR BOX
43	523371	1	3/4" TAPER HUB
44	523096	1	5" TAPERED PULLEY
46	105005	4	5/16" LOCK WASHER
47	107255	1	3/16" X 1" KEY
48	363145	2	1" CLAMP COLLAR
49	363187	2	1" FLANGE BEARING
50	582021	1	HEIGHT ADJUSTMENT BRACKET
51	822141	1	DECK HEIGHT BAR W/BUSHING
52	253059	1	ENGAGEMENT BUSHING
53	822062	1	DECK HEIGHT HANDLE W/GRIP
54	823312	1	GRIP
55	823149	1	HANDLE ROD
56	823093	1	3/8" CLAMP COLLAR
57	100252	6	1/4"-20 X 3/4" HEX BOLT
58	105004	2	1/4" LOCK WASHER
59	523028	1	ASSIST SPRING
60	823242	1	61" DECK BELT
61	423175	1	PUMP IDLER PIVOT
62	823155	2	CASTER ROD
64	100297	1	3/8"-16 X 2 1/4" HEX BOLT
65	582063	1	LIFT ARM WELDMENT
66	373089	1	3/8 STD RETAINING WASHER
67	582025	1	GRASS DEFLECTOR - 61
68	100300	4	3/8"-16 X 3" HEX BOLT
69	100301	4	3/8"-16 X 3 1/4" HEX BOLT
70	100251	2	1/4"-20 X 5/8" HEX BOLT
71	100273	2	5/16"-18 X 1" HEX BOLT
72	823330	4	CASTER ARM PIVOT
73	823090	4	CASTER BAR PIVOT
74A	582053	1	LEFT HAND CASTER ARM
74B	582051	1	RIGHT HAND CASTER ARM
75	582055	1	RIGHT HAND BELT SHIELD
76	582059	2	CASTER BAR WELDMENT
77	823150	2	HEAVY COMPRESSION SPRING
78	822124	1	61" DECK TUBE WELDMENT
79	583074	2	ROLLER MOUNT
80	100298	2	3/8"-16 X 2 1/2" HEX BOLT
82	753028	4	KNOB
83	107516	2	3/8"-16 X 2 1/4" CARRIAGE BOLT
84	107513	3	3/8"-16 X 3" CARRIAGE BOLT

# 61" Mid-Cut Deck Assembly

#	PART NO.	QTY	DESCRIPTION
85	593074	1	SPRING - FLTG. IDLER
86	823153	2	CASTER ROD SPACER
87	823159	2	SPRING SLIDE ( SEE NOTE A )
88	100030	2	3/8"-16 X 3" TAP BOLT
89	822132	1	DECK HEIGHT PIVOT
90	823333	2	DECK ATTACH PIN
91	108001	2	3/16" QUICK PIN
92	823200	1	STEP TREAD
93	107502	2	1/4"-20 X 3/4" CARRIAGE BOLT
94	104255	2	1/4"-20 NYLOC NUT
95	823314	2	TUBE SADDLE SPACER
96	483017	2	RIGHT HAND IDLER SPACER
97	823157	2	CASTER ROD END
98	109025	2	5/8" HEAVY WASHER
99	823210	2	1/2" X 2" CLEVIS PIN
100	106763	2	1/8" COTTER PIN
101	108510	4	7/8" E-RING
102	109026	1	1/2" X 2" DETENT PIN
103	823209	1	1/2" X 1 1/2" CLEVIS PIN
104	363161	2	BELT SHIELD CAP
105	823211	2	1/2" X 2 1/2" RING PIN
106	582010	1	FRONT AXLE
107	582057	1	LEFT HAND BELT SHIELD
112	582176	1	CUT GAGE WELDMENT
113	100291	1	3/8"-16 X 3/4" HEX BOLT
114	105006	2	3/8" LOCK WASHER
115	583422	1	NUT - CUT GAGE
116	583420	1	POINTER - CUT GAGE
117	100358	3	5/8"-11 X 2 1/4" HEX BOLT
118	583106	3	BLADE SPINDLE ASSY
119A	592006	1	SPRING RETAINER
119B	593176	1	LIFT SPRING CUP
120	593096	1	GEAR BOX TRUSS
121	106778	2	3/16 X 1 1/2" COTTER PIN
122	107255	1	KEY - 3/16" X 1"
123	423023	2	ANTI-SCALP ROLLER
124	100336	2	1/2-13 X 4 1/2 HHCS
125	453132	2	SPACER
126	104259	2	1/2-13 NYLOC

**NOTES:**

- A    PERFORMANCE UPGRADE FOR DECK SPRING ASSY. REQUIRES ITEM 119. BOTH SIDES NEED BE UPGRADED AT THE SAME TIME.

# 61" MID-CUT MAINFRAME ASSEMBLY

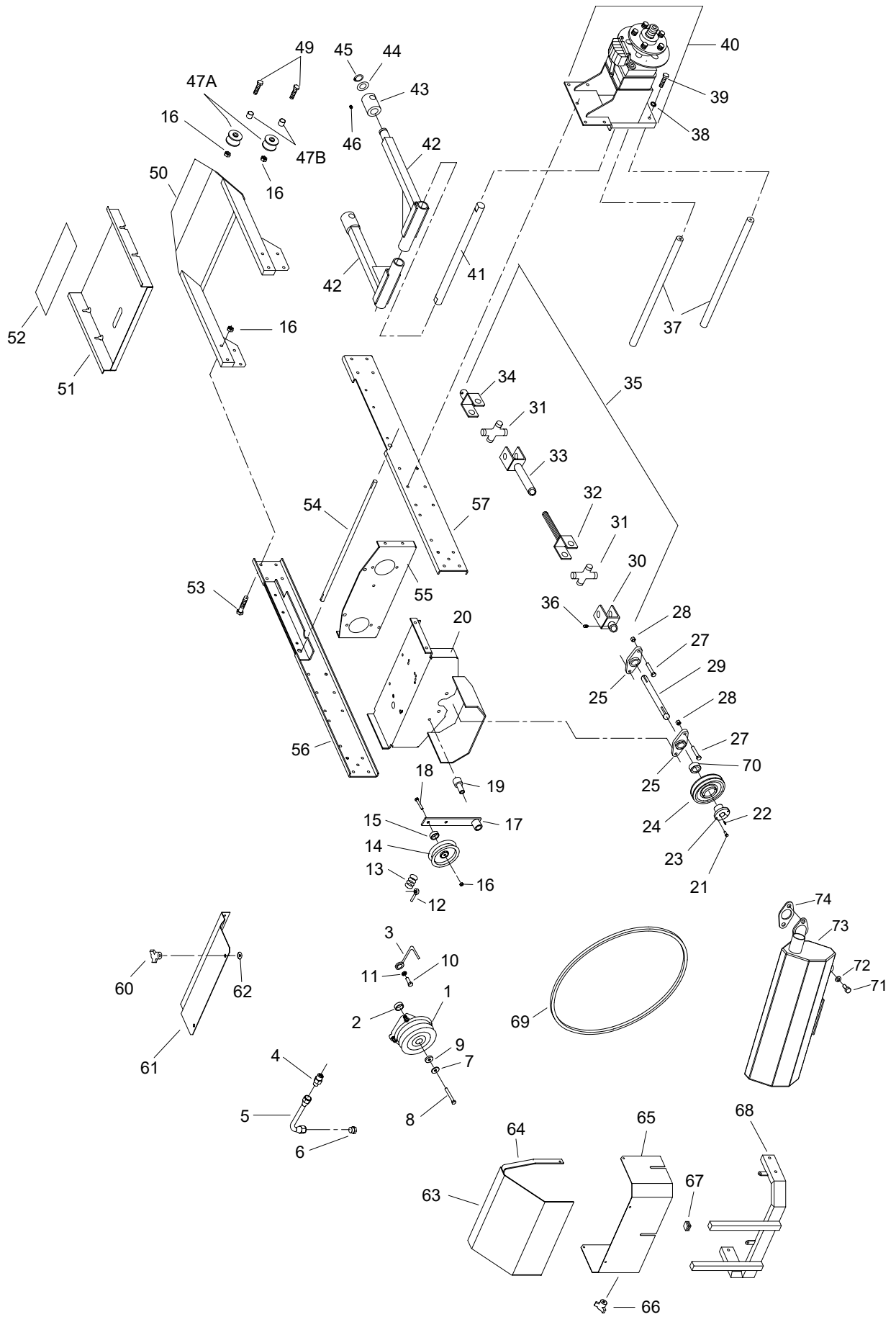

# 61" Mid-Cut Mainframe Assembly

25 HP KAW  
27 HP KAW

#	PART NO.	QTY	DESCRIPTION	25 HP KAW	27 HP KAW
1A	823165	1	ELECTRIC CLUTCH - MS	X	
1B	583518	1	ELECTRIC CLUTCH - MS		X
2	523322	2	CLUTCH SPACER		
3	363075	1	ROUND BELT GUIDE		
4	523063	1	ENGINE DRAIN ADAPTER		
5	523064	1	ENGINE DRAIN LINE		
6	523065	1	ENGINE DRAIN PLUG		
7	753027	1	3/8" DISC SPRING WASHER		
8	109019	1	10MM-1.5 X 30MM HEX BOLT		
9	423068	1	CLUTCH WASHER		
10	100512	2	5/16"-24 X 1" HEX BOLT		
11	363226	4	DISC SPRING WASHER		
12	363080	1	RIGHT EYEBOLT		
13	593074	1	IDLER SPRING - HH		
14	483025	1	RIGHT HAND IDLER PULLEY		
15	483017	1	RIGHT HAND IDLER SPACER		
16	104257	30	3/8"-16 NYLOC NUT		
17	422025	1	TENSIONER W/BUSHING		
X	523111	X	BUSHING ( SERVICE )		
18	100297	1	3/8"-16 X 2 1/4" HEX BOLT		
19	823030	1	IDLER PIVOT		
20	582043	1	ENGINE BASE - KAW	X	X
21	100503	2	1/4" X 3/4" HEX BOLT		
22	107259	1	1/4" X 1/4" X 1" KEY		
23	363215	1	TAPER LOCK HUB		
24A	523096	1	TAPER LOCK SHEAVE	X	
24B	363216	1	TAPER LOCK SHEAVE		X
25	823032	2	2 BOLT FLANGE BEARING		
27	100311	4	7/16"-14 X 1 1/4" HEX BOLT		
28	104258	4	7/16"-14 NYLOC NUT		
29	583080	1	1" POWER SHAFT - MC		
30	523414	1	1" YOKE		
31	523415	2	CROSS		
32	593075	1	YOKE SHAFT		
33	583481	1	YOKE TUBE		
34	823372	1	3/4" YOKE		
35	593064	1	COMPLETE PTO SHAFT		
36	103295	2	3/8"-16 X 1/2" SET SCREW		
37	823066	2	BRACE ROD - LOWER		
38	105006	6	3/8" LOCKWASHER		
39	100292	23	3/8"-16 X 1" HEX BOLT		
40			SEE HYDRAULIC ILLUSTRATION		

# 61" Mid-Cut Mainframe Assembly

25 HP KAW  
27 HP KAW

#	PART NO.	QTY	DESCRIPTION		
41	823050	1	DECK ARM SHAFT		
42	822036	2	DECK ARM		
43	822090	2	DCK ARM SWVL W/ZERK		
44	823015	4	DECK ARM WASHER		
45	108502	2	SNAP RING		
46	111004	12	1/4"-28 GREASE ZERK		
47	583120	2	FRONT PIVOT ROLLER (REF ONLY)		
47A	583464	2	FRONT ROLLER		
47B	583490	2	FRONT ROLLER TUBE		
49	100298	2	3/8"-16 X 2 1/2" HEX BOLT		
50	582006	1	FRONT FRAME		
51	593078	1	FOOT PLATE		
52	823042	3	FOOT PLATE TREAD		
53	100295	4	3/8"-16 X 1 3/4" HEX BOLT		
54	823140	1	PARK SHAFT		
55			SEE HYDRAULIC ILLUSTRATION		
56	582041	1	LEFT HAND FRAME RAIL		
57	582039	1	RIGHT HAND FRAME RAIL		
60	583168	2	KNOB 5/16" STUD		
61A	592036	1	CENTER COVER A / C	X	
61B	583010	1	FRONT ENGINE COVER		X
62	109030	2	5/16" RETAINING CLIP		
63	822146	1	REAR COVER		
64	823335	2	REAR COVER STRAP		
65	583504	1	REAR COVER - KAW		
66	753028	2	KNOB		
67	583191	2	1" SQ. TUBE PLUG		
68	582061	1	ENGINE GUARD - REAR		
69B	823267	1	CLUTCH BELT	X	
69C	583517	1	CLUTCH BELT		X
70	363145	1	1" CLAMP COLLAR		
71	100271	2	5/16-18 X 3/4 BOLT		
72	105005	2	5/16 HEAVY LOCKWASHER		
73	593123	1	MUFFLER-KAW 27 LC		
74	593213	2	MUFFLER GASKET-27 KAW		

NOTES:

- A CONTACT ENGINE MFG FOR ALL ENGINE & RADIATOR PARTS NOT SHOWN. ENCORE MFG DO NOT SERVICE THESE PARTS!



# 61" Mid-Cut Seatframe Assembly

25 HP KAW  
27 HP KAW

#	PART NO.	QTY	DESCRIPTION		
1	100252	28	1/4-20 X 3/4 HHCS		
2	100254	8	1/4"-20 X 1" HEX BOLT		
3	100271	19	5/16-18 X 3/4 HHCS		
4	100273	8	5/16-18 X 1 HHCS		
5	100274	4	5/16-18 X 1-1/4 TAP BOLT		
6	100275	2	5/16-18 X 1-1/2 HHCS		
7	100294	2	3/8-16 – 1-1/2 HHCS		
8	100303	2	3/8-16 X 4 HHCS		
9	102000	3	#12-24 X 5/8 SELF TAP. SCREW		
10	104253	2	5/16-24 NYLOC NUT		
11	104255	2	1/4"-20 NYLOC NUT		
12	104256	33	5/16-18 NYLOC NUT		
13	104257	3	3/8"-16 NYLOC NUT		
14	104752	4	5/16-24 JAM NUT		
15	105005	10	5/16 LOCKWASHER - HEAV		
16	105256	28	1/4 STD. FLATWASHER		
17	105258	4	5/16 STD. FLATWASHER		
18	105260	1	3/8 WASHER - STD FLAT		
19	105261	2	3/8 ANS. TYPE B FLATWASHER		
20	107503	2	5/16-18 X 3/4 CARR. BOLT		
21	107520	2	5/16-18 X 1-3/4 CARR BOLT		
22	109000	8	1/4"-20 WHIZ LOCK NUT		
23	109001	4	5/16-18 WHIZLOCK NUT		
24	109015	24	1/4-20 NUT CLIP		
25	153045	1	5/16 PUSH NUT		
26	363029	1	.312 ROD SWIVEL		
27A	363098	2	GAS LINE CLAMP		
27B	363098	4	FUEL LINE CLAMP		
28	363105	1	BUSHING		
29	363113	4	SPACER		
30	363165	1	#3 ISSCO HAIRPIN COTTER (#2)		
32	373054	2	SPRING		
33	393042	2	GROMMET		
34	423140	4	3/4 ID 2 BOLT BEARING		
35	423160	2	5/16-24 BALL STUD		
36	453082	2	5/16 ROD END		
37	523030	1	SEAT SWITCH		
38	523031	1	PTO SWITCH		
39	523032	2	HANDLE GRIP		
40	523033	2	HANDLE PLUG		
41	523034	1	PARK SWITCH		
42	523044	1	SEAT CABLE		

# 61" Mid-Cut Seatframe Assembly

25 HP KAW  
27 HP KAW

#	PART NO.	QTY	DESCRIPTION		
43	523112	2	5/16 CLAMP COLLAR		
44	523278	2	SEAT SPRING		
45	523283	1	HOUR METER		
46	582048	1	PARK LEVER w/ GRIP		
47	583050	1	FUEL VALVE		
48	583077	1	SEAT LT. GREY W/TRACK		
49	583089	1	SEAT CUSHION		
50	583090	1	BACK CUSHION		
51	593097	1	ARM REST PAD - LH		
51	593097	1	ARM REST PAD - RH		
52	583183	2	FUEL TANK ADAPTER		
53	583184	1	FUEL LINE		
54	583186	1	FUEL LINE – 29”		
55	583224	1	SEAT STOP		
56	583401	1	BATTERY MOUNT		
57	583415	2	DAMPENER		
58	583438	2	ADJUSTMENT PLATE		
60A	592041	1	CONTROL HANDLE - RH		
60B	592042	1	CONTROL HANDLE - LH		
61	592008	1	SEAT FRAME WELDMENT		
62	592010	1	SEAT PLATE WELDMENT		
63	592012	1	RH REAR TANK MT.		
64	592014	1	LH REAR TANK MT.		
65	592016	1	FRONT TANK MOUNT – RH		
66	592018	1	FRONT TANK MOUNT – LH		
67	592020	1	CONTROL PANEL		
68	592060	2	HANDLE MOUNT WELDMNT-LH		
69	592024	2	CONTROL PIVOT RIGHT		
69	592026	1	CONTROL PIVOT LEFT		
70	593001	1	FUEL TANK/FENDER - LH		
71	593002	1	FUEL TANK/FENDER - RH		
72	593008	2	1-1/2” GROMMET		
73	593010	2	HANDLE MOUNT BAR		
74A	593022	2	RH CONTROL MOUNT		
74B	593024	1	LH CONTROL MOUNT		
75	593026	2	RH CONTROL COVER		
76	593028	2	LH CONTROL COVER		
77	593032	1	RH CONTROL LINK		
78	593034	1	LH CONTROL LINK		
79	593048	1	SWITCH MOUNT – NEUTRAL		
80	593058	2	NEUTRAL INDICATOR		
81	593067	1	RH TANK PANEL		

# 61" Mid-Cut Seatframe Assembly

25 HP KAW  
27 HP KAW

#	PART NO.	QTY	DESCRIPTION		
82	593068	1	LH TANK PANEL		
83	603032	1	FUEL LINE - 24"		
84	823127	2	NEUTRAL LINK		
85	823132	1	PARK BRAKE LINK		
86	823179	2	FUEL CAP - LARGE		
87	823194	1	ALARM		
88	823221	4	BALL STUD		

NOTES:

# 61" MID-CUT SMALL HYDRO PUMP ASSEMBLY

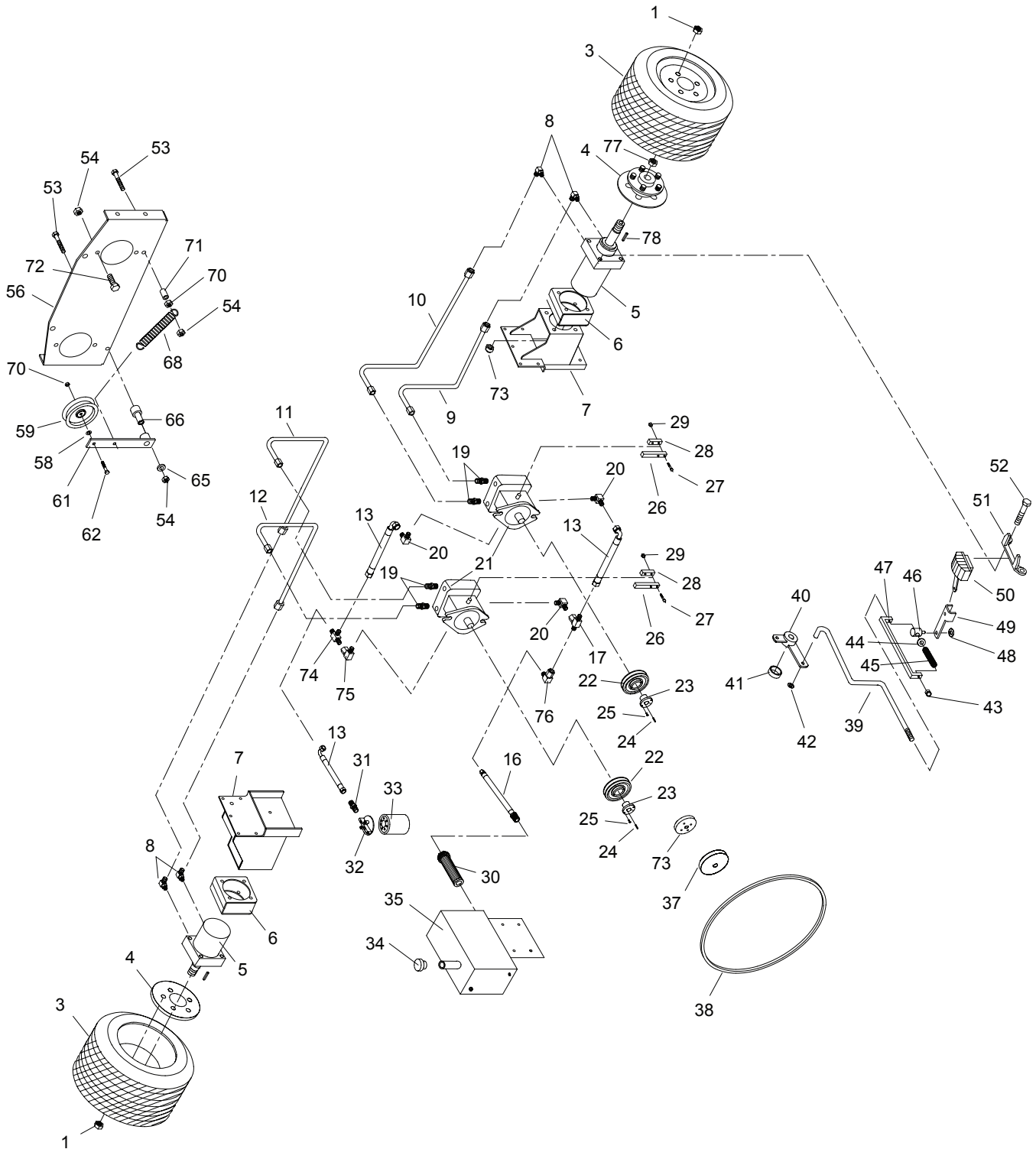

# 61" Mid-Cut Small Hydro Pump Assembly

25 HP KAW  
27 HP KAW

#	PART NO.	QTY	DESCRIPTION		
1	103023	10	LUG NUT		
3	583055	2	DRIVE WHEEL ( COMPLETE )		
3A	583059	X	DRIVE TIRE ( 24 X 12 X 12 )		
3B	583487	X	BAR LUG TIRE ( 23 X 10.5 X 12 )		
3C	583058	X	RIM W/ VALVESTEM		
4	582008	2	WHEEL HUB		
5	583325	2	WHEEL MOTOR - MP14		
5A	583520	X	SEAL KIT - MP14		
6	582031	2	MOTOR SPACER		
7	582002	1	RIGHT HAND MOTOR MOUNT		
7	582004	1	LEFT HAND MOTOR MOUNT		
8	523058	4	90 DEGREE MOTOR ADAPTER		
9	583397	1	RIGHT HAND OUTSIDE LINE(61")		
10	583396	1	RIGHT HAND INSIDE LINE(61")		
11	583398	1	LEFT HAND INSIDE LINE(61")		
12	583399	1	LEFT HAND OUTSIDE LINE(61")		
13	583241	2	PUMP TO PUMP HOSE		
16	453129	1	PUMP TO TANK SUPPLY HOSE		
17	453106	1	SWIVEL TEE		
19	583126	4	STRAIGHT ADAPTER		
20	453074	3	90 DEGREE ADAPTER		
21	583491	2	PUMP- 10A W / RELIEF		
21A	583514	X	PUMP SEAL KIT - 10L		
22	583382	2	PUMP PULLEY		
23	423178	2	15 MM TAPER HUB		
24	453102	2	PUMP KEY		
25	100252	2	1/4"-20 X 3/4" HEX BOLT		
26	823104	2	CONTROL BAR		
27	100257	4	1/4"-20 X 1 3/4" HEX BOLT		
28	453090	2	CLAMP BAR		
29	104255	6	1/4"-20 NYLOC NUT		
30	583132	1	SUCTION SCREEN		
31	583442	1	FILTER ADAPTER(61")		
32	423064	1	FILTER HEAD		
33	423063	1	HYDRO OIL FILTER (NO CROSS REF AVAIL)		
34	423165	1	OIL BREATHER CAP(61")		
35	583049	1	OIL TANK(61")		
36	423065	1	OIL EYE		
37A	583200	1	PUMP DRIVE PULLEY	X	
37A	583217	1	PUMP PULLEY - KAW		X
38	583385	1	PUMP BELT SML PUMP	X	X
39A	583042	1	RIGHT HAND BRAKE ROD(61")		

# 61" Mid-Cut Small Hydro Pump Assembly

25 HP KAW  
27 HP KAW

#	PART NO.	QTY	DESCRIPTION		
39B	583044	1	LEFT HAND BRAKE ROD(61")		
40	422049	1	BRAKE CRANK		
41	373086	1	BLADE SPACER		
42	104256	6	5/16" PUSH NUT		
43	593116	2	BRAKE SPRINT NUT		
44	105257	2	5/16" SAE FLAT WASHER		
45	523024	2	DECK DR. SPRING		
46	423130	2	PARK BRAKE SWIVEL		
47	593114	2	PARK BRAKE STRAP		
48	363177	2	3/8" PUSH NUT		
49	583190	2	BRAKE ARM		
50A	583038	1	RIGHT HAND BRAKE CALIPER		
50B	583039	1	LEFT HAND BRAKE CALIPER		
50C	583511	X	BRAKE PAD KIT		
51	583040	2	CALIPER MOUNT		
52	100339	8	1/2"-13 X 6" HEX BOLT		
53	100300	2	3/8"-16 X 3" HEX BOLT		
54	104257	32	3/8" NYLOC NUT		
56	583328	1	PUMP PLATE -MCBDP10		
58	105260	13	3/8" FLAT WASHER		
59	823351	1	PUMP DRIVE IDLER		
61	422025	1	TENSIONER W/BUSHING		
X	523111	X	BUSHING ( SERVICE )		
62	100294	2	3/8"- 16 X 1 1/2 HHCS		
65	373089	2	RETAINING WASHER		
66	423175	1	IDLER PIVOT		
68	583144	1	PUMP IDLER SPRING		
70	109007	2	3/8"-16 WHIZLOCK NUT		
71	393070	1	IDLER SPACER		
73	583274	1	FRONT DRIVE ADAPTER		
72	100293	1	3/8" - 16 X 1 1/4 HHCS		
73A	583218	1	PULLEY ADAPTER		X
73B	583508	1	FRONT DRIVE	X	
74	453020	1	CROSS ADAPTER		
75	453076	1	90 DEG SWIVEL		
76	453109	1	SWIVEL ELBOW		
77	593181	2	WHEEL MOTOR SHAFT NUT - TJ		
78	107013	2	KEY, 5/16 X 1.0 (1001) WOODRUFF		

NOTES:

# 61" MID-CUT ELECTRICAL SECTION

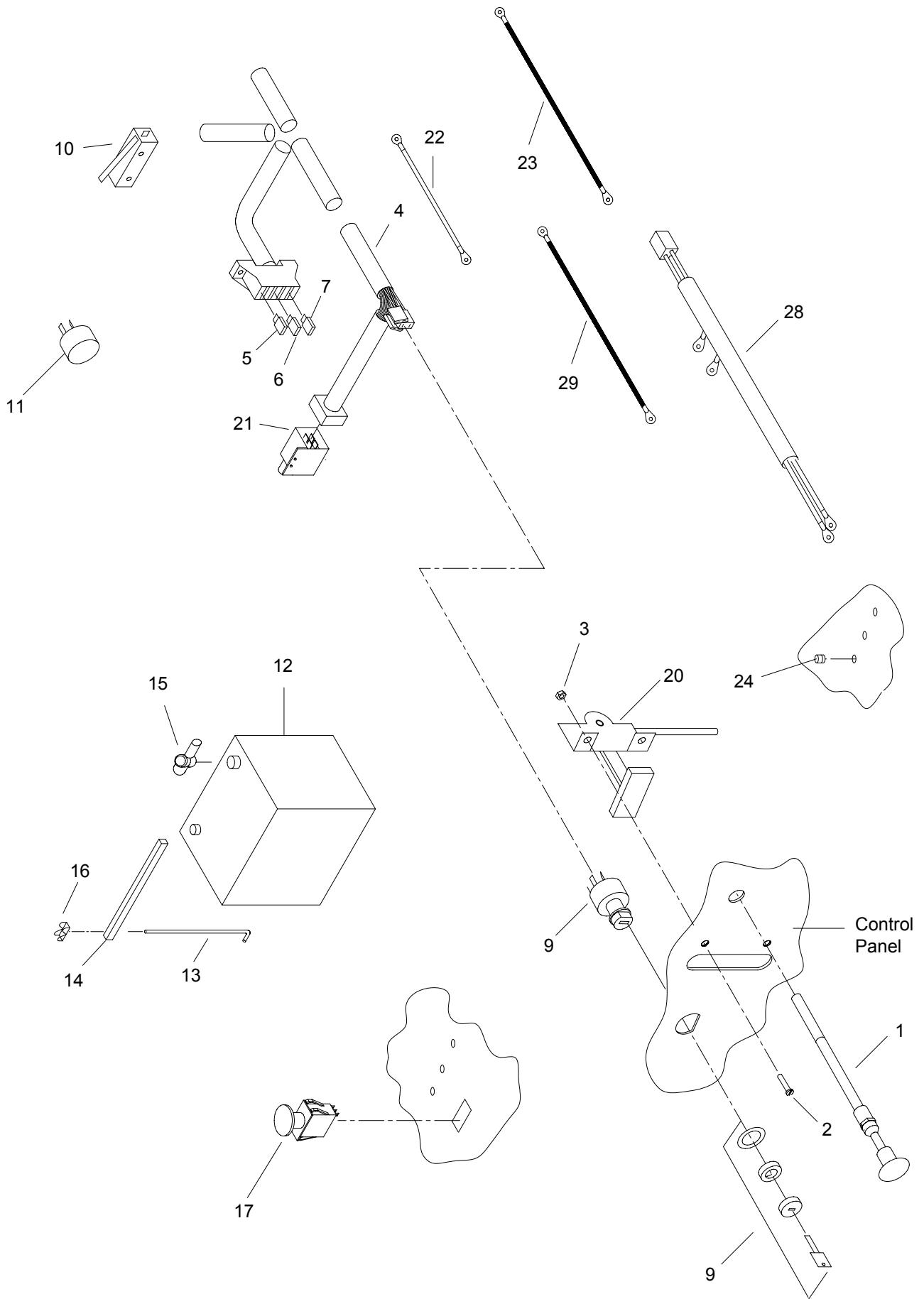

# 52" Mid-Cut Electrical Section

23 HP KAW  
25 HP KAW  
27 HP KAW

#	PART NO.	QTY	DESCRIPTION			
1	593044	1	CHOKE CABLE			
2	101039	6	#10 - 24 X 5/8" PAN HEAD BOLT			
3	104252	6	#10-24 NYLOC NUT			
4A	593050	1	WIRE HARNESS	X	X	
4B	593049	1	WIRE HARNESS			X
5	523145	1	20 AMP FUSE			
6	523146	1	15 AMP FUSE			
7	523147	1	10 AMP FUSE			
9	423027	1	IGNITION SWITCH ASSEMBLY			
10	593041	1	NEUTRAL SWITCH			
11	823194	1	ALARM			
12	423142	1	12 VOLT BATTERY			
13	423172	2	BATTERY HOLD DOWN			
14	423011	1	BATTERY HOLD DOWN ANGLE			
15	423158	3	TERMINAL INSULATOR			
X	823199	1	BATTERY BOOT - POS.			
16	109017	2	1/4"-20 WING NUT			
17	523031	1	PTO SWITCH			
20	593043	1	THROTTLE CABLE			
21	523034	1	PARK BRAKE SWITCH			
22	823196	1	POSITIVE CABLE			
23	823197	1	NEGATIVE CABLE			
24	523036	1	WARNING LIGHT	X	X	
24	523036	3	WARNING LIGHT			X
26	423030	1	SAFETY MODULE	X	X	X
27	423017	1	STARTER RELAY	X	X	X
28	583495	1	ENGINE WIRE HARNESS			X
29	423117	1	POSITIVE CABLE - LONG	X	X	

NOTES:

**61" MID-CUT  
DIESEL  
SECTION**

# 61" MID-CUT DECK ASSEMBLY

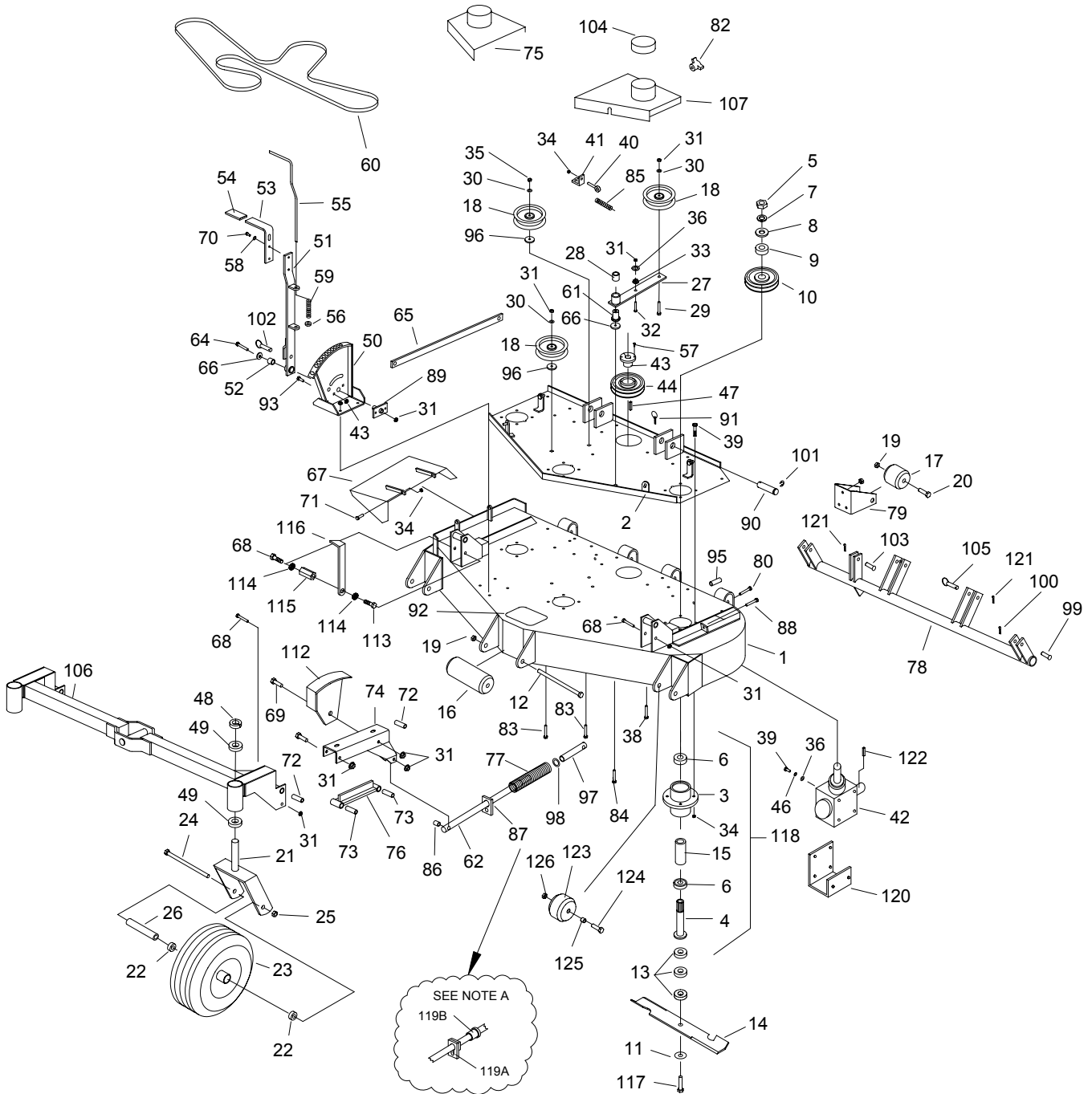

# 61" Mid-Cut Deck Assembly - Diesel

#	PART NO.	QTY	DESCRIPTION
1	582016	1	61" MC DECK WLDMNT
2	582012	1	61" MC DECK CHANNEL
3	583111	3	SPINDLE HOUSING
4	583112	3	SPINDLE SHAFT
5	104511	3	3/4"-16 HEX NUT
6	363350	6	BEARING - BLADE SPINDLE
7	105010	3	3/4" LOCK WASHER
8	105269	3	3/4" SAE FLAT WASHER
9	583110	3	PULLEY SPACER
10	583107	3	SPINDLE PULLEY - 5 3/4"
11	583108	3	5/8" SPRING DISC WASHER
12	100351	1	5/8"-11 X 8 1/2" HEX BOLT
13	583109	9	BLADE SPACER
14	823006	3	21.0" HI LIFT BLADE
15	583113	3	BEARING SPACER TUBE
16	603023	1	ANTI-SCALP ROLLER
17	523084	2	REAR DECK ROLLER
18	523329	3	FLTG. IDLER - FLAT
19	104261	3	5/8"-11 NYLOC NUT
20	100346	2	5/8"-11 X 4 1/2" HEX BOLT
21	822088	2	WIDE TAIL WHEEL STRUT
22	363187	4	1" BEARING
23	823220	2	WIDE TIRE ASSY ( COMPLETE )
23A	823339	X	TIRE ( 13 X 6.5 X 6 )
23B	823338	X	FRONT RIM W/ VALVESTEM
24	100352	2	5/8"-11 X 9" HEX BOLT
25	104261	2	5/8"-11 NYLOC NUT
26	823245	2	AXLE TUBE
27	822144	1	DECK IDLER ARM W/BUSHING
28	523111	1	3/4 PLASTIC BUSHING
29	107511	1	3/8"-16 X 2" CARRIAGE BOLT
30	105260	8	3/8" FLAT WASHER
31	104257	16	3/8"-16 NYLOC NUT
32	100275	1	5/16"-18 X 1 1/2" HEX BOLT
33	109001	2	5/16"-18 WHIZLOCK NUT
34	104256	36	5/16"-18 NYLOC NUT
35	109007	2	3/8"-16 WHIZLOCK NUT
36	105258	9	5/16" FLAT WASHER
37	107503	10	5/16"-18 X 3/4" CARRIAGE BOLT
38	107509	5	5/16"-18 X 1" CARRIAGE BOLT
39	100274	12	5/16"-18 X 1 1/4" HEX BOLT
40	363080	1	RIGHT EYE BOLT

# 61" Mid-Cut Deck Assembly - Diesel

#	PART NO.	QTY	DESCRIPTION
41	523094	1	SPRING MT.-DECK
42	583087	1	DECK - GEAR BOX
43	523371	1	3/4" TAPER HUB
44	523096	1	5" TAPERED PULLEY
46	105005	4	5/16" LOCK WASHER
47	107255	1	3/16" X 1" KEY
48	363145	2	1" CLAMP COLLAR
49	363187	2	1" FLANGE BEARING
50	582021	1	HEIGHT ADJUSTMENT BRACKET
51	822141	1	DECK HEIGHT BAR W/BUSHING
52	253059	1	ENGAGEMENT BUSHING
53	822062	1	DECK HEIGHT HANDLE W/GRIP
54	823312	1	GRIP
55	823149	1	HANDLE ROD
56	823093	1	3/8" CLAMP COLLAR
57	100252	6	1/4"-20 X 3/4" HEX BOLT
58	105004	2	1/4" LOCK WASHER
59	523028	1	ASSIST SPRING
60	823242	1	61" DECK BELT
61	423175	1	PUMP IDLER PIVOT
62	823155	2	CASTER ROD
64	100297	1	3/8"-16 X 2 1/4" HEX BOLT
65	582063	1	LIFT ARM WELDMENT
66	373089	1	3/8 STD RETAINING WASHER
67	582025	1	GRASS DEFLECTOR - 61
68	100300	4	3/8"-16 X 3" HEX BOLT
69	100301	4	3/8"-16 X 3 1/4" HEX BOLT
70	100251	2	1/4"-20 X 5/8" HEX BOLT
71	100273	2	5/16"-18 X 1" HEX BOLT
72	823330	4	CASTER ARM PIVOT
73	823090	4	CASTER BAR PIVOT
74A	582053	1	LEFT HAND CASTER ARM
74B	582051	1	RIGHT HAND CASTER ARM
75	582055	1	RIGHT HAND BELT SHIELD
76	582059	2	CASTER BAR WELDMENT
77	823150	2	HEAVY COMPRESSION SPRING
78	822124	1	61" DECK TUBE WELDMENT
79	583074	2	ROLLER MOUNT
80	100298	2	3/8"-16 X 2 1/2" HEX BOLT
82	753028	4	KNOB
83	107516	2	3/8"-16 X 2 1/4" CARRIAGE BOLT
84	107513	3	3/8"-16 X 3" CARRIAGE BOLT

# 61" Mid-Cut Deck Assembly - Diesel

#	PART NO.	QTY	DESCRIPTION
85	593074	1	SPRING - FLTG. IDLER
86	823153	2	CASTER ROD SPACER
87	823159	2	SPRING SLIDE ( SEE NOTE A )
88	100030	2	3/8"-16 X 3" TAP BOLT
89	822132	1	DECK HEIGHT PIVOT
90	823333	2	DECK ATTACH PIN
91	108001	2	3/16" QUICK PIN
92	823200	1	STEP TREAD
93	107502	2	1/4"-20 X 3/4" CARRIAGE BOLT
94	104255	2	1/4"-20 NYLOC NUT
95	823314	2	TUBE SADDLE SPACER
96	483017	2	RIGHT HAND IDLER SPACER
97	823157	2	CASTER ROD END
98	109025	2	5/8" HEAVY WASHER
99	823210	2	1/2" X 2" CLEVIS PIN
100	106763	2	1/8" COTTER PIN
101	108510	4	7/8" E-RING
102	109026	1	1/2" X 2" DETENT PIN
103	823209	1	1/2" X 1 1/2" CLEVIS PIN
104	363161	2	BELT SHIELD CAP
105	823211	2	1/2" X 2 1/2" RING PIN
106	582010	1	FRONT AXLE
107	582057	1	LEFT HAND BELT SHIELD
112	582176	1	CUT GAGE WELDMENT
113	100291	1	3/8"-16 X 3/4" HEX BOLT
114	105006	2	3/8" LOCK WASHER
115	583422	1	NUT - CUT GAGE
116	583420	1	POINTER - CUT GAGE
117	100358	3	5/8"-11 X 2 1/4" HEX BOLT
118	583106	3	BLADE SPINDLE ASSY
119A	592006	1	SPRING RETAINER
119B	593176	1	LIFT SPRING CUP
120	593096	1	GEAR BOX TRUSS
121	106778	2	3/16 X 1 1/2" COTTER PIN
122	107255	1	KEY - 3/16" X 1"
123	423023	2	ANTI-SCALP ROLLER
124	100336	2	1/2-13 X 4 1/2 HHCS
125	453132	2	SPACER
126	104259	2	1/2-13 NYLOC

**NOTES:**

- A    PERFORMANCE UPGRADE FOR DECK SPRING ASSY. REQUIRES ITEM 119.  
      BOTH SIDES NEED BE UPGRADED AT THE SAME TIME.

# 61" MID-CUT MAINFRAME ASSEMBLY

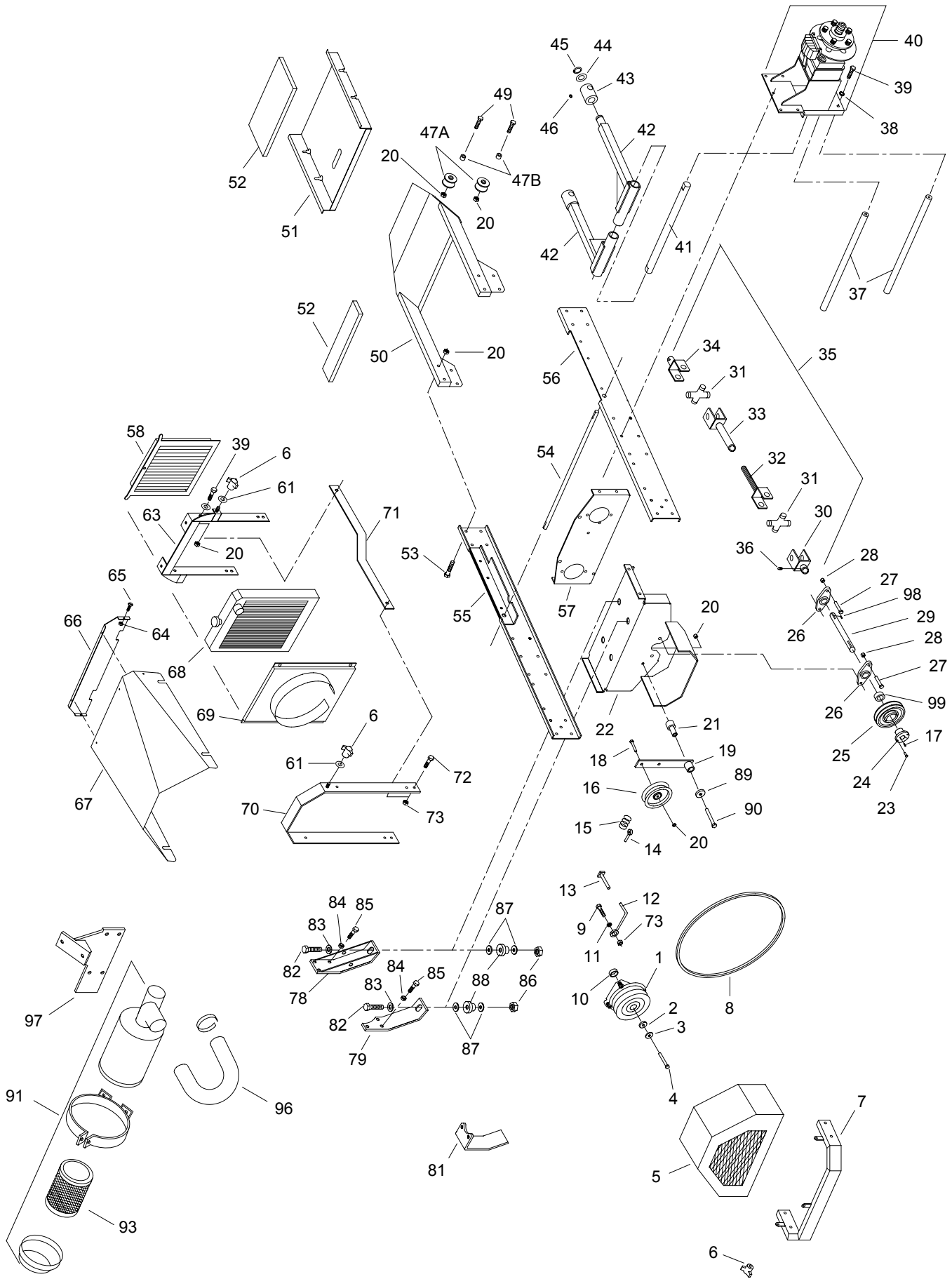

# 61" Mid-Cut Mainframe Assembly - Diesel

#	PART NO.	QTY	DESCRIPTION
1	583308	1	CLUTCH - 200 FT/LBS
2	373089	1	RETAINER WASHER
3	423069	2	7/16" SPRING DISC WASHER
4	100534	1	7/16"-20 X 1 1/4" HEX BOLT
5	582157	1	CLUTCH COVER - IL3
6	753028	7	KNOB
7	582132	1	ENGINE GUARD
8	523374	1	CLUTCH BELT
9	100273	16	5/16"-18 X 1" HEX BOLT
10	823248	2	CLUTCH SPACER 9/32
11	105258	6	5/16" FLAT WASHER
12	363075	1	ROUND BELT GUIDE
13	582169	1	CLUTCH STOP
14	363080	1	RIGHT EYE BOLT
15	593074	1	IDLER SPRING HH
16	483025	1	RIGHT HAND IDLER PULLEY
17	107259	1	1/4" X 1/4" X 1" KEY
18	100294	6	3/8"-16 X 1 1/2" HEX BOLT
19	422025	1	TENSIONER W/BUSHING
X	523111	X	BUSHING ( SERVICE )
20	104257	32	3/8"-16 NYLOC NUT
21	823030	1	PUMP IDLER SUPPORT
22	582165	1	ENGINE BASE 26 DSL MC
23	100503	2	1/4" X 3/4" HEX BOLT
24	363215	1	TAPER LOCK HUB
25	523507	1	TAPER LOCK SHEAVE
26	823032	2	2-BOLT FLANGE BEARING
27	100311	4	7/16"-14 X 1 1/4" HEX BOLT
28	104258	4	7/16"-14 NYLOC NUT
29	583271	1	POWER SHAFT - MC - DSL
30	523414	1	1" YOKE
31	523415	2	CROSS & BEARING
32	593075	1	YOKE SHAFT
33	583481	1	YOKE TUBE
34	823372	1	3/4" YOKE
35	593064	1	DRIVE SHAFT MC
36	103295	2	3/8"-16 X 1/2" SET SCREW
37	823066	2	BRACE ROD - LOWER
38	105006	6	3/8" LOCK WASHER
39	100292	23	3/8"-16 X 1" HEX BOLT
40			SEE HYDRAULIC ILLUSTRATION
41	823050	1	DECK ARM SHAFT

# 61" Mid-Cut

## Mainframe Assembly - Diesel

#	PART NO.	QTY	DESCRIPTION
42	822036	2	DECK ARM
43	822090	2	DECK SWIVEL W/ZERK
44	823015	4	DECK ARM WASHER
45	108502	2	SNAP RING
46	111004	12	1/4"-28 GREASE ZERK
47	583464	2	FRONT ROLLER - MC
47A	583464	2	FRONT ROLLER
47B	583490	2	FRONT ROLLER TUBE
49	100298	2	3/8"-16 X 2 1/2" HEX BOLT
50	582006	1	FRONT FRAME
51	593078	1	FOOT PLATE
52A	583374	1	FOOT REST PAD LARGE
52B	583373	1	FOOT REST PAD SMALL
53	100295	4	3/8"-16 X 1 3/4" HEX BOLT
54	823140	1	PARK SHAFT
55	582126	1	LEFT HAND FRAME RAIL
56	582124	1	RIGHT HAND FRAME RAIL
57			SEE HYDRAULIC ILLUSTRATION
58	583301	1	RADIATOR SCREEN
61	105260	13	3/8" FLAT WASHER
63	582159	1	RADIATOR MOUNT
64	104252	15	#10-24 NYLOC NUT
65	101039	17	#10-24 X 5/8" SCREW
66	583010	1	FRONT ENGINE COVER - IL3
67	583296	1	ENGINE COVER
68	SEE NOTE A	1	RADIATOR ASSY.
69	583476	1	FAN SHROUD
70	582161	1	HOOD BRACE
71	583356	2	HOOD SIDE BRACE
72	100271	4	5/16"-18 X 3/4" HEX BOLT
73	104256	5	5/16"-18 NYLOC NUT
78	583250	2	ENGINE MOUNT FRONT
79	582116	2	ENGINE MOUNT - 3 CYL.
81	582134	1	FUEL FILTER MOUNT
82	100327	4	1/2"-13 X 1 1/2" HEX BOLT
83	105264	4	1/2" FLAT WASHER
84	105005	6	5/16" LOCK WASHER
85	109031	6	M8-1.25 X 20MM HEX BOLT
86	104259	4	1/2"-13 NYLOC NUT
87	583478	8	WASHER-ISO MOUNT
88	583303	4	ISO BUSHING
89	373089	1	RETAINING WASHER

# 61" Mid-Cut Mainframe Assembly - Diesel

#	PART NO.	QTY	DESCRIPTION
90	100300	2	3/8"-16 X 3" HEX BOLT
91	583297	1	AIR CLEANER ASSY
93	583298	1	AIR FILTER ELEMENT
96	583369	1	AIR FILTER HOSE U-SHAPE
97	582153	1	AIR FILTER MOUNT
98	107258		POWER SHAFT KEY
99	363145	1	1" CLAMP COLLAR

**NOTES:**

- A CONTACT ENGINE MFG FOR ALL ENGINE & RADIATOR PARTS SHOWN. **ENCORE MFG DO NOT SERVICE THESE PARTS!**

# 61" MID-CUT SEATFRAME ASSEMBLY

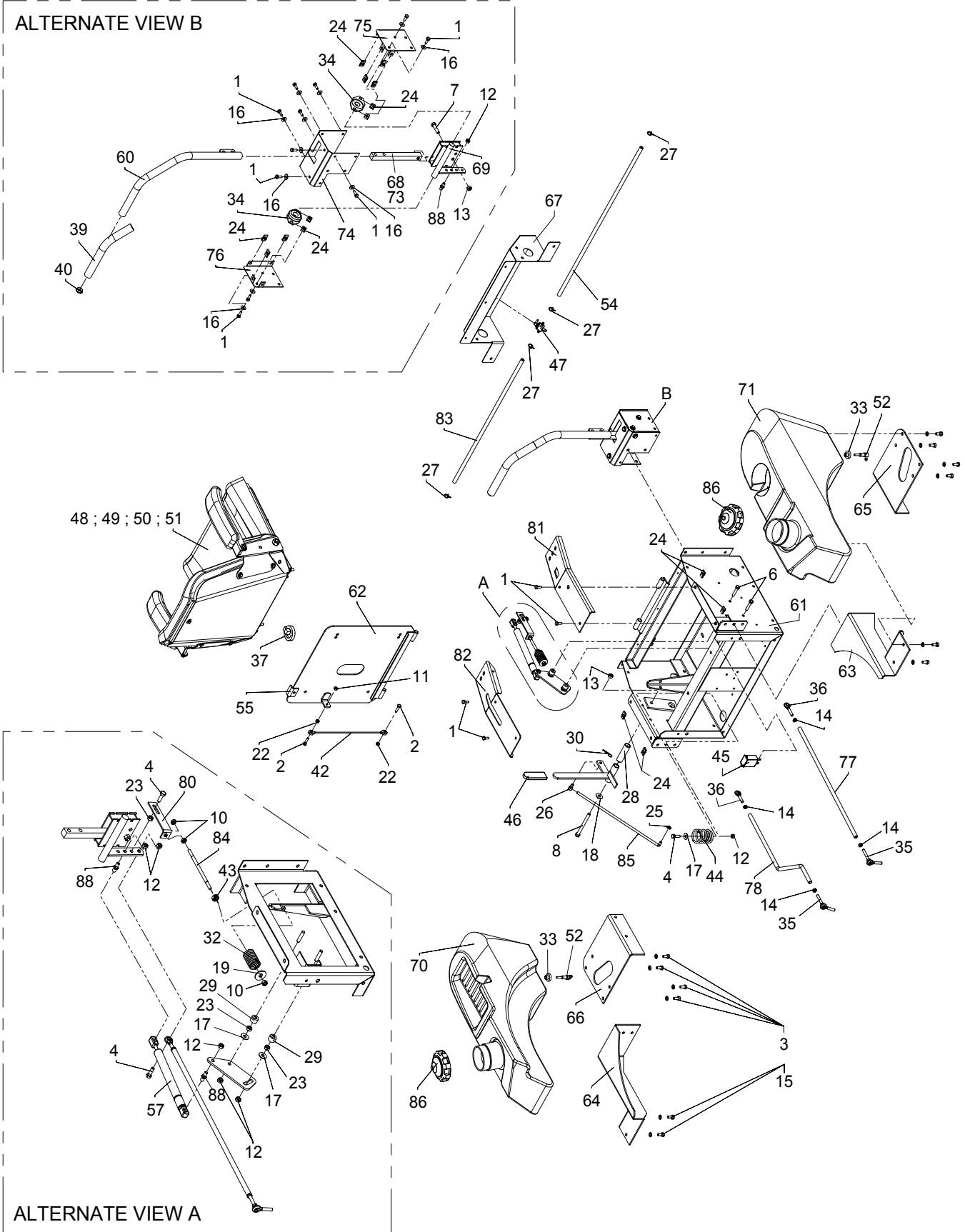

# 61" Mid-Cut Seatframe Assembly - Diesel

#	PART NO.	QTY	DESCRIPTION
1	100252	28	1/4-20 X 3/4 HHCS
2	100254	8	1/4"-20 X 1" HEX BOLT
3	100271	19	5/16-18 X 3/4 HHCS
4	100273	8	5/16-18 X 1 HHCS
5	100274	4	5/16-18 X 1-1/4 TAP BOLT
6	100275	2	5/16-18 X 1-1/2 HHCS
7	100294	2	3/8-16 – 1-1/2 HHCS
8	100303	2	3/8-16 X 4 HHCS
9	102000	3	#12-24 X 5/8 SELF TAP. SCREW
10	104253	2	5/16-24 NYLOC NUT
11	104255	2	1/4"-20 NYLOC NUT
12	104256	33	5/16-18 NYLOC NUT
13	104257	3	3/8"-16 NYLOC NUT
14	104752	4	5/16-24 JAM NUT
15	105005	10	5/16 LOCKWASHER - HEAV
16	105256	28	1/4 STD. FLATWASHER
17	105258	4	5/16 STD. FLATWASHER
18	105260	1	3/8 WASHER - STD FLAT
19	105261	2	3/8 ANS. TYPE B FLATWASHER
20	107503	2	5/16-18 X 3/4 CARR. BOLT
21	107520	2	5/16-18 X 1-3/4 CARR BOLT
22	109000	8	1/4"-20 WHIZ LOCK NUT
23	109001	4	5/16-18 WHIZLOCK NUT
24	109015	24	1/4-20 NUT CLIP
25	153045	1	5/16 PUSH NUT
26	363029	1	.312 ROD SWIVEL
27	363098	8	GAS LINE CLAMP - DSL
28	363105	1	BUSHING
29	363113	4	SPACER
30	363165	1	#3 ISSCO HAIRPIN COTTER (#2)
32	373054	2	SPRING
33	393042	2	GROMMET
34	423140	4	3/4 ID 2 BOLT BEARING
35	423160	2	5/16-24 BALL STUD
36	453082	2	5/16 ROD END
37	523030	1	SEAT SWITCH
38	523031	1	PTO SWITCH
39	523032	2	HANDLE GRIP
40	523033	2	HANDLE PLUG
41	523034	1	PARK SWITCH
42	523044	1	SEAT CABLE
43	523112	2	5/16 CLAMP COLLAR

# 61" Mid-Cut Seatframe Assembly - Diesel

#	PART NO.	QTY	DESCRIPTION
44	523278	2	SEAT SPRING
45	523283	1	HOUR METER
46	582048	1	PARK LEVER w/ GRIP
47	583302	1	FUEL VALVE - DSL
48	583077	1	SEAT LT. GREY W/TRACK
49	583089	1	SEAT CUSHION
50	583090	1	BACK CUSHION
51A	583242	1	ARM REST PAD - LH
51B	583243	1	ARM REST PAD - RH
52	583183	2	FUEL TANK ADAPTER
55	583224	1	SEAT STOP
56	583401	1	BATTERY MOUNT
57	583415	2	DAMPENER
58	583438	2	ADJUSTMENT PLATE
60	592002	1	CONTROL HANDLE - RH
60	592004	1	CONTROL HANDLE - LH
61	592008	1	SEAT FRAME WELDMENT
62	592010	1	SEAT PLATE WELDMENT
63	592012	1	RH REAR TANK MT.
64	592014	1	LH REAR TANK MT.
65	592016	1	FRONT TANK MOUNT – RH
66	592018	1	FRONT TANK MOUNT – LH
67	592020	1	CONTROL PANEL
68	592060	2	HANDLE MOUNT WELDMNT-LH
69A	592024	2	CONTROL PIVOT RIGHT
69B	592026	1	CONTROL PIVOT LEFT
70	593001	1	FUEL TANK/FENDER - LH
71	593002	1	FUEL TANK/FENDER - RH
72	593008	2	1-1/2" GROMMET
73	593010	2	HANDLE MOUNT BAR
74A	593022	2	RH CONTROL MOUNT
74B	593024	1	LH CONTROL MOUNT
75	593026	2	RH CONTROL COVER
76	593028	2	LH CONTROL COVER
77	593032	1	RH CONTROL LINK
78	593034	1	LH CONTROL LINK
79	593048	1	SWITCH MOUNT – NEUTRAL
80	593058	2	NEUTRAL INDICATOR
81	593067	1	RH TANK PANEL
82	593068	1	LH TANK PANEL
84	823127	2	NEUTRAL LINK
85	823132	1	PARK BRAKE LINK

# 61" Mid-Cut Seatframe Assembly - Diesel

#	PART NO.	QTY	DESCRIPTION
87	823194	1	ALARM
86	583463	2	DEISEL CAP - LARGE
88	823221	4	BALL STUD
89	583480	1	FUEL LINE - ILS ( 1/4 X 13" )
90	583435	1	FUEL LINE - RETURN DSL ( 1/4 X 66" )
91	583184	2	FUEL LINE - ENG ( 1/4 X 58" )
92	523045	1	FUEL LINE - ( 5/16 X 15" )
93	583186	2	FUEL LINE - ( 1/4 X 29" )
94	603032	2	FUEL LINE - ( 1/4 X 24" )

**NOTES:**

# 61" MID-CUT SMALL HYDRO PUMP ASSEMBLY

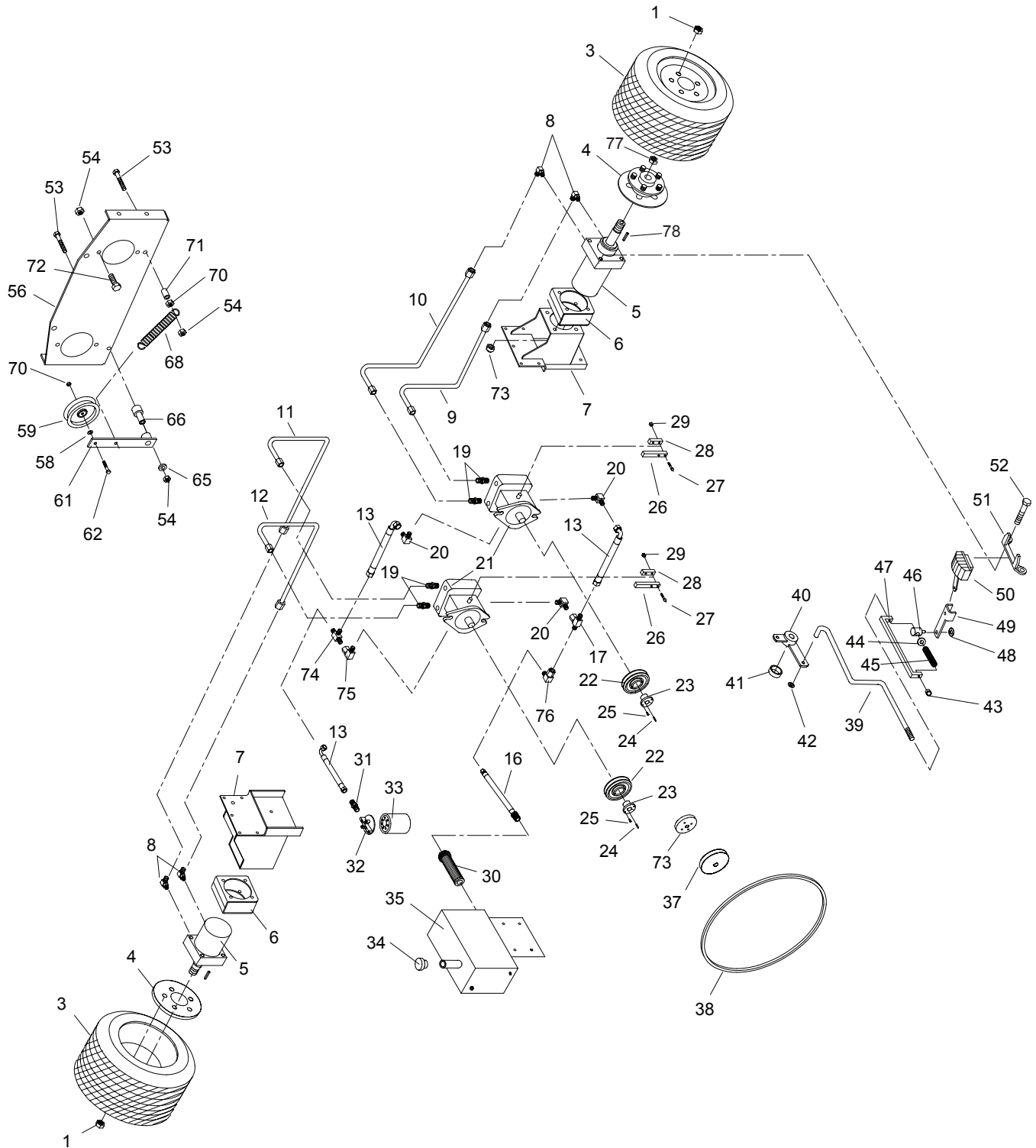

# 61" Mid-Cut

## Small Hydro Pump Assembly - Diesel

#	PART NO.	QTY	DESCRIPTION
1	103023	10	LUG NUT
3	583055	2	DRIVE WHEEL ( COMPLETE )
3A	583059	X	DRIVE TIRE ( 24 X 12 X 12 )
3B	583487	X	BAR LUG TIRE ( 23 X 10.5 X 12 )
3C	583058	X	RIM W/ VALVESTEM
4	582008	2	WHEEL HUB
5	583325	2	WHEEL MOTOR - MP14
5A	583520	X	SEAL KIT - MP14
6	582031	2	MOTOR SPACER
7A	582002	1	RIGHT HAND MOTOR MOUNT
7B	582004	1	LEFT HAND MOTOR MOUNT
8	523058	4	90 DEGREE MOTOR ADAPTER
9	583397	1	RIGHT HAND OUTSIDE LINE
10	583396	1	RIGHT HAND INSIDE LINE
11	583398	1	LEFT HAND INSIDE LINE
12	583399	1	LEFT HAND OUTSIDE LINE
13	583241	2	PUMP TO PUMP HOSE
16	453129	1	PUMP TO TANK SUPPLY HOSE
17	453106	1	SWIVEL TEE
19	583126	4	STRAIGHT ADAPTER
20	453074	3	90 DEGREE ADAPTER
21	583491	2	PUMP- 10A W / RELIEF
21A	583514	X	PUMP SEAL KIT - 10L
22	583382	2	PUMP PULLEY
23	423178	2	15 MM TAPER HUB
24	453102	2	PUMP KEY
25	100252	2	1/4"-20 X 3/4" HEX BOLT
26	823104	2	CONTROL BAR
27	100257	4	1/4"-20 X 1 3/4" HEX BOLT
28	453090	2	CLAMP BAR
29	104255	6	1/4"-20 NYLOC NUT
30	583132	1	SUCTION SCREEN
31	583442	1	FILTER ADAPTER
32	423064	1	FILTER HEAD
33	423063	1	HYDRO OIL FILTER
34	423165	1	OIL BREATHER CAP
35	583049	1	OIL TANK
36	423065	1	OIL EYE
37	583200	1	PUMP PULLEY
38	583385	1	PUMP BELT SML PUMP
39A	583042	1	RIGHT HAND BRAKE ROD
39B	583044	1	LEFT HAND BRAKE ROD

# 61" Mid-Cut

## Small Hydro Pump Assembly - Diesel

#	PART NO.	QTY	DESCRIPTION
40	422049	1	BRAKE CRANK
41	373086	1	BLADE SPACER
42	104256	6	5/16" PUSH NUT
43	593116	2	BRAKE SPRING NUT
44	105257	2	5/16" SAE FLAT WASHER
45	523024	2	DECK DR. SPRING
46	423130	2	PARK BRAKE SWIVEL
47	593114	2	PARK BRAKE STRAP
48	363177	2	3/8" PUSH NUT
49	583190	2	BRAKE ARM
50A	583038	1	RIGHT HAND BRAKE CALIPER
50B	583039	1	LEFT HAND BRAKE CALIPER
50C	583511	X	BRAKE PAD KIT
51	583040	2	CALIPER MOUNT
52	100339	8	1/2"-13 X 6" HEX BOLT
53	100300	2	3/8"-16 X 3" HEX BOLT
54	104257	32	3/8" NYLOC NUT
56	583328	1	PUMP PLATE -MCBDP10
58	105260	13	3/8" FLAT WASHER
59	823351	1	PUMP DRIVE IDLER
61	422025	1	TENSIONER W/BUSHING
X	523111	X	BUSHING ( SERVICE )
62	100294	2	3/8"-16 X 1 1/2" HHCS
65	373089	2	RETAINING WASHER
66	423175	1	IDLER PIVOT
68	583144	1	PUMP IDLER SPRING
70	109007	2	3/8"-16 WHIZLOCK NUT
71	393070	1	IDLER SPACER
72	100293	1	3/8 X 1 1/4 HHCS
73	583274	1	FRONT DRIVE ADAPTER
74	453020	1	CROSS ADAPTER
75	453076	1	90 DEG SWIVEL
76	453109	1	SWIVEL ELBOW
77	583181	2	WHEEL MOTOR SHAFT NUT - TJ
78	107013	2	KEY, 5/16 X 1.0 (1001) WOODRUFF

NOTES:

# 61" MID-CUT ELECTRICAL SECTION

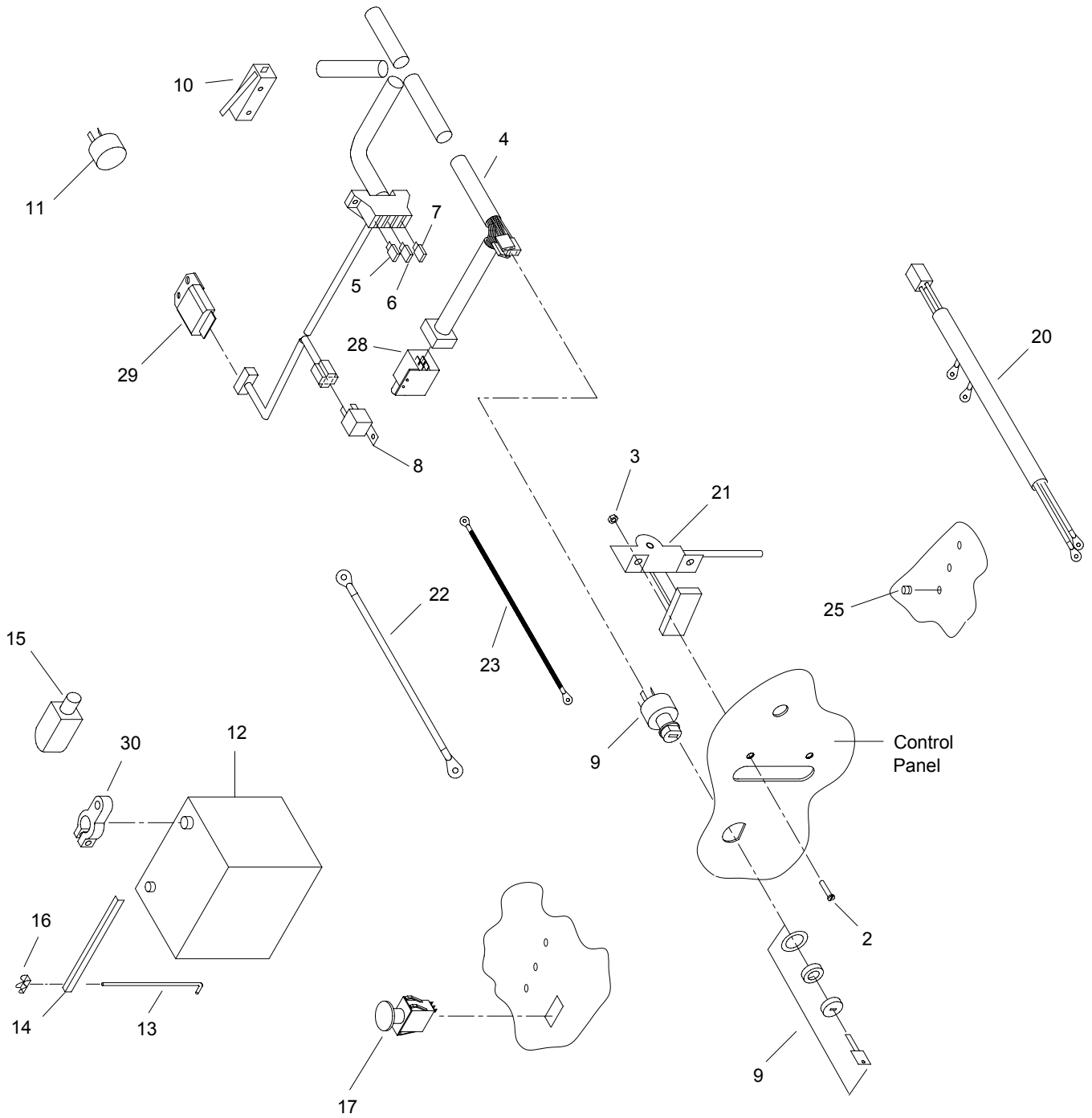

# 61" Mid-Cut

## Electrical Section - Diesel

#	PART NO.	QTY	DESCRIPTION
2	101039	6	#10-24 X 5/8" PAN HEAD BOLT
3	104252	6	#10-24 NYLOC NUT
4	593051	1	WIRE HARNESS - 950D-MC
5	583502	1	30 AMP FUSE
6	523146	1	15 AMP FUSE
7	523147	1	10 AMP FUSE
8	523042	3	RELAY
9	423027	1	IGNITION SWITCH ASSEMBLY
10	593041	1	NEUTRAL SWITCH
11	823194	1	ALARM
12	523050	1	12 VOLT BATTERY
13	423172	2	BATTERY HOLD DOWN
14	583403	1	BATTERY ANGLE - IL3
15	583409	1	POSITIVE BATTERY BOOT
16	109017	2	1/4"-20 WING NUT
17	523031	1	PTO SWITCH
20	583276	1	ENGINE WIRE HARNESS DSL
21	593045	1	THROTTLE CONTROL
22	823196	1	POSITIVE CABLE
23	823197	1	NEGATIVE CABLE
25	523036	5	WARNING LIGHT
28	523034	1	PARK SWITCH
29	583423	1	TIME DELAY MODULE
30	583429	2	BATTERY TERMINAL

**NOTES:**

**PROWLER  
MID-CUT  
WIRE DIAGRAMS  
SECTION**

ENCLOSURE PART #: 593050  
 WIRE HARNESS FOR 52K23A ; 23 HP KAWASAKI  
 WIRE HARNESS FOR 52K25A ; 25 HP KAWASAKI  
 WIRE HARNESS FOR 61K25A ; 25 HP KAWASAKI

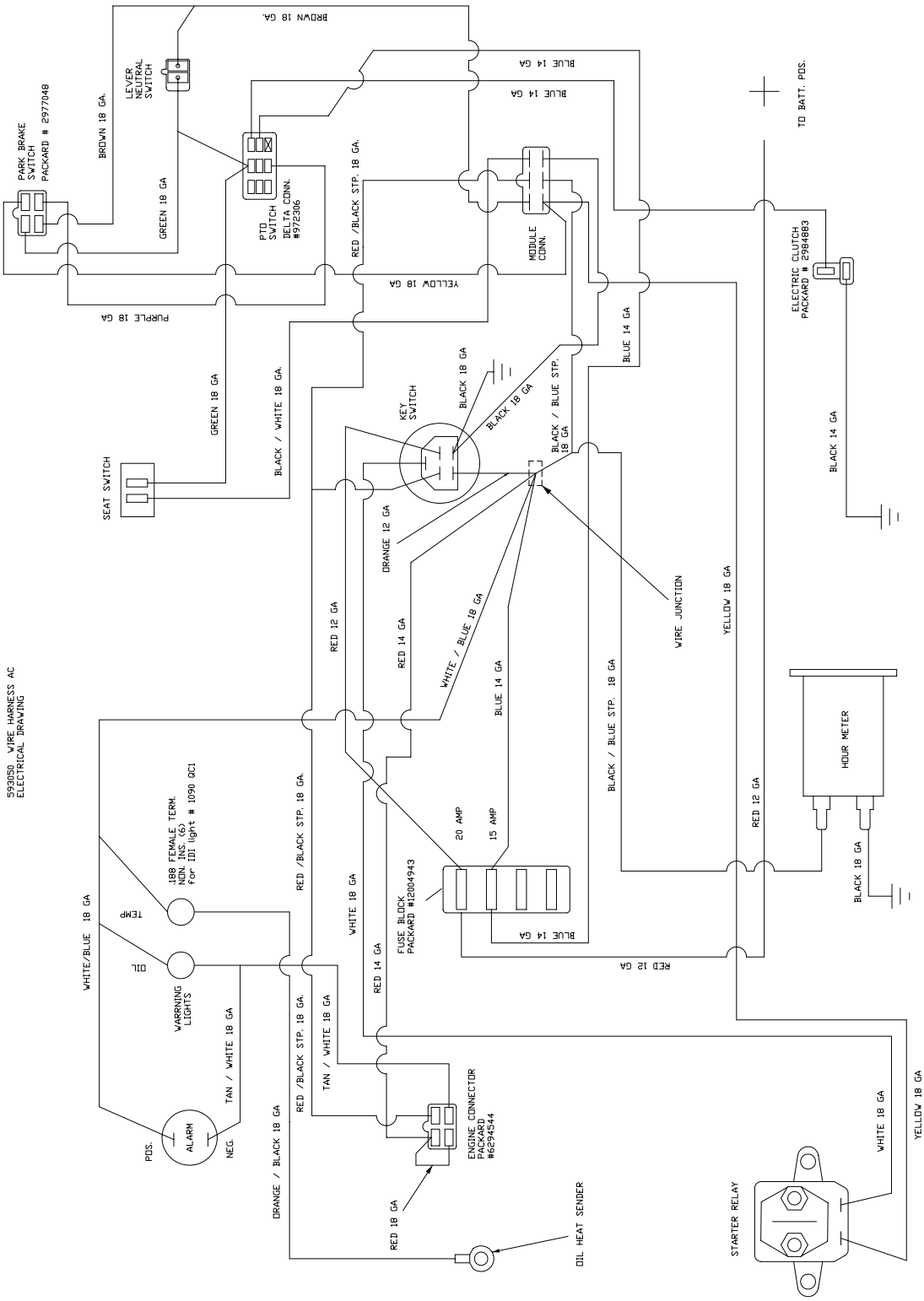

593050 WIRE HARNESS AC  
 ELECTRICAL DRAWING



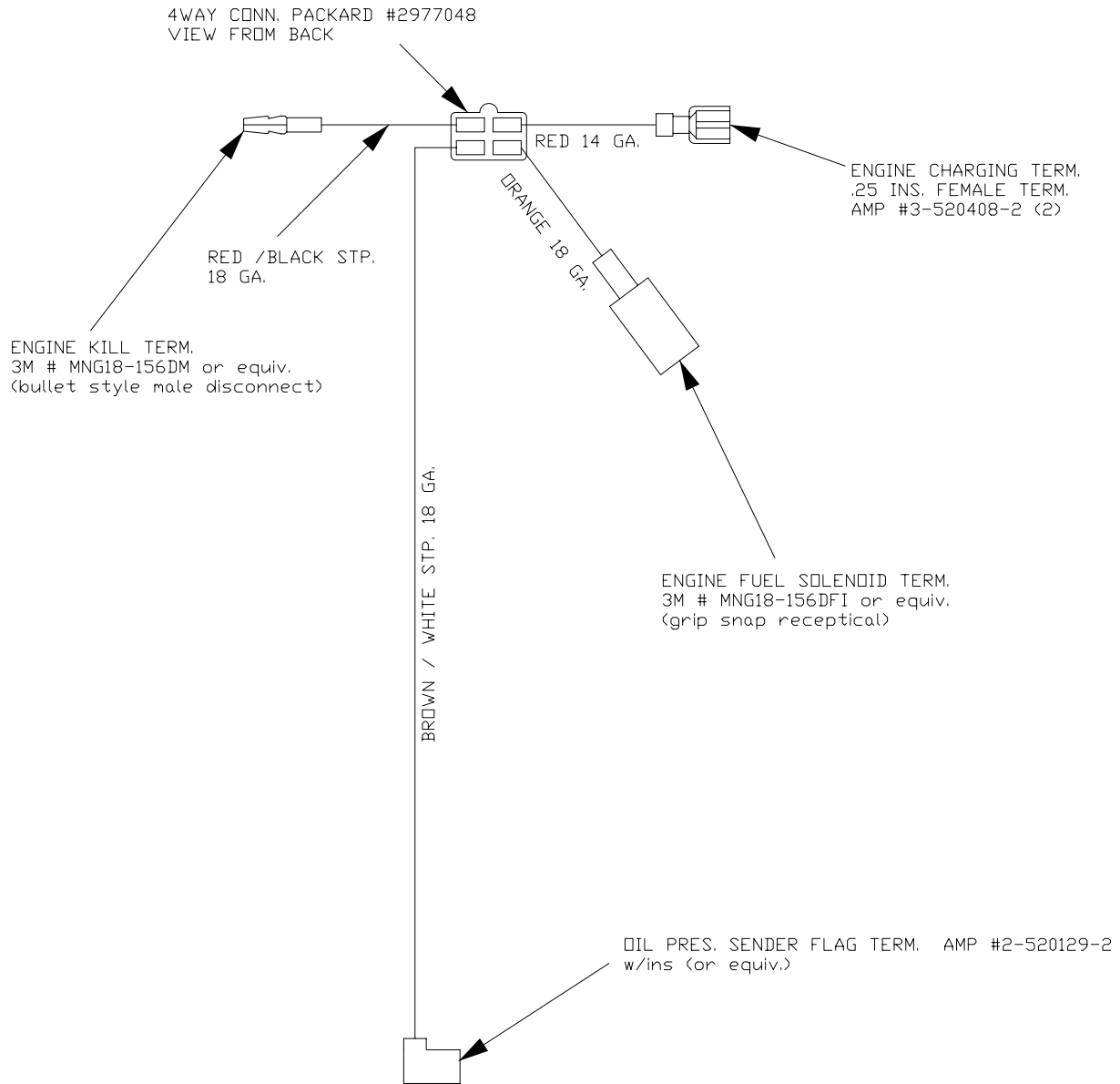

ENCORE PART #: 583495  
 ENGINE WIRE HARNESS FOR 52K23A ; 23 HP KAWASAKI  
 ENGINE WIRE HARNESS FOR 52K25A ; 25 HP KAWASAKI  
 ENGINE WIRE HARNESS FOR 61K25A ; 25 HP KAWASAKI



ALL VIEWS OF CONNECTORS ARE  
FROM WIRE-IN SIDE

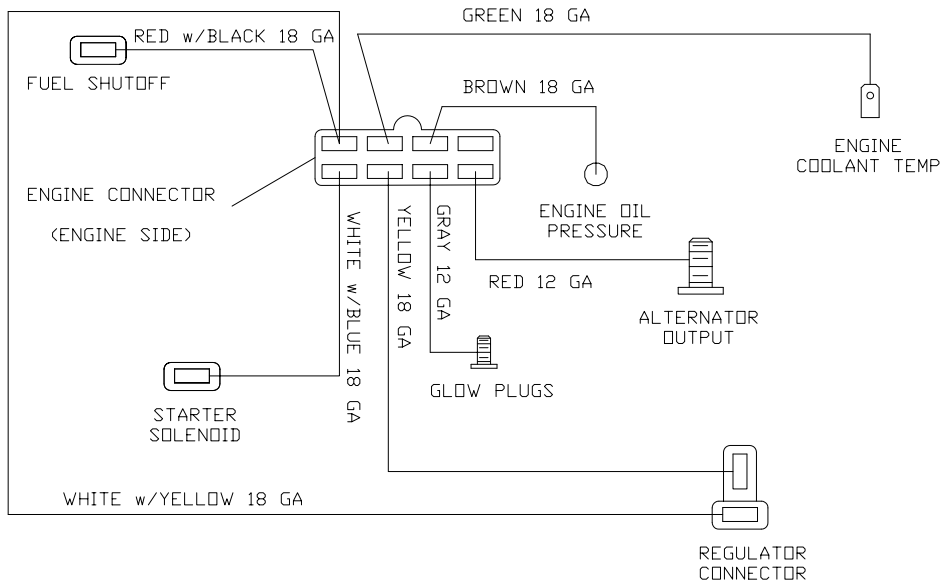

ENCORE PART #: 583276

ENGINE WIRE HARNESS FOR 61B850P ; 26 HP BRIGGS - DIESEL

ENGINE WIRE HARNESS FOR 72B850P ; 26 HP BRIGGS - DIESEL

ENGINE WIRE HARNESS FOR 72B850ZP ; 26 HP BRIGGS - DIESEL

ENGINE WIRE HARNESS FOR B850PFC ; 26 HP BRIGGS - DIESEL

ENGINE WIRE HARNESS FOR 61B27LD ; 27 HP BRIGGS - DIESEL

ENGINE WIRE HARNESS FOR 72B27LD ; 27 HP BRIGGS - DIESEL

# 52" & 61" MID-CUT DECALS



1

## ENCORE

2,3,4



5

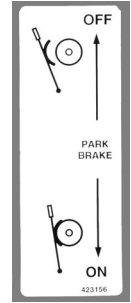

6

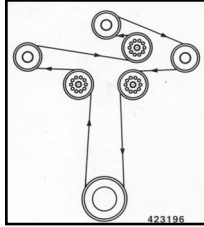

7

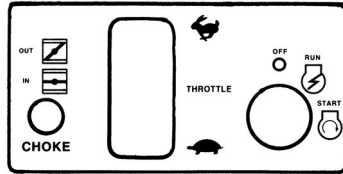

8



9

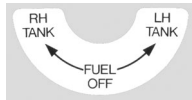

12

## PROWLER

14,21

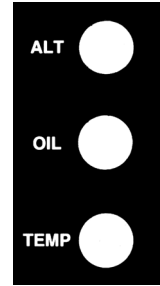

10

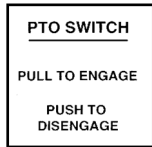

11

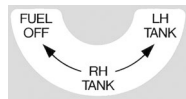

17

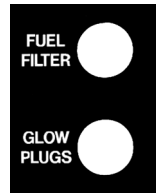

18

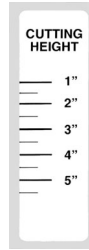

19

## PRO 52 PRO 61

15

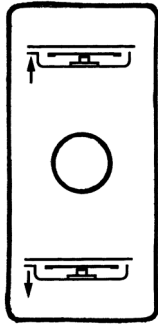

16

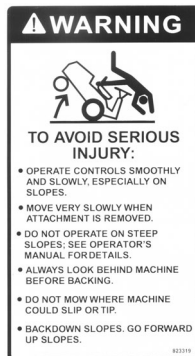

23



24

## DIESEL

20

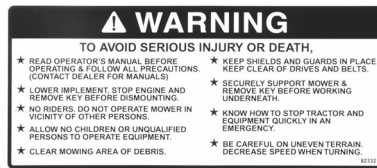

25



26

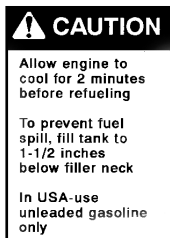

22



28



29



27



30



31

# 52" & 61" Mid-Cut Decal List

#	PART NO.	DESCRIPTION
1	363023	DANGER DECAL
2	363231	LARGE ENCORE LABEL
3	363243	ENCORE DECAL
4	363265	SMALL ENCORE LABEL
5	423155	RIDER CAUTION DECAL
6	423156	PARK LEVER DECAL
7	423196	BELT ROUTING DECAL
8	423197	CONTROL DECAL
9	453010	OIL DECAL
10	523020	LIGHT DECAL
11	523021	PTO DECAL
12	583023	LABEL – FUEL VALVE
13	583076	PROWLER DECAL
14	583088	PROWLER - BLK DECAL
15	523493	PRO-52" DECAL
15	583192	PRO-61" DECAL
16	583232	DECAL – UP- DOWN
17	583280	FUEL VALVE LABEL – DSL
18	583372	GLOW PLUG DECAL
19	583416	CUT GAGE DECAL
20	583441	DIESEL LABEL
21	583443	PROWLER DECAL - RED
22	823318	FUEL TANK DECAL
23	823319	TIP OVER – WARNING
24	823320	BATTERY - WARNING DECAL
25	823321	OPERATING - WARNING
26	823322	ROTATING PARTS – DANGER
27	823323	ROTATING PARTS - WARNING
28	823324	SHIELD - DANGER
29	823325	THROWN OBJECTS - DANGER
30	823326	DISCHARGE - WARNING
31	823327	DISCHARGE - DANGER

**NOTES:**

# Notes:

# Notes:

