

OWNER'S MANUAL

How to operate your EcoWater Systems Water Conditioner/Refiner

ECOWATER
S Y S T E M S®



Your Water. Perfected.

EcoWater Systems
HydroLink® & HydroLink Plus®
Conditioners (ECR)
Refiners (ERR)
Chloramine & Chlorine
Conditioner (ERRC)*
SERIES 3500 & 3502

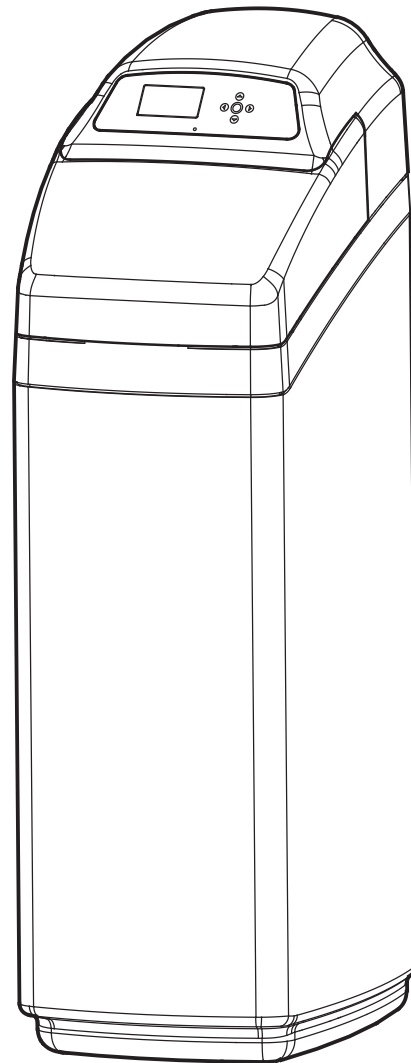

Systems tested and certified by NSF International against NSF/ANSI Standard 44 for hardness reduction and efficiency and the reduction of barium and radium 226/228, and certified to NSF/ANSI Standard 372.

ERR 3500R20, ERR 3502R30 & ERR 3502R50 are tested and certified by NSF International against NSF/ANSI Standard 42 for chlorine taste and odor.



C US

Systems tested and certified by the Water Quality Association against CSA B483.1.

* Model ERRC 3502R50 has not been tested or certified by NSF International or the Water Quality Association.



Designed, Engineered &
Assembled in the U.S.A.

EcoWater Systems LLC
P.O. Box 64420, St. Paul, MN 55164-0420
www.ecowater.com

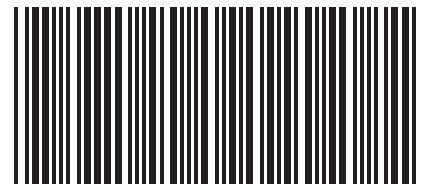

Part No. 7352953 (Rev. D 10/12/16)

TABLE OF CONTENTS

	<u>Page</u>
Warranty	3
Guarantee	4
Planning Installation	5
Unpacking	6
Installation	6-8
Wi-Fi Systems: Setup, Connect & Registration ..	9-12
Non-Wi-Fi Systems: Setup & Remote	13-23
Conditioner/Refiner Operation	23-36
Service Information	37-39
Refilling with Salt	37
Troubleshooting	40-42
Dimensions & Schematic	43
Specifications & Performance Claims	44-45
Repair Parts	46-49

SAFETY GUIDES

Follow the installation instructions carefully. Failure to install the EcoWater Systems conditioner/refiner properly **voids the warranty.**

Before you begin installation, read this entire manual. Then, obtain all the materials and tools you will need to make the installation.

Check local plumbing and electrical codes. The installation must conform to them.

Use only lead-free solder and flux for all sweat-solder connections, as required by state and federal codes.

Use care when handling the EcoWater Systems conditioner/refiner. Do not turn upside down, drop, or set on sharp protrusions.

Do not locate the EcoWater Systems conditioner/refiner where freezing temperatures occur. Do not attempt to treat water over 120°F. **Freezing, or hot water damage voids the warranty.**

Avoid installing in direct sunlight. Excessive sun heat may cause distortion or other damage to non-metallic parts.

The EcoWater Systems conditioner/refiner requires a minimum water flow of 3 gallons per minute at the inlet. **Maximum allowable inlet water pressure is 125 psi.** If daytime pressure is over 80 psi, nighttime pressure may exceed the maximum. Use a pressure reducing valve if necessary (Adding a pressure reducing valve may reduce the flow).

The EcoWater Systems conditioner/refiner works on **24V DC** electrical power, supplied by a direct plug-in power supply (included). Be sure to use the included power supply, and plug it into a nominal **120V, 60 Hz** household outlet that is in a **dry location only**, grounded and properly protected by an over current device such as a circuit breaker or fuse.

This system is not intended to be used for treating water that is microbiologically unsafe or of unknown quality without adequate disinfection before or after the system.

If conditioner/refiner is being used to reduce barium and/or radium 226 and 228, please verify performance by contacting Legend Technical Services, an independent laboratory, at 1-800-949-8220 for testing treated water supply, or check the water testing section of your local phone directory.

NOTE: This equipment has been tested and found to comply with the limits for a Class B digital device, pursuant to Part 15 of the **FCC** Rules. These limits are designed to provide reasonable protection against harmful interference in a residential installation. This equipment generates, uses, and can radiate radio frequency energy and, if not installed and used in accordance with the instructions may cause harmful interference to radio communications. However, there is no guarantee that interference will not occur in a particular installation. If this equipment does cause harmful interference to radio or television reception, which can be determined by turning the equipment off and on, the user is encouraged to try to correct the interference by one or more of the following measures:

- Reorient or relocate the receiving antenna.
- Increase the separation between the equipment and receiver.
- Connect the equipment into an outlet on a circuit different from that to which the receiver is connected.
- Consult the dealer or an experienced radio/TV technician for help.

Changes or modifications not expressly approved by EcoWater Systems could void the user's authority to operate the equipment.

This device complies with **Industry Canada** Standard RSS-210. Operation is subject to the following two conditions: (1) this device may not cause interference, and (2) this device must accept any interference, including interference that may cause undesired operation of the device.

Ce dispositif est conforme avec la norme CNR-210 **d'Industrie Canada**. Le fonctionnement du dispositif est sujet aux deux conditions suivantes: (1) le dispositif ne doit pas causer de brouillage, et (2) le dispositif doit accepter tous brouillages, incluant tous brouillages qui peut nuire au bon fonctionnement du dispositif.



European Directive 2002/96/EC requires all electrical and electronic equipment to be disposed of according to Waste Electrical and Electronic Equipment (WEEE) requirements. This directive or similar laws are in place nationally and can vary from region to region. Please refer to your state and local laws for proper disposal of the equipment.

LIMITED WARRANTY

EcoWater Systems LLC Advantage Warranty Series 3500 & 3502 Water Conditioning System

Congratulations! You have just purchased the highest quality water conditioning product on the market.

To whom is this warranty extended?

EcoWater Systems LLC warrants its products to the original owner and guarantees that the products will be free from defects in materials and workmanship from the original date of installation.

How does my warranty work?

If, during the respective warranty period, a part proves, after inspection by EcoWater, to be defective, EcoWater will, at its sole option repair or replace that part at no charge, other than normal shipping, installation or service charges.

What is covered by the warranty?

EcoWater Systems LLC guarantees that,

for the LIFETIME of the original owner, the SALT TANK and the MINERAL TANK will not rust, corrode, leak, burst, or in any other manner fail to perform their proper functions and that,

for a period of TEN YEARS, the VALVE BODY will be free of defects in materials and workmanship and will perform its proper function and that,

for a period of FIVE YEARS, the ELECTRONIC FACEPLATE and ALL OTHER PARTS, including the HYDROLINK® REMOTE will be free of defects in materials and workmanship and will perform their normal functions.

Only on models designated as ERR on the rating decal, is the media bed guaranteed, for the lifetime of the original owner, to be free of defects in materials and workmanship and to remove chlorine taste and odor from a municipal water supply.

Only on models designated as ERRC on the rating decal, is the media bed guaranteed, for a period of TEN YEARS, to remove chloramines and chlorine taste and odor from a municipal water supply.

How do I obtain warranty service?

Should you need service, your local, independent EcoWater Dealer is only a phone call away.

PHONE: _____

To obtain warranty service, notice must be given, within thirty (30) days of the discovery of the defect, to your local EcoWater Systems dealer.

If I need a part replaced after the factory warranty expires, is the replacement part warranted?

Yes, EcoWater Systems LLC warrants FACTORY REPAIRS as well as all REPLACEMENT PARTS for a period of 90 DAYS. This warranty does not include normal shipping, installation or service charges.

Are any additional warranties available?

We are pleased to say, YES! EcoWater Systems LLC sells an EXTENDED, PARTS ONLY WARRANTY for the ELECTRONICS portion of your product. This warranty is called the "Perfect Ten" and extends the five year warranty on the electronic FACEPLATE, WIRING HARNESS, DRIVE MOTOR, POWER SUPPLY, POWER CORD, SENSOR HOUSING, and MICRO SWITCHES to a total of TEN YEARS from the date of original installation. Your local dealer will provide details regarding this warranty or will refer you to the factory for additional information. In addition, the 3500 SERIES product carries the CREST OF EXCELLENCE GUARANTEE that, should you experience a repetitive problem that remains uncorrected, EcoWater will, during the FIRST YEAR OF INSTALLATION, replace the product with the exact or comparable product.* This guarantee may be subject to normal shipping and installation or service charges.

General Provisions

The above warranties are effective provided the water conditioner/refiner is operated at water pressures not exceeding 125 psi, and at water temperatures not exceeding 120°F (and on a municipal chlorinated water supply - models designated as ERR on the rating decal); provided further that the water conditioner/refiner is not subject to abuse, misuse, alteration, neglect, freezing, accident or negligence; and provided further that the water conditioner/refiner is not damaged as the result of any unusual force of nature such as, but not limited to, flood, hurricane, tornado or earthquake. EcoWater Systems LLC is excused if failure to perform its warranty obligations is the result of strikes, government regulation, materials shortages, or other circumstances beyond its control.

*THERE ARE NO WARRANTIES ON THE WATER CONDITIONER/REFINER BEYOND THOSE SPECIFICALLY DESCRIBED ABOVE. ALL IMPLIED WARRANTIES, INCLUDING ANY IMPLIED WARRANTY OF MERCHANTABILITY OR OF FITNESS FOR A PARTICULAR PURPOSE, ARE DISCLAIMED TO THE EXTENT THEY MIGHT EXTEND BEYOND THE ABOVE PERIODS. THE SOLE OBLIGATION OF ECOWATER SYSTEMS LLC UNDER THESE WARRANTIES IS TO REPLACE OR REPAIR THE COMPONENT OR PART WHICH PROVES TO BE DEFECTIVE WITHIN THE SPECIFIED TIME PERIOD, AND ECOWATER IS NOT LIABLE FOR CONSEQUENTIAL OR INCIDENTAL DAMAGES. NO ECOWATER DEALER, AGENT, REPRESENTATIVE, OR OTHER PERSON IS AUTHORIZED TO EXTEND OR EXPAND THE WARRANTIES EXPRESSLY DESCRIBED ABOVE.

Some states do not allow limitations on how long an implied warranty lasts or exclusions or limitations of incidental or consequential damage, so the limitations and exclusions in this warranty may not apply to you. This warranty gives you specific legal rights, and you may have other rights which vary from state to state. This warranty applies to consumer-owned installations only.

Crest of Excellence

GUARANTEE

for the EcoWater Series 3500 & 3502 Water Conditioning Systems

Satisfied customers are our most valuable asset, and EcoWater has been dedicated to the manufacture of the highest quality water conditioning equipment and to the satisfaction of its customers for over 85 years. When you purchase EcoWater equipment you're buying quality; and that is exactly what we expect you to receive!

The Crest of Excellence Performance Guarantee assures you that satisfying customers is our primary concern, and allows you to feel secure and confident with the quality of your purchase.

If during the first year of installation, the unit does not perform the function for which it was designed, and the repetitive problem remains uncorrected, we will – under the Crest of Excellence Performance Guarantee and at no charge to you – replace the unit with identical equipment or with equipment of comparable features and capabilities.

The Crest of Excellence Performance Guarantee applies to new equipment which is purchased and serviced through Authorized EcoWater Dealers, and is not applicable to equipment which is damaged or destroyed by forces of nature, abuse, neglect or misuse.

It's just that easy! Quality and satisfaction are what you are buying and the Crest of Excellence Performance Guarantee is our promise that you'll get what you pay for!

For future reference, enter the following information:

Model No. _____ **Installation Date** _____

Serial No. (includes date code) _____

Water Hardness _____ **GPG** **Iron Content** _____ **PPM**

Model No. and Serial No. are on the shipping carton and on the conditioner/refiner's rating decal.

TYPICAL INSTALLATION DRAWINGS

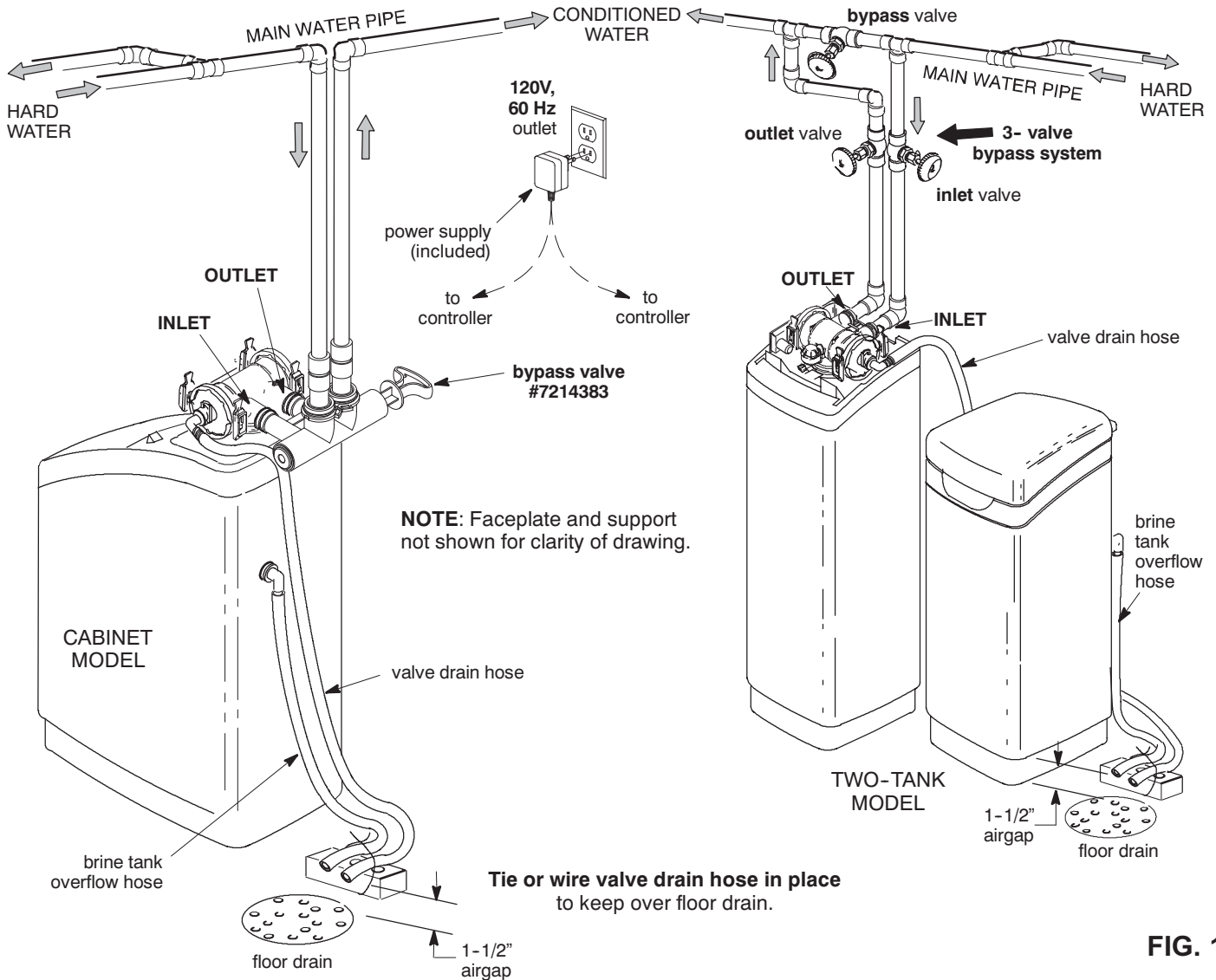

FIG. 1

INLET / OUTLET PLUMBING OPTIONS

- ALWAYS INSTALL either an EcoWater Systems bypass valve #7214383, or a 3-valve bypass system. Bypass valves allow you to turn off water to the conditioner/refiner for repairs if needed, but still have water in house pipes.

OTHER REQUIREMENTS

- A drain is needed for recharge discharge water. A floor drain is preferred, close to the EcoWater Systems conditioner/refiner. A laundry tub, standpipe, etc., are other options (See Figure 1B).
- A 120V, 60 Hz, grounded, continuously "live" electrical outlet is needed, in a dry location near the EcoWater Systems conditioner/refiner.

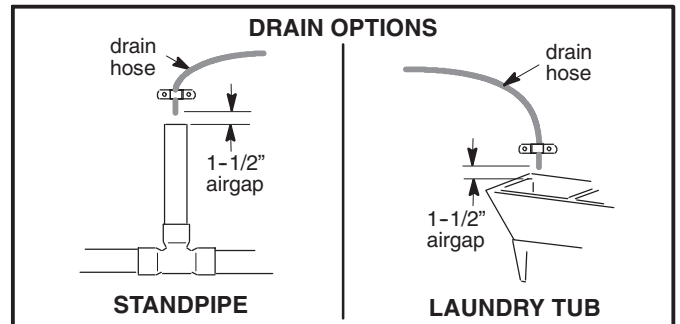

FIG. 1B

NOTE: The Commonwealth of Massachusetts plumbing code 248-CMR shall be adhered to. A licensed plumber shall be used for this installation.

1. UNPACKING

EcoWater Systems conditioner models R70 and R50S are shipped from the factory in two cartons. These contain resin tank/controller assembly in one carton and the brine tank, cover, bag(s) of small parts needed to assemble and install the unit, plus this manual, in the other.

EcoWater Systems conditioner/refiner models R20, R30 and R40 are shipped from the factory in one master carton. The carton also includes a bag of small parts needed to assemble and install the unit, plus this manual.

Thoroughly check the EcoWater Systems conditioner/refiner for possible shipping damage and parts loss. Also inspect and note any damage to the shipping carton. Notify the transportation company if damage is present. EcoWater Systems is not responsible for in-transit damages.

Remove and discard (RECYCLE) all packing materials. We suggest you keep the small parts in the bag(s) until you are ready to use them.

2. BRINE TANK (on two-tank models)

- Locate the brinewell in position. On the brine tank, locate the slots at the bottom of the brinewell, toward the tank wall, as shown in Figure 2. Then use the screw and washer (in parts bag) to fasten the brinewell in place.
- Lower the brine valve into the brinewell. Push the tubing into the brinewell top slot (Fig. 2) and route it out of the brine tank through the smaller hole in the rear wall of the brine tank.
- Install the brinewell cover.
- Take the rubber grommet and hose adaptor elbow from the parts bag. Push grommet into the larger hole in the rear wall of the brine tank. Then insert the larger diameter end of the elbow through the grommet.

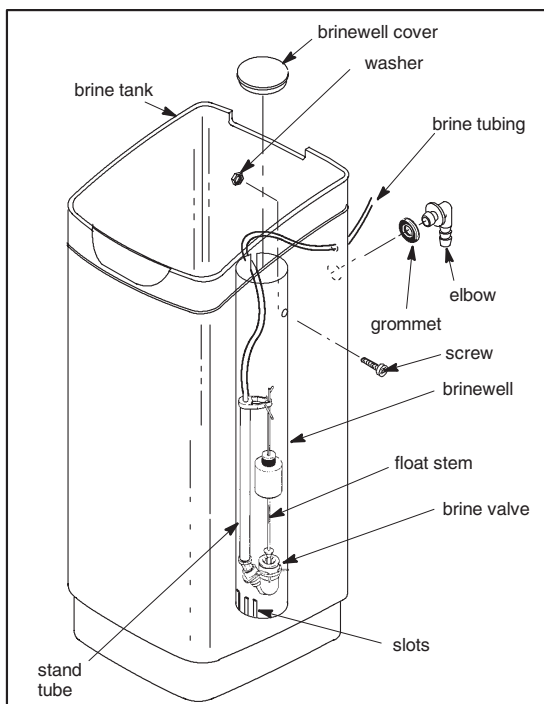

FIG. 2

- Make sure the brine tank cover is properly positioned on the tank.

3. INSTALL BYPASS VALVE and/or COPPER TUBES

- If installing an **EcoWater Systems Bypass Valve**, put lubricated o-ring seals onto both bypass valve ports (See Figure 3B). Carefully slide the bypass valve into the conditioner/refiner valve and install the "C" clips.
- Slide a lubricated o-ring seal onto each of the copper tubes. Carefully insert the copper tubes into the bypass valve (See Figure 3B), or into the conditioner/refiner valve (Figures 3 & 3A). Then install the "C" clips.

NOTE: For lubrication, use silicone grease approved for potable water supplies.

4. TURN OFF WATER SUPPLY

- Close the main water supply valve near the well pump or water meter.
- Shut off the electric or fuel supply to the water heater.
- Open high and low faucets to drain all water from the house pipes.

5. INSTALLING THREE-VALVE BYPASS

If installing a 3-valve bypass system, plumb as needed using Figure 1 as a guide. When installing sweat copper, be sure to use lead-free solder and flux, required by federal and state codes. Use pipe joint compound on outside pipe threads.

6. ASSEMBLE INLET & OUTLET PLUMBING

Measure, cut, and loosely assemble pipe and fittings from the main water pipe (or from the bypass valves installed in Step 5), to the inlet and outlet copper tubes, installed in Step 3b. Be sure **hard water** supply pipe goes to the **valve inlet side**. Trace the water flow direction to be sure.

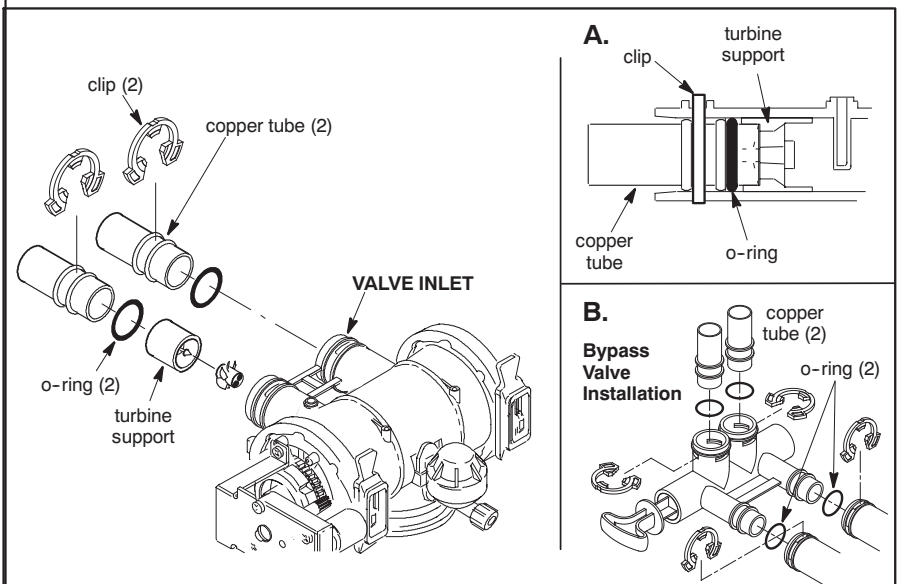

FIG. 3

7. CONNECT INLET & OUTLET PLUMBING

a. SOLDERED COPPER

- (1) Thoroughly clean and flux all joints.
- (2) Pull the plastic "C" clips and remove the inlet and outlet tubes from the valve. Remove o-rings from the tubes. **DO NOT solder with tubes in the valve.** Soldering heat will damage the valve.

NOTE: If installing a ground as shown in Figure 4A, place ground clamps on copper tubes before soldering (See Step 7a).

- (3) Make all solder connections. Be sure to keep fittings fully together, and pipes square and straight.

b. THREADED PIPE

- (1) Apply pipe joint compound to all outside pipe threads.
- (2) Tighten all threaded joints.
- (3) If soldering to the inlet and outlet tubes, observe Step 7a above.

c. CPVC PLASTIC PIPE

- (1) Clean, prime and cement all joints, following the manufacturer's instructions supplied with the plastic pipe and fittings.
- (2) If soldering to the inlet and outlet tubes, observe Step 7a above.

8. COLD WATER PIPE GROUNDING

The house cold water pipe (metal only) is often used as a ground for the house electrical system. The 3-valve bypass type of installation, shown in Figure 1, will maintain ground continuity. If you use the plastic bypass, continuity is broken. To restore the ground, do either step **8a** or **8b** following.

- a. Use the EcoWater ground clamp kit (not included) to make a jumper across the inlet and outlet pipes (See Figure 4A).

- b. Install a #4 copper wire across the removed section of main water pipe, securely clamping at both ends (See Figure 4B) – parts not included.

9. INSTALL VALVE DRAIN HOSE

NOTE: See valve drain options on Page 5.

- a. Elevating the drain hose may cause back pressure that could reduce the brine draw during recharge. If raising the drain line overhead is required to get to the drain point, measure the inlet water pressure to the conditioner/refiner first. For inlet pressures between 20 and 50 psi, do not raise higher than 8 feet above the floor. For inlet pressure above 50 psi, the drain line may be raised to a maximum height of 14 feet.

- b. Connect a length of 1/2" I.D. hose (check codes) to the valve drain elbow, on the controller. Use a hose clamp to hold the hose in place. Route the hose out through the notch in the back of the top cover.

- c. Run the hose to the floor drain, and as typically shown in Figure 1, tie or wire the end to a brick or other heavy object. This will prevent "whipping" during recharges. Be sure to provide a 1-1/2" minimum air gap, to prevent possible sewer water backup.

10. INSTALL BRINE TANK OVERFLOW HOSE

- a. Connect a length of 1/2" I. D. hose to the brine tank overflow elbow and secure in place with a hose clamp.

- b. Run the hose to the floor drain, or other suitable drain point **no higher than the drain fitting** on the tank. If the tank overfills with water, the excess water flows to the drain point.

11. On **Two-tank models**, connect the brine tubing to the nozzle and venturi housing.

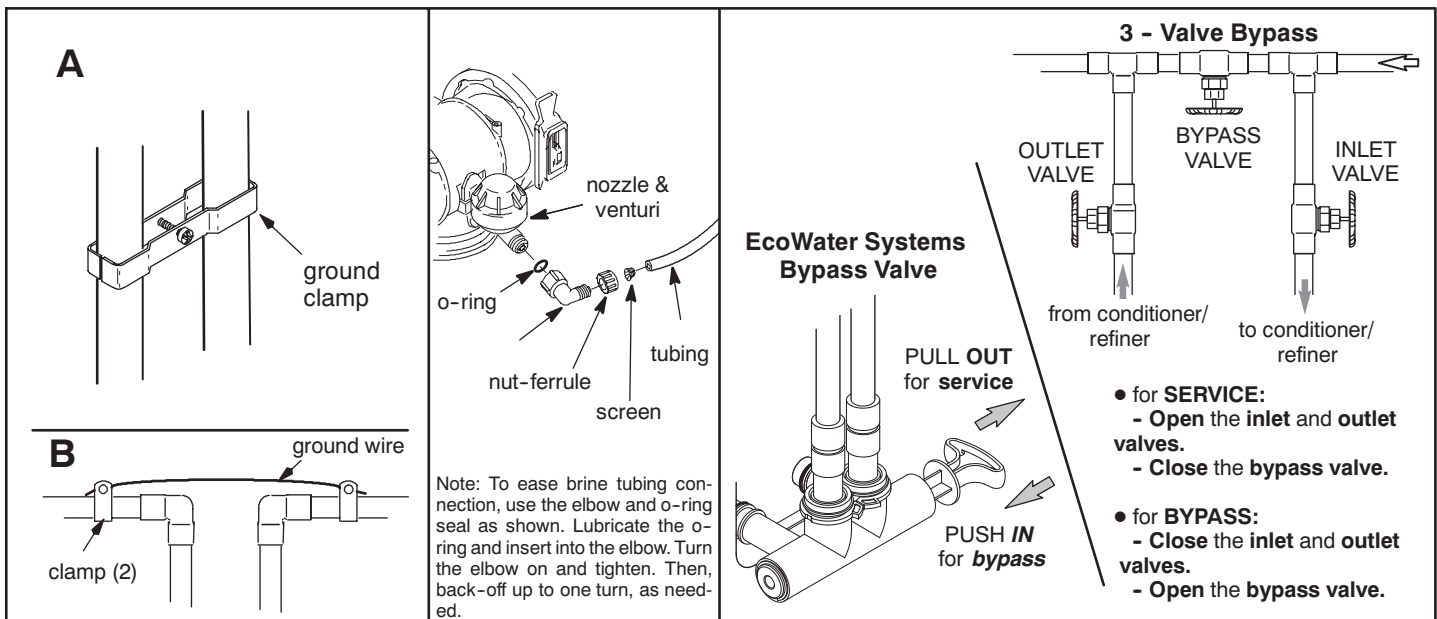

12. PRESSURE TESTING FOR LEAKS, PROGRAMMING THE CONTROLLER & RINSING THE MEDIA

To prevent excessive air pressure in the EcoWater Systems conditioner/refiner and plumbing system, do the following steps **EXACTLY** in order:

- a. Fully open two or more **conditioned** cold water faucets nearby the EcoWater Systems conditioner/refiner.
- b. Place the bypass valve(s) in **bypass** position (See Figure 6).
- c. Fully open the main water supply valve. Watch until the flow from the opened faucets becomes steady, with no spurting or air bubbles.
- d. After about three minutes, open a hot water faucet for one minute, or until all air is expelled.
- e. Close all faucets and check your plumbing work for leaks.
- f. Make sure the conditioner/refiner's valve drain hose is hooked up and the open end directed to a floor drain, laundry tub or other suitable type of drain.
- g. Make sure the conditioner/refiner's bypass valve is in the **bypass** position.
- h. Plug in the power supply.
- i. **Program the electronic controller:** Follow the Setup Procedure on Pages 9-12 for a Wi-Fi system (or Page 13 for a non-Wi-Fi system) to program the electronic controller with basic operating information, such as time and water hardness. After completing the setup procedure, continue with "j. Start a recharge", below.
- j. **Start a recharge:** From the rolling status screens, press the SELECT (○) button to display the **Main menu**. Make sure **Recharge** is highlighted, then press SELECT (○). Press DOWN (▼) to scroll to **Recharge Now**, then press SELECT (○) twice. You should hear the valve motor run as the conditioner/refiner begins recharging. Use the RIGHT (▶) button to advance the valve to the **backwash** position.
- k. Once the unit is in backwash, place bypass valve(s) into the **service** position, as follows:
 - (1) SINGLE BYPASS VALVE: **Slowly** move the valve stem toward **service** position, pausing several times to allow the unit to pressurize slowly.
 - (2) 3-VALVE BYPASS: Fully close the **bypass** valve and open the **outlet** valve. **Slowly** open the **inlet** valve, pausing several times to allow the unit to pressurize slowly.
- l. Let the conditioner/refiner complete the backwash and fast rinse cycles (takes 10-12 minutes). When the recharge cycle ends, the conditioner/refiner valve returns to the service position.

13. ADD WATER AND SALT TO THE BRINE TANK

- a. Using a pail or garden hose, add about 3 gallons of water into the brine tank. **DO NOT** pour into the brinewell.
- b. Add salt to the brine tank. It is recommended to fill the brine tank no more than 1/2 full. Level the salt when finished adding. You can use most water conditioner salts, but it must be clean. Recommended nugget, pellet or coarse solar salts have less than 1% impurities. Salt storage capacity is shown on page 43.

NOTE: See page 37 for additional information on salt.

14. SANITIZING THE ECOWATER SYSTEMS CONDITIONER/REFINER

Care is taken at the factory to keep your EcoWater Systems conditioner/refiner clean and sanitary. However, during shipping, storage, installing and operating, bacteria could get into the unit. For this reason, sanitizing as follows is suggested* when installing.

- a. Remove the brinewell cover and pour about 1-1/2 oz. (2 to 3 tablespoons) of common household bleach into the conditioner/refiner brinewell. Replace the brinewell cover.
- b. Make sure the bypass valve is in the **service** position.
- c. **Start a recharge:** From the rolling status screens, press the SELECT (○) button to display the **Main menu**. Make sure **Recharge** is highlighted, then press SELECT (○). Press DOWN (▼) to scroll to **Recharge Now**, then press SELECT (○) twice. You should hear the valve motor run as the conditioner/refiner begins recharging. This recharge draws the sanitizing bleach into and through the conditioner/refiner. Any air remaining in the unit is purged to the drain.
- d. After the recharge has completed, fully open a cold water faucet, downstream from the conditioner/refiner, and allow 50 gallons of water to pass through the system. This should take at least 20 minutes. Close the faucet.

15. RESTART THE WATER HEATER

Turn on the electric or fuel supply to the water heater, and light the pilot, if applies.

NOTE: The water heater is filled with hard water and, as hot water is used, it refills with conditioned water. In a few days, the hot water will be fully conditioned. To have fully conditioned hot water immediately, wait until the recharge (Step 14) is complete, then drain the water heater until water runs cold.

16. NON-WI-FI SYSTEMS ONLY: REMOTE

If your system includes a remote, see Pages 13-23 for setup procedure, remote unpacking, connecting and operating instructions.

*Recommended by the Water Quality Association. On some water supplies, the EcoWater Systems unit may need periodic disinfecting.

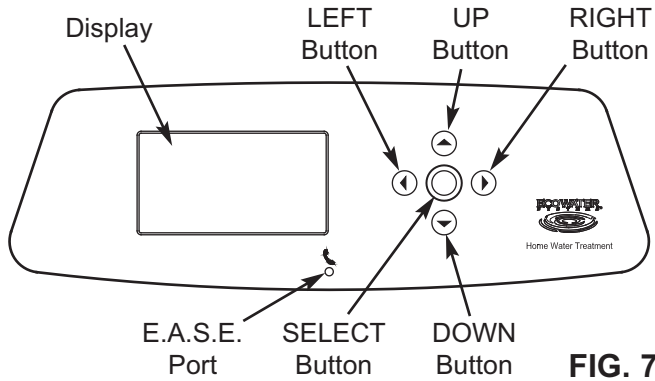

FIG. 7

SETUP PROCEDURE

When the EcoWater Systems conditioner/refiner is plugged in for the first time, a beep sounds and the display briefly shows a logo, followed by model information. Next, a series of “wizard” screens prompts you to enter basic operating information:

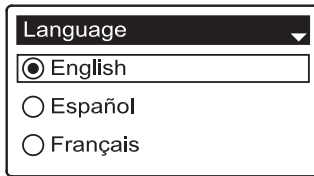

FIG. 8

- 1. LANGUAGE** If the desired language already has a black dot next to it (See Figure 8), go to Step 2. Otherwise, press the conditioner/refiner’s DOWN (▼) or UP (▲) buttons to scroll to the desired language, then press the SELECT (○) button to choose it.
- Press the SELECT (○) button to advance to the next “wizard” screen.

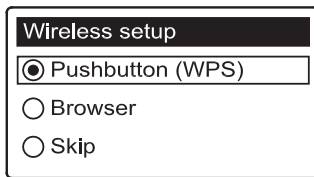

FIG. 9

NOTE: Wireless Setup can also be done after the rest of the Setup Procedure (Steps 16-28) has been completed. From the **Main menu**, go down to the **Advanced settings** menu and select **Wireless setup**.

- 3. WIRELESS SETUP** Choose how you will connect the softener to your home’s wireless network:
Browser: You can connect using the browser on your laptop, tablet or phone. Skip to Step 7.

OR

Pushbutton: If your wireless router has a **WPS** (Wi-Fi Protected Setup) or **Push to Connect** button, you can use this method to connect. Proceed to Step 4.

Pushbutton (WPS) Option

- Use the SELECT (○) button to choose **Pushbutton (WPS)**. The softener display will change to show “Push wireless router button”.

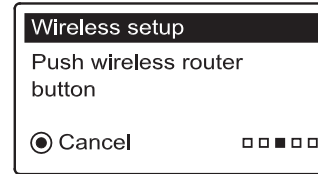

FIG. 10

- Press the WPS or Push to Connect button on your router and wait for a minute or two to see if the display changes again to “Connected” and gives you a key code. If not, you may need to cancel and use the browser option.

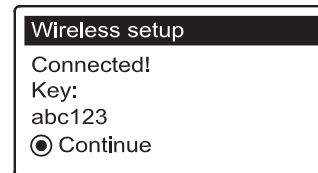

FIG. 11

- Once the key code is displayed, write it down. It will be used when you register your system on the EcoWater web site. Proceed to Step 16 on the next page.

NOTE: If the “Connected” message shows “-----” (dashes) instead of a key code, it may be that your router is not connected to the internet. Verify that the router’s internet connection works with your laptop or other device.

Browser Option

- Press the conditioner/refiner’s DOWN (▼) button to scroll to **Browser**.

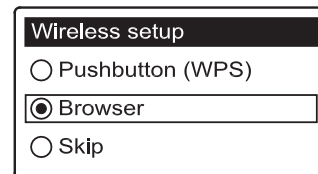

FIG. 12

- Press the SELECT (○) button twice. The softener display will change to show “See connection instructions”.

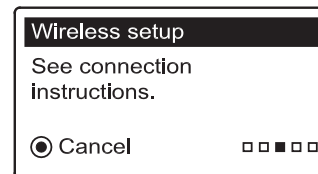

FIG. 13

continued on the next page

continued from the previous page

- On your laptop, tablet or phone, activate the view of wireless networks in range. For example, on a laptop, look for and click on the wireless icon along the lower right edge of the screen. On a phone, you should go into "Settings" and look for "Wi-Fi".



FIG. 14

- You should see a network named "H2O-" followed by 12 characters. Select this network to connect your device with it.

- Once your device indicates that it is connected to the H2O network, go to your internet browser (Chrome, Firefox, Internet Explorer, etc.) and type in this URL:

192.168.0.1

then click Go or press Enter.

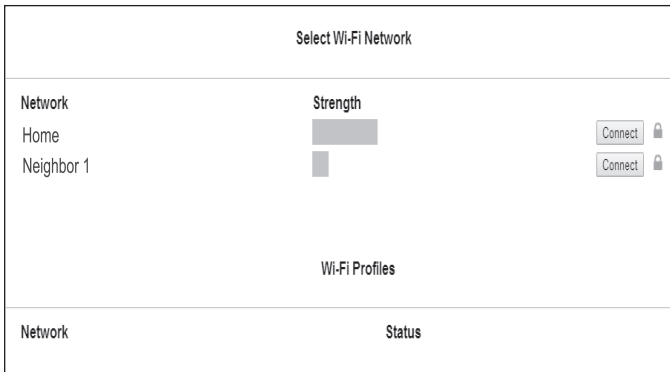

FIG. 15

- After a screen like the one shown above appears, select your in-home wireless network and enter the correct password.
- The softener display should change to "Connected" and give you a key code.

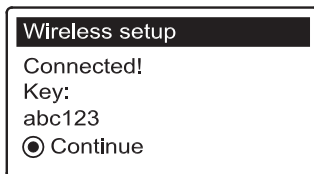

FIG. 16

- Once the key code is displayed (it may take a few seconds), write it down. It will be used when you register your system on the EcoWater web site.

NOTE: If the "Connected" message shows "-----" (dashes) instead of a key code, it may be that your router is not connected to the internet. Verify that the router's internet connection works with your laptop or other device.

- On your laptop, tablet or phone, go back to the view of networks in range, and make sure that your device is connected back to your local network.

Finish Setting up the Softener

- Once you have connected the Wi-Fi system and written down your key code, press the SELECT (O) button to advance to the next "wizard" screen.

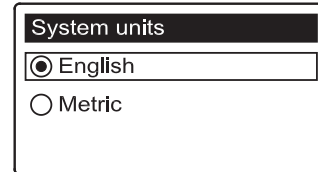

FIG. 17

- SYSTEM UNITS** If the desired system already has a black dot next to it (See Figure 17), go to Step 18. Otherwise, press the DOWN (▼) or UP (▲) buttons to scroll to the desired system, then press the SELECT (O) button to choose it.

- Press the SELECT (O) button.

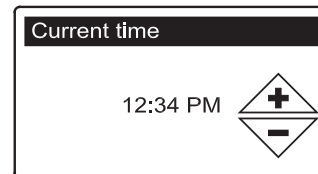

FIG. 18

- CURRENT TIME** Press the DOWN (▼) or UP (▲) buttons to set the current time (See Figure 18). Hold the button down to rapidly advance. Be sure that AM or PM is correct. If the system units were set to metric in Step 17, the clock will be in 24-hour format.

- Press the SELECT (O) button.

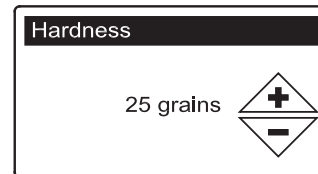

FIG. 19

- HARDNESS** Press the UP (▲) or DOWN (▼) buttons to set the value of your water's hardness (See Figure 19).

NOTE: Do not increase the hardness setting to compensate for iron in your water. The electronic control compensates automatically after you set the iron level in Step 25, below.

22. Press the SELECT (O) button.

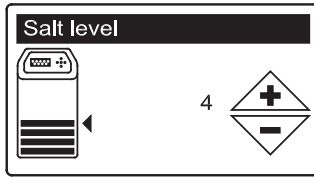

FIG. 20

23. **SALT LEVEL** Press the UP (▲) or DOWN (▼) buttons to set the salt level (See Figure 20). It should match the lowest number visible on the brinewell above the salt.

24. Press the SELECT (O) button.

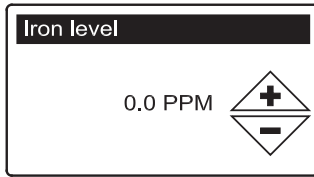

FIG. 21

25. **IRON LEVEL** Press the UP (▲) or DOWN (▼) buttons to set the value for iron in your water (See Figure 21). The conversion factor is 3 grains per 1 ppm of clear water iron.

26. Press the SELECT (O) button. The screen will show “Setup complete!” (See Figure 22).

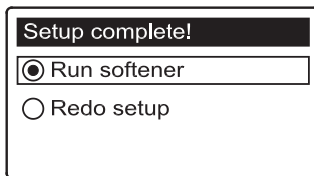

FIG. 22

27. If, at this point, you want to go back and make changes, press the DOWN (▼) button to scroll to **Redo setup**, then press the SELECT (O) button twice to repeat the “wizard” screens.

28. If no changes are desired, make sure **Run softener** has a black dot next to it (See Figure 22) and press the SELECT (O) button. The unit begins normal operation, described on Page 23.

HOW TO REGISTER A SYSTEM ON THE ECOWATER WEB SITE AS A DEALER

NOTE: A dealer registering softeners must log in as a dealer, not as a customer.

29. In your internet browser, type in this URL:

<http://wifi.ecowater.com>

30. If you are a dealer, and have an account, log in to your account and go to the next step. If you are a customer, go to Page 12 for instructions to create an account and register.

31. After you’ve logged in to your dealer account, click “Add New Customer System” and then enter the key code that you wrote down earlier. If you wait too long between writing down the key code and registering (an hour or less), the code may change. This is a security feature. Look up the new key code, as described in the following note.

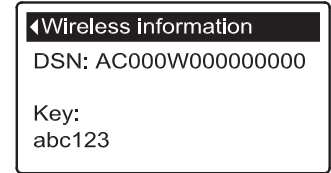
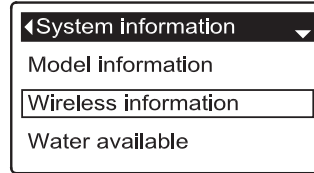

FIG. 23

NOTE: You can look up the current key code on your softener’s controller. From the **Main menu**, go down to the **System information** menu and select **Wireless information**.

32. After you’ve entered the key code in the **Add System** screen, click the “Connect” button to advance to the **Customer Information** screen.

33. Fill in the customer information (address, e-mail, etc.). When entering a password, either have the customer enter their own, or enter one for them and give it to them. If you intend to share the system, sharing needs to be done from the customer’s account (See “How to Share a System” on the following page). When finished filling in the customer information screen, click the “Save and Continue” button.

NOTE: When filling in address information, be sure to select the country before attempting to select a state or province.

34. Fill in the **System Settings** screen and click the “Save Settings” button.

35. Fill in the **Dealer Communication Preferences** screen and click the “Save and Continue” button.

36. The message “Customer System Setup Complete” should appear, along with the customer’s account screen. At this point you can make changes or add another system for this customer. When everything is correct, return to the dealer Home page by clicking the “Home” tab along the top of the page.

36. On the dealer Home page, the new system you set up should appear on the systems list.

NOTE: On the dealer Home page, the number of shared systems is displayed below the bar along the top of the screen. You can display only shared systems by clicking “shared with you”, and display all systems again by clicking the “Home” tab. See the following page for instructions on how to share a system.

HOW TO CREATE AN ACCOUNT AND REGISTER YOUR SYSTEM ON THE ECOWATER WEB SITE AS A CUSTOMER

NOTE: A dealer registering softeners must log in as a dealer, not as a customer.

1. In your internet browser, type in this URL:
http://wifi.ecowater.com
2. If you are a new customer, click on “Create Account” to advance to the **Create Your Account** screen.
3. Fill in the account information (e-mail, password, language, etc.). Agree to the Terms of Use, and then click the “Create Account” button to advance to the **Customer Information** screen.
4. Fill in the customer information (name, address, etc.). When finished filling in the customer information screen, click the “Save and Continue” button.

NOTE: When filling in address information, be sure to select the country before attempting to select a state or province.

5. Follow the instructions on the **Verify e-mail** screen. You will shortly receive an e-mail confirming that you have created your account. Open this e-mail and click on the link it contains. Your browser will be directed to a **Verification Complete** screen.
6. Now that you have created your account, you may log in. In the verification screen, click the “logging in” link (or go to **http://wifi.ecowater.com**).
7. Log in with the e-mail and password that you entered when creating your account.
8. After you’ve created and logged in to your account, the **Add System** screen will appear. Enter the key code that you wrote down earlier. If you wait too long between writing down the key code and registering (an hour or less), the code may change. This is a security feature. Look up the new key code, as described in the following note.

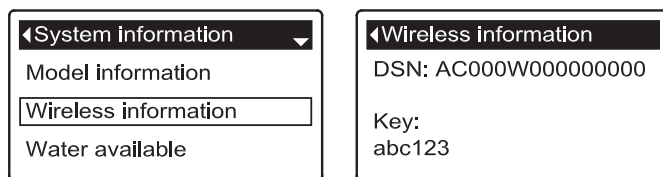

FIG. 24

NOTE: You can look up the current key code on your softener’s controller. From the **Main menu**, go down to the **System information** menu and select **Wireless information**.

9. After you’ve entered the key code in the **Add System** screen, click the “Connect” button to advance to the **System Settings** screen.
10. Fill in the **System Settings** screen and click the “Save Settings” button.
11. Fill in the **Communication Preferences** screen and click the “Save and Continue” button.
12. The screen should change to show the Home page for your system, including the softener “dashboard”. Click the “Log Out” tab when you are done.

VISITING YOUR CUSTOMER ACCOUNT

Any time after your customer account has been created and system registered, you can visit your account to see your softener “dashboard”, change settings, etc. Direct your browser to **http://wifi.ecowater.com** and log in using the e-mail and password that were specified when setting up the account.

HOW TO SHARE A SYSTEM BETWEEN A DEALER AND CUSTOMER

NOTE: A system can only be shared from a customer’s account, not a dealer’s.

Systems can be “shared” between a dealer and customer. If a system is shared, the dealer has full access to the displays and settings for that system on the EcoWater Wi-Fi web site. If a system is not shared, the dealer only has access to the “Dealer Communication Preferences” screen for that system.

Once a customer account has been created by a dealer, a customer can grant a dealer access to their system. Access can only be granted to the dealer who sold that system.

With permission, a dealer (but only the one who sold the system) could also grant it for the customer. To do so, a dealer must log in as a customer rather than as a dealer, using the customer’s e-mail and password (which were entered when the customer account was created).

1. Go to **http://wifi.ecowater.com** and log in (customer’s e-mail and password, not dealer’s).
2. Click on the “Support” tab along the top of the customer Home page.
3. On the **Support** screen, click the “Grant Access” button. It should change to read “Revoke Access”.
4. The system is now shared. Click the “Log Out” tab when you are done.

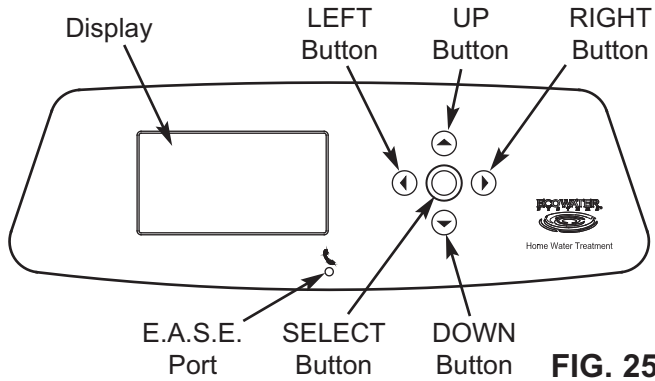

FIG. 25

SETUP PROCEDURE

When the EcoWater Systems conditioner/refiner is plugged in for the first time, a beep sounds and the display briefly shows a logo, followed by model information. Next, a series of “wizard” screens prompts you to enter basic operating information:

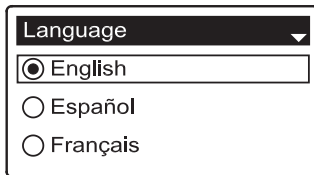

FIG. 26

- 1. LANGUAGE** If the desired language already has a black dot next to it (See Figure 26), go to Step 2. Otherwise, press the conditioner/refiner’s DOWN (▼) or UP (▲) buttons to scroll to the desired language, then press the SELECT (○) button to choose it.
- Press the SELECT (○) button to advance to the next “wizard” screen.

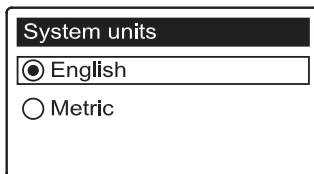

FIG. 27

- 3. SYSTEM UNITS** If the desired system already has a black dot next to it (See Figure 27), go to Step 4. Otherwise, press the DOWN (▼) or UP (▲) buttons to scroll to the desired system, then press the SELECT (○) button to choose it.
- Press the SELECT (○) button.

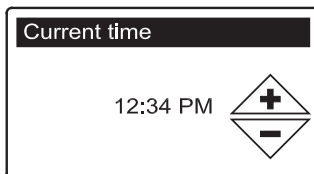

FIG. 28

- 5. CURRENT TIME** Press the DOWN (▼) or UP (▲) buttons to set the current time (See Figure 28). Hold the button down to rapidly advance. Be sure that AM or PM is correct. If the system units were set to metric in Step 3, the clock will be in 24-hour format.

- Press the SELECT (○) button.

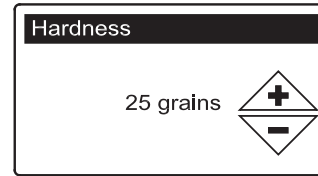

FIG. 29

- 7. HARDNESS** Press the UP (▲) or DOWN (▼) buttons to set the value of your water’s hardness (See Figure 29).

NOTE: Do not increase the hardness setting to compensate for iron in your water. The electronic control compensates automatically after you set the iron level in Step 11, below.

- Press the SELECT (○) button.

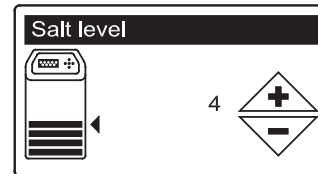

FIG. 30

- 9. SALT LEVEL** Press the UP (▲) or DOWN (▼) buttons to set the salt level (See Figure 30). It should match the lowest number visible on the brinewell above the salt.

- Press the SELECT (○) button.

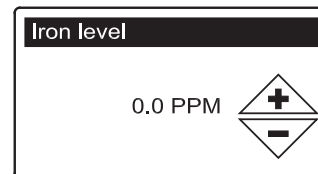

FIG. 31

- 11. IRON LEVEL** Press the UP (▲) or DOWN (▼) buttons to set the value for iron in your water (See Figure 31). The conversion factor is 3 grains per 1 ppm of clear water iron.

- Press the SELECT (○) button. The screen will show “Setup complete!” (See Figure 32).

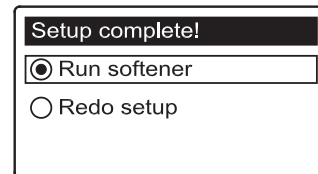

FIG. 32

- If, at this point, you want to go back and make changes, press the DOWN (▼) button to scroll to **Redo setup**, then press the SELECT (○) button twice to repeat the “wizard” screens.
- If no changes are desired, make sure **Run softener** has a black dot next to it (See Figure 32) and press the SELECT (○) button. The unit begins normal operation, described on Page 23.

UNPACKING

The EcoWater Systems HydroLink® remote is shipped from the factory in one carton. Thoroughly check for possible shipping damage and parts loss. Also note any damage to the shipping carton. Notify the transportation company if damage is present. EcoWater Systems is not responsible for in-transit damages. Remove and discard (RECYCLE) all packing materials.

ITEMS INCLUDED WITH SHIPMENT

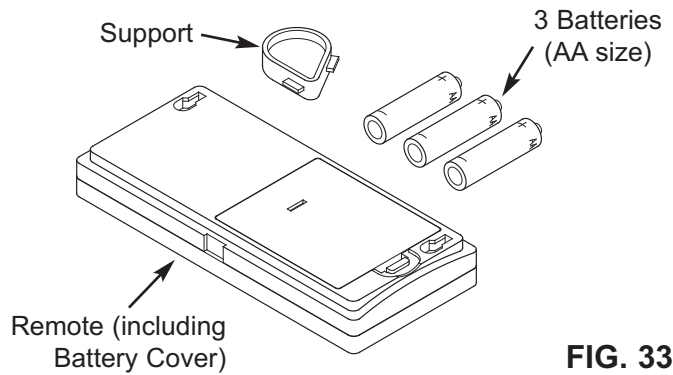

INSTALLING BATTERIES

1. Remove the battery cover from the back of the remote.
2. Install three (3) AA size batteries, making sure that they are oriented to match the + and - markings inside the battery compartment (See Figure 34).
3. Snap the battery cover back in place.

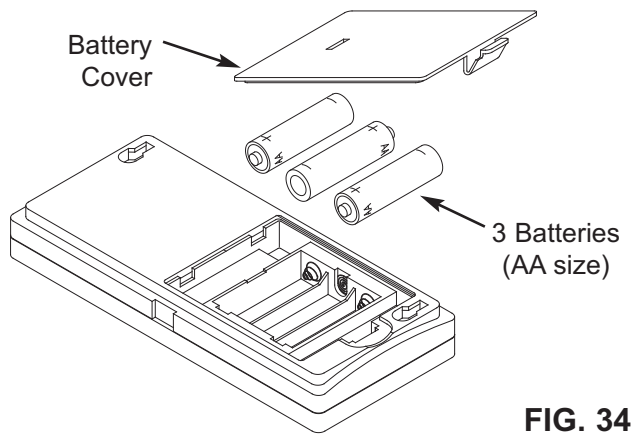

NOTE: When replacing batteries in a remote that was previously connected to a conditioner/refiner, it is not necessary to reconnect the remote and conditioner/refiner.

INSTALLING THE SUPPORT

The EcoWater Systems HydroLink® remote is shipped with a teardrop-shaped support to hold the unit at an angle when placed on a horizontal surface.

1. Snap one of the support's two tabs into the rectangular slot on the back of the remote's case (See Figure 35).

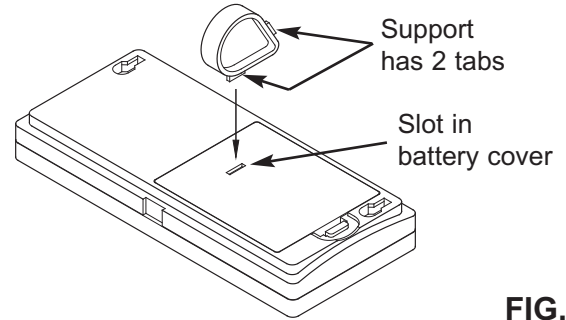

2. The angle may be adjusted by reorienting the support in the battery cover (See Figure 36).

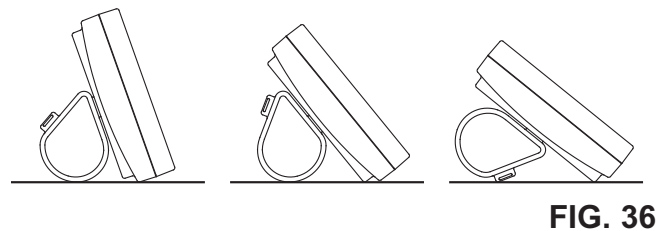

OPTIONAL WALL MOUNTING

The EcoWater Systems HydroLink® remote (without the support) may also be mounted on a wall. If this option is desired, install two fasteners (not included) at a convenient height, spaced 6-1/8" (156 mm) apart (See Figure 37).

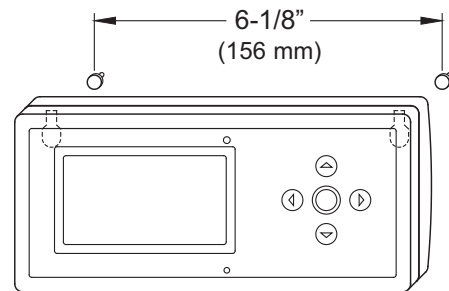

CONNECTING TO REMOTE

When the conditioner/refiner’s electronic control is first powered up, it is not yet in communication with the remote. Do the following to establish a link between the two:

1. This procedure involves pushing buttons on both the conditioner/refiner and remote, so have the remote near the conditioner/refiner for now. Make sure the remote is powered up (See “Installing Batteries” on Page 14).
2. From any of the rolling status screens, press the conditioner/refiner’s SELECT (O) button to display the **Main menu**.
3. Press the conditioner/refiner’s DOWN (▼) button to scroll through the menu options until **Advanced settings** is highlighted (See Figure 38).

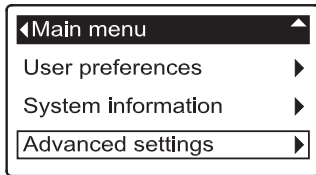

FIG. 38

4. Press the conditioner/refiner’s SELECT (O) button to display the Advanced settings menu (See Figure 39).

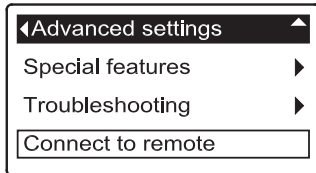

FIG. 39

5. Press the conditioner/refiner’s DOWN (▼) button to scroll through the menu options until **Connect to remote** is highlighted.
6. If the remote does not already show a menu screen, press the remote’s SELECT (O) button to display a **Menu** screen. (See Figure 43 on the next page).
7. Press the remote’s DOWN (▼) button to scroll through the menu options until **Add new device** is highlighted in a box (See Figure 44).
8. Press the remote’s SELECT (O) button, and the “Waiting for new device...” screen appears (See Figure 45). The remote waits two minutes for the conditioner/refiner to be activated (in the next step).
9. Make sure the conditioner/refiner’s display still shows the screen in Figure 39. Press the conditioner/refiner’s SELECT (O) button to display the “Looking for remote” screen (See Figure 40).

continued

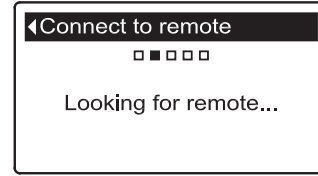

FIG. 40

10. Within a few seconds the screen should change to show “Remote found” (See Figure 41). If, after about one minute, the conditioner/refiner’s screen instead reads “New remote not found,” press the conditioner/refiner’s SELECT (O) button to return to the screen in Figure 39 and press the remote’s LEFT (◀) button to return to the screen in Figure 44. Then repeat this procedure from Step 8. If the remote is not found after several tries, contact your dealer for service. Take note of the message on the remote’s screen after an unsuccessful attempt, as it indicates the nature of the problem.



FIG. 41

11. Press the conditioner/refiner’s SELECT (O) button. The display will go back to the Advanced settings menu (Figure 39).
12. Press the conditioner/refiner’s LEFT (◀) button twice to return to the rolling status screens.

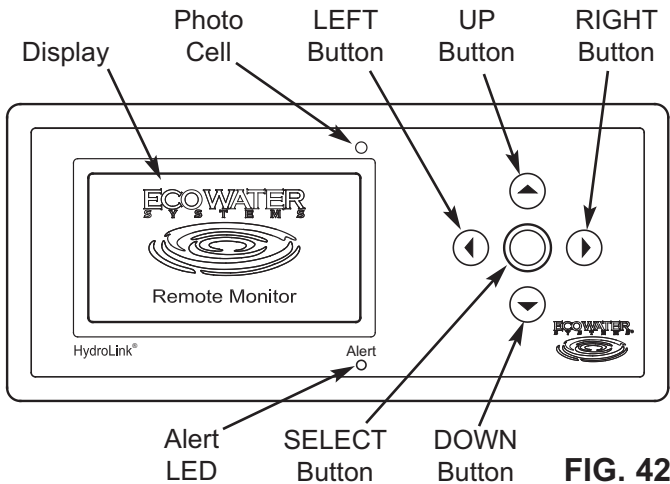

FIG. 42

REMOTE MENUS

Startup Menu

Before any devices have been added to the remote, the following menu is displayed:

- **Display options**
 - **Set language** (See Page 18)
- **Network options**
 - **Add new device** (See Page 16)

Conditioner/Refiner Menu

After the conditioner/refiner has been added, the remote will display a conditioner/refiner status screen as one of the rolling status screens. Pressing the remote's SELECT (O) button when the conditioner/ refiner status screen is displayed shows the following menu:

- **Remote Control**
 - **Recharge** (See Page 19)
 - **Recharge time** (See Page 20)
- **Display options**
 - **Display data** (See Page 20)
 - **Display order** (See Page 21)
 - **Remote control data** (See Page 22)
 - **Rename device** (See Page 22)
 - **Set language** (See Page 18)
- **Network options**
 - **Add new device** (See Page 16)
 - **Delete current device** (See Page 23)
 - **RF signal strength** (See Page 18)

Drinking Water Status Menu

If no drinking water system has been added, the remote will display a drinking water status screen as one of the rolling status screens. Pressing the remote's SELECT (O) button when the drinking water status screen is displayed shows the following menu:

- **Display options**
 - **Drinking water message** (See Page 19)
 - **Set language** (See Page 18)
- **Network options**
 - **Add new device** (See Page 16)

ADDING A DEVICE

To initiate communication between the remote and a device such as a conditioner/refiner, it is necessary to add the device to the remote by doing the following:

1. If no device has been added to the remote, the menu shown in Figure 43 is displayed instead of status screens. In this case, skip to step 2. Otherwise, if status screens are shown, press the remote's SELECT (O) button to display a **Menu** screen (See Figure 43).

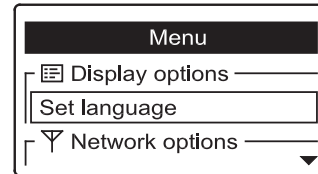

FIG. 43

2. Press the DOWN (▼) button to scroll through the menu options until **Add new device** is highlighted in a box (See Figure 44).

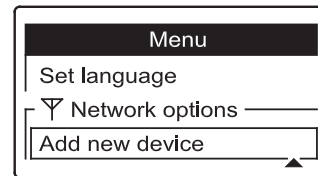

FIG. 44

3. Press the SELECT (O) button, and the screen shown in Figure 45 appears. The remote waits two minutes for the device to be activated (following the instructions in that device's manual). For complete instructions on adding the conditioner/refiner, refer to "Connecting to Remote" on Page 15 of this manual.



FIG. 45

4. When the remote detects a signal from the device, the display will change to show that it has been added to the remote (See Figure 46). If another message appears instead, indicating the device was not added successfully, press the LEFT (◀) button to return to the screen in Figure 44. Repeat Step 3. If this does not work, contact your dealer for service.



FIG. 46

5. To exit this screen, press the LEFT (◀) button or wait 30 seconds for it to exit automatically.

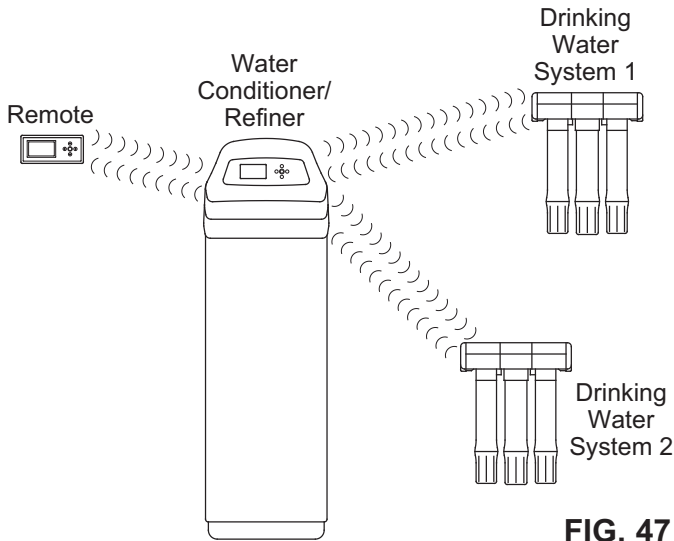

FIG. 47

HYDROLINK® REMOTE

The EcoWater Systems HydroLink® remote is part of a wireless system which monitors multiple water treatment devices in a home. These water treatment devices include water conditioner/refiner(s) and drinking water filter(s) equipped to communicate with this type of system (See Figure 47). The remote displays, in a convenient, central location, useful operating information.

Once devices capable of communicating with the system have been added to the remote (See “Adding a Device” on Page 16), the remote’s normal operating mode displays a sequence of screens showing the status of each device in the system (See Figure 48), and any active alerts, such as “Low salt.”

In addition to monitoring water treatment devices, the remote can also control some water conditioner/refiner operations, such as initiating a manual recharge.

HYDROLINK® COMMUNICATION SYSTEM

The devices in the system exchange information in a loosely coupled network. AC powered devices, such as conditioner/refiners, listen for new data all the time and act as data hubs. Battery powered devices like the remote check for information at regular intervals. Battery powered devices like drinking water systems do not communicate directly with each other or the remote, but pass along information through AC powered devices. Up to 4 devices may be added to one remote, including no more than 3 AC powered devices. An AC powered device with a transmitter must be part of any network (usually a water conditioner/refiner).

It is not necessary for every device in a network to be in radio range of all others. Information one device communicates to any other device will be passed along (like gossip) to all devices in the network.

NAVIGATING THE SCREENS

When the remote is powered up (by installing the batteries), a logo will briefly appear in the display. Once a device has been added, as shown in the procedure on Page 15, the display will automatically cycle between screens showing the status of water treatment devices communicating with the remote. To manually go to the next screen in the sequence, press the LEFT (◀) or RIGHT (▶) buttons.

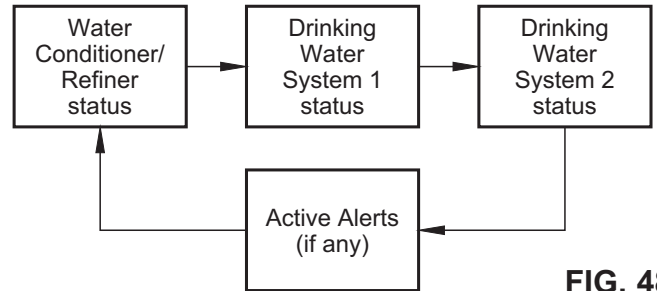

FIG. 48

Some screens have more information than can be shown at one time (for example, the conditioner/refiner status display shown in Figure 49). A down arrow (▼) in the lower right corner indicates that there is more information below. Use the DOWN (▼) button to scroll through the additional lines.

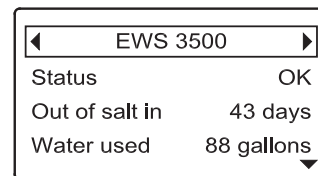

FIG. 49

ACTIVE ALERTS

The status screens described above will not be displayed in a rolling sequence when one of the following active alert messages is displayed:

- **Low salt** (See Page 37)
- **Time lost** (Set the conditioner/refiner’s clock, as described on Page 27)
- **Service overdue** (See Page 35)
- **Error code** (Contact your dealer for service)

MANUALLY REFRESHING THE DATA

If there has been no button activity for 30 seconds, pressing any button will refresh the data being displayed. Normally each data element refreshes at a much slower rate to conserve battery life.

CHECKING RF SIGNAL STRENGTH

During installation of a system, it is useful to check the strength of the signal from a water treatment device. If you check the signal strength of a device communicating with the remote indirectly through another device, the display will show the strength of the “weakest link” in the chain of communication to the remote.

Begin by checking the signal strength between the conditioner/refiner and the remote. If the signal is weak (2 bars or less on the display shown in Figure 52), move the remote to a different location to try improving the signal strength.

When adding additional devices, such as battery-operated drinking water systems (RO), keep in mind that the signal strength display shows the “weakest link” in the chain of communications. If the link between the RO and the conditioner/refiner is weak, move the RO (if possible) to a location closer to the conditioner/refiner or remove metal objects between the two.

To check the signal strength for a particular device:

1. Press the remote’s LEFT (◀) or RIGHT (▶) buttons to manually advance to the status screen for the device you want to check. The device name will show in the header. (See Figure 50).

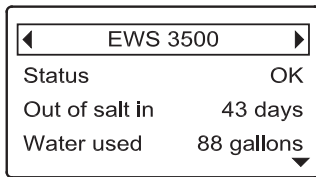

FIG. 50

2. Press the remote’s SELECT (○) button to display the device menu.
3. Press the DOWN (▼) button to scroll through the menu options until **RF signal strength** is highlighted in a box (See Figure 51).

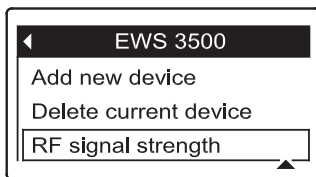

FIG. 51

4. Press the SELECT (○) button, and the screen shown in Figure 52 will appear. The more bars that are filled in black, the stronger the signal. The signal strength display updates every 15 seconds.

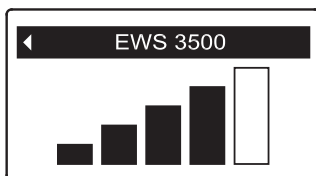

FIG. 52

5. To exit this screen, press the LEFT (◀) button.

SETTING THE LANGUAGE

Language is set independently on the remote and conditioner/refiner (See Page 29 to set the conditioner/refiner’s language). Fewer languages are available on the remote. To change the remote’s language:

1. Press the remote’s SELECT (○) button to display a **Menu** screen.
2. Press the DOWN (▼) button to scroll through the menu options until **Set language** is highlighted in a box (See Figure 53). Press the SELECT (○) button.

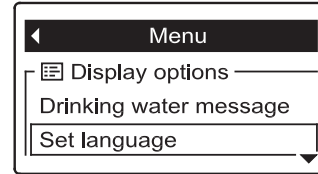

FIG. 53

3. Depending on which devices are added, you could see a message saying “This will delete all devices! Continue?” If so, you would need to add the devices again after changing the language. Press the RIGHT (▶) button to continue (or skip to Step 4 if this message is not displayed).
4. The Set language menu is displayed (See Figure 54). The current language has a black dot next to it.



FIG. 54

5. Press the DOWN (▼) or UP (▲) buttons to scroll through the list to the desired language, then press SELECT (○) to choose it.
6. Press the SELECT (○) button. The display will go back to the menu shown in Figure 53, in the newly set language.
7. To exit this menu, press the LEFT (◀) button or wait 30 seconds for it to exit automatically.

**TO SET THE REMOTE TO ENGLISH
IF ANOTHER LANGUAGE IS DISPLAYED:**

From the rolling status screens, press SELECT (○). Press DOWN (▼) to scroll through the list until the line immediately **above** the antenna (Υ) symbol is highlighted (See Figure 55), then press SELECT (○). Press UP (▲) to scroll to **English** at the top of the list, then press SELECT (○) twice. Press LEFT (◀) to exit the menu.

FIG. 55

DRINKING WATER STATUS MESSAGE

If a communications-capable drinking water filtration (RO) system has been added to the remote, it will have its own status screen displayed during normal operation. Otherwise, a drinking water status screen will display a message like the one shown in Figure 56.

If the message displayed is not appropriate to your system, change it as follows:

1. Press the remote's LEFT (◀) or RIGHT (▶) buttons to manually advance to the **Drinking water status** screen (See Figure 56).

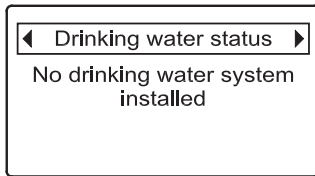

FIG. 56

2. Press the remote's SELECT (○) button to display the drinking water status menu (See Figure 57).
3. If necessary, press the DOWN (▼) button to scroll through the menu options until **Drinking water message** is highlighted in a box (See Figure 57).

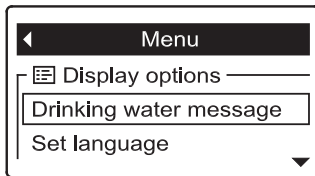

FIG. 57

4. Press the SELECT (○) button to display the Drinking water message menu (See Figure 58).

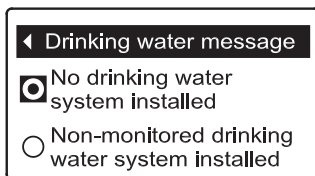

FIG. 58

5. The current message has a black dot next to it. Press the DOWN (▼) or UP (▲) buttons to scroll between the two messages, then press SELECT (○) to choose one.
6. Press the SELECT (○) button. The display will go back to the menu shown in Figure 57.
7. Press the LEFT (◀) button to exit this menu, or wait 30 seconds for it to exit automatically.

* The conditioner/refiner may not respond instantly to the remote's command. Because of the way information is distributed in the HydroLink® network, it may take a few seconds (or even minutes if multiple AC powered devices are in the network).

RECHARGING THE CONDITIONER/REFINER

This feature may be used to assure an adequate supply of conditioned water at times of unusually high water use. For example, if you have guests and the "Capacity remaining" line on the conditioner/refiner status screen is at or below 50%, you could deplete conditioned water capacity before the next automatic recharge. Initiating a manual recharge will restore 100% conditioned water capacity after complete.

1. Press the remote's LEFT (◀) or RIGHT (▶) buttons to manually advance to the **EWS 3500** status screen (See Figure 59).

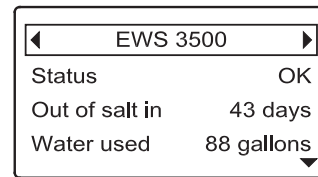

FIG. 59

2. Press the remote's SELECT (○) button to display the device menu (See Figure 60).
3. If necessary, press the DOWN (▼) button to scroll through the menu options until **Recharge** is highlighted in a box (See Figure 60).

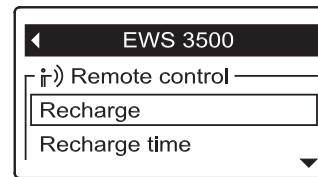

FIG. 60

4. Press the SELECT (○) button to display the Recharge menu (See Figure 61).

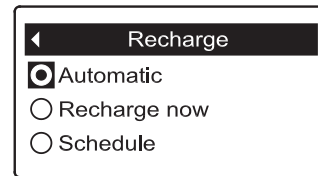

FIG. 61

5. The currently selected option has a black dot next to it. Press the DOWN (▼) or UP (▲) buttons to scroll to the desired option, then press SELECT (○) to choose it.
 - **Automatic** cancels a manually scheduled recharge (if it has not already begun) and lets the electronic control determine when to recharge next.
 - **Recharge now** begins a recharge after the SELECT (○) button is pushed again in Step 6.*
 - **Schedule** sets a recharge to begin at the preset recharge time (set according to the instructions at right).
6. Press the SELECT (○) button. The display will go back to the conditioner/refiner menu (Figure 60).
7. Press the LEFT (◀) button to exit this menu, or wait 30 seconds for it to exit automatically.

SETTING CONDITIONER/REFINER RECHARGE TIME

When the conditioner/refiner’s electronic control is first powered up, the default time for starting an automatic recharge is 2:00 a.m. This is a good time in most households because water is not being used.

To change the conditioner/refiner’s recharge time using the remote:

1. Press the remote’s LEFT (◀) or RIGHT (▶) buttons to manually advance to the **EWS 3500** status screen (See Figure 59).
2. Press the remote’s SELECT (○) button to display the device menu (See Figure 60).
3. Press the DOWN (▼) button to scroll through the menu options until **Recharge time** is highlighted in a box (See Figure 62).

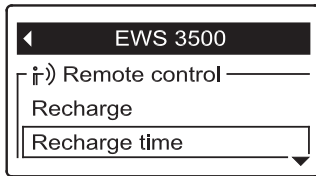

FIG. 62

4. Press the SELECT (○) button to display the Recharge time screen (See Figure 63).

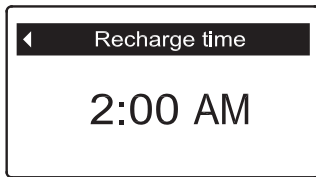

FIG. 63

5. Press the UP (▲) or DOWN (▼) buttons to change the recharge time in 1 hour increments. Hold the button down to rapidly advance. Be sure that AM or PM is correct (unless conditioner/refiner is set for a 24-hour clock).
6. Press the SELECT (○) button. The display will go back to the conditioner/refiner menu (Figure 60).
7. Press the LEFT (◀) button to exit this menu, or wait 30 seconds for it to exit automatically.

CHANGING WHICH DATA ITEMS ARE DISPLAYED IN THE STATUS SCREENS

Each device added to the remote (conditioner/refiner, drinking water system, etc.) has a status screen which the remote displays during normal operation. The status screen may be customized by turning items on or off.

On the remote, the conditioner/refiner’s status screen, for example, will include a **Status** line and may also include any or all of the optional data items in the list below. The frequency with which data is updated on the remote depends on the data item:

<u>DATA ITEM</u>	<u>REMOTE DISPLAY UPDATED EVERY</u>
● Out of salt in (days)	7 hours
● Soft water left (gallons)	10 min.
● Soft water left (liters)	10 min.
● Average daily use (gallons)	7 hours
● Average daily use (liters)	7 hours
● Total minerals removed (lbs)	7 hours
● Total minerals removed (kg)	7 hours
● Capacity remaining (%)	10 min.
● Salt level	10 min.
● Total soft water (gallons)	10 min.
● Total soft water (m ³)	10 min.
● Water used today (gallons)	10 min.
● Water used today (liters)	10 min.

To turn data items on or off:

1. Press the remote’s LEFT (◀) or RIGHT (▶) buttons to manually advance to the status screen you want to customize. For example, to change the data for the conditioner/refiner, manually advance to the **EWS 3500** status screen.
2. Press the remote’s SELECT (○) button to display the device menu.
3. Press the DOWN (▼) button to scroll through the menu options until **Display data** is highlighted in a box (See Figure 64).

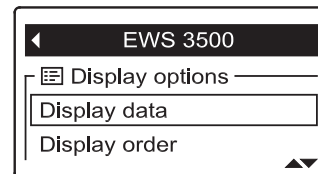

FIG. 64

4. Press the SELECT (○) button to display the Display data screen (See Figure 65).

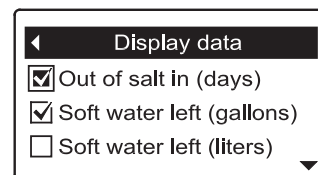

FIG. 65

5. Press the DOWN (▼) or UP (▲) buttons to scroll through the list of display data items. Items with a check mark in the box next to them will be displayed during normal operation.
6. To select an unchecked display data item, make sure the box next to the item's name is highlighted (box is black inside). Then press the SELECT (○) button. The check mark will appear in the box.
7. To un-select a checked display data item, make sure the box next to the item's name is highlighted (box is black inside). Then press the SELECT (○) button. The check mark will disappear.
8. When selections are complete, exit this menu by pressing the LEFT (◀) button. The display will go back to the device menu (Figure 64).
9. Press the LEFT (◀) button to exit this menu, or wait 30 seconds for it to exit automatically.

OUT OF SALT IN (X) DAYS

This display, on both the conditioner/refiner and remote status screens, is an **estimate** of the number of days until the conditioner/refiner will be out of salt. This estimate is based on salt level in the brine tank, salt dose used, and average daily water use. It is recalculated when the conditioner/refiner regenerates, and the number of days may decrease, remain the same or even increase at regeneration time (a drop in water use could cause the estimated days left to increase). Between regenerations it will count down.

PHOTO CELL

To prolong battery life, the remote has a photo cell above the display (See Figure 42). This cell triggers the display to "go to sleep" (turn off) when the ambient light level stays low for 10 minutes. The display will immediately turn back on when the ambient light level is increased.

NOTE: The "Alert" LED (See Figure 42) will not "go to sleep" if ambient light levels are low.

CHANGING THE ORDER OF DATA ITEMS DISPLAYED IN THE STATUS SCREENS

In addition to changing which data items the remote displays during normal operation, the order of these items may be customized, as follows:

1. Press the remote's LEFT (◀) or RIGHT (▶) buttons to manually advance to the status screen you want to customize. For example, to change the order of the conditioner/refiner's screen, manually advance to the **EWS 3500** status screen.
2. Press the remote's SELECT (○) button to display the device menu.
3. Press the DOWN (▼) button to scroll through the menu options until **Display order** is highlighted in a box (See Figure 66).

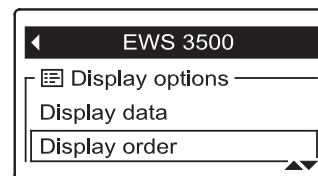

FIG. 66

4. Press the SELECT (○) button to display the Display order screen (See Figure 67).

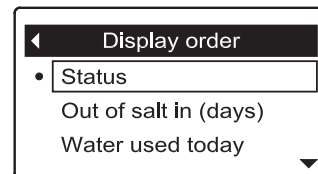

FIG. 67

5. Press the DOWN (▼) or UP (▲) buttons to scroll through the list of display data items. Stop when the item you want to move is highlighted in a box.
6. Press the SELECT (○) button. Arrows will appear next to the item (See Figure 68).

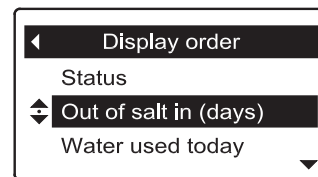

FIG. 68

7. Press the UP (▲) or DOWN (▼) buttons to move the item higher or lower in the list.
8. When the item is where you want it in the list, press the SELECT (○) button. The arrows next to the item will disappear.
9. To move another item, return to Step 5. When finished moving items, press the LEFT (◀) button. The display will go back to the device menu (Figure 66).

CHANGING WHICH DATA ITEMS MAY BE REMOTELY CONTROLLED

Some devices (conditioner/refiners, for example) have a list of data items which may be controlled by the remote. Remote control items may be customized, as follows:

1. Press the remote's LEFT (◀) or RIGHT (▶) buttons to manually advance to the status screen of the device you want to customize. For example, to change the data for the conditioner/refiner, manually advance to the **EWS 3500** status screen.
2. Press the remote's SELECT (○) button to display the device menu.
3. Press the DOWN (▼) button to scroll through the menu options until **Remote control data** is highlighted in a box (See Figure 69).

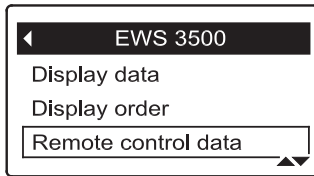

FIG. 69

4. Press the SELECT (○) button to display the Remote control data screen (See Figure 70).

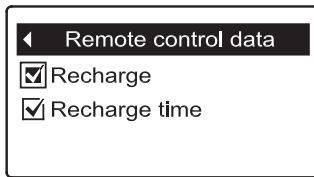

FIG. 70

5. Press the DOWN (▼) or UP (▲) buttons to scroll through the list of remote control items. Items with a check mark in the box next to them will be controllable using the remote.
6. To select an unchecked remote control item, make sure the box next to the item's name is highlighted (box is black inside). Then press the SELECT (○) button. The check mark will appear in the box.
7. To un-select a checked remote control item, make sure the box next to the item's name is highlighted (box is black inside). Then press the SELECT (○) button. The check mark will disappear.
8. When selections are complete, exit this menu by pressing the LEFT (◀) button. The display will go back to the device menu (Figure 69).
9. Press the LEFT (◀) button to exit this menu, or wait 30 seconds for it to exit automatically.

RENAMING A DEVICE

Each device (conditioner/refiner, drinking water system, etc.) in the system has a default name in the header of its status screen. The name may be customized (up to 20 characters long), as follows:

1. Press the remote's LEFT (◀) or RIGHT (▶) buttons to manually advance to the status screen of the device you want to rename. For example, to rename the conditioner/refiner, manually advance to the **EWS 3500** status screen.
2. Press the remote's SELECT (○) button to display the device menu.
3. Press the DOWN (▼) button to scroll through the menu options until **Rename device** is highlighted in a box (See Figure 71).

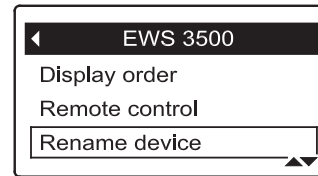

FIG. 71

4. Press the SELECT (○) button to display the Rename device screen (See Figure 72).

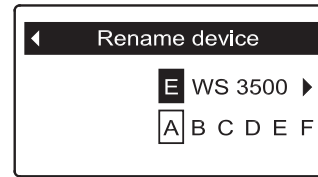

FIG. 72

5. Two lines are displayed below the header. The upper line shows the device name. The lower line is the list of available characters (upper and lower case alphabets, space character, numbers and common punctuation marks). Use the RIGHT (▶) or LEFT (◀) buttons to highlight the first character you want to replace in the old device name.
6. Press DOWN (▼) to switch to the lower line.
7. Press the RIGHT (▶) or LEFT (◀) buttons to scroll through the character list. Stop when the character you want to select is highlighted (See Fig. 73).

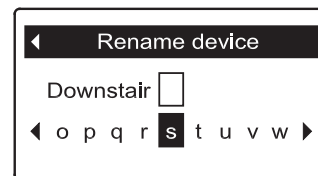

FIG. 73

8. Press the SELECT (○) button. The character you picked is added to the upper line.
9. To select the next character, return to Step 7. When finished entering the device name, press the UP (▲) button to switch to the upper line, then press SELECT (○) to go back to the device menu (Figure 71).

DELETING A DEVICE

To delete a device from the remote (possible reasons for deleting a device include replacing or upgrading the conditioner/refiner's electronic control):

1. Press the remote's LEFT (◀) or RIGHT (▶) buttons to manually advance to the status screen for the device to delete. The device name will show in the header. (See Figure 74).

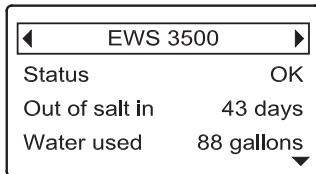

FIG. 74

2. Press the remote's SELECT (O) button to display the device menu (See Figure 75).

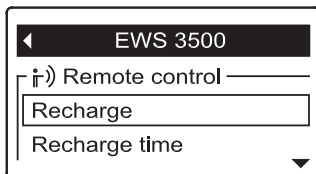

FIG. 75

3. Press the DOWN (▼) button to scroll through the menu options until **Delete current device** is highlighted in a box (See Figure 76).

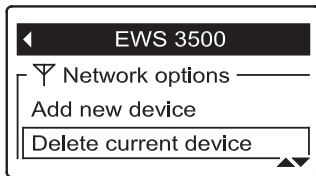

FIG. 76

4. Press the SELECT (O) button. The screen shown in Figure 77 will appear.



FIG. 77

5. Press the RIGHT (▶) button. The screen shown in Figure 78 will appear.

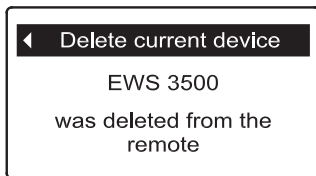

FIG. 78

6. To exit this screen, press the LEFT (◀) button or wait 30 seconds for it to exit automatically.

NORMAL OPERATION

CONDITIONER/REFINER STATUS SCREENS

During normal operation, the EcoWater Systems conditioner/refiner's display shows up to five status screens. Page 29 explains how individual screens can be turned on or off. Each is shown for six seconds, in a rolling sequence (See Figure 79).

The "Wireless status" screen will only be shown on Wi-Fi systems. The check marks indicate the following:

- ✓ **WiFi** - The softener is connected to a Wi-Fi router.
- ✓ **Internet** - The softener is connected to a Wi-Fi router which is connected to the internet.

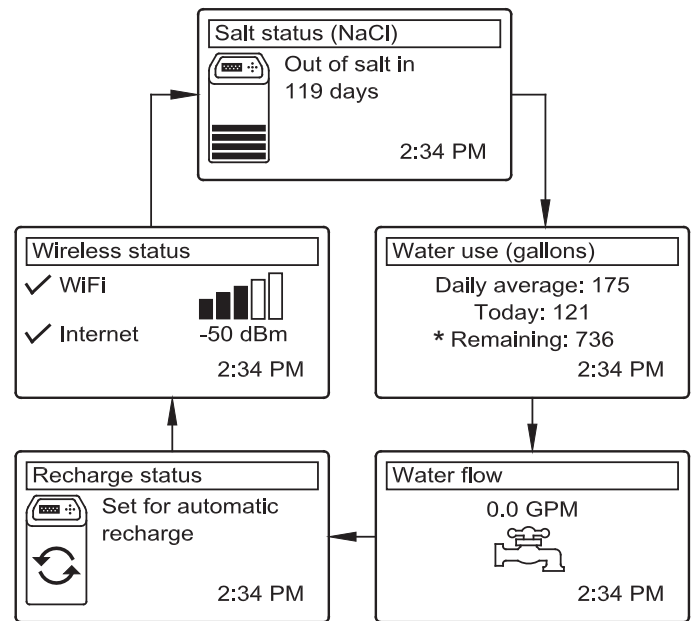

*Water remaining before the next recharge.

FIG. 79

Pressing the conditioner/refiner's RIGHT (▶) button manually advances to the next screen in the sequence. Pressing the LEFT (◀) button manually returns to the previous status screen. If no buttons are pressed for 30 seconds, the automatic rolling sequence resumes.

continued on the next page

MAIN MENU

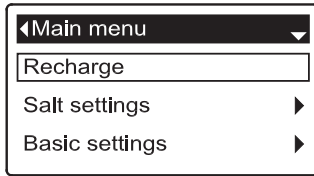

FIG. 80

During normal operation (status screens rolling), press the conditioner/refiner's SELECT (O) button to display the Main menu (See Figure 80). This menu and its subsidiary screens are used to control these operations:

- **Recharge** (See Page 27)
- **Salt settings**
 - **Salt level** (See Page 26)
 - **Low salt alarm** (See Page 26)
 - **Salt type** (See Page 26)
- **Basic settings**
 - **Current time** (See Page 27)
 - **Hardness** (See Page 28)
 - **Iron level** (See Page 28)
 - **Recharge time** (See Page 28)
 - **Rolling screens** (See Page 29)
- **User preferences**
 - **Language** (See Page 29)
 - **Time format** (See Page 30)
 - **Volume units** (See Page 30)
 - **Hardness units** (See Page 30)
 - **Weight units** (See Page 30)
- **System information**
 - **Model information** (See Page 31)
 - **Wireless information** (See Page 31)
 - **Water available** (See Page 31)
 - **Daily avg. water used** (See Page 31)
 - **Water used today** (See Page 31)
 - **Total water used** (See Page 31)
 - **Current water flow** (See Page 31)
 - **Days powered up** (See Page 31)
 - **Last recharge** (See Page 31)
 - **Total recharges** (See Page 31)
- **Advanced settings**
 - **Cycle times**
 - **Backwash time** (See Page 32)
 - **2nd backwash (On/Off)** (See Page 32)
 - **2nd backwash time** (See Page 32)
 - **Fast rinse time** (See Page 32)
 - **Special features**
 - **Efficiency mode** (See Page 33)
 - **Max. days between recharges** (See Page 33)
 - **Auxiliary control** (See Page 34)
 - **Chemical feed volume**** (See Page 34)
 - **Chemical feed timer**** (See Page 34)
 - **97% feature** (See Page 33)
 - **Service reminder** (See Page 35)
 - **Troubleshooting**
 - **Send E.A.S.E. message** (See Page 35)
 - **Diagnostics** (See Page 36)
 - **Setup changes** (See Page 36)
 - **Wireless setup** (See Pages 9-10) on Wi-Fi systems
OR **Connect to remote** (See Page 15)

**Only displayed if Auxiliary control is set to Chemical feed.

OTHER MESSAGES, ALERTS & REMINDERS

The conditioner/refiner status screens described above will not be displayed in a rolling sequence when one of the following items is displayed:

- **Recharge status** (Displayed during recharges, showing valve position and time remaining)
- **Add salt or Out of salt** (See Page 37)
- **Current time** setting screen instead of status screens indicates time has been lost, perhaps after a long power loss. Set the time (See Page 27).
- **Service reminder** (See Page 35)
- **Error detected** (Contact your dealer for service)

FLASHING BACKLIGHT

The conditioner/refiner's display is backlit to make it easy to read. The backlight will flash on and off when one or more of the following conditions occurs:

- Salt needs to be added
- Time needs to be set (Time has been lost)
- Service is overdue (Service reminder)
- Error condition

The flashing will stop after any key is pressed. However, it will start again at Midnight if the underlying condition (e.g. low salt level) has not been addressed.

LONG DISPLAY SCREEN MESSAGES

Most messages in the conditioner/refiner's display screens are short enough to be shown as a single line. Longer messages will be truncated (See Figure 81 for an example) until you highlight them.

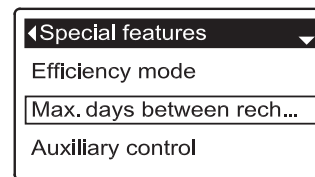

FIG. 81

One second after being highlighted, the viewing box expands (See Figure 82) to show the entire message. After three seconds the view resets (Figure 81).

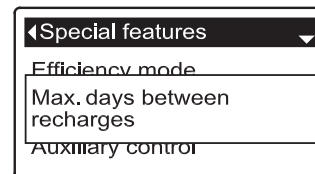

FIG. 82

LOCKOUT FEATURE

A “lockout” feature is available to prevent user modification of parameters that affect conditioner/refiner performance. The unit is shipped from the factory with the lockout feature off. After programming is complete, the lockout feature can be turned on to prevent changes to the following:

- **Hardness**
- **Iron level**
- **Backwash time**
- **Second backwash (On/Off)**
- **Second backwash time**
- **Fast rinse time**
- **Efficiency mode**
- **Max days between recharges**
- **Auxiliary control**
- **Chemical feed volume**
- **Chemical feed timer**
- **97% feature**
- **Service reminder**
- **Setup changes**

To turn on the lockout feature:

1. From any of the rolling status screens, press the SELECT (O) button to display the **Main menu**.
2. Press the DOWN (▼) button to scroll through the menu options until **Advanced settings** is highlighted.
3. Press the SELECT (O) button to display the Advanced settings menu.
4. Press the DOWN (▼) button to scroll through the menu options until **Troubleshooting** is highlighted.
5. Press the SELECT (O) button to display the Troubleshooting menu.
6. Press the DOWN (▼) button to scroll through the menu options until **Setup changes** is highlighted.
7. Press the SELECT (O) button to display the Setup changes menu (See Figure 83).

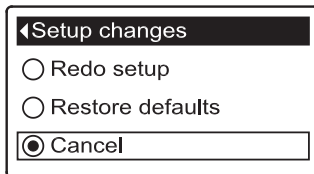

FIG. 83

8. Press the RIGHT (▶) button. A flashing padlock icon will appear, as shown in Figure 84.

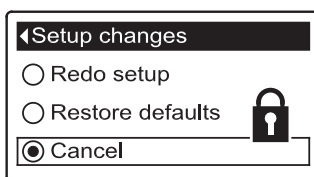

FIG. 84

9. Press the SELECT (O) button.

10. Press the LEFT (◀) button three times to return to the rolling status screens.

When the lockout feature is on, the flashing padlock icon will appear in any screen that would normally be used to change a parameter in the list to the left. For example, the **Hardness** screen will look like Figure 86, instead of Figure 85.

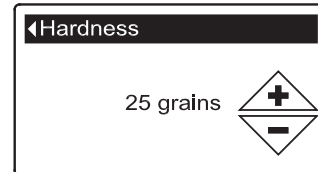

FIG. 85

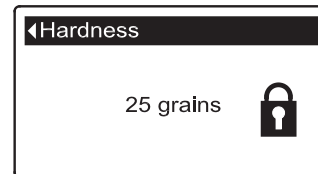

FIG. 86

Another indicator that the lockout feature is on is the **Model Information** screen. This screen appears on power-up, and can also be displayed from the System Information menu (See Page 31). If the lockout feature is on, there will be a non-flashing padlock icon in the upper right corner (See Figure 87).

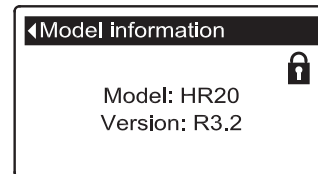

FIG. 87

To turn off the lockout feature:

- 1-7. Go to the **Setup changes** screen (Figure 84) by following Steps 1-7 at left.
8. Press the RIGHT (▶) button. The flashing padlock icon will disappear, as shown in Figure 83.
9. Press the SELECT (O) button.
10. Press the LEFT (◀) button three times to return to the rolling status screens.

SETTING SALT LEVEL

Use this feature when adding salt to the conditioner/ refiner.

Procedure for Cabinet Models

1. When the conditioner/refiner is displaying the rolling status screens, open the salt lid. The tank light turns on and the Salt level screen appears (See Figure 88).

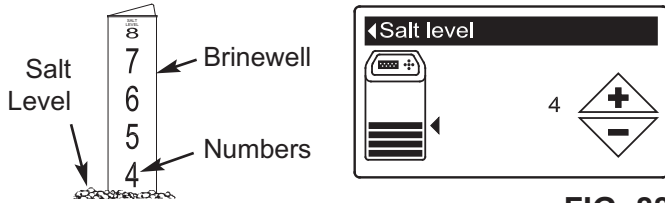

FIG. 88

2. After adding and leveling salt, observe the numbered scale on the brinewell (See Figure 88). Press UP (▲) or DOWN (▼) to match the lowest number visible above the salt.

NOTE: If you will be setting the salt level via the web, instead of pushing buttons on the faceplate, make sure that the salt lid is closed first.

3. Close the salt lid. The tank light turns off and the display goes back to the rolling status screens.

Procedure for Two-tank Models

1. From any of the rolling status screens, press the SELECT (○) button to display the **Main menu**.
2. Press the DOWN (▼) button to scroll through the menu options until **Salt settings** is highlighted (See Figure 89).

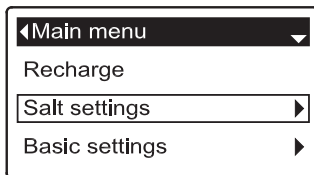

FIG. 89

3. Press the SELECT (○) button to display the Salt settings menu (See Figure 90).

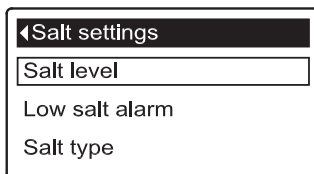

FIG. 90

4. Make sure **Salt level** is highlighted.
5. Press the SELECT (○) button to display the Salt level screen (See Figure 88). This screen will not automatically exit for 15 minutes.
6. After adding and leveling salt, observe the numbered scale on the brinewell (See Figure 88). Press UP (▲) or DOWN (▼) to match the lowest number visible above the salt.
7. Press the SELECT (○) button. The display will go back to the Salt settings menu (Figure 90).
8. Press the LEFT (◀) button twice to return to the rolling status screens. It will also exit automatically if no buttons are pressed for four minutes.

LOW SALT ALARM

Use this feature to program when the electronic control will display a low salt alarm. The number of days can be customized, or the feature can be turned off. The default is 20 days.

- 1-3. Go to the **Salt settings** menu by following Steps 1-3 in “Procedure for Two-tank Models” at left.
4. Press the DOWN (▼) button to scroll through the menu options until **Low salt alarm** is highlighted.
5. Press the SELECT (○) button to display the Low salt alarm screen (See Figure 91).

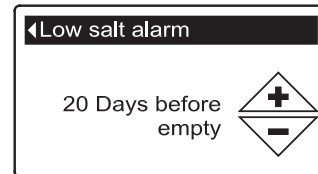

FIG. 91

6. Press the UP (▲) or DOWN (▼) buttons to change the number of days. Set the number of days to provide enough time to purchase salt and avoid running into hard water. Setting the number of days below 1 turns the alarm feature off.
7. Press the SELECT (○) button. The display will go back to the Salt settings menu.
8. Press the LEFT (◀) button twice to return to the rolling status screens.

SETTING SALT TYPE

Use this feature to program the electronic control with which type of salt is used. The default is NaCl. Selecting KCl increases fill time 25% and brine/slow rinse times 12%.

- 1-3. Go to the **Salt settings** menu by following Steps 1-3 in “Procedure for Two-tank Models” at left.
4. Press the DOWN (▼) button to scroll through the menu options until **Salt type** is highlighted.
5. Press the SELECT (○) button to display the Salt type menu (See Figure 92).

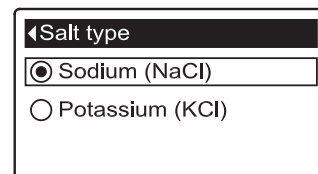

FIG. 92

6. If the desired salt type already has a black dot next to it (See Figure 92), go to Step 7. Otherwise, press the conditioner/refiner’s DOWN (▼) or UP (▲) buttons to scroll to the other salt type, then press SELECT (○) to choose it.
7. Press the SELECT (○) button. The display will go back to the Salt settings menu.
8. Press the LEFT (◀) button twice to return to the rolling status screens.

RECHARGING THE CONDITIONER/REFINER

This feature may be used to assure an adequate supply of conditioned water at times of unusually high water use. For example, if you have guests and the “Water available” screen (See Page 31) is at or below 50%, you could deplete conditioned water capacity before the next automatic recharge. Initiating a manual recharge will restore 100% conditioned water capacity after complete.

1. From any of the rolling status screens, press the SELECT (O) button to display the **Main menu**.

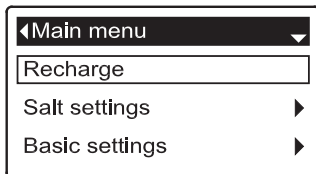

FIG. 93

2. Make sure **Recharge** is highlighted (See Figure 93).
3. Press the SELECT (O) button to display the Recharge menu (See Figure 94).

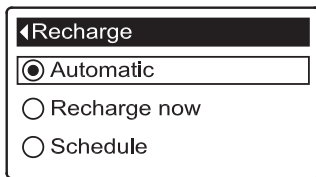

FIG. 94

4. If the desired option already has a black dot next to it (See Figure 94), go to Step 5. Otherwise, press the DOWN (▼) or UP (▲) buttons to scroll to the desired option, then press SELECT (O) to choose it.

- **Automatic** cancels a manually scheduled recharge (if it has not already begun) and lets the electronic control determine when to recharge next.

- **Recharge now** begins a recharge immediately after the SELECT (O) button is pushed again in Step 5.

- **Schedule** sets a recharge to begin at the preset recharge time (set according to the instructions on Page 28).

5. Press the SELECT (O) button. If **Recharge now** is selected, the display immediately goes to the Recharge status screen (See Figure 95). If **Automatic** or **Schedule** are selected, the display goes back to the Main menu (Figure 93).

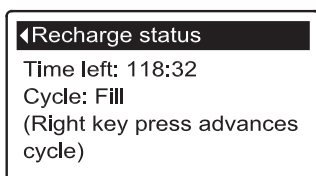

FIG. 95

6. Press the LEFT (◀) button (twice from the Recharge status screen) to return to the rolling status screens.

SETTING THE CURRENT TIME

When the conditioner/refiner’s electronic control is first powered up, a “wizard” screen prompts you to set the current time (See Page 10 or 13). To change the time at a later date, such as after a long power loss:

1. From any of the rolling status screens, press the SELECT (O) button to display the **Main menu**.
2. Press the DOWN (▼) button to scroll through the menu options until **Basic settings** is highlighted (See Figure 96).

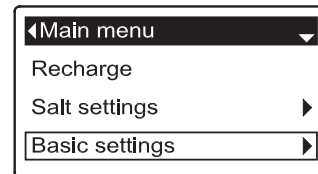

FIG. 96

3. Press the SELECT (O) button to display the Basic settings menu (See Figure 97).

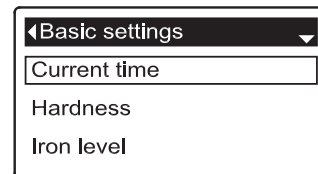

FIG. 97

4. Make sure **Current time** is highlighted.
5. Press the SELECT (O) button to display the Current time screen (See Figure 98).

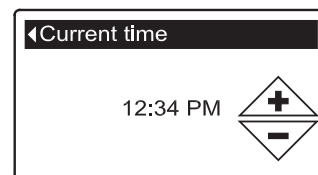

FIG. 98

6. Press the UP (▲) or DOWN (▼) buttons to change the time. Hold the button down to rapidly advance. Be sure that AM or PM is correct (unless conditioner/refiner is set for a 24-hour clock).
7. Press the SELECT (O) button. The display will go back to the Basic settings menu (Figure 97).
8. Press the LEFT (◀) button twice to return to the rolling status screens.

SETTING RECHARGE TIME

When the conditioner/refiner's electronic control is first powered up, the default time for starting an automatic recharge is 2:00 a.m. This is a good time in most households because water is not being used. To change this time:

1. From any of the rolling status screens, press the SELECT (O) button to display the **Main menu**.
2. Press the DOWN (▼) button to scroll through the menu options until **Basic settings** is highlighted (See Figure 99).

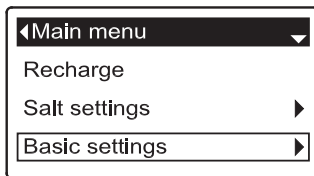

FIG. 99

3. Press the SELECT (O) button to display the Basic settings menu (See Figure 100).

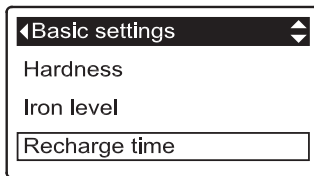

FIG. 100

4. Press the DOWN (▼) button to scroll through the menu options until **Recharge time** is highlighted.
5. Press the SELECT (O) button to display the Recharge time screen (See Figure 101).

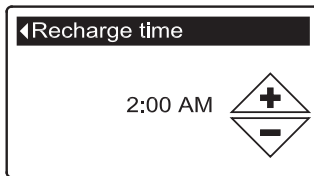

FIG. 101

6. Press the UP (▲) or DOWN (▼) buttons to change the recharge time in 1 hour increments. Hold the button down to rapidly advance. Be sure that AM or PM is correct (unless conditioner/refiner is set for a 24-hour clock).
7. Press the SELECT (O) button. The display will go back to the Basic settings menu (Figure 100).
8. Press the LEFT (◀) button twice to return to the rolling status screens.

SETTING HARDNESS

When the conditioner/refiner's electronic control is first powered up, a "wizard" screen prompts you to enter your water's hardness (See Page 10 or 13). To change it:

- 1-3. Go to the **Basic settings** menu by following Steps 1-3 in "Setting Recharge Time" at left.
4. Press the DOWN (▼) button to scroll through the menu options until **Hardness** is highlighted.
5. Press the SELECT (O) button to display the Hardness screen (See Figure 102).

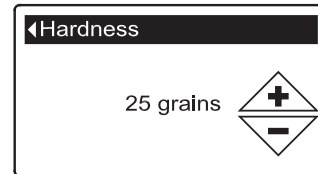

FIG. 102

6. Press the UP (▲) or DOWN (▼) buttons to set the value for your water's hardness. Hold the button down to rapidly advance.

NOTE: Do not increase the hardness setting to compensate for iron in your water. The electronic control compensates automatically after you set the iron level, below.

7. Press the SELECT (O) button. The display will go back to the Basic settings menu.
8. Press the LEFT (◀) button twice to return to the rolling status screens.

SETTING IRON LEVEL

When the conditioner/refiner's electronic control is first powered up, a "wizard" screen prompts you to enter your water's iron level (See Page 11 or 13). The conversion is 3 grains per ppm of clear water iron. To change:

- 1-3. Go to the **Basic settings** menu by following Steps 1-3 in "Setting Recharge Time" at left.
4. Press the DOWN (▼) button to scroll through the menu options until **Iron level** is highlighted.
5. Press the SELECT (O) button to display the Iron level screen (See Figure 103).

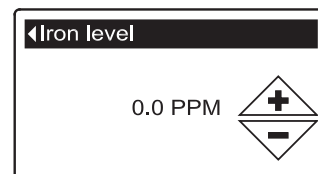

FIG. 103

6. Press the UP (▲) or DOWN (▼) buttons to set the value for iron in your water. Hold the button down to rapidly advance.
7. Press the SELECT (O) button. The display will go back to the Basic settings menu.
8. Press the LEFT (◀) button twice to return to the rolling status screens.

MODIFYING ROLLING SCREENS

During normal conditioner/refiner operation, up to five status screens are shown in sequence (See “Conditioner/ Refiner Status Screens” on Page 23). When the conditioner/refiner’s electronic control is first powered up, the default is to show all four. You can turn on/off individual screens*:

1. From any of the rolling status screens, press the SELECT (O) button to display the **Main menu**.
2. Press the DOWN (▼) button to scroll through the menu options until **Basic settings** is highlighted (See Figure 104).

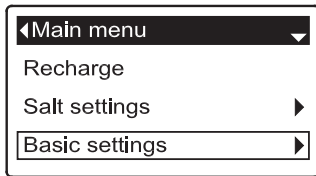

FIG. 104

3. Press the SELECT (O) button to display the Basic settings menu (See Figure 105).

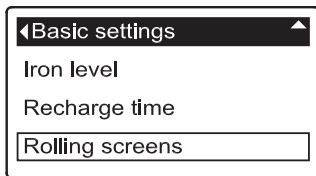

FIG. 105

4. Press the DOWN (▼) button to scroll through the menu options until **Rolling screens** is highlighted.
5. Press the SELECT (O) button to display the Rolling screens menu (See Figure 106).

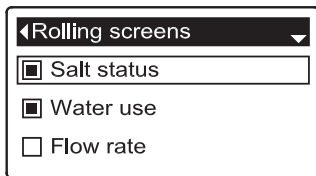

FIG. 106

6. Press the DOWN (▼) or UP (▲) buttons to scroll through the list. Items with a black square next to them will be displayed during normal operation.
7. To un-select a screen, make sure its name is highlighted in a box. Then press the SELECT (O) button. The black square will disappear. Pressing SELECT (O) again makes the black square reappear and re-selects the highlighted item. At least one screen must be selected/highlighted.
8. When selections are complete, exit this menu by pressing the LEFT (◀) button. The display will go back to the Basic settings menu (Figure 105).
9. Press the LEFT (◀) button twice to return to the rolling status screens.

*This does not include service reminders, errors, alerts or Recharge status screens.

SETTING THE LANGUAGE

When the conditioner/refiner’s electronic control is first powered up, a “wizard” screen prompts you to set the language (See Page 9 or 13). Language is set independently on the conditioner/refiner and remote (See Page 18 to set the remote’s language). To change the conditioner/ refiner’s language:

1. From any of the rolling status screens, press the SELECT (O) button to display the **Main menu**.
2. Press the DOWN (▼) button to scroll through the menu options until **User preferences** is highlighted (See Figure 107).

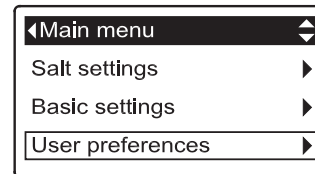

FIG. 107

3. Press the SELECT (O) button to display the User preferences menu (See Figure 108).

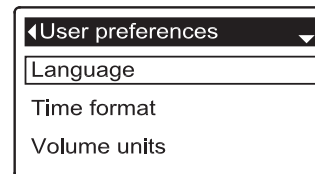

FIG. 108

4. Make sure **Language** is highlighted.
5. Press the SELECT (O) button to display the Language menu (See Figure 109).

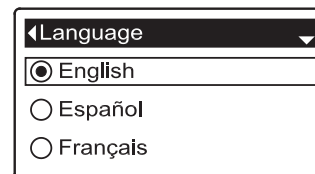

FIG. 109

6. If the desired language already has a black dot next to it (See Figure 109), go to Step 7. Otherwise, press the DOWN (▼) or UP (▲) buttons to scroll to the desired language, then press SELECT (O) to choose it. The choices are: English, Spanish, French, Italian, German, Dutch, Polish, Russian, Hungarian, Turkish, Lithuanian, Greek, Romanian, Czech, Slovak, Bulgarian, Serbian or Croatian.
7. Press the SELECT (O) button. The display will go back to the User preferences menu (Figure 108).
8. Press the LEFT (◀) button twice to return to the rolling status screens.

TO SET THE CONDITIONER/REFINER TO ENGLISH IF ANOTHER LANGUAGE IS DISPLAYED:

From the rolling status screens, press SELECT (O). Press DOWN (▼) three times, then press SELECT (O) twice. Press UP (▲) to scroll to **English** at the top of the list, then press SELECT (O) twice. Press LEFT (◀) twice to exit all menus.

SETTING TIME FORMAT

Use this feature to select a 12-hour (AM/PM) or 24-hour clock.

1. From any of the rolling status screens, press the SELECT (O) button to display the **Main menu**.
2. Press the DOWN (▼) button to scroll through the menu options until **User preferences** is highlighted.
3. Press the SELECT (O) button to display the User preferences menu.
4. Press the DOWN (▼) button to scroll through the menu options until **Time format** is highlighted.
5. Press the SELECT (O) button to display the Time format menu (See Figure 110).

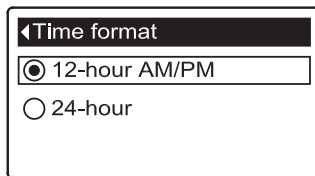

FIG. 110

6. If the desired time format already has a black dot next to it (See Figure 110), go to Step 7. Otherwise, press the DOWN (▼) or UP (▲) buttons to scroll to the other time format, then press SELECT (O) to choose it.
7. Press the SELECT (O) button. The display will go back to the User preferences menu.
8. Press the LEFT (◀) button twice to return to the rolling status screens.

SETTING VOLUME UNITS

Use this feature to select gallons or liters as volume units.

- 1-3. Go to the **User preferences** menu by following Steps 1-3 in "Setting Time Format" above.
4. Press the DOWN (▼) button to scroll through the menu options until **Volume units** is highlighted.
5. Press the SELECT (O) button to display the Volume units menu (See Figure 111).

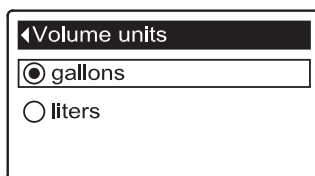

FIG. 111

6. If the desired volume unit already has a black dot next to it (See Figure 111), go to Step 7. Otherwise, press the DOWN (▼) or UP (▲) buttons to scroll to the other volume unit, then press SELECT (O) to choose it.
7. Press the SELECT (O) button. The display will go back to the User preferences menu.
8. Press the LEFT (◀) button twice to return to the rolling status screens.

SETTING HARDNESS UNITS

Use this feature to select grains or parts per million (ppm) as hardness units.

1. From any of the rolling status screens, press the SELECT (O) button to display the **Main menu**.
2. Press the DOWN (▼) button to scroll through the menu options until **User preferences** is highlighted.
3. Press the SELECT (O) button to display the User preferences menu.
4. Press the DOWN (▼) button to scroll through the menu options until **Hardness units** is highlighted.
5. Press the SELECT (O) button to display the Hardness units menu (See Figure 112).

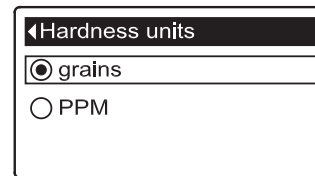

FIG. 112

6. If the desired hardness unit already has a black dot next to it (See Figure 112), go to Step 7. Otherwise, press the DOWN (▼) or UP (▲) buttons to scroll to the other hardness unit, then press SELECT (O) to choose it.
7. Press the SELECT (O) button. The display will go back to the User preferences menu.
8. Press the LEFT (◀) button twice to return to the rolling status screens.

SETTING WEIGHT UNITS

Use this feature to select pounds or kilograms as weight units.

- 1-3. Go to the **User preferences** menu by following Steps 1-3 in "Setting Hardness Units" above.
4. Press the DOWN (▼) button to scroll through the menu options until **Weight units** is highlighted.
5. Press the SELECT (O) button to display the Weight units menu (See Figure 113).

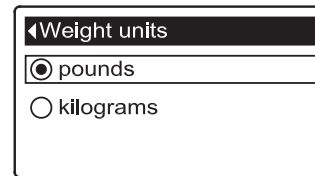

FIG. 113

6. If the desired weight unit already has a black dot next to it (See Figure 113), go to Step 7. Otherwise, press the DOWN (▼) or UP (▲) buttons to scroll to the other weight unit, then press SELECT (O) to choose it.
7. Press the SELECT (O) button. The display will go back to the User preferences menu.
8. Press the LEFT (◀) button twice to return to the rolling status screens.

SYSTEM INFORMATION

Use these features to look up the following information about the conditioner/refiner and its operations:

- **Model information** (model number and software version)
- **Wireless information** (only on Wi-Fi systems)
- **Water available** (conditioned water ready for use)
- **Daily average water used**
- **Water used today**
- **Total water used** (explained in Step 6, below)
- **Current water flow**
- **Days powered up**
- **Last recharge**
- **Total recharges**

To display one of these screens:

1. From any of the rolling status screens, press the SELECT (O) button to display the **Main menu**.
2. Press the DOWN (▼) button to scroll through the menu options until **System information** is highlighted (See Figure 114).

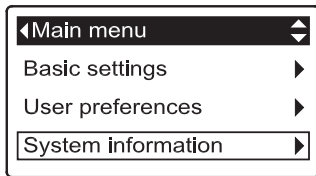

FIG. 114

3. Press the SELECT (O) button to display the System information menu (See Figure 115).

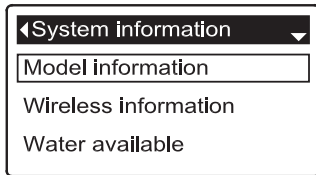

FIG. 115

4. Press the DOWN (▼) button to scroll through the menu options until the desired option is highlighted (See list at the top of this column).
5. Press the SELECT (O) button to display the desired information screen (See Figures 116-125).
6. The **Total water used** screen (See Figure 121) shows the volume of water used since it was last reset (it works like the trip odometer in a car). To reset the value to 0, press the RIGHT (▶) button while this screen is displayed.
7. When finished viewing an information screen, press the SELECT (O) button. The display will go back to the System information menu (Figure 115). It will also exit automatically if no buttons are pressed for four minutes.
8. Press the LEFT (◀) button twice to return to the rolling status screens.

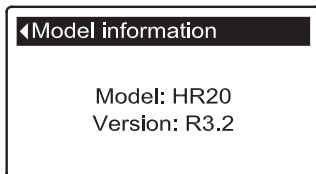

FIG. 116

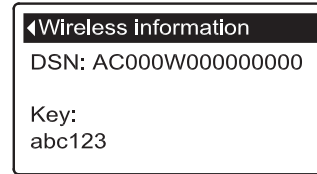

FIG. 117

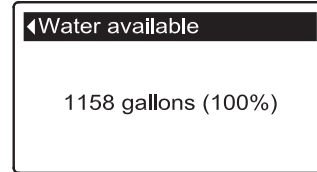

FIG. 118

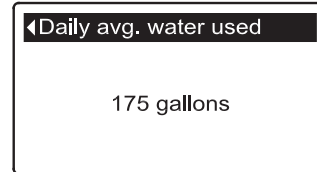

FIG. 119

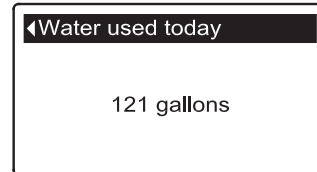

FIG. 120

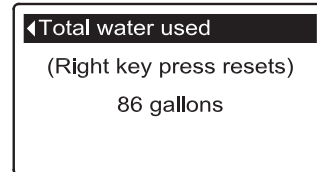

FIG. 121

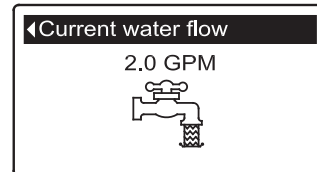

FIG. 122

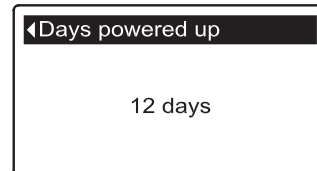

FIG. 123

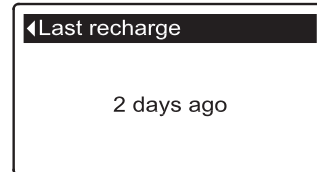

FIG. 124

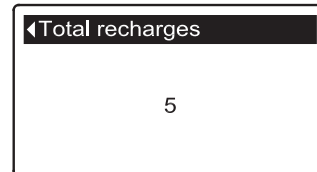

FIG. 125

CYCLE TIMES

Use these features to change the following conditioner/refiner operations:

- **Backwash time**
- **Second backwash (On/Off)**
- **Second backwash time**
- **Fast rinse time**

To display these screens:

1. From any of the rolling status screens, press the SELECT (O) button to display the **Main menu**.
2. Press the DOWN (▼) button to scroll through the menu options until **Advanced settings** is highlighted (See Figure 126).

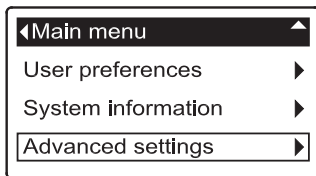

FIG. 126

3. Press the SELECT (O) button to display the Advanced settings menu (See Figure 127).

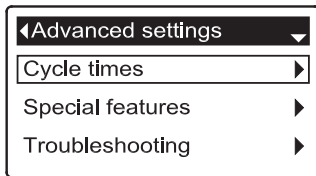

FIG. 127

4. Make sure **Cycle times** is highlighted.
5. Press the SELECT (O) button to display the Cycle times menu (See Figure 128).

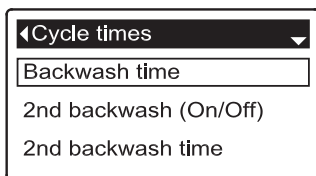

FIG. 128

6. Press the DOWN (▼) button to scroll through the menu options until the desired option is highlighted (See list at the top of this column).
7. Press the SELECT (O) button to display the desired information screen (See Figures 129-132).
8. **See the right column on this page for specific instructions on each cycle time screen.**
9. Press the SELECT (O) button. The display will go back to the Cycle times menu (Figure 128).
10. Press the LEFT (◀) button three times to return to the rolling status screens.

- 8a. **Backwash time:** Press the UP (▲) or DOWN (▼) buttons to change the backwash time. Hold the button down to rapidly advance. The backwash time can be set from 1 to 30 minutes* (See Figure 129).

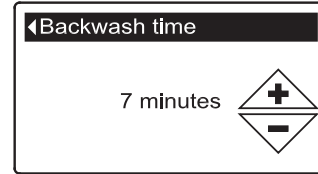

FIG. 129

- 8b. **Second backwash (On/Off):** If the desired option already has a black dot next to it (See Figure 130), go to Step 9. Otherwise, press the DOWN (▼) or UP (▲) buttons to scroll to the other option, then press SELECT (O) to choose it. Setting this feature On adds a second backwash and rinse at the beginning of the recharge cycle. Default is Off. Set this feature On if your water supply contains a lot of sediment or iron.

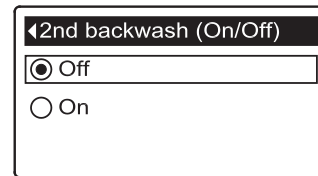

FIG. 130

- 8c. **Second backwash time:** Press the UP (▲) or DOWN (▼) buttons to change the second backwash time. Hold the button down to rapidly advance. The time can be set from 1 to 30 minutes (See Figure 131).

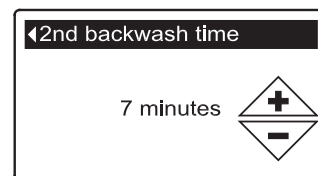

FIG. 131

- 8d. **Fast rinse time:** Press the UP (▲) or DOWN (▼) buttons to change the fast rinse time. Hold the button down to rapidly advance. The fast rinse time can be set from 1 to 30 minutes* (See Figure 132).

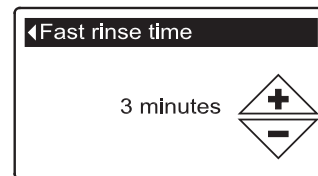

FIG. 132

*Reducing the backwash and fast rinse times below a conditioner/refiner model's default settings can result in salty water after recharges.

SPECIAL FEATURES

Use these features to change the following operations:

- **Efficiency mode**
- **Maximum days between recharges**
- **Auxiliary control** (described on Page 34)
- **Chemical feed volume*** (described on Page 34)
- **Chemical feed timer*** (described on Page 34)
- **97% feature**
- **Service reminder** (described on Page 35)

To display one these screens:

1. From any of the rolling status screens, press the SELECT (O) button to display the **Main menu**.
2. Press the DOWN (▼) button to scroll through the menu options until **Advanced settings** is highlighted (See Figure 133).

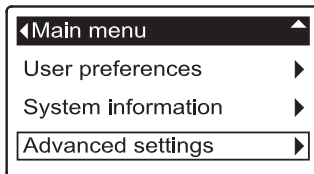

FIG. 133

3. Press the SELECT (O) button to display the Advanced settings menu (See Figure 134).

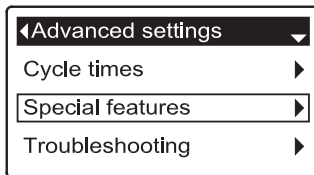

FIG. 134

4. Press the DOWN (▼) button to scroll through the menu options until **Special features** is highlighted.
5. Press the SELECT (O) button to display the Special features menu (See Figure 135).

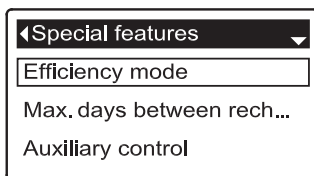

FIG. 135

6. Press the DOWN (▼) button to scroll through the menu options until the desired option is highlighted (See list at the top of this column).
7. Press the SELECT (O) button to display the desired information screen (See Figures 136-138).
8. **See the right column on this page for specific instructions on each cycle time screen.**
9. Press the SELECT (O) button. The display will go back to the Special features menu (Figure 135).
10. Press the LEFT (◀) button three times to return to the rolling status screens.

*Only displayed if Auxiliary control is set to Chemical feed.

8a. Efficiency mode: If the desired efficiency mode already has a black dot next to it (See Figure 136), go to Step 9. Otherwise, press the DOWN (▼) or UP (▲) buttons to scroll to the desired efficiency mode, then press SELECT (O) to choose it.

- **Salt efficient** limits available salt doses to maintain 4000 grains/lb. of salt efficiency. Units may recharge more frequently.

- **Auto adjusting** is the default. It automatically adjusts salt doses to target a 3-4 day interval between recharges. Recommended.

- **High capacity** is for applications where very low "bleed" (less than 1.5 ppm) of hardness can be tolerated. Such applications include water for boilers. This setting will consume higher quantities of salt.

NOTE: California regulations require the efficiency mode be set to **Salt efficient** for units installed in the state of California.

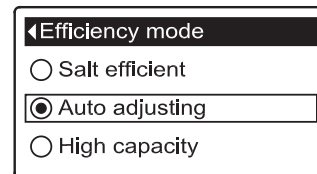

FIG. 136

8b. Maximum days between recharges: Press the UP (▲) or DOWN (▼) buttons to change the number of days (See Figure 137). The feature can be set from 1 to 15 days. Setting the number of days below 1 turns the feature off and defaults to automatic control of recharging.

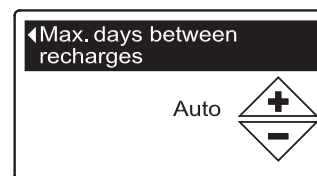

FIG. 137

8c. 97% feature: If the desired option already has a black dot next to it (See Figure 138), go to Step 9. Otherwise, press the DOWN (▼) or UP (▲) buttons to scroll to the other option, then press SELECT (O) to choose it. If this feature is On, the conditioner/refiner will automatically recharge when 97% of capacity is used, at any time of day. Default is Off.

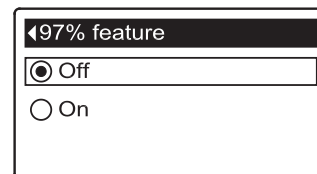

FIG. 138

AUXILIARY CONTROL

The electronic control has an auxiliary output which can control external devices in a water treatment system. The signal is 24V DC, current draw 500 mA maximum. The Auxiliary Output terminals are located on the electronic control board (See Schematic on Page 43).

For more details on the use of auxiliary controlled equipment in water treatment systems, consult the EcoWater Systems “Problem Water Guide.”

To select an auxiliary control mode:

1. From any of the rolling status screens, press the SELECT (O) button to display the **Main menu**.
2. Press the DOWN (▼) button to scroll through the menu options until **Advanced settings** is highlighted.
3. Press the SELECT (O) button to display the Advanced settings menu.
4. Press the DOWN (▼) button to scroll through the menu options until **Special features** is highlighted.
5. Press the SELECT (O) button to display the Special features menu (See Figure 139).

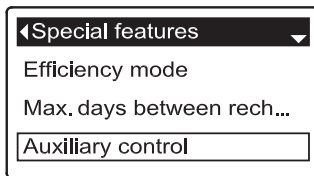

FIG. 139

6. Press the DOWN (▼) button to scroll through the menu options until **Auxiliary control** is highlighted.
7. Press the SELECT (O) button to display the Auxiliary control menu (See Figure 140).
8. If the desired option already has a black dot next to it (See Figure 140), go to Step 9. Otherwise, press the DOWN (▼) or UP (▲) buttons to scroll to the desired option, then press SELECT (O) to choose it.
 - **Off** is the default. The 24V DC output is always off.
 - **On**: The 24V DC output is always on.
 - **Chlorine** can be used to drive a chlorine generator, which produces chlorine, as brine water passes through it, to sanitize the resin during recharges.
 - **Bypass**: Turns 24V DC on during the entire regeneration cycle (when the conditioner’s valve is in bypass and hard water is going to the house).
 - **Chemical feed**: Can be used to run a chemical feed pump. If chosen, the chemical feed volume and timer must be set, as detailed at right)
 - **Water use**: Turns 24V DC on when the conditioner’s turbine indicates water flow. Could drive an air pump for iron or sulfur oxidation.
 - **Fast Rinse**: Turns 24V DC on during the fast rinse portion of the regeneration cycle.
9. Press the SELECT (O) button. The display will go back to the Special features menu (Figure 139).
10. Press the LEFT (◀) button three times to return to the rolling status screens.

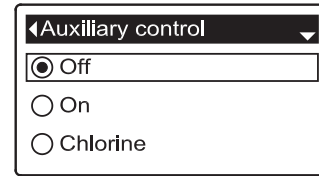

FIG. 140

CHEMICAL FEED

If the auxiliary control mode has been set to **Chemical feed**, as described in the previous section, two additional lines (**Chemical feed volume** and **Chemical feed timer**) will appear on the Special features menu.

To set these values:

1. From any of the rolling status screens, press the SELECT (O) button to display the **Main menu**.
2. Press the DOWN (▼) button to scroll through the menu options until **Advanced settings** is highlighted.
3. Press the SELECT (O) button to display the Advanced settings menu.
4. Press the DOWN (▼) button to scroll through the menu options until **Special features** is highlighted.
5. Press the SELECT (O) button to display the Special features menu (See Figure 139).
6. Press the DOWN (▼) button to scroll through the menu options until **Chemical feed volume** or **Chemical feed timer** is highlighted.
7. Press the SELECT (O) button to display the Chemical feed volume or Chemical feed timer menu (See Figures 141 & 142).

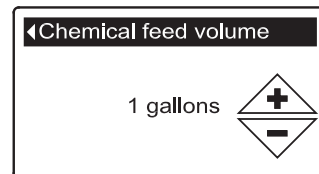

FIG. 141

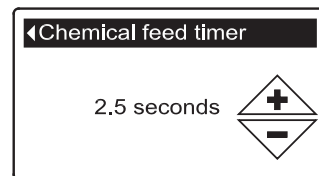

FIG. 142

8. Press the UP (▲) or DOWN (▼) buttons to change the value. Hold the button down to rapidly advance.
 - **Chemical feed volume** is the amount of water which will pass through the conditioner/refiner between each activation of the chemical feed equipment.
 - **Chemical feed timer** is how long the output to the chemical feed equipment is energized each time it is activated.
9. Press the SELECT (O) button. The display will go back to the Special features menu (Figure 139).
10. Press the LEFT (◀) button three times to return to the rolling status screens.

SERVICE REMINDER (set / reset)

Use this feature to program the number of months (up to 24) before a “Service overdue” message will appear instead of the rolling status screens (See Figure 143).

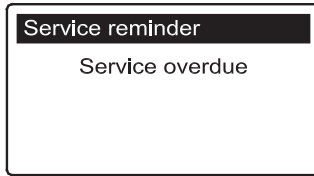

FIG. 143

This message also appears on the remote. This will be a reminder to call your dealer for service. Once programmed, this feature displays the number of months and days left until the service reminder.

Once the “Service overdue” message has appeared, dealers performing service clear it by setting the number of months until the next service reminder. Set or reset the service reminder as follows:

1. From any of the rolling status screens, press the SELECT (O) button to display the **Main menu**.
2. Press the DOWN (▼) button to scroll through the menu options until **Advanced settings** is highlighted.
3. Press the SELECT (O) button to display the Advanced settings menu.
4. Press the DOWN (▼) button to scroll through the menu options until **Special features** is highlighted.
5. Press the SELECT (O) button to display the Special features menu (See Figure 144).

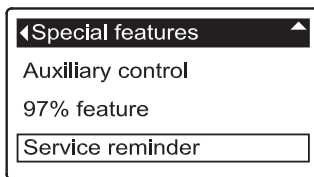

FIG. 144

6. Press the DOWN (▼) button to scroll through the menu options until **Service reminder** is highlighted.
7. Press the SELECT (O) button to display the Service reminder screen (See Figure 145).

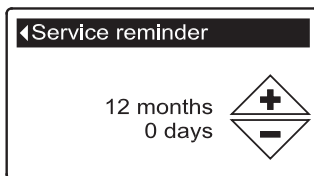

FIG. 145

8. Press the UP (▲) or DOWN (▼) buttons to set the number of months until the service reminder appears. Repeatedly pressing the DOWN (▼) button until the display reads “Off” turns this feature off and zeros the number of months and days.
9. Press the SELECT (O) button. The display will go back to the Special features menu (Figure 144).
10. Press the LEFT (◀) button three times to return to the rolling status screens.

SEND E.A.S.E. MESSAGE

With E.A.S.E. (Electronic Automated Service Evaluation), a homeowner or service technician can transmit operational data via a telephone for diagnostic purposes. Ask your participating EcoWater Systems dealer for more information.

To send an E.A.S.E. message:

1. From any of the rolling status screens, press the SELECT (O) button to display the **Main menu**.
2. Press the DOWN (▼) button to scroll through the menu options until **Advanced settings** is highlighted.
3. Press the SELECT (O) button to display the Advanced settings menu (See Figure 146).

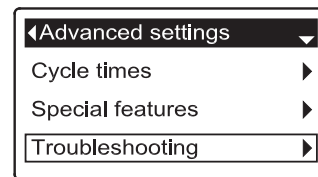

FIG. 146

4. Press the DOWN (▼) button to scroll through the menu options until **Troubleshooting** is highlighted.
5. Press the SELECT (O) button to display the Troubleshooting menu (See Figure 147).

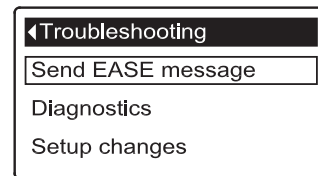

FIG. 147

6. Make sure **Send EASE message** is highlighted.
7. With the phone ready, press the SELECT (O) button to display the Send EASE message screen and begin transmission.
8. Hold the phone’s receiver an inch or two above the E.A.S.E. port on the conditioner/refiner’s faceplate (See Figure 7 on Page 9). Maintain the receiver steadily in this position during the entire transmission.

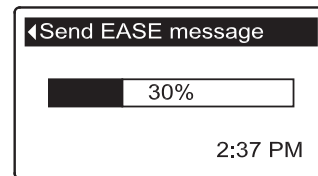

FIG. 148

9. A bar is displayed showing the transmission’s progress (See Figure 148). Once completed, the Troubleshooting screen immediately reappears (Figure 147).
10. Press the LEFT (◀) button three times to return to the rolling status screens.

DIAGNOSTICS

This feature allows a service technician to check the operating state of individual components in the conditioner/refiner (e.g. valve position) to troubleshoot problems. **If an error code is displayed in place of the rolling status screens, call your dealer for service.**

To view the Diagnostics screen:

1. If an error code is displayed, skip Steps 2-7 and go directly to Step 8.
2. To display the Diagnostics screen from any of the rolling status screens (when an error code is not displayed), press the SELECT (O) button to display the **Main menu**.
3. Press the DOWN (▼) button to scroll through the menu options until **Advanced settings** is highlighted.
4. Press the SELECT (O) button to display the Advanced settings menu.
5. Press the DOWN (▼) button to scroll through the menu options until **Troubleshooting** is highlighted.
6. Press the SELECT (O) button to display the Troubleshooting menu (See Figure 149).

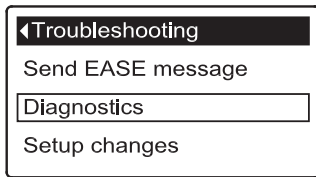

FIG. 149

7. Press the DOWN (▼) button to scroll through the menu options until **Diagnostics** is highlighted.
8. Press the SELECT (O) button to display the Diagnostics screen (See Figure 150).

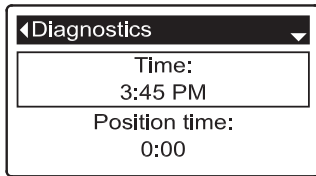

FIG. 150

9. Press the DOWN (▼) or UP (▲) buttons to scroll through the list. The following items are displayed:
 - **Time** (current)
 - **Position time** (counts down the time remaining in the current valve position)
 - **Current position** (of the valve: service, fill, brine, backwash, fast rinse or moving)
 - **Requested position** (of the valve)
 - **Motor state** (on or off)
 - **Valve position switch** (open or closed)
 - **Turbine count** (if changing, indicates water flow)
 - **Tank light switch** (open or closed)
 - **RF module** (detected or not)
 - **Error code** (call for service if a number is displayed)

continued

10. When finished viewing the Diagnostics screen, press the SELECT (O) button. The display will go back to the Troubleshooting menu.
11. Press the LEFT (◀) button three times to return to the rolling status screens (or error code screen if an error condition exists).

SETUP CHANGES

This feature allows a service technician to repeat the setup procedure (See Pages 9-13) or restore the conditioner/refiner's default operating values.

1. From any of the rolling status screens, press the SELECT (O) button to display the **Main menu**.
2. Press the DOWN (▼) button to scroll through the menu options until **Advanced settings** is highlighted.
3. Press the SELECT (O) button to display the Advanced settings menu.
4. Press the DOWN (▼) button to scroll through the menu options until **Troubleshooting** is highlighted.
5. Press the SELECT (O) button to display the Troubleshooting menu (See Figure 149).
6. Press the DOWN (▼) button to scroll through the menu options until **Setup changes** is highlighted.
7. Press the SELECT (O) button to display the Setup changes menu (See Figure 151).

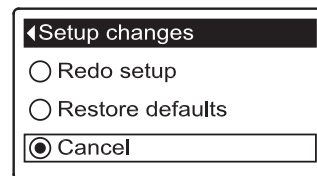

FIG. 151

8. If the desired option already has a black dot next to it (See Figure 151), go to Step 9. Otherwise, press the DOWN (▼) or UP (▲) buttons to scroll to the desired option, then press SELECT (O) to choose it.
 - **Redo setup** allows you to select a different model code (intended to be used for upgrades or retrofits of existing conditioner/refiners). Model codes are listed on Page 44.
 - **Restore defaults** will reset all customizable settings to their default values and take you through the "wizard" screen setup procedure (See Pages 9-13).
 - **Cancel** will return to the Troubleshooting menu (Figure 149).
9. Press the SELECT (O) button.

REFILLING WITH SALT

If the conditioner/refiner uses all the salt before more is added, hard water will result. Lift the brine tank lid and check the salt level frequently. The remote can also be used to monitor salt. It has an optional display, on the conditioner/refiner status screen, of the estimated number of days until salt is depleted (“Out of salt in X days”). The conditioner/refiner can also be programmed to display a Low Salt Alarm a certain number of days before salt is estimated to run out (See Page 26).

Be sure that the brinewell cover is on when adding salt. After adding and leveling salt, always set the salt level on the electronic controller, as described on Page 26.

NOTE: In humid areas it is best to keep the salt level less than half full and refill more often.

RECOMMENDED SALT: Cube, pellet, coarse solar, etc., water conditioner salt is recommended. This type of salt is high purity evaporated crystals, sometimes formed and pressed into briquets. It has less than 1% insoluble (not dissolvable in water) impurities. Clean, high grade rock salts are acceptable, but may require frequent brine tank cleaning to remove the “sludge” residue (insolubles) collecting at the bottom of the tank.

POTASSIUM CHLORIDE: If you choose potassium chloride (KCl) salt as a regenerant:

- 1) Make sure “Salt type” on the electronic control is set to “KCl”, as shown on Page 26.
- 2) Place only one bag of potassium chloride (KCl) into your conditioner/refiner at a time. The salt storage tank should never contain more than 60 pounds of KCl.

SALT NOT RECOMMENDED: Rock salt high in impurities, block, granulated, table, ice melting, or ice cream making salts, etc., are not recommended.

SALT WITH IRON REMOVING ADDITIVE: Some salts have an additive to help a water conditioner/refiner handle iron in the water supply. Although this may help keep the resin bed clean, it may also release corrosive fumes that will weaken and shorten the life of some EcoWater Systems conditioner/refiner electronic parts. Iron Out salt is safe to use on two-tank models.

NOTE: The Commonwealth of Massachusetts plumbing code 248-CMR shall be adhered to. A licensed plumber shall be used for this installation.

BREAKING A SALT BRIDGE

Sometimes a hard crust or salt “bridge” forms in the brine tank. This is usually caused by high humidity or the wrong kind of salt. When the salt bridges, an empty space forms between the water and the salt. Then salt will not dissolve in the water to make brine. Without brine, the resin bed is not recharged and hard water will result.

If the storage tank is full of salt, it is difficult to tell whether there is a salt bridge. A bridge may be underneath loose salt. The following is the best way to check for a salt bridge:

Salt should be loose all the way to the bottom of the tank. Hold a broom handle, or like tool, up to the conditioner/refiner, as shown in Figure 152. Make a pencil mark on the handle 1” - 2” below the top of the rim. Then, carefully push it straight down into the salt. If a hard object is felt before the pencil mark is even with the top, it is most likely a salt bridge. Carefully push into the bridge in several places to break it. **Do not try to break the salt bridge by pounding on the outside of the salt tank. You may damage the tank.**

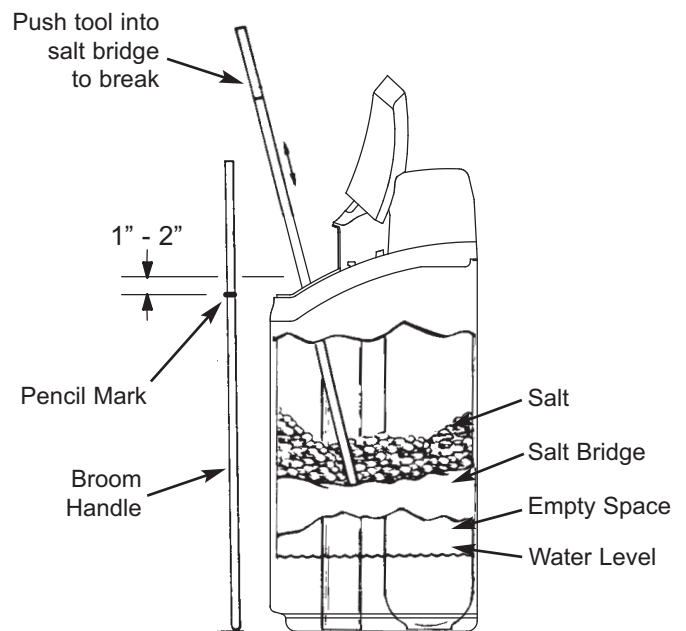

FIG. 152

CLEANING THE NOZZLE & VENTURI

A clean nozzle & venturi (See Figure 153) is necessary for the EcoWater Systems conditioner/refiner to work properly. This small unit creates the suction to move brine from the brine tank into the resin tank. If it should become plugged with dirt, silt, sand, etc., the EcoWater Systems conditioner/refiner will not work and hard water will result.

To get access to the nozzle & venturi, remove the conditioner/refiner's top cover. Put the bypass valve(s) into the bypass position. Be sure the conditioner/refiner is in the service cycle (no water pressure at the nozzle & venturi). Then, holding the nozzle & venturi housing with one hand, turn the cap to remove it. Do not lose the o-ring seal. Lift out the screen support and screen. Then, remove the nozzle & venturi. Wash the parts in warm, soapy water and rinse in fresh water. If needed, use a small brush to remove iron or dirt. Be careful not to scratch, misshape, etc., surfaces of the nozzle & venturi. Also, check and clean the gasket and flow plug(s) if dirty.

Carefully replace all parts in the correct order. Lubricate the o-ring seal with silicone grease and put in place. Install and tighten the cap, by hand only. Do not overtighten, which could break the cap or housing. Put the bypass valve(s) into service (conditioned water) position.

RESIN BED CLEANING

If the water supply contains clear water iron, regular resin bed cleaning is needed to keep the bed from coating with iron. Use resin bed cleaner, available from EcoWater Systems, following directions on the container. Clean the resin every six months, or more often if iron appears in the conditioned water supply.

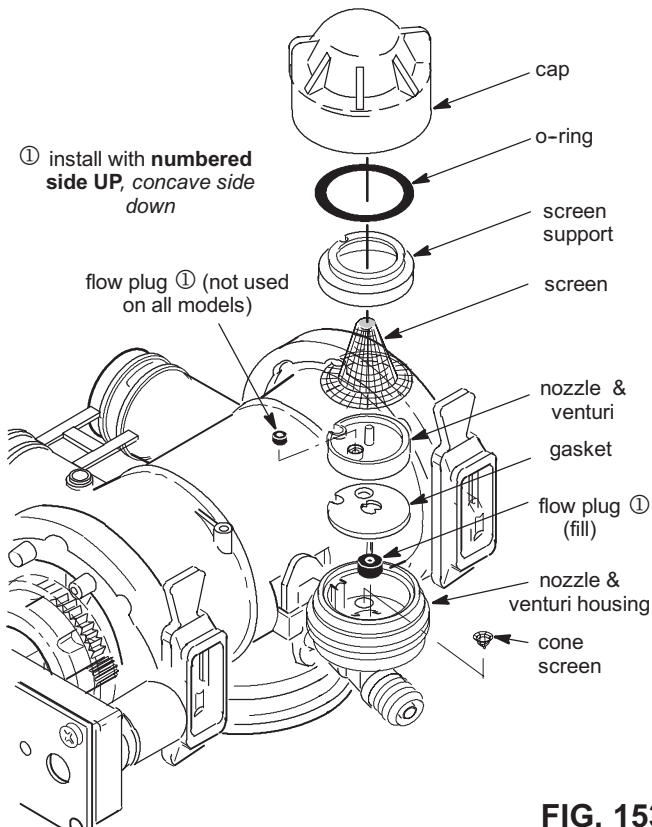

FIG. 153

RELIEVING WATER PRESSURE WITH THE BYPASS VALVE(S)

CAUTION: Always relieve water pressure in the EcoWater Systems conditioner/refiner, as described below, before removing parts from the valve or resin tank.

DE-PRESSURIZE

1. Put bypass valve(s) into **Bypass** position.
2. Place conditioner/refiner valve in **Fill** position by performing Steps 1 & 8 of Manual Advance Recharge procedure on Page 42.

PRESSURIZE

1. Put bypass valve(s) into **Service** position.
2. Return conditioner/refiner valve to **Service** position by performing Steps 11-17 of Manual Advance Recharge procedure on Page 42.

ALTERNATE METHODS:

3-VALVE BYPASS (See Figure 154)

DE-PRESSURIZE

1. Close the INLET valve.
2. Open HOT and COLD conditioned water house faucets.
3. Close the OUTLET valve and open the BYPASS valve.
4. Close all house faucets.

PRESSURIZE

1. Open HOT and COLD house faucets.
2. Close the BYPASS valve and open the OUTLET valve.
3. **Slowly**, open the INLET valve.
4. Close all house faucets.

ECOWATER SYSTEMS BYPASS VALVE

(See Figure 155)

DE-PRESSURIZE

1. Close the house main water supply valve.
2. Open HOT and COLD conditioned water house faucets.
3. Push the bypass valve handle to **Bypass** position.
4. Optional: For hard water bypass to house faucets, reopen the main water supply valve.

PRESSURIZE

1. Open main water supply valve if it is closed.
2. Open HOT and COLD house faucets.
3. Pull the bypass valve handle to **Service** position.
4. Close all house faucets.

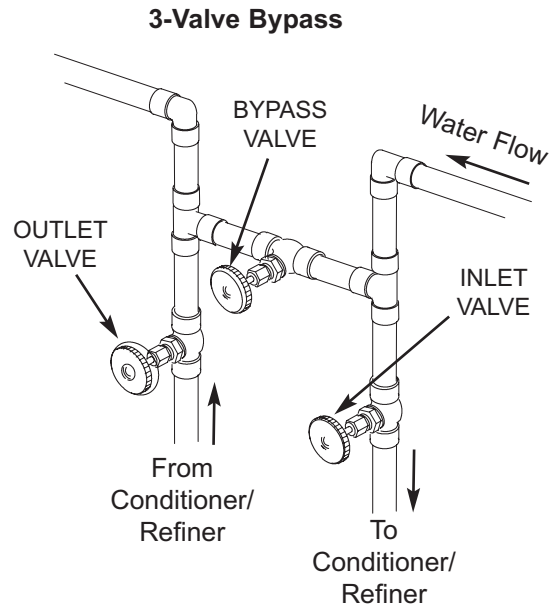

For Service
Close Bypass Valve.
Open Inlet & Outlet
Valves.

For Bypass
Open Bypass Valve.
Close Inlet & Outlet
Valves.

FIG. 154

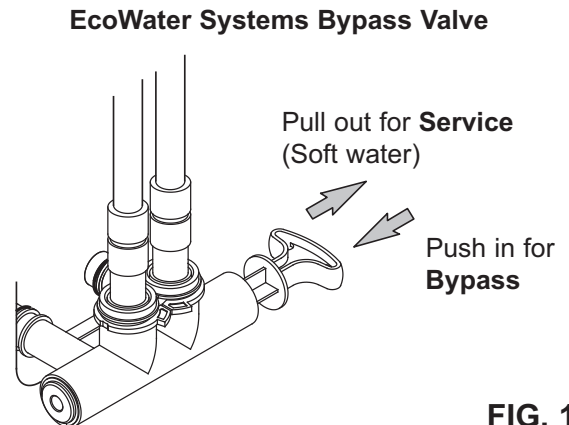



FIG. 155

TROUBLESHOOTING GUIDE

PROBLEM	CAUSE	CORRECTION
Remote display shows question marks (?) instead of numbers	Loss of signal between conditioner/refiner and remote.	Make sure conditioner/refiner is powered up. Check signal strength on remote (See Page 18). If signal is weak, move remote to a different location.
Cannot set some conditioner/refiner parameters and display shows a padlock icon: 	Lockout feature is on.	Turn off the lockout feature (See Page 25).
No soft water	No salt in the storage tank.	Add salt (See Page 37) and then initiate a "Recharge now," as shown on Page 27.
	Salt is "bridged."	Break salt bridge (See Page 37) and then initiate a "Recharge now," as shown on Page 27.
	If display is blank, power supply may be unplugged at wall outlet, power cable leads may be disconnected from the electronic control board, fuse may be blown, circuit breaker may be popped, or power supply may be plugged into a switched outlet which is "off."	Check for power loss due to any of these and correct. When power is restored, if the display shows the "Current Time" setting screen (Figure 98 on Page 27), it means time was lost during the outage. Set the current time. Other settings such as hardness are retained in memory during a power loss.
	Bypass valve(s) in bypass position.	Referring to Figure 6 on Page 7, place bypass valve(s) in service position.
	Dirty, plugged or damaged nozzle & venturi.	Take apart, clean and inspect the nozzle & venturi assembly, as shown on Page 38.
	Valve drain hose plugged or restricted.	Drain hose must not have any kinks, sharp bends, or be raised too high above the conditioner/refiner (See Page 7).
Water hard sometimes	Bypassed hard water being used during recharge, due to current time or recharge time settings being incorrect.	Check the current time displayed. If not correct, refer to "Set Current Time" on Page 27. Check the recharge time, as described on Page 28.
	Hardness number setting is too low.	Referring to "Setting Hardness" on Page 28, check the current hardness setting and increase if needed.
	Hot water being used when conditioner/refiner is recharging.	Avoid using hot water during recharges, because water heater refills with hard water.
	Increase in actual hardness of water supply.	Have unconditioned water sample tested. Referring to Page 28, check the current hardness setting and increase if needed.
	Turbine is not turning freely.	Check turbine, as described on Page 41.
Motor stalled or clicking	Motor malfunction or internal valve fault causing high torque on motor.	Contact your dealer for service.
Error code E1, E3 or E4 displayed.	Fault in wiring harness, connections to position switch, switch, valve or motor.	Contact your dealer for service.
Error code E5 displayed.	Electronic control malfunction.	Contact your dealer for service.

TROUBLESHOOTING - INITIAL CHECKS

Always make these initial checks first:

1. Is display blank? Check power source.
2. Is Error code displayed? If so, go to "Automatic Electronic Diagnostics" on the next page.
3. Is correct time displayed? If not, recharges occur at the wrong time. Set current time (See Page 27.)
4. Is there salt in the brine tank? If not, refill.
5. Is salt "bridged" (See Page 37)?
6. Are plumbing bypass valve(s) in service position (See Figure 6 on Page 7)?
7. Are inlet and outlet pipes connected to the EcoWater conditioner/refiner inlet and outlet respectively?

8. Is valve drain hose free of kinks and sharp bends, and not elevated over 8 feet above the floor.
9. Is the brine tube connected (See Fig. 5 on Page 7)?
10. Check the hardness setting (See "Setting Hardness" on Page 28). Be sure it is correct for the household's water supply. Perform a hardness test on a raw water sample to compare with the setting.
11. Perform a hardness test on a conditioned water sample to determine whether a problem exists.

If no problem is found after making the initial checks, proceed to "Troubleshooting - Manual Diagnostics" and "Manual Advance Recharge Check" on the next two pages.

AUTOMATIC ELECTRONIC DIAGNOSTICS

This conditioner/refiner has a self-diagnostic function for the electrical system (except for input power and/or water meter). The controller monitors electronic components and circuits for correct operation. If a malfunction occurs, an **Error code** is displayed (See Figure 156).

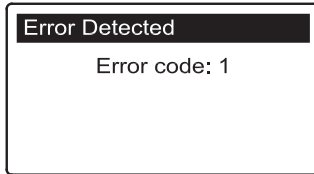

FIG. 156

The troubleshooting chart on the previous page shows the error codes that could appear, and the possible malfunctions for these codes.

When an error code appears in the display, pressing SELECT (O) will display the **Diagnostics** screen (See Page 36), so a service technician can further isolate the problem.

REMOVING ERROR CODE

1. Unplug power supply from electrical outlet.
2. Correct problem.
3. Plug power supply back in.
4. Wait for eight minutes while controller operates valve through an entire cycle. The error code will return if the problem was not corrected.

TROUBLESHOOTING - MANUAL DIAGNOSTICS

1. Display the **Diagnostics** screen, following the procedure on Page 36.
2. Press the DOWN (▼) or UP (▲) buttons to scroll through the list. The following items are displayed:
 - **Time** (current)
 - **Position time** (counts down the time remaining in the current valve position)
 - **Current position** (of the valve: service, fill, brine, backwash, fast rinse or moving) See “Manual Advance Recharge Check” on next page for position verification.
 - **Requested position** (of the valve)
 - **Motor state** (on or off)
 - **Valve position switch** (open or closed)
 - **Turbine count** (indicates water flow) See following section for turbine diagnostics.
 - **Tank light switch** (open or closed)
 - **RF module** (detected or not)
 - **Error code**

CHECKING THE TURBINE

1. Display the **Diagnostics** screen, following the procedure on Page 36.
2. Press the DOWN (▼) button to scroll through the list until **Turbine Count** is displayed (See Figure 157).

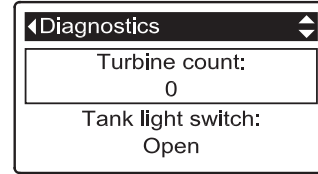

FIG. 157

3. A steady display of “0” (zero) indicates no water flow through the meter (i.e. no conditioned water being used).
4. Open a nearby conditioned water faucet.
5. The number in the display should count upward from 0 and reset for each gallon of flow (at 200 on some models, for example).
6. If the display reading does not change with the faucet open, pull the wire harness from the valve outlet port (See Figure 158).

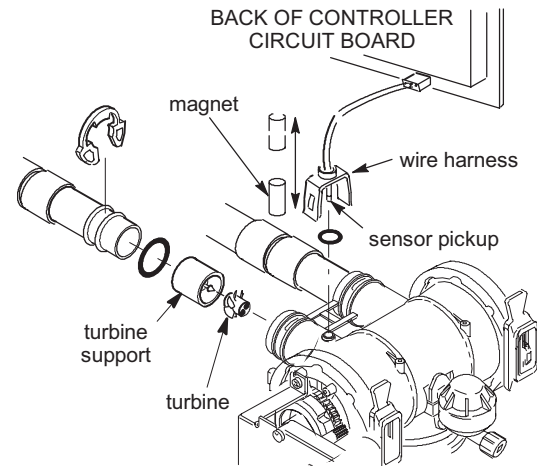

FIG. 158

7. Pass a small magnet back and forth in front of the sensor.
- 8a. If the displayed **Turbine Count** does count upward with each pass of the magnet, disconnect the outlet plumbing and check the turbine for binding.
- 8b. If the displayed **Turbine Count** does not count upward with each pass of the magnet, the sensor is probably faulty.

TROUBLESHOOTING - MANUAL ADVANCE RECHARGE CHECK

This check verifies proper operation of the position switch, gear motor, brine tank fill, brine draw, recharge flow rates, and other controller functions. Always make the Initial Checks (See Page 40) and the Manual Diagnostics (See Page 41) first.

1. Display the **Diagnostics** screen, following the procedure on Page 36.
2. Press the DOWN (▼) button to scroll through the list until **Valve position switch** is displayed (See Figure 159).

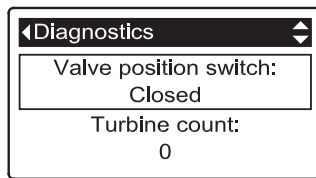

FIG. 159

3. Verify that when the switch plunger is down (into one of the detents on the valve motor cam), this screen reads **Open**. When the valve cam is rotating (for example, after Step 8, below), the switch plunger will be up and this screen should read **Closed**.
4. Press the UP (▲) button to scroll through the list until **Current position** is displayed (See Figure 160).

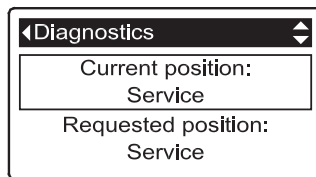

FIG. 160

6. Verify that the valve position indicator on the motor cam agrees with the position displayed on the screen
7. Remove the brinewell cover.
8. With the Diagnostics screen displayed, press the RIGHT (▶) button once to advance the valve from **Service** to **Fill**.
9. Shine a flashlight into the brinewell and observe fill water entering the tank.
10. If water does not enter the tank, look for an obstructed nozzle / venturi, fill flow plug or brine tube (See Figure 153 on Page 38).
11. After verifying fill, press the RIGHT (▶) button once to move the valve into **Brine***. A slow flow of water to the drain will begin. Verify brine draw from the brine tank by shining the flashlight into the brinewell to observe a noticeable drop in the liquid level.

* If the 2nd Backwash option is set "On" (See Page 32), the valve will enter backwash and fast rinse before brine.

12. If the unit does not draw brine, check for:
 - Dirty or defective nozzle / venturi (See Page 38)
 - Nozzle / venturi not seated on the gasket or gasket not sealing properly
 - Restriction in valve drain, causing back pressure (bends, kinks, elevated too high, etc.)
 - Obstruction in valve or brine tubing
 - Internal valve fault (obstructed outlet disc, wave washer faulty etc.)
13. With the Diagnostics screen displayed, once again press the RIGHT (▶) button to advance the valve to **Backwash**.
14. Look for a fast flow of water from the drain hose. If flow is slow, check for a plugged top distributor, backwash flow plug or drain hose
15. With the Diagnostics screen displayed, once again press the RIGHT (▶) button to advance the valve to **Fast rinse**.
16. Again, look for a fast flow of water from the drain hose. Allow the unit to rinse for several minutes to flush out any brine that may remain from the brine cycle test.
17. With the Diagnostics screen displayed, once again press the RIGHT (▶) button to return the valve to the **Service** position.

IMPORTANT: Always return the valve to the **Service** position before exiting this procedure.

OTHER SERVICE

Hard Water Bypass (Hard water "bleeds" into conditioned water supply):

1. Faulty inlet disc, seal or wave washer (See Pages 48 and 49).
2. Missing or faulty o-ring(s) at valve connection to riser pipe.

Water Leaks from Drain Hose during service:

1. Faulty inlet disc, seal or wave washer.
2. Faulty o-ring on inlet disc shaft.
3. Faulty outlet disc, seal or wave washer.

Flooded Salt Tank:

1. Nozzle / venturi plugged.
2. Faulty valve seals.
3. Restricted or plugged backwash / fast rinse controls.
4. Restricted or plugged drain line.

Water Has Salty Taste:

1. House water pressure low. Adjust well pump.
2. Partially restricted valve drain hose, top distributor, backwash flow plug, resin tank internal riser pipe, or bottom distributor.
3. Backwash and fast rinse times have been reduced from default settings.
4. Wrong model code.

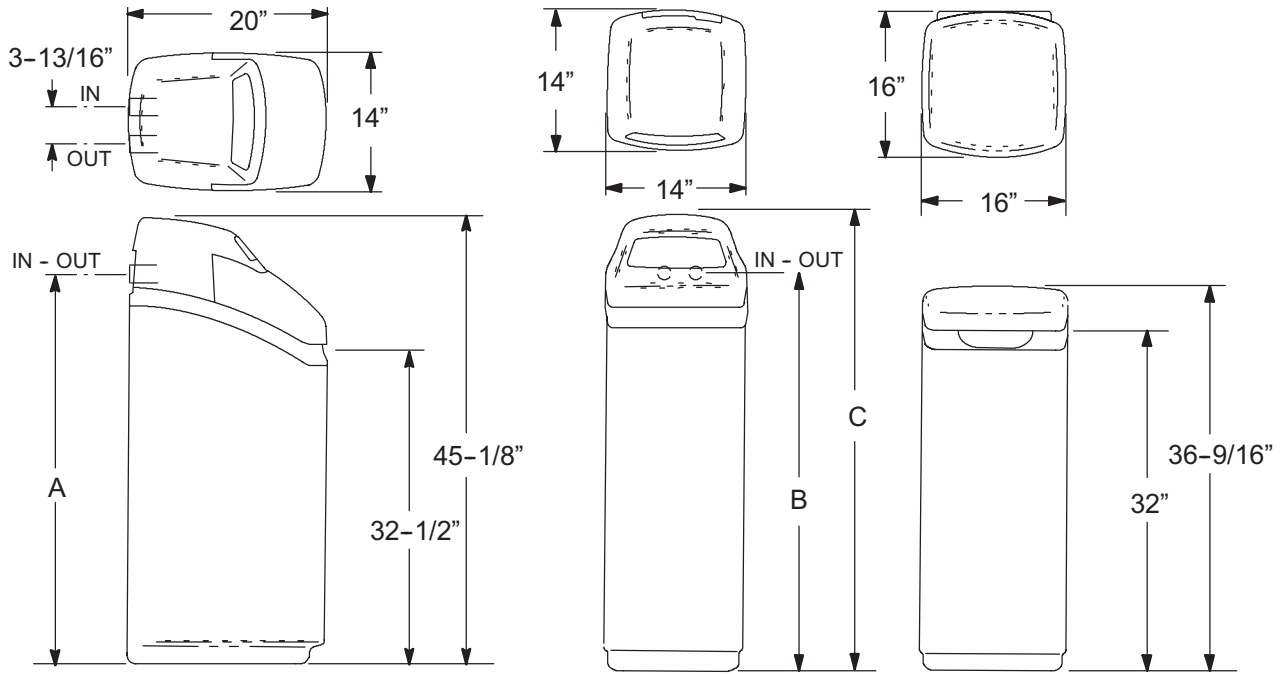

Cabinet Models

Two-Tank Models

FIG. 161

Model	Nominal Resin Tank Size	Dimension A	Dimension B	Dimension C	Salt Storage Capacity
ECR 3500R20	8" Dia. x 35"	39.5"	—	—	225 lbs.
ERR 3500R20 & ECR 3500R30	10" Dia. x 35"	39.5"	—	—	200 lbs.
ECR 3502R30	10" Dia. x 35"	—	39.5"	44.8"	300 lbs.
ERR 3502R30 & ECR 3502R40	10" Dia. x 47"	—	51.3"	56.6"	300 lbs.
ECR 3502R50S, ERR 3502R50, ECR 3502R70 & ERRC 3502R50	12" Dia. x 54"	—	57.1"	62.2"	300 lbs.

WIRING SCHEMATIC

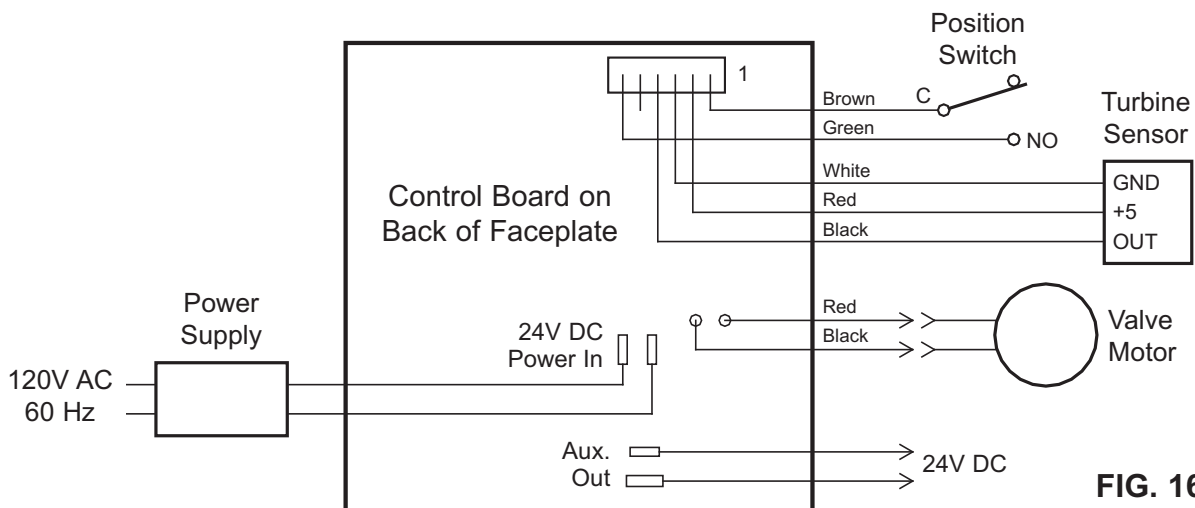

FIG. 162

SPECIFICATIONS					
	ECR 3500R20	ERR 3500R20	ECR 3500R30	ECR 3502R30	ERR 3502R30
Model Code	HR20	HR20+	HR30	2H30	2H30+
Rated Softening Capacity (Grains @ lb. Salt Dose)	5,700 @ 1.1 16,800 @ 4.3 20,400 @ 7.5	9,800 @ 2.4 18,100 @ 5.6 20,900 @ 8.9	8,300 @ 1.6 25,000 @ 6.4 30,200 @ 11.3	8,300 @ 1.6 25,000 @ 6.4 30,200 @ 11.3	11,600 @ 2.8 22,300 @ 6.9 25,900 @ 11.0
Rated Efficiency (gr./lb. of Salt at Min. Salt Dose)	5,150	4,100	5,160	5,160	4,140
Water Used During Regeneration	4.6 gal./1,000 grains	5.0 gal./1,000 grains	4.5 gal./1,000 grains	4.5 gal./1,000 grains	5.0 gal./1,000 grains
Service Flow Rate (gpm)	9.0	8.0	11.0	11.0	8.0
Pressure Drop at Service Flow Rate (psi)	10	7	8	8	8
Intermittent Flow Rate (gpm) @ 15 psi ▲	12.0	14.8	16.5	16.5	14.2
Intermittent Flow Rate (gpm) @ 30 psi ▲	19.4	23.6	25.8	25.8	21.4
Amount of High Capacity Resin (cu. ft.)	0.60	0.71	0.89	0.89	0.88
Water Supply Max. Hardness (gpg)	40	50	60	60	60
Water Supply Max. Clear Water Iron (ppm) ■	10	10	12	12	12
Min.-Max. Working Pressure (psi) ◆	20 - 125				
Min.-Max. Operating Temperature (°F)	40 - 120				
Min. Water Supply Flow Rate (gpm)	3				
Max. Flow Rate (gpm) to Drain during Recharge	2.4	3.0	3.0	3.0	3.0

SPECIFICATIONS					
	ECR 3502R40	ECR 3502R50S	ERR 3502R50	ECR 3502R70	ERRC 3502R50 *
Model Code	2H40	2H50	2R50	2H70	2H50+
Rated Softening Capacity (Grains @ lb. Salt Dose)	11,300 @ 2.2 33,200 @ 8.5 40,100 @ 14.8	21,600 @ 4.5 39,500 @ 11.0 50,000 @ 17.4	21,000 @ 4.7 35,300 @ 9.7 49,900 @ 19.5	32,900 @ 6.2 57,600 @ 12.8 71,500 @ 25.6	21,600 @ 4.5 39,500 @ 11.0 50,000 @ 17.4
Rated Efficiency (gr./lb. of Salt at Min. Salt Dose)	5,150	4,800	4,440	5,310	4,800
Water Used During Regeneration	4.7 gal./1,000 grains	3.8 gal./1,000 grains	3.9 gal./1,000 grains	2.9 gal./1,000 grains	3.8 gal./1,000 grains
Service Flow Rate (gpm)	12.0	20.0	10.9	12.0	12.0
Pressure Drop at Service Flow Rate (psi)	13	13	8	11	10
Intermittent Flow Rate (gpm) @ 15 psi ▲	13.6	21.5	15.8	17.0	15.0
Intermittent Flow Rate (gpm) @ 30 psi ▲	21.6	32.2	24.0	22.0	21.0
Amount of High Capacity Resin (cu. ft.)	1.18	1.53	1.56	2.05	1.53
Water Supply Max. Hardness (gpg)	75	95	95	125	95
Water Supply Max. Clear Water Iron (ppm) ■	15	15	15	15	15
Min.-Max. Working Pressure (psi) ◆	20 - 125				
Min.-Max. Operating Temperature (°F)	40 - 120				
Min. Water Supply Flow Rate (gpm)	3				
Max. Flow Rate (gpm) to Drain during Recharge	3.0	4.0	4.0	4.0	4.0

▲ Intermittent flow rate does not represent the maximum service flow rate used for determining the unit's rated capacity and efficiency. Continuous operation at flow rates greater than the service flow rate may affect capacity and efficiency performance. The validity of these flow rates is verified by Water Quality Association (WQA).

■ Capacity to remove clear water iron is substantiated by WQA test data. State of Wisconsin requires additional treatment if water supply contains greater than 5 ppm clear water iron.

◆ Canada working pressure limits: 1.4 - 7.0 kg/cm².

* Model ERRC 3502R50 has not been tested or certified by NSF International or the Water Quality Association.

These units conform to NSF/ANSI 44 for the specific performance claims as verified and substantiated by test data.

These models are efficiency rated. The efficiency rating is valid only at the minimum salt dose and the service flow rate. The softeners have a demand initiated regeneration (D.I.R) feature that complies with specific performance specifications intended to minimize the amount of regenerant brine and water used in their operation.

These softeners have a rated softener efficiency of not less than 3,350 grains of total hardness exchange per pound of salt (based on sodium chloride) and shall not deliver more salt than their listed rating or be operated at a sustained maximum service flow rate greater than their listed rating. These softeners have been proven to deliver soft water for at least ten continuous minutes at the rated service flow rate. The rated salt efficiency is measured by laboratory tests described in NSF/ANSI Standard 44. These tests represent the maximum possible efficiency that the system can achieve. Operational efficiency is the actual efficiency after the system has been installed. It is typically less than the rated efficiency, due to individual application factors including water hardness, water usage, and other contaminants that reduce a softener's capacity.

While testing was performed under standard laboratory conditions, actual performance of the system may vary based on local water conditions.

PERFORMANCE CLAIMS		
Contaminant	Influent Challenge Level	Maximum Allowable Product Water Level
Barium	10 ±10% mg/L	2.0 mg/L
Radium 226/228	25 pCi/L	5 pCi/L

Test parameters include: pH = 7.5 ±0.5, flow rate = 7.5 gpm, and dynamic pressure = 35 ±5 psig.

Models ERR 3500R20, ERR 3502R30 and ERR 3502R50 have been tested according to NSF/ANSI Standard 42 for the reduction of chlorine taste and odor. The concentration of the indicated substance in water entering the system was reduced to a concentration less than or equal to the permissible limit for water leaving the system, as specified in NSF/ANSI Standard 42.

PERFORMANCE CLAIMS		
Substance	Influent Challenge Level	Reduction Requirement
Chlorine	2.0 ±10% mg/L	50%

		Model ERR 3500R20	Model ERR 3502R30	Model ERR 3502R50
Rated Capacity at Chlorine Concentration** of:	0.50 ppm	2,920,000 gal.*	3,650,000 gal.*	4,867,000 gal.*
	0.75 ppm	1,950,000 gal.*	2,440,000 gal.*	3,250,000 gal.*
	1.0 ppm	1,460,000 gal.*	1,820,000 gal.*	2,433,000 gal.*
	1.5 ppm	950,000 gal.*	1,910,000 gal.*	1,583,000 gal.*
	2.0 ppm	730,000 gal.	912,000 gal.*	1,217,000 gal.*

* From independent laboratory test data.

** Typical residential chlorine concentration is 0.5 to 1.0 ppm.

Model ERRC 3502R50 has not been tested or certified by NSF International or the Water Quality Association.

MODEL ERRC 3502R50 PERFORMANCE CLAIM		
Substance	Influent Challenge Level	Reduction Requirement
Chloramines	3 mg/L	>70% @ 10 gpm for 34,000 gal.***

*** From manufacturer's test data.

ECOWATER SYSTEMS CONDITIONER/REFINER ASSEMBLY

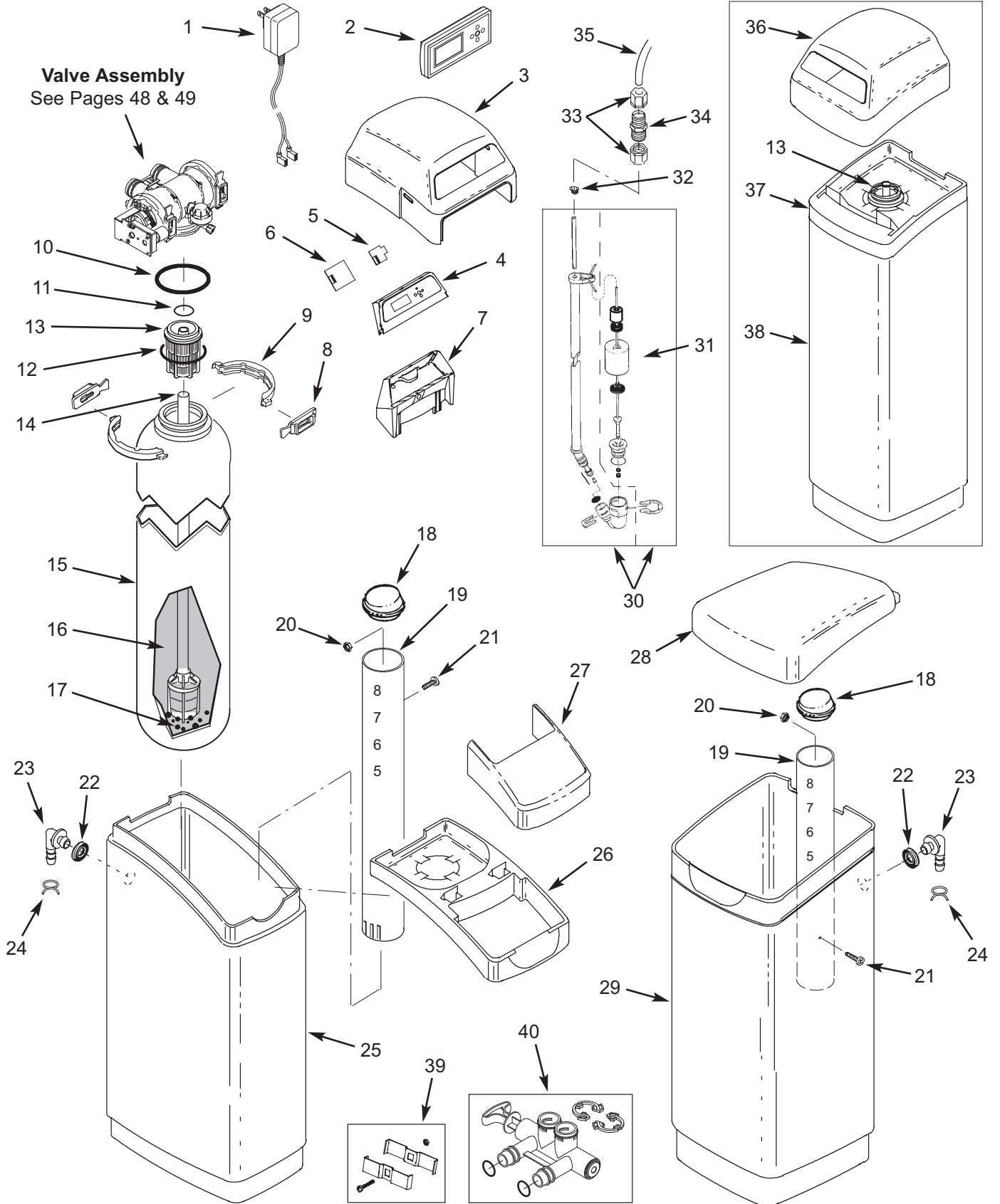

ECOWATER SYSTEMS CONDITIONER/REFINER ASSEMBLY

Key No.	Part No.	Description
1	7351054	Power Supply, 24V DC
2	7292967	Repl. Remote, incl. batteries (for non-Wi-Fi systems only)
3	7218662	Repl. Top Cover (cabinet models)
4	7341952	Repl. Faceplate Assembly, incl. decal & PWA (electronic controller), does not include Key Nos. 5 or 6
5	7341520	Repl. Wi-Fi Board (for Wi-Fi systems only)
6	7343491	Repl. Remote Transceiver Board (for non-Wi-Fi systems only)
7	7291343	Support, Faceplate w/lens
-	7331177	Tank Neck Clamp Kit (includes 2 ea. of Key Nos. 8 & 9)
8	↑	Retainer Clip (2 req.)
9	↑	Clamp Section (2 req.)
-	7112963	Distributor O-Ring Kit (includes Key Nos. 10-12)
10	↑	O-Ring, 2-7/8" x 3-1/4"
11	↑	O-Ring, 13/16" x 1-1/16"
12	↑	O-Ring, 2-3/4" x 3"
13	7077870	Top Distributor
14	7105047	Repl. Bottom Distributor
15	7304235	Resin Tank, 8" dia. x 35"
	7113066	Resin Tank, 10" dia. x 35"
	7092202	Resin Tank, 10" dia. x 47"
	7113074	Resin Tank, 12" dia. x 54"
16	0502272	Resin, 1 cu. ft. (standard mesh)
	7052202	Resin, 1 cu. ft. (fine mesh)
	7175149	Activated Carbon (ERR 3500R20, ERR 3502R30 & ERR 3502R50)
	7339141	Catalytic Carbon, 1 cu. ft. (ERRC 3502R50)
17	7124415	Gravel, 17 lbs.
18	7219888	Cover, Brinewell
19	7214375	Brinewell Assembly (including salt level decal)
-	7331698	Brinewell Mounting Hardware Kit (includes Key Nos. 20 & 21)
20	↑	Washer
21	↑	Screw

Key No.	Part No.	Description
-	7331258	Overflow Hose Adaptor Kit (includes Key Nos. 22-24)
22	↑	Grommet
23	↑	Adaptor Elbow
24	↑	Hose Clamp *
25	7218604	Repl. Brine Tank (cabinet models)
26	7287386	Rim (cabinet models)
27	7291466	Salt Lid Assembly
28	7274008	Cover, Brine Tank (two-tank models)
29	7218612	Repl. Brine Tank (two-tank models)
30	7310210	Brine Valve Assembly, R20, ECR 3500R30, R50(S) & R70 models)
	7310197	Brine Valve Assembly, ECR 3502R30, ERR 3502R30 & R40 models
31	7327568	Float, Stem & Guide Assembly, R20, ECR 3500R30, R50(S) & R70 models
	7113008	Float, Stem & Guide Assembly, ECR 3502R30, ERR 3502R30 & R40 models
32	7171349	Cone Screen
33	9003201	Nut-Ferrule (2 req.) *
34	7094987	Union Connector *
35	7161807	Tubing, 20 ft. *
	7161768	Tubing, 100 ft. *
36	7218670	Repl. Top Cover (two-tank models)
37	7274286	Rim (two-tank models)
38	7111084	Repl. Tank Sleeve, ECR 3502R30
	7218646	Repl. Tank Sleeve, ERR 3502R30 & ECR 3502R40
	7111050	Repl. Tank Sleeve, R50(S) & R70 models
39	7248706	Ground Clamp Kit *
40	7214383	Bypass Valve, 1" * (includes 2 ea. of Key Nos. 52 & 55)
■	7108118	Drain Hose, 1/2" I.D. *
■	7112882	Hose Clamp, for Valve Drain *

■ Not illustrated

* Optional parts, not included with conditioner/refiner

 To order parts, call your local EcoWater dealer or go to www.ecowater.com to locate a dealer in your area.

VALVE ASSEMBLY

Key No.	Part No.	Description
-	7290931	Turbine & Support Assembly (includes 1 ea. of Key Nos. 50, 51 & 2 ea. of Key No. 52), ECR 3500R20, ERR 3500R20, ECR 3500R30 & ECR 3502R30
	7331703	Turbine & Support Assembly (includes 1 ea. of Key Nos. 50, 51 & 2 ea. of Key No. 52), ERR 3502R30, R40, R50(S) & R70 models
50	↑	Turbine
51	↑	Turbine Support & Shaft
52	7311127	O-Ring, 1-1/16" x 1-5/16", single (2 req.)
	7336410	O-Ring, 1-1/16" x 1-5/16", pack of 20
53	7077642	Copper Tube, 1", single (2 req.)
	7344138	Copper Tube, 1", pack of 10 (includes 10 ea. of Key No. 52)
54	7234553	Copper Tube, 1-1/4" pipe (2 req.)
55	7089306	Clip, 1", single (2 req.)
	7336428	Clip, 1", pack of 20
56	7309811	Wire Harness w/pos. switch conn.
57	7159949	Disc Valve Housing
58	7334133	Outlet End Seal, single ❶
	7353404	Outlet End Seal, pack of 20
59	7334125	Inlet End Seal, single ❶
	7353399	Inlet End Seal, pack of 20
-	7135270	Inlet & Outlet End Seal Kit (includes 1 ea. of Key Nos. 58 & 59)
60	7214286	Inlet Disc ❶
61	7058216	Wave Washer (2 req.)
62	7170220	O-Ring, 3/4" x 15/16", single (3 req.) ❶
	7336444	O-Ring, 3/4" x 15/16", pack of 30
63	7170296	O-Ring, 2-7/8" x 3-1/4", single (2 req.)
	7336452	O-Ring, 2-7/8" x 3-1/4", pack of 20
64	7077498	Inlet End Cap
65	7142942	Clip, Drain
66	7219066	Drain Nipple
-	7141239	Drain Hose Adaptor (optional)
67	7170327	O-Ring, 5/8" x 13/16"
68	1110600	Flow Plug, Fast Rinse, 2.4 gpm, ECR 3500R20
	7097969	Flow Plug, Fast Rinse, 3.0 gpm, ERR 3500R20, R30 & R40 models
	7097977	Flow Plug, Fast Rinse, 4.0 gpm, R50(S) & R70 models
-	7331177	Tank Neck Clamp Kit (includes 2 ea. of Key Nos. 69 & 70)
69	↑	Retainer Clip (4 req.) ❷
70	↑	Clamp Section (4 req.) ❷

Key No.	Part No.	Description
-	7137507	Nozzle & Venturi Assembly (includes Key Nos. 71-79), ECR 3500R20 ❸
	7091866	Nozzle & Venturi Assembly (includes Key Nos. 71-78), ERR 3500R20, R30 & R40 models
	7085247	Nozzle & Venturi Assembly (includes Key Nos. 71-78), R50(S) & R70 models
71	7199729	Cap
72	7170262	O-Ring, 1-1/8" x 1-3/8", single
	7336436	O-Ring, 1-1/8" x 1-3/8", pack of 20
73	7167659	Screen Support
74	7146043	Screen
75	7187772	Nozzle & Venturi (red) Kit w/Gasket, R20 ❸, R30 & R40 models
	7114533	Nozzle Venturi (blue) Kit w/Gasket, R50(S) & R70 models
	7204362	Gasket only, single
	7336486	Gasket only, pack of 20
76	1148800	Flow Plug, Fill, 0.3 gpm
77	7081104	Housing, Nozzle & Venturi
78	7095030	Cone Screen
79	7084607	Flow Plug, 0.15 gpm, ECR 3500R20 ❸
80	7292323	O-Ring, 3/16" x 7/16"
81	7120526	Elbow, 90°
82	1202600	Nut - Ferrule
83	7170319	O-Ring, 1/4" x 3/8" (2 req.)
84	7081201	Clip, Nozzle & Venturi
85	7078313	Retainer
86	7104774	Flow Washer, Backwash, 1.0 gpm, ECR 3500R20
	7104570	Flow Washer, Backwash, 1.7 gpm, ERR 3500R20, R30 & R40 models - not used on R50(S) & R70 models
87	7214278	Outlet Disc ❶
88	7091329	Driver, Outlet Disc
89	7159965	Outlet End Cap
90	7283497	Cam & Gear
91	7203104	Washerhead Screw, #8-18 x 1/2"
92	7281275	Motor, incl. Key No. 93
93	7289702	Bracket, Motor
94	7168524	Screw, #10-32 x 5/16" (3 req.)
95	7103972	Screw, #8-18 x 7/16" (2 req.)
96	7140738	Screw, #4-24 x 3/4"
97	7145186	Switch
98	7140746	Expansion Pin

❶ Included in Disc Kit, #7218688

❷ Not all parts are shown

❸ Use red nozzle along with Key No. 79 on water pressures of 50 psi and less.

State of California
Department of Public Health
Water Treatment Device
Certificate Number
06- 1756

Date Issued: January 17, 2011

Trademark/Model Designation

ECR3500R20

Replacement Elements

N/A

Manufacturer: EcoWater Systems

The water treatment device(s) listed on this certificate have met the testing requirements pursuant to Section 116830 of the Health and Safety Code for the following health related contaminants:

Microbiological Contaminants and Turbidity

None

Inorganic/Radiological Contaminants

Barium

Radium 226/228

Organic Contaminants

None

Rated Service Capacity: N/A

Rated Service Flow: 9 gpm

Conditions of Certification:

Do not use with water that is microbiologically unsafe or of unknown quality, without adequate disinfection before or after the system.

State of California
Department of Public Health
Water Treatment Device
Certificate Number
06-1757

Date Issued: January 17, 2011

Trademark/Model Designation

ECR3500R30

ECR3502R30

Replacement Elements

N/A

N/A

Manufacturer: EcoWater Systems

The water treatment device(s) listed on this certificate have met the testing requirements pursuant to Section 116830 of the Health and Safety Code for the following health related contaminants:

Microbiological Contaminants and Turbidity

None

Inorganic/Radiological Contaminants

Barium

Radium 226/228

Organic Contaminants

None

Rated Service Capacity: N/A

Rated Service Flow: 11 gpm

Conditions of Certification:

Do not use with water that is microbiologically unsafe or of unknown quality, without adequate disinfection before or after the system.

State of California
Department of Public Health
Water Treatment Device
Certificate Number
06-1758

Date Issued: January 17, 2011

Trademark/Model Designation

ECR3502R40

Replacement Elements

N/A

Manufacturer: EcoWater Systems

The water treatment device(s) listed on this certificate have met the testing requirements pursuant to Section 116830 of the Health and Safety Code for the following health related contaminants:

Microbiological Contaminants and Turbidity

None

Inorganic/Radiological Contaminants

Barium

Radium 226/228

Organic Contaminants

None

Rated Service Capacity: N/A

Rated Service Flow: 12 gpm

Conditions of Certification:

Do not use with water that is microbiologically unsafe or of unknown quality, without adequate disinfection before or after the system.

State of California
Department of Public Health
Water Treatment Device
Certificate Number
06-1759

Date Issued: January 17, 2011

Trademark/Model Designation

ECR3502R50S

Replacement Elements

N/A

Manufacturer: EcoWater Systems LLC

The water treatment device(s) listed on this certificate have met the testing requirements pursuant to Section 116830 of the Health and Safety Code for the following health related contaminants:

Microbiological Contaminants and Turbidity

None

Inorganic/Radiological Contaminants

Barium

Radium 226/228

Organic Contaminants

None

Rated Service Capacity: N/A

Rated Service Flow: 20 gpm

Conditions of Certification:

Do not use with water that is microbiologically unsafe or of unknown quality, without adequate disinfection before or after the system.

State of California
Department of Public Health
Water Treatment Device
Certificate Number
06-1760

Date Issued: January 17, 2011

Trademark/Model Designation

ECR3502R70

Replacement Elements

N/A

Manufacturer: EcoWater Systems

The water treatment device(s) listed on this certificate have met the testing requirements pursuant to Section 116830 of the Health and Safety Code for the following health related contaminants:

Microbiological Contaminants and Turbidity

None

Inorganic/Radiological Contaminants

Barium
Radium 226/228

Organic Contaminants

None

Rated Service Capacity: N/A

Rated Service Flow: 12 gpm

Conditions of Certification:

Do not use with water that is microbiologically unsafe or of unknown quality, without adequate disinfection before or after the system.

State of California
Department of Public Health
Water Treatment Device
Certificate Number
06-1761

Date Issued: January 17, 2011

Trademark/Model Designation

ERR3500R20

Replacement Elements

N/A

Manufacturer: EcoWater Systems

The water treatment device(s) listed on this certificate have met the testing requirements pursuant to Section 116830 of the Health and Safety Code for the following health related contaminants:

Microbiological Contaminants and Turbidity

None

Inorganic/Radiological Contaminants

Barium
Radium 226/228

Organic Contaminants

None

Rated Service Capacity: N/A

Rated Service Flow: 9 gpm

Conditions of Certification:

Do not use with water that is microbiologically unsafe or of unknown quality, without adequate disinfection before or after the system.

State of California
Department of Public Health
Water Treatment Device
Certificate Number
06-1762

Date Issued: January 17, 2011

Trademark/Model Designation

ERR3502R30

Replacement Elements

N/A

Manufacturer: EcoWater Systems

The water treatment device(s) listed on this certificate have met the testing requirements pursuant to Section 116830 of the Health and Safety Code for the following health related contaminants:

Microbiological Contaminants and Turbidity

None

Inorganic/Radiological Contaminants

Barium

Radium 226/228

Organic Contaminants

None

Rated Service Capacity: N/A

Rated Service Flow: 10 gpm

Conditions of Certification:

Do not use with water that is microbiologically unsafe or of unknown quality, without adequate disinfection before or after the system.



FOR IOWA USE ONLY

All sales in Iowa require the following signature before consummation of sale. These signatures must be retained by seller/renter for 2 years minimum.

Buyer/Renter _____ Date _____

Seller _____ Date _____

Seller's Address _____

Seller's Phone No. _____

EcoWater Systems Digital Demand Water System – ECR / ERR Series 3500 or 3502