

OWNER'S MANUAL

How to install, operate
and maintain your
Models

IDP30S Water Softener

IDP40S Water Softener

IDP40CC* Chloramine
& Chlorine Water Conditioner

IDP50CC* Chloramine
& Chlorine Water Conditioner

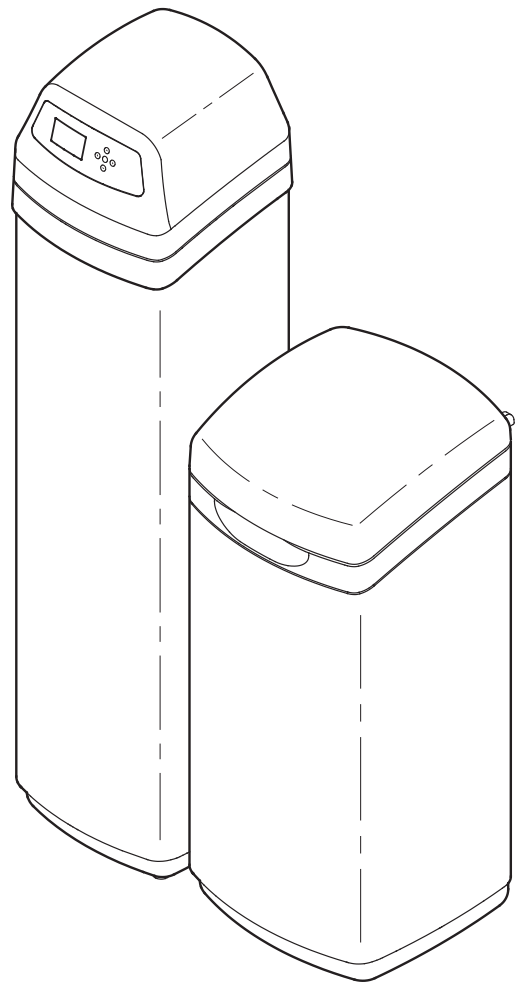

Models IDP30S & IDP40S tested and certified by NSF International against NSF/ANSI Standard 44 for hardness reduction and efficiency and the reduction of barium and radium 226/228, and certified to NSF/ANSI Standard 372.



Models IDP30S & IDP40S tested and certified by the Water Quality Association against CSA B483.1.



C US

* Models IDP40CC & IDP50CC have not been tested or certified by NSF International or the Water Quality Association.



Designed, Engineered &
Assembled in the U.S.A.

Manufactured by
Ecodyne Water Systems
1890 Woodlane Drive
Woodbury, MN 55125

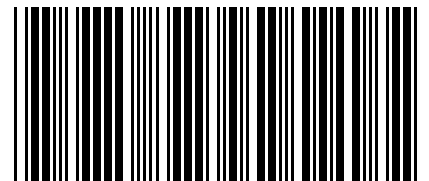

7371046 (Rev. B 9/1/18)

Table of Contents, Unpacking & Safety Guides

TABLE OF CONTENTS

	<u>Page</u>
Specifications	3
Performance Claims & Dimensions	4
Before Starting Installation	5
Typical Installation Illustrations	6
Installation	7-10
Sanitizing Procedure	10
Setup Procedure	11
Programming the Water Softener	12-25
Wiring Schematic	24
Adding Salt	26
Routine Maintenance	26-27
Service Information	23-24
Troubleshooting	28-31
Repair Parts	32-37
Warranty	38

UNPACKING

Models IDP30S, IDP40S and IDP40CC are shipped from the factory in one carton. The carton also includes a bag of small parts needed to assemble and install the unit.

Model IDP50CC is shipped from the factory in two cartons. One contains the resin tank/controller assembly, plus a bag of small parts needed to assemble and install the unit. The other carton contains the assembled brine tank.

Thoroughly check the water softener for possible shipping damage and parts loss. Also inspect and note any damage to the shipping carton.

Remove and discard (or recycle) all packing materials. To avoid loss of small parts, we suggest you keep the small parts in the parts bag until you are ready to use them.

SAFETY GUIDES

Follow the installation instructions carefully. Failure to install the water filtration system properly **voids the warranty**.

Before you begin installation, read this entire manual. Then, obtain all the materials and tools you will need to make the installation.

Check local plumbing and electrical codes. The installation must conform to them.

Use only lead-free solder and flux for all sweat-solder connections, as required by state and federal codes.

Use care when handling the water filtration system. Do not turn upside down, drop, or set on sharp protrusions.

Do not locate the water filtration system where freezing temperatures occur. Do not attempt to treat water over 120°F. **Freezing, or hot water damage voids the warranty.**

Avoid installing in direct sunlight. Excessive sun heat may cause distortion or other damage to non-metallic parts.

The water filtration system requires a minimum water pressure of 30 psi at the inlet. **Maximum allowable inlet water pressure is 125 psi.** If daytime pressure is over 80 psi, nighttime pressure may exceed the maximum. Use a pressure reducing valve if necessary (Adding a pressure reducing valve may reduce the flow).

The water filtration system works on **24V DC** electrical power, supplied by a direct plug-in power supply (included). Be sure to use the included power supply, and plug it into a nominal **120V, 60 Hz** household outlet that is in a **dry location only**, grounded and properly protected by an overcurrent device such as circuit breaker or fuse.

This system is not intended to be used for treating water that is microbiologically unsafe or of unknown quality without adequate disinfection before or after the system.



European Directive 2002/96/EC requires all electrical and electronic equipment to be disposed of according to Waste Electrical and Electronic Equipment (WEEE) requirements. This directive or similar laws are in place nationally and can vary from region to region. Please refer to your state and local laws for proper disposal of the equipment.

Specifications

These models are efficiency rated. The efficiency rating is valid only at the minimum salt dose and the service flow rate. The softeners have a demand initiated regeneration (D.I.R) feature that complies with specific performance specifications intended to minimize the amount of regenerant brine and water used in their operation.

These softeners have a rated softener efficiency of not less than 3,350 grains of total hardness exchange per pound of salt (based on sodium chloride) and shall not deliver more salt than their listed rating or be operated at a sustained maximum service flow rate greater than their listed rating. These softeners have been proven to deliver soft water for at least ten continuous minutes at the rated service flow rate. The rated salt efficiency is measured by laboratory tests described in NSF/ANSI Standard 44. These tests represent the maximum possible efficiency that the system can achieve. Operational efficiency is the actual efficiency after the system has been installed. It is typically less than the rated efficiency, due to individual application factors including water hardness, water usage, and other contaminants that reduce a softener's capacity.

While testing was performed under standard laboratory conditions, actual performance of the system may vary based on local water conditions.

SPECIFICATIONS				
Model	IDP30S	IDP40S	IDP40CC*	IDP50CC*
Model Code	ID30S	ID40S	ID40C	ID50C
Rated Softening Capacity (grains @ lb. salt dose)	12,000 @ 2.4 25,600 @ 7.5 30,600 @ 12.6	11,800 @ 2.4 31,600 @ 9.0 40,000 @ 15.5	11,800 @ 2.4 31,600 @ 9.0 40,000 @ 15.5	16,600 @ 3.3 44,300 @ 12.3 56,300 @ 21.3
Rated Efficiency (grains / lb. @ minimum salt dose)	5,090 @ 2.4	4,950 @ 2.4	4,980 @ 2.4	5,090 @ 3.3
Water Used During Regeneration @ Minimum Salt Dose	2.5 gal. / 1,000 grains	3.1 gal. / 1,000 grains	4.1 gal. / 1,000 grains	4.5 gal. / 1,000 grains
Amount of High Capacity Resin	0.79 cu. ft.	1.13 cu. ft.	1.13 cu. ft.	1.56 cu. ft.
Amount of Catalytic Carbon	–	–	0.40 cu. ft.	0.57 cu. ft.
Amount of Gravel	–	–	–	12 lbs.
Service Flow Rate	7.2 gpm	8.0 gpm	4.0 gpm	5.0 gpm
Pressure Drop at Rated Service Flow	15.0 psig	8.5 psig	10.0 psig	10.0 psig
Intermittent Flow @ 15 psi ▲	7.2 gpm	11.7 gpm	15.0 gpm	15.0 gpm
Intermittent Flow @ 30 psi ▲	11.0 gpm	18.1 gpm	21.0 gpm	21.0 gpm
Water Supply Maximum Hardness	50 gpg	65 gpg	65 gpg	85 gpg
Water Supply Maximum Clear Water Iron ■	6 ppm	8 ppm	8 ppm	10 ppm
Min. - Max. Water Supply Pressure ◆	20 - 125 psi			
Min. - Max. Water Supply Temperature	40 - 120 °F			
Minimum Water Supply Flow Rate	3 gpm			
Max Drain Flow Rate	2.0 gpm			

▲ Intermittent flow rate does not represent the maximum service flow rate used for determining the unit's rated capacity and efficiency. Continuous operation at flow rates greater than the service flow rate may affect capacity and efficiency performance.

■ Capacity to remove clear water iron is substantiated by independent laboratory test data. State of Wisconsin requires additional treatment if water supply contains greater than 5 ppm clear water iron.

◆ Canada working pressure limits: 1.4 - 7.0 kg/cm².

* Models IDP40CC & IDP50CC have not been tested or certified by NSF International or the Water Quality Association.

These units conform to NSF/ANSI 44 for the specific performance claims as verified and substantiated by test data.

Performance Claims & Dimensions

Test parameters include: pH = 7.5 ±0.5
 flow rate = 7.5 gpm
 dynamic pressure = 35 ±5 psig

PERFORMANCE CLAIMS		
Contaminant	Influent Challenge Level	Maximum Allowable Product Water Level
Barium	10 ±10% mg/L	2.0 mg/L
Radium 226/228	25 pCi/L	5 pCi/L

Models IDP40CC & IDP50CC have not been tested or certified by NSF International or the Water Quality Association.

MODELS IDP40CC & IDP50CC PERFORMANCE CLAIM		
Substance	Influent Challenge Level	Reduction Requirement
Chloramines	3 mg/L	>70% @ 10 gpm for 34,000 gal.*

* From manufacturer's test data.

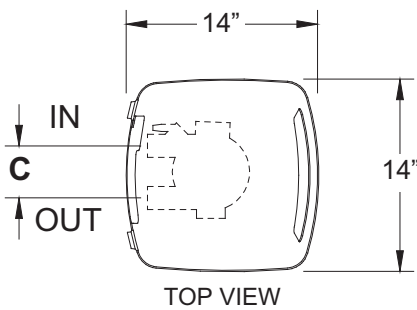

Model	Nominal Resin Tank Size	Dimension A	Dimension B	Dimension C
IDP30S	8" dia. x 40"	48-3/4"	42"	3-3/8"
IDP40S	10" dia. x 47"	56-3/4"	50"	3-3/4"
IDP40CC				
IDP50CC	12" dia. x 54"	62-1/2"	55-3/4"	3-3/4"

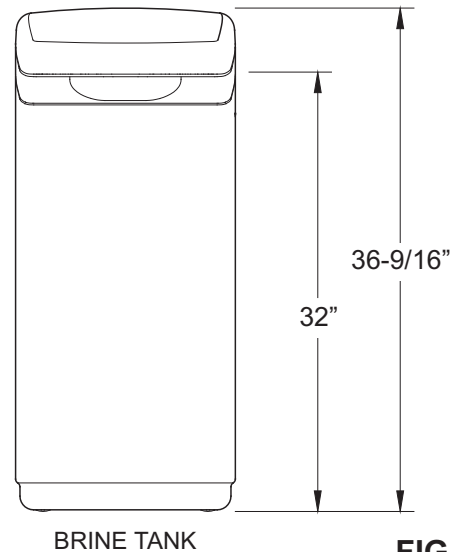
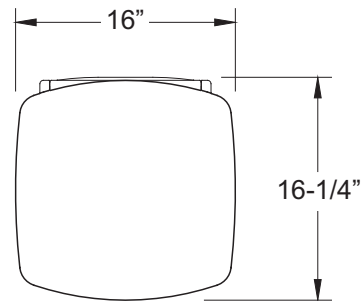
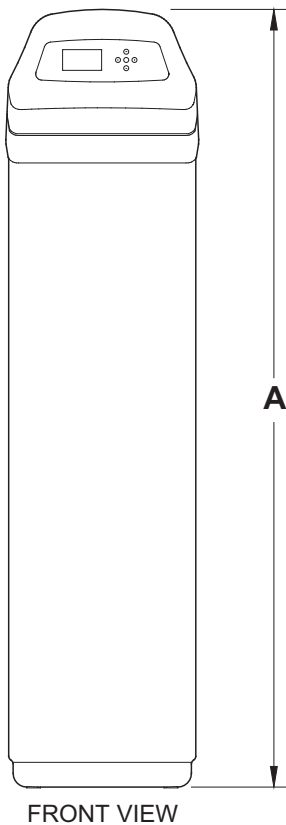
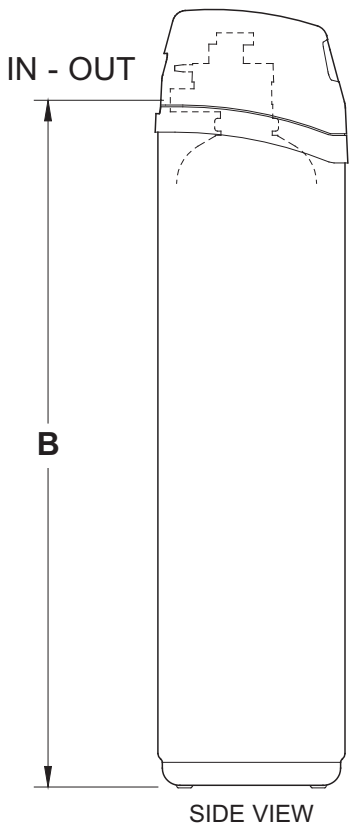

FIG. 1

Before Starting Installation

WHERE TO INSTALL THE SOFTENER

- To soften all water in the home, install the water softener close to the water supply inlet, upstream of all other plumbing connections, **except** outside water pipes. Outside faucets should remain on hard water to conserve salt and softening capacity.
- Place the softener near a floor drain, or other acceptable drain point (laundry tub, sump, stand-pipe, etc.) to carry away regeneration discharge water.
- Connect the softener to the main water supply pipe **UPSTREAM** of the water heater. **DO NOT RUN HOT WATER THROUGH THE SOFTENER.** The temperature of water passing through the softener must be less than 120°F.
- Do not install the softener in a place where it could freeze. Damage caused by freezing is not covered by the warranty.
- Put the softener in a place water damage is least likely to occur if a leak develops. The manufacturer will not repair or pay for water damage.
- A 120V, 60 Hz electrical outlet, to plug the included power supply into, is needed near the softener. Be sure the electrical outlet and power supply are in an inside location, to protect from wet weather.
- If installing in an outside location, you must take the steps necessary to assure the softener, installation plumbing, wiring, etc., are as well protected from the elements, contamination, vandalism, etc., as when installed indoors.
- Keep the softener out of direct sunlight. The sun's heat may soften and distort plastic parts.

TOOLS, PIPE & FITTINGS, OTHER MATERIALS YOU WILL NEED

- **ALWAYS** install a single bypass valve, or a 3-valve bypass system. Bypass valves let you turn off water to the softener for repairs if needed, but still have water available to the house pipes.
- Plastic inlet and outlet fittings are included with the softener, which allow water flow equivalent to 1 inch nominal pipe. To maintain maximum valve flow, 1" pipes to and from the softener fittings are recommended. Do not reduce the pipes to less than 3/4" size.
- Use copper, brass or PEX plastic pipe and fittings.
- Drain hose, 1/2" inside diameter minimum, is needed for the valve drain.
- If a rigid valve drain is needed, to comply with plumbing codes, you can buy the parts needed to connect a 1/2" minimum copper tubing drain.

NOTE: The Commonwealth of Massachusetts plumbing code 248-CMR shall be adhered to. A licensed plumber shall be used for this installation.

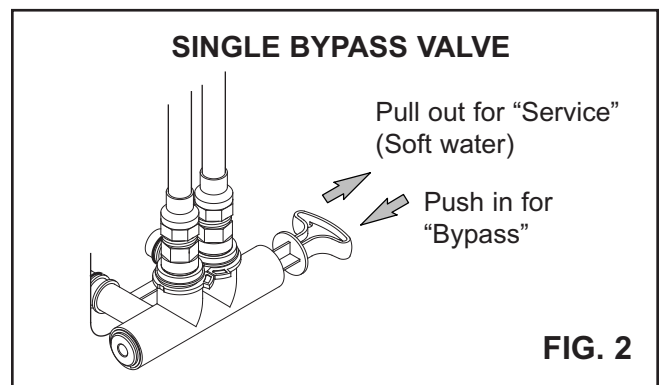

THE PROPER ORDER TO INSTALL WATER TREATMENT EQUIPMENT

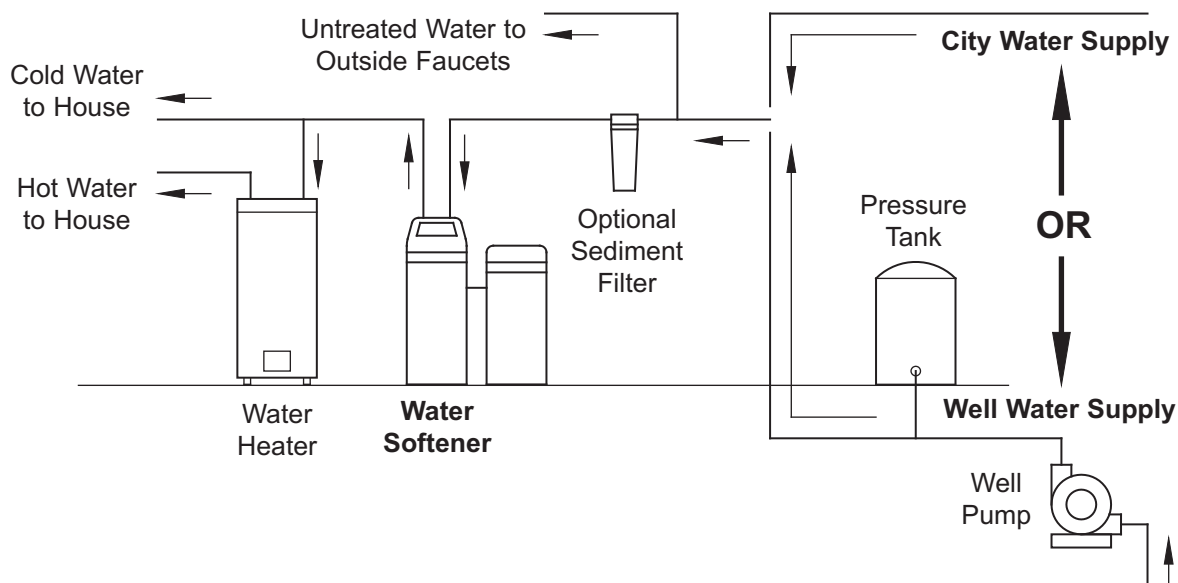

Typical Installation Illustrations

INSTALLATION USING SINGLE BYPASS VALVE

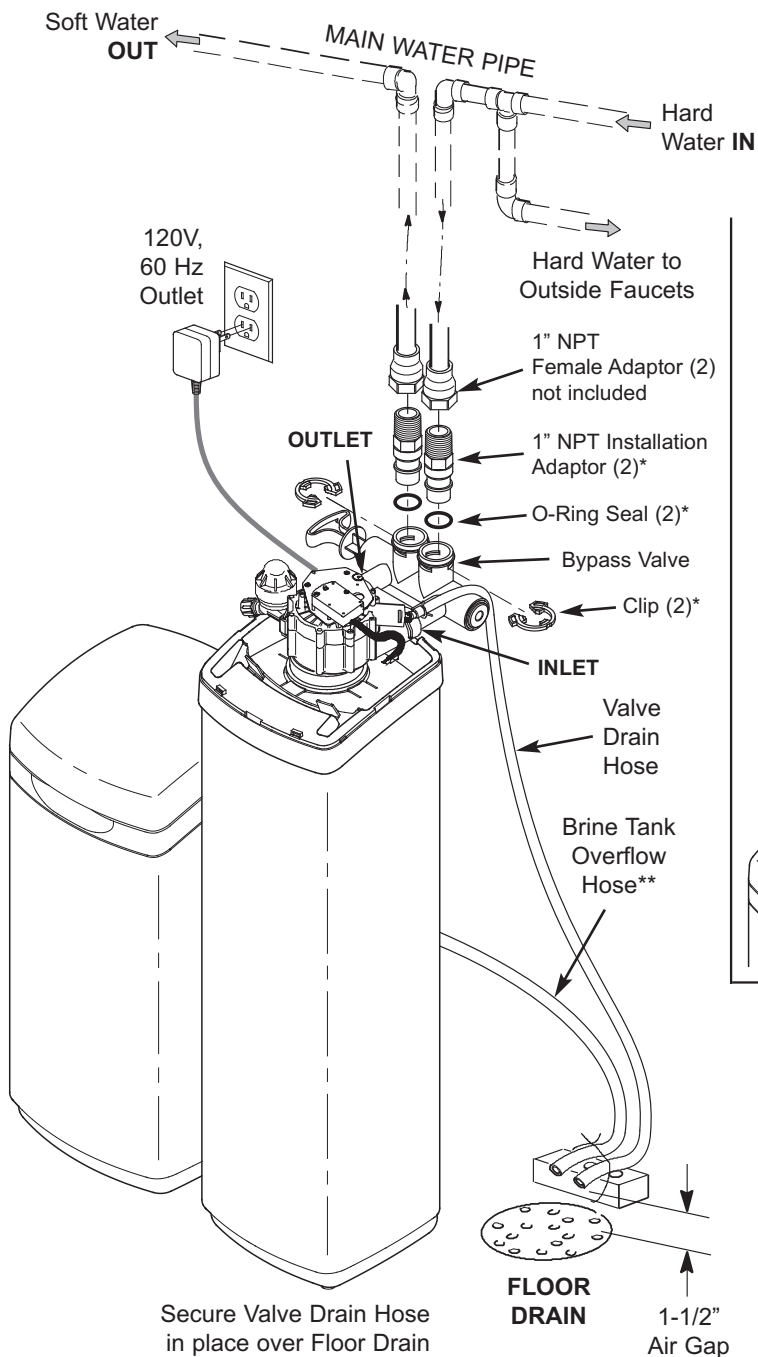

*Included with softener - Pipe and fittings supplied by installer.

**Do not connect the water softener valve drain hose to the brine tank overflow hose.

CROSS-OVER

Use if water supply flows from the left. Include single or 3-valve bypass.

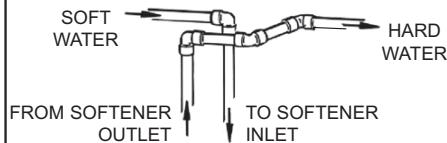

INSTALLATION USING 3-VALVE BYPASS

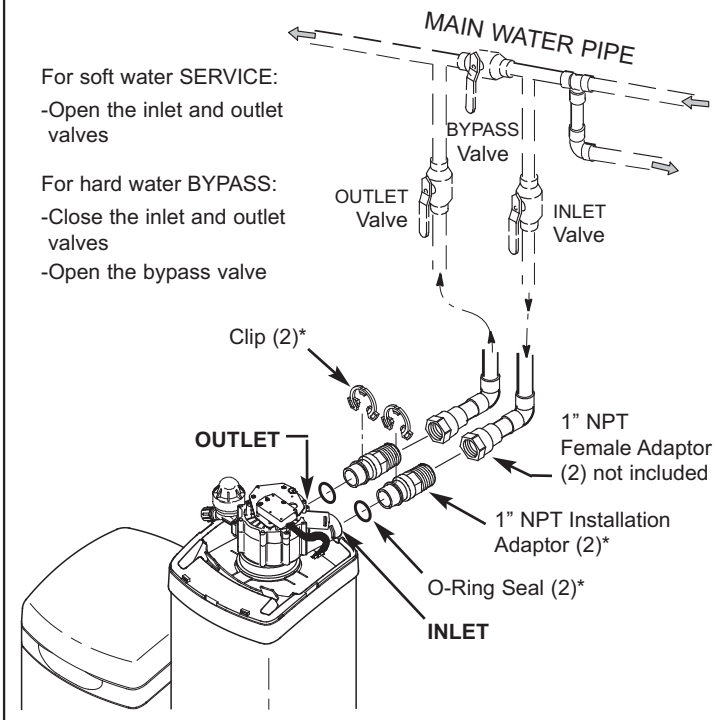

CONNECTING A RIGID VALVE DRAIN TUBE

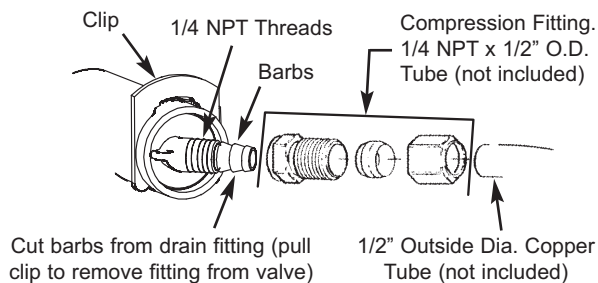

To standpipe, sump, laundry tub or other suitable drain.

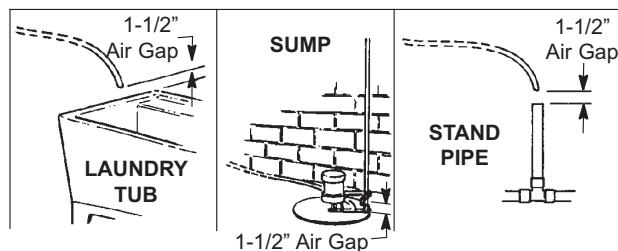

FIG. 4

Installation

1. TURN OFF WATER SUPPLY

- Close the main water supply valve near the well pump or water meter.
- Shut off the electric or fuel supply to the water heater.
- Open high and low faucets to drain all water from the house pipes.

2. INSTALL BYPASS VALVE AND/OR PLASTIC ADAPTORS:

- If installing a single bypass valve, push the bypass valve, with lubricated o-ring seals in place, into the valve inlet and outlet ports (See Figures 4 & 5).

- OR -

- If installing a 3-valve bypass system, slide plastic installation adaptors, with lubricated o-ring seals in place, into the valve inlet and outlet ports (See Figure 4 & 5).
- Be sure the turbine support is in place in the valve outlet, as shown in Figure 6.
- Snap the two large plastic clips in place on the inlet and outlet ports, from the top, down (See Figure 7). Be sure they snap into place. Pull on the bypass valve or plastic adaptors, to make sure they are held securely in place.

3. COMPLETE PLUMBING TO AND FROM THE SOFTENER

Using the "Typical Installation Illustration" on page 6 as a guide, observe all of the following cautions while you connect inlet and outlet plumbing:

- Be sure incoming, **hard water** is directed to the valve **INLET** port.
- Be sure to install bypass valve(s).
- If making a soldered copper installation, do all sweat soldering before connecting pipes to the softener fittings. Torch heat will damage plastic parts.
- Use pipe joint compound on all external pipe threads.
- When turning threaded pipe fittings onto plastic fittings, use care not to cross-thread.
- Support inlet and outlet plumbing in some manner (use pipe hangers) to keep the weight off of the valve fittings.

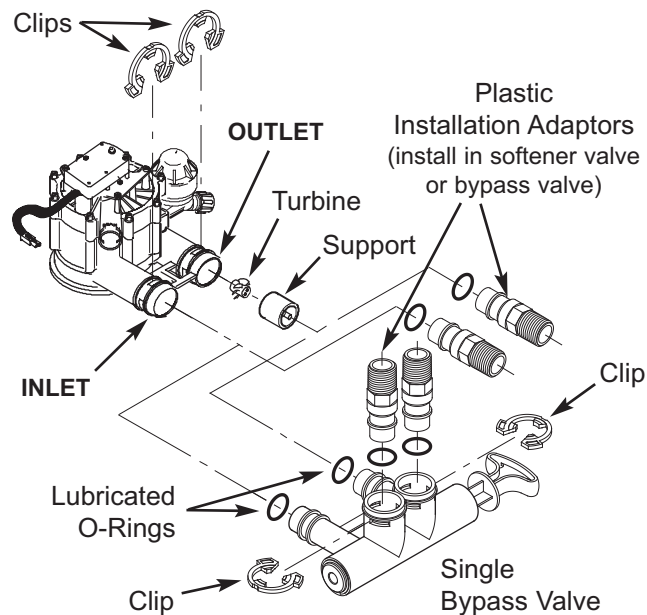

FIG. 5

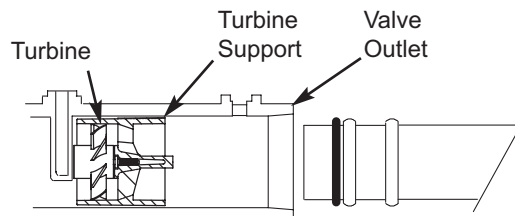

FIG. 6

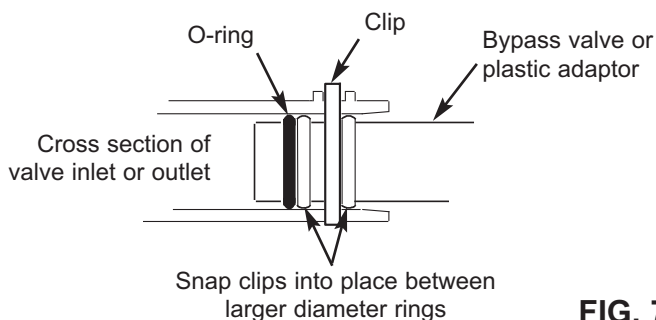
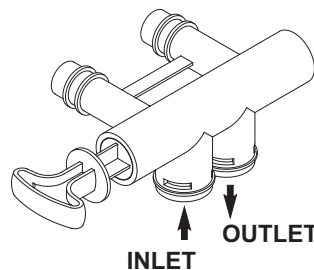

FIG. 7



Turn the bypass valve downward if connecting to floor level plumbing

FIG. 8

Installation

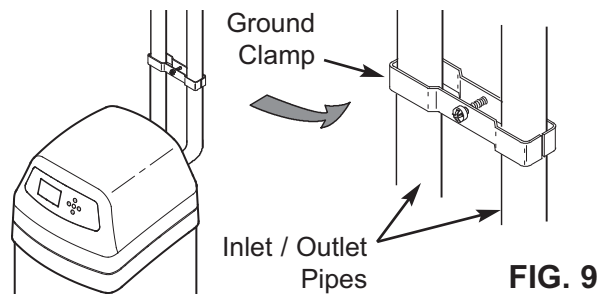

4. COLD WATER PIPE GROUNDING

The house cold water pipe (metal only) is often used as a ground for the house electrical system. The 3-valve bypass type of installation, shown in Figure 4, will maintain ground continuity. If you use the plastic bypass, continuity is broken. To restore the ground, do either step **4a** or **4b** following.

- a. Use the ground clamp kit (not included) to make a jumper across the inlet and outlet pipes (See Figure 9).
- b. Install a #4 copper wire across the removed section of main water pipe, securely clamping at both ends – parts not included.

5. INSTALL VALVE DRAIN HOSE

- a. Take a length of 1/2" inside diameter hose and attach to the valve drain fitting, securing it with a hose clamp (See Figure 4 on page 6).
- b. Locate the other end of the hose at a suitable drain point (floor drain, sump, laundry tub, etc.). Check and comply with local codes. Refer to Figure 4 if codes require a rigid pipe drain run.

IMPORTANT: Use high quality, thick wall hose that will not easily kink or collapse. The softener will not backwash properly if water cannot exit this hose during recharges.

- c. Tie or wire the hose in place at the drain point. Water pressure will cause it to whip during the backwash portion of the recharge cycle. Also provide an air gap of at least 1-1/2" between the end of the hose and the drain point. An air gap prevents possible siphoning of sewer water, into the softener, if the sewer should back up.
- d. If raising the drain hose overhead is required to get to the drain point, do not raise higher than 8 feet above the floor. Elevating the hose may cause a back pressure that could reduce backwash flow and proper resin bed cleaning.

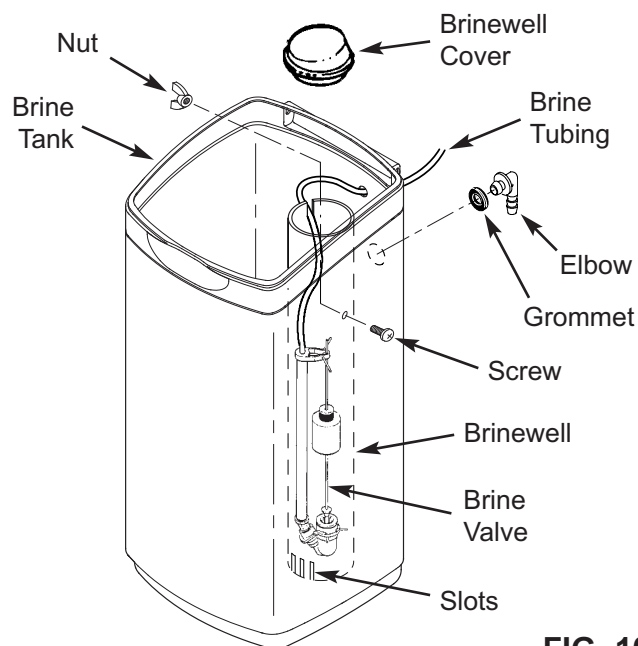

6. BRINE TANK ASSEMBLY

Complete the following steps for Models IDP30S, IDP40S and IDP40CC. For Model IDP50CC, shipped with an assembled brine tank, proceed to Step 7.

- a. Place the brine well into position in the brine tank, with the slots at the bottom, as shown in Figure 10. Align the mounting hole in the brine well with the corresponding hole in the tank wall. Then use the screw and nut from the parts bag to fasten the brine well in place.
- b. Lower the brine valve into the brine well. Push the tubing into the brine well top slot (Fig. 10) and route it out of the brine tank through the smaller hole in the rear wall of the brine tank.
- c. Install the brine well cover.

7. INSTALL BRINE TANK OVERFLOW HOSE

This drain is for safety only. If the brine tank should over-fill with water, the excess is carried to the drain.

- a. Take the rubber grommet and hose adaptor elbow from the parts bag. Push grommet into the corresponding hole in the back wall of the brine tank. Then insert the larger diameter end of the elbow through the grommet.
- b. Attach a length of 1/2" inside diameter hose to the drain elbow, installed in the previous step. Use a hose clamp to hold it in place.
- c. Locate the other end of the hose at the drain point. Do not elevate this hose higher than the elbow on the brine tank. Do not tee this hose to the valve drain hose.

Installation

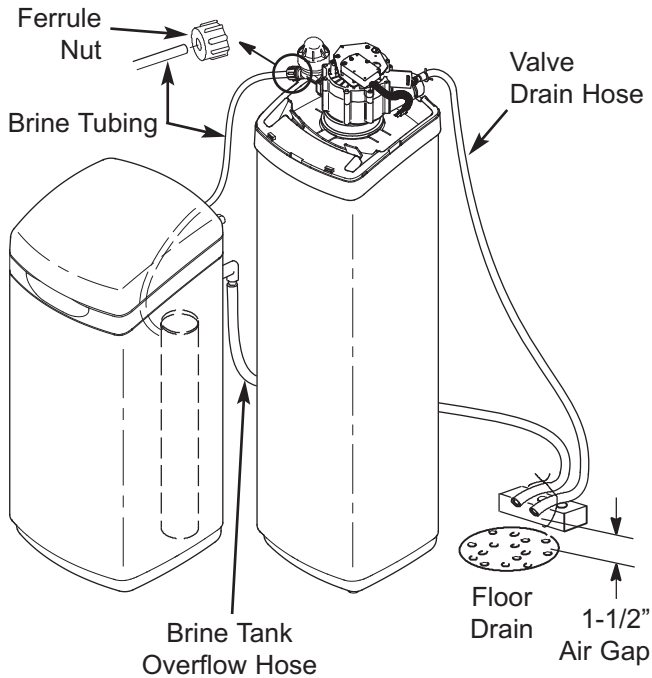

FIG. 11

8. CONNECT BRINE TUBING

- Route the brine tube out of the brine tank through the smaller hole in the tank back wall.
- Connect the brine tube to the nozzle/venturi assembly using the ferrule nut provided (See Figure 11).

9. PRESSURE TESTING FOR LEAKS, PROGRAMMING THE CONTROLLER & RINSING THE MEDIA

To prevent excessive air pressure in the water softener and plumbing system, do the following steps **EXACTLY** in order:

- Fully open two or more **softened** cold water faucets nearby the water softener.
- Place the bypass valve(s) in **bypass** position (See Figures 2 & 4).
- Fully open the main water supply valve. Watch until the flow from the opened faucets becomes steady, with no spurting or air bubbles.
- After about three minutes, open a hot water faucet for one minute, or until all air is expelled.
- Close all faucets and check your plumbing work for leaks.
- Make sure the softener's valve drain hose is hooked up and the open end directed to a floor drain, laundry tub or other suitable type of drain.

- Make sure the softener's bypass valve is in the **bypass** position.
- Plug in the power supply.
- Program the electronic controller:** Follow the steps on Page 11 to program the electronic controller with basic operating information, such as time and water hardness. After completing these steps, continue with "j. Start a recharge", below.
- Start a recharge:** From the rolling status screens, press the SELECT (O) button to display the **Main menu**. Make sure **Recharge** is highlighted, then press SELECT (O). Press DOWN (▼) to scroll to **Recharge now**, then press SELECT (O) twice. You should hear the valve motor run as the softener begins recharging.
- Once the unit is in backwash, place bypass valve(s) into the **service** position, as follows:
 - SINGLE BYPASS VALVE:** **Slowly** move the valve stem toward **service** position, pausing several times to allow the unit to pressurize slowly.
 - 3-VALVE BYPASS:** Fully close the **bypass** valve and open the **outlet** valve. **Slowly** open the **inlet** valve, pausing several times to allow the unit to pressurize slowly.
- Let the softener complete the backwash and fast rinse cycles (takes 10-12 minutes). When the recharge cycle ends, the softener valve returns to the service position.

10. ADD WATER AND SALT TO THE BRINE TANK

- Using a pail or garden hose, add about 3 gallons of water into the brine tank. **DO NOT** pour into the brinewell.
- Add salt to the brine tank. It is recommended to fill the brine tank no more than 1/2 full. Level the salt when finished adding. You can use most water softener salts, but it must be clean. Recommended nugget, pellet or coarse solar salts have less than 1% impurities.

NOTE: See page 26 for additional information on salt.

Installation & Sanitizing

11. SANITIZING THE WATER SOFTENER

Care is taken at the factory to keep your water softener clean and sanitary. However, during shipping, storage, installing and operating, bacteria could get into the unit. For this reason, sanitizing as follows is suggested* when installing.

- a. Remove the brinewell cover and pour about 1-1/2 oz. (2 to 3 tablespoons) of common household bleach into the softener's brinewell. Replace the brinewell cover.
- b. Make sure the bypass valve is in the **service** position.
- c. **Start a recharge:** From the rolling status screens, press the SELECT (○) button to display the **Main menu**. Make sure **Recharge** is highlighted, then press SELECT (○). Press DOWN (▼) to scroll to **Recharge now**, then press SELECT (○) twice. You should hear the valve motor run as the softener begins recharging. This recharge draws the sanitizing bleach into and through the softener. Any air remaining in the unit is purged to the drain.
- d. After the recharge has completed, fully open a cold water faucet, downstream from the softener, and allow 50 gallons of water to pass through the system. This should take at least 20 minutes. Close the faucet.

12. RESTART THE WATER HEATER

Turn on the electric or fuel supply to the water heater, and light the pilot, if applies.

NOTE: The water heater is filled with hard water and, as hot water is used, it refills with softened water. In a few days, the hot water will be fully conditioned. To have fully conditioned hot water immediately, wait until the recharge (Step 11) is complete, then drain the water heater until water runs cold.

***NOTE:** Sanitizing is recommended by the Water Quality Association for disinfecting. On some water supplies, they suggest periodic sanitizing.

Setup Procedure

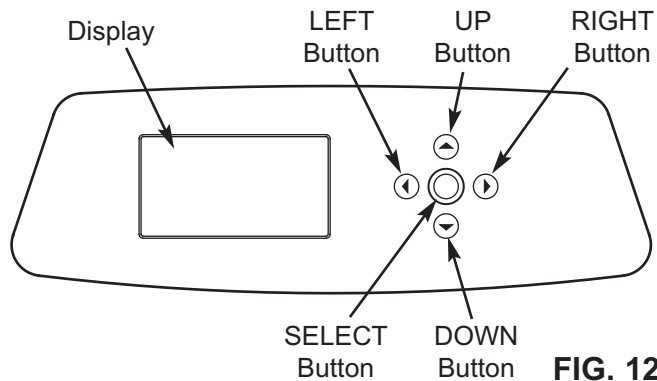

6. Press the SELECT (O) button.

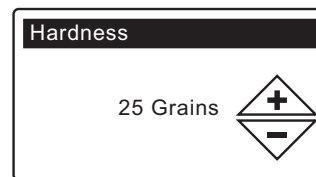

FIG. 16

7. **HARDNESS** Press the UP (▲) or DOWN (▼) buttons to set the value of your water's hardness (See Figure 16).

NOTE: Do not increase the hardness setting to compensate for iron in your water. The electronic control compensates automatically after you set the iron level in Step 11, below.

8. Press the SELECT (O) button.

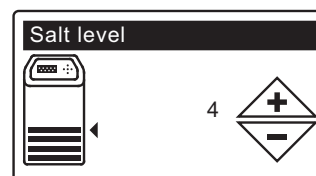

FIG. 17

9. **SALT LEVEL** Press the UP (▲) or DOWN (▼) buttons to set the salt level (See Figure 17). It should match the lowest number visible on the brinewell above the salt.

10. Press the SELECT (O) button.

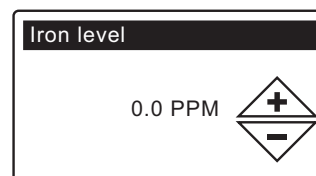

FIG. 18

11. **IRON LEVEL** Press the UP (▲) or DOWN (▼) buttons to set the value for iron in your water (See Figure 18)

12. Press the SELECT (O) button. The screen will show "Setup complete!" (See Figure 19).

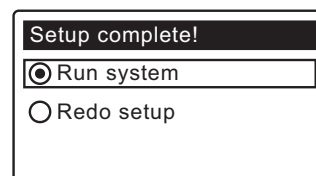

FIG. 19

13. If, at this point, you want to go back and make changes, press the DOWN (▼) button to scroll to **Redo setup**, then press the SELECT (O) button twice to repeat the "wizard" screens.

14. If no changes are desired, make sure **Run system** has a black dot next to it (See Figure 19) and press the SELECT (O) button. The unit begins normal operation, described on the next page.

SETUP PROCEDURE

When the water softener is plugged in for the first time, a beep sounds and the display briefly shows model information. Next, a series of "wizard" screens prompts you to enter basic operating information:

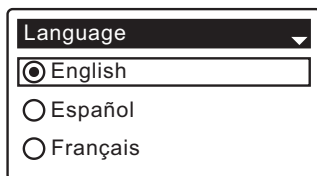

FIG. 13

1. **LANGUAGE** If the desired language already has a black dot next to it (See Figure 13), go to Step 2. Otherwise, press the softener's DOWN (▼) or UP (▲) buttons to scroll to the desired language, then press the SELECT (O) button to choose it.

2. Press the SELECT (O) button to advance to the next "wizard" screen.

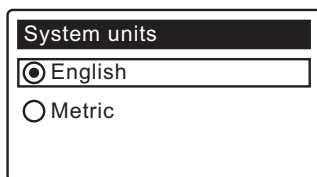

FIG. 14

3. **SYSTEM UNITS** If the desired system already has a black dot next to it (See Figure 14), go to Step 4. Otherwise, press the DOWN (▼) or UP (▲) buttons to scroll to the desired system, then press the SELECT (O) button to choose it.

4. Press the SELECT (O) button.

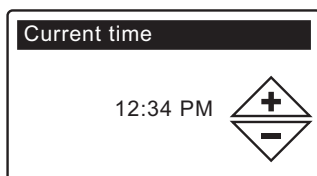

FIG. 15

5. **CURRENT TIME** Press the DOWN (▼) or UP (▲) buttons to set the current time (See Figure 15). Hold the button down to rapidly advance. Be sure that AM or PM is correct. If the system units were set to metric in Step 3, the clock will be in 24-hour format.

Programming the Water Softener

NORMAL OPERATION

SOFTENER STATUS SCREENS

During normal operation, the water softener's display shows up to four status screens. Page 18 explains how individual screens can be turned on or off. Each is shown for six seconds, in a rolling sequence (See Figure 20).

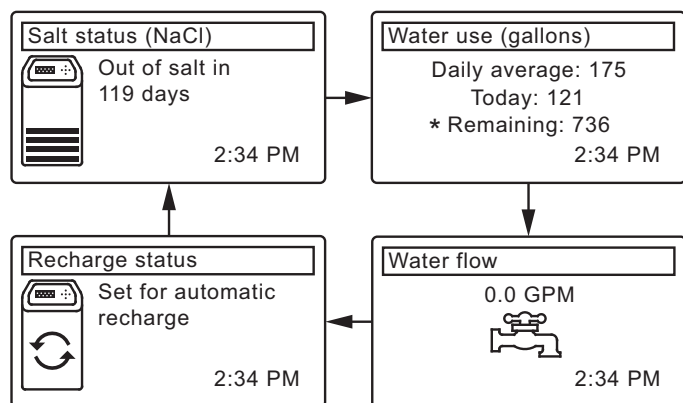

*Water remaining before the next recharge.

FIG. 20

Pressing the softener's RIGHT (▶) button manually advances to the next screen in the sequence. Pressing the LEFT (◀) button manually returns to the previous status screen. If no buttons are pressed for 30 seconds, the automatic rolling sequence resumes.

OTHER MESSAGES, ALERTS & REMINDERS

The softener status screens described in the previous section will not be displayed in a rolling sequence when one of the following items is displayed:

- **Recharge status** (Displayed during recharges, showing valve position and time remaining)
- **Add salt or Out of salt** (See Page 26)
- **Current time** setting screen instead of status screens indicates time has been lost, perhaps after a long power loss. Set the time (See Page 16).
- **Service reminder** (See Page 24)
- **Error detected** (Contact your dealer for service)

FLASHING DISPLAY

The softener's display will flash on and off when one or more of the following conditions occurs:

- Salt needs to be added
- Time needs to be set (Time has been lost)
- Service is overdue (Service reminder)
- Error condition

The flashing will stop after any key is pressed. However, it will start again at Midnight if the underlying condition (e.g. low salt level) has not been addressed.

LONG DISPLAY SCREEN MESSAGES

Most messages in the softener's display screens are short enough to be shown as a single line. Longer messages will be truncated (See Figure 21 for an example) until you highlight them.

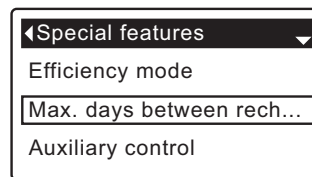

FIG. 21

One second after being highlighted, the viewing box expands (See Figure 22) to show the entire message. After three seconds the view resets (Figure 21).

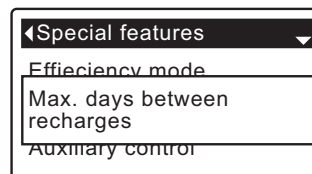

FIG. 22

Programming the Water Softener

MAIN MENU

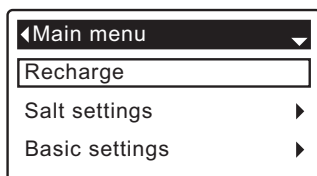

FIG. 23

During normal operation (status screens rolling), press the softener's SELECT (O) button to display the Main menu (See Figure 23). This menu and its subsidiary screens are used to control these operations:

- **Recharge** (See Page 16)
- **Salt settings**
 - Salt level (See Page 15)
 - Low salt alarm (See Page 15)
 - Salt type (See Page 15)
- **Basic settings**
 - Current time (See Page 16)
 - Hardness (See Page 17)
 - Iron level (See Page 17)
 - Recharge time (See Page 17)
 - Rolling screens (See Page 18)
- **User preferences**
 - Language (See Page 18)
 - Time format (See Page 19)
 - Volume units (See Page 19)
 - Hardness units (See Page 19)
 - Weight units (See Page 19)
- **System information**
 - Model information (See Page 20)
 - Water available (See Page 20)
 - Daily avg. water used (See Page 20)
 - Water used today (See Page 20)
 - Total water used (See Page 20)
 - Current water flow (See Page 20)
 - Days powered up (See Page 20)
 - Last recharge (See Page 20)
 - Total recharges (See Page 20)
- **Advanced settings**
 - **Cycle times**
 - Backwash time (See Page 21)
 - 2nd backwash (On/Off) (See Page 21)
 - 2nd backwash time (See Page 21)
 - Fast rinse time (See Page 21)
 - **Special features**
 - Efficiency mode (See Page 22)
 - Max. days between recharges (See Page 22)
 - Auxiliary control (See Page 23)
 - Chemical feed volume* (See Page 23)
 - Chemical feed timer* (See Page 23)
 - 97% feature (See Page 22)
 - Service reminder (See Page 24)
 - **Troubleshooting**
 - Diagnostics (See Page 25)
 - Setup changes (See Page 25)

* Only displayed if Auxiliary control is set to Chemical feed.

Programming the Water Softener

LOCKOUT FEATURE

A “lockout” feature is available to prevent user modification of parameters that affect softener performance. The unit is shipped from the factory with the lockout feature off. After programming is complete, the lockout feature can be turned on to prevent changes to the following:

- **Hardness**
- **Iron level**
- **Backwash time**
- **Second backwash (On/Off)**
- **Second backwash time**
- **Fast rinse time**
- **Efficiency mode**
- **Max days between recharges**
- **Auxiliary control**
- **Chemical feed volume**
- **Chemical feed timer**
- **97% feature**
- **Service reminder**
- **Setup changes**

To turn on the lockout feature:

1. From any of the rolling status screens, press the SELECT (O) button to display the **Main menu**.
2. Press the DOWN (▼) button to scroll through the menu options until **Advanced settings** is highlighted.
3. Press the SELECT (O) button to display the **Advanced settings** menu.
4. Press the DOWN (▼) button to scroll through the menu options until **Troubleshooting** is highlighted.
5. Press the SELECT (O) button to display the **Troubleshooting** menu.
6. Press the DOWN (▼) button to scroll through the menu options until **Setup changes** is highlighted.
7. Press the SELECT (O) button to display the **Setup changes** menu (See Figure 24).

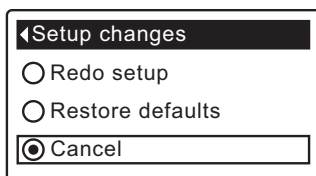

FIG. 24

8. Press the RIGHT (▶) button. A flashing padlock icon will appear, as shown in Figure 25.

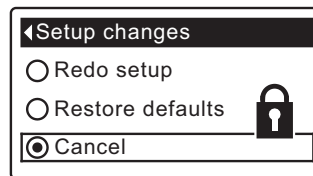

FIG. 25

9. Press the SELECT (O) button.
10. Press the LEFT (◀) button three times to return to the rolling status screens.

When the lockout feature is on, the flashing padlock icon will appear in any screen that would normally be used to change a parameter in the list to the left. For example, the **Hardness** screen will look like Figure 27, instead of Figure 26.

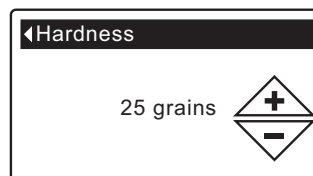

FIG. 26

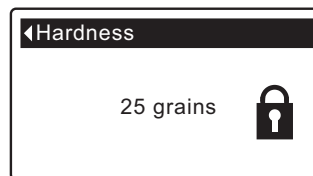

FIG. 27

Another indicator that the lockout feature is on is the **Model Information** screen. This screen appears on power-up, and can also be displayed from the System Information menu (See Page 20). If the lockout feature is on, there will be a non-flashing padlock icon in the upper right corner (See Figure 28).

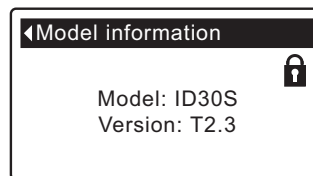

FIG. 28

To turn off the lockout feature:

- 1-7. Go to the **Setup changes** screen (Figure 25) by following Steps 1-7 at left.
8. Press the RIGHT (▶) button. The flashing padlock icon will disappear, as shown in Figure 24.
9. Press the SELECT (O) button.
10. Press the LEFT (◀) button three times to return to the rolling status screens.

Programming the Water Softener

SETTING SALT LEVEL

Use this feature when adding salt to the softener.

1. From any of the rolling status screens, press the SELECT (O) button to display the **Main menu**.
2. Press the DOWN (▼) button to scroll through the menu options until **Salt settings** is highlighted (See Figure 29).

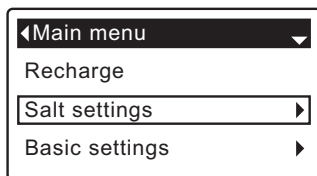

FIG. 29

3. Press the SELECT (O) button to display the Salt settings menu (See Figure 30).

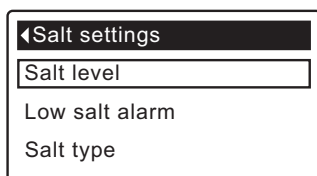

FIG. 30

4. Make sure **Salt level** is highlighted.
5. Press the SELECT (O) button to display the Salt level screen (See Figure 31). This screen will not automatically exit for 15 minutes.

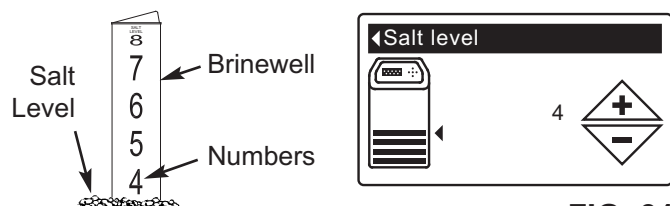

FIG. 31

6. After adding and leveling salt, observe the numbered scale on the brinewell (See Figure 31). Press UP (▲) or DOWN (▼) to change the salt level to match the lowest number visible above the salt.
7. Press the SELECT (O) button. The display will go back to the Salt settings menu (Figure 30).
8. Press the LEFT (◀) button twice to return to the rolling status screens. It will also exit automatically if no buttons are pressed for four minutes.

LOW SALT ALARM

Use this feature to program when the electronic control will display a low salt alarm. The number of days can be customized, or the feature can be turned off. The default is 20 days.

- 1-3. Go to the **Salt settings** menu by following Steps 1-3 in “Setting Salt Level” at left.
4. Press the DOWN (▼) button to scroll through the menu options until **Low salt alarm** is highlighted.
5. Press the SELECT (O) button to display the Low salt alarm screen (See Figure 32).

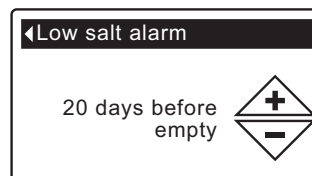

FIG. 32

6. Press the UP (▲) or DOWN (▼) buttons to change the number of days. Set the number of days to provide enough time to purchase salt and avoid running into hard water. Setting the number of days below 1 turns the alarm feature off.
7. Press the SELECT (O) button. The display will go back to the Salt settings menu.
8. Press the LEFT (◀) button twice to return to the rolling status screens.

SETTING SALT TYPE

Use this feature to program the electronic control with which type of salt is used. The default is NaCl. Selecting KCl increases fill time 25% and brine/slow rinse times 12%.

- 1-3. Go to the **Salt settings** menu by following Steps 1-3 in “Setting Salt Level” at left.
4. Press the DOWN (▼) button to scroll through the menu options until **Salt type** is highlighted.
5. Press the SELECT (O) button to display the Salt type menu (See Figure 33).

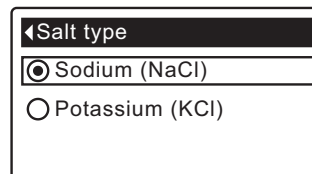

FIG. 33

6. If the desired salt type already has a black dot next to it (See Figure 33), go to Step 7. Otherwise, press the softener’s DOWN (▼) or UP (▲) buttons to scroll to the other salt type, then press SELECT (O) to choose it.
7. Press the SELECT (O) button. The display will go back to the Salt settings menu.
8. Press the LEFT (◀) button twice to return to the rolling status screens.

Programming the Water Softener

RECHARGING THE SOFTENER

This feature may be used to assure an adequate supply of softened water at times of unusually high water use. For example, if you have guests and the “Water available” screen (See Page 20) is at or below 50%, you could deplete softened water capacity before the next automatic recharge. Initiating a manual recharge will restore 100% softened water capacity after complete.

1. From any of the rolling status screens, press the SELECT (O) button to display the **Main menu**.

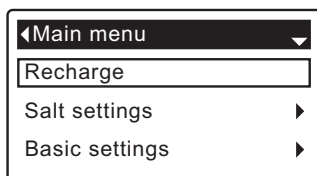

FIG. 34

2. Make sure **Recharge** is highlighted (See Figure 34).
3. Press the SELECT (O) button to display the Recharge menu (See Figure 35).

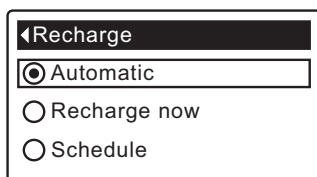

FIG. 35

4. If the desired option already has a black dot next to it (See Figure 35), go to Step 5. Otherwise, press the DOWN (▼) or UP (▲) buttons to scroll to the desired option, then press SELECT (O) to choose it.

- **Automatic** cancels a manually scheduled recharge (if it has not already begun) and lets the electronic control determine when to recharge next.

- **Recharge now** begins a recharge immediately after the SELECT (O) button is pushed again in Step 5.

- **Schedule** sets a recharge to begin at the preset recharge time (set according to the instructions on Page 17).

5. Press the SELECT (O) button. If **Recharge now** is selected, the display immediately goes to the Recharge status screen (See Figure 36). If **Automatic** or **Schedule** are selected, the display goes back to the Main menu (Figure 34).

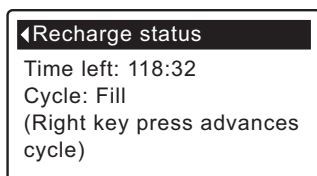

FIG. 36

6. Press the LEFT (◀) button (twice from the Recharge status screen) to return to the rolling status screens.

SETTING THE CURRENT TIME

When the softener's electronic control is first powered up, a “wizard” screen prompts you to set the current time (See Page 11). To change the time at a later date, such as after a long power loss:

1. From any of the rolling status screens, press the SELECT (O) button to display the **Main menu**.
2. Press the DOWN (▼) button to scroll through the menu options until **Basic settings** is highlighted (See Figure 37).

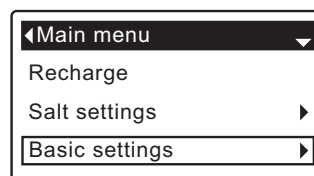

FIG. 37

3. Press the SELECT (O) button to display the Basic settings menu (See Figure 38).

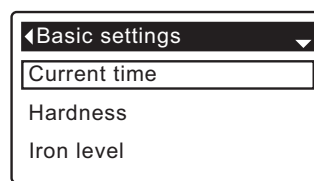

FIG. 38

4. Make sure **Current time** is highlighted.
5. Press the SELECT (O) button to display the Current time screen (See Figure 39).

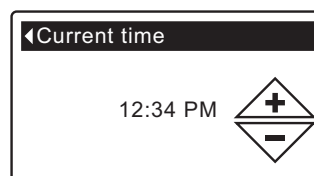

FIG. 39

6. Press the UP (▲) or DOWN (▼) buttons to change the time. Hold the button down to rapidly advance. Be sure that AM or PM is correct (unless softener is set for a 24-hour clock).
7. Press the SELECT (O) button. The display will go back to the Basic settings menu (Figure 38).
8. Press the LEFT (◀) button twice to return to the rolling status screens.

Programming the Water Softener

SETTING RECHARGE TIME

When the softener's electronic control is first powered up, the default time for starting an automatic recharge is 2:00 a.m. This is a good time in most households because water is not being used. To change this time:

1. From any of the rolling status screens, press the SELECT (O) button to display the **Main menu**.
2. Press the DOWN (▼) button to scroll through the menu options until **Basic settings** is highlighted (See Figure 40).

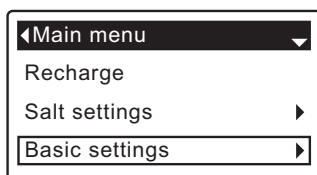

FIG. 40

3. Press the SELECT (O) button to display the Basic settings menu (See Figure 41).

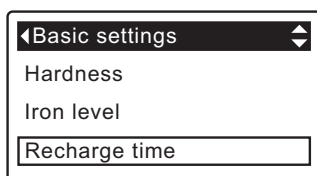

FIG. 41

4. Press the DOWN (▼) button to scroll through the menu options until **Recharge time** is highlighted.
5. Press the SELECT (O) button to display the Recharge time screen (See Figure 42).

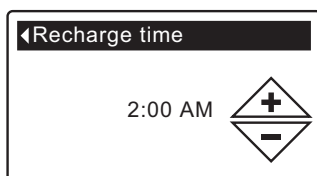

FIG. 42

6. Press the UP (▲) or DOWN (▼) buttons to change the recharge time in 1 hour increments. Hold the button down to rapidly advance. Be sure that AM or PM is correct (unless softener is set for a 24-hour clock).
7. Press the SELECT (O) button. The display will go back to the Basic settings menu (Figure 41).
8. Press the LEFT (◀) button twice to return to the rolling status screens.

SETTING HARDNESS

When the softener's electronic control is first powered up, a "wizard" screen prompts you to enter your water's hardness (See Page 11). To change it:

- 1-3. Go to the **Basic settings** menu by following Steps 1-3 in "Setting Recharge Time" at left.
4. Press the DOWN (▼) button to scroll through the menu options until **Hardness** is highlighted.
5. Press the SELECT (O) button to display the Hardness screen (See Figure 43).

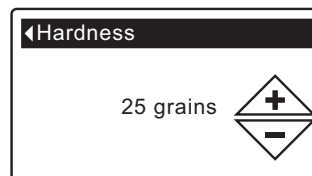

FIG. 43

6. Press the UP (▲) or DOWN (▼) buttons to set the value for your water's hardness. Hold the button down to rapidly advance.

NOTE: Do not increase the hardness setting to compensate for iron in your water. The electronic control compensates automatically after you set the iron level, below.

7. Press the SELECT (O) button. The display will go back to the Basic settings menu.
8. Press the LEFT (◀) button twice to return to the rolling status screens.

SETTING IRON LEVEL

When the softener's electronic control is first powered up, a "wizard" screen prompts you to enter your water's iron level (See Page 11). To change:

- 1-3. Go to the **Basic settings** menu by following Steps 1-3 in "Setting Recharge Time" at left.
4. Press the DOWN (▼) button to scroll through the menu options until **Iron level** is highlighted.
5. Press the SELECT (O) button to display the Iron level screen (See Figure 44).

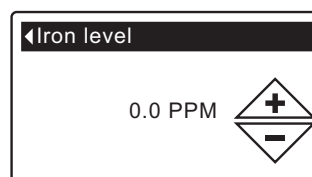

FIG. 44

6. Press the UP (▲) or DOWN (▼) buttons to set the value for iron in your water. Hold the button down to rapidly advance.
7. Press the SELECT (O) button. The display will go back to the Basic settings menu.
8. Press the LEFT (◀) button twice to return to the rolling status screens.

Programming the Water Softener

MODIFYING ROLLING SCREENS

During normal softener operation, up to five status screens are shown in sequence (See “Softener Status Screens” on Page 12). When the softener’s electronic control is first powered up, the default is to show all four. You can turn on/off individual screens*:

1. From any of the rolling status screens, press the SELECT (O) button to display the **Main menu**.
2. Press the DOWN (▼) button to scroll through the menu options until **Basic settings** is highlighted (See Figure 45).

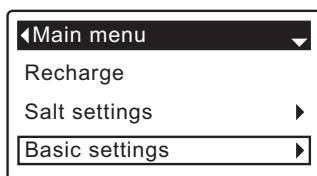

FIG. 45

3. Press the SELECT (O) button to display the Basic settings menu (See Figure 46).

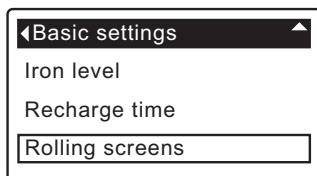

FIG. 46

4. Press the DOWN (▼) button to scroll through the menu options until **Rolling screens** is highlighted.
5. Press the SELECT (O) button to display the Rolling screens menu (See Figure 47).

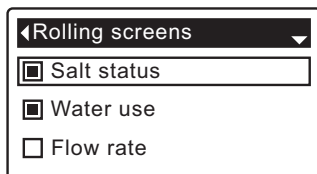

FIG. 47

6. Press the DOWN (▼) or UP (▲) buttons to scroll through the list. Items with a black square next to them will be displayed during normal operation.
7. To un-select a screen, make sure its name is highlighted in a box. Then press the SELECT (O) button. The black square will disappear. Pressing SELECT (O) again makes the black square reappear and re-selects the highlighted item. At least one screen must be selected/highlighted.
8. When selections are complete, exit this menu by pressing the LEFT (◀) button. The display will go back to the Basic settings menu (Figure 46).
9. Press the LEFT (◀) button twice to return to the rolling status screens.

*This does not include service reminders, errors, alerts or Recharge status screens.

SETTING THE LANGUAGE

When the softener’s electronic control is first powered up, a “wizard” screen prompts you to set the language (See Page 11). To change the language:

1. From any of the rolling status screens, press the SELECT (O) button to display the **Main menu**.
2. Press the DOWN (▼) button to scroll through the menu options until **User preferences** is highlighted (See Figure 48).

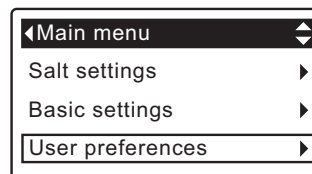

FIG. 48

3. Press the SELECT (O) button to display the User preferences menu (See Figure 49).

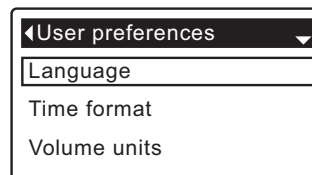

FIG. 49

4. Make sure **Language** is highlighted.
5. Press the SELECT (O) button to display the Language menu (See Figure 50).

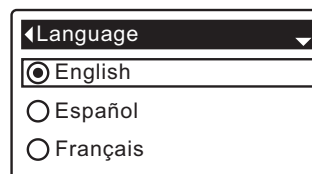

FIG. 50

6. If the desired language already has a black dot next to it (See Figure 50), go to Step 7. Otherwise, press the DOWN (▼) or UP (▲) buttons to scroll to the desired language, then press SELECT (O) to choose it. The choices are: English, Spanish, French, Italian, German, Dutch, Polish, Russian, Hungarian, Turkish, Lithuanian, Greek, Romanian, Czech, Slovak, Bulgarian, Serbian or Croatian.
7. Press the SELECT (O) button. The display will go back to the User preferences menu (Figure 49).
8. Press the LEFT (◀) button twice to return to the rolling status screens.

TO SET THE SOFTENER TO ENGLISH IF ANOTHER LANGUAGE IS DISPLAYED:

From the rolling status screens, press SELECT (O). Press DOWN (▼) three times, then press SELECT (O) twice. Press UP (▲) to scroll to **English** at the top of the list, then press SELECT (O) twice. Press LEFT (◀) twice to exit all menus.

Programming the Water Softener

SETTING TIME FORMAT

Use this feature to select a 12-hour (AM/PM) or 24-hour clock.

1. From any of the rolling status screens, press the SELECT (O) button to display the **Main menu**.
2. Press the DOWN (▼) button to scroll through the menu options until **User preferences** is highlighted.
3. Press the SELECT (O) button to display the User preferences menu.
4. Press the DOWN (▼) button to scroll through the menu options until **Time format** is highlighted.
5. Press the SELECT (O) button to display the Time format menu (See Figure 51).

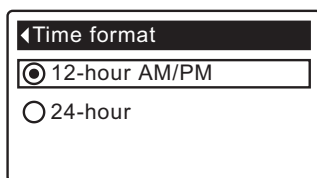

FIG. 51

6. If the desired time format already has a black dot next to it (See Figure 51), go to Step 7. Otherwise, press the DOWN (▼) or UP (▲) buttons to scroll to the other time format, then press SELECT (O) to choose it.
7. Press the SELECT (O) button. The display will go back to the User preferences menu.
8. Press the LEFT (◀) button twice to return to the rolling status screens.

SETTING VOLUME UNITS

Use this feature to select gallons or liters as volume units.

- 1-3. Go to the **User preferences** menu by following Steps 1-3 in "Setting Time Format" above.
4. Press the DOWN (▼) button to scroll through the menu options until **Volume units** is highlighted.
5. Press the SELECT (O) button to display the Volume units menu (See Figure 52).

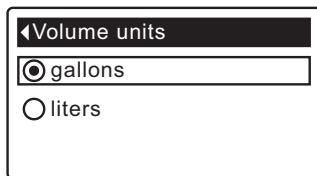

FIG. 52

6. If the desired volume unit already has a black dot next to it (See Figure 52), go to Step 7. Otherwise, press the DOWN (▼) or UP (▲) buttons to scroll to the other volume unit, then press SELECT (O) to choose it.
7. Press the SELECT (O) button. The display will go back to the User preferences menu.
8. Press the LEFT (◀) button twice to return to the rolling status screens.

SETTING HARDNESS UNITS

Use this feature to select grains or parts per million (ppm) as hardness units.

1. From any of the rolling status screens, press the SELECT (O) button to display the **Main menu**.
2. Press the DOWN (▼) button to scroll through the menu options until **User preferences** is highlighted.
3. Press the SELECT (O) button to display the User preferences menu.
4. Press the DOWN (▼) button to scroll through the menu options until **Hardness units** is highlighted.
5. Press the SELECT (O) button to display the Hardness units menu (See Figure 53).

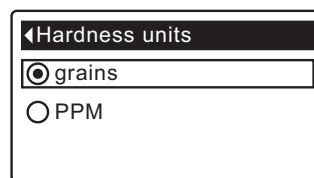

FIG. 53

6. If the desired hardness unit already has a black dot next to it (See Figure 53), go to Step 7. Otherwise, press the DOWN (▼) or UP (▲) buttons to scroll to the other hardness unit, then press SELECT (O) to choose it.
7. Press the SELECT (O) button. The display will go back to the User preferences menu.
8. Press the LEFT (◀) button twice to return to the rolling status screens.

SETTING WEIGHT UNITS

Use this feature to select pounds or kilograms as weight units.

- 1-3. Go to the **User preferences** menu by following Steps 1-3 in "Setting Hardness Units" above.
4. Press the DOWN (▼) button to scroll through the menu options until **Weight units** is highlighted.
5. Press the SELECT (O) button to display the Weight units menu (See Figure 54).

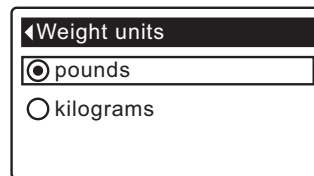

FIG. 54

6. If the desired weight unit already has a black dot next to it (See Figure 54), go to Step 7. Otherwise, press the DOWN (▼) or UP (▲) buttons to scroll to the other weight unit, then press SELECT (O) to choose it.
7. Press the SELECT (O) button. The display will go back to the User preferences menu.
8. Press the LEFT (◀) button twice to return to the rolling status screens.

Programming the Water Softener

SYSTEM INFORMATION

Use these features to look up the following information about the softener and its operations:

- **Model information** (model number and software version)
- **Water available** (softened water ready for use)
- **Daily average water used**
- **Water used today**
- **Total water used** (explained in Step 6, below)
- **Current water flow**
- **Days powered up**
- **Last recharge**
- **Total recharges**

To display one of these screens:

1. From any of the rolling status screens, press the SELECT (O) button to display the **Main menu**.
2. Press the DOWN (▼) button to scroll through the menu options until **System information** is highlighted (See Figure 55).

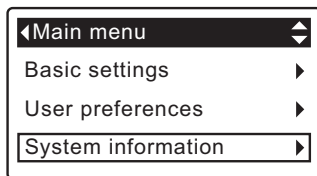

FIG. 55

3. Press the SELECT (O) button to display the System information menu (See Figure 56).

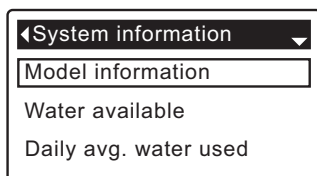

FIG. 56

4. Press the DOWN (▼) button to scroll through the menu options until the desired option is highlighted (See list at the top of this column).
5. Press the SELECT (O) button to display the desired information screen (See Figures 57-65).
6. The **Total water used** screen (See Figure 61) shows the volume of water used since it was last reset (it works like the trip odometer in a car). To reset the value to 0, press the RIGHT (▶) button while this screen is displayed.
7. When finished viewing an information screen, press the SELECT (O) button. The display will go back to the System information menu (Figure 56). It will also exit automatically if no buttons are pressed for four minutes.
8. Press the LEFT (◀) button twice to return to the rolling status screens.

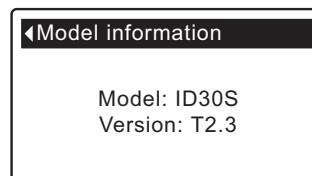

FIG. 57

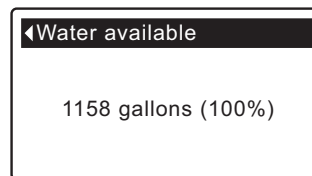

FIG. 58

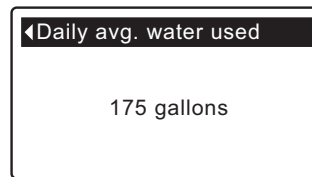

FIG. 59

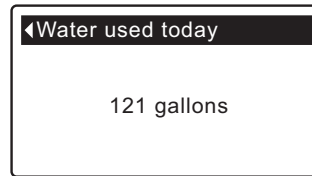

FIG. 60

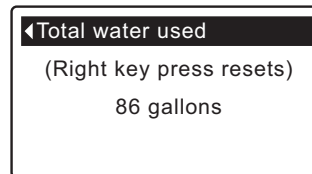

FIG. 61

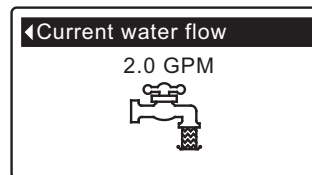

FIG. 62

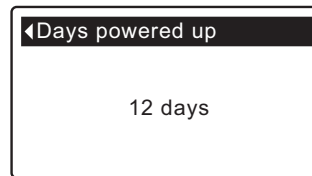

FIG. 63

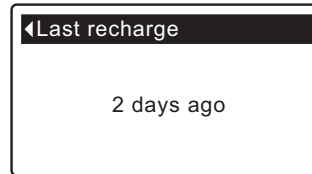

FIG. 64

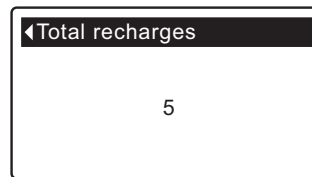

FIG. 65

Programming the Water Softener

CYCLE TIMES

Use these features to change the following softener operations:

- Backwash time
- Second backwash (On/Off)
- Second backwash time
- Fast rinse time

To display these screens:

1. From any of the rolling status screens, press the SELECT (O) button to display the **Main menu**.
2. Press the DOWN (▼) button to scroll through the menu options until **Advanced settings** is highlighted (See Figure 66).

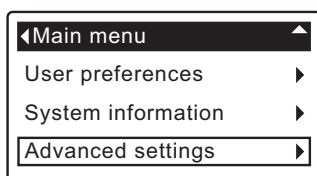

FIG. 66

3. Press the SELECT (O) button to display the Advanced settings menu (See Figure 67).

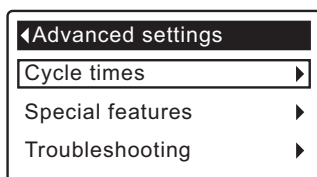

FIG. 67

4. Make sure **Cycle times** is highlighted.
5. Press the SELECT (O) button to display the Cycle times menu (See Figure 68).

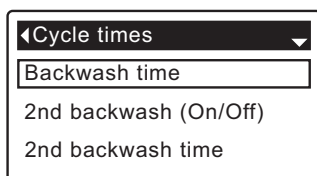

FIG. 68

6. Press the DOWN (▼) button to scroll through the menu options until the desired option is highlighted (See list at the top of this column).
7. Press the SELECT (O) button to display the desired information screen (See Figures 69-72).
8. **See the right column on this page for specific instructions on each cycle time screen.**
9. Press the SELECT (O) button. The display will go back to the Cycle times menu (Figure 68).
10. Press the LEFT (◀) button three times to return to the rolling status screens.

- 8a. **Backwash time:** Press the UP (▲) or DOWN (▼) buttons to change the backwash time. Hold the button down to rapidly advance. The backwash time can be set from 1 to 30 minutes* (See Figure 69).



FIG. 69

- 8b. **Second backwash (On/Off):** If the desired option already has a black dot next to it (See Figure 70), go to Step 9. Otherwise, press the DOWN (▼) or UP (▲) buttons to scroll to the other option, then press SELECT (O) to choose it. Setting this feature On adds a second backwash and rinse at the beginning of the recharge cycle. Default is Off. Set this feature On if your water supply contains a lot of sediment or iron.

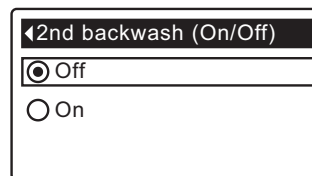

FIG. 70

- 8c. **Second backwash time:** Press the UP (▲) or DOWN (▼) buttons to change the second backwash time. Hold the button down to rapidly advance. The time can be set from 1 to 30 minutes (See Figure 71).



FIG. 71

- 8d. **Fast rinse time:** Press the UP (▲) or DOWN (▼) buttons to change the fast rinse time. Hold the button down to rapidly advance. The fast rinse time can be set from 1 to 30 minutes* (See Figure 72).



FIG. 72

*Reducing the backwash and fast rinse times below a softener model's default settings can result in salty water after recharges.

Programming the Water Softener

SPECIAL FEATURES

Use these features to change the following operations:

- **Efficiency mode**
- **Maximum days between recharges**
- **Auxiliary control** (described on Page 23)
- **Chemical feed volume*** (described on Page 23)
- **Chemical feed timer*** (described on Page 23)
- **97% feature**
- **Service reminder** (described on Page 24)

To display one these screens:

1. From any of the rolling status screens, press the SELECT (O) button to display the **Main menu**.
2. Press the DOWN (▼) button to scroll through the menu options until **Advanced settings** is highlighted (See Figure 73).

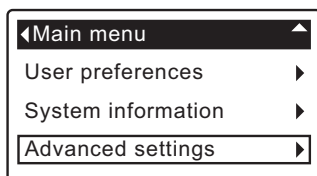

FIG. 73

3. Press the SELECT (O) button to display the Advanced settings menu (See Figure 74).

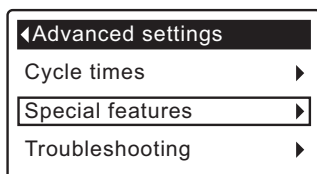

FIG. 74

4. Press the DOWN (▼) button to scroll through the menu options until **Special features** is highlighted.
5. Press the SELECT (O) button to display the Special features menu (See Figure 75).

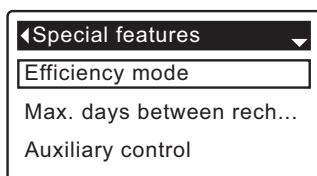

FIG. 75

6. Press the DOWN (▼) button to scroll through the menu options until the desired option is highlighted (See list at the top of this column).
7. Press the SELECT (O) button to display the desired special feature screen (See Figures 76-78).
8. **See the right column on this page for specific instructions on each cycle time screen.**
9. Press the SELECT (O) button. The display will go back to the Special features menu (Figure 75).
10. Press the LEFT (◀) button three times to return to the rolling status screens.

*Only displayed if Auxiliary control is set to Chemical feed.

- 8a. **Efficiency mode:** If the desired efficiency mode already has a black dot next to it (See Figure 76), go to Step 9. Otherwise, press the DOWN (▼) or UP (▲) buttons to scroll to the desired efficiency mode, then press SELECT (O) to choose it.

- **Salt efficient** limits available salt doses to maintain 4000 grains/lb. of salt efficiency. Units may recharge more frequently.

- **Auto adjusting** is the default. It automatically adjusts salt doses to target a 3-4 day interval between recharges. Recommended.

- **High capacity** is for applications where very low “bleed” (less than 1.5 ppm) of hardness can be tolerated. Such applications include water for boilers. This setting will consume higher quantities of salt.

NOTE: California regulations require the efficiency mode be set to **Salt efficient** for units installed in the state of California.

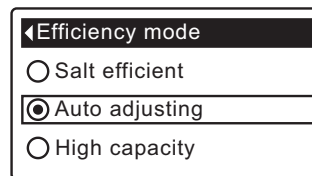

FIG. 76

- 8b. **Maximum days between recharges:** Press the UP (▲) or DOWN (▼) buttons to change the number of days (See Figure 77). The feature can be set from 1 to 15 days. Setting the number of days below 1 turns the feature off and defaults to automatic control of recharging.

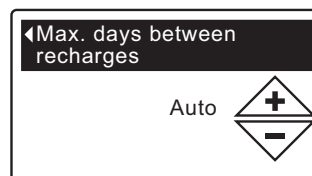

FIG. 77

- 8c. **97% feature:** If the desired option already has a black dot next to it (See Figure 78), go to Step 9. Otherwise, press the DOWN (▼) or UP (▲) buttons to scroll to the other option, then press SELECT (O) to choose it. If this feature is On, the softener will automatically recharge when 97% of capacity is used, at any time of day. Default is Off.

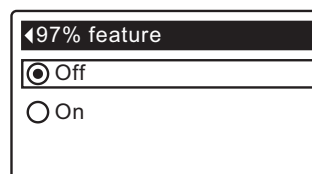

FIG. 78

Programming the Water Softener

AUXILIARY CONTROL

The electronic control has an auxiliary output which can control external devices in a water treatment system. The signal is 24V DC, current draw 500 mA maximum. The Auxiliary Output terminals are located on the electronic control board (see Schematic on the next page).

To select an auxiliary control mode:

1. From any of the rolling status screens, press the SELECT (O) button to display the **Main menu**.
2. Press the DOWN (▼) button to scroll through the menu options until **Advanced settings** is highlighted.
3. Press the SELECT (O) button to display the Advanced settings menu.
4. Press the DOWN (▼) button to scroll through the menu options until **Special features** is highlighted.
5. Press the SELECT (O) button to display the Special features menu (See Figure 79).

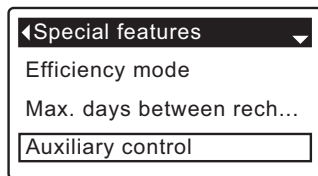

FIG. 79

6. Press the DOWN (▼) button to scroll through the menu options until **Auxiliary control** is highlighted.
7. Press the SELECT (O) button to display the Auxiliary control menu (See Figure 80).
8. If the desired option already has a black dot next to it (See Figure 80), go to Step 9. Otherwise, press the DOWN (▼) or UP (▲) buttons to scroll to the desired option, then press SELECT (O) to choose it.
 - **Off** is the default. The 24V DC output is always off.
 - **On**: The 24V DC output is always on.
 - **Chlorine** can be used to drive a chlorine generator, which produces chlorine, as brine water passes through it, to sanitize the resin during recharges.
 - **Bypass**: Turns 24V DC on during the entire regeneration cycle (when the softener's valve is in bypass and hard water is going to the house).
 - **Chemical feed**: Can be used to run a chemical feed pump. If chosen, the chemical feed volume and timer must be set, as detailed at right)
 - **Water use**: Turns 24V DC on when the softener's turbine indicates water flow. Could drive an air pump for iron or sulfur oxidation.
 - **Fast Rinse**: Turns 24V DC on during the fast rinse portion of the regeneration cycle.
9. Press the SELECT (O) button. The display will go back to the Special features menu (Figure 79).
10. Press the LEFT (◀) button three times to return to the rolling status screens.

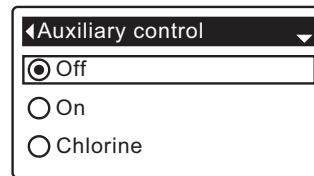

FIG. 80

CHEMICAL FEED

If the auxiliary control mode has been set to **Chemical feed**, as described in the previous section, two additional lines (**Chemical feed volume** and **Chemical feed timer**) will appear on the Special features menu.

To set these values:

1. From any of the rolling status screens, press the SELECT (O) button to display the **Main menu**.
2. Press the DOWN (▼) button to scroll through the menu options until **Advanced settings** is highlighted.
3. Press the SELECT (O) button to display the Advanced settings menu.
4. Press the DOWN (▼) button to scroll through the menu options until **Special features** is highlighted.
5. Press the SELECT (O) button to display the Special features menu (See Figure 79).
6. Press the DOWN (▼) button to scroll through the menu options until **Chemical feed volume** or **Chemical feed timer** is highlighted.
7. Press the SELECT (O) button to display the Chemical feed volume or Chemical feed timer menu (See Figures 81 & 82).

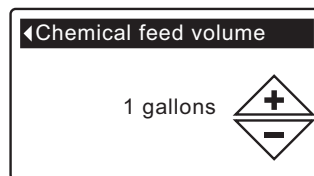

FIG. 81

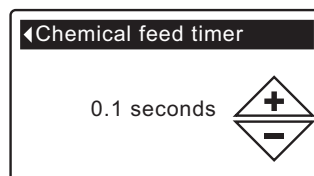

FIG. 82

8. Press the UP (▲) or DOWN (▼) buttons to change the value. Hold the button down to rapidly advance.
 - **Chemical feed volume** is the amount of water which will pass through the softener between each activation of the chemical feed equipment.
 - **Chemical feed timer** is how long the output to the chemical feed equipment is energized each time it is activated.
9. Press the SELECT (O) button. The display will go back to the Special features menu (Figure 79).
10. Press the LEFT (◀) button three times to return to the rolling status screens.

Programming the Water Softener

SERVICE REMINDER (set / reset)

Use this feature to program the number of months (up to 24) before a “Service overdue” message will appear instead of the rolling status screens (See Figure 83).

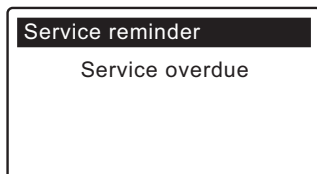

FIG. 83

This will be a reminder to call your dealer for service. Once programmed, this feature displays the number of months and days left until the service reminder.

Once the “Service overdue” message has appeared, dealers performing service clear it by setting the number of months until the next service reminder. Set or reset the service reminder as follows:

1. From any of the rolling status screens, press the SELECT (O) button to display the **Main menu**.
2. Press the DOWN (▼) button to scroll through the menu options until **Advanced settings** is highlighted.
3. Press the SELECT (O) button to display the Advanced settings menu.
4. Press the DOWN (▼) button to scroll through the menu options until **Special features** is highlighted.

5. Press the SELECT (O) button to display the Special features menu (See Figure 84).

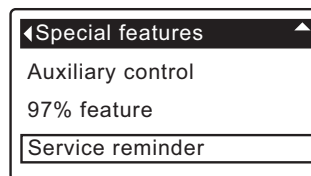

FIG. 84

6. Press the DOWN (▼) button to scroll through the menu options until **Service reminder** is highlighted.
7. Press the SELECT (O) button to display the Service reminder screen (See Figure 85).

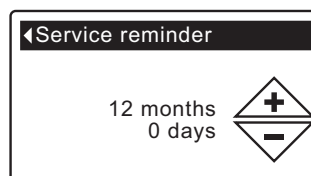

FIG. 85

8. Press the UP (▲) or DOWN (▼) buttons to set the number of months until the service reminder appears. Repeatedly pressing the DOWN (▼) button until the display reads “Off” turns this feature off and zeros the number of months and days.
9. Press the SELECT (O) button. The display will go back to the Special features menu (Figure 84).
10. Press the LEFT (◀) button three times to return to the rolling status screens.

WIRING SCHEMATIC

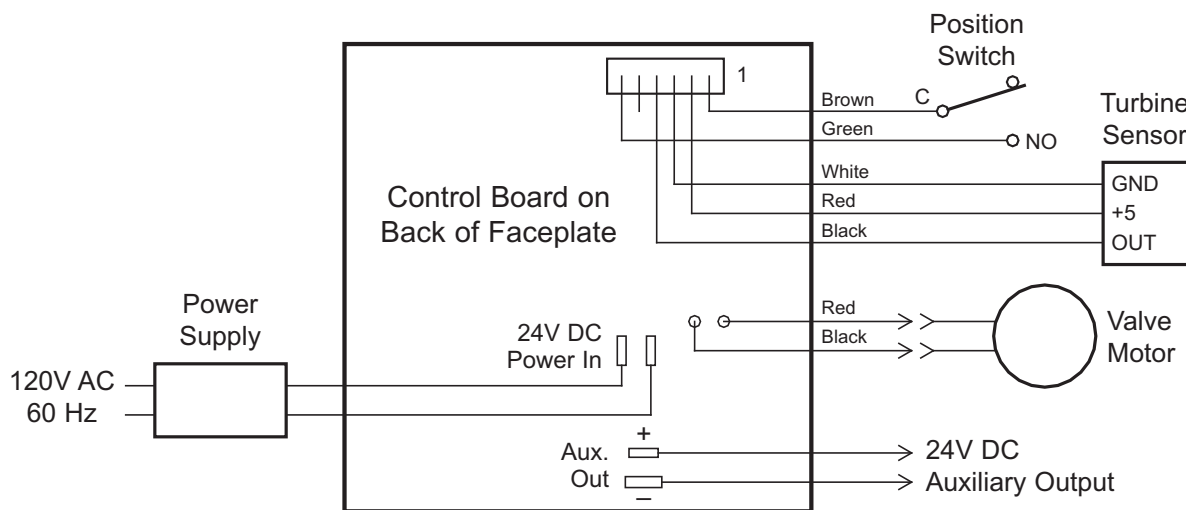

FIG. 86

Programming the Water Softener

DIAGNOSTICS

This feature allows a service technician to check the operating state of individual components in the softener (e.g. valve position) to troubleshoot problems. **If an error code is displayed in place of the rolling status screens, call your dealer for service.**

To view the Diagnostics screen:

1. If an error code is displayed, skip Steps 2-7 and go directly to Step 8.
2. To display the Diagnostics screen from any of the rolling status screens (when an error code is not displayed), press the SELECT (O) button to display the **Main menu**.
3. Press the DOWN (▼) button to scroll through the menu options until **Advanced settings** is highlighted.
4. Press the SELECT (O) button to display the Advanced settings menu.
5. Press the DOWN (▼) button to scroll through the menu options until **Troubleshooting** is highlighted.
6. Press the SELECT (O) button to display the Troubleshooting menu (See Figure 87).

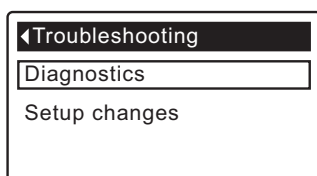

FIG. 87

7. Press the DOWN (▼) button to scroll through the menu options until **Diagnostics** is highlighted.
8. Press the SELECT (O) button to display the Diagnostics screen (See Figure 88).

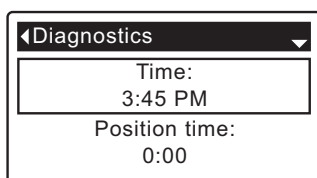

FIG. 88

9. Press the DOWN (▼) or UP (▲) buttons to scroll through the list. The following items are displayed:
 - **Time** (current)
 - **Position time** (counts down the time remaining in the current valve position)
 - **Current position** (of the valve: service, fill, brine, backwash, fast rinse or moving)
 - **Requested position** (of the valve)
 - **Motor state** (on or off)
 - **Valve position switch** (open or closed)
 - **Turbine count** (if changing, indicates water flow)
 - **Tank light switch** (open or closed)
 - **Error code** (call for service if a number is displayed)

continued

10. When finished viewing the Diagnostics screen, press the SELECT (O) button. The display will go back to the Troubleshooting menu.
11. Press the LEFT (◀) button three times to return to the rolling status screens (or error code screen if an error condition exists).

SETUP CHANGES

This feature allows a service technician to repeat the setup procedure (See Page 11) or restore the softener's default operating values.

1. From any of the rolling status screens, press the SELECT (O) button to display the **Main menu**.
2. Press the DOWN (▼) button to scroll through the menu options until **Advanced settings** is highlighted.
3. Press the SELECT (O) button to display the Advanced settings menu.
4. Press the DOWN (▼) button to scroll through the menu options until **Troubleshooting** is highlighted.
5. Press the SELECT (O) button to display the Troubleshooting menu (See Figure 87).
6. Press the DOWN (▼) button to scroll through the menu options until **Setup changes** is highlighted.
7. Press the SELECT (O) button to display the Setup changes menu (See Figure 89).

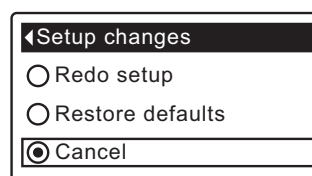

FIG. 89

8. If the desired option already has a black dot next to it (See Figure 89), go to Step 9. Otherwise, press the DOWN (▼) or UP (▲) buttons to scroll to the desired option, then press SELECT (O) to choose it.
 - **Redo setup** allows you to select a different model code (intended to be used for upgrades or retrofits of existing softeners). Model codes are listed on Page 3.
 - **Restore defaults** will reset all customizable settings to their default values and take you through the "wizard" screen setup procedure (See Page 11).
 - **Cancel** will return to the Troubleshooting menu (Figure 87).
9. Press the SELECT (O) button.

Routine Maintenance

ADDING SALT

If the water softener uses all the salt before more is added, hard water will result. The softener salt status screen has an optional display of the estimated number of days until salt is depleted (“Out of salt in X days”). The softener can also be programmed to display a Low Salt Alarm a certain number of days before salt is estimated to run out (See Page 15).

Be sure that the brinewell cover is on when adding salt.

NOTE: In humid areas it is best to keep the salt level less than half full and add salt more often.

RECOMMENDED SALT: Cube, pellet, coarse solar, etc., water softener salt is recommended. This type of salt is high purity evaporated crystals, sometimes formed and pressed into briquets. It has less than 1% insoluble (not dissolvable in water) impurities. Clean, high grade rock salts are acceptable, but may require frequent brine tank cleaning to remove the “sludge” residue (insolubles) collecting at the bottom of the tank.

POTASSIUM CHLORIDE: If you choose potassium chloride (KCl) salt as a regenerant:

- 1) Make sure “Salt type” on the electronic control is set to “KCl”, as shown on Page 15.
- 2) Place only one bag of potassium chloride (KCl) into your softener at a time. The salt storage tank should never contain more than 60 pounds of KCl.

SALT NOT RECOMMENDED: Rock salt high in impurities, block, granulated, table, ice melting, or ice cream making salts, etc., are not recommended.

SALT WITH IRON REMOVING ADDITIVE: Some salts have an additive to help a water softener handle iron in the water supply. Although this may help keep the resin bed clean, it may also release corrosive fumes that will weaken and shorten the life of some water softener electronic parts. Iron Out salt is safe to use on two-tank models.

BREAKING A SALT BRIDGE

Sometimes a hard crust or salt “bridge” forms in the brine tank. This is usually caused by high humidity or the wrong kind of salt. When the salt bridges, an empty space forms between the water and the salt. Then salt will not dissolve in the water to make brine. Without brine, the resin bed is not recharged and hard water will result.

If the storage tank is full of salt, it is difficult to tell whether there is a salt bridge. A bridge may be underneath loose salt. The following is the best way to check for a salt bridge:

Salt should be loose all the way to the bottom of the tank. Hold a broom handle, or like tool, up to the softener, as shown in Figure 90. Make a pencil mark on the handle 1” - 2” below the top of the rim. Then, carefully push it straight down into the salt. If a hard object is felt before the pencil mark is even with the top, it is most likely a salt bridge. Carefully push into the bridge in several places to break it. **Do not try to break the salt bridge by pounding on the outside of the salt tank. You may damage the tank.**

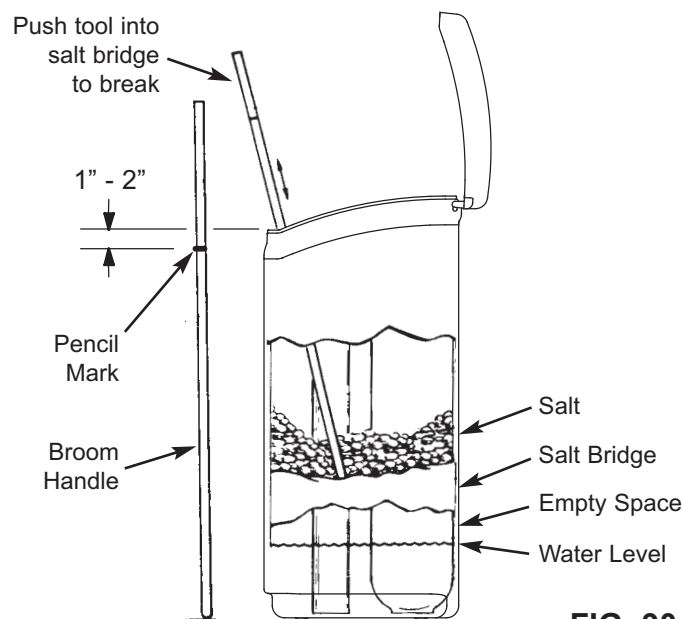

FIG. 90

Routine Maintenance

CLEANING THE NOZZLE & VENTURI

A clean nozzle & venturi (See Figure 91) is a necessity for the water softener to work properly. This small component creates the suction to aspirate (bring air into) the mineral tank during recharges. If it should become plugged with sand, silt, dirt, etc., the water softener will not work, and hard water will result.

To get access to the nozzle & venturi, remove the water softener's top cover. Put the bypass valve(s) into the bypass position. Be sure the water softener's main valve is in "service" position (no water pressure at nozzle & venturi). Then, holding the nozzle & venturi housing with one hand, unscrew the cap. Do not lose the o-ring seal. Lift out the screen support and screen. Then, remove the nozzle & venturi disc, gasket and flow plug. Wash the parts in warm, soapy water and rinse in fresh water. Be sure to clean both the top and bottom of the nozzle & venturi disc. If needed, use a small brush to remove iron or dirt. Do not scratch, misshape, etc., surfaces of the nozzle & venturi.

Gently replace all parts in the correct order. Lubricate the o-ring seal with silicone grease and locate in place. Install and tighten the cap by hand, while supporting the housing. Overtightening may break the cap or housing. Put the bypass valve(s) into "service" position.

Recharge the softener to reduce water level in the tank. This will also assure that the softener is completely recharged and ready to provide softened water again. Check the water level in the tank by looking down the brinewell. If the water level does not drop after a recharge, the problem has not been resolved.

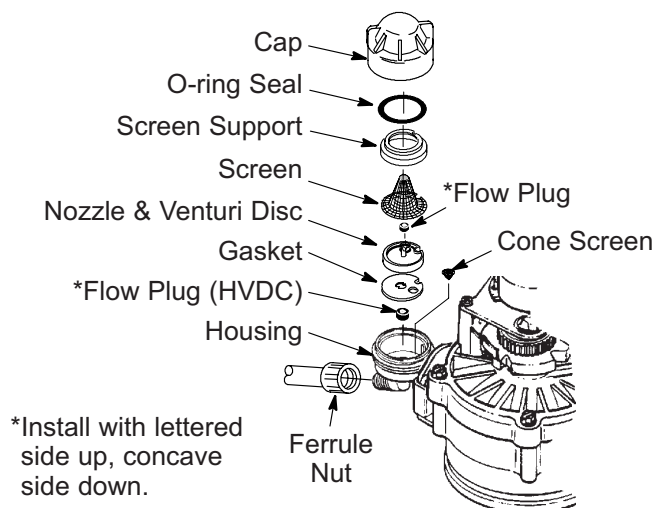

IMPORTANT: Be sure small hole in the gasket is centered directly over the small hole in the nozzle & venturi housing. Be sure the numbers are facing up

FIG. 91

RESIN BED CLEANING

If the water supply contains clear water iron, regular resin bed cleaning is needed to keep the bed from coating with iron. Use resin bed cleaner, available from your dealer, following directions on the container. Clean the resin every six months, or more often if iron appears in the conditioned water supply.

Troubleshooting Guide

PROBLEM	CAUSE	CORRECTION
Cannot set some softener parameters and display shows a padlock icon: 	Lockout feature is on.	Turn off lockout feature (See Page 14).
No soft water	No salt in the storage tank.	Add salt (See Page 26) and then initiate a "Recharge now," as shown on Page 16.
	Salt is "bridged."	Break salt bridge (See Page 26) and then initiate a "Recharge now," as shown on Page 16.
	If display is blank, power supply may be unplugged at wall outlet, power cable leads may be disconnected from the electronic control board, fuse may be blown, circuit breaker may be popped, or power supply may be plugged into a switched outlet which is "off."	Check for power loss due to any of these and correct. When power is restored, if the display shows the "Current Time" setting screen (Figure 39 on Page 16), it means time was lost during the outage. Set the current time. Other settings such as hardness are retained in memory during a power loss.
	Bypass valve(s) in bypass position.	Place bypass valve(s) in service position.
	Dirty, plugged or damaged nozzle & venturi.	Take apart, clean and inspect the nozzle & venturi assembly, as shown on Page 27.
	Valve drain hose plugged or restricted.	Drain hose must not have any kinks, sharp bends, or be raised too high above the softener.
Water hard sometimes	Bypassed hard water being used during recharge, due to current time or recharge time settings being incorrect.	Check the current time displayed. If not correct, refer to "Set Current Time" on Page 16. Check the recharge time, as described on Page 17.
	Hardness number setting is too low.	Referring to "Setting Hardness" on Page 17, check the current hardness setting and increase if needed.
	Hot water being used when softener is recharging.	Avoid using hot water during recharges, because water heater refills with hard water.
	Increase in actual hardness of water supply.	Have unsoftened water sample tested. Referring to Page 17, check the current hardness setting and increase if needed.
	Turbine is not turning freely.	Check turbine, as described on Page 29.
Motor stalled or clicking	Motor malfunction or internal valve fault causing high torque on motor.	Contact a service technician.
Error code E1, E3 or E4 displayed.	Fault in wiring harness, connections to position switch, switch, valve or motor.	Contact a service technician.
Error code E5 displayed.	Electronic control malfunction.	Contact a service technician.

TROUBLESHOOTING - INITIAL CHECKS

Always make these initial checks first:

1. Is display blank? Check power source.
2. Is Error code displayed? If so, go to "Automatic Electronic Diagnostics" on the next page.
3. Is correct time displayed? If not, recharges occur at the wrong time. Set current time (See Page 16.)
4. Is there salt in the brine tank? If not, refill.
5. Is salt "bridged" (See Page 26)?
6. Are plumbing bypass valve(s) in service position?
7. Are inlet and outlet pipes connected to the water softener inlet and outlet respectively?
8. Is valve drain hose free of kinks and sharp bends, and not elevated over 8 feet above the floor.
9. Is the brine tube connected?
10. Check the hardness setting (See "Setting Hardness" on Page 17). Be sure it is correct for the household's water supply. Perform a hardness test on a raw water sample to compare with the setting.
11. Perform a hardness test on a softened water sample to determine whether a problem exists.

If no problem is found after making the initial checks, proceed to "Troubleshooting - Manual Diagnostics" and "Manual Advance Recharge Check" on the next two pages.

Troubleshooting

AUTOMATIC ELECTRONIC DIAGNOSTICS

This softener has a self-diagnostic function for the electrical system (except for input power and/or water meter). The controller monitors electronic components and circuits for correct operation. If a malfunction occurs, an **Error code** is displayed (See Figure 92).

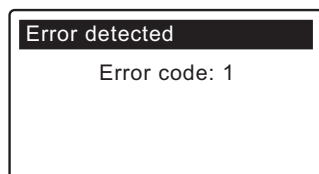

FIG. 92

The troubleshooting chart on the previous page shows the error codes that could appear, and the possible malfunctions for these codes.

When an error code appears in the display, pressing SELECT (O) will display the **Diagnostics** screen (See Page 25), so a service technician can further isolate the problem.

REMOVING ERROR CODE

1. Unplug power supply from electrical outlet.
2. Correct problem.
3. Plug in power supply.
4. Wait for eight minutes while controller operates valve through an entire cycle. The error code will return if the problem was not corrected.

TROUBLESHOOTING - MANUAL DIAGNOSTICS

1. Display the **Diagnostics** screen, following the procedure on Page 25.
2. Press the DOWN (▼) or UP (▲) buttons to scroll through the list. The following items are displayed:
 - **Time** (current)
 - **Position time** (counts down the time remaining in the current valve position)
 - **Current position** (of the valve: service, fill, brine, backwash, fast rinse or moving) See "Manual Advance Recharge Check" on next page for position verification.
 - **Requested position** (of the valve)
 - **Motor state** (on or off)
 - **Valve position switch** (open or closed)
 - **Turbine count** (indicates water flow) See following section for turbine diagnostics.
 - **Tank light switch** (open or closed)
 - **Error code**

CHECKING THE TURBINE

1. Display the **Diagnostics** screen, following the procedure on Page 25.
2. Press the DOWN (▼) button to scroll through the list until **Turbine Count** is displayed (See Figure 93).

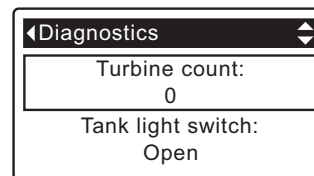

FIG. 93

3. A steady display of "0" (zero) indicates no water flow through the meter (i.e. no softened water being used).
4. Open a nearby softened water faucet.
5. The number in the display should count upward from 0 to 140 for each gallon of flow on 1" valve models, or 0 to 199 for each gallon on 3/4" valve models.
6. If the display reading does not change with the faucet open, pull the wire harness from the valve outlet port (See Figure 94).

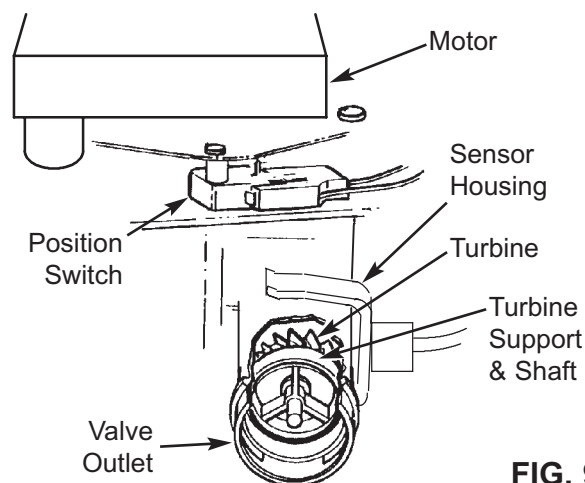

FIG. 94

7. Pass a small magnet back and forth in front of the sensor.
 - 8a. If the displayed **Turbine Count** does count upward with each pass of the magnet, disconnect the outlet plumbing and check the turbine for binding.
 - 8b. If the displayed **Turbine Count** does not count upward with each pass of the magnet, the sensor is probably faulty.

Troubleshooting

TROUBLESHOOTING - MANUAL ADVANCE RECHARGE CHECK

This check verifies proper operation of the position switch, gear motor, brine tank fill, brine draw, recharge flow rates, and other controller functions. Always make the Initial Checks (See Page 28) and the Manual Diagnostics (See Page 25) first.

1. Display the **Diagnostics** screen, following the procedure on Page 25.
2. Press the DOWN (▼) button to scroll through the list until **Valve position switch** is displayed (See Figure 95).

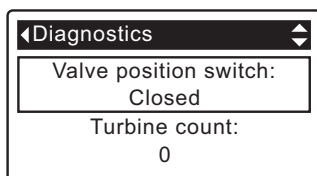

FIG. 95

3. Verify that when the switch plunger is down (into one of the detents on the valve motor cam), this screen reads **Open**. When the valve cam is rotating (for example, after Step 8, below), the switch plunger will be up and this screen should read **Closed**.
4. Press the UP (▲) button to scroll through the list until **Current position** is displayed (See Figure 96).

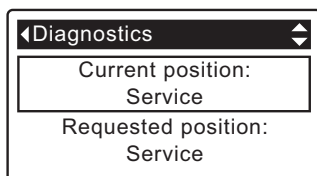

FIG. 96

6. Verify that the valve position indicator on the motor cam agrees with the position displayed on the screen
7. Remove the brinewell cover.
8. With the Diagnostics screen displayed, press the RIGHT (▶) button once to advance the valve from **Service** to **Fill**.
9. Shine a flashlight into the brinewell and observe fill water entering the tank.
10. If water does not enter the tank, look for an obstructed nozzle / venturi, fill flow plug or brine tube (See Figure 91 on Page 27).
11. After verifying fill, press the RIGHT (▶) button once to move the valve into **Brine***. A slow flow of water to the drain will begin. Verify brine draw from the brine tank by shining the flashlight into the brinewell to observe a noticeable drop in the liquid level.

* If the 2nd Backwash option is set (See Page 21), the valve will enter backwash and fast rinse before brine.

12. If the unit does not draw brine, check for:
 - Dirty or defective nozzle / venturi (See Page 27)
 - Nozzle / venturi not seated on the gasket or gasket not sealing properly
 - Restriction in valve drain, causing back pressure (bends, kinks, elevated too high, etc.)
 - Obstruction in valve or brine tubing
 - Internal valve fault (obstructed outlet disc, wave washer faulty etc.)
13. With the Diagnostics screen displayed, once again press the RIGHT (▶) button to advance the valve to **Backwash**.
14. Look for a fast flow of water from the drain hose. If flow is slow, check for a plugged top distributor, backwash flow plug or drain hose
15. With the Diagnostics screen displayed, once again press the RIGHT (▶) button to advance the valve to **Fast rinse**.
16. Again, look for a fast flow of water from the drain hose. Allow the unit to rinse for several minutes to flush out any brine that may remain from the brine cycle test.
17. With the Diagnostics screen displayed, once again press the RIGHT (▶) button to return the valve to the **Service** position.

IMPORTANT: Always return the valve to the **Service** position before exiting this procedure.

OTHER SERVICE

Hard Water Bypass (Hard water “bleeds” into softened water supply):

1. Faulty inlet disc, seal or wave washer (See Pages 34-37).
2. Missing or faulty o-ring(s) at valve connection to riser pipe.

Water Leaks from Drain Hose during service:

1. Faulty inlet disc, seal or wave washer.
2. Faulty o-ring on inlet disc shaft.
3. Faulty outlet disc, seal or wave washer.

Flooded Salt Tank:

1. Nozzle / venturi plugged.
2. Faulty valve seals.
3. Restricted or plugged backwash / fast rinse controls.
4. Restricted or plugged drain line.

Water Has Salty Taste:

1. House water pressure low. Adjust well pump.
2. Partially restricted valve drain hose, top distributor, backwash flow plug, resin tank internal riser pipe, or bottom distributor.
3. Backwash and fast rinse times have been reduced from default settings.
4. Wrong model code.

Troubleshooting

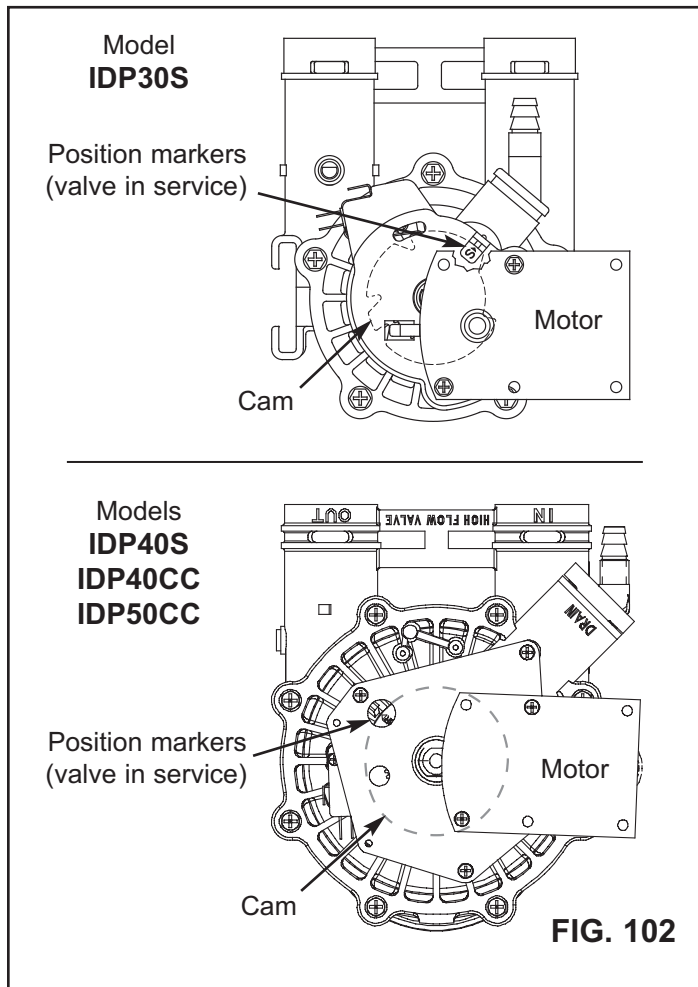
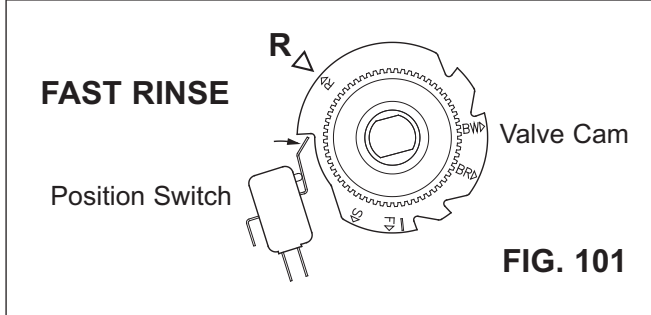
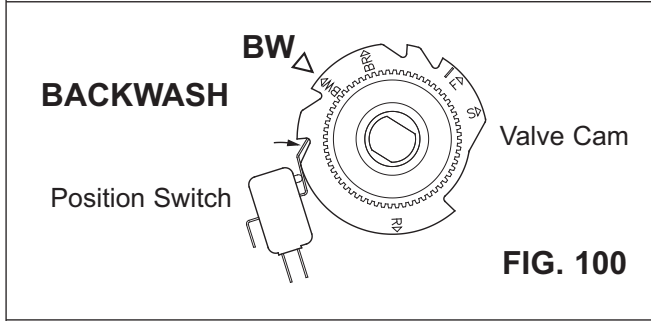
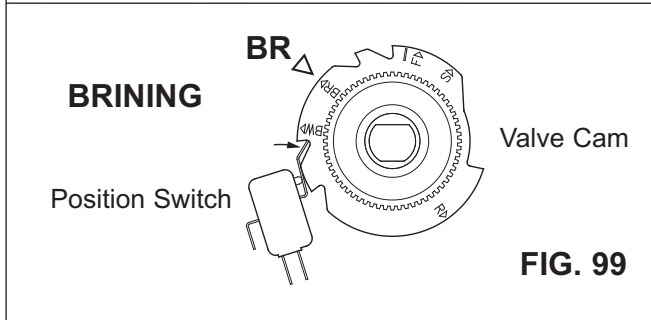
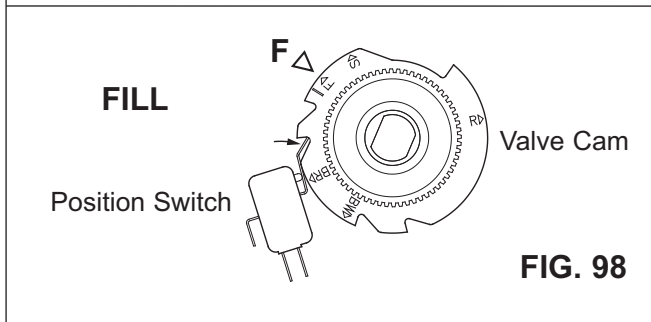
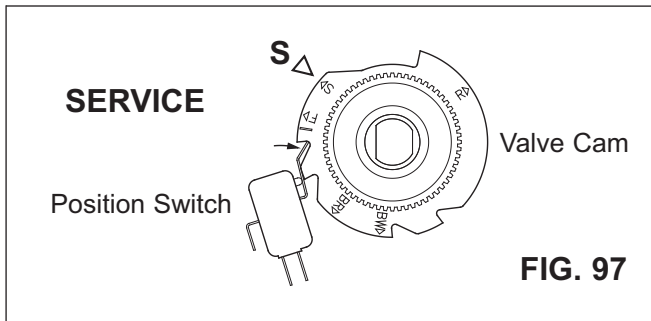

Softener Exploded View - All Models

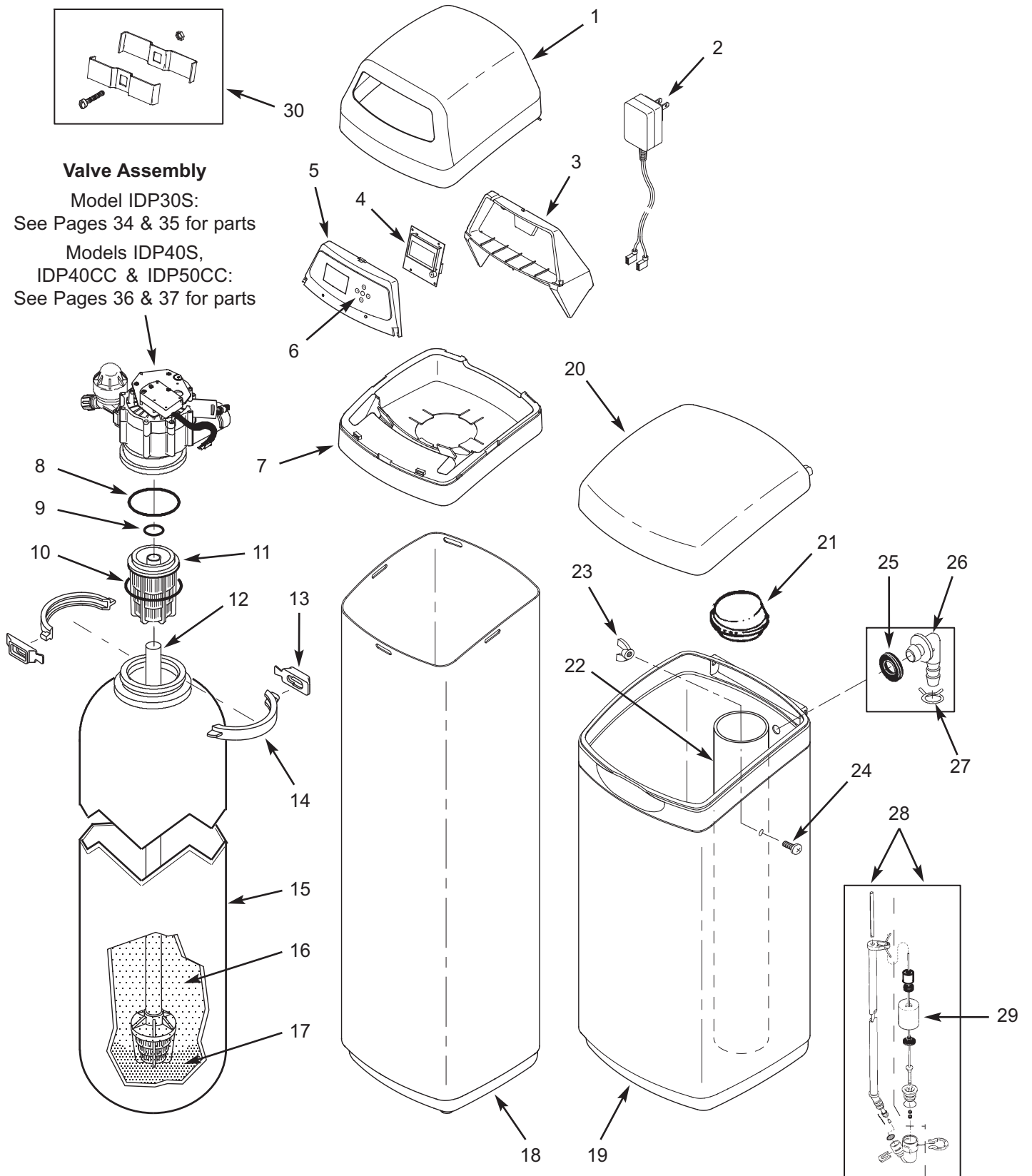

Softener Parts List – All Models

Key No.	Part No.	Description
1	7371884	Top Cover
2	7351054	Power Supply, 24V DC
3	7291212	Support, Faceplate
–	7371680	Repl. Faceplate Assembly (includes Key Nos. 4-6)
4	↑	Electronic Controller (PWA)
5	↑	Faceplate
6	↑	Keypad/Decal
7	7371876	Rim
–	7112963	Distributor O-Ring Kit (includes Key Nos. 8-10)
8	↑	O-Ring, 2-7/8" x 3-1/4"
9	↑	O-Ring, 13/16" x 1-1/16"
10	↑	O-Ring, 2-3/4" x 3"
11	7088855	Top Distributor
12	7178498	Repl. Bottom Distributor, Models IDP30S, IDP40S & IDP40CC
	7105047	Repl. Bottom Distributor, Model IDP50CC
–	7331177	Tank Neck Clamp Kit (includes 2 ea. of Key Nos. 13 & 14)
13	↑	Retainer, Clamp (2 req.)
14	↑	Clamp Section (2 req.)
15	7113058	Repl. Resin Tank, 8" x 40", Model IDP30S
	7092202	Repl. Resin Tank, 10" x 47", Models IDP40S & IDP40CC
	7113074	Repl. Resin Tank, 12" x 54", Model IDP50CC
16	0502272	Resin, 1 cu. ft. (standard mesh)
	7339141	Catalytic Carbon, 1 cu. ft. Models IDP40CC & IDP50CC
17	7124415	Gravel, 17 lbs., Model IDP50CC

Key No.	Part No.	Description
18	7371800	Shroud, Model IDP30S
	7371795	Shroud, Models IDP40S & IDP40CC
	7371630	Shroud, Model IDP50CC
19	7371826	Brine Tank
20	7371892	Cover, Brine Tank (order decal below)
■	7357767	Decal, Instruction
21	7155115	Cover, Brinewell
22	7214375	Brinewell
–	7331981	Brinewell Mounting Hardware Kit (includes Key Nos. 23 & 24)
23	↑	Wing Nut
24	↑	Screw
–	7331258	Overflow Hose Adaptor Kit (includes Key Nos. 25-27)
25	↑	Grommet
26	↑	Adaptor Elbow
27	↑	Hose Clamp
28	7310197	Brine Valve Assembly, Model IDP30S
	7310210	Brine Valve Assembly, Models IDP40S, IDP40CC & IDP50CC
29	7113008	Float, Stem & Guide Assembly Model IDP30S
	7327568	Float, Stem & Guide Assembly, Models IDP40S, IDP40CC & IDP50CC
30	7248706	Ground Clamp Kit *

■ Not illustrated.

* Optional parts, not included with softener.

Valve Exploded View - Model IDP30S

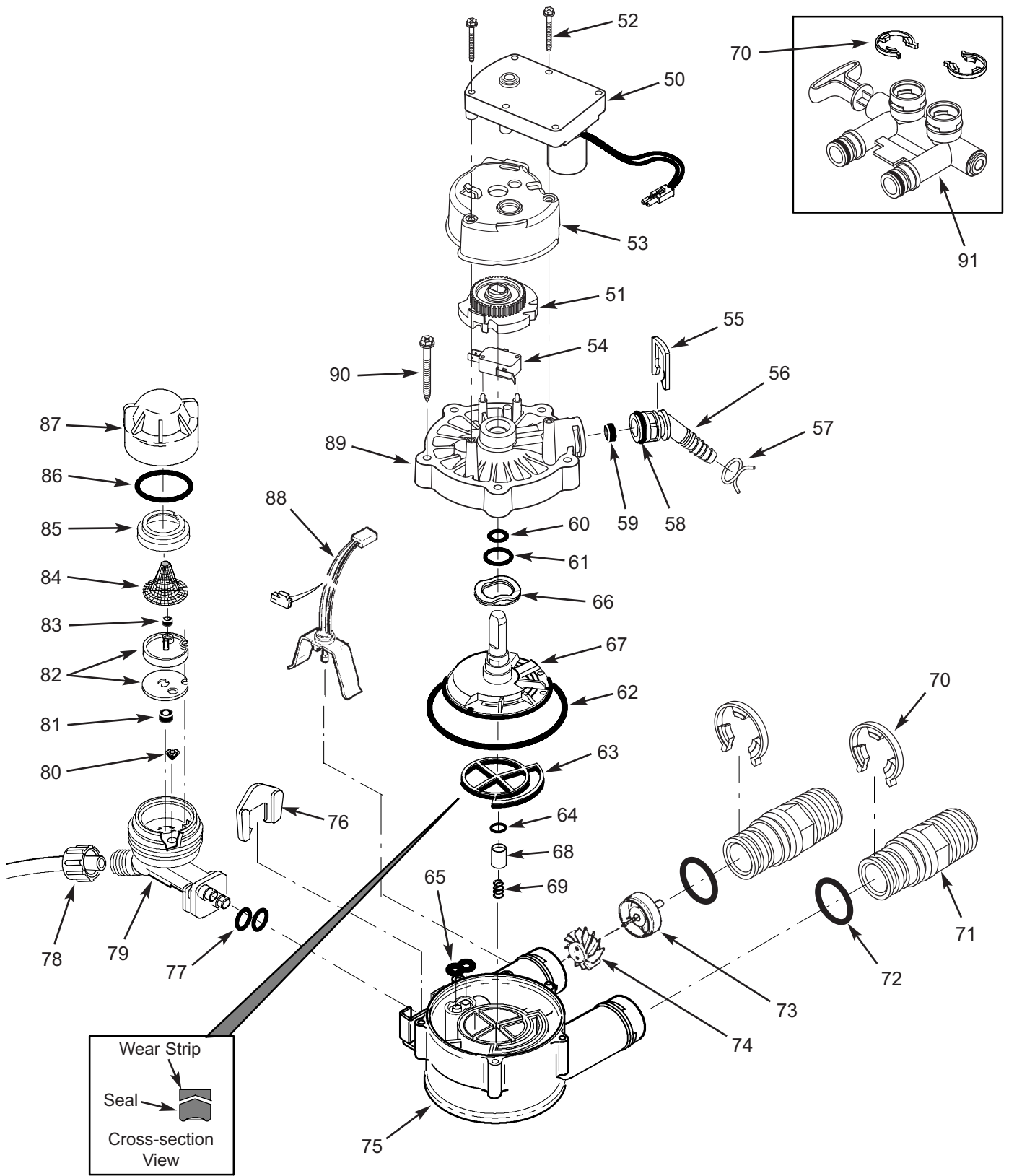

Valve Parts List – Model IDP30S

Key No.	Part No.	Description
–	7373810	Motor, Cam & Gear Kit, 3/4" (includes Key Nos. 50-52)
50	↑	Motor
51	↑	Cam & Gear
52	7338111	Screw, #6-19 x 1-3/8" (2 req.)
53	7337474	Motor Mount
54	7030713	Switch
–	7331185	Drain Hose Adaptor Kit (includes Key Nos. 55-59)
55	↑	Clip, Drain
56	↑	Drain Hose Adaptor
57	↑	Hose Clamp
58	↑	O-Ring, 5/8" x 13/16"
59	↑	Flow Plug, 2.0 gpm
–	7129716	Seal Kit (includes Key Nos. 60-65)
60	↑	O-Ring, 7/16" x 5/8"
61	↑	O-Ring, 3/4" x 15/16"
62	↑	O-Ring, 3-3/8" x 3-5/8"
63	↑	Rotor Seal
64	↑	O-Ring, 3/8" x 9/16"
65	↑	Seal, Nozzle & Venturi
66	7082087	Wave Washer
67	7199232	Rotor & Disc
–	7342665	Drain Plug Kit, 1" (includes Key Nos. 64, 68 & 69)
68	↑	Plug, Drain Seal
69	↑	Spring
70	7116713	Clip, 3/4", single (2 req.)
	7336397	Clip, 3/4", pack of 20
71	7278442	Installation Adaptor, 3/4", single (2 req.)
	7336606	Installation Adaptor, 3/4", pack of 10 (includes 10 ea. of Key No. 72)

Key No.	Part No.	Description
72	7170288	O-Ring, 15/16" x 1-3/16", single (2 req.)
	7336402	O-Ring, 15/16" x 1-3/16", pack of 20
–	7113040	Turbine & Support Assembly (includes 1 ea. of Key Nos. 73, 74 & 2 ea. of Key No. 72)
73	↑	Turbine Support & Shaft
74	↑	Turbine
75	7082053	Valve Body
76	7081201	Retainer, Nozzle & Venturi
77	7170319	O-Ring, 1/4" x 3/8" (2 req.)
78	1202600	Nut - Ferrule
–	7238450	Nozzle & Venturi Assembly (incl. Key Nos. 76, 77 & 79-87)
79	7081104	Housing, Nozzle & Venturi
80	7095030	Cone Screen
81	1148800	Flow Plug, .3 gpm
82	7187772	Nozzle & Venturi Kit w/Gasket
	7204362	Gasket only, single
	7336486	Gasket only, pack of 20
83	0521829	Flow Plug, .1 gpm
84	7146043	Screen
85	7167659	Screen Support
86	7170262	O-Ring, 1-1/8" x 1-3/8", single
	7336436	O-Ring, 1-1/8" x 1-3/8", pack of 20
87	7199729	Cap
88	7309803	Wire Harness, Sensor
89	7337466	Valve Cover
90	7074123	Screw, #10-14 x 2" (5 req.)
91	7278434	Bypass Valve Assembly, 3/4" * (includes 2 ea. of Key No. 72)

* Optional parts, not included with softener.

Valve Exploded View – Models IDP40S, IDP40CC & IDP50CC

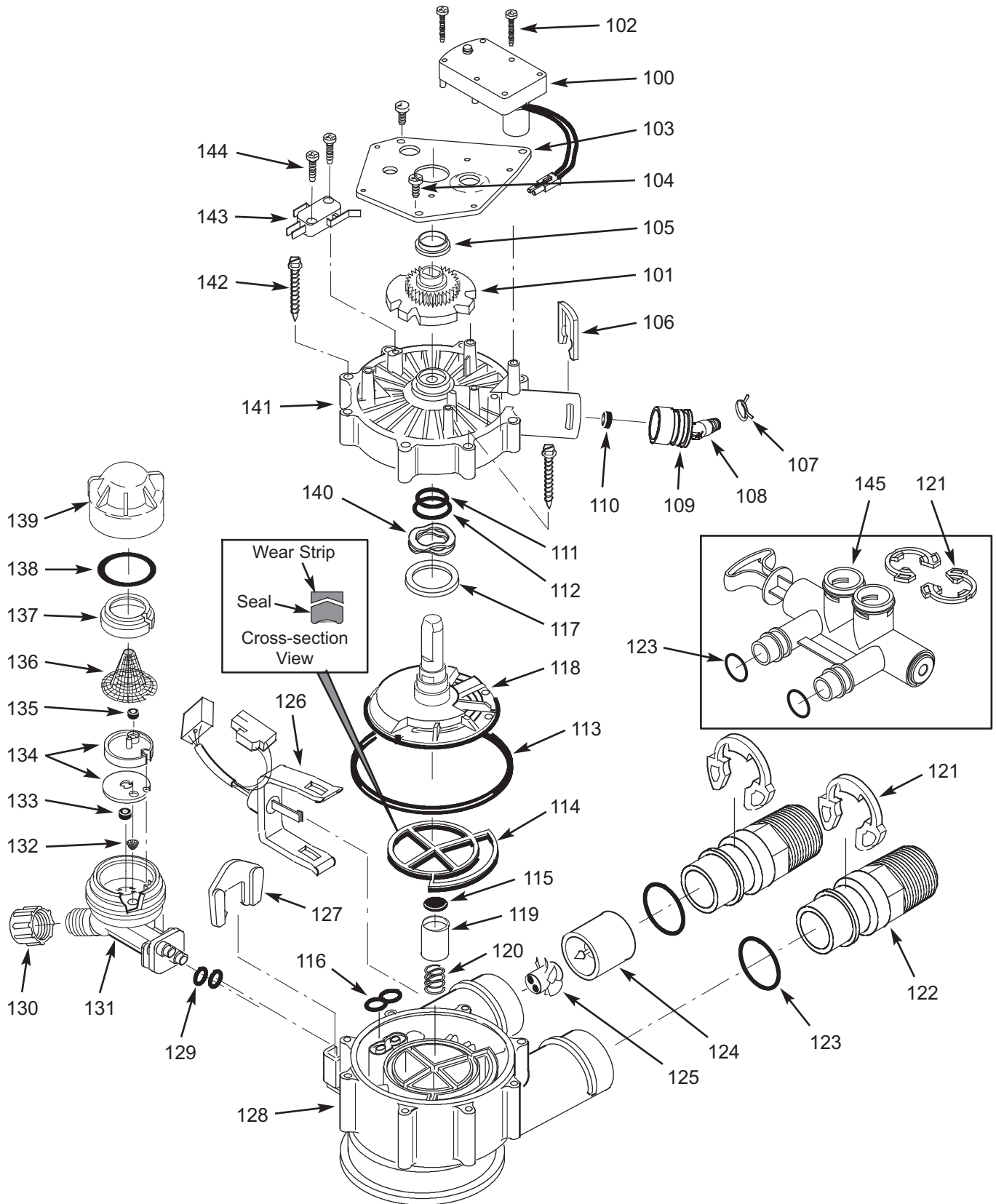

Valve Parts List – Models IDP40S, IDP40CC & IDP50CC

Key No.	Part No.	Description
–	7373828	Motor, Cam & Gear Kit, 1” (includes Key Nos. 100-102)
100	↑	Motor
101	↑	Cam & Gear
102	7224087	Screw, #8-32 x 1” (2 req.)
103	7231393	Motor Plate
104	0900857	Screw, #6-20 x 3/8” (3 req.)
105	7171250	Bearing
–	7331169	Drain Hose Adaptor Kit (incl. Key Nos. 106-110)
106	↑	Clip, Drain
107	↑	Hose Clamp
108	↑	Drain Hose Adaptor
109	↑	O-Ring, 15/16” x 1-3/16”
110	↑	Flow Plug, 2.0 gpm
–	7185487	Seal Kit (includes Key Nos. 111-116)
111	↑	O-Ring, 5/8” x 13/16”
112	↑	O-Ring, 1-1/8” x 1-1/2”
113	↑	O-Ring, 4-1/2” x 4-7/8”
114	↑	Rotor Seal
115	↑	Seal
116	↑	Seal, Nozzle & Venturi
117	7174313	Bearing, Wave Washer
118	7185500	Rotor & Disc
–	7342712	Drain Plug Kit, 1” (includes Key Nos. 115, 119 & 120)
119	↑	Plug, Drain Seal
120	↑	Spring
121	7089306	Clip, 1”, single (2 req.)
	7336428	Clip, 1”, pack of 20
122	7271204	Installation Adaptor, 1”, single (2 req.)
	7336614	Installation Adaptor, 1”, pack of 10 (includes 10 ea. of Key No. 123)

Key No.	Part No.	Description
123	7311127	O-Ring, 1-1/16” x 1-5/16”, single (2 req.)
	7336410	O-Ring, 1-1/16” x 1-5/16”, pack of 20
–	7290931	Turbine & Support Assembly (includes 1 ea. of Key Nos. 124, 125 & 2 ea. of Key No. 123)
124	↑	Turbine Support & Shaft
125	↑	Turbine
126	7309811	Wire Harness, Sensor
127	7081201	Retainer, Nozzle & Venturi
128	7171145	Valve Body
129	7270319	O-Ring, 1/4” x 3/8” (2 req.)
130	1202600	Nut - Ferrule
–	7257454	Nozzle & Venturi Assembly (incl. Key Nos. 127, 129 & 131-139)
131	7081104	Housing, Nozzle & Venturi
132	7095030	Cone Screen
133	1148800	Flow Plug, .3 gpm
134	7114533	Nozzle & Venturi Kit w/Gasket
	7204362	Gasket only, single
	7336486	Gasket only, pack of 20
135	7084607	Flow Plug, .15 gpm
136	7146043	Screen
137	7167659	Screen Support
138	7170262	O-Ring, 1-1/8” x 1-3/8”, single
	7336436	O-Ring, 1-1/8” x 1-3/8”, pack of 20
139	7199729	Cap
140	7175199	Wave Washer
141	7171161	Valve Cover
142	7172997	Screw, #10 x 2-5/8” (8 req.)
143	7305150	Switch
144	7140738	Screw, #4-24 x 3/4” (2 req.)
145	7214383	Bypass Valve, 1” * (includes 2 ea. of Key Nos. 121 & 123)

* Optional parts, not included with softener.

LIMITED WARRANTY

IDP30/40/50 Series Water Softener

Warrantor: Ecodyne Water Systems, 1890 Woodlane Drive, Woodbury, MN 55125

Warrantor guarantees to the original owner that:

for the LIFETIME of the original owner, the RESIN TANK will not rust, corrode, leak, burst, or in any other manner fail to perform its proper functions and that,

for a period of TEN (10) YEARS after installation, the SALT TANK will be free of defects in materials and workmanship and will perform its proper function and that,

for a period of THREE (3) YEARS after installation, the VALVE BODY, ELECTRONIC FACEPLATE and ALL OTHER PARTS will be free of defects in materials and workmanship and will perform their normal functions.

Only on Models IDP40CC and IDP50CC is the MEDIA BED guaranteed, for a period of SEVEN (7) YEARS after installation, to be free of defects in materials and workmanship and to reduce chlorine taste and odor from a municipal water supply.

If, during the respective warranty period, a part proves, after inspection by Warrantor, to be defective, Warrantor will, at its sole option repair or replace that part at no charge, other than normal shipping, installation or service charges.

General Provisions

The above warranties are effective provided the water softener is operated at water pressures not exceeding 125 psi, and at water temperatures not exceeding 100°F; provided further that the water softener is not subject to abuse, misuse, alteration, neglect, freezing, accident or negligence; and provided further that the water softener is not damaged as the result of any unusual force of nature such as, but not limited to, flood, hurricane, tornado or earthquake. Warrantor is excused if failure to perform its warranty obligations is the result of strikes, government regulation, materials shortages, or other circumstances beyond its control.

To obtain warranty service, notice must be given, within thirty (30) days of the discovery of the defect, to your local dealer or representative.

THERE ARE NO WARRANTIES ON THE WATER SOFTENER BEYOND THOSE SPECIFICALLY DESCRIBED ABOVE. ALL IMPLIED WARRANTIES, INCLUDING ANY IMPLIED WARRANTY OF MERCHANTABILITY OR OF FITNESS FOR A PARTICULAR PURPOSE, ARE DISCLAIMED TO THE EXTENT THEY MIGHT EXTEND BEYOND THE ABOVE PERIODS. THE SOLE OBLIGATION OF WARRANTOR UNDER THESE WARRANTIES IS TO REPLACE OR REPAIR THE COMPONENT OR PART WHICH PROVES TO BE DEFECTIVE WITHIN THE SPECIFIED TIME PERIOD, AND WARRANTOR IS NOT LIABLE FOR CONSEQUENTIAL OR INCIDENTAL DAMAGES. NO DEALER, AGENT, REPRESENTATIVE, OR OTHER PERSON IS AUTHORIZED TO EXTEND OR EXPAND THE WARRANTIES EXPRESSLY DESCRIBED ABOVE.

Some states do not allow limitations on how long an implied warranty lasts or exclusions or limitations of incidental or consequential damage, so the limitations and exclusions in this warranty may not apply to you. This warranty gives you specific legal rights, and you may have other rights which vary from state to state.