COMPONENTS

Comprehensive range of accessories

Our extensive assortment of accessories for press brakes and tools helps to maximize flexibility and extend their capabilities. WILA accessories are compatible with our New Standard Tooling and New Standard Tool Holders. From non-marking protective cloth to efficient Tool Storage Systems WILA has everything you need.



Hydraulic-Power Pack HM10 and HM11 type H-R (with remote control).

Hydraulic Power Pack HM10 and HM11 type H (Manual operation) or C (linked to the CNC control).

COMPONENTS

HYDRAULIC POWER PACK FOR USE IN COMBINATION WITH CLAMPING, CROWNING, BOTTOM TOOL HOLDERS & (A3) CLAMPING BARS.

Type	Optional
HM10-400-H	Manual operation ¹ , 400V-50Hz-3ph
HM10-400-H-R	Manual operation ² , 400V-50Hz-3ph
HM10-400-C	Linked to the CNC control, 400V-50Hz-3ph
HM11-460/230-H dual voltage	Manual operation ¹ , 230/460V-60Hz-3ph, supplied at 460V
HM11-460/230-H-R dual voltage	Manual operation ² , 230/460V-60Hz-3ph, supplied at 460V
HM11-230/460-H dual voltage	Manual operation ¹ , 230/460V-60Hz-3ph, supplied at 230V
HM11-230/460-H-R dual voltage	Manual operation ² , 230/460V-60Hz-3ph, supplied at 230V
HM12-460/230 dual voltage	Fully integratable in the press brake ³ , valve 24 V supplied at 460V
HM13-400	Fully integratable in the press brake ³ , valve 24 V
Manual pump	Manual operation with hand lever and relief valve
Extra hydraulic hose	Hose L=2.5 m equipped with straight fitting and fitting for extra hose

Comments.

- ¹) Operation via push button on the Power Pack
- ²) Comes with a remote control.
- ³) Only for press brake manufacturers
- All Hydraulic Power Packs have a Ø10 connection and are supplied with one hose measuring 2.5 meters.
- All Hydraulic Power Packs with dual voltage have been specially developed for the North American market.

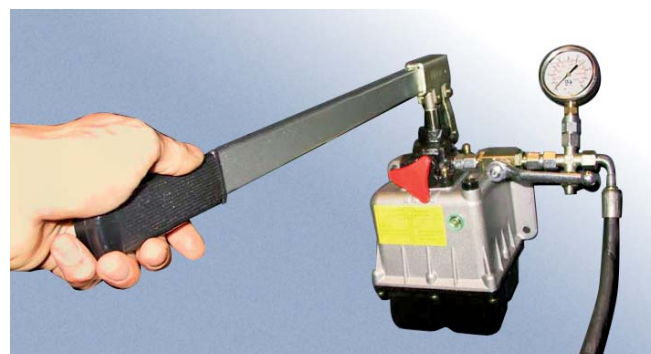

Manual pump.

PRESS BRAKE PRODUCTIVITY CABINETS®

In order to be able to store tools in an organized and safe way, WILA has put on the market its Press Brake Productivity Cabinet.



COMPONENTS

DRAWER SAFETY LOCK



All drawers are provided with an additional locking device to ensure that the drawer never can be opened by itself.

These tool cabinets are delivered standard with:

- 1 shallow drawer, weight capacity of 100 kg/224 lbs, to store measuring tools etc.
- A base with removable kick plates front and back to allow for easy movement with fork-lift or pallet truck.
- A tilting guard, so that only 1 drawer at a time can be opened.
- Lockable doors.
- All drawers are provided with an additional locking device.
- A black rubber mat on top.
- 5 drawers with perforated bottom, weight capacity of 200 kg/448 lbs each. The distance between the drawers can be adjusted easily in steps of about 25 mm/1".
- The arrangement of the tool drawers can be adjusted according to the height of the tools to be stored.
- Each drawer has two bottom plates made from practically indestructible nylon with milled slots designed especially to hold vertically all WILA tools according to their adaption widths.

Each drawer also includes one nylon spacer plate.

- WILA has 3 bottom plates in the program.
 - Bottom plate type no. 377487 suitable for the OZU lower tools of the complete New Standard program, and the BIU top tools of the American Style and American Vintage programs with AS II adaption.
 - Bottom plate type no. 22086 suitable for the BIU top tools of the complete New Standard program.
 - Bottom plate type 22084 suitable for American Style top tools with AS I adaption.
 - Drawers, bottom and spacer plates (type no. 22088) can be delivered separately.

WILA has more cabinet arrangements available, more information can be received upon request.

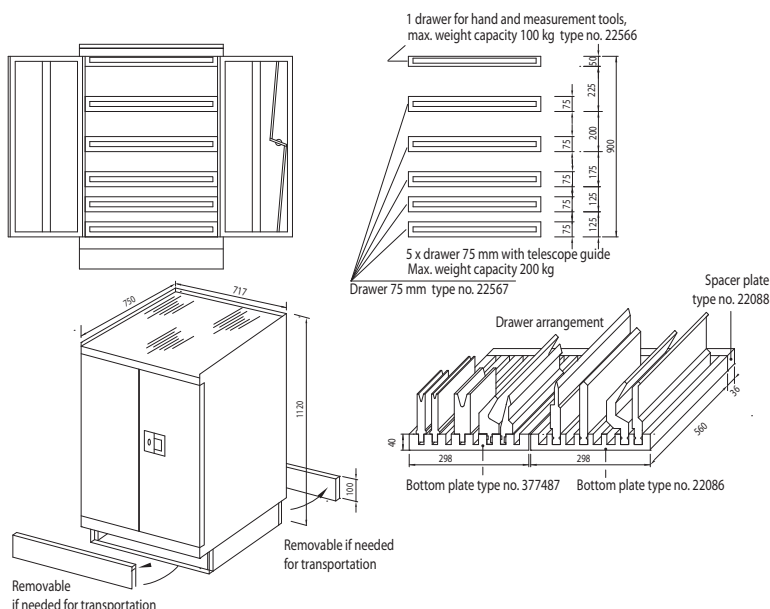

COMPONENTS

USABLE FOR TOOLS WITH ADAPTION



NS I head load

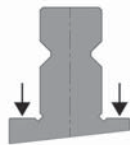

NS II shoulder load

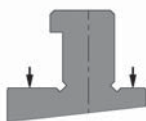

AS I shoulder load

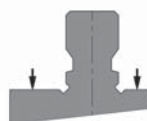

AS II shoulder load

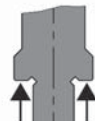

NS V shoulder load

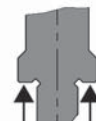

NS VI shoulder load
with V-Lock®

PRESS BRAKE PRODUCTIVITY TOOLSTATION[®]

The Press Brake Productivity ToolStation has been specifically designed to safely change and store (heavy) New Standard tooling. Tool changing and storage operates on its best, when using upper and lower tools, equipped with WILA's E2M[®] bearing system. The loading arm, on which the required tools are rolled back and forth, is attached to a (heavy duty) guide rail. This creates a very stiff and stable transfer arrangement that ensures perfect alignment between the loading arm and the upper and lower tools. This guarantees safety and convenience when moving the tooling from the loading arm into the press brake.

Due to required safety and construction modifications to the press brake it is only possible to order a ToolStation via a press brake manufacturer.

COMPONENTS



Each upper Tool Holder, used in combination with a Press Brake Productivity ToolStation, requires a dedicated guard with a safety mechanism for safe loading and unloading of the top tools (with E2M[®]). The movable load/unload arm will lock and unlock the guard.



Each lower Tool Holder, used in combination with a Press Brake Productivity ToolStation, requires a dedicated guard with a safety mechanism for safe loading and unloading of the bottom tools (with E2M[®]). The movable load/unload arm will lock and unlock the guard.



STANDARD
ToolStation with 1 load/unload arm (left or right)
Dimensions approx 2500 mm x 1500 mm
Height of load surface for dies is adjustable between 940 mm and 1065 mm
Daylight opening 490 mm/25.591"
Guards to suit WILA made New Standard Premium HC Tool Holders
Storage capacity 12 meters of punches and dies
Upper storage and load/unload arm equipped to support E2M® centric and eccentric
Max. weight on load/unload arm 250 kg/560 lbs (100 top and 150 bottom)
Loading and unloading possible at all storage positions
Storage area achievable from 3 sides
Usable for tools with max. wide 300 mm (centric against centerline)
Color 'WILA black'
OPTIONAL
Other daylight openings
2 drawers in front of ToolStation to load extra tooling (max. load 200 kg/448 lbs each)
Support rail under load/unload arm
ToolStation modules with different dimensions
Color according customers request

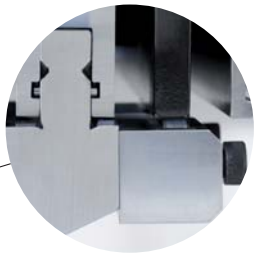

ToolStation comes equipped for 'Gooseneck' shaped New Standard top tools with extra side adjustment making it extremely easy and safe to exchange.



All ToolStations are equipped for New Standard top tools (with E2M®) making it extremely easy and safe to exchange.



All ToolStations are equipped for New Standard bottom tools (with E2M®) making it extremely easy and safe to exchange.

LA-E2M

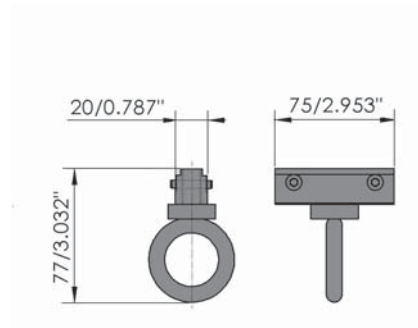

Type	Length	Weight		Max load t/m
		kg	lbs	
LA-E2M	75 mm	2.0	4.4	-

Allows easy lifting and moving heavy OZU bottom tools that are equipped with eye bolt holes within the press brake. Suitable for any NSCL Clamping System. Comes with E2M® as standard and lifts max 75 kg/168 lbs.

AUTOMATIC TOOL CHANGE (ATC) GRIPPER[®]

With the introduction of the ATC-G7 Gripper, WILA makes it possible for robotic press brakes to bend small batches of various products in random order fully automatically. Now bending on demand has been made possible.



By automating tool change overs, the tooling set-up in your press brake is no longer the limiting factor in the variety of parts that can be formed entirely unmanned. The robot or the manipulator changes its part gripper to the ATC-G7 Gripper, changes the tooling set-up very quickly, and is ready to bend the next part(s).

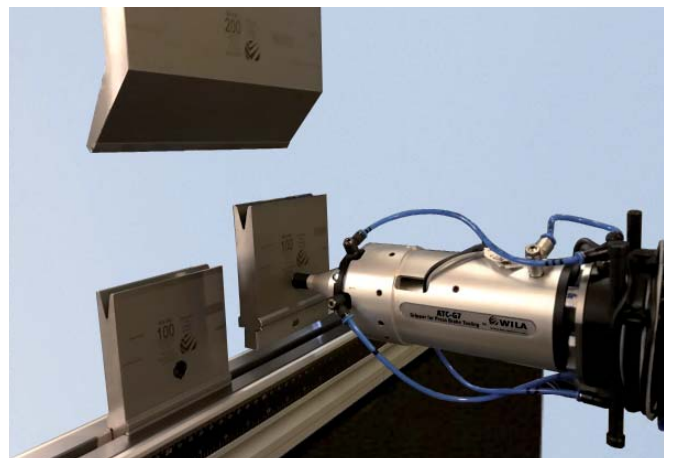

GRIPPER ATC-G7

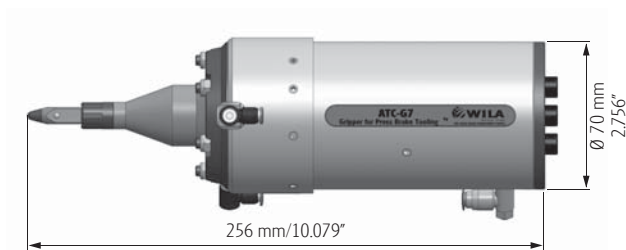

Allow automatic loading and unloading of all current models of our New Standard tooling program executed with ATC Adaptor.

DOCKING STATION

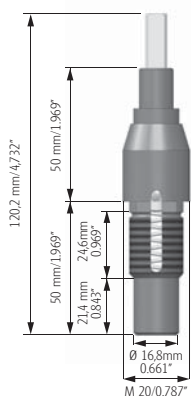

Holds all current models of our New Standard tooling program executed with ATC Adaptor up to 100mm.

SET DOCKING PINS

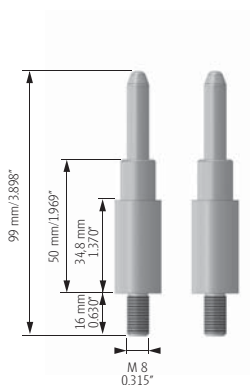

Set of 2 Docking Pins. Holds all current models of our New Standard tooling program executed with ATC Adaptor > 100mm.

ATC-ADAPTOR BIU



All New Standard top tools (BIU) with lengths from 20-255 mm/0.787"-10.039", when equipped with this ATC-Adaptor, can be automatically loaded and unloaded by the ATC-G7 Gripper. In this case the ATC-G7 Gripper will operate the Safety-Click®! Max tool weight is 12,5 kg/27.6 lbs Adaptor can be placed in new and existing BIU top tools.

ATC-ADAPTOR OZU



All New Standard bottom tools (OZU) with lengths from 20-255 mm/0.787"-10.039", when equipped with this ATC-Adaptor, can be automatically loaded and unloaded by the ATC-G7 gripper. Max tool weight is 12,5 kg/27.6 lbs. Adaptor can be placed in new and existing OZU bottom tools.

GRIPPER ATC-G7

Specifications	
Size	Ø70*256mm/2.756" * 10.079"
Weight	2,5 kg/5.5 lbs
Change-over time	5 seconds
Max. tool weight	12,5 kg/27.6 lbs
Min. - max. tool length	20-255mm/0.787" - 10.039"
Tool shapes	handles all the WILA New Standard top and bottom tool models

K-001/5

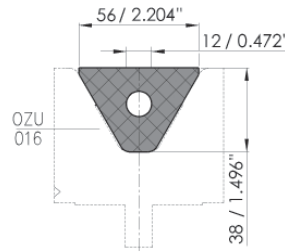

Type	Length	Weight		Max load
		kg	lbs	
K-001/5	ca 2100 mm	1.5	3.3	-

Adiprene inserts for bending material without marking. To be used in bottom tools type OZU-016. Use dependent on material type, thickness, angles and radius size. Available in 85 Shore A and 95 Shore A.

K-003

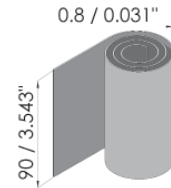

Type	Length	Weight		Max load
		kg	lbs	
K-003	unlimited	-	-	-

Protective foil for bending material without marking. Use dependent on material type, thickness, angles, radius size and bending method.

K-004

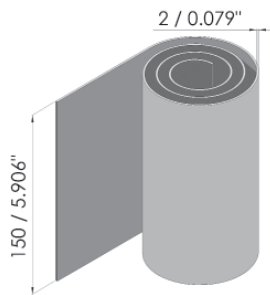

Type	Length	Weight		Max load
		kg	lbs	
K-004	unlimited	-	-	-

Protective foil for bending material without marking. Use dependent on material type, thickness, angles, radius size and bending method.

K-005

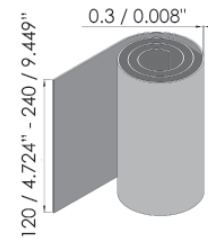

Type	Length	Weight		Max load
		kg	lbs	
K-005/120	unlimited	-	-	-
K-005/240	unlimited	-	-	-

NoMar Protective Cloth for bending material without marking. Use dependent on material type, thickness, angles, radius size and bending method.

USE OF FOIL OR CLOTH TO AVOID MARKING

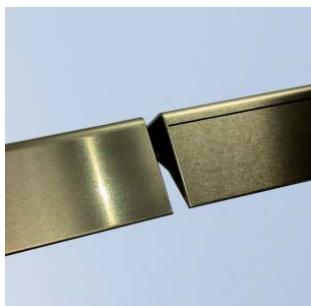

Foil or cloth can help to avoid marking on your part.

Advantage:

- No scratches, therefore no post-processing necessary.
- Time and cost savings.

CLAMPING SYSTEM FOR K-003/4/5

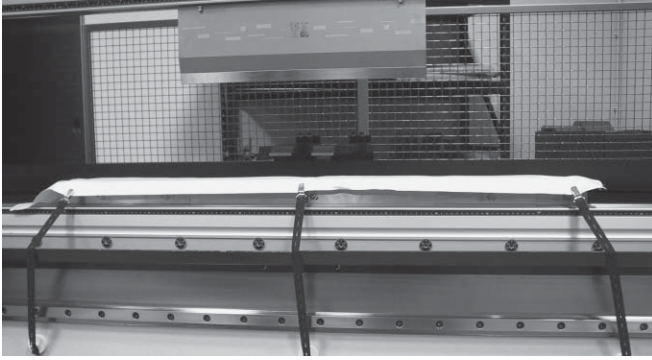

Set
Clamping set
Clamping system for protective foil/cloth K-003/K-004/K-005. 1 set consists of 6 magnets and 6 straps.

D(1+2)

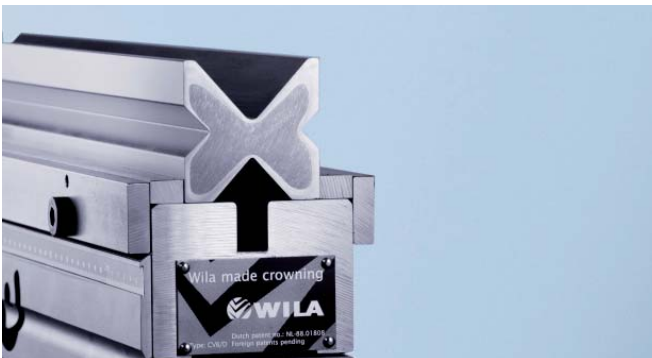

Type	Length	Weight	
		kg	lbs
D1	510 mm	1.2	2.6
D2	510 mm	0.6	1.3

Makes the crowning with Manual Clamping suitable for European Style bottom tools with a width of 60 mm. One set includes one bar of D1/D2.

4-WAY DIE CLAMP SET

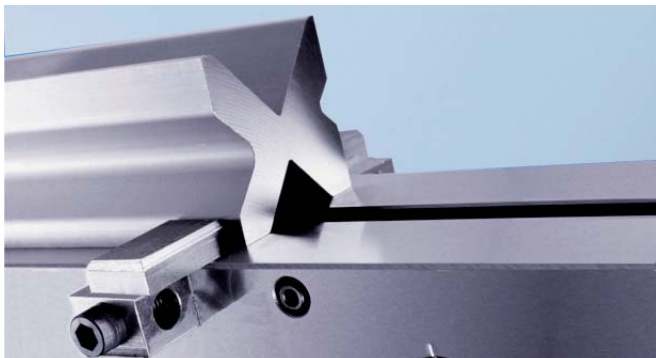

Set	Weight	
	kg	lbs
4-way die clamp set	1.5	3.3

Makes the crowning suitable for 4-ways dies with block size 2 3/4"; 3 1/4"; 3 3/4"; 4 1/4". One set includes 8 clamps.

COMPONENTS

PRESS BRAKE PRODUCTIVITY WAX



Press Brake Productivity Wax is a spray that has been specially developed for cleaning, maintaining and protecting WILA tools.

Required press force at 90° air bending, force in t/m.

The charts below give the appropriate tonnage to air bend mild steel.

Bending force for other metals:

- Soft aluminium : Tons per unit length x 50%
- Aluminum alloys heat treated : Tons per unit length x 100%
- Stainless : Tons per unit length x 150%
- Bottoming : Tonnage requirements are three to five times greater than for air bending.

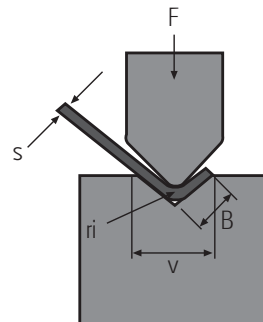

F = Tons per meter of workpiece
 s = Material thickness
 r_i = Inside radius of formed part
 v = V-die opening
 B = Minimum flange

Metric

V (mm)	4	6	8	10	12	16	20	24	30	40	50	60	80	100	120	160
V (inch)	0.157"	0.236"	0.315"	0.394"	0.472"	0.630"	0.787"	0.945"	1.181"	1.575"	1.969"	2.362"	3.150"	3.937"	4.724"	6.299"
B (outside mm)	2.8	4.2	5.6	7	8.6	11.5	14.4	17	21	29	36	42.4	56.5	71	85	114
ri (mm)	0.6	1	1.2	1.5	1.8	2.4	3	3.6	4.5	6	7.5	9	12	15	18	24

Material Thickness
mm

0.5	4	2															
1		10	8	5.5	4.5												
1.2		16	12	9	7												
1.5			20	14	11	8	6										
2					22	15	11	9.5									
2.5						25	19	15	11								
3							28	22	17	12							
4								44	33	22.5	17						
5									55	37	29	22					
6										58	42	34					
8											83	65	45	35			
10												110	75	57	45		
12													116	85	68		
14														121	91	68	
15														143	112	79	
16														168	131	90	
18															172	119	
20																222	150
25																	254

Inch

V (mm)	6.4	9.5	12.7	15.9	19.05	22.2	25.4	28.6	31.8	38.1	50.8	63.5	80	100	120	160
V (inch)	0.250"	0.375"	0.500"	0.625"	0.750"	0.875"	1.000"	1.125"	1.250"	1.500"	2.000"	2.500"	3.150"	3.937"	4.724"	6.299"
B (outside inch)	0.167"	0.265"	0.354"	0.442"	0.530"	0.619"	0.707"	0.795"	0.866"	1.06"	1.414"	1.768"	2.224"	2.795"	3.346"	4.488"
ri (inch)	0.038"	0.056"	0.075"	0.094"	0.113"	0.131"	0.150"	0.169"	0.188"	0.225"	0.300"	0.375"	0.472"	0.591"	0.709"	0.945"

Material Thickness
Gauge Inches

20	0.036"	3.2	2.0															
18	0.048"	5.1	3.4	2.7	2.4													
16	0.060"		5.8	4.0	3.1	2.5												
14	0.075"			6.9	5.0	4.0	3.5											
12	0.105"					8.3	6.9	5.6										
11	0.120"						9.9	8.2	7.2	5.4								
10	0.135"						11.9	9.9	7.3	7.1	5.8							
3/16"	0.188"								14.3	14.2	12.2	7.5						
1/4"	0.250"										23.7	16.5	11.4					
5/16"	0.313"											27	19.7					
3/8"	0.375"											42.3	30.9	22.8	16.9			
7/16"	0.438"													32.2	24.3	19.4		
1/2"	0.500"														34.6	27.0	18.3	
5/8"	0.625"															47.1	32.0	
3/4"	0.750"																74.2	50.4
7/8"	0.875"																	73.9
1"	1.000"																	103.0

ALL SORTS OF INFORMATION

Mild steel

Rm≈42 KN/cm²
Rm≈55-60.000 PSI



Rm≈42 KN/cm²
Rm≈55-60.000 PSI



Thickness

Tonnage

D

Tonnage

D

mm	inches	t/m	US t/ft	mm	inches	t/m	US t/ft	mm	inches
0.6	.024	12	4.0	2.3	.091	20	6.7	1.3	.051
0.8	.031	16	5.4	2.3	.091	30	10.1	1.7	.067
1.0	.039	20	6.7	2.4	.095	30	10.1	2.2	.087
1.2	.047	24	8.1	3.0	.118	40	13.4	2.5	.098
1.5	.059	30	10.1	4.4	.173	50	16.8	3.5	.138
2.0	.079	40	13.6	5.1	.201	60	20.2	4.2	.165
2.5	.098	65	21.8	6.6	.260				
3.0	.118	90	30.2	8.2	.323				

Stainless steel

Rm≈70 KN/cm²
Rm≈100.000 PSI



Rm≈70 KN/cm²
Rm≈100.000 PSI

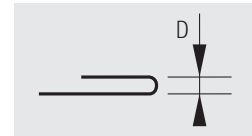

Thickness

Tonnage

D

Tonnage

D

mm	inches	t/m	US t/ft	mm	inches	t/m	US t/ft	mm	inches
0.6	.024	20	6.7	2.3	.091	35	11.8	1.3	.051
0.8	.031	27	9.0	2.3	.091	50	16.8	1.7	.067
1.0	.039	34	11.4	2.4	.095	50	16.8	2.2	.087
1.2	.047	40	13.5	3.0	.118	80	26.9	2.5	.098
1.5	.059	50	16.8	4.4	.173	85	28.6	3.5	.138
2.0	.079	90	30.3	5.1	.201	120	40.4	4.7	.185
2.5	.098	110	37.0	8.6	.339				
3.0	.118	125	42.0	10.4	.409				

ALL SORTS OF INFORMATION

THE COLD HARD TRUTH! CNC-DEEPHARDENING® VERSUS NITRIDE

Due to improvements in quality and durability, press brake tooling is no longer a perishable commodity. When properly cared for and used within the correct range of applications, today's precision ground and hardened press brake tooling can often provide an extremely long usable service life. That is not to say that it will simply last for ten years or more, but rather, it will provide performance that is the same or nearly the same as it did when it was brand new and right out of the box for that long or longer.

This is certainly not true of all press brake tooling. It is true however of high quality precision ground and hardened press brake tooling. As such, when purchasing tooling for a new press brake, today's press brake buyer is now more than ever making a long term decision. And as with any other long term business decision, you'll want to make the decision that will provide you with maximum productivity and the maximum return on your investment.

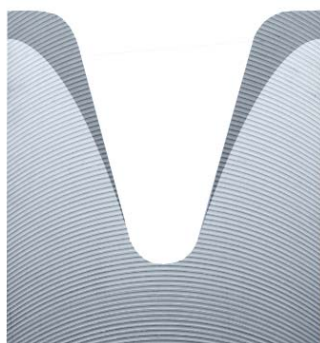

*Bottom tool with WILA's proprietary
CNC-Deephardenig® process applied.*

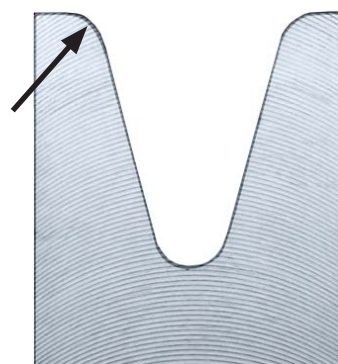

*Bottom tool with competitors Nitride
process applied.*