

Test Report For:  
**SPIG Industries, LLC**  
**SGET End Terminal**



TESTED TO:  
**Manual for Assessing Safety Hardware (MASH 2016)**  
**Test 3-35**

PREPARED FOR:  
**SPIG Industries, LLC**  
**14675 Industrial Park Road**  
**Bristol, Virginia 24202**

TEST REPORT NUMBER:  
**TR-P38032-01-A**

REPORT DATE:  
**August 20, 2018**

TEST DATE:  
**March 12, 2018**





**KARCO Engineering, LLC. TL-371**  
Automotive Safety and Testing Facility  
9270 Holly Road, Adelanto, CA 92301  
Tel: (760) 246-1672 Fax: (760) 246-8112  
[www.KARCO.com](http://www.KARCO.com)

KARCO Engineering compiled this publication for information gathering only. The findings and conclusions expressed in this publication are those of the authors and not necessarily those of any other organization. KARCO Engineering provides test services only and is not involved in consulting, product design or the manufacturing of any highway safety products. KARCO does not warrant, supervise or monitor compliance of products or services except as specifically agreed to in writing. By their very nature, testing, analysis and other KARCO services are limited in scope and subject to expected measurement variability. No activity by KARCO Engineering can release a manufacturer from product or any other liability. The results, findings and conclusions expressed in this publication relate only to the items tested for the specific situation simulated in the test.

Tested By:   
Mr. Robert L. Ramirez  
Project Engineer

Report By:   
Mr. Robert L. Ramirez  
Project Engineer

Reviewed By:   
Mr. Andrew J. Espindola  
Quality Assurance Manager

Approved By:   
Mr. Michael L. Dunlap  
Director of Operations

Approval Date: August 20, 2018

**REVISION CONTROL LOG**

**TR-P38032-01**

<b>Revision</b>	<b>Date</b>	<b>Description</b>
-NC	08/20/18	Original Test Report
-A	09/20/21	Updated Manufacturer's Drawings

## TECHNICAL REPORT DOCUMENTATION PAGE

<b>1. Report No.</b> TR-P38032-01-A	<b>2. Government Accession No.</b>	<b>3. Recipients Catalog No.</b>	
<b>4. Title and Subtitle</b> Final Test Report SPIG Industries, LLC SGET End Terminal MASH 2016 Test 3-35		<b>5. Report Date</b> August 20, 2018	
		<b>6. Performing Organization Code</b> KAR	
<b>7. Author(s)</b> Mr. Robert L. Ramirez, Project Engineer, KARCO		<b>8. Performing Organization Report No.</b> TR-P38032-01-A	
<b>9. Performing Organization Name and Address</b> KARCO Engineering, LLC. 9270 Holly Rd. Adelanto, CA 92301		<b>10. Work Unit No.</b>	
		<b>11. Contract or Grant No.</b>	
<b>12. Sponsoring Agency Name and Address</b>		<b>13. Type of Report and Period Covered</b> Final Test Report, Mar. 12 - Aug. 20, 2018	
		<b>14. Sponsoring Agency Code</b>	
<b>15. Supplementary Notes</b>			
<b>16. Abstract</b>  One (1) Test Level 3, Test 35 (3-35) was performed on the subject SPIG Industries, LLC SGET end terminal. The terminal was impacted by a 2012 RAM 1500 4-door pickup truck. Testing was conducted by KARCO Engineering, LLC. in Adelanto, CA on March 12, 2018.  The test vehicle impacted the SGET end terminal at a velocity of 59.63 mph (95.97 km/h) and an impact angle of 25.2°. The vehicle impacted the article at its length-of-need point and the vehicle was redirected. The vehicle exited within the exit box and contacted the system a second time downstream. The system was damaged from post 1 through post 7.  The test vehicle sustained damage to its front passenger side. The front wheel assembly was damaged and the tire punctured. The passenger side of the vehicle was damaged down its length. The occupant compartment was not penetrated and the deformation limits were not exceeded.  The SPIG Industries, LLC SGET met all the requirements for MASH 2016 Test 3-35.			
<b>17. Key Words</b> SPIG Industries, LLC SGET Terminal MASH 2016 3-35		<b>18. Distribution Statement</b>	
<b>19. Security Classification of this report</b>	<b>20. Security Classification of this page</b>	<b>21. No. of Pages</b> 75	<b>22. Price</b>

# Table of Contents

<b>1. INTRODUCTION .....</b>	<b>1</b>
1.1 PROBLEM STATEMENT .....	1
1.2 OBJECTIVE.....	1
1.3 SCOPE.....	1
<b>2. SYSTEM DETAILS.....</b>	<b>2</b>
2.1 TEST ARTICLE .....	2
<b>3. TEST REQUIREMENTS AND EVALUATION CRITERIA.....</b>	<b>4</b>
3.1 TEST REQUIREMENTS.....	4
3.2 EVALUATION CRITERIA.....	4
3.3 SOIL STRENGTH REQUIREMENTS.....	5
<b>4. TEST CONDITIONS .....</b>	<b>6</b>
4.1 TEST FACILITY.....	6
4.2 VEHICLE TOW AND GUIDANCE SYSTEM .....	6
4.3 TEST VEHICLES.....	6
4.4 DATA ACQUISITION SYSTEMS .....	8
4.4.1 TEST VEHICLE INSTRUMENTATION .....	8
4.4.2 CALIBRATION.....	8
4.4.3 PHOTOGRAPHIC DOCUMENTATION.....	8
4.4.4 MEASUREMENT UNCERTAINTY.....	9
<b>5. CRASH TEST RESULTS.....</b>	<b>10</b>
5.1 STATIC SOIL TEST .....	10
5.2 WEATHER CONDITIONS .....	10
5.3 MASH 2016 TEST 3-35 .....	10
5.4 TEST DESCRIPTION .....	11
5.5 TEST ARTICLE DAMAGE .....	11
5.6 TEST VEHICLE DAMAGE .....	11
5.7 STRUCTURAL ADEQUACY .....	12
5.8 OCCUPANT RISK.....	12
5.9 DISCUSSION AND SUMMARY OF RESULTS.....	13
<b>MASH 2016 TEST 3-35 SUMMARY .....</b>	<b>15</b>
<b>APPENDIX A.....</b>	<b>A</b>
<b>APPENDIX B.....</b>	<b>B</b>
<b>APPENDIX C.....</b>	<b>C</b>
<b>APPENDIX D.....</b>	<b>D</b>
<b>APPENDIX E.....</b>	<b>E</b>
<b>APPENDIX F.....</b>	<b>F</b>

## List of Tables

Table 1 MASH 2016 TL-3 Test Matrix for Redirective Terminals .....	4
Table 2 MASH 2016 Evaluation Criteria for Terminals and Crash Cushions .....	5
Table 3 Vehicle Instrumentation List for Test 3-35 .....	8
Table 4 High Speed Camera Information Test 3-35 .....	9
Table 5 Weather Conditions Test 3-35.....	10
Table 6 Maximum Occupant Compartment Deformation by Location.....	12
Table 7 Summary of Occupant Risk Factors .....	13
Table 8 Evaluation Criteria Summary .....	14

## List of Figures

Figure 1 Test 3-35 Vehicle Information .....	7
Figure 2 Summary of Test 3-35.....	15
Total Number of Pages .....	75
Final Page of Report .....	F-1

Quantity	Typical Application	Std Units	Metric Unit	Multiply By
Mass	Vehicle Weight	lb	kg	0.4536
Linear Velocity	Impact Velocity	miles/hr	km/hr	1.609344
Length or Distance	Measurements	in	mm	25.4
Volume	Fuel Systems	gal	liter	3.785
Volume	Small Fluids	oz	mL	29.574
Pressure	Tire Pressures	lbf/in <sup>2</sup>	kPa	6.895
Temperature	General Use	°F	°C	=(Tf -32)/1.8
Force	Dynamic Forces	lbf	N	4.448
Moment	Torque	lbf-ft	N•m	1.355

# 1. Introduction

## 1.1 Problem Statement

The purpose of this report is to detail the safety performance of the SPIG Industries, LLC Spig Gating End Terminal (SGET) when evaluated to the criteria set forth by *Manual for Assessing Safety Hardware* (MASH 2016).

## 1.2 Objective

The primary objective of this project was to evaluate the safety performance of the SGET when subjected to full-scale crash testing according to MASH 2016 Test Level 3, Test 35 (3-35) for redirective terminals.

## 1.3 Scope

This project consists of full-scale dynamic crash testing of the SGET end terminal. The system was subject to MASH 2016 Test 3-35. Test 3-35 was conducted with a 2270P test vehicle impacting the system at a nominal angle of 25° with the vehicle impacting the system at post 3.

## 2. System Details

### 2.1 Test Article

The SPIG Gating End Terminal (SGET) is an energy absorbing guardrail end treatment designed to reduce the severity of end on impacts with W-beam guardrail. When impacted the SGET feeds the rail through the impact head and exits to the non-traffic side of the system. The SGET system was composed of one (1) impact head, one (1) post 1 assembly, one (1) cable anchor system, one (1) specialty panel, and seven (7) yielding posts. The posts were spaced 75.0 in. (1.9 m) on centers with the rail splices located at the posts. The total terminal length was 50.0 ft. (15.2 m). The system was attached to 106.3 ft. (32.4 m) of standard guardrail with splices placed midspan. The system can be installed with a top rail height of 31 in.  $\pm$  1 inch. The as-tested system was installed with a rail height of 30.0 in. (762 mm) to increase the risk of vehicle override. The system was tested with an RFID chip attached to the impact head.

The impact head rests over the specialty panel and mounts to the first post with two (2) 3.0 in. (76 mm) long lag bolts and washers. The impact head was 64.0 in. (1.6 m) long and had a rear chute width of 5.0 in. (127 mm). The front face of the impact head was 24.0 in. (610 mm) tall and 17.0 in. (432 mm) wide. Welded 9.0 in. (229 mm) behind the front face of the impact head was a 0.625 in. (16 mm) thick steel post breaker plate. The chute was composed of 0.25 in. (6 mm) C-channel. The downstream end of the impact head tapers to an overall height of 13.5 in. (343 mm). There were two (2) 0.5 in. (13 mm) thick straps welded at the downstream end of the impact head.

Post 1 was a wooden post inserted into a steel foundation tube and once assembled was 8.9 ft. (2.7 m) long. The wooden post and foundation tube were connected with a 10.0 in. (254 mm) long 0.625 in. hex head bolt. The steel foundation tube was 6.0 in (152 mm) by 8.0 in. (203 mm) and 6.0 ft. (1.8 m) long. The wooden portion of post 1 was a 5.5 in. (140 mm) by 7.5 in. (188 mm) and was 4.2 ft. (1.3 m) long. The wooden portion had two (2) 0.75 in. (19 mm) holes drilled 13.0 in. (330 mm) down from the top to mount the strike plate and block. The strike plate and block were installed on the leading side of post 1 with one (1) 14.0 in. long 0.625 in. guardrail bolt, washer and guardrail nut. The rail does not attach to post 1 and there is no blackout.

The cable anchor assembly was secured to post 1 with a bearing plate and to the specialty panel with a guardrail grabber. The cable was routed through a 2.5 in (64 mm) hole located at the base of post 1. The bearing plate was 0.625 in (16 mm) thick and had two (2) 0.5 in. (13 mm) holes at the top used to secure the plate to post 1 with two (2) lag bolts. The downstream end of the cable assembly was the guardrail grabber. The grabber was 17.0 in. (432 mm) long and had



six (6) teeth that lock into the specialty panel. Between the specialty panel and the grabber there was a 17.0 in. (432mm) long reinforcement panel. The reinforcement panel was held onto the rail with six (6) 1.0 in long 1/2 in. bolts, twelve (12) washers, six (6) lock washers and six (6) nuts. The specialty panel was a standard 12 Ga w-beam section measuring 12.5 ft. (3.8 m) long and had six (6) rectangular slots cut for the guardrail grabber. The other three (3) panels in the terminal section were standard 12 Ga 12.5 ft. (3.8m) MGS guardrail panels.

Posts 2 through 8 were 6.0 ft. (1.8 m) long yielding posts. The yielding posts had two (2) 0.5 in. (13 mm) holes drilled through both of its flanges 31.0 in. (787 mm) from the top of the post. There was a 3.0 in. (76 mm) by 3.0 in. (76 mm) by 80.0 in. (2032 mm) long strut channel that was connected between post 1 and 2. The upstream end was mounted at the connection point of the foundation tube and wooden post. The downstream end of the strut was connected to post 2 with two (2) 2.0 in. long 1.5 in. bolts, four (4) washers, 2 lock washers and two (2) nuts. Post 2 attached to the specialty panel with a standard 1.25 in. long 0.625 in. guardrail bolt and nut with no blockout. Posts 3 through 8 used 8.0 in. (203 mm) deep notched wooden blockouts and 10.0 in. long 0.625 in. guardrail bolts.

After the terminal there was one (1) 9.4 ft. (2.9 m) panel to transition the splices to the midspan location. After the transition panel there were seventeen (17) W6x8.5 galvanized steel posts, seventeen (17) 8.0 in. (203 mm) deep notched wooden blocks and six (6) 12.5 ft. (3.8 m) MGS panels. The rails were spliced together with 1.25 in. long 5/8 in. guardrail splice bolts and nuts. The rails were held to the posts using 10.0 in. long 5/8 in. guardrail bolts and nuts. A second 9.4 ft. (2.9 m) transition panel was used before the downstream anchor and the installation was terminated with an SFT type anchor.

Photographs of the as-tested unit and installation are available in Appendix A of this report. The manufacturer's drawings are available in Appendix D. A complete set of manufacturer drawings are available in KARCO CD-R 2018-4897.

### 3. Test Requirements and Evaluation Criteria

#### 3.1 Test Requirements

The SGET system described in this report was classified as a redirective terminal. MASH 2016 recommends a series of up to nine (9) full scale crash tests to evaluate redirective terminals. However, Test 3-36 is intended for a system that had a rigid backup structure and is not applicable for this system. Test 3-38 is intended for a staging device and is not applicable for this system. Therefore Test 3-36 and 3-38 were not conducted.

**Table 1 MASH 2016 TL-3 Test Matrix for Redirective Terminals**

	Test Designation	Impact Conditions			Evaluation Criteria
	MASH Test No.	Vehicle	Nominal Speed (mph)	Nominal Angle (deg)	
<b>Test Level 3</b>	3-30	1100C	62	0	C,D,F,H,I,N
	3-31	2270P	62	0	C,D,F,H,I,N
	3-32	1100C	62	5-15	C,D,F,H,I,N
	3-33	2270P	62	5-15	C,D,F,H,I,N
	3-34	1100C	62	15	C,D,F,H,I,N
	3-35	2270P	62	25	A,D,F,H,I
	3-36	2270P	62	25	A,D,F,H,I
	3-37a	2270P	62	25	C,D,F,H,I,N
	3-37b	1100C			
	3-38	1500A	62	0	C,D,F,H,I,N

#### 3.2 Evaluation Criteria

Evaluation criteria for full-scale vehicle crash testing are based on three criteria: (1) Structural Adequacy, (2) Occupant Risk, and (3) Post-Impact Vehicular Response. Criteria for structural adequacy evaluate the article’s ability to allow redirection, controlled penetration, or controlled stopping of the vehicle. Occupant risk evaluates the degree of hazard to occupants in the impacting vehicle. Post-impact vehicular response is a measure of the potential of the vehicle to result in a secondary collision with other vehicles or fixed objects.

Post-Impact Head Deceleration (PHD), Theoretical Head Impact Velocity (THIV), and Acceleration Severity Index (ASI) occupant risk values have also been calculated for the evaluation of the crash tests.

**Table 2 MASH 2016 Evaluation Criteria for Terminals and Crash Cushions**

Evaluation Factors	Evaluation Criteria			
Structural Adequacy	A	Test article should contain and redirect the vehicle or bring the vehicle to a controlled stop, the vehicle should not penetrate, underide, or override the installation although controlled lateral deflection of the test article is acceptable.		
Occupant Risk	D.	Detached elements, fragments, or other debris from the test article should not penetrate or show potential for penetrating the occupant compartment or present undue hazard to other traffic, pedestrian, or personnel in a work zone.		
	F.	The vehicle should remain upright during and after collision. The maximum roll and pitch angles are not to exceed 75 degrees		
	H.	Occupant impact velocities (OIV) should satisfy the following		
		Occupant Impact Velocity Limits, ft/s (m/s)		
		Component	Preferred	Maximum
	Longitudinal and Lateral	30 ft/s (9.1 m/s)	40 ft/s (12.2 m/s)	
	I.	The occupant ridedown acceleration should satisfy the following limits		
		Occupant Ridedown Acceleration Limits (G)		
Component		Preferred	Maximum	
Longitudinal and Lateral	15.0 G	20.49 G		

**3.3 Soil Strength Requirements**

In accordance to Appendix B of MASH 2016, the soil strength must be verified before any full-scale crash testing can be conducted on soil-based installations. Two instrumented W6x16 posts are installed near the impact area of the installation. The posts are pulled prior to full-scale testing to ensure the soil meets 90% of the established baseline.

## **4. Test Conditions**

### **4.1 Test Facility**

This test series was conducted at KARCO Engineering's test facility in Adelanto, California.

### **4.2 Vehicle Tow and Guidance System**

The tow road is a continuous level surface constructed of reinforced concrete and measures 700.0 ft. (213.4 m) in length, 14.0 ft. (4.3 m) wide, and 6.0 in. (152 mm) thick. A steel rail is embedded in the road to provide vehicle guidance. Vehicle tow propulsion is provided by a 1 ton truck using a 1-to-2 pulley system. The test vehicle is towed into the test article by a nylon rope clamped to a 0.375 in. (10 mm) steel cable. The clamp is released from the cable on contact with a cable release mechanism positioned to allow the test vehicle to proceed under its own momentum for a maximum of 25.0 ft. (7.6 m) before impacting the test article.

### **4.3 Test Vehicles**

For test 3-35, a 2270P test vehicle was used. The vehicle was a 2012 RAM 1500 4-door pickup truck with a front mounted engine, automatic transmission, and rear wheel drive. The 2270P test vehicle had a curb and test inertial weight of 4,968.0 lbs (2,253.5 kg) and 5,006.6 lbs (2,271.0 kg), respectively. An Anthropomorphic Test Device (ATD) was not used for this test. The test vehicle information can be found in Figure 1.

Test Date..... 03/12/18      Project No..... P38032-01      Year..... 2012  
 Make..... RAM      Model..... 1500      Color..... White  
 Tire Size..... P265/70R17      Vehicle Vin #..... 1C6RD6FP2CS281365  
 Tire Inflation..... 40 psi      Odometer..... 145,818 mi

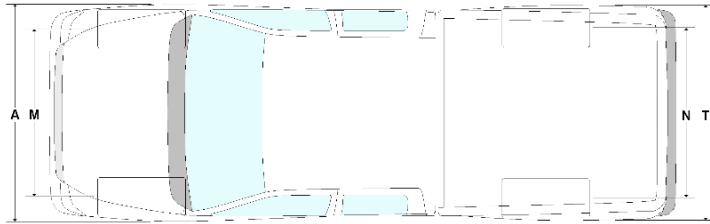

**GVWR Rating**

Total..... 6,700 lbs  
 Front..... 3,700 lbs  
 Rear..... 3,900 lbs

Engine Type..... V8  
 Engine Size..... 4.7 L  
 Transmission Type..... Automatic

Dummy Type..... None  
 Dummy Mass..... N/A  
 Seat Position..... N/A

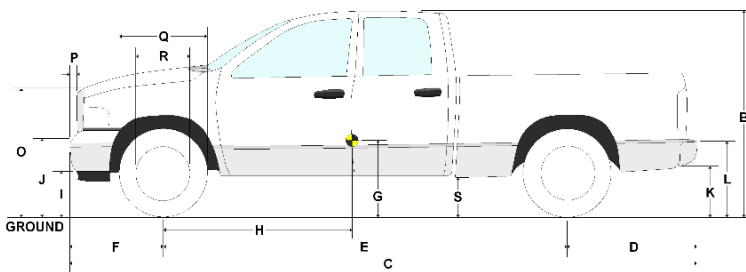

Previous Vehicle Damage....None

No.	Inches	mm	No.	Inches	mm	No.	Inches	mm	No.	Inches	mm
A	78.7	2000	F	40.9	1040	K	18.1	460	P	5.1	130
B	73.6	1870	G	28.3	720	L	29.1	740	Q	30.5	775
C	228.7	5810	H	64.6	1640	M	68.3	1734	R	18.5	470
D	47.4	1205	I	12.4	315	N	67.9	1725	S	13.1	334
E	140.4	3565	J	23.6	600	O	44.1	1120	T	79.5	2020

**TEST VEHICLE MASS**

	As Received (lbs)			Test Inertial (lbs)			Gross Static (lbs)		
	Front	Rear	Total	Front	Rear	Total	Front	Rear	Total
Left	1416.4	1048.3	2464.7	1319.4	1140.9	2460.3	1319.4	1140.9	2460.3
Right	1436.3	1067.0	2503.3	1396.6	1149.7	2546.3	1396.6	1149.7	2546.3
Ratio (%)	57.4	42.6	100.0	54.2	45.8	100.0	54.2	45.8	100.0
Total	2852.7	2115.3	4968.0	2716.0	2290.6	5006.6	2716.0	2290.6	5006.6

	As Received (kg)			Test Inertial (kg)			Gross Static (kg)		
	Front	Rear	Total	Front	Rear	Total	Front	Rear	Total
Left	642.5	475.5	1118.0	598.5	517.5	1116.0	598.5	517.5	1116.0
Right	651.5	484.0	1135.5	633.5	521.5	1155.0	633.5	521.5	1155.0
Ratio (%)	57.4	42.6	100.0	54.2	45.8	100.0	54.2	45.8	100.0
Total	1294.0	959.5	2253.5	1232.0	1039.0	2271.0	1232.0	1039.0	2271.0

Figure 1 Test 3-35 Vehicle Information

#### 4.4 Data Acquisition Systems

All data acquisition for this test of the terminal was performed in accordance with the MASH 2016 requirements.

##### 4.4.1 Test Vehicle Instrumentation

The test vehicle was instrumented with one (1) tri-axial accelerometer and one (1) tri-axial angular rate sensor. The set of accelerometers and angular rate sensors were mounted within 2.0 in. (50 mm) of the test vehicle's center of gravity in the x-y plane. The accelerometers measured longitudinal (x), lateral (y), and vertical (z) acceleration. The angular rate sensors measured roll (moment x), pitch (moment y) and yaw (moment z).

**Table 3 Vehicle Instrumentation List for Test 3-35**

Ch.	Location	Axis	Ident. No.	Description	MFR	Model	Units
1	Vehicle CG	X	P51708	Accel, Half Bridge	Endevco	7264-2K	g
2	Vehicle CG	Y	P51700	Accel, Half Bridge	Endevco	7264-2K	g
3	Vehicle CG	Z	P51696	Accel, Half Bridge	Endevco	7264-2K	g
4	Vehicle CG	Yaw	ARS8537	Rate Gyro	DTS	ARS-18K	Deg/s
5	Vehicle CG	Pitch	ARS8532	Rate Gyro	DTS	ARS-18K	Deg/s
6	Vehicle CG	Roll	ARS8486	Rate Gyro	DTS	ARS-18K	Deg/s

##### 4.4.2 Calibration

All instrumentation used in this test has been calibrated through standards traceable to NIST and is maintained in a calibrated condition.

##### 4.4.3 Photographic Documentation

Photographic documentation of this test series included a minimum of two (2) real-time video cameras at 30 frames per second (fps), and seven (7) high-speed color digital video cameras at 1,000 fps. All high-speed cameras were activated by a pressure-sensitive tape switch which was positioned on the test article to indicate the instant of contact (time zero). A digital still camera was used for documenting the pre- and post-test condition of the test article and the test vehicle.

**Table 4 High Speed Camera Information Test 3-35**

View No.	Location	Identification No.	Manufacturer	Type
1	Driver Overall View	7959	Phantom	V9
2	Passenger Overall View	6657	Phantom	V10
3	Inline Track View	8187	Phantom	V10
4	Inline Article View	6936	Phantom	V10
5	Overhead Close-up View	6710	Phantom	V.5.1
6	Overhead Overall View	6075	Phantom	V10
7	Obique View	8520	Phantom	V10

#### **4.4.4 Measurement Uncertainty**

Measurement uncertainties have been determined for pertinent values affecting the results of this test. KARCO maintains these uncertainty budgets, which are available upon request, but are not included in this report. In certain cases the nature of the test method may preclude rigorous and statistically valid calculation of uncertainty of measurement. In these cases KARCO attempts to identify the components of uncertainty and make a reasonable estimation. Reasonable estimation is based on knowledge of the performance of the method and on the measurement scope and makes use of, for example, previous experience and validation data.

## 5. Crash Test Results

### 5.1 Static Soil Test

Prior to full scale crash test P38032-01, a static soil test was conducted to ensure the soil condition was acceptable for full-scale crash testing. The static test results at 5.0 in. (127 mm) and 10.0 in. (254 mm) were above 90% of the baseline established during soil certification. The hydraulic ram stopped pulling the post at 13.8 in. (350 mm) and the load was 8,581.2 lbs. (38.2 kN) which is 3,764.7 lbs higher than the minimum requirement at this point. Based on the fact that there was only 1.2 in. left of displacement and the significantly stronger soil, approximately a 50% increase in strength from the requirement, the soil was deemed as acceptable for testing. The baseline value at 13.8 in. (351 mm) of displacement value is 4816.5 lbs (21.4 kN), the added strength can be attributed to the extended amount of time the installation was in the ground. KARCO deemed the soil acceptable for testing based on the assumption that the soil was acceptable from 0 to 13.8 in. (351 mm) and the remaining 1.2 in. (30 mm) of deflection should also be acceptable if the hydraulic ram had added capacity. Static test results can be found in Appendix C of this test report.

### 5.2 Weather conditions

Test No. P38032-01 was conducted on March 12, 2018 at approximately 10:39 A.M.

**Table 5 Weather Conditions Test 3-35**

Temperature	67 °F
Humidity	45%
Wind Speed	0 mph
Wind Direction	N/A

Information for reference only

### 5.3 MASH 2016 Test 3-35

As recommended in MASH 2016 a full-scale impact test was conducted to evaluate the impact performance of the Spig Industries, LLC SGET end terminal to MASH Test 3-35 on March 12, 2018. The test article was positioned at an angle of 25° with the vehicle impacting the system at post 3. The test was conducted using a commercially available 2012 RAM 1500 4-door pickup truck with a test inertial mass of 5,006.6 lbs (2,271.0 kg).



## **5.4 Test Description**

The test vehicle impacted the system at a velocity of 59.63 mph (95.97 km/h) and an angle of 25.2°. The vehicle was set to impact the system at the center of post 3 and the actual first point of contact with the system was 3.0 in. (76 mm) downstream from the center of post 3.

Upon impact the front bumper began to deform and the system started to deflect to the field side. The vehicle's front tire contacted post 4 at 0.085 s and caused the post to pull from the rail. The rail deflection caused post 5 to pull from the rail at 0.114 s and the vehicle impacted post 5 at approximately 0.150 s. Post 6 began to twist and rotate to the field side and pulled from the rail at 0.160 s. The vehicle's rear end contacted the rail around post 3 location at 0.235 s. The vehicle was parallel to the installation at 0.290 s and began to redirect. The vehicle exited the system at 0.700 s at an angle of 6.7°. The front passenger side wheel assembly was damaged and caused the vehicle to track back towards the installation after it exited. The vehicle impacted the installation a second time around post 17. The vehicle came to rest 92.2 ft. (28.1 m) downstream and 1.7 ft. (0.5 m) right from its initial point of contact with the system measured from the vehicle's center of gravity.

## **5.5 Test Article Damage**

The system was damaged from post 1 through post 8 and the first four (4) W-beam guardrail panels were damaged. The lag bolts that mount the impact head to post 1 were torn from the post. There was no visible damage to the cable anchor assembly. Post 1 through 3 shifted in the soil and post 2 and 3 remained attached to the rail. Post 4 through 8 were bent at the ground line and detached from the rail. The downstream end of the installation was also damaged from the second impact with the test vehicle. Posts 15 to 17 leaned in the soil and there was a slight bend in rails 8 and 9.

## **5.6 Test Vehicle Damage**

The vehicle's damage was concentrated at its front-right side. The subframe assembly behind the quarter panel was deformed. The lower control arm was bent and the tire was punctured. The side of the front bumper was deformed inward and was lodged behind the front wheel. The front quarter panel, both doors and bedside were damaged. The front head light was detached and the grill was damaged. The occupant compartment was not penetrated and the deformation limits were not exceeded.

**Table 6 Maximum Occupant Compartment Deformation by Location**

Location	Maximum Deformation	MASH Allowable Deformation
Roof	0.0 in.	4.0 in. (102 mm)
Windshield	0.0 in.	3.0 in. (76 mm)
Window	0.0 in.	0.0 in
Wheel / foot well and toe pan	0.2 in. (5 mm)	9.0 in. (229 mm)
Side front panel (forward of A-pillar	0.0 in.	12.0 in. (305 mm)
Front side door area (above seat)	0.0 in.	9.0 in. (229 mm)
Front side door area (below seat	0.0 in.	12.0 in. (305 mm)
Floor pan and transmission tunnel	0.3 in. (8 mm)	12.0 in. (305 mm)

### 5.7 Structural Adequacy

Test article should contain and redirect the vehicle or bring the vehicle to a controlled stop; the vehicle should not penetrate, underride, or override the installation although controlled lateral deflection of the test article is acceptable. The test article redirected the vehicle in a controlled manner.

### 5.8 Occupant Risk

Under occupant risk, the test articles are evaluated by four (4) criteria. The first criterion evaluates the potential hazard of detached elements, fragments, or other debris from the test article to penetrate the test vehicle's occupant compartment or present undue hazard to other traffic, pedestrians, or personnel in a work zone. The second criterion is that the vehicle remains upright. The third criterion is that the roll angle of the vehicle does not exceed 75° throughout the test. The final criteria are based on the calculated Occupant Impact Velocities (OIV) and occupant ridedown accelerations. The maximum allowable limit for Occupant Impact Velocity Limit in both the longitudinal and lateral directions is 40.0 ft/s (12.2 m/s). The maximum allowable ridedown acceleration in both the longitudinal and lateral directions is 20.49 g. Both criteria are calculated from the acceleration data collected during the test.

The maximum extent of the debris field was 149.9 ft. (45.7 m) downstream and 71.1 ft. (21.7 m) to the traffic side measured from the first point of contact with the system. The debris consisted of broken blockouts and vehicle parts.

**Table 7 Summary of Occupant Risk Factors**

Test Parameter	Axis	Units	Max	Time (ms)	Min	Time (ms)
Vehicle Impact Velocity	X	ft/s	87.9			
Occupant Impact Velocity	X	ft/s	14.1	157.2		
Occupant Impact Velocity	Y	ft/s	13.8	157.2		
Ridedown Acceleration	X	g	1.4	547.4	-5.8	384.9
Ridedown Acceleration	Y	g	1.9	602.5	-7.8	234.8
THIV		ft/s	21.3	166.9		
PHD		g	8.3	235.0		
ASI			0.62	265.0		
Roll	X	deg.	1.8	177.8	-3.1	999.9
Pitch	Y	deg.	0.9	115.6	-3.5	672.7
Yaw	Z	deg.	34.4	681.7	0.0	1.9

### 5.9 Discussion and Summary of Results

The SPIG Industries, LLC SGET end terminal met all the requirements for MASH 2016 Test 3-35. The system contained and redirected the vehicle. None of the intrusion limits were exceeded, there was no penetration into the occupant compartment, and all the occupant risk factors were within the allowable limits. The SGET end terminal's performance to MASH 2016 test 3-35, was deemed as acceptable.

**Table 8 Evaluation Criteria Summary**

Evaluation Factor	Evaluation Criteria	Result						
Structural Adequacy	A Test article should contain and redirect the vehicle or bring the vehicle to a controlled stop; the vehicle should not penetrate, underide, or override the installation although controlled lateral deflection of the test article is acceptable.	PASS						
Occupant Risk	D Detached elements, fragments, or other debris from the test article should not penetrate or show potential for penetrating the occupant compartment, or present undue hazard to other traffic, pedestrians, or personnel in a work zone.	PASS						
	F The vehicle should remain upright during and after the collision. The maximum roll and pitch angles are not to exceed 75°.	PASS						
	H Occupant impact velocities (OIV) should satisfy the following limits:	PASS						
	<table border="1" data-bbox="402 949 1328 1066"> <thead> <tr> <th data-bbox="409 949 685 991">Component</th> <th data-bbox="685 949 938 991">Preferred</th> <th data-bbox="938 949 1321 991">Maximum</th> </tr> </thead> <tbody> <tr> <td data-bbox="409 991 685 1066">Longitudinal and Lateral</td> <td data-bbox="685 991 938 1066">30 ft/s (9.1 m/s)</td> <td data-bbox="938 991 1321 1066">40 ft/s (12.2 m/s)</td> </tr> </tbody> </table>	Component	Preferred	Maximum	Longitudinal and Lateral	30 ft/s (9.1 m/s)	40 ft/s (12.2 m/s)	PASS
	Component	Preferred	Maximum					
Longitudinal and Lateral	30 ft/s (9.1 m/s)	40 ft/s (12.2 m/s)						
I The occupant ridedown acceleration should satisfy the following limits:	PASS							
<table border="1" data-bbox="402 1129 1328 1243"> <thead> <tr> <th data-bbox="409 1129 685 1171">Component</th> <th data-bbox="685 1129 938 1171">Preferred</th> <th data-bbox="938 1129 1321 1171">Maximum</th> </tr> </thead> <tbody> <tr> <td data-bbox="409 1171 685 1243">Longitudinal and Lateral</td> <td data-bbox="685 1171 938 1243">15.0 g</td> <td data-bbox="938 1171 1321 1243">20.49 g</td> </tr> </tbody> </table>	Component	Preferred	Maximum	Longitudinal and Lateral	15.0 g	20.49 g	PASS	
Component	Preferred	Maximum						
Longitudinal and Lateral	15.0 g	20.49 g						
<b>OVERALL TEST ASSESSMENT</b>		PASS						

# MASH 2016 Test 3-35 Summary

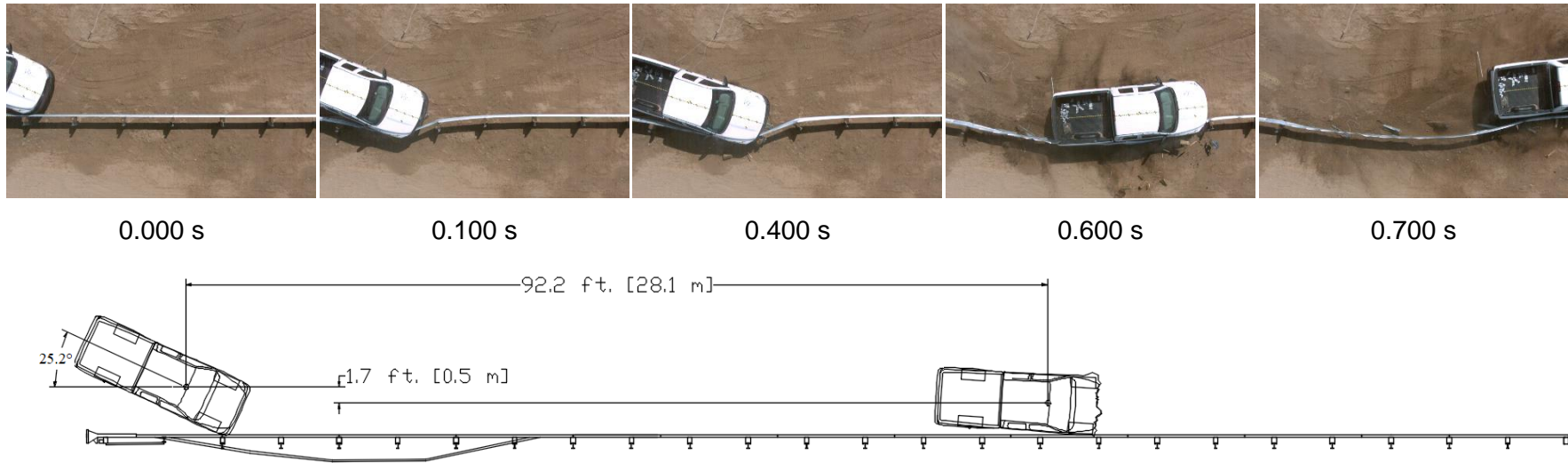

<b>GENERAL INFORMATION</b>	
Test Agency.....	KARCO Engineering, LLC.
KARCO Test No.....	P38032-01
Test Designation.....	3-35
Test Date.....	03/12/18
<b>TEST ARTICLE</b>	
Name / Model.....	SGET
Type.....	End Terminal
Installation Length.....	156.3 ft. (47.6 m)
Terminal Length.....	50.0 ft. (15.2 m)
Road Surface.....	Medium to Fine Silty Soil
<b>TEST VEHICLE</b>	
Type / Designation.....	2270P
Year, Make, and Model....	2012 RAM 1500
Curb Mass.....	4,968.0 lbs (2,253.5 kg)
Test Inertial Mass.....	5,006.6 lbs (2,271.0 kg)
Gross Static Mass.....	5,006.6 lbs (2,271.0 kg)

<b>Impact Conditions</b>	
Impact Velocity.....	59.63 mph (95.97 km/h)
Impact Angle.....	25.2°
Location / Orientation.....	Post 3
Impact Severity.....	107.9 kip-ft (146.3 kJ)
<b>Exit Conditions</b>	
Exit Velocity.....	25.10 mph (40.39 km/h)
Exit Angle.....	6.7°
Final Vehicle Position.....	92.2 ft. (28.1 m) Downstream
	1.7 ft. (0.5 m) Right
Exit Box Criteria Met.....	Yes
Vehicle Snagging.....	None
Vehicle Pocketing.....	None
Vehicle Stability.....	Satisfactory
Maximum Roll Angle.....	-3.1 °
Maximum Pitch Angle.....	-3.5 °
Maximum Yaw Angle.....	34.4 °

<b>Occupant Risk</b>	
Longitudinal OIV.....	14.1 ft/s (4.3 m/s)
Lateral OIV.....	13.8 ft/s (4.2 m/s)
Longitudinal RA.....	-5.8 g
Lateral RA.....	-7.8 g
THIV.....	21.3 ft/s (6.5 m/s)
PHD.....	8.3 g
ASI.....	0.62
<b>Test Article Deflections</b>	
Static.....	2.7 ft. (0.8 m)
Dynamic.....	4.0 ft. (1.2 m)
Working Width.....	4.0 ft. (1.2 m)
Debris Field.....	149.9 ft. (45.7 m) Downstream
	71.1 ft. (21.7 m) Right
<b>Vehicle Damage</b>	
Vehicle Damage Scale.....	01-RFQ-2
CDC.....	01RFEW1
Maximum Intrusion.....	0.3 in. (8 mm)

Figure 2 Summary of Test 3-35

# **Appendix A**

## **Photographs**

## LIST OF PHOTOGRAPHS

Figure		Page
1	Test Setup	A-1
2	Test Setup, Close-Up	A-1
3	Test Setup	A-2
4	Test Setup, Close-Up	A-2
5	Test Setup	A-3
6	Test Setup, Close-Up	A-3
7	Test Setup	A-4
8	Test Setup, Close-Up	A-4
9	Test Setup	A-5
10	Test Setup, Close-Up	A-5
11	Pre-Test	A-6
12	Post-Test	A-6
13	Post-Test	A-7
14	Post-Test	A-7
15	Pre-Test Front View of Test Article	A-8
16	Post-Test Front View of Test Article	A-8
17	Pre-Test Right Front $\frac{3}{4}$ View of Test Article	A-9
18	Post-Test Right Front $\frac{3}{4}$ View of Test Article	A-9
19	Pre-Test Right Front View of Test Article	A-10
20	Post-Test Right View of Test Article	A-10
21	Pre-Test Right Rear $\frac{3}{4}$ View of Test Article	A-11
22	Post-Test Right Rear $\frac{3}{4}$ View of Test Article	A-11
23	Pre-Test Right Rear View of Test Article	A-12
24	Post-Test Right Rear View of Test Article	A-12
25	Pre-Test Left Rear $\frac{3}{4}$ View of Test Article	A-13
26	Post-Test Left Rear $\frac{3}{4}$ View of Test Article	A-13
27	Pre-Test Left View of Test Article	A-14
28	Post-Test Left View of Test Article	A-14
29	Pre-Test Left Front $\frac{3}{4}$ View of Test Article	A-15
30	Post-Test Left Front $\frac{3}{4}$ View of Test Article	A-15
31	Test Article Damage	A-16
32	Test Article Damage	A-16
33	Test Article Damage	A-17

## LIST OF PHOTOGRAPHS ... (CONTINUED)

Figure		Page
34	Test Article Damage	A-17
35	Test Article Damage	A-18
36	Test Article Damage	A-18
37	Pre-Test Left View of Test Vehicle	A-19
38	Post-Test Left View of Test Vehicle	A-19
39	Pre-Test Left Front $\frac{3}{4}$ View of Test Vehicle	A-20
40	Post-Test Left Front $\frac{3}{4}$ View of Test Vehicle	A-20
41	Pre-Test Front View of Test Vehicle	A-21
42	Post-Test Front View of Test Vehicle	A-21
43	Pre-Test Right Front $\frac{3}{4}$ View of Test Vehicle	A-22
44	Post-Test Right Front $\frac{3}{4}$ View of Test Vehicle	A-22
45	Pre-Test Right View of Test Vehicle	A-23
46	Post-Test Right View of Test Vehicle	A-23
47	Pre-Test View of Windshield	A-24
48	Post-Test View of Windshield	A-24
49	Pre-Test Driver Side Occupant Compartment	A-25
50	Post-Test Driver Side Occupant Compartment	A-25
51	Pre-Test Driver Side Floorpan	A-26
52	Post-Test Driver Side Floorpan	A-26
53	Pre-Test Passenger Side Occupant Compartment	A-27
54	Post-Test Passenger Side Occupant Compartment	A-27
55	Pre-Test Passenger Side Floorpan	A-28
56	Post-Test Passenger Side Floorpan	A-28
57	Test Vehicle Manufacturer's Label	A-29





FIGURE 1. Test Setup



FIGURE 2. Test Setup, Close-Up



FIGURE 3. Test Setup



FIGURE 4. Test Setup, Close-Up



FIGURE 5. Test Setup

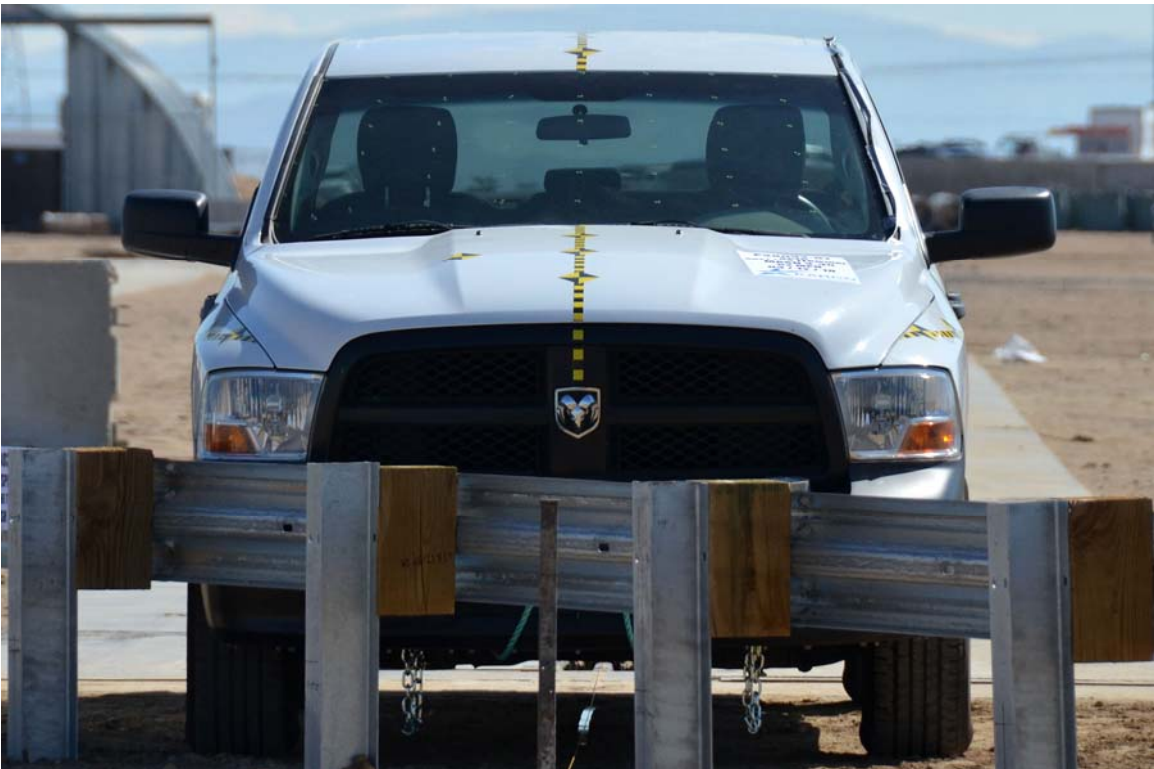

FIGURE 6. Test Setup, Close-Up



FIGURE 7. Test Setup

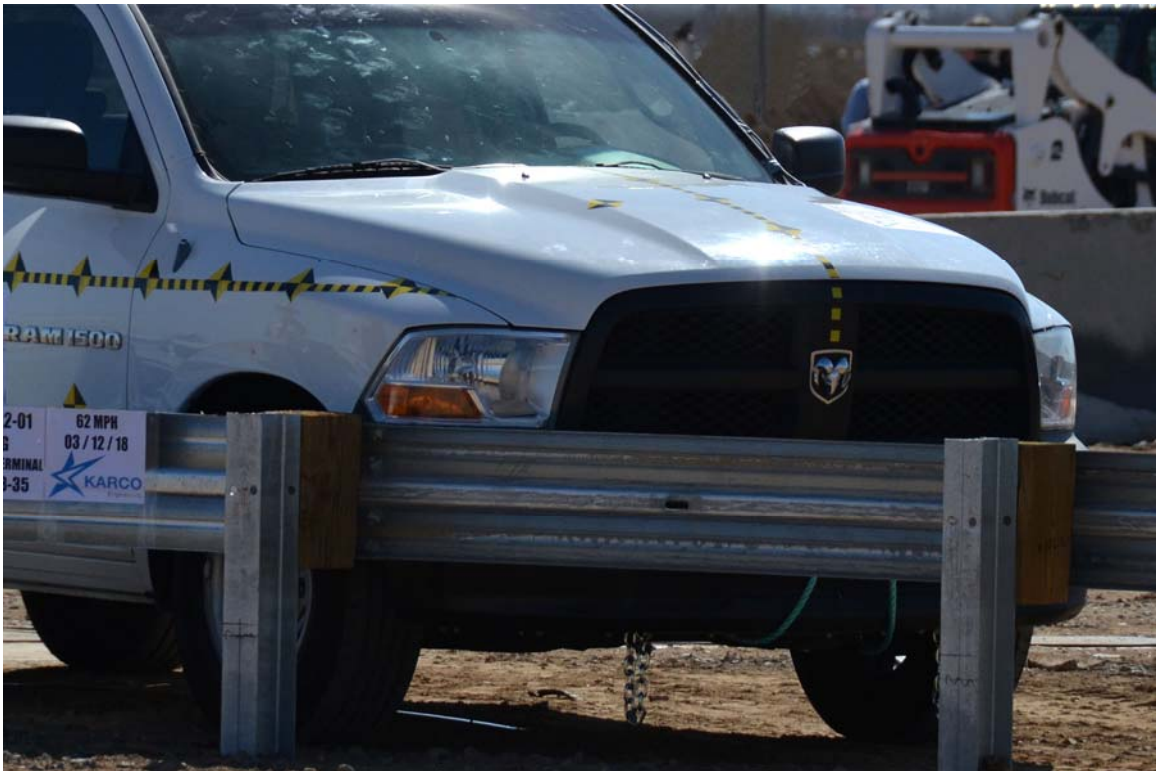

FIGURE 8. Test Setup, Close-Up



FIGURE 9. Test Setup



FIGURE 10. Test Setup, Close-Up



FIGURE 11. Pre-Test



FIGURE 12. Post-Test



FIGURE 13. Post-Test



FIGURE 14. Post-Test



FIGURE 15. Pre-Test Front View of Test Article

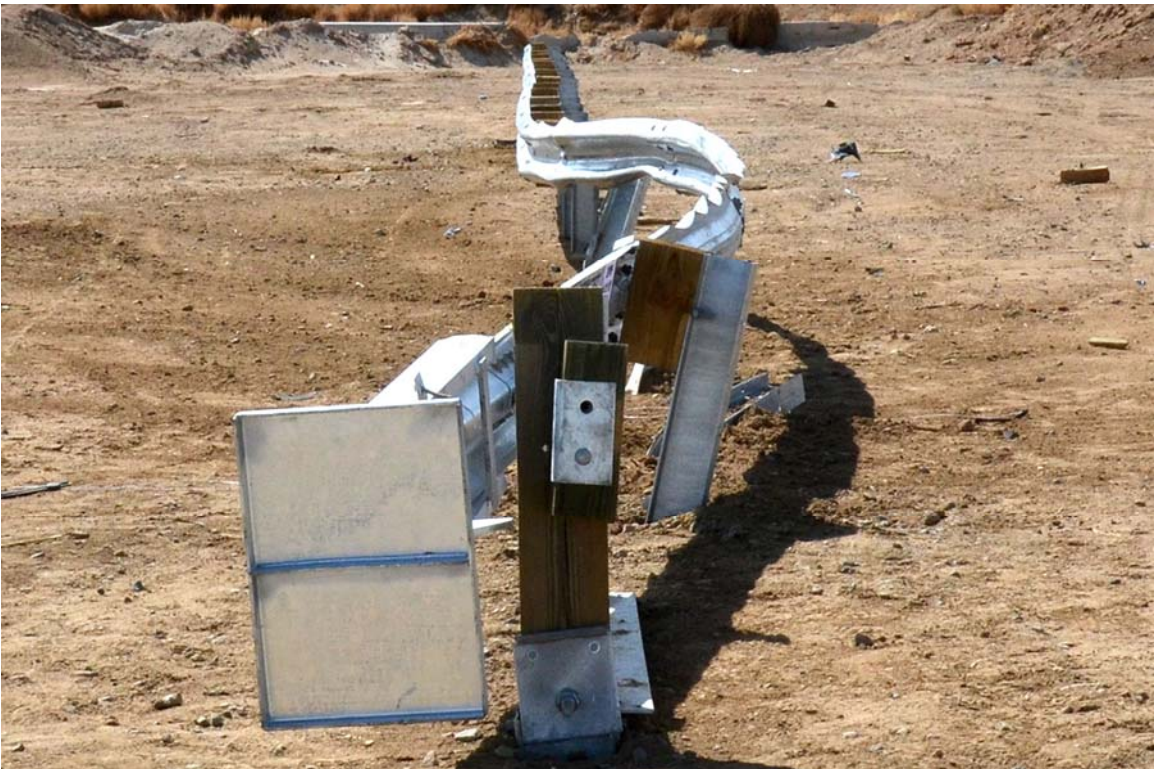

FIGURE 16. Post-Test Front View of Test Article





FIGURE 17. Pre-Test Right Front  $\frac{3}{4}$  View of Test Article



FIGURE 18. Post-Test Right Front  $\frac{3}{4}$  View of Test Article



FIGURE 19. Pre-Test Right View of Test Article



FIGURE 20. Post-Test Right View of Test Article



FIGURE 21. Pre-Test Right Rear  $\frac{3}{4}$  View of Test Article



FIGURE 22. Post-Test Right Rear  $\frac{3}{4}$  View of Test Article



FIGURE 23. Pre-Test Rear View of Test Article



FIGURE 24. Post-Test Rear View of Test Article



FIGURE 25. Pre-Test Left Rear  $\frac{3}{4}$  View of Test Article



FIGURE 26. Post-Test Left Rear  $\frac{3}{4}$  View of Test Article



FIGURE 27. Pre-Test Left View of Test Article



FIGURE 28. Post-Test Left View of Test Article



FIGURE 29. Pre-Test Left Front  $\frac{3}{4}$  View of Test Article



FIGURE 30. Post-Test Left Front  $\frac{3}{4}$  View of Test Article



FIGURE 31. Test Article Damage



FIGURE 32. Test Article Damage





FIGURE 33. Test Article Damage



FIGURE 34. Test Article Damage



FIGURE 35. Test Article Damage



FIGURE 36. Test Article Damage



FIGURE 37. Pre-Test Left View of Test Vehicle



FIGURE 38. Post-Test Left View of Test Vehicle



FIGURE 39. Pre-Test Left Front  $\frac{3}{4}$  View of Test Vehicle



FIGURE 40. Post-Test Left Front  $\frac{3}{4}$  View of Test Vehicle



FIGURE 41. Pre-Test Front View of Test Vehicle

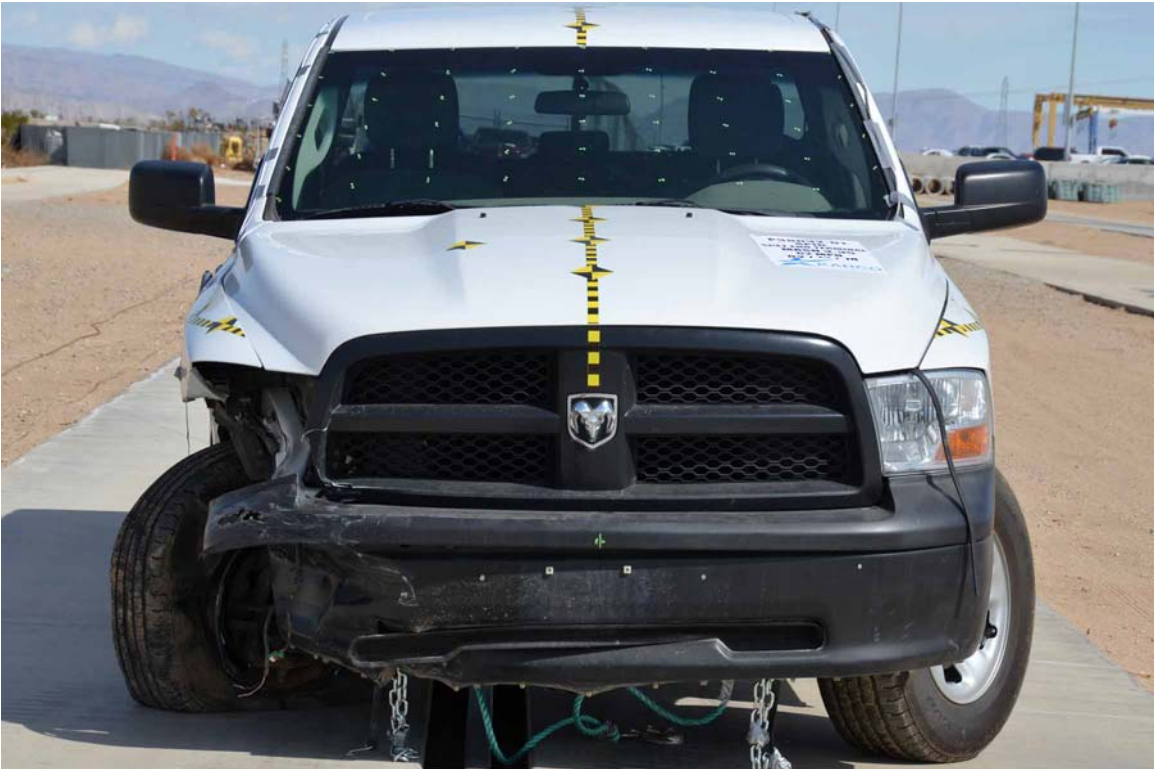

FIGURE 42. Post-Test Front View of Test Vehicle



FIGURE 43. Pre-Test Right Front ¾ View of Test Vehicle

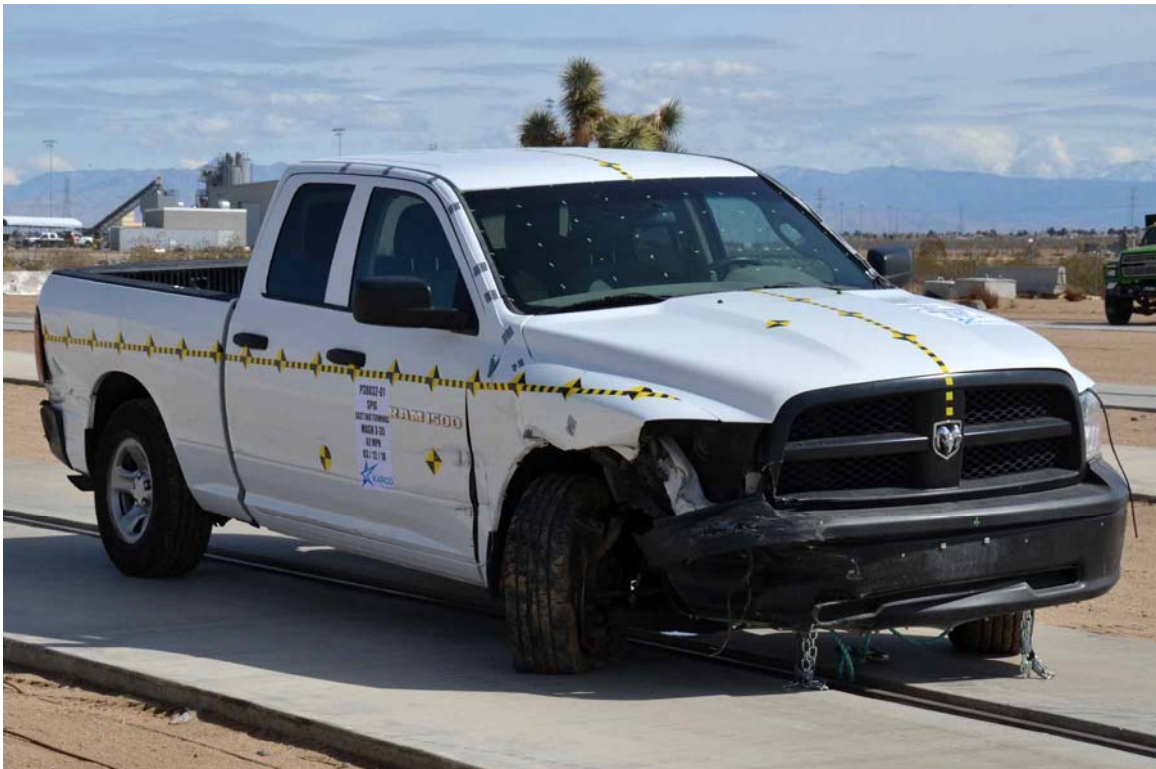

FIGURE 44. Post-Test Right Front ¾ View of Test Vehicle



FIGURE 45. Pre-Test Right View of Test Vehicle



FIGURE 46. Post-Test Right View of Test Vehicle



FIGURE 47. Pre-Test Windshield



FIGURE 48. Post-Test Windshield





FIGURE 49. Pre-Test Driver Side Occupant Compartment



FIGURE 50. Post-Test Driver Side Occupant Compartment



FIGURE 51. Pre-Test Driver Side Floorpan



FIGURE 52. Post-Test Driver Side Floorpan



FIGURE 53. Pre-Test Passenger Side Occupant Compartment



FIGURE 54. Post-Test Passenger Side Occupant Compartment



FIGURE 55. Pre-Test Passenger Side Floorpan



FIGURE 56. Post-Test Passenger Side Floorpan



FIGURE 57. Test Vehicle Manufacturer's Label

# **Appendix B**

## **Data Plots**

## LIST OF DATA PLOTS

<u>Plot</u>		<u>Page</u>
1	Test Vehicle CG X	B-1
2	Test Vehicle CG X Moving Average	B-1
3	Test Vehicle CG X Velocity	B-1
4	Test Vehicle CG X Displacement	B-1
5	Test Vehicle CG Y	B-2
6	Test Vehicle CG Y Moving Average	B-2
7	Test Vehicle CG Y Velocity	B-2
8	Test Vehicle CG Y Displacement	B-2
9	Test Vehicle CG Z	B-3
10	Test Vehicle Accident Severity Index	B-3
11	Test Vehicle Roll Angle	B-4
12	Test Vehicle Yaw Angle	B-4
13	Test Vehicle Pitch Angle	B-4

Test Article: SPIG Industries SGET End Terminal  
 Test Program: MASH 3-35

Project No: P38032-01  
 Test Date.: 03/12/18

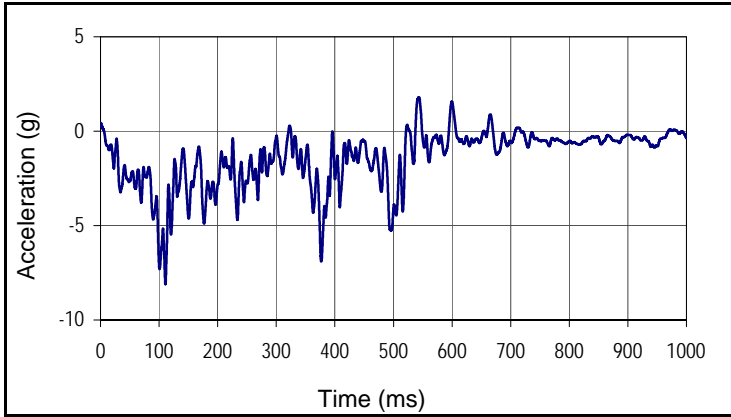

Curve Description			
Test Vehicle CG X			
Plot No.		SAE Class	Units
001		60	g
Max	Time	Min	Time
1.8	543.4	-8.1	110.8

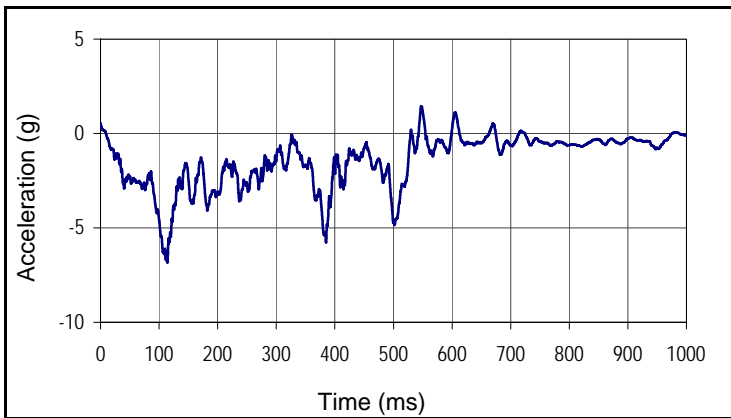

Curve Description			
Test Vehicle CG X Moving Average			
Plot No.		SAE Class	Units
002		180	g
Max	Time	Min	Time
1.4	547.4	-6.8	114.2

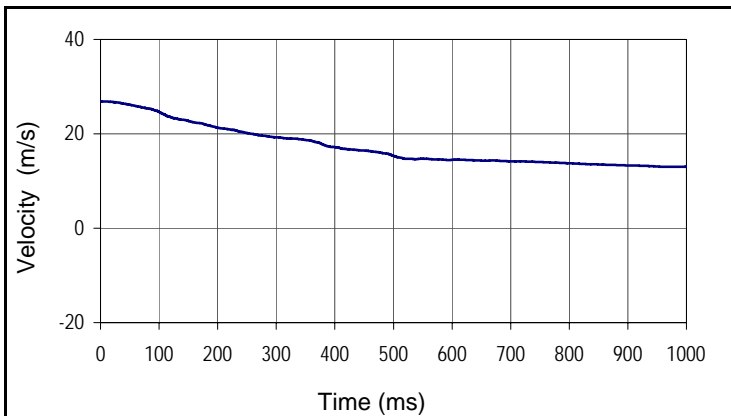

Curve Description			
Test Vehicle CG X Velocity			
Plot No.		SAE Class	Units
003		180	m/s
Max	Time	Min	Time
26.9	7.3	13.0	999.9

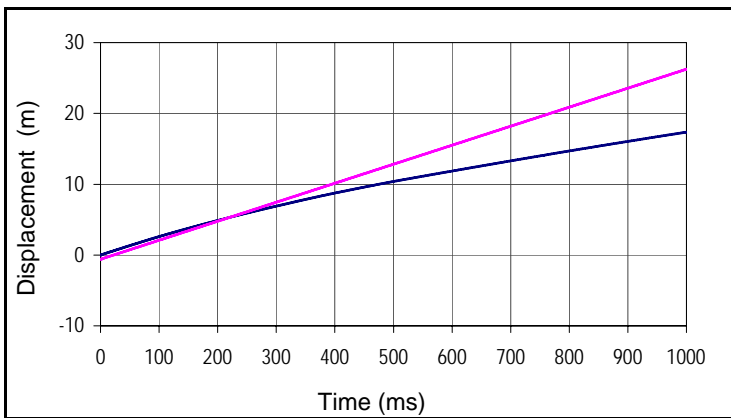

Curve Description			
Test Vehicle CG X Displacement			
Plot No.		SAE Class	Units
004		180	m
Max	Time	Min	Time
17.4	999.9	0.0	0.0

— Vehicle CG X Displacement  
 — Occupant X Displacement



Test Article: SPIG Industries SGET End Terminal  
 Test Program: MASH 3-35

Project No: P38032-01  
 Test Date.: 03/12/18

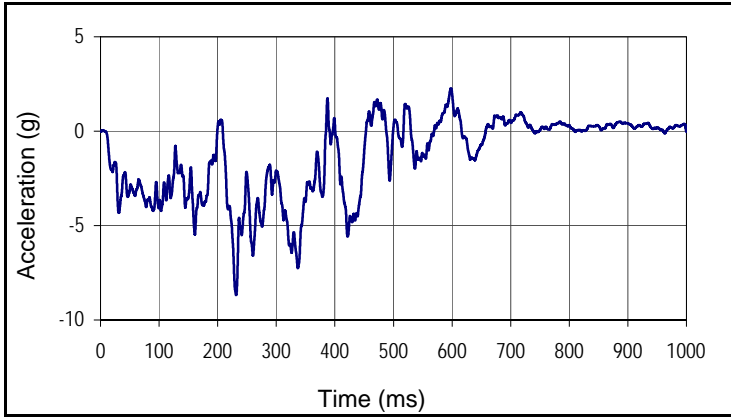

Curve Description			
Test Vehicle CG Y			
Plot No.		SAE Class	Units
005		60	g
Max	Time	Min	Time
2.3	598.1	-8.7	231.5

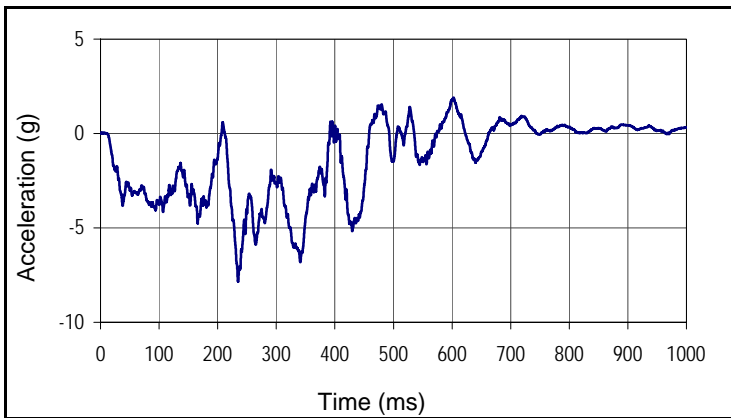

Curve Description			
Test Vehicle CG Y Moving Average			
Plot No.		SAE Class	Units
006		180	g
Max	Time	Min	Time
1.9	602.5	-7.8	234.8

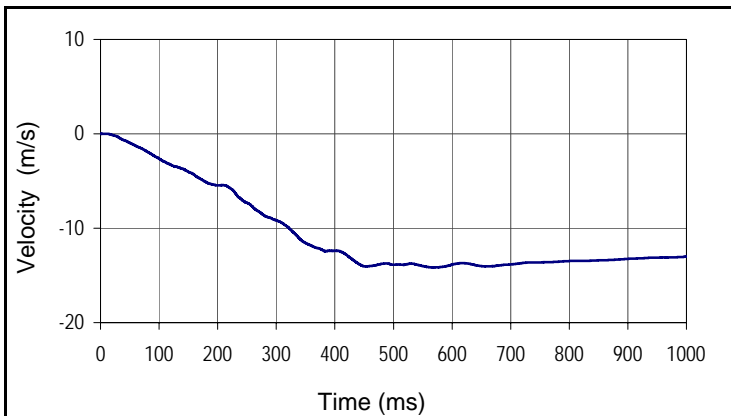

Curve Description			
Test Vehicle CG Y Velocity			
Plot No.		SAE Class	Units
007		180	m/s
Max	Time	Min	Time
0.0	6.5	-14.2	569.6

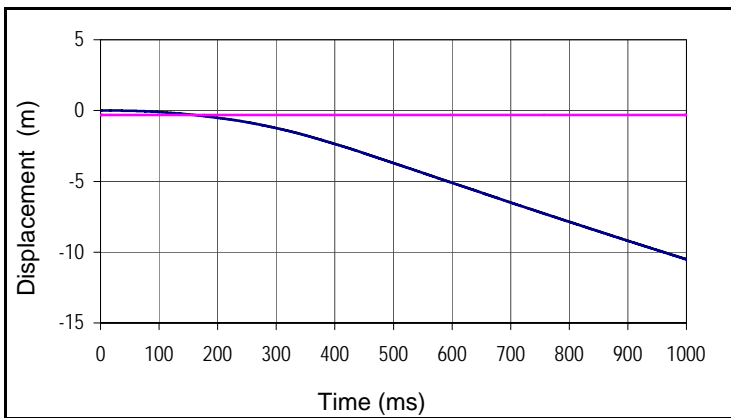

Curve Description			
Test Vehicle CG Y Displacement			
Plot No.		SAE Class	Units
008		180	m
Max	Time	Min	Time
0.0	9.5	-10.5	999.9

— Vehicle CG Y Displacement  
 — Occupant Y Displacement



Test Article: SPIG Industries SGET End Terminal  
 Test Program: MASH 3-35

Project No: P38032-01  
 Test Date.: 03/12/18

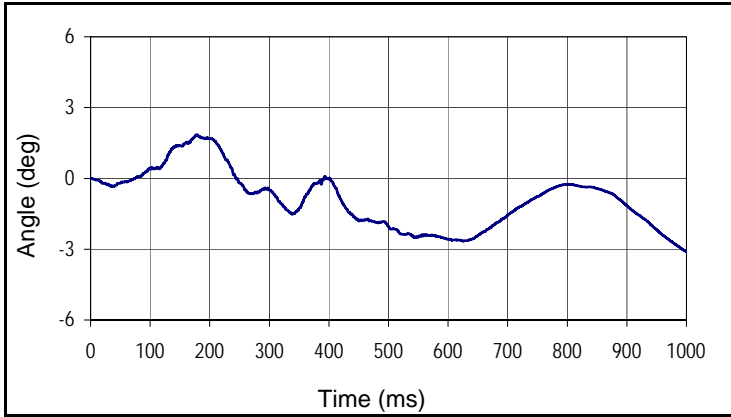

Curve Description			
Test Vehicle Roll Angle			
Plot No.		SAE Class	Units
011		180	deg
Max	Time	Min	Time
1.8	177.8	-3.1	999.9

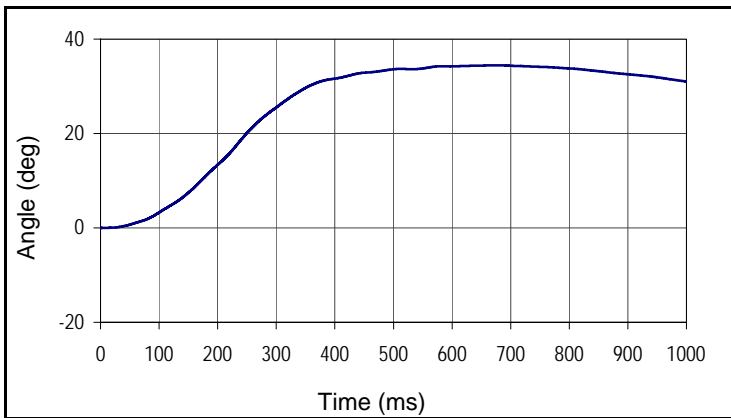

Curve Description			
Test Vehicle Yaw Angle			
Plot No.		SAE Class	Units
012		180	deg
Max	Time	Min	Time
34.4	681.7	0.0	1.9

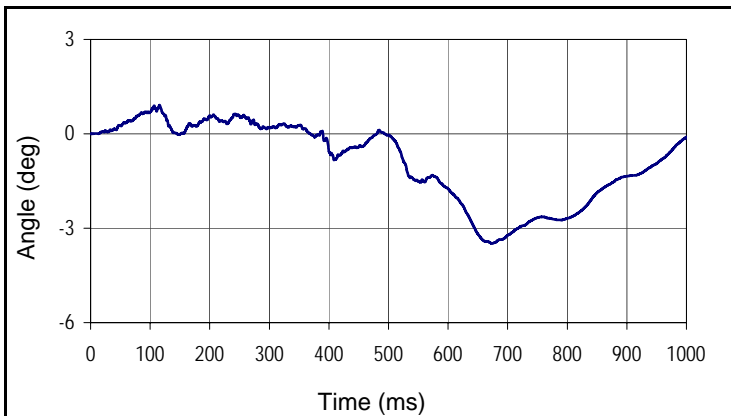

Curve Description			
Test Vehicle Pitch Angle			
Plot No.		SAE Class	Units
013		180	deg
Max	Time	Min	Time
0.9	115.6	-3.5	672.7

**Appendix C**  
**Soil Strength Information**

## LIST OF FIGURES



<u>Figure</u>		<u>Page</u>
1	Dynamic Soil Strength Data	C-1
2	Static Soil Strength Data	C-2
3	Soil Sieve Analysis	C-3



## STATIC SOIL STRENGTH DATA

Test Article:           SPIG Industries SGET End Terminal                Project No.           P38032-01            
 Test Program:   MASH 3-35        Test Date:           03/12/18          

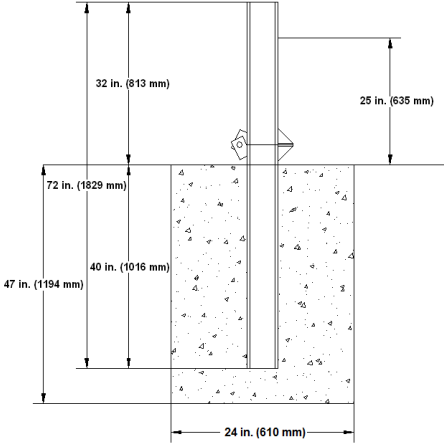
### STATIC SOIL VERIFICATION TEST DATA

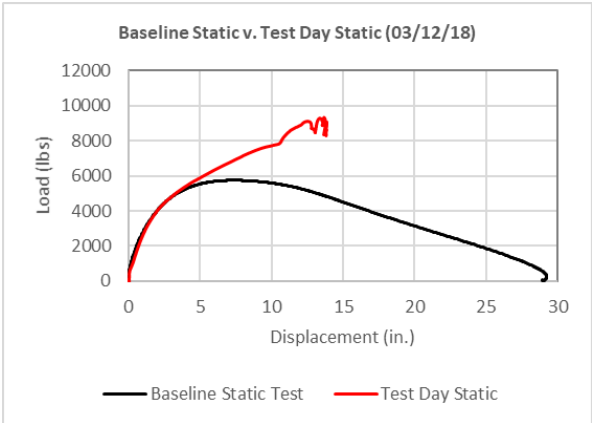
	
<b>Static Load Test Setup</b>	<b>Static Test/Installation Details</b>
	
<b>Post-Test Photo of Post</b>	<b>Comparison of Load vs. Displacement</b>

Date	03/12/18
Test Facility and Site Location	KARCO, Track 4
In Situ Soil Description (ASTM D 2487)	Medium to fine silty sand
Description of Fill Placement Procedure	8.0 in. (203 mm) lifts compacted with pneumatic tamper

Figure 2: Static Soil Strength Data

### SOIL SIEVE ANALYSIS

Test Article: SPIG Industries SGET End Terminal

Project No. P38032-01

Test Program: MASH 3-35

Test Date: 03/12/18

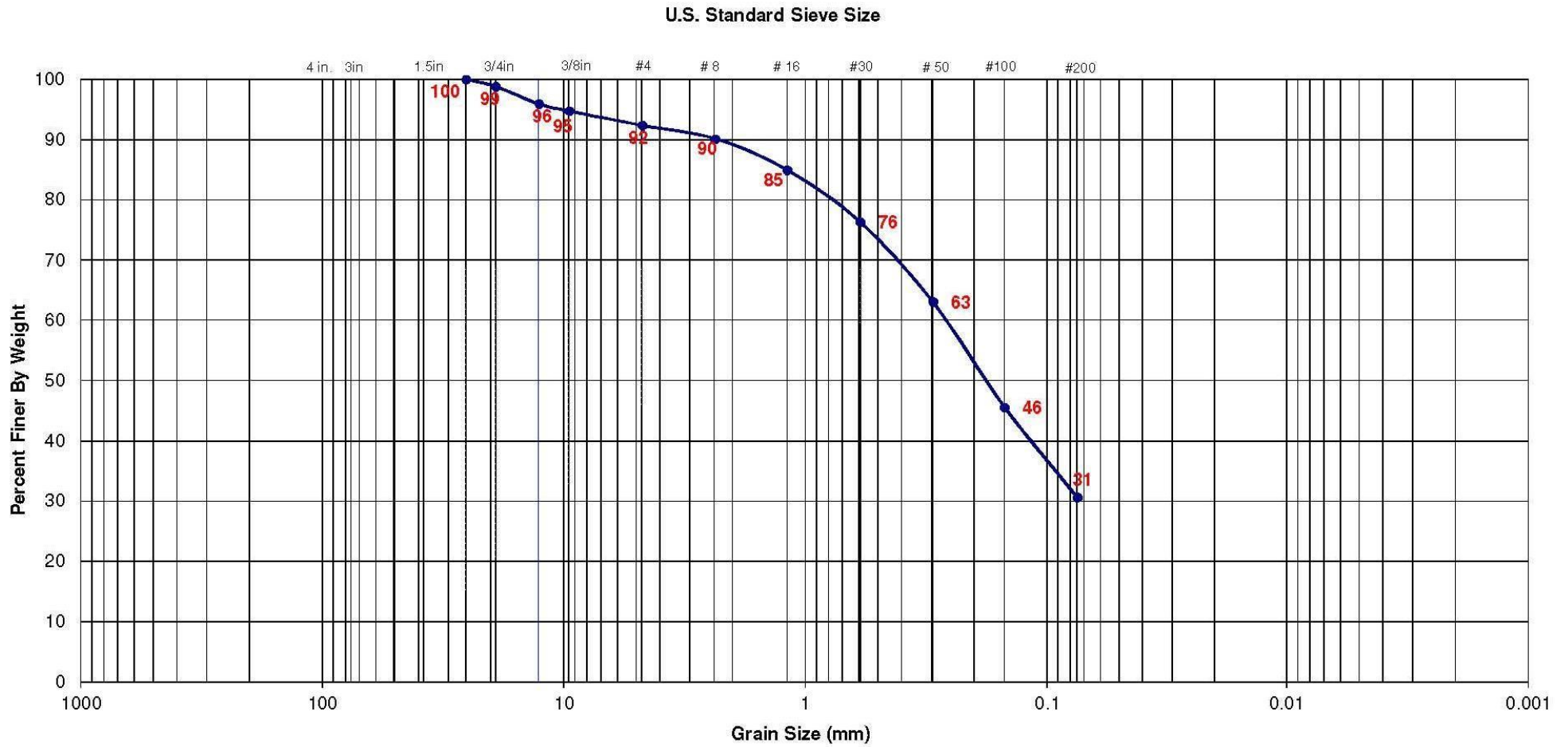

Figure 3: Soil Sieve Analysis



**Appendix D**  
**Manufacturer Documents**

## LIST OF FIGURES

<u>Figure</u>		<u>Page</u>
1	SGET System Parts	D-1
2	SGET System Parts	D-2
3	Single Guardrail Terminal	D-3
4	Single Guardrail Terminal	D-4

## SGET SYSTEM PARTS

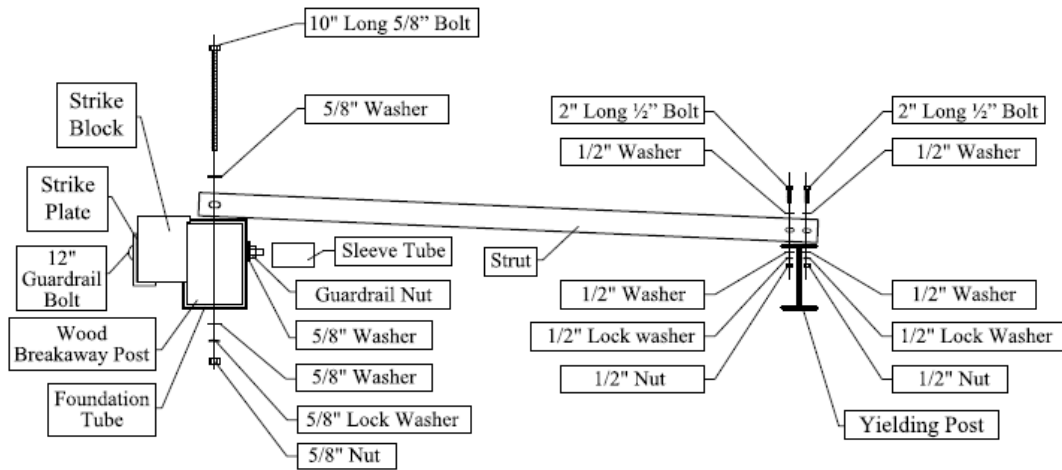

### POST PARTS

	QTY
12" Guardrail Bolt – 5/8 X 12 307A HDG	1
Strike Plate	1
Strike Block	1
Guardrail Nut – 5/8-11 Nut A563 HDG	1
Wood Breakaway Post – 5-1/2 X 7-1/2 X 50 BCT	1
Foundation Tube – 6" X 8" X 6' Rectangular Tube	1
10" long 5/8" Bolt – 5/8-11 X 10 A325 HDG	1
5/8" Nut – 5/9-11 A563 Hex Nut Galvanized	1
5/8" Washer – 5/8 F436(A325) HDG Flatwasher	3
5/8" Lock Washer Galvanized	1
2" long 1/2" Bolt – 1/2-13 X 2 A325 HDG	2
1/2" Washer – 1/2 F436(A325) HDG Flatwasher	4
1/2" Nut – 1/2-13 A563 Hex Nut Galvanized	2
1/2" Lock Washer Galvanized	2
Yielding Post – Modified W6 X 8.5 Guardrail Post	7
Strut – 3" X 3" X 80" Angle	1
Sleeve Tube – 2-3/8 OD X 4-1/4	1

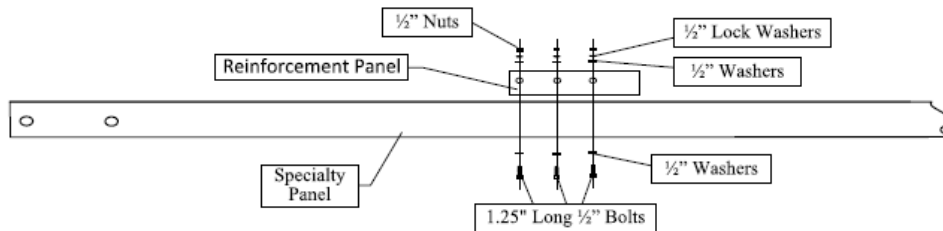

### SPECIALTY PANEL PARTS

	QTY
Specialty Panel	1
1.25" Long 1/2" Bolt – 1/2-13 X 1-1/4 A325 HDG	6
1/2" Washer – 1/2 F436(A325) HDG Flatwasher	12
1/2" Nut – 1/2-13 A563 Hex Nut Galvanized	6
1/2" Lock Washer Galvanized	6
Reinforcement Plate	1

Figure 1: SGET System Parts

## SGET SYSTEM PARTS

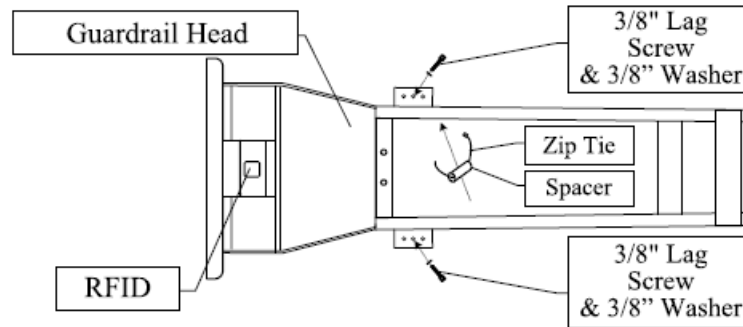

### GUARDRAIL HEAD PARTS

PARTS	QTY
Guardrail Head	1
3/8" Lag Screw – 3/8 X 3 GR5 HDG Hex Lag Screw	2
3/8" Washer Galvanized F844	2
Spacer – 4" Long X 1-1/2 SCH-40 PVC PIPE	1
Zip Tie – 18"-24" Long Rated at 175-200 lbs.	1
RFID chip rated MIL-STD-810F (e.g. Omni-ID EX0750)	1

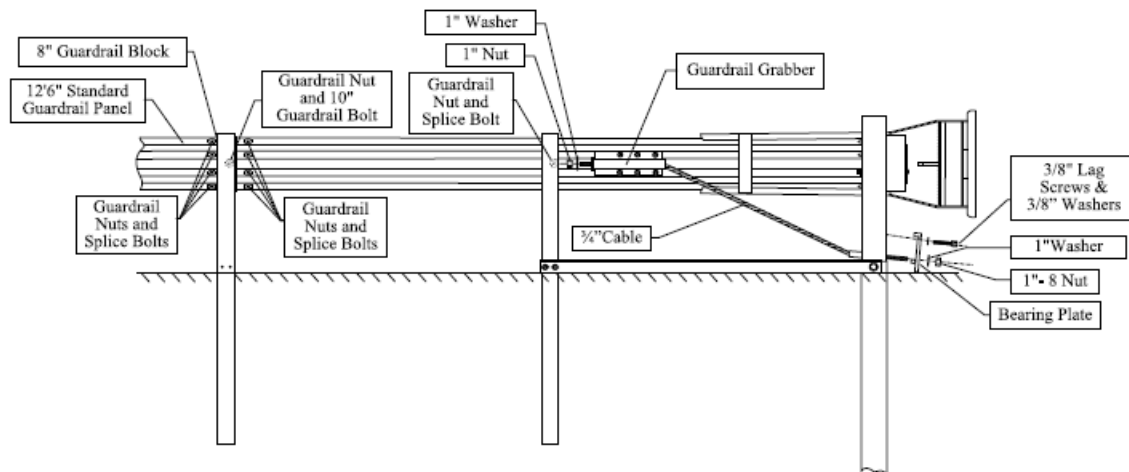

### RAIL AND CABLE PARTS

PARTS	QTY
3/8" Cable – 81" Long BCT Cable	1
1" Nut – 1- 8 Hex Nut UNC Galvanized A563DH	2
1" Washer Galvanized F436	2
Guardrail Splice Bolt – 5/8 X 1-1/4 307A HDG	25
10" Guardrail Bolt – 5/8 X 10 307A HDG	6
Guardrail Nut– 5/8-11 Nut A563 HDG	31
8" Guardrail Block	6
12' 6" Standard Guardrail Panel – W-Beam M-180	3
Bearing Plate	1
3/8" Lag Screw – 3/8 X 3 GR5 HDG Hex Lag Screw	2
3/8" Washer Galvanized F844	2
Guardrail Grabber	1

Figure 2: SGET System Parts

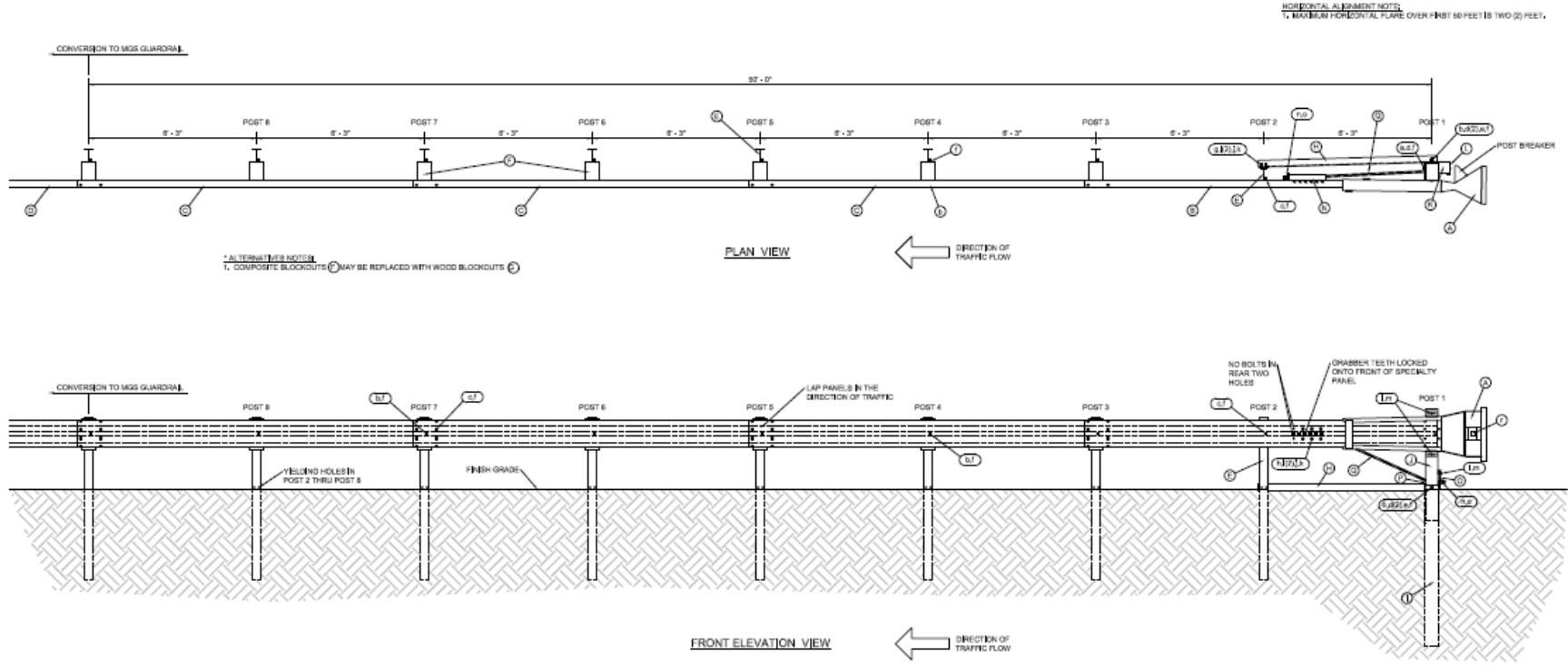

**MAIN SYSTEM COMPONENTS**

ITEM	QUANTITY	COMPONENT	ITEM NUMBER
A	1	SGT IMPACT HEAD	SHRA
B	1	SPECIALIZED GUARDRAIL PANEL/WOOD BEAM 12' 4" SECTION W-BEAM M-180	1288P23P
C	3	STANDARD GUARDRAIL PANEL (12'-0" SECTION W-BEAM M-180)	GP126
D	1	MGS CONVERSION GUARDRAIL PANEL (W-BEAM M-180)	GP25
E	7	YIELDING POST - MODIFIED WELDS GUARDRAIL POST	YPM00
F	5	COMPOSITE BLOCKOUT 6"x6"x4"	CS08
G	5	WOOD BLOCKOUT 6"x6"x4"	WS06
H	1	STRUT - 2"x2"x8' 3/8" ANGLE	STR80
I	1	FOUNDATION TUBE - 6"x6"x7' 3/4" RECTANGULAR TUBE	FN075
J	1	WOOD BREAKAWAY POST - 4' 2"x4' 2"x6"	WBK60
K	1	WOOD STRIKE BLOCK	WSBK14
L	1	STRIKE PLATE - 2" x 6" BENT PLATE	SP176
M	1	REINFORCEMENT PANEL - 12 GA. GSSS 17"x6.125" BENT PLATE	REPL177
N	1	GUARDRAIL GRABBER - 2' x 40' 2"x16' 2" x 3/8" SQUARE TUBE	GR0117
O	1	BEARING PLATE - 4"x6' 3/8" x 3/8" ANGLE PLATE	BPL76
P	1	PPE SLEEVE - 4' 2" LONG x 3' 3/8" DIA x 2' 3/8" ID, A36 ROUND TUBE	PBLV4
Q	1	3/4" CABLE - 81' LONG 3/4" BCT CABLE	CSL81

**SMALL HARDWARE**

ITEM	QUANTITY	COMPONENT	ITEM NUMBER
a	1	1 1/4" GUARDRAIL BOLT - 3/8 x 12 307A HDG	14GRBLT
b	7	10" GUARDRAIL BOLT - 3/8 x 10 307A HDG	10GRBLT
c	33	1 1/2" GUARDRAIL SPRUCE BOLT - 3/8 x 1 1/2 307A HDG	1GRBLT
d	3	3/8" FLAT WASHER - 3/8 F438 (A325) HDG	58FW438
e	1	3/8" LOCK WASHER - HDG	58LW
f	33	3/8" HEX NUT - 3/8 x 11 A563 HDG	58HN33
g	2	2" STRUT BOLT - 1/2 x 13 x 2 A325 HDG	2RBLT
h	8	1 1/2" REINFORCEMENT PANEL - 3/8 x 13 x 1 1/2 A325 HDG	12RBLT
i	16	3/8" FLAT WASHER - 3/8 F438 (A325) HDG	12FW438
j	3	3/8" LOCK WASHER - HDG	12LW
k	3	2" HEX NUT - 1/2 x 13 A493 HDG	12HN3
l	4	3/8" HEX LAG SCREW - 3/8 x 3 GR5 HDG	38LS
m	4	3/8" FLAT WASHER - 3/8 F344 HDG	38FW344
n	2	1" FLAT WASHER - 1 F438 (A325) HDG	1FW438
o	2	1" HEX NUT - 1 x 8 A88034 HDG	1HN33
p	1	RFD 40P RATED M8-STDx10F (6x6, 6MMx8 EX0750)	3810810F

THIS PLAN IS NOT FINAL, UPON APPROVAL MY SEAL AND DATED SIGNATURE WILL APPEAR WHERE THIS CIRCLE EXISTS.

**CERTIFICATION STATEMENT:**  
 I, BARNEY HORRELL, DO HEREBY CERTIFY THAT I AM A DULY LICENSED PROFESSIONAL ENGINEER IN THE STATE OF VIRGINIA, LICENSE NO. 0402244654 AND THAT I PERSONALLY DRAFTED THIS PLAN SHEET BASED ON SKETCHES AND INFORMATION PROVIDED BY THE MANUFACTURER. I DO NOT CERTIFY TO THE DESIGN OR EFFECTIVENESS OF ANY OF THE ITEMS SHOWN, THE MANUFACTURER HAS COMMISSIONED OTHER PROPERLY LICENSED INDEPENDENT FIRMS TO TEST AND CERTIFY TO THE EFFECTIVENESS OF THE ITEMS AND THEIR CONFIGURATION DEPICTED HEREON. THIS STATEMENT AND THE SEAL ABOVE REPRESENT ONLY THAT THIS DRAWING IS AN ACCURATE GRAPHIC DEPICTION OF THE INFORMATION PROVIDED TO ME BY THE MANUFACTURER.

**CALIFORNIA DEPT. OF TRANSPORTATION (CALTRANS)**

**SINGLE GUARDRAIL TERMINAL**

**SGET-MASH-TL-3**

REV: SGET_2021_06_17_20W0	CNC ##	CNC ##	CNC ##	CNC ##
CONT	SECT	JOB	HIGHWAY	
##	##	##	##	
DET	COUNTY			SHEET NO.
##	##			1 OF 2

DATE: JUNE 17, 2021  
 FILE: SGET\_2021\_06\_17\_20W0

Figure 3: Single Guardrail Terminal

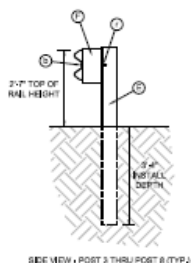

SIDE VIEW - POST 3 THRU POST 6 (TYP.)

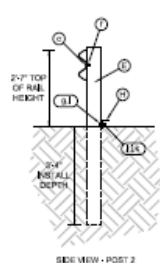

SIDE VIEW - POST 2

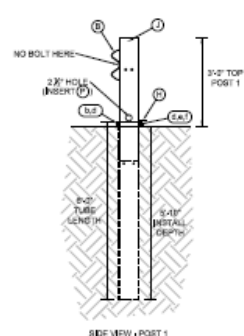

SIDE VIEW - POST 1

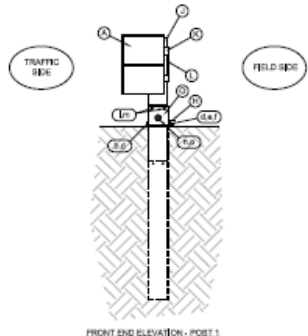

FRONT END ELEVATION - POST 1

**GENERAL NOTES:**

1. STEP-BY-STEP INSTALLATION INSTRUCTIONS AS WELL AS OTHER GUIDANCE ARE AVAILABLE FROM SPIG INDUSTRY, INC., (276) 644-6510, 14675 INDUSTRIAL PARK RD., BRISTOL, VA 24202.
2. THE FIRST SPECIALIZED GUARDRAIL PANEL SHOULD BE CENTERED BETWEEN THE MOUNTING TABS OF THE SGET IMPACT HEAD SUCH THAT THE TOP SPACING CHANNEL OF THE TOP OF THE FIRST SPECIALIZED GUARDRAIL PANEL AND THE TOP FEED CHANNEL OF THE SGET IMPACT HEAD IS THE SAME AS THE BOTTOM SPACING BETWEEN THE BOTTOM OF THE FIRST SPECIALIZED GUARDRAIL PANEL AND THE BOTTOM FEED CHANNEL OF THE SGET IMPACT HEAD. A PLASTIC SPACER IS PROVIDED WITH THE INSTALLATION KIT TO ACCOMPLISH THE CENTERING OF FIRST SPECIALIZED GUARDRAIL PANEL BETWEEN THE MOUNTING TABS OF THE SGET IMPACT HEAD.
3. THE CABLE SHOULD BE TENSIONED SUCH THAT LESS THAN 1 INCH OF DEFLECTION OCCURS WHEN THE CABLE IS STEPPED ON.
4. THE THREADED END OF THE CABLE SHOULD ONLY PROTRUDE 1 TO 1 1/2 INCH FROM THE CABLE TIGHTENING NUT AT THE END OF THE GUARDRAIL GRABBER (N) ON THE FIRST SPECIALIZED GUARDRAIL PANEL (R).
5. THE NOMINAL HEIGHT OF THE GUARDRAIL BEAM IS 31 INCHES WITH A TOLERANCE OF +/- ONE INCH.
6. THE ENTIRE SYSTEM MUST BE INSTALLED IN A STRAIGHT LINE WITHOUT ANY CURVE, HOWEVER, THE SYSTEM CAN BE FLARED UP TO TWO FEET OVER 50 FEET TO FURTHER OFFSET THE FACEPLATE OF THE SGET IMPACT HEAD FROM THE SHOULDER OF THE ROAD.
7. THE SYSTEM IS SHOWN WITH A FIRST 12'-6\"/>

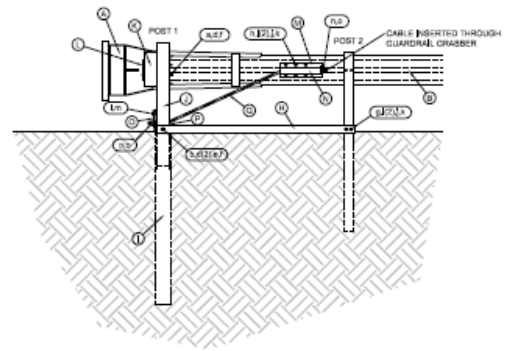

REAR ELEVATION - POST 1 THRU POST 2

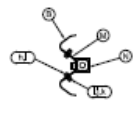

SIDE VIEW - REINFORCEMENT POST & GUARDRAIL GRABBER

THIS PLAN IS NOT FINAL, UPON APPROVAL MY SEAL AND DATED SIGNATURE WILL APPEAR WHERE THIS CIRCLE EXISTS.

**CERTIFICATION STATEMENT:**  
 I, BARNEY HORRELL, DO HEREBY CERTIFY THAT I AM A DULY LICENSED PROFESSIONAL ENGINEER IN THE STATE OF VIRGINIA, LICENSE NO. 0402944654 AND THAT I PERSONALLY DRAFTED THIS PLAN SHEET BASED ON SKETCHES AND INFORMATION PROVIDED BY THE MANUFACTURER, I DO NOT CERTIFY TO THE DESIGN OR EFFECTIVENESS OF ANY OF THE ITEMS SHOWN, THE MANUFACTURER HAS COMMISSIONED OTHER PROPERLY LICENSED INDEPENDENT FIRMS TO TEST AND CERTIFY TO THE EFFECTIVENESS OF THE ITEMS AND THEIR CONFIGURATION DEPICTED HEREON, THIS STATEMENT AND THE SEAL ABOVE REPRESENT ONLY THAT THIS DRAWING IS AN ACCURATE GRAPHIC DEPICTION OF THE INFORMATION PROVIDED TO ME BY THE MANUFACTURER.

**CALIFORNIA DEPT. OF TRANSPORTATION (CALTRANS)**

**SINGLE GUARDRAIL TERMINAL**

**SGET-MASH-TL-3**

FILE# SGET_2021_06_17.DWG	DSC ##	DSC ##	DSC ##	DSC ##
CONT	SECT	JOB	HIGHWAY	
DIST	COUNTY	SHEET NO.		
##	##	2 OF 2		

DATE: JUNE 17, 2021  
 FILE: SGET\_2021\_06\_17.DWG

Figure 4: Single Guardrail Terminal

**Appendix E**  
**Sequential Photographs**



0.000 s



0.100 s



0.150 s



0.400 s



0.750 s



1.050 s





0.000 s



0.150 s



0.400



0.750 s



1.900 s



2.900 s

# **Appendix F**

## **References**

## References

1. American Association of State Highway and Transportation Officials. "Manual for Assessing Safety Hardware, Second Edition" 2016.
2. A Transportation Research Board. "NCHRP Report 350 Recommended Procedures for the Safety Performance Evaluation of Highway Features" Washington, D.C.: National Academy of Sciences, 1993
3. Society of Automotive Engineers. "SAE J224 MAR80, Collision Deformation Classification, SAE Recommended Practice Revised March 1980" SAE, Warrendale, Pennsylvania, 1980
4. National Safety Council. "Vehicle Damage Scale for Traffic Accident Investigators" Chicago, Illinois, 1984

FINAL PAGE OF REPORT