

LEFT CONNECTOR

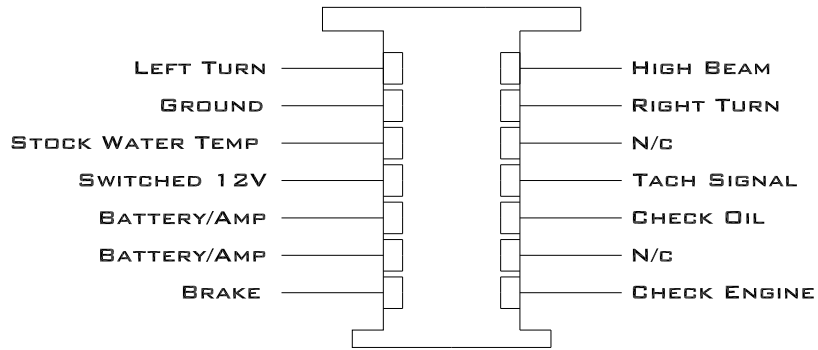

'87-'89

RIGHT CONNECTOR

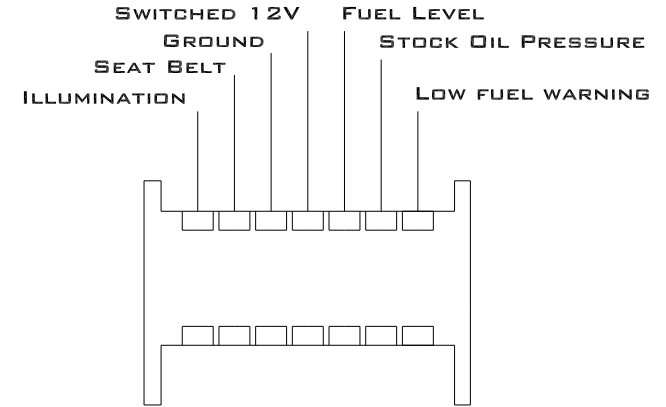

LEFT CONNECTOR

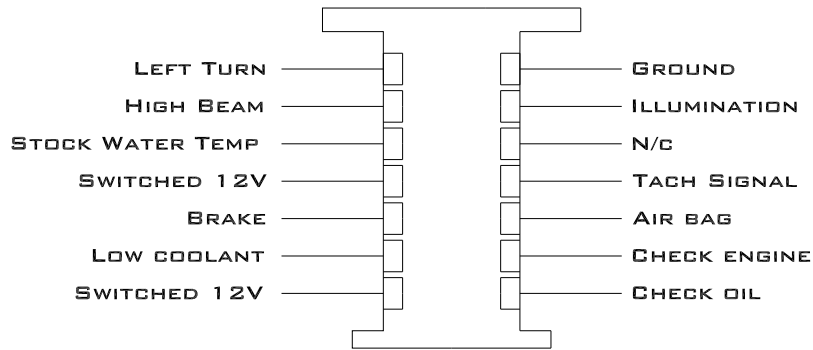

'90-'93

RIGHT CONNECTOR

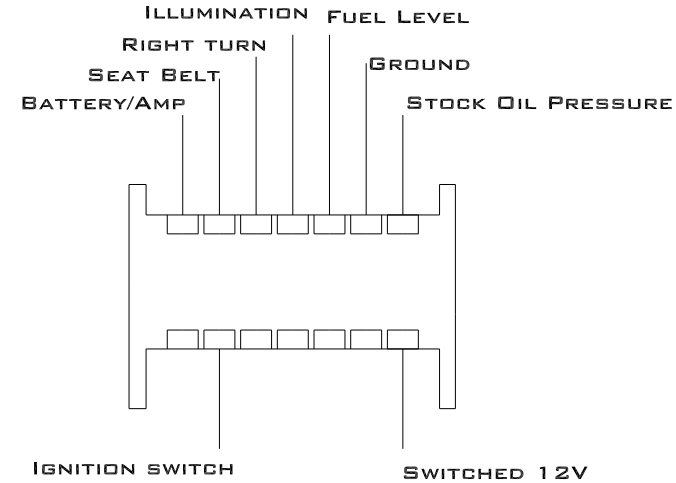

THESE ARE THE STOCK CLUSTER CONNECTORS AS VIEWED FROM THE DRIVER'S SEAT LOOKING TOWARDS THE FRONT OF THE CAR. VERIFY THESE CONNECTIONS BY TRACING THE COPPER LEADS ON THE BACK OF THE CLUSTER YOU ARE REPLACING. SOME YEARS HAD "AIR BAG" LIGHTS AND/OR "LOW COOLANT" LIGHTS SO THE CONNECTIONS MAY HAVE CHANGED SLIGHTLY.

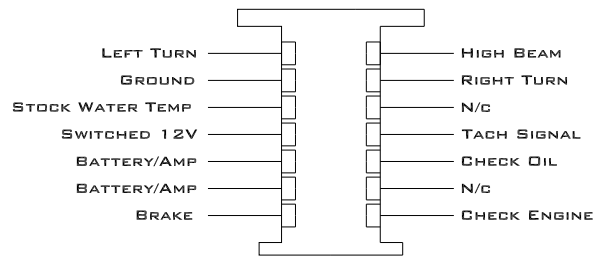

'87-'89

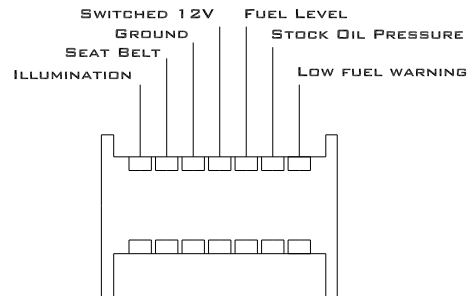

LEFT CONNECTOR

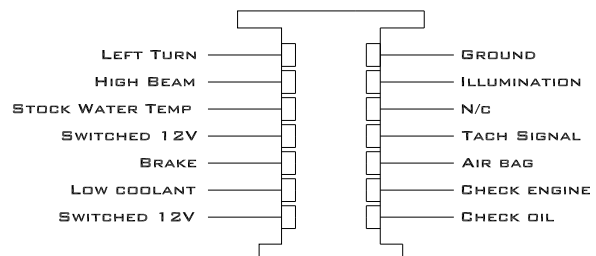

'90-'93

RIGHT CONNECTOR

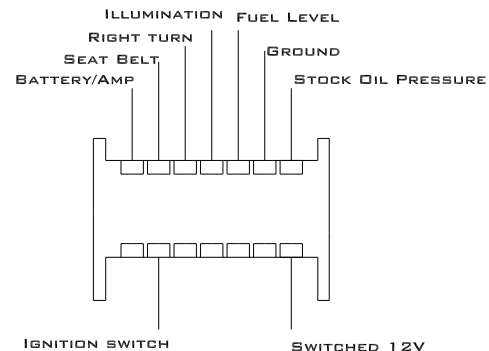

THESE ARE THE STOCK CLUSTER CONNECTORS AS VIEWED FROM THE DRIVER'S SEAT LOOKING TOWARDS THE FRONT OF THE CAR. VERIFY THESE CONNECTIONS BY TRACING THE COPPER LEADS ON THE BACK OF THE CLUSTER YOU ARE REPLACING. SOME YEARS HAD "AIR BAG" LIGHTS AND/OR "LOW COOLANT" LIGHTS SO THE CONNECTIONS MAY HAVE CHANGED SLIGHTLY.