

HDPE Restraint

High Density Polyethylene Pipe Restraint

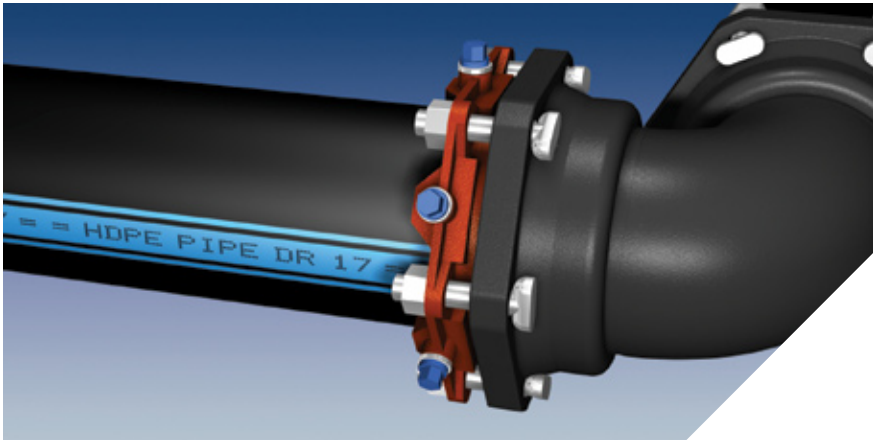

▲ Series 2006PV on HDPE pipe at a M.J. Fitting.

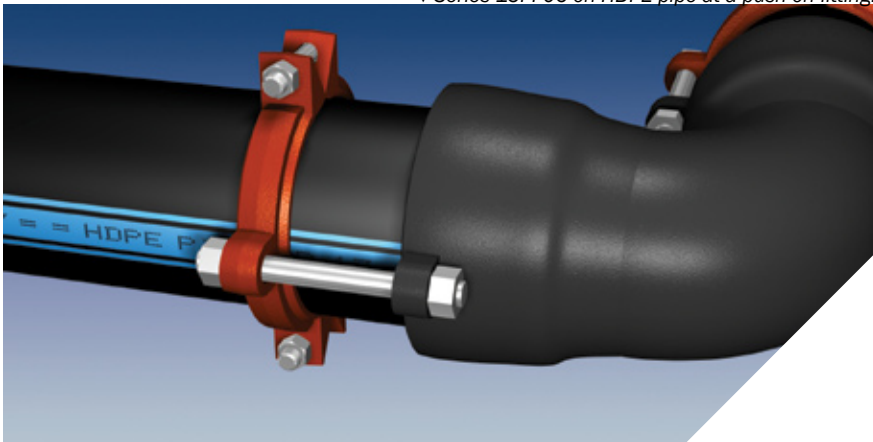

▼ Series 15PF06 on HDPE pipe at a push-on fitting.

Series 2100 MEGAFLANGE® Restrained Flange Adapter not shown, refer to 2100 brochure.

Features and Applications:

- For use in restraining HDPE pipe to AWWA fittings, valves, and similar appurtenances:
 Series 2000PV Mechanical Joint Restraint
 Series 15MJ00 Mechanical Joint Gland Restraint
 Series 15PF00 Push-On Joint Restraint
 Series 2100 Restrained Flange Adapter
 (2100 Not Shown in this brochure, see Series 2100 MEGAFLANGE® Brochure)
- Pipe must be manufactured in accordance with AWWA Standard ANSI/ AWWA C906 with respect to size
- Operating pressure is limited to the pressure rating of the pipe, derated as appropriate for service temperature
- Pipe systems must be designed to compensate for thermal expansion/ contraction
- Products are intended for use in underground service only
- **MEGA-BOND®** Coating System
- For additional information on the products listed in this brochure, please refer to www.ebaa.com
- Internal pipe stiffeners must be used. Stiffener length must be sufficient to fully encompass the area of the pipe being restrained.

For use on water or wastewater pipelines subject to hydrostatic pressure and tested in accordance with either AWWA C600, C605 or ASTM D2774.

Nominal Pipe Size	Series 2000PV	Series 15PF00	Series 2100	Pressure Ratings (PSI)		
				DR11	DR13.5	DR17
3	2003PV	15PF03	2103	160	130	100
4	2004PV	15PF04	2104	160	130	100
6	2006PV	15PF06	2106	160	130	100
8	2008PV	15PF08	2108	160	130	100
10	2010PV	15PF10	2110	160	130	100
12	2012PV	15PF12	2112	160	130	100

NOTE: For applications or pressures other than those shown, please call EBAA for assistance.

Sample Specification For Restraining High Density Polyethylene (HDPE) Pipe

EBAA Series 15PF00, 2000PV and 2100 restraint devices, 3 inch through 12 inch diameter, are designed to resist pull out forces based on the maximum working pressure rating of the pipe, Forces experienced due to expansion/contraction of the pipe require special consideration.

EBAA products for HDPE are designed for underground pressurized fluid service and are pressure rated to match the pipe SDR pressure rating, derated as appropriate for service temperature. Maximum test pressure limited to pipe rated pressure.

The stiffeners must be sized to encompass the entire bearing length of the restraint device. Pipe systems must be engineered to prevent movement causing fitting to slide or rotate on the pipe.

Spacer Instructions

Ductile Iron or C900 PVC Pipe Sizes

For installation on C900 PVC pipe, use as received and install per instructions.

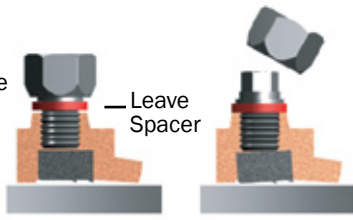

ASTM 2241 PVC Pipe Sizes (IPS O.D.)

For installation on ASTM 2241 sized pipe, remove spacers and replace screws. Install per instructions.

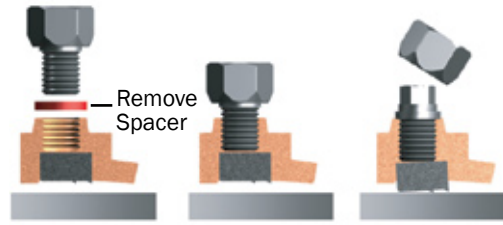

Installation Instructions for 2000PV

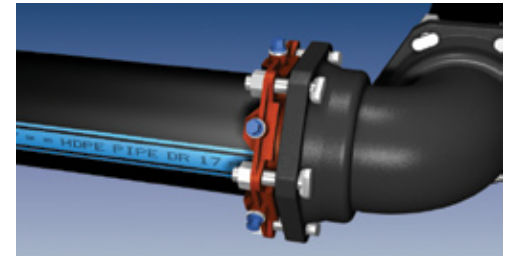
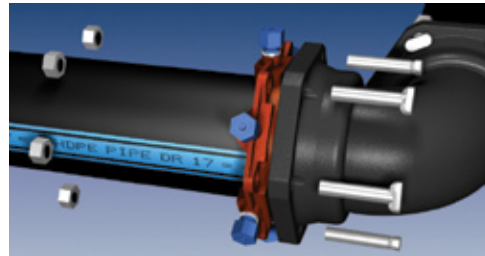
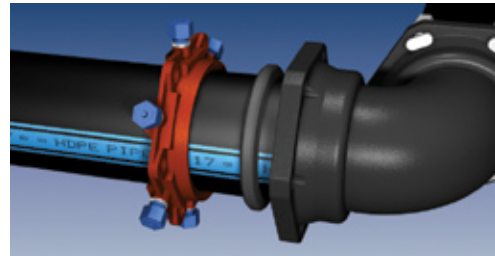

1. Identify the pipe. The 2000PV is for use with PVC and HDPE pipe. The 4 inch through 12 inch size may be used on C900, IPS, and C909 PVC pipe as well as C906 HDPE pipe. Check to see if the spacers under the screws are in place. If the pipe is C900 or is ductile iron O.D., proceed with spacers in place. If the pipe is IPS O.D., remove the spacers. Since 3 inch and 14 inch through 24 inch restraints are only used with one pipe diameter, no spacers are used.

bi-directional and has no front or back. The use of a pipe wall stiffening insert is required on High Density Polyethylene pipe.]

NOTE: In cold weather it is preferable to warm the gasket to facilitate assembly of the joint.

3. Insert the pipe into the socket and press the gasket firmly and evenly into the gasket recess. Keep the joint straight during assembly.

points around the socket. This can be accomplished by partially tightening the bottom bolt first, then the top bolt, next the bolts at either side, finally the remaining bolts. Repeat the process until all bolts are within the appropriate range of torque. In large sizes (30-48 inch), five or more repetitions may be required. The use of a torque-indicating wrench will facilitate the procedure.

2. Clean the socket and the plain end. Lubrication and additional cleaning should be provided by brushing both the gasket and plain end with soapy water or an approved pipe lubricate meeting the requirements of ANSI/AWWA C111/A12.11 just prior to slipping the gasket onto the plain end for joint assembly. Place the gland on the plain end with the lip extension toward the plain end; follow by the gasket with the narrow edge of the gasket toward the plain end.

4. Push the gland toward the socket and center it around the pipe with the gland lip against the gasket. Insert bolts and hand-tighten nuts. Make deflection after joint assembly but before tightening bolts.

6. Tighten the torque limiting twist-off nuts in a clockwise direction (direction indicated by arrow on top of nut) until all wedges are in firm contact with the pipe surface. Continue tightening in an alternating manner until all of the nuts have been twisted off.

5. Tighten the bolts to the normal range of bolt torque [45-60 ft-lbs for 3 inch, 75-90 ft-lbs for 4 inch through 24 inch, 100-120 ft-lbs for 30 inch and 36 inch, and 120-150 ft-lbs for 42 inch and 48 inch.] while at all times maintaining approximately the same distance between the gland and the face of the flange at all

7. If removal is necessary, utilize the 5/8 inch hex heads provided. If reassembly is required, assemble the joint in the same manner as above; tighten the screws to 60 to 80 ft-lbs. If the Series 2000PV restraint is removed from the pipe, be sure that all of the screws, spacers (if required), and wedges are in place before the restraint is reassembled.

[The gasket provided may have been the EBAA-Seal™ Improved Mechanical Joint Gasket. This gasket is

Installation Instructions for 15PF00

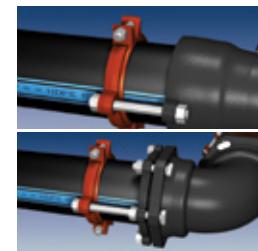
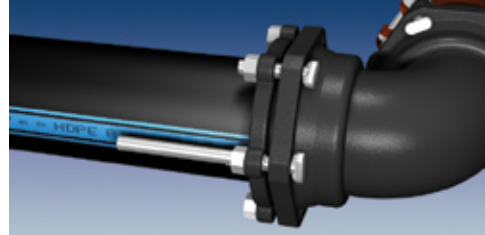

1. The Series 15PF00 is designed for restraining C900 PVC pipe and HDPE pipe at ductile iron fittings supplied with restraining ears or mechanical joints. It has a split, serrated restraint ring on the spigot and attaches to the fitting with connecting thrust rods.

4. Tighten the connecting thrust rods until snug; do not over tighten connecting thrust rods as to move the spigot further into the joint.

2. Assemble joint per the pipe and fitting manufacturer's instructions. In case of mechanical joint, create seal according to mechanical joint gland manufacturer's instructions. [The use of a pipe wall stiffening insert is required on High Density Polyethylene pipe.]

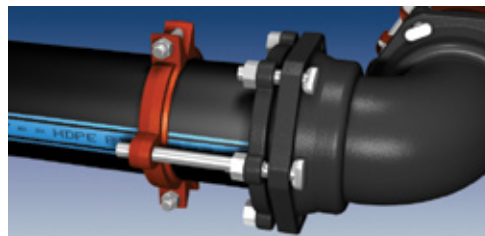
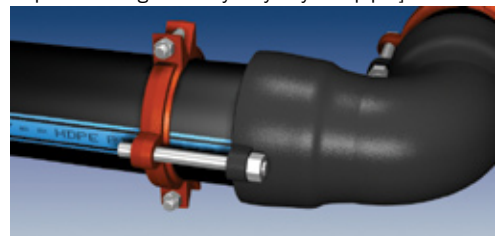
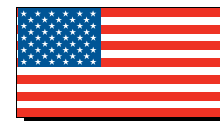

3. Using the connecting thrust rods to determine the proper restraint location, install both halves of the restraint by tapping them into place. Allow enough room on the connecting thrust rods to fully engage the nuts with several threads showing. Make sure the ID of the restraint is touching the pipe before installing and tightening of side bolts. Side bolts are to be evenly tightened to 110 ft-lbs of torque (60 ft-lbs on 4 inch and 6 inch). A torque indicating wrench will help facilitate this.

EBAA IRON Sales, Inc.

P.O. Box 857, Eastland, TX 76448

Tel: (254) 629-1731

Fax: (254) 629-8931

(800) 433-1716 within US and Canada

contact@ebaa.com

www.ebaa.com