

### Specifications

#### Construction:

- Rugged one-piece, die-cast aluminum housing secures the thermally conductive LED panel and electrical chamber
- Low profile, 3G vibration rated compact design minimizes wind load requirements.
- Housing is completely sealed against moisture and environmental contaminants.

#### Optics:

- Available in IES Type III, IV, V distributions
- Light engines are available in standard 4000 K and 5000 K (70 CRI) configurations.
- Scalable Lumen Packages from 5,360 to 42,000 Lumens replaces up to 1000W Metal Halide.
- Optics is precisely designed to shape the distribution, maximizing efficiency and application spacing.
- For the ultimate level of spill light control, an optional house-side shield accessory can be field or factory installed.
- The optics can conform to dark sky requirement.

#### Electrical:

- Universal 120-277 VAC or 347-480 VAC input voltage
- Standard with 1-10V dimming driver(s)
- THD: ≤20%
- Power Factor: ≥90%

#### Controls:

- Optional occupancy sensor
- Optional Photocell

#### Ambient Temperature:

- Ambient operating temperature -40° C to 45° C (-40 F to 113 F).

#### Installation:

- Suitable for mounting heights ranging from 26-50' in area lighting applications
- Round pole, Square pole, slipfitter and wall mount are available
- The design can be operated by one person to install the whole lamp

#### Lifespan:

- Estimated 100,000-hour LED lifespan based on IES LM-80 results and TM-21 calculations

#### Finish:

- It's available in black or optional dark bronze, silvery gray or white.



Black



Dark Bronze



Silver Gray



White

#### Certifications:

- UL wet location listed and DLC qualified

Small Size: 40W/70W/100W



Medium Size: 150W/200W



Large Size: 250W/300W



#### Warranty:

Fudakin warrants that our LED products will be free from defects in materials and workmanship for a period of five (5) years from the date of delivery to the end user, including coverage of light output, color stability, driver performance and fixture finish. (For more information visit: <http://www.fudakinlighting.com/resources/warranty/>)

#### Note:

Actual performance may differ as a result of end-user environment and application. All values are design or typical values, measured under laboratory conditions at 25 C (±5 C) specifications subject to change without notice.

### Applications:

Auto dealerships, parking lots, walkways, roadways, campuses, facade lighting, grocery stores and other public areas.



# 5 FIVE YEARS WARRANTY

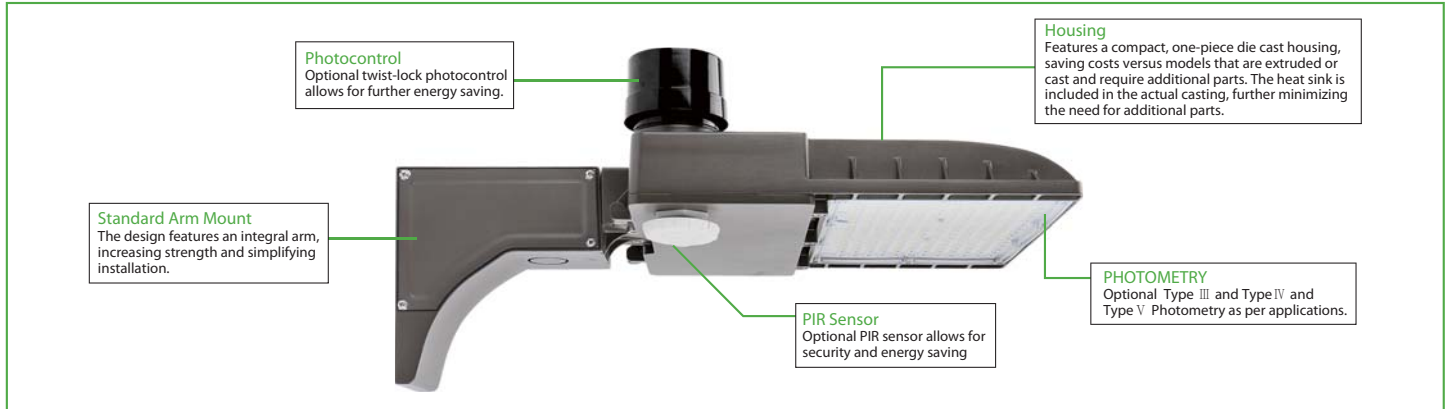

## PERFORMANCE DATA

			4000K(70CRI)		5000K(70CRI)	
SYSTEM WATTS	VOLTAGE	DIST. TYPE	LUMENS	LPW	LUMENS	LPW
40W	120-277V	3	5400lm	135 lm/W	5500lm	138 lm/W
	120-277V	4	5360lm	134 lm/W	5480lm	137 lm/W
	120-277V	5	5600lm	140 lm/W	5720lm	143 lm/W
45W	347-480V	3	5900lm	131 lm/W	6000lm	133 lm/W
	347-480V	4	5850lm	130 lm/W	5940lm	132lm/W
	347-480V	5	6120lm	136 lm/W	6210lm	138 lm/W
70W	120-277V	3	9500lm	136 lm/W	9600lm	137 lm/W
	120-277V	4	9310lm	133 lm/W	9450lm	132 lm/W
	120-277V	5	9730lm	139 lm/W	9800lm	140 lm/W
75W	347-480V	3	9800lm	131 lm/W	10000lm	133 lm/W
	347-480V	4	9750lm	130 lm/W	9900lm	132 lm/W
	347-480V	5	10200lm	136 lm/W	10350lm	138 lm/W
100W	120-277V	3	13500lm	135 lm/W	13800lm	138 lm/W
	120-277V	4	13200lm	132 lm/W	13300lm	133 lm/W
	120-277V	5	13800lm	138 lm/W	13900lm	139 lm/W
150W	120-277V	3	20500lm	137 lm/W	20800lm	139 lm/W
	347-480V	3	21000lm	140 lm/W	21300lm	143 lm/W
	120-277V/347-480V	4	19800lm	132 lm/W	20000lm	133 lm/W
	120-277V	5	20500lm	137 lm/W	20800lm	139 lm/W
200W	347-480V	5	21000lm	140 lm/W	21000lm	140 lm/W
	120-277V/347-480V	3	25500lm	128 lm/W	26000lm	130 lm/W
	120-277V/347-480V	4	24600lm	123 lm/W	24800lm	124 lm/W
250W	120-277V/347-480V	5	25500lm	128 lm/W	26000lm	130 lm/W
	120-277V/347-480V	3	34000lm	136 lm/W	34500lm	138 lm/W
	120-277V/347-480V	4	33250lm	133 lm/W	33750lm	135 lm/W
300W	120-277V/347-480V	5	34750lm	139 lm/W	35250lm	141 lm/W
	120-277V	3	40500lm	135 lm/W	41000lm	137 lm/W
	347-480V	3	41500lm	138 lm/W	42000lm	140 lm/W
	120-277V/347-480V	4	39600lm	132 lm/W	39900lm	133 lm/W
300W	120-277V	5	40500lm	135 lm/W	41000lm	137 lm/W
	347-480V	5	41500lm	138 lm/W	42000lm	140 lm/W

## PHOTOMETRICS

Fudakin offers a complete set of optical systems to meet every site lighting requirement. These systems provide remarkable flexibility in precisely matching light distribution patterns to specific site requirements.

Type 3 optics produce an asymmetrical pattern that directs the majority of the light forward and equally on both sides of the luminaire. In a back-to-back configuration, it creates a rectangular pattern which can extend pole spacings.

Type 4 is suitable for applications where light is primarily required forward with minimal backlight. Typical installations include perimeter poles.

Type 5 optics produce a symmetrical square distribution pattern that distributes light equally on all sides of the luminaire. Type 5 luminaires is universal for most area lighting applications

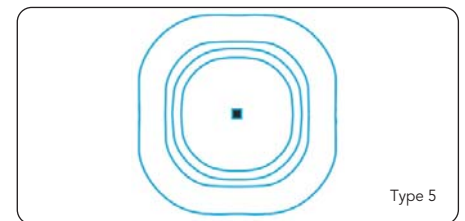
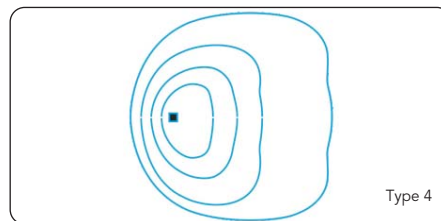
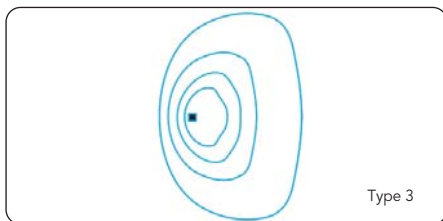







# 5 FIVE YEARS WARRANTY

## ELECTRICAL DATA

Number Of Drivers	Driver Current (mA)	Nominal Power (W)	INPUT VOLTAGE (V)	CURRENT (Amps)
1	980	40	120	0.33
		40	208	0.19
		40	240	0.17
		40	277	0.14
		45	347	0.13
		45	480	0.09
1	1720	70	120	0.58
		70	208	0.34
		70	240	0.29
		70	277	0.25
		75	347	0.22
		75	480	0.16
1	2450	100	120	0.83
		100	208	0.48
		100	240	0.42
		100	277	0.36
1	3900	150	120	1.25
		150	208	0.72
		150	240	0.63
		150	277	0.54
		150	347	0.43
		150	480	0.31
1	5100	200	120	1.67
		200	208	0.96
		200	240	0.83
		200	277	0.72
		200	347	0.58
		200	480	0.42
1	6400	250	120	2.08
		250	208	1.20
		250	240	1.04
		250	277	0.90
		250	347	0.72
		250	480	0.52
1	6000	300	120	2.50
		300	208	1.44
		300	240	1.25
		300	277	1.08
		300	347	0.86
		300	480	0.63

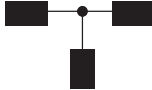
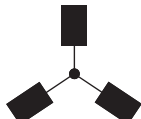
## EPA OF AREA LIGHT

Item							
	1	2 @90°	2 @120°	2@180°	3 @90°	3 @120°	4 @90°
40W/70W/100W	0.3413	0.5929	0.7983	0.6826	1.0239	1.0499	1.0239
150W/200W	0.423	0.735	0.873	0.846	1.158	1.185	1.158
250W/300W	0.4759	0.7889	1.0581	0.9518	1.2648	1.3711	1.2648



# 5 FIVE YEARS WARRANTY

## MOUNTING

- Standard versatile mounting arm accommodates multiple drilling patterns as well as square and round poles
- Wall Mount available for direct wall mounting and J-box mounting
- Optional for cast aluminum slipfitter mounting adapter (Compatible with more FUDAKIN mounting adaptors such as Tenon, suits for various application)

### Mounting Options



**Arm Mount** (4" and 5" Square and Round poles)  
Standard versatile mounting arm is simple to install and can be used with existing poles for retrofit installations.

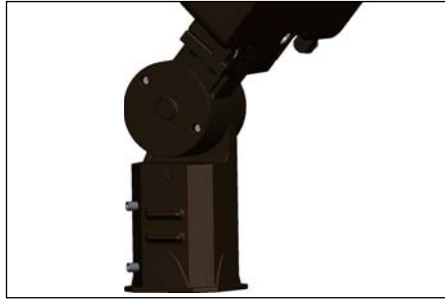

**Slipfitter Mount**  
An optional cast aluminum mast arm adapter secures fixture head to nominal 2"(2-3/8" O.D. pipe size) horizontal steel tenon arm.



**Wall Mount**  
Wall Mount is easy to install for direct wall mounting with 1/2" conduit wiring or standard J-box mounting

### Mounting Dimensions

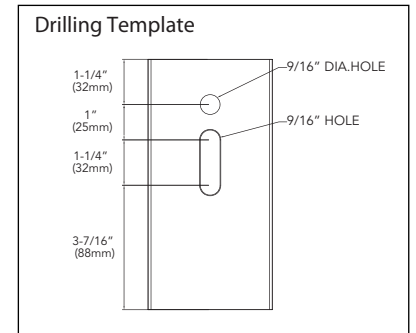
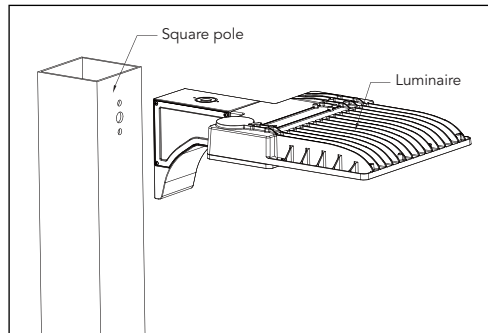
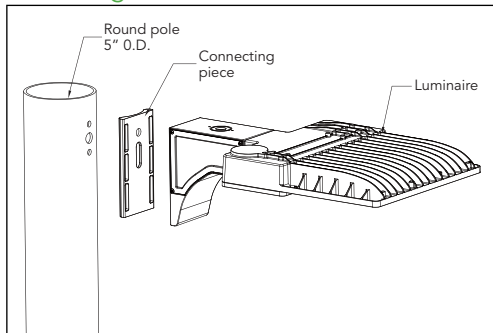

## DIMENSION

unit: inch/mm

### 40W/70W/100W (Slipfitter Mount)

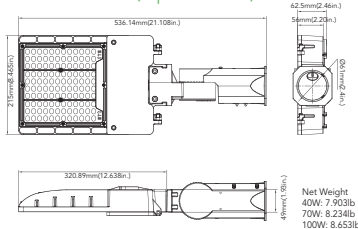

### 40W/70W/100W (Pole Mount)

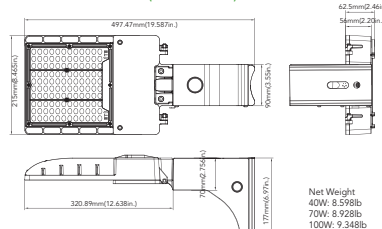

### 40W/70W/100W (Wall Mount)

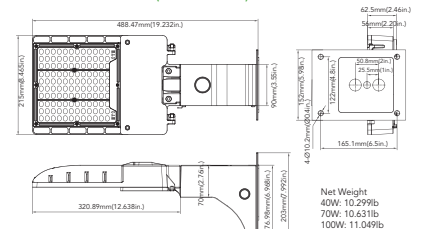

**5 FIVE YEARS WARRANTY**

150W/200W (Slipfitter Mount)

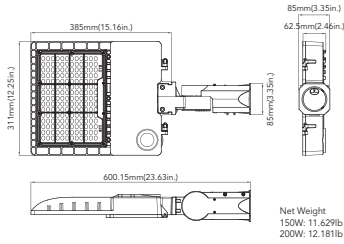

Net Weight  
150W: 11.629lb  
200W: 12.181lb

150W/200W (Pole Mount)

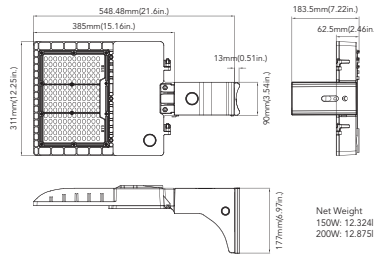

Net Weight  
150W: 12.324lb  
200W: 12.875lb

150W/200W (Wall Mount)

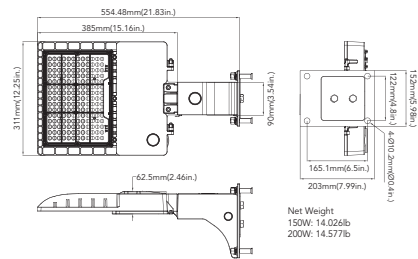

Net Weight  
150W: 14.026lb  
200W: 14.577lb

250W/300W (Slipfitter Mount)

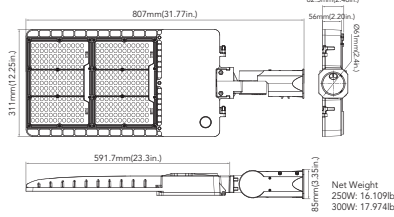

Net Weight  
250W: 16.109lb  
300W: 17.974lb

250W/300W (Pole Mount)

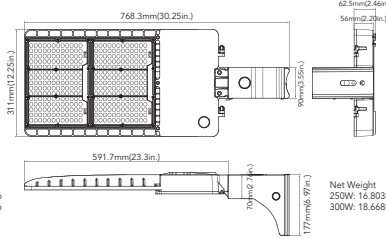

Net Weight  
250W: 18.803lb  
300W: 18.668lb

250W/300W (Wall Mount)

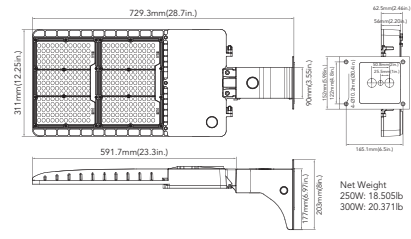

Net Weight  
250W: 18.505lb  
300W: 20.371lb

## ORDERING GUIDE

Example: FDK-AL-F2-100W-27V-XXK-YYYYYY

Fixture Type	Wattage	Voltage	CCT	Finish	Photocell (Option)	Sensor (Option)	Mounting	Photometry	Surge Protection (Option)
<input type="checkbox"/>	<input type="checkbox"/>	<input type="checkbox"/>	<input type="checkbox"/>	<input type="checkbox"/>	<input type="checkbox"/>	<input type="checkbox"/>	<input type="checkbox"/>	<input type="checkbox"/>	<input type="checkbox"/>
<b>FDK-AL-F2</b> Area Light F2 Series	<b>40</b> 40W <b>45</b> 45W <b>70</b> 70W <b>75</b> 75W <b>100</b> 100W	<b>27V</b> 120-277V <b>48V</b> 347-480V	<b>40K</b> 4000K <b>50K</b> 5000K	<b>D</b> Dark Bronze <b>B</b> Black <b>W</b> White <b>SG</b> Silver Gray	<b>P0</b> 120-277V Photocell <b>P3</b> 347V Photocell <b>P4</b> 480V Photocell <b>Blank</b> Without Photocell	<b>M</b> With 120-277V Sensor <b>Blank</b> Without Sensor	<b>SQ</b> Square Pole Mount <b>SP</b> Slipfitter Mount <b>WM</b> Wall Mount	<b>T3</b> TYPE III Photometry <b>T4</b> TYPE IV Photometry <b>T5</b> TYPE V Photometry	<b>S</b> Surge protection <b>(Blank)</b> No Surge protection

Note: 1. 100W is limited to 120-277V input only.  
2. The Watt is 40W when the voltage is 120-277V, while when it is 347-480V, the watt is 45W.  
3. The Watt is 70W when the voltage is 120-277V, while when it is 347-480V, the watt is 75W.

Example: FDK-AL-F2-150W-27V-XXK-YYYYYY

Fixture Type	Wattage	Voltage	CCT	Finish	Photocell (Option)	Sensor (Option)	Mounting	Photometry
<input type="checkbox"/>	<input type="checkbox"/>	<input type="checkbox"/>	<input type="checkbox"/>	<input type="checkbox"/>	<input type="checkbox"/>	<input type="checkbox"/>	<input type="checkbox"/>	<input type="checkbox"/>
<b>FDK-AL-F2</b> Area Light F2 Series	<b>150</b> 150W <b>200</b> 200W <b>250</b> 250W <b>300</b> 300W	<b>27V</b> 120-277V <b>48V</b> 347-480V	<b>40K</b> 4000K <b>50K</b> 5000K	<b>D</b> Dark Bronze <b>B</b> Black <b>W</b> White <b>SG</b> Silver Gray	<b>P0</b> 120-277V Photocell <b>P3</b> 347V Photocell <b>P4</b> 480V Photocell <b>Blank</b> Without Photocell	<b>M</b> With 120-277V Sensor <b>Blank</b> Without Sensor	<b>SQ</b> Square Pole Mount <b>SP</b> Slipfitter Mount <b>WM</b> Wall Mount	<b>T3</b> TYPE III Photometry <b>T4</b> TYPE IV Photometry <b>T5</b> TYPE V Photometry



# 5 FIVE YEARS WARRANTY

## ADDITIONAL MOUNTING ACCESSORIES

POLE BRACKET • For mounting one fixture on an existing pole			
 <p>60mm(2 3/8in.) 183.6mm(7.228in.) 76mm(3in.) 102±1mm(4in.)</p>	<p><b>4" Square Pole Mount with 2-3/8" O.D. Tenon</b> No. 4SQ-SP-D Finish: Dark Bronze USE: For use with square, non-tapered steel and aluminum poles. Furnished with four 5/16" hex head stainless-steel bolts. Vertical tenon measures 2-3/8" O.D., and is made of steel tubing. Fixtures mounted to this bracket can be adjusted both vertically and horizontally.</p>	 <p>60mm(2 3/8in.) 222.5mm(8.76in.) 101.6mm(4in.) 106.68mm(4.2in.)</p>	<p><b>4" Round Pole Mount with 2-3/8" O.D. Tenon</b> NO. 4SOR-SP-D Finish: Dark Bronze USE: For use with Round, non-tapered steel and aluminum poles. Furnished with three 3/8" hex head stainless-steel bolts. Vertical tenon measures 2-3/8" O.D., and is made of steel tubing. Fixtures mounted to this bracket can be adjusted both vertically and horizontally.</p>
 <p>60mm(2 3/8in.) 183.6mm(7.228in.) 76mm(3in.) 127±1mm(5in.)</p>	<p><b>5" Square Pole Mount with 2-3/8" O.D. Tenon</b> No. 5SQ-SP-D Finish: Dark Bronze USE: For use with square, non-tapered steel and aluminum poles. Furnished with four 5/16" hex head stainless-steel bolts. Vertical tenon measures 2-3/8" O.D., and is made of steel tubing. Fixtures mounted to this bracket can be adjusted both vertically and horizontally.</p>	 <p>60mm(2 3/8in.) 222.5mm(8.76in.) 101.6mm(4in.) 131.86mm(5.19in.)</p>	<p><b>5" Round Pole Mount with 2-3/8" O.D. Tenon</b> NO. 5SOR-SP-D Finish: Dark Bronze USE: For use with Round, non-tapered steel and aluminum poles. Furnished with three 3/8" hex head stainless-steel bolts. Vertical tenon measures 2-3/8" O.D., and is made of steel tubing. Fixtures mounted to this bracket can be adjusted both vertically and horizontally.</p>
 <p>154.5±1mm(6.08 in.) 102±1mm(4 in.) 108.6mm(4.28in.) 63mm(2.48in.)</p>	<p><b>Pole Bracket accessories-Tenon &amp; Yoke Adaptor</b> NO. SP-TR-D Finish: Dark Bronze USE: The 2-3/8" OD Tenon Mount Adaptor for Yoke Fixtures is designed to mount FUDAKIN light fixtures that are equipped with a yoke mount onto a 2-3/8" OD tenon. It may be utilized with the FUDAKIN Flood Light Series of light fixtures.</p>		
WALL BRACKET • Attaches to any flat surface • Provides wiring access		Mid-Pole tenon Bracket	
 <p>60mm(2 3/8in.) 102±1mm(4in.) 152.4mm(6in.) 227.2mm(7.76 in.)</p>	<p><b>90° Wall Mount Bracket with 2-3/8" O.D. Tenon</b> NO. WM-SP-D Finish: Dark Bronze USE: The 90° wall mount bracket with 2-3/8" tenon attaches an FUDAKIN floodlight to almost any surface: wall, roof, or wood pole. Provides wiring access and built-in 2-3/8" O.D. tenon to mount a fixture with our adjustable slipfitter. Suggested 3/8" diameter bolts for mounting. Mounting holes are spaced 3-1/4" apart.</p>	 <p>185mm(7.28in.) 180mm(7.08 in.) 100mm(3.94 in.) 60mm(2.36in.)</p>	<p><b>2-3/8" OD Horizontal Tenon Mid-Pole Bracket</b> NO. SQ-SP-D Finish: Dark Bronze USE: 2-3/8" OD Horizontal Tenon Mid-Pole Bracket is designed to mount light fixture that is equipped with a adjustable slipfitter onto a 2-3/8" OD horizontal tenon</p>
Round External Mount Horizontal Tenon • To mount 2/3/4 fixtures on a existing pole			
 <p>184mm(7.25in.) 101.6mm(4in.) 60mm(2.36in.) 63.5mm(2.5in.)</p>	<p><b>Double 90° Horizontal Tenon Adaptor</b> NO. R60-SP2-90-D Finish: Dark Bronze USE: The Bracket is designed to mount over 2-3/8" (60mm) O.D. vertical tenon. Two fixtures can be mounted to the Round External Mount Horizontal Tenon and adjusted horizontally</p>	 <p>184mm(7.25in.) 101.6mm(4in.) 60mm(2.36in.) 63.5mm(2.5in.)</p>	<p><b>Triple 120° Horizontal Tenon Adaptor</b> NO. R60-SP3-120-D Finish: Dark Bronze USE: The Bracket is designed to mount over 2-3/8" (60mm) O.D. vertical tenon. Three fixtures can be mounted to the Round External Mount Horizontal Tenon and adjusted horizontally</p>
 <p>184mm(7.25in.) 101.6mm(4in.) 60mm(2.36in.) 63.5mm(2.5in.)</p>	<p><b>Double 180° Horizontal Tenon Adaptor</b> NO. R60-SP2-180-D Finish: Dark Bronze USE: The Bracket is designed to mount over 2-3/8" (60mm) O.D. vertical tenon. Two fixtures can be mounted to the Round External Mount Horizontal Tenon and adjusted horizontally</p>	 <p>184mm(7.25in.) 101.6mm(4in.) 60mm(2.36in.) 63.5mm(2.5in.)</p>	<p><b>Quad 90° Horizontal Tenon Adaptor</b> NO. R60-SP4-90-D Finish: Dark Bronze USE: The Bracket is designed to mount over 2-3/8" (60mm) O.D. vertical tenon. Four fixtures can be mounted to the Round External Mount Horizontal Tenon and adjusted horizontally</p>
 <p>184mm(7.25in.) 101.6mm(4in.) 60mm(2.36in.) 63.5mm(2.5in.)</p>	<p><b>Triple 90° Horizontal Tenon Adaptor</b> NO. R60-SP3-90-D Finish: Dark Bronze USE: The Bracket is designed to mount over 2-3/8" (60mm) O.D. vertical tenon. Three fixtures can be mounted to the Round External Mount Horizontal Tenon and adjusted horizontally</p>		



# 5 FIVE YEARS WARRANTY

