



Electrical Safety and Overcurrent Protection

Brian Lewis
Field Application Engineer
Bussmann division

Contact info:
Phone: 858-210-1557
Email: BrianLewis1@eaton.com



Agenda

1. Overcurrents and the NEC®
2. Electrical hazards overview
3. The role of the overcurrent protective device
4. Methods to determine Arc Flash Boundary & PPE
5. Arc-flash mitigation
 - Safety by design
 - Maintenance considerations

Overcurrents and the NEC®

Overview of overcurrents

NEC Article 100 Definition

Overcurrent. Any current in excess of the rated current of equipment or the ampacity of a conductor. It may result from overload, short circuit, or ground fault.

- Effects of overcurrents
 - Fires & explosions
 - Conductor damage
 - Equipment damage
 - Arc-flash

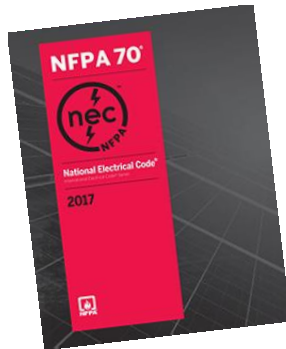
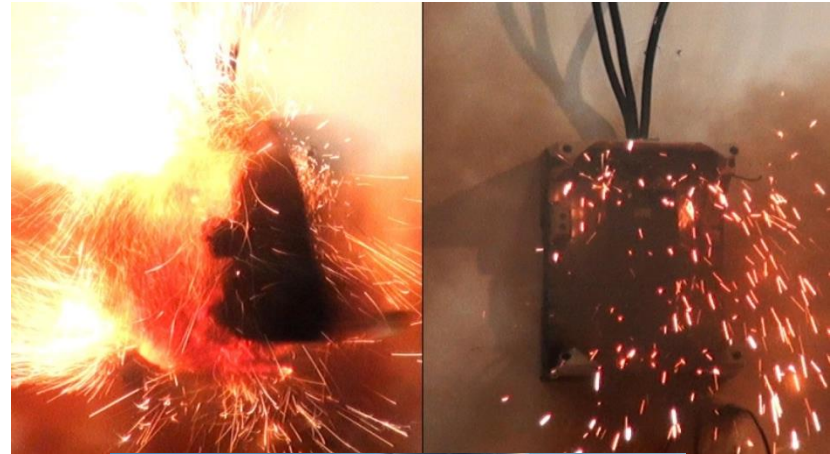

Overloads

NEC Article 100 Definition

Overload. Operation of equipment in excess of normal, full-load rating, or of a conductor in excess of rated ampacity that, when it persists for a sufficient length of time, would cause damage or dangerous overheating. A fault, such as a short circuit or ground fault, is not an overload.

- Effects of overloads
 - Fires
 - Conductor damage
 - Equipment damage
 - Component failure



Normal load current

$$I_L = V_S / R_T$$

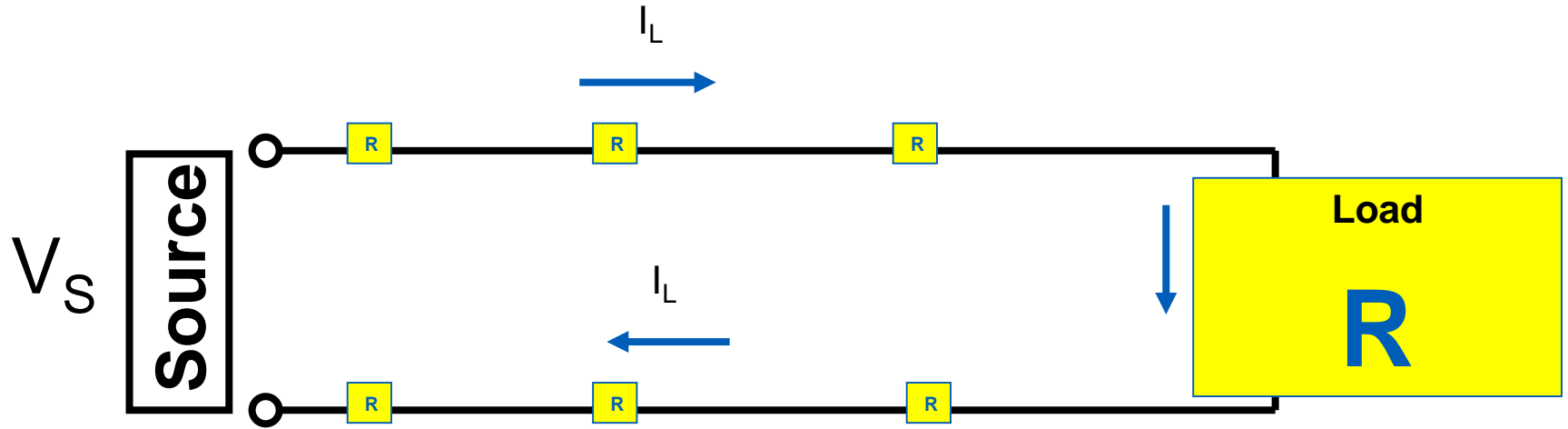

Overload current

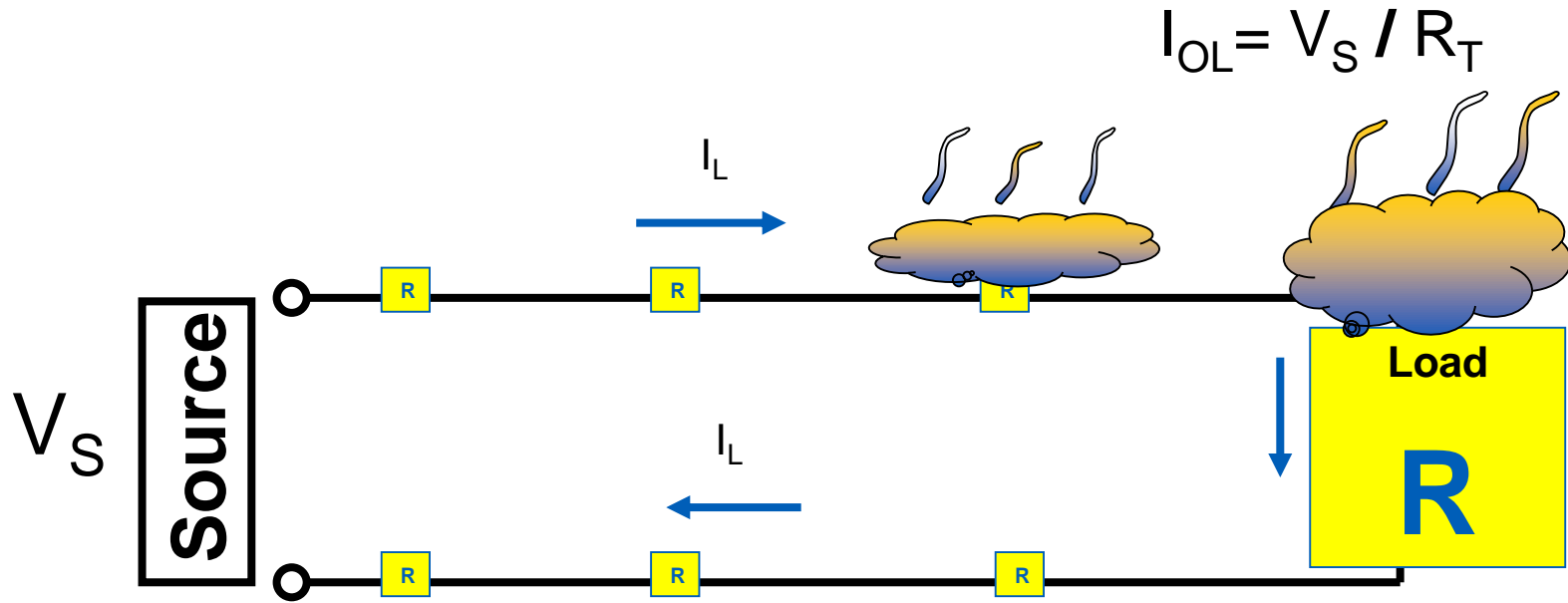

Current flows within the normal path

Fault current

NEW NEC 2020 Article 100 Definitions

Fault Current. The current delivered at a point on the system during a short-circuit condition.

Fault Current, Available (Available Fault Current).

The largest amount of current capable of being delivered at a point on the system during a short-circuit condition.

(Bolted Fault)

- An overcurrent, typically hundreds to thousands of times greater than normal operating current
- Up to 30 kA or greater than 200 kA
- Can be between phases and/or phase to ground

Effects of Fault current

- Warp and distort busbars and associated bracing beyond repair
- Severe insulation damage
- Melting or vaporizing conductors
- Vaporizing metal, including buswork in electrical equipment
- Ionized gases
- Fires and explosions

Fault current

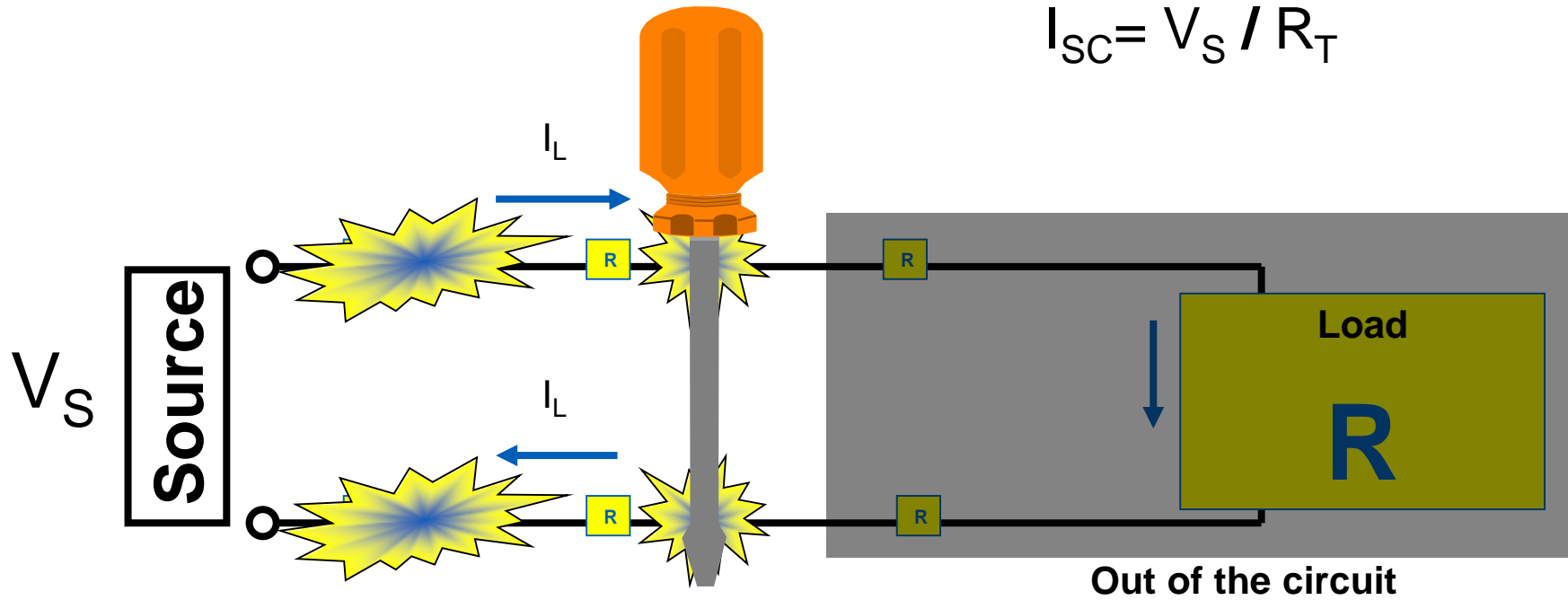

Current flows outside the normal path

Typical fault currents



Home receptacle
200 – 500 A



Home service
2,000 – 10,000 A



Light industrial
up to 70,000 A



Heavy industrial
up to 100,000 A



Large city
may exceed
200,000 A

High fault currents are prevalent and extremely destructive

Symmetrical fault current

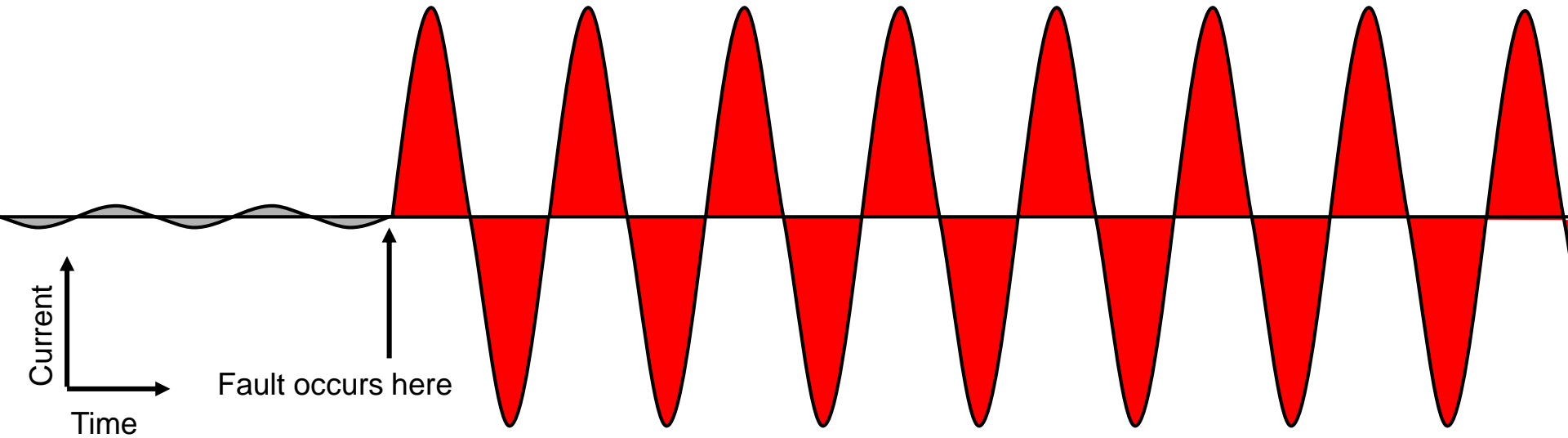

Asymmetrical fault current

- Asymmetry due to:
 - Power factor
 - Point on cycle when initiated
 - Location in system

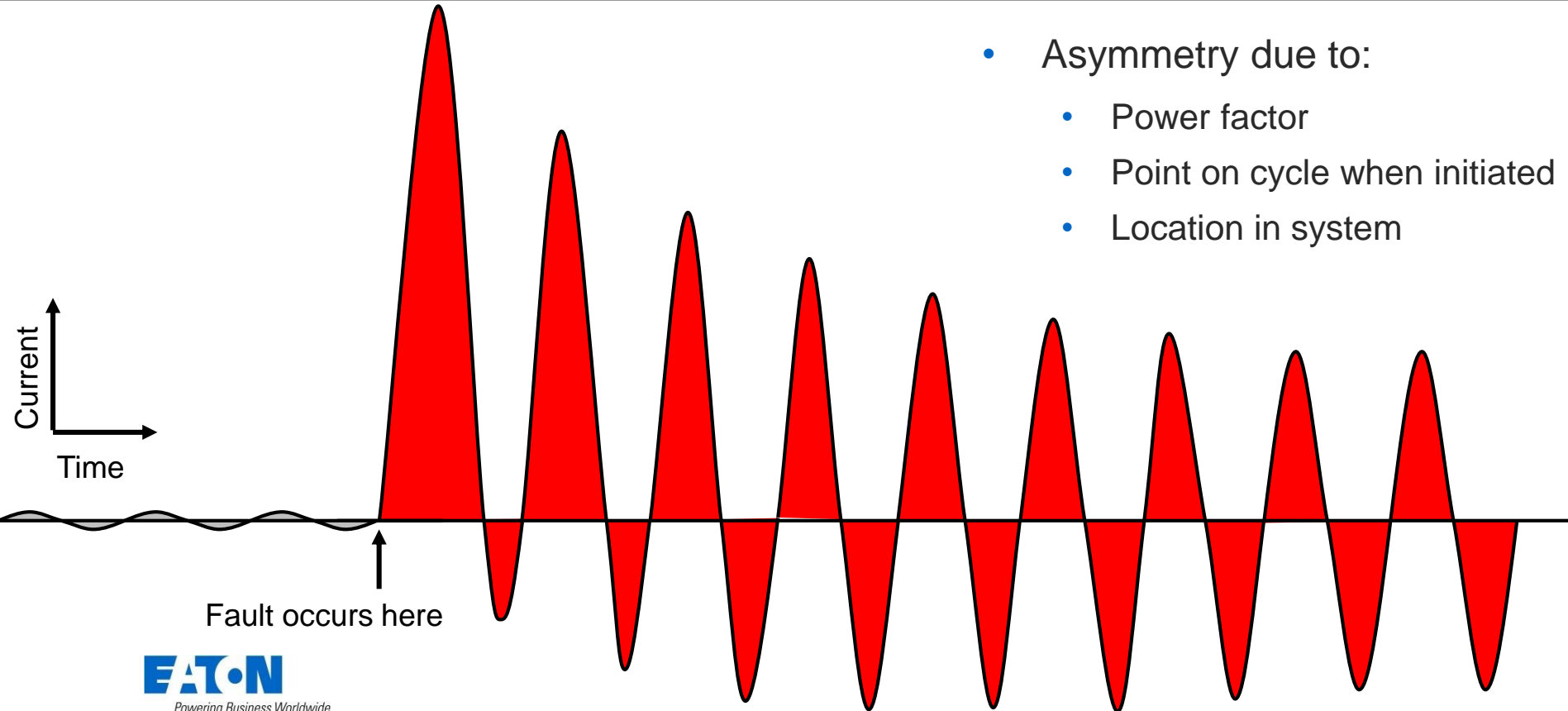

Fault calculations and use

- Bolted fault currents used to evaluate:
 - Interrupting rating (IR) – NEC 110.9
 - Short-circuit current rating (SCCR) – NEC 110.10
 - Selective Coordination
- Arcing fault currents used to evaluate
 - Arc flash energy and determine PPE for electrical safe work practices

Bolted fault

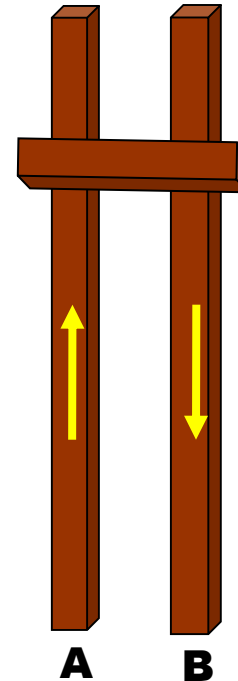

Arcing fault

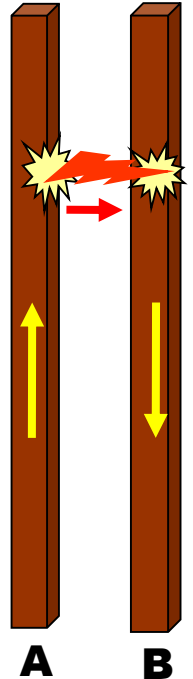

Interrupting rating

NEC Article 100 Definition

Interrupting Rating. The highest current at rated voltage that a device is identified to interrupt under standard test conditions.

NEC Requirement

110.9 Interrupting Rating. Equipment intended to interrupt current at fault levels shall have an interrupting rating at nominal circuit voltage at least equal to the current that is available at the line terminals of the equipment.

- The highest current a fuse or breaker can *safely* interrupt – self protection rating
- Must be equal to or greater than the available fault current at the line terminals

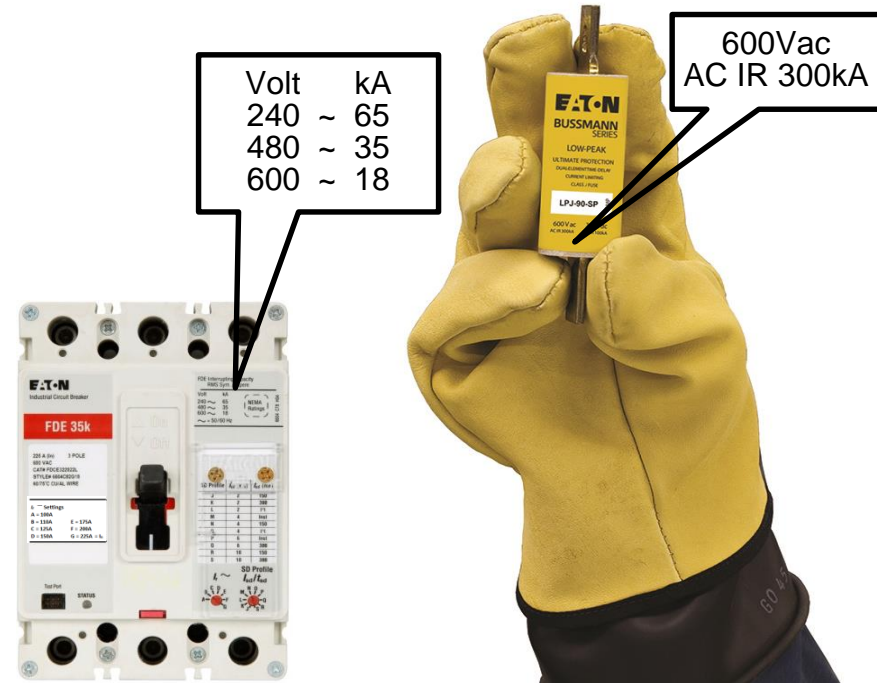

Same Requirements are found in OSHA 1910.303(b)(4) – Ties this to safety

Importance of interrupting rating – Circuit Breaker

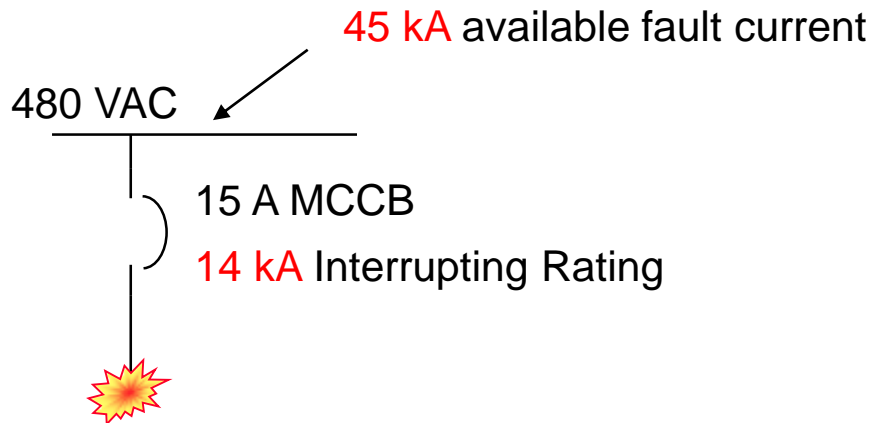
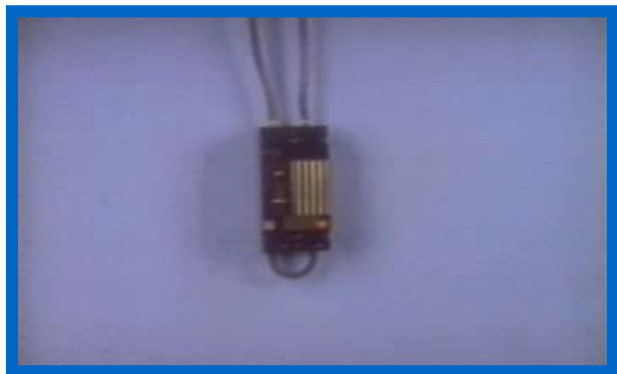

Violates NEC 110.9 and OSHA 1910.303(b)(4)

NEC applies to new installations, OSHA applies to both new and existing installations

Still photos of misapplication

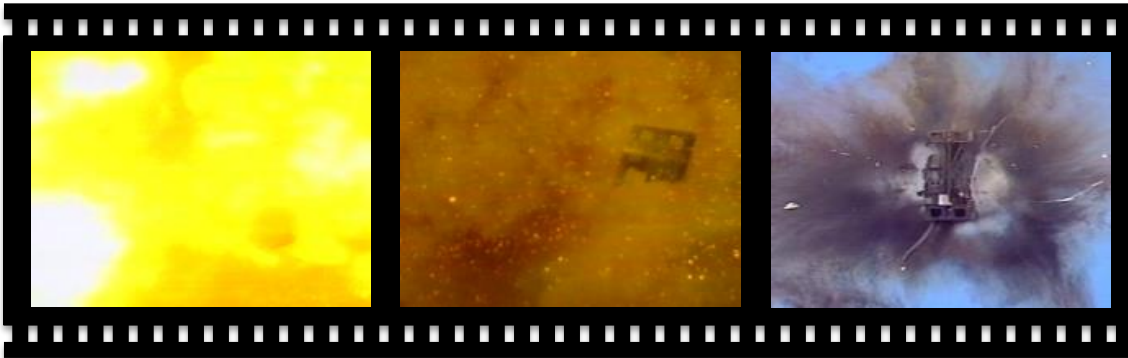

Importance of interrupting rating - Fuse

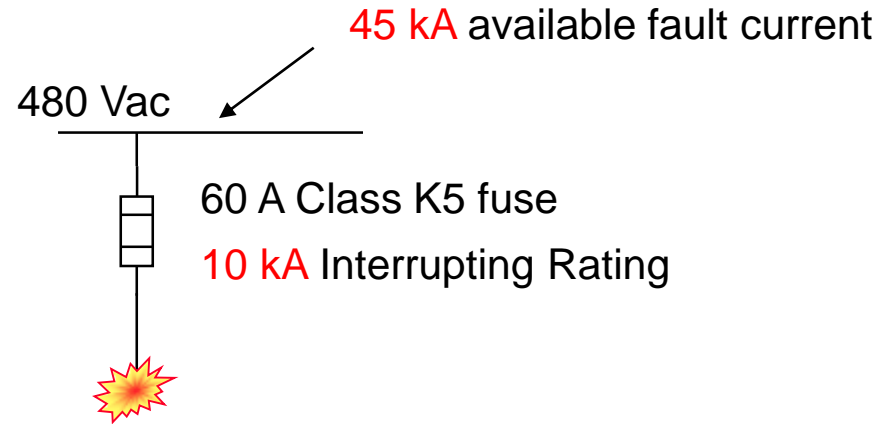
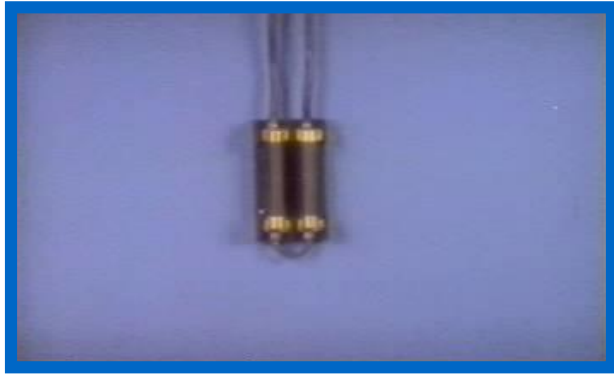

Violates NEC 110.9 and OSHA 1910.303(b)(4)

Still photos of misapplication

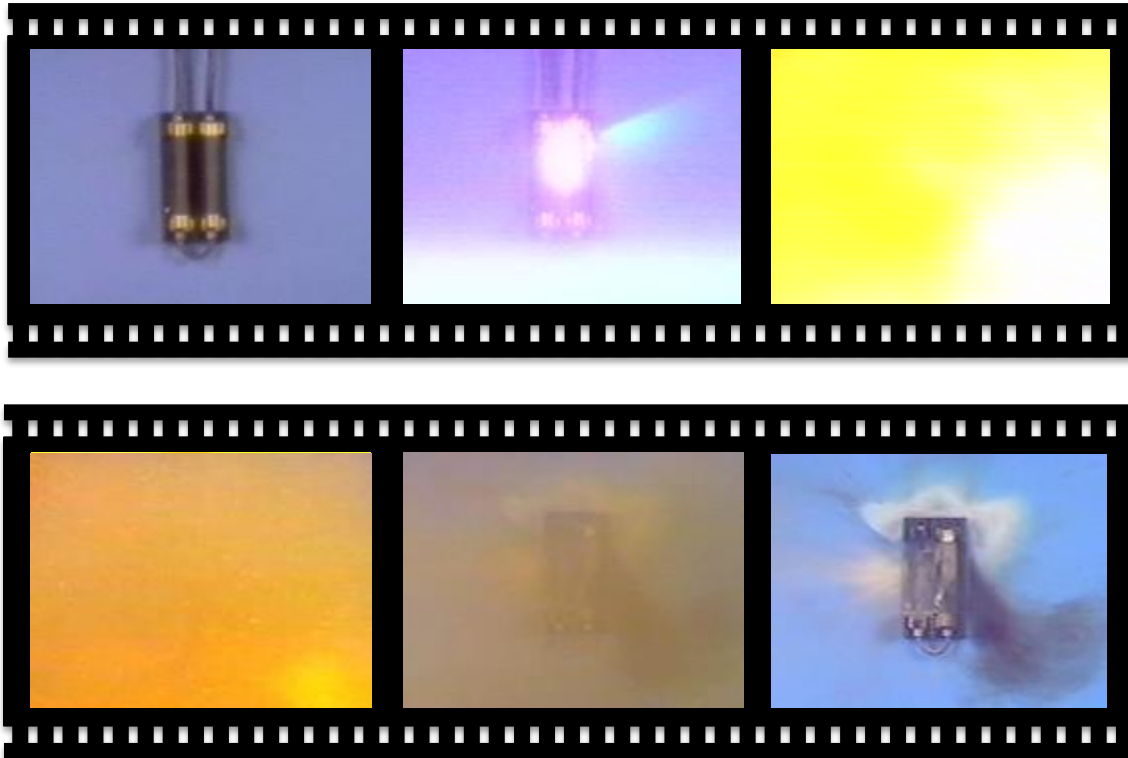

Interrupting rating – proper application

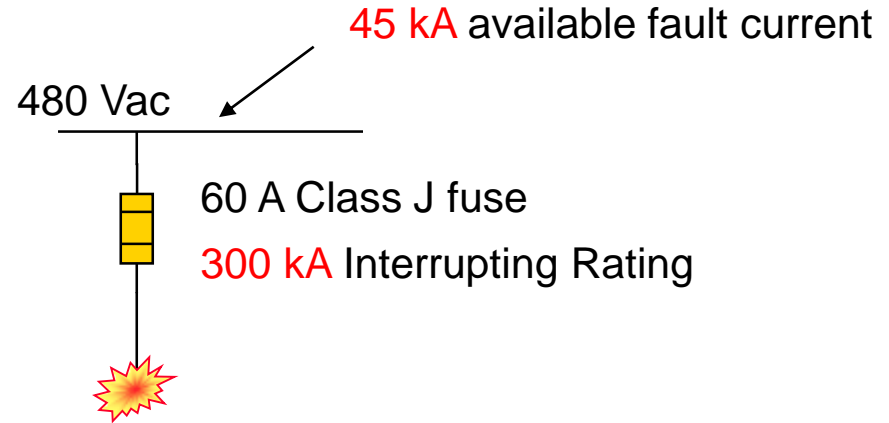
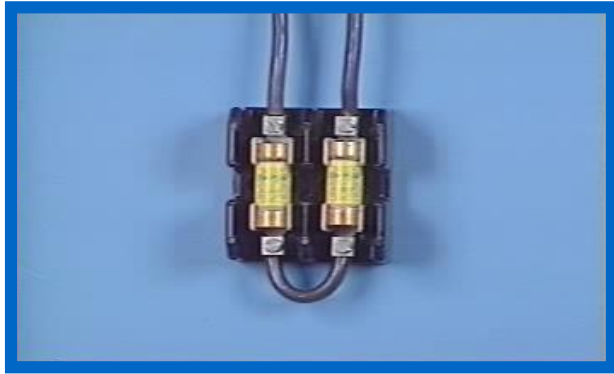

Complies with NEC 110.9 and OSHA 1910.303(b)(4)

What is short-circuit current rating?

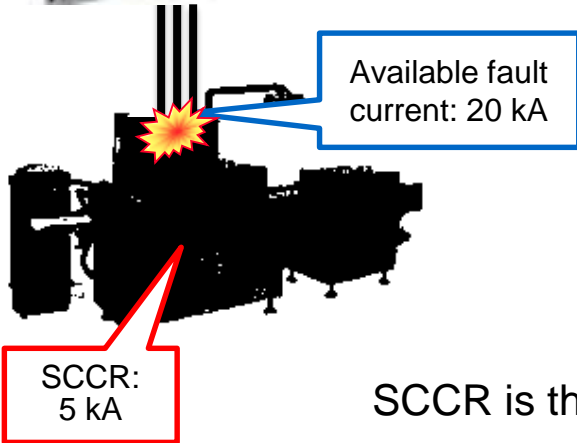

NEC Article 100 Definition

Short-Circuit Current Rating. The prospective symmetrical fault current at a nominal voltage to which an apparatus or system is able to be connected without sustaining damage exceeding defined acceptable criteria.

Hazards of insufficient SCCR

- **Shock:** Enclosure becomes energized from conductors pulling away from terminations
- **Fire:** Explosive power blows off door exposing flames and molten metal to exterior
- **Projectile (shrapnel):** Enclosure door explosively blows open emitting failing device debris

SCCR is the equipment rating

SCCR is the withstand rating of the equipment

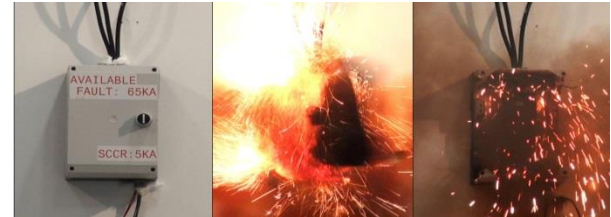

A serious misapplication



Another misapplication



Combination motor starter 5 kA SCCR
50 kA available fault current

Key requirement for SCCR

NEC Requirement

110.10 Circuit Impedance & Other Characteristics. The overcurrent protective devices, the total impedance, the component short-circuit current ratings, and other characteristics shall be selected and coordinated to permit the circuit-protective devices used to clear a fault to do so without extensive damage to the electrical components of the circuit.

- OCPDs and SCCR must be “*selected and coordinated*”
- OCPDs must clear fault without extensive damage
- SCCR applies to the device or equipment

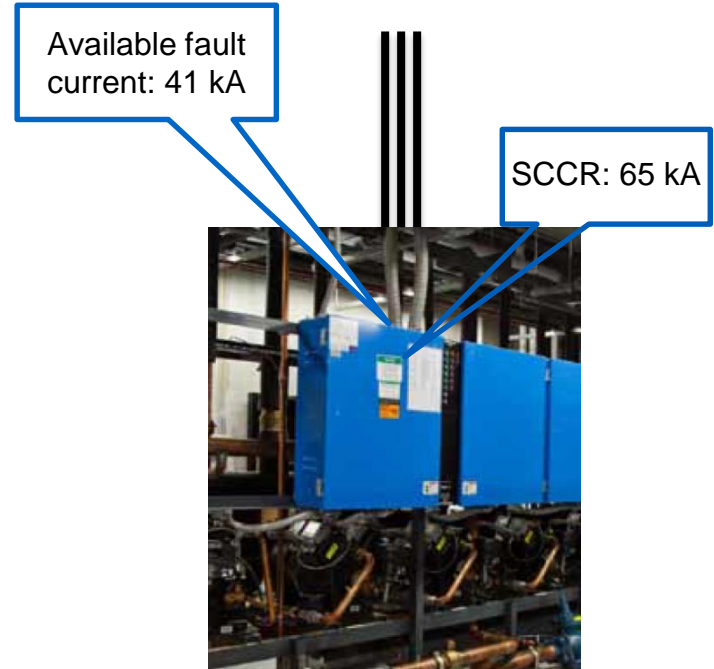

2017 NEC committee statements

1. Emphasis on proper installation for equipment SCCR
2. Equipment is being ordered, installed and energized with inadequate SCCR
3. AHJs need more tools and procedures to simplify enforcement of SCCR

*“This change provides much needed information to **aid the electrical inspector when enforcing** 409.22. It will help the inspector ensure that the industrial control panel is installed within its short-circuit current rating.”*

First Revision No. 3002 - 409.22(B)
Industrial Control Panels

*“Inspectors are having an extremely difficult **time enforcing proper short-circuit current ratings of HVACR equipment** because there is typically no information on the job site as to the available fault current at the HVACR equipment...”*

First Revision No. 3006 - 440.10
HVAC/R Equipment

SCCR marking requirements

NEC Section	Equipment type
409.110(A)	Industrial control panels
430.8	Motor controllers
430.98	Motor control centers
<i>440.4(B)</i>	<i>Air Conditioning and refrigeration equipment</i>
<i>620.16(A)</i>	<i>Elevator control panel</i>
670.3(A)(4)	Industrial machinery
<i>700.5(E)</i>	<i>Equipment transfer switches for emergency systems</i>
<i>701.5(D)</i>	<i>Equipment transfer switches for legally required standby systems</i>
<i>702.5</i>	<i>Equipment transfer switches for optional standby systems</i>
<i>708.24(E)</i>	<i>Equipment transfer switches for critical operations power systems</i>

Red italic text indicates 2017 change

Available fault current requirements

NEC Section	Equipment type (mark/document fault current)
110.24	Service entrance equipment (mark/document)
408.6	Switchboards, switchgear, and panelboards (mark)*
409.22(B)	Industrial control panels (document)
430.99	Motor control centers (document)
440.10(B)	<i>Air Conditioning and refrigeration equipment (document)</i>
620.51(D)(2)	<i>Elevator control panel (mark)</i>
670.5(2)	Industrial machinery (mark)
NEC Section	Equipment type (fault current can not exceed SCCR)
409.22(A)	Industrial control panels
440.10(A)	<i>Air Conditioning and refrigeration equipment</i>
620.16(B)	<i>Elevator control panel</i>
670.5(1)	Industrial machinery

Red italic text indicates 2017 change. * indicates 2020 change

Service entrance equipment

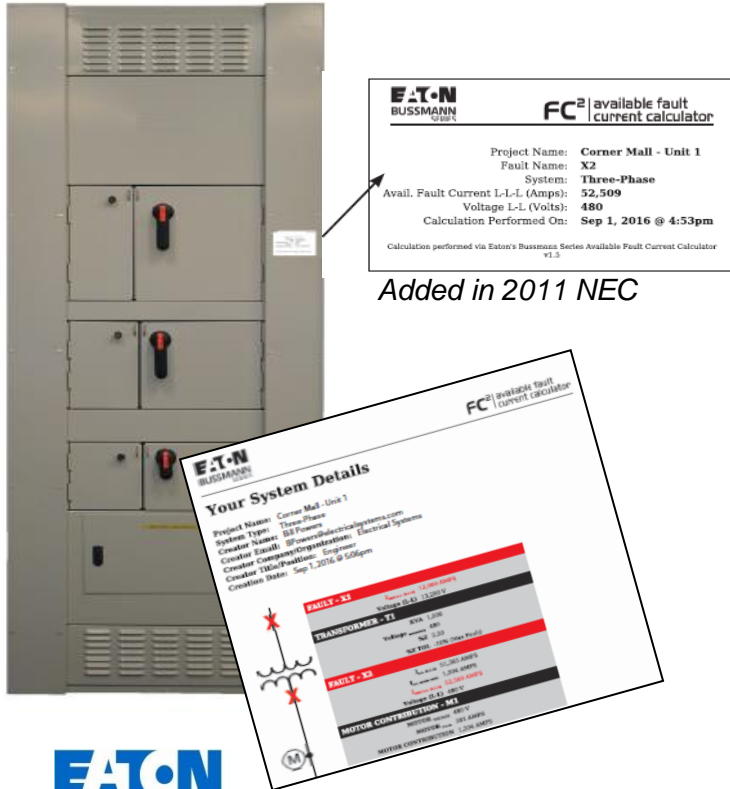

EATON
BUSSMANN
FC² available fault
current calculator

Project Name: Corner Mall - Unit 1
Fault Name: X2
System: Three-Phase
Avail. Fault Current L-L (Amps): 52,509
Voltage L-L (Volts): 480
Calculation Performed On: Sep 1, 2016 @ 4:53pm

Calculation performed via Eaton's Busmann Series Available Fault Current Calculator v1.5

Added in 2011 NEC

EATON
BUSSMANN
FC² available fault
current calculator

Your System Details

Project Name: Corner Mall - Unit 1
System Type: 3-Phase
System Voltage: 480V
Creator Name: Bill Powers
Creator Email: bpowers@electricalsystems.com
Creator Company/Organization: Electrical Systems
Creator Title/Position: Engineer
Creation Date: Sep 1, 2016 @ 5:08pm

Component	Available Fault Current (Amps)
FAMILY - F1	52,509
TRANSFORMER - T1	52,509
FAMILY - F2	52,509
MOTOR CONTRIBUTION - M1	52,509

Code requirements

110.24(A)

- Available fault-current field marked on equipment
- *Documented and made available to those authorized to design, install, inspect, maintain and operate the system*

110.24(B)

- Verify or recalculate with changes in electrical system

Exceptions for industrial installations where only qualified persons service equipment

Red italic text indicates 2017 change

Determining available fault current

Method	Benefit	Result	Considerations
Utility published value	No calculations required	Worst case fault current	May require higher equipment ratings
As installed value (transformer nameplate)	Simple calculation (infinite primary)	Closer to actual fault current	Reduced equipment ratings but may not be adequate if system changes
SCCR of existing equipment	May be already calculated or use tools to calculate	Closer to actual fault current	May require research or calculations

Bussmann series FC² Available Fault Calculator

- Makes point-to-point calculations easy
- Create labels and prints system one-lines
- Available for Apple or Android devices



Current-limitation effects and Benefits

Non-current limiting

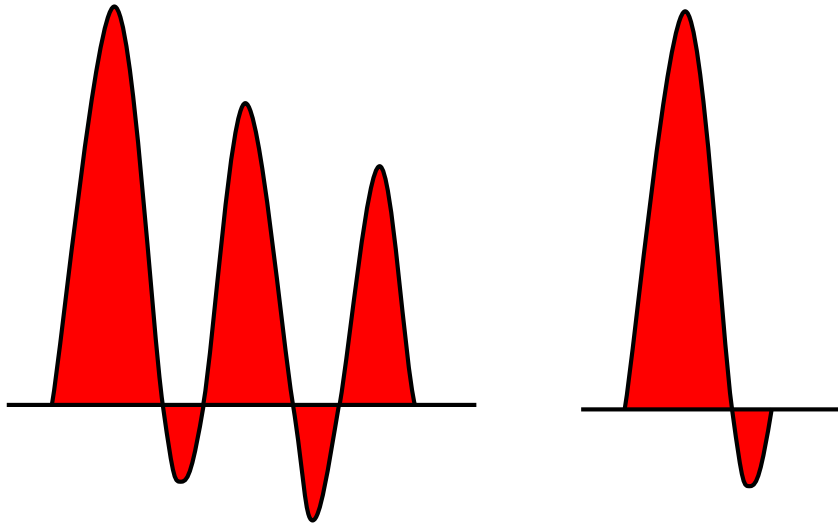

2-1/2 cycle opening

1 cycle opening

Current-limiting

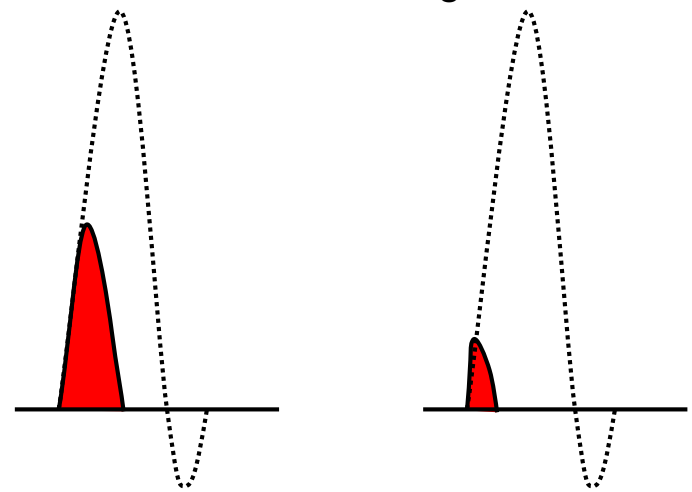

1/2 cycle opening

1/4 cycle opening

Peak Current is proportional to the amount of Mechanical/Magnetic Force. Red Shaded area under is the amount of thermal energy of the fault.

Current-limitation effects “cable whip” test

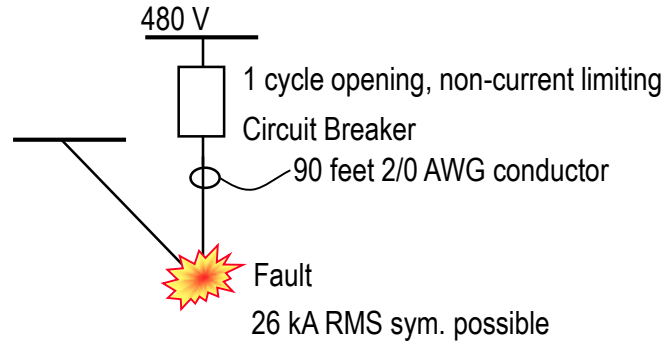

Test results:

- Ip let-through = 48.1 kA
- Clearing time = 16.7 ms

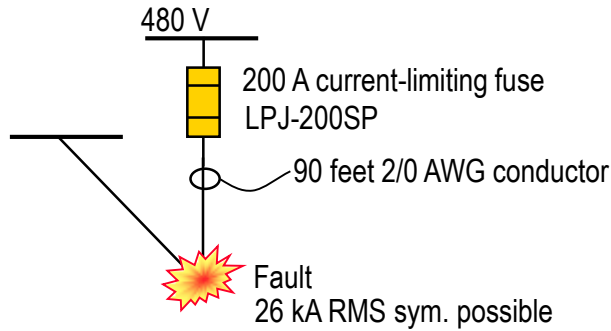

Test results:

- Ip let-through = 10.2 kA
- Clearing time = 4 ms

- Mechanical forces let-through: 1/25th
- Thermal energy let-through: 1/123rd

Changing the transformer – Determination of the fault current

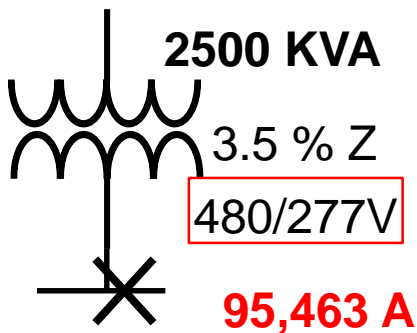
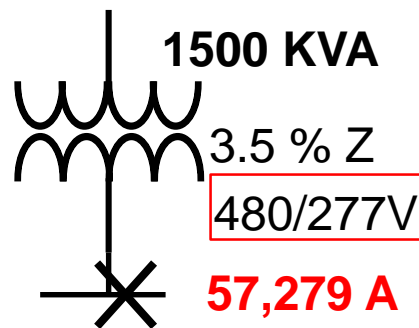
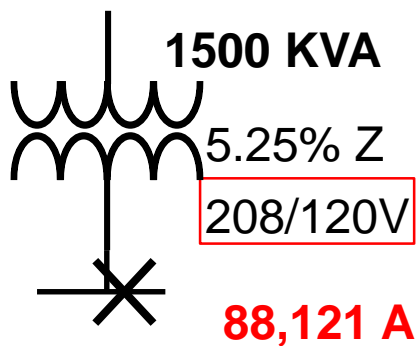
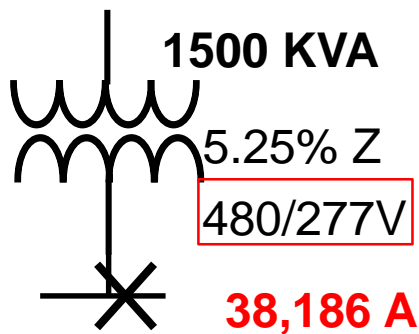

Calculations made assuming 10% impedance tolerance and using full motor contribution

Electrical hazard overview

What are the hazards?



Electrical hazards overview

- Shock
- Arc-flash
 - Heat
 - Fire
- Arc-blast
 - Pressure
 - Shrapnel
 - Sound



Electric shock hazards

NFPA 70E Article 100 Definition

Shock Hazard. A source of possible injury to health associated with current through the body caused by **contact or approach** to energized electrical conductors or circuit parts.

Informational Note: Injury and damage to health resulting from shock is dependent on the **magnitude of the electrical current**, the power source frequency (e.g., 60 Hz, 50 Hz, dc), and the path and time duration of current through the body. The physiological reaction ranges from perception, muscular contractions, inability to let go, ventricular fibrillation, tissue burns, and death.

Injury and damage to health depends on:

- **Current magnitude** – amount of current flowing through the body influenced by voltage and resistance of current path
- **Current path** – the direction current flows through the body
- **Time current flows** – length of time the body is in contact

Shock Hazard protection boundaries

NFPA 70E Table 130.4(D)(a) for AC systems

(1) Nominal System Voltage Range, Phase to Phase	(2) Limited Approach Boundary		(4) Restricted Approach Boundary
	Exposed Movable Conductor	Exposed Fixed Circuit Part	
Less than 50 V	Not specified	Not specified	Not specified
50 V – 150 V	3.0 m (10ft 0 in.)	1.0 m (3 ft 6 in.)	Avoid contact
151 V – 750 V	3.0 m (10ft 0 in.)	1.0 m (3 ft 6 in.)	0.3 m (1 ft 0 in.)

- Restricted approach boundary qualified persons only
- Limited approach boundary, qualified or unqualified if accompanied by qualified person

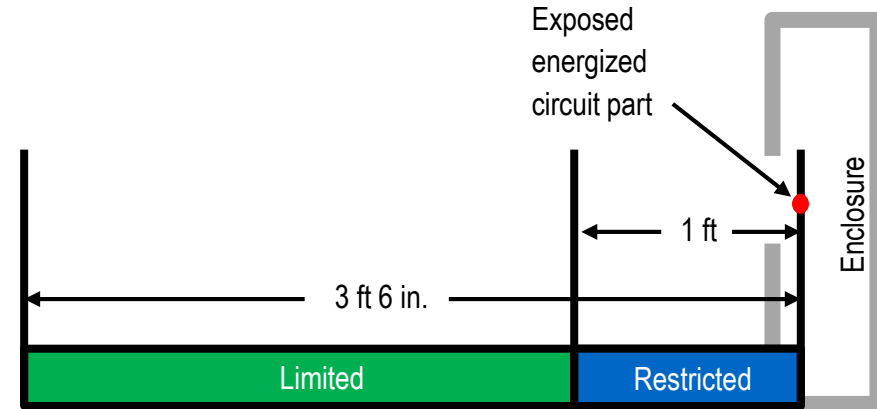

Shock approach boundary example at 480 VAC

Electric arc

Arcing Current Happens when current jumps from one Phase to another or Phase to Ground

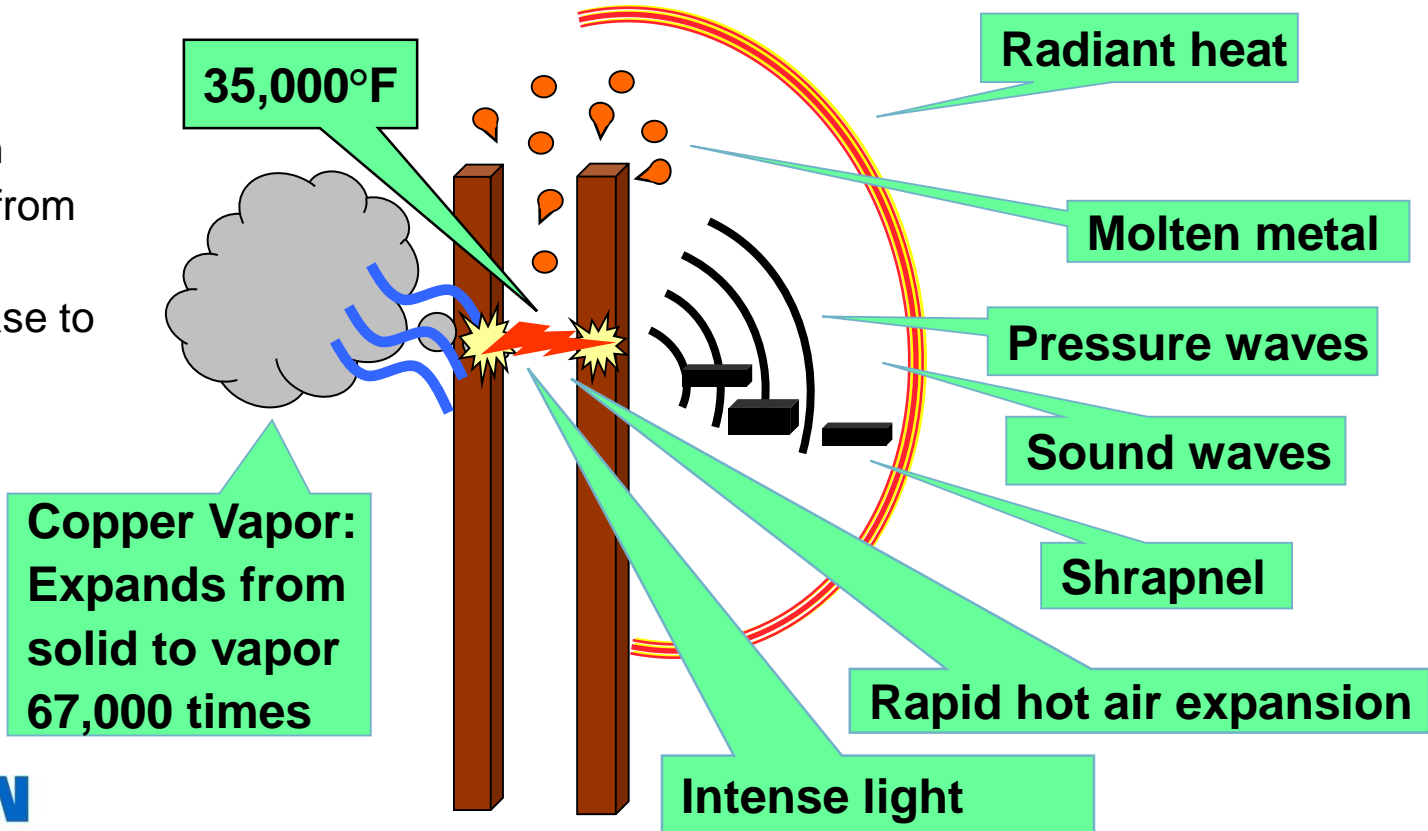

Hazards associated with arc-flash and arc-blast

- Heat – burns & ignition of material
 - Arc temperature of 35,000°F
 - Molten metal, copper vapor, heated air
- Second degree burn threshold:
 - 80°C / 175°F (0.1 sec), 2nd degree burn
- Third degree burn threshold:
 - 96°C / 205°F (0.1 sec), 3rd degree burn
- Intense light
 - Eye damage, cataracts
- Pressures from expansion of metals & air
- Eardrum rupture threshold:
 - 720 lbs/ft²
- Lung damage threshold:
 - 1728 - 2160 lbs/ft²
- Shrapnel
- Flung across room or from ladder/bucket

The role of the overcurrent protective device

The role of the overcurrent protective device

Arc flash boundary and incident energy exposure levels both depend upon:

- Duration of the arc-fault
 - Time to clear
 - Related to speed of OCPD
- Arc-fault current magnitude
 - Related to available fault current
 - Current-limitation can reduce



IEEE/PCIC staged arc-flash tests in Late Nineties

- Ad-hoc safety committee
 - Users
 - Consultants
 - Manufacturers
 - Medical examiners
- IEEE paper published March 2000 which laid the ground work for IEEE1584

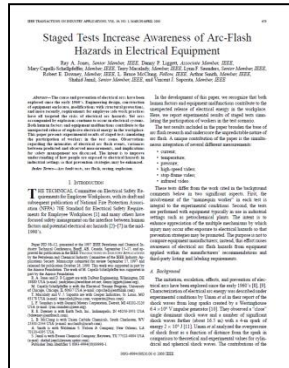

Copyright IEEE, with Special Permission to Cooper Bussmann

Test 4: 640A non-current limiting device

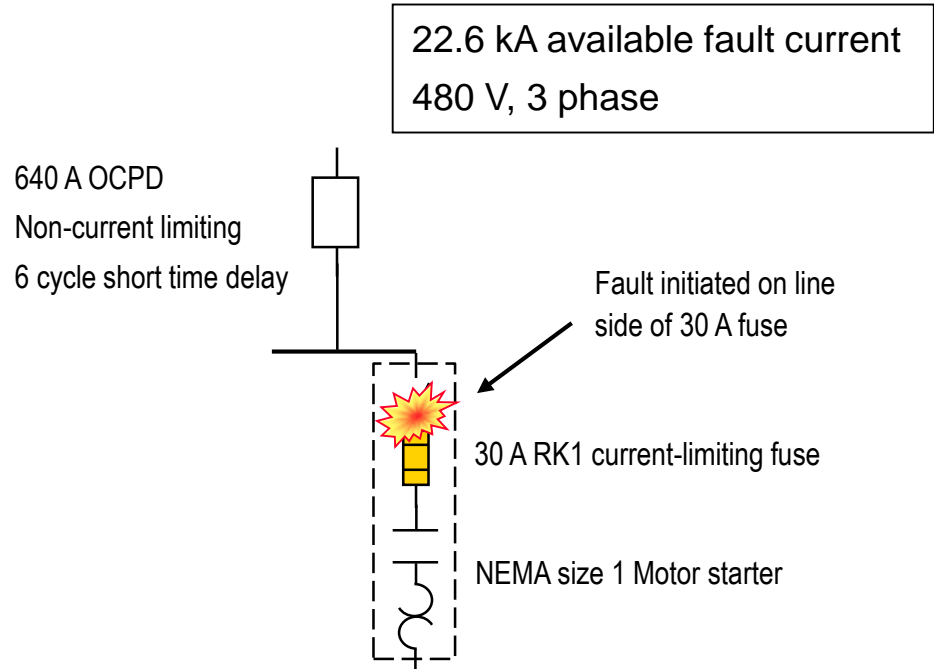

The upstream device that will determine what the incident energy is

Test 4 still photos



Test 4 still photos



Test 4 still photos



Test 4 still photos



Copyright IEEE, with Special Permission to Cooper Bussmann

Test 4 still photos



Test 4 still photos



Copyright IEEE, with Special Permission to Cooper Bussmann

Test 4 results

- Feeder OCPD provided protection
 - 640 A w/ STD
 - Opened in 6 cycles
 - Non-current limiting
- Incident energy:
 - 5.8 cal/cm² @ 18"

IEEE 1584-2002 basic equations

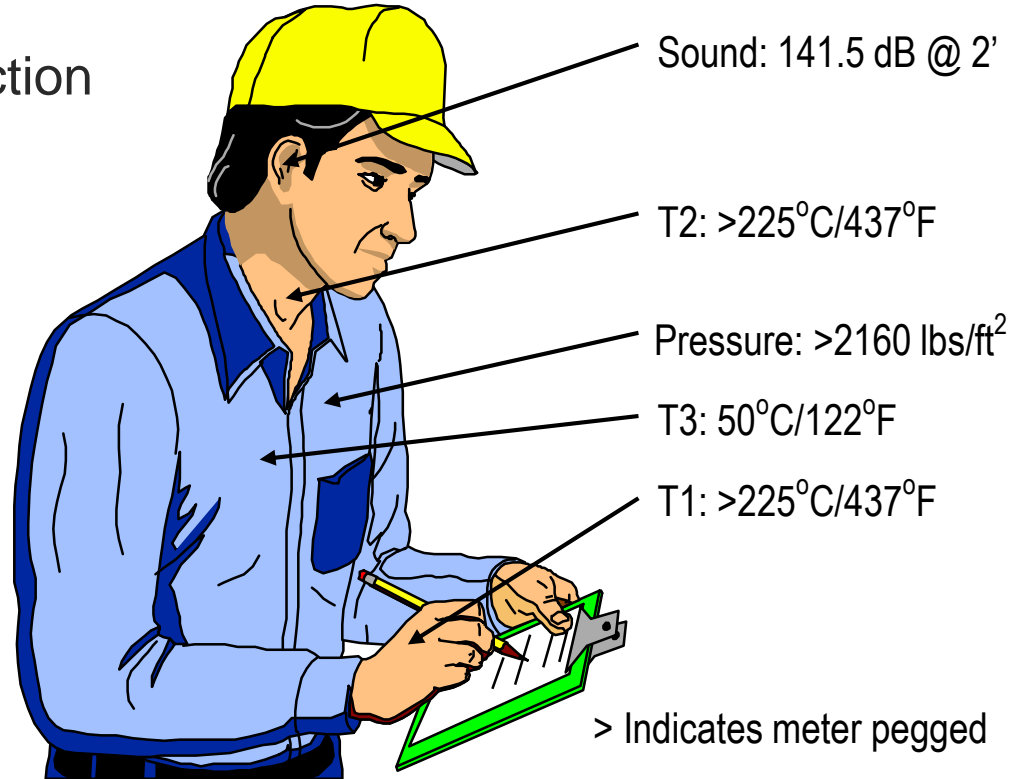

Test 3: 601A current-limiting Class L fuse



22.6 kA available fault current
480 V, 3 phase

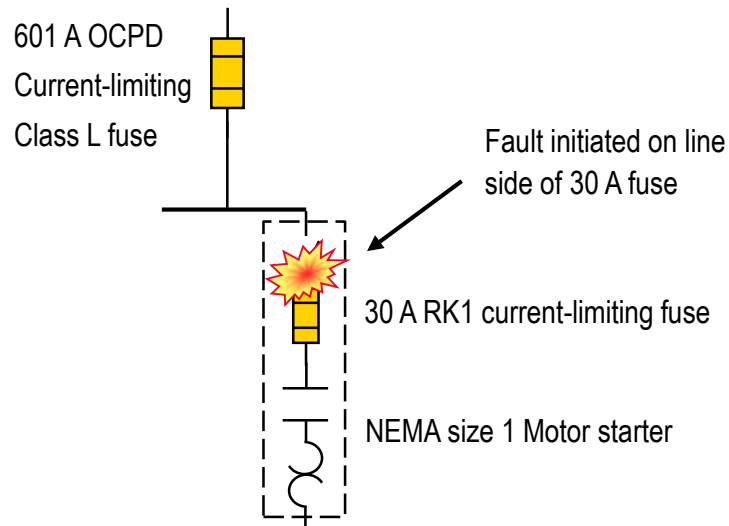

Test 3 still photos



Test 3 still photos



Test 3 still photos



Test 3 results

- Feeder OCPD provided protection
 - 601 A Class L fuse
 - Opened in less than ½ cycle
 - current-limiting
- Incident energy:
 - 1.6 cal/cm² @ 18"

IEEE 1584-2002 simplified fuse equations

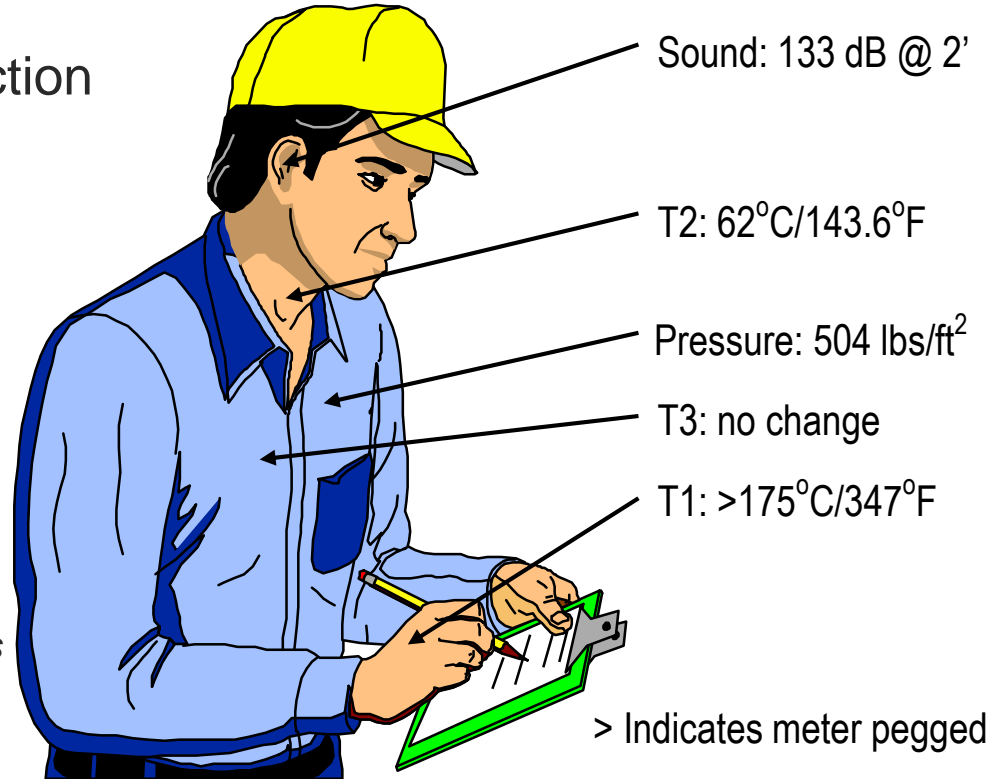

Test 1: 30A current-limiting Class RK1 fuse



22.6 kA available fault current
480 V, 3 phase

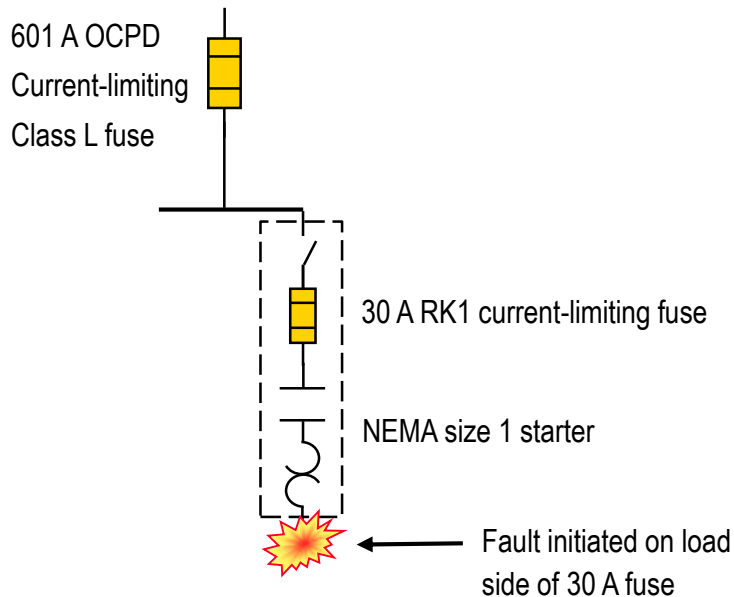

Test 1 still photos



Copyright IEEE, with Special Permission to Cooper Bussmann

Copyright IEEE, with Special Permission to Cooper Bussmann

Copyright IEEE, with Special Permission to Cooper Bussmann

Test 1 results

- Branch OCPD provided protection
 - 30 A Class RK1 fuse
 - Opened in less than ½ cycle
 - Current-limiting
- Incident energy:
 - $< 0.25 \text{ cal/cm}^2 @ 18''$

IEEE 1584-2002 simplified fuse equations

Note: actual hazard based on feeder device



Powering Business Worldwide

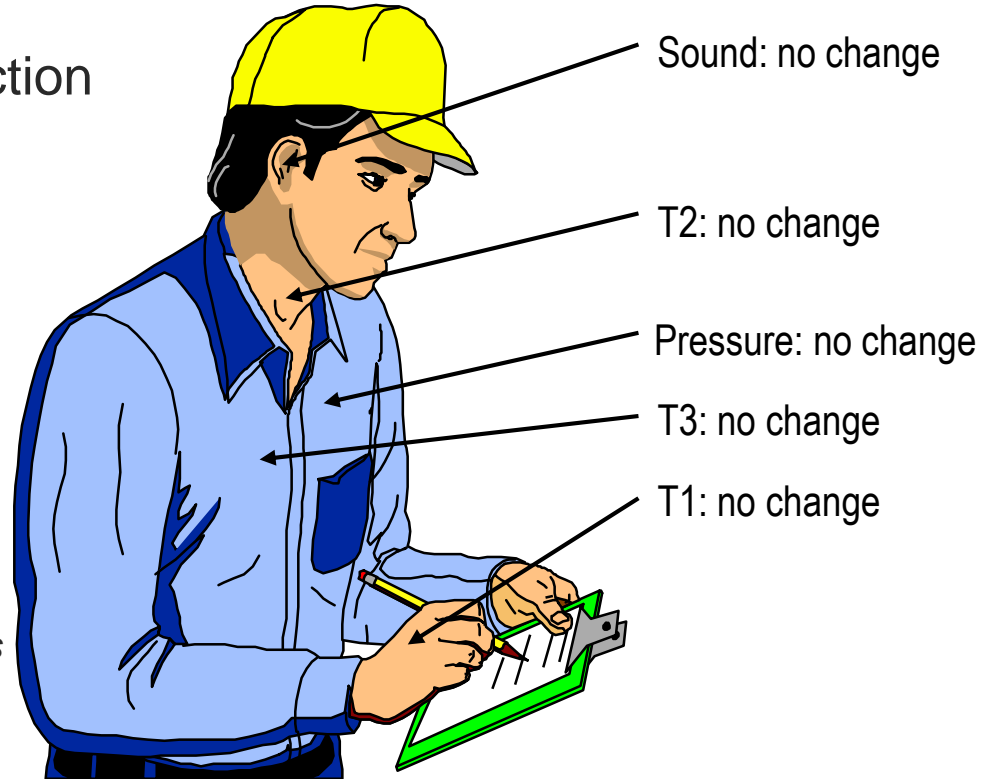

Comparison of test results

Test 4



Test 3



Test 1

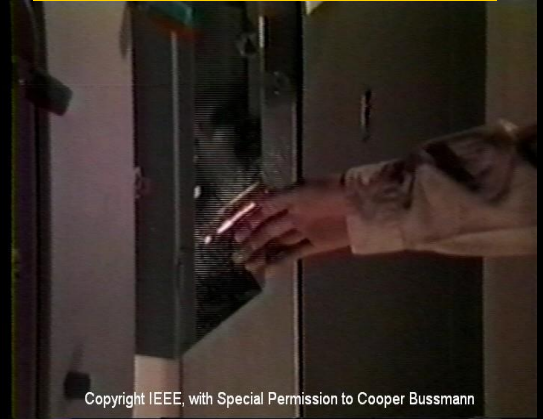

Non-current limiting

AFB = 47", I.E. = 5.8 cal/cm²

IEEE 1584-2002 (basic equations)

Current-limiting

AFB = 21", I.E. = 1.6 cal/cm²

IEEE 1584-2002 (simplified fuse equations)

Current-limiting

AFB = 6", I.E. = <0.25 cal/cm²

Overview of Methods to determine arc flash boundary and PPE

Methods to Determine Arc Flash Boundary and Arc Flash PPE

- Two Main Methods to Determine Arc Flash Boundary and Arc Flash PPE are:
 - Incident energy analysis methods (1584) – NFPA 70E 130.5(G)
 - Arc flash PPE category method – NFPA 70E 130.7(C)(15)
- How does Overcurrent Protection plays into these methods

First Method – Basic Equations for calculating incident energy

2002 IEEE 1584 Method	Brief Description (Key Differentiating Points)	Comments
Basic Equations NFPA 70E Annex D D.4.1 to D.4.5	<ul style="list-style-type: none">• Based on testing• Ability to change many variables• For any overcurrent protective device (OCPD)• Process:<ol style="list-style-type: none">1. Determine the available (bolted) fault current2. Use the IEEE 1584 arcing current equations to determine the arcing current3. Using OCPD time-current characteristics, determining the OCPD clearing time for the arcing current4. Repeat step 3 for 85% of arcing current5. Use IEEE 1584 AFB and incident energy basic equations to calculate AFB and incident energy at specified working distance for both steps 3 and 4; select the worst case of the two results	<ul style="list-style-type: none">• If doing manual calculations, this is the more tedious method• Method suggested for specific circuit break if time-current curve is available• Method suggested for a fuse that is not one where the simplified fuse equations are applicable

Looking at time current curves to get specific operating times – use SKM or EasyPower

Second Method -Equations for calculating incident energy

<p>Simplified Circuit Breaker Equations NFPA 70E Annex D D.4.7</p>	<ul style="list-style-type: none">• Equations based on testing and analysis• For generalized circuit breakers based on type, ampere rating, trip unit type, and maximum settings• Process:<ol style="list-style-type: none">1. Determine the available (bolted) fault current2. Verify that the available fault current does not exceed the circuit breaker's interrupting rating3. Verify using the IEEE 1584 simplified circuit breaker equations that the available fault current is high enough to generate an arcing fault current sufficient to cause circuit breaker instantaneous tripping or short-time delay tripping (if the circuit breaker has no instantaneous trip)4. From the IEEE 1584 simple circuit breaker method table, select and use the appropriate AFB and incident energy (at 18 inches working distance) simplified circuit breaker equations based on circuit breaker ampere rating, type, and trip unit type	<ul style="list-style-type: none">• Easier than the basic equation method• Generalized for all circuit breaker manufacturers – not manufacturer specific• No need to determine the arcing current• Requires qualifying calculations: available fault current must be within the range of use for circuit breaker settings and interrupting rating
--	--	--

Third Method - Incident energy table for fuses

- Based on IEEE testing of Bussmann series Low-Peak fuses

Bolted fault current (kA)	1-100 A		101-200 A		201-400 A		401-600 A		601-800 A		801-1200 A		1201-1600 A		1601-2000 A	
	IE	AFB	IE	AFB	IE	AFB	IE	AFB	IE	AFB	IE	AFB	IE	AFB	IE	AFB
1	2.39	29	>100	>120	>100	>120	>100	>120	>100	>120	>100	>120	>100	>120	>100	>120
2	0.25	6	5.20	49	>100	>120	>100	>120	>100	>120	>100	>120	>100	>120	>100	>120
3	0.25	6	0.93	16	>100	>120	>100	>120	>100	>120	>100	>120	>100	>120	>100	>120
4	0.25	6	0.25	6	20.60	>120	>100	>120	>100	>120	>100	>120	>100	>120	>100	>120
5	0.25	6	0.25	6	1.54	21	>100	>120	>100	>120	>100	>120	>100	>120	>100	>120
6	0.25	6	0.25	6	0.75	13	>100	>120	>100	>120	>100	>120	>100	>120	>100	>120
8	0.25	6	0.25	6	0.69	12	36.85	>120	>100	>120	>100	>120	>100	>120	>100	>120
10	0.25	6	0.25	6	0.63	12	12.82	90	75.44	>120	>100	>120	>100	>120	>100	>120
12	0.25	6	0.25	6	0.57	11	6.71	58	49.66	>120	>100	>120	>100	>120	>100	>120
14	0.25	6	0.25	6	0.51	10	0.60	11	23.87	>120	>100	>120	>100	>120	>100	>120
16	0.25	6	0.25	6	0.45	9	0.59	11	1.94	25	>100	>120	>100	>120	>100	>120
18	0.25	6	0.25	6	0.39	8	0.48	10	1.82	24	>100	>120	>100	>120	>100	>120
20	0.25	6	0.25	6	0.33	7	0.38	8	1.70	23	>100	>120	>100	>120	>100	>120
22	0.25	6	0.25	6	0.27	7	0.28	7	1.58	22	>100	>120	>100	>120	>100	>120
4	0.25	6	0.25	6	0.25	6	0.25	6	1.46	21	>100	>120	>100	>120	>100	>120



Arc flash PPE category method

- NFPA 70E Table 130.7(C)(15)(a)
 - Conditions of use must be satisfied
 - Still need to know available fault current
 - Overcurrent protective device opening time
 - Method to identify and estimate what PPE to use if you have to work on energized equipment

Arc flash PPE category method (continued)

- 130.7(C)(15)(a) for AC systems: conditions of use parameters in Table 130.7(C)(15)(a) for equipment type and voltage
 - Estimated available fault current equal or less than the parameter maximum available fault current value
 - Fault clearing time has to be equal or less than parameter maximum fault clearing time value
 - Working distance must not be less than parameter value

These Three Conditions have to be met in order to use this category method. IMPORTANT not to overlook this.

Arc flash PPE category method-Panelboard Example

Table 130.7(C)(15)(a): (for panelboards)

Equipment	Arc-Flash PPE Category	Arc-Flash Boundary
Panelboard or other equipment 240 V or less Parameters: (1) maximum 25 kA available fault current, (2) maximum of 0.03 sec (2 cycles) fault clearing time, (3) 18 inches min. working distance	1	19 inches
Panelboards or other equipment rated greater than 240 volts and up to 600 volts Parameters: (1) maximum of 25 kA available fault current, (2) maximum of 0.03 sec (2 cycles) fault clearing time, (3) 18 inches min. working distance	2	3 feet

Arc flash PPE category method (continued)

- Table 130.7(C)(15)(a) Note: For equipment rated 600 volts and below and protected by upstream current-limiting fuses or current-limiting circuit breakers sized at 200 amperes or less, the arc flash PPE category can be reduced by one number but not below arc flash PPE category 1.

So if I use Current Limitation and I am below 200 amps I can wear less PPE. So Current limiting devices can help reduce the hazard and that is recognized by this category method.

Arc flash PPE category method – How do we know the opening times

- Informational Note to Table 130.7(C)(15)(a): The following are typical fault clearing times of overcurrent protective devices:
 - (1) 0.5 cycle fault clearing time is typical for current limiting fuses when the fault current is within the current limiting range – ALLOWED TO USE this category Method
 - (2) 1.5 cycle fault clearing time is typical for molded case circuit breakers rated less than 1000 volts with an instantaneous integral trip. – ALLOWED TO USE this category Method.
 - (3) 3.0 cycle fault clearing time is typical for insulated case circuit breakers rated less than 1000 volts with an instantaneous integral trip or relay operated trip. (4) 5.0 cycle fault clearing time is typical for relay operated circuit breakers rated 1 kV to 35 kV when the relay operates in the instantaneous range (i.e., “no intentional delay”).
 - (5) 20 cycle fault clearing time is typical for low-voltage power and insulated case circuit breakers with a short time fault clearing delay for motor inrush.
 - (6) 30 cycle fault clearing time is typical for low-voltage power and insulated case circuit breakers with a short time fault clearing delay without instantaneous trip.

How do I Identifying MCCB to use the Category Method

Three Common Circuit Breaker Types

- Molded Case Circuit Breakers (MCCBs) 15 to 2500-A
 - Panelboards, switchboards, MCCs
- Insulated Case Circuit Breakers (ICCBs) 200 to 6000-A
 - Switchboards, MCCs
- Low Voltage Power Circuit Breakers (LVPCBs) 200 to 6000-A
 - Switchgear



Identifying Molded Case Circuit Breakers



MCCBs will have toggle handle

Panelboards only use MCCBs

From the informational note the typical fault clearing time is within the parameters of the table



ICCB and LVPCBs will have charging mechanism and push buttons to turn on or off.

May prevent using arc flash PPE category method due to opening time - have to do an in depth calculation using IEEE 1584

Arc Flash Category Method

Category method is a convenient way for someone to walk up to equipment and get the appropriate PPE and work near energized equipment. Even if its just to check for the essence of voltage when you are de-energizing the circuit, you still have to wear the appropriate PPE. This is a way to help identify when you can use that category method and when you can use the table and meet all three parameters. If your fault current is too high you can't use the category method, if your opening times are too long you cannot use the category method, or if you don't meet the working distance requirement. Then you have to go in the more detailed arc flash analysis (IEE1584).

Eaton can do in detail Arc Flash analysis. We can also do more in depth training on NFPA70E. Done through the Eaton Electrical Services Group.

Arc-flash mitigation: NEC Requirements

2017 NEC – Arc Energy Reduction

NEC Requirement

240.67 - Arc Energy Reduction. Where fuses rated 1200 A or higher are installed, 240.67(A) and (B) shall apply.

- A. Documentation. Documentation shall be available to those authorized to design, install, operate, or inspect the installation as to the location of the fuses.
- B. Method to Reduce Clearing Time. A fuse shall have a clearing time of 0.07 seconds or less at the available arcing current, or one of the following shall be provided:
 - (1) Differential relaying
 - (2) Energy-reducing maintenance switching with local status indicator
 - (3) Energy-reducing active arc flash mitigation system
 - (4) An approved equivalent means

Is arc reduction technology required?

- Not required for fuses rated below 1200A (e.g. A 1000A fuse in a 1200A switch does not have to comply)
- Not all fuses 1200A and above will have to have an arc energy reduction methods applied.
- ONLY fuse 1200A and above with a clearing time longer than 0.07 seconds at the arcing current
- Determining if arc energy reduction is required involves
 - Calculate the available fault current
 - Calculate the arcing current
 - Consult the fuse time-current curve

Available fault current

- The NEC does not identify the method needed to calculate available fault current
- Need an accurate value of utility fault current
- Methods that could be used
 - Bussmann Point-to-Point Method
 - Ohmic or per unit method
 - SKM, Easy Power, etc.
 - Tools/Apps such as Bussmann FC2
- Next find arcing current

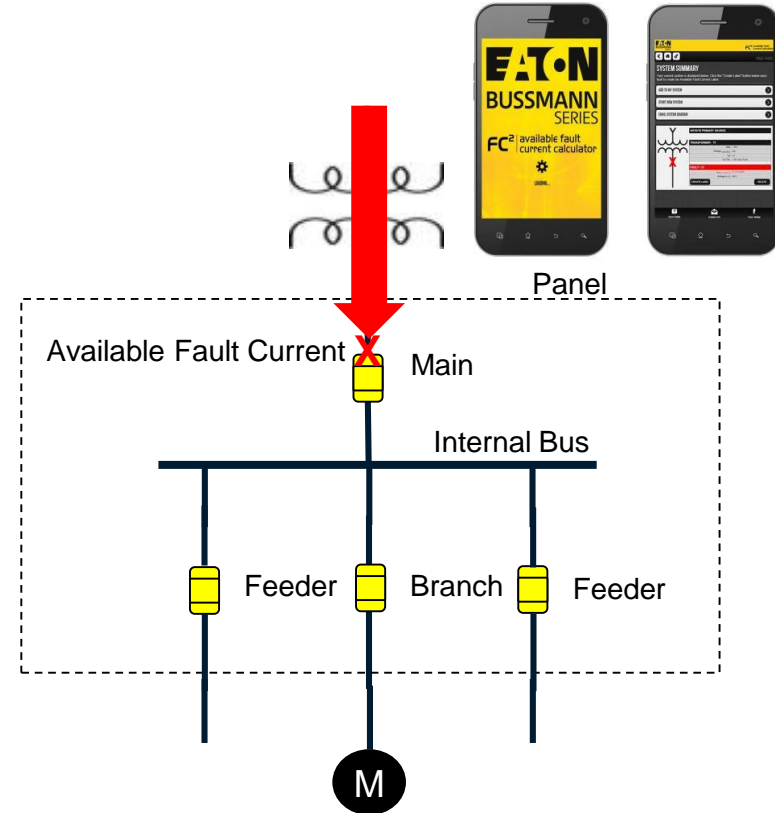

Arcing Current

- Based upon available fault current
- One method of estimating arcing current is by using IEEE 1584
- Latest edition is IEEE 1584-2018
- Arcing current calculation is significantly different (more complex and arcing current values) in 2018 edition
- IEEE 1584 is only applicable for fault current up to 106kA
- No method available above 106kA

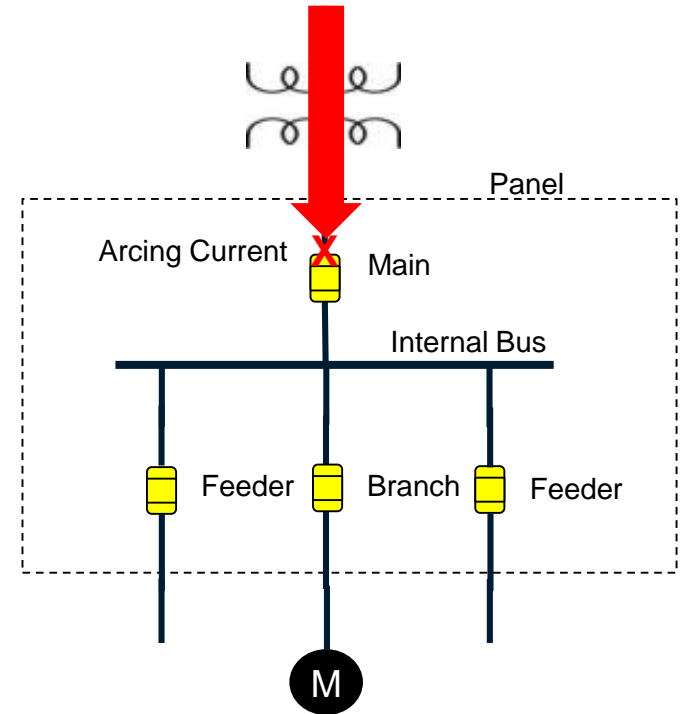

Resources and tools

- Bussmann series toolbox
- <https://toolbox.bussmann.com/>
 - Available fault current calculator (FC²)
 - Arcing Current Calculator
 - Arc Reduction Calculator
 - Many more!

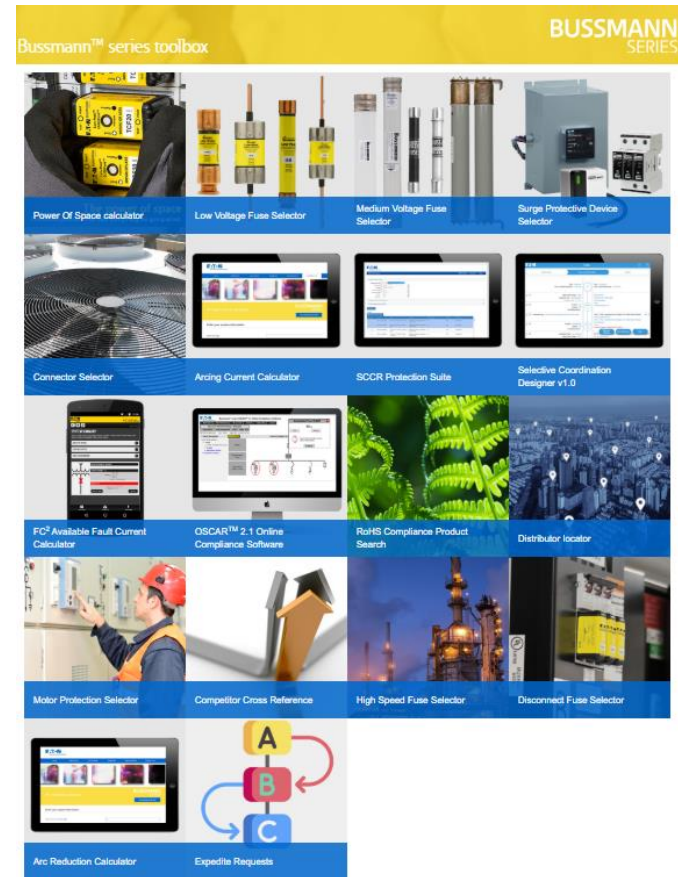

Arcing Currents of KTU fuse

Example: 600V, 1200A KTU fuse

Available Fault Current = 60 kA

Lowest Calculated Arcing current = 34.49 kA

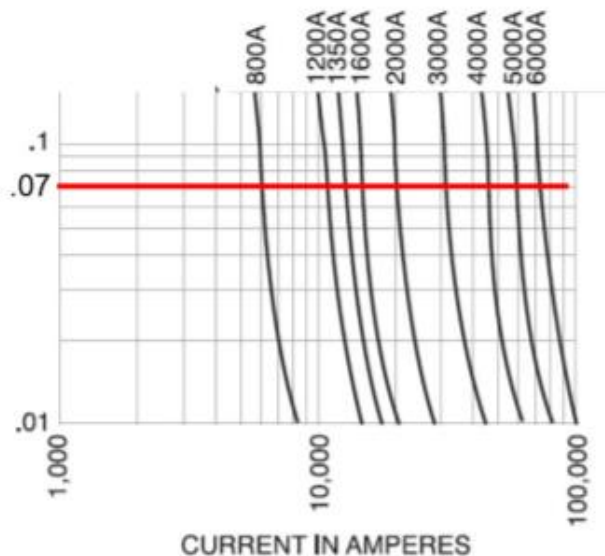

Fuse	Ampere rating (A)	Arcing current (kA)
KTU	1200	11.02
KTU	1400	13.54
KTU	1500	14.7
KTU	1600	15.7
KTU	1800	18.6
KTU	2000	21.23
KTU	2500	26.65
KTU	3000	32.58
KTU	3500	40.05
KTU	4000	51.08

Gap between electrodes (mm)	25
Electrical configuration	VCBB
Voltage (Vac)	480
Fault current (kA)	65
Fuse amperage rating (A)	2000
Results	
Max arcing current (kA)	40.52
Min arcing current (kA)	35.72
<u>Below listed are the available fuses on 2000A:</u>	
KRP-C-2000	PASS
KTU-2000	PASS

Arc-flash mitigation: Safety by design

Safety by design

NFPA 70E Article 110 Requirement

110.1(H)(3) Hierarchy of Risk Control Methods. The risk assessment procedure shall require that preventive and protective risk control methods be implemented in accordance with the following hierarchy:

- (1) Elimination
- (2) Substitution
- (3) Engineering controls
- (4) Awareness
- (5) Administrative controls
- (6) PPE

- System design should
 - Reduce the likelihood of exposure
 - Reduce the magnitude or severity of exposure
 - Enable achievement of an electrical safe work condition
- Applied at the source of possible injury – not affected by human error

Sound engineering design for safety can greatly reduce hazards – How can we do that by Current Limitation

Current limitation = arc energy reduction

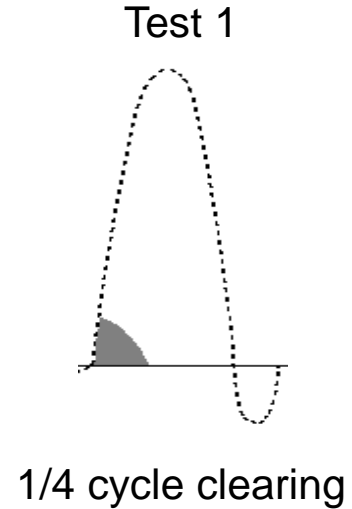
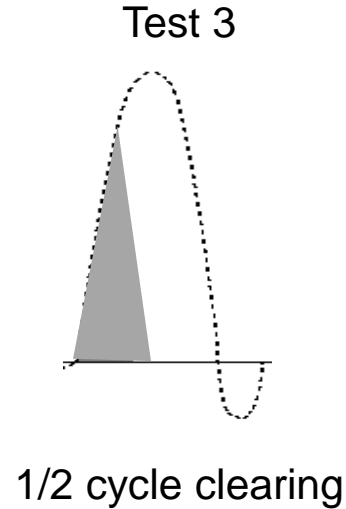
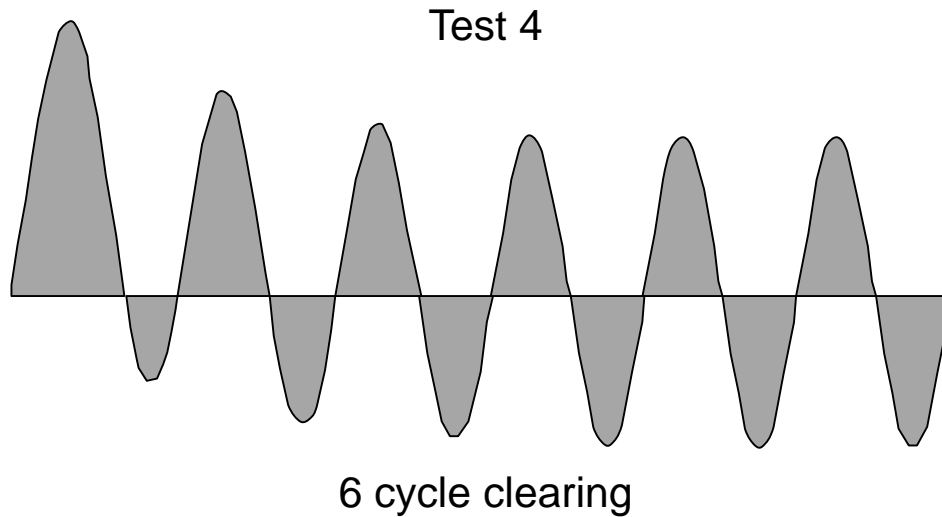

Current-limitation can significantly reduce arc energy

Upgrade to Busmann series Low-Peak fuses



Renewable

Upgrade
Customer to Low
Peak fuse – most
current limiting



Class H/K5



Class RK1
Dual element
time delay



Class RK1
Non-time delay



Class RK5
Time delay

Specify finger-safe fusible panelboards - QSCP

- UL 98 disconnect with CUBEFuse branch circuits
- Service branch fuses without opening trim
- Fuse rejection, interlock, and indication
- Door-in-door construction
- Class J is the most current limiting Fuse



Minimize shock hazards: Finger-safe solutions



Minimize shock hazards: Barriers

- Add barriers to prevent shock when replacing fuses
- New requirement for lineside barriers in service entrance equipment
- Deadfront barriers prevent access to live parts



Add local disconnects

- Increase likelihood that work will be performed in electrically safe state
- Ability to size current-limiting fuses close to the load and possibly reduce arc flash hazards
- UL 98 disconnects can be used as branch disconnect, motor controller disconnect or within sight motor disconnect



Arc-flash protecting OCPD

- Upstream OCPD in separate enclosure
- Incident energy levels at equipment to be serviced depend on upstream OCPD
- Utilize current-limiting OCPDs as the arc flash protecting device

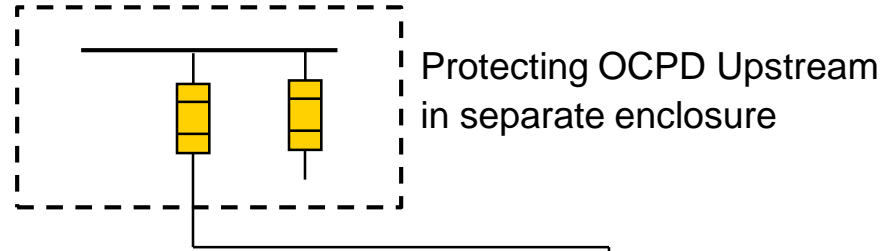

Downstream equipment
to be serviced



Arc-flash reduction maintenance switch

- ARMS utilize electronic trip units to reduce the opening time
- When enabled, ARMS places circuit into maintenance mode while work is performed
- This has to be the device that is upstream and not in the same equipment
- Eaton's Arc Energy Reduction System is the fastest offering for incident energy reduction with circuit breakers



Eaton Bussmann Arc Flash Relay (EAFR)



- Measures light & current to eliminate nuisance operation
- Seamless integration into new & existing equipment
- Choice of fiber optic loop or wired point sensors
- Monitors the equipment that is being worked on to reduce incident energy.
- Advantage is that it is always active. Does not have to be activated. Disadvantage is that you have to be in the zone of protection.

Arc-flash mitigation: maintenance considerations

NFPA 70E – condition of maintenance

70E Article 100 Definition

Maintenance, Condition of. The state of the electrical equipment considering the manufacturers' instructions, manufacturers' recommendations, and applicable industry codes, standards, and recommended practices.

70E 90.2 Scope

(A) Covered. This standard addresses electrical safety-related work practices, **safety-related maintenance requirements**, and other administrative controls for employee workplaces that are necessary for the practical **safeguarding of employees** relative to the hazards associated with electrical energy...

- Direct relationship between maintaining electrical equipment and safety
- Maintenance is not just an overhead cost – part of overall safety program



OCPD maintenance affects safety

Theoretical calculated values

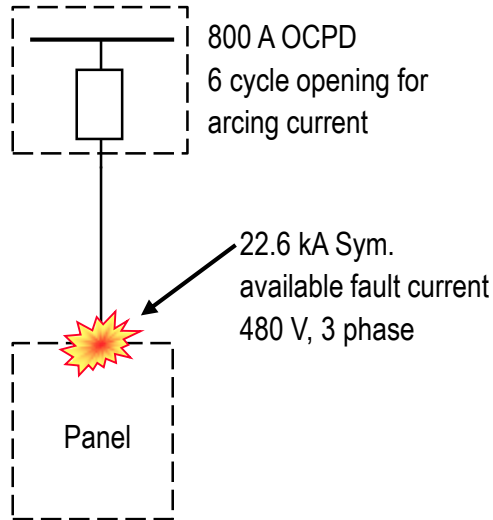

Initial calculated values:

- Incident energy: 5.8 cal/cm² @ 18"
- Arc flash boundary: 47"

Actual values due to poor maintenance

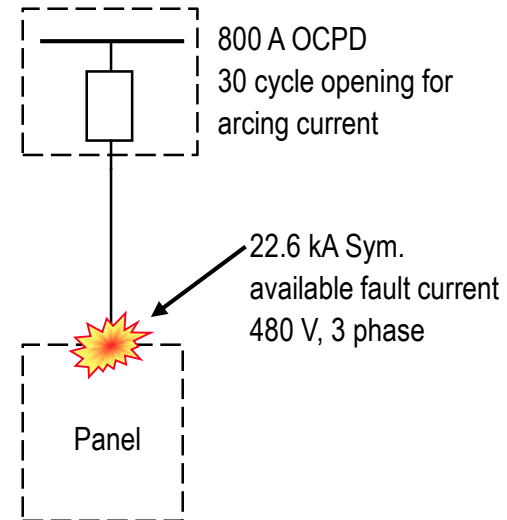

Actual calculated values:

- Incident energy: 29 cal/cm² @ 18"
- Arc flash boundary: 125"

Reducing electrical hazards

- Design phase
 - Use engineering controls and “Safety by Design”
 - Specify current-limiting OCPDs and touch-safe products
- Existing equipment
 - Do not work on energized
 - Maintain equipment, especially OCPDs
 - Replace non-current limiting OCPDs to current-limiting
 - Utilize Low-Peak fuses (most current limiting fuses)

EAT•N

BUSSMANN
SERIES