

AAI[®]

AMERICANATHLETIC.COM

65
YEARS IN
BUSINESS

"WE CARE FOR THE SPORT"



800.247.3978
ASKAAI@AMERICANATHLETIC.COM

OPEN HERE
FOR THE NEXT
EVOLUTION

SUPPLIERS & PARTNERS

AAI IS THE OFFICIAL EQUIPMENT SUPPLIER

Since 1972: USA National Championships
Women's Local, Regional, and J.O. Championships
Men's Local, Regional, and J.O. Championships
American Cup

Since 1974 American Cup

Since 1976 U.S. Olympic Trials

Since 1984 NCAA® Women's Championships

Since 1984 NCAA® Men's Championships

Since 1985 U.S. Olympic Sports Festivals

Since 2017 T&T, ACRO, & Rhythmic USA
Championships

2019 30th Summer University Games, Napoli, Italy
2017-2019 Ricky Deci Inv.-MEN
2017-2018 Alberta Provincial Championships
2017-2018 University of Calgary Invitational Cup
2016 PAC RIM Championships
2016 USA Championships for T&T, ACRO & Rhythmic
2015 Mexican National Championships
2015 Western Canadian Championships
2015 Canadian Summer Games
2015 University of Calgary International Cup
2015 Central American Gymnastics Championship
2015 Panama South American Club Championship
2014 Jr. Pan Am Tumbling & Trampoline
2014 Youth Olympic Games
2014 Western Canadian Championships
2014 World Artistic Gymnastics Championships
2014 Trampoline World Championships
2013/2014 Nat'l Gymnastic Championship of China
2013/2014 British Columbia Judges Cup
2013/2014 Salto Mardi Gras Invitational
2013 National Games of China
2012-2018 Saskatchewan Provincial Championships
2012-2017 Alberta Provincial Championships
2012/2013 Kyle Shewfelt Intl. Championships
2012/2013 World Acro Championships

2013 Chinese National Championships
2012 PAC RIM Championships
2012 Alberta Winter Games
2012 Indonesian National Games
2012 Senior Apparatus Pan American Championships
2012 Malaysian Games
2012 Mexican Gymnastics Open - Acapulco
2012 South American Junior Championship — Bolivia
2012 Pan American Clubs Cup — Bolivia
2011 Canadian Western Championships
2011 Alberta Invitational
2011 Indonesian National School Championships
2011 Wild Rose Invitational
2011 SEA Games
2011 Mexican National Championships
2010 Rhythmic World Cup — Montreal
2010 Malaysia Games
2010 Mexican National Championships
2010 Central American and Caribbean Games
2009 Mexican Junior Olympics
2009 National High School Games — Taiwan
2009 National University Games — Taiwan
2008 Olympic Trials
2008 Pacific Rim Championships
2008 Indonesian National Games
2007 Borneo Games
2007 World Cup — Women
2006 South American Games
2006 Pacific Alliance
2006 Borneo Regional Games
2005 South East Asian Games
2005 Pacific Alliance
2004 Pacific Alliance
2004 Malaysian Games
2004 Indonesian National Games
2003 World Gymnastic Championships
2003 World Championship Tour
2002 Brazilian Invitational
2002 European Gymnastic Championships

2002 Malaysian Games
2002 World Rhythmic Team Championships
2001 Asian Games
2000 Olympic Games (Vault Boards)
2000 Malaysian Games
2000 Olympic Tour
1999 2nd European Gymnastic Masters
1999 World Gymnastic Championships
1999 Rhythmic Four Continents
Championships
1998 Goodwill Games
1998 Commonwealth Games
1998 Asian Games
1998 Malaysian Games
1998 PAGU
1997 SEA Games
1997 Balkan Games
1996 Olympic Games
1996 PAGU
1996 Jr. Pan American Games
1996 Olympic Tour
1995 Goodwill Games
1995 British Commonwealth Games
1995 SEA Games
1995 South American Games
1995 Pan American Games
1993 Malaysian Games
1991 World Gymnastic Championships
1990 Pan American Games
1989 Jr. Pan American Games
1987 World Special Olympics
1987 Pan American Games
1985-1996 International Mixed Pairs
Championships
1985 Vidal Sassoon Olympic Tour
1984 Summer Olympics
1983 Pan American Games
1979 World Gymnastic Championships



Approved Supplier
and Partner



USA GYMNASTICS.

Official Supplier
and Partner



Official Equipment for
NCAA® Gymnastics
Championships



Official Equipment Supplier
to YMCA® National
Championships



Official Equipment
Supplier of
USAIGC



Proud Supporter of
the International
Gymnastics Hall of Fame
www.ighof.com



Official Equipment
Supplier to Federacion
Puertorriquena de
Gimnasia



Official Equipment
Supplier to Gimnasia
Argentina

TABLE OF CONTENTS

BASIC BENEFITS OF AAI® EQUIPMENT:

Standard 18oz. vinyl is CPSIA & Prop 65 approved and extremely durable

Powder-coat finish resists chipping, fading and regular wear found in average finishes

High quality durable steel or aluminum materials provide longevity to the products

Heavy-duty pistons provide added stability and performance

Quality polyethylene & polyurethane foams help produce superior results

Non-marking pads reduce the risk of floor damage

Partnerships with renowned companies to be your one-stop-shop

Sales team with only your best interest in mind

Athletes & coaches that support the brand

EQUIPMENT THAT YOU CAN TRUST!

American Athletic, Inc. ("AAI") has been manufacturing world-class sports equipment since 1954. Our commitment to providing high-quality, high-performance products has been unchanged for over 60 years. AAI began because of its innovation; however, the company is number one today because of its determination. AAI will continue to search out new solutions to keep equipment at peak performance.

EVO-BLACK™

03-09 | Evo-Black™ Apparatus

VAULT

10-11 | Competition Vault Tables
12-13 | Vault Boards & Trampolines
14 | Competition Vault Runway
15 | Competition Vault Training

BARS

16-17 | Competition Uneven Bars
18 | Competition Horizontal Bars
19 | Single Bar Trainers
20-21 | Competition Parallel Bars
22 | Rails/Bars

BEAMS

23-24 | Competition Balance Beams
25 | Balance Beam Training

POMMEL

26 | Competition Pommel Horses
27 | Pommel Accessories
28 | Pommel Training

RINGS

29-30 | Competition Rings

FLOOR EXERCISE

31-33 | Floor Exercise Systems
34-35 | Floor Exercise Decks
36 | Floor Exercise Carpets
37 | Floor Exercise CBF

TRAMPOLINE

38 | ELITE™ Tumbling Trampoline
39-42 | Eurotramp®

TRAINING PITS

43-44 | In-Ground Training Pits
45 | Pit Cubes & Covers

ACCESSORIES

46-48 | Accessories
49-50 | Apparatus Accessories

FREESTANDING ADAPTERS

51 | Freestanding Adapters

MATS

52-53 | Competition Landing Mats
54 | FIG Competition Landing Mats
55 | Training Mats/Skill Cushions
56 | Folding Mats
57 | AirTrack Mats

WALL PADDING

58 | Protective Wall Padding

MOTOR DEVELOPMENT

59 | Inclines
60 | Vinyl Shapes & Gaga
61-62 | Development Accessories

G2N™

63-66 | G2N™ Gymnastics Meets Ninja

ELITE™ KIDS GYM

67-69 | ELITE™ Kids Gym

CUSTOMIZE

70 | Customize Your Gym



Visit americanathletic.com/rental
to learn more about renting
equipment for your local meet!

AAI's branded semi-trailers will haul gymnastics, T&T, and cheer equipment across the United States! Look for the trucks out on the road and at upcoming national events!

EVO-BLACK™ COMPETITION LINE

EVO



EVO-BLACK™ VAULT TABLE

407-596 EVO-Black™ Artistic Vault Table

407-597 EVO-Black™ TAC/10 Vault Table

EVO



UNDER DEVELOPMENT

PERFORMANCE

Spring assist for training

DESIGN

Lock out mechanism for zero spring



CONVENIENCE

Quick and effortless adjustments



SOFT



MED



FIRM



FIG

ADJUSTABILITY

Four vault top settings by using one, two, three or disengaging springs!



STABILITY

Larger steel structure

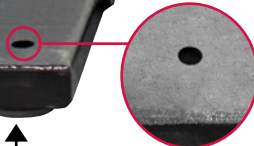

STABILITY

Top adjusting foot leveling system



CONVENIENCE

Flip top to access for spring adjustment



5 YEAR WARRANTY ON FRAME AND 1 YEAR ON PARTS AND PISTONS

americanathletic.com/evoblack

EVO-BLACK™ COMPETITION LINE



EVO-BLACK™ UNEVEN BARS

407-324 EVO-Black™ Uneven Bars E-Rails

Fixed front position to receive FIG approval.



DESIGN

Longer pistons provide additional heights for taller athletes

PERFORMANCE

E Rail is used for maximum performance



CONVENIENCE

Spin-locks lowered for easy accessibility

CONVENIENCE

Dual height markings allow for convenient visibility of adjustments

DESIGN

New E-Locks gives a stronger hold to the upright



ADJUSTABILITY

Single adjustment collar for simple width adjustment

STABILITY

Raised attachment point of spreader bar on low bar improves stability



ADJUSTABILITY

Better height visibility for FIG & Domestic settings

PERFORMANCE

Cables and swivel tie downs are designed to transfer any load sustained by the cables to floor plates

CONVENIENCE

Can be used with AAI®'s Freestanding system

5 YEAR WARRANTY ON FRAME AND 1 YEAR ON PARTS AND PISTONS

All measurements are from the floor to top of rail.
FIG Low Bar setting: 170cm
 Lowest setting 155cm and Highest setting 185cm.

FIG High Bar setting: 250cm
 Lowest setting 235cm and Highest setting 265cm.

Width measurement is taken in-side to in-side between both rails.
FIG Width 130cm-180cm.
 Shortest setting 130cm-Widest setting 195cm.
 Dual Width markings JO/AAI and FIG.

Example: JO/AAI 4.2 = FIG180cm

EVO-BLACK™ COMPETITION LINE

EVO



EVO-BLACK™ BALANCE BEAM

407-715 EVO-Black™ Balance Beam

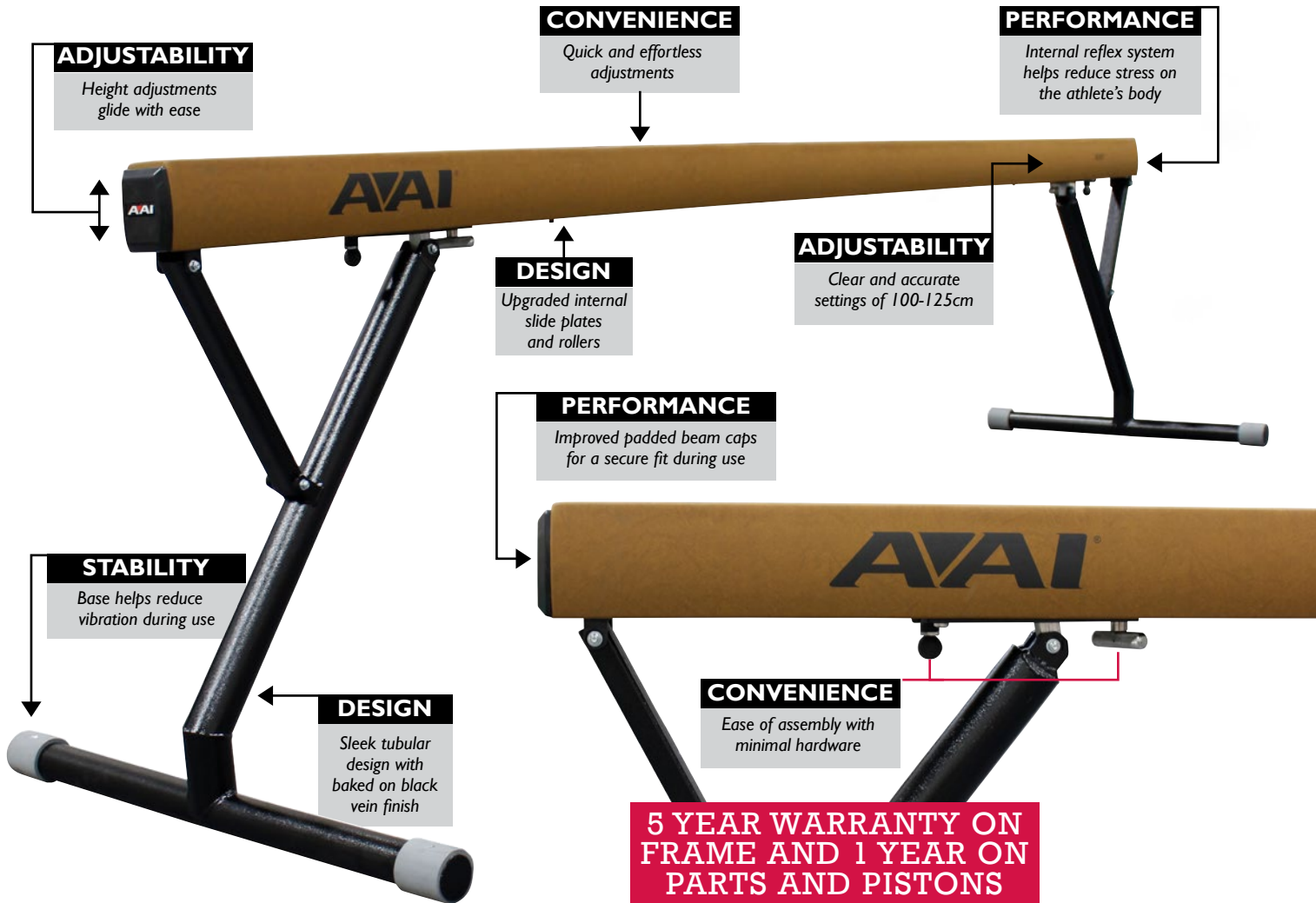

"I've trained and competed on AAI equipment so many times in my life, that I couldn't be happier to now be supporting the brand." – Laurie Hernandez



"Between the stability of the system and the ease of adjustment, the EVO-Black Balance Beam is definitely our beam of choice!" – Coach Jenny Liang

EVO-BLACK™ COMPETITION LINE



EVO-BLACK™ HIGH BAR

407-710 EVO-Black™ High Bar

EVO

DESIGN

Multi-directional collar provides maximum flex and performance

PERFORMANCE

AAI®'s exclusive high strength "Shot-peened Stainless"-steel bar is designed to eliminate residual stresses on the surface of the bar



PERFORMANCE

Stiffer wall uprights provide quick positive bar response

STABILITY

Increased wall thickness of uprights and 3/8" cable with double copper compression sleeves

CONVENIENCE

Ease of set-up

Final Dimensional Spec's all measurements are from the floor to the top on the bar.

FIG Height Setting: 280 cm. +/- 1 cm. AAI EVO Black adjustments in 5 cm. from 275cm.- 290 cm., in 5cm. increments.

Double Copper compression sleeves for additional safety, Along with 3/8" (9mm) cables for more stability during performance. Note when used with Free Standing Adapter 407-713, will add 5cm to heights.

ADJUSTABILITY

Easy twist and lock adjustments made at the base from 275-290cm

STABILITY

Sturdy 3/4" floor swivel anchors to ensure direct line connections

DESIGN

Modern design eliminates piston, moving all adjustment to the base

CONVENIENCE

Ease of height adjustment when it is needed

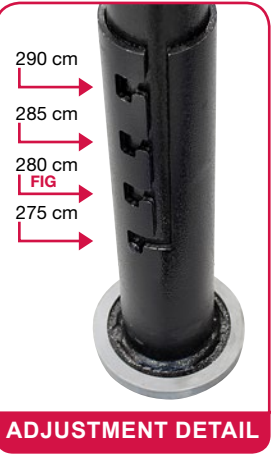

5 YEAR WARRANTY ON FRAME AND 1 YEAR ON PARTS AND PISTONS

EVO-BLACK™ COMPETITION LINE

EVO



EVO-BLACK™ PARALLEL BARS

407-708 EVO-Black™ Parallel Bars

ADJUSTABILITY

Width adjusts from 15"-26"

PERFORMANCE

Overall design reduces movement during single bar skills

DESIGN

Exclusive AAI's Graphite II Fiberglass-graphite rails

ADJUSTABILITY

Height adjusts from 165-225cm in 5 cm increments

DESIGN

Longer pistons provide additional heights for taller athletes

PERFORMANCE

New E-Locks gives a stronger hold to the upright

CONVENIENCE

Can be broken down in sections for ease of transport and set-up

STABILITY

Built in telescopic upright design provides added strength

STABILITY

Top adjusting foot leveling system

STABILITY

Larger structural steel base provides increased stability for bigger athletes and greater skills

DESIGN

Modular design base allows for compact shipping and/or storage

FIG measurements for height are from the floor to the top of the rail 200 cm. +/- 1 cm.

FIG width is 42cm.-52cm

AAI width is 15"(38cm) - 26"(65cm)

AAI height is 165cm - 225cm in 5cm increments

5 YEAR WARRANTY ON FRAME AND 1 YEAR ON PARTS AND PISTONS

EVO-BLACK™ COMPETITION LINE



EVO-BLACK™ POMMEL HORSE

407-750 EVO-Black™ Pommel Horse

EVO

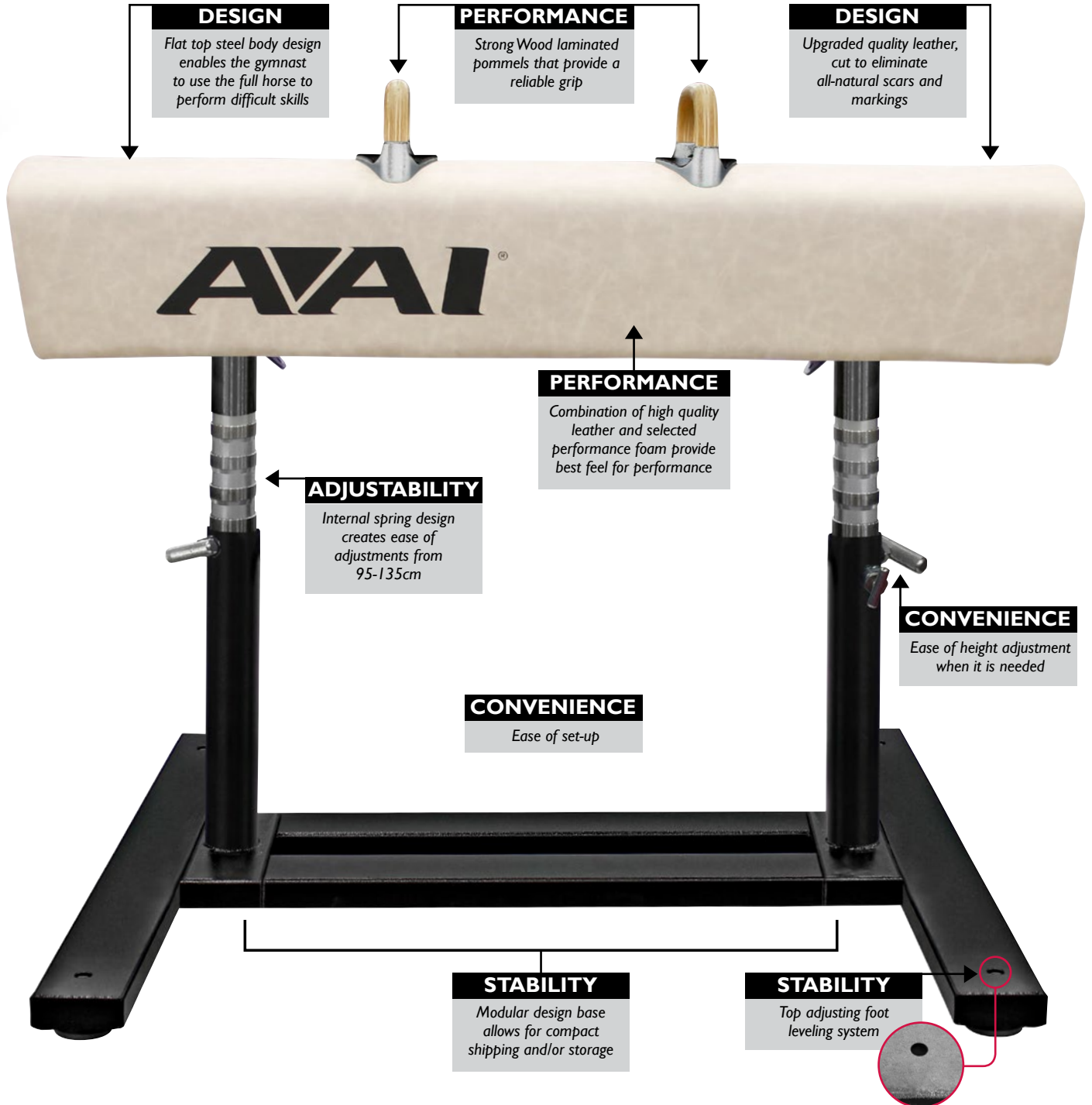

DESIGN

Flat top steel body design enables the gymnast to use the full horse to perform difficult skills

PERFORMANCE

Strong Wood laminated pommels that provide a reliable grip

DESIGN

Upgraded quality leather, cut to eliminate all-natural scars and markings

PERFORMANCE

Combination of high quality leather and selected performance foam provide best feel for performance

ADJUSTABILITY

Internal spring design creates ease of adjustments from 95-135cm

CONVENIENCE

Ease of height adjustment when it is needed

CONVENIENCE

Ease of set-up

STABILITY

Modular design base allows for compact shipping and/or storage

STABILITY

Top adjusting foot leveling system

5 YEAR WARRANTY ON FRAME AND 1 YEAR ON PARTS AND PISTONS

Final Dimensional Spec's all measurements are from the floor to top of horse.

FIG Height Setting: 115cm. +/- 1cm.

AAI EVO Black adjustments in 5cm. from 95cm.- 135 cm. from floor

Pommels Adj from 39cm-46 cm. FIG allows width from 40cm-45cm

EVO-BLACK™ COMPETITION LINE

EVO



EVO-BLACK™ RINGS

407-700 EVO-Black™ Adjustable Rings

407-698 EVO-Black™ Fixed Rings

PERFORMANCE

Reflex Spring-loaded swivel assembly to help reduce the impact on the gymnasts shoulders and back

PERFORMANCE

Heavy webbing straps have a leather insert to reduce wear on the rings for a secure grip

Attachment point for a spotting rig.

ADJUSTABILITY

Dual adjustments, at Reflex swivel, and at foot for fine adjustment

STABILITY

3/8" Cable system used for improved stability and performance

DESIGN

New tubular design for added strength

DESIGN

40% lighter frame allows for easy set-up

ADJUSTABILITY

Adjustment from 280-295 cm for taller gymnasts when needed

CONVENIENCE

Ease of set up and leveling

CONVENIENCE

Can be used with AAI®'s Freestanding System

5 YEAR WARRANTY ON FRAME AND 1 YEAR ON PARTS AND PISTONS

FIG at Fixed Setting: 280cm. +/- .5cm

measured from the floor to the top grip of the ring.

Adjustable Ring Tower Setting: 280cm-290cm.

STABILITY

Sturdy 3/4" floor swivel anchors to ensure direct line connections

COMPETITION VAULT TABLES

VAULT



ELITE™ ARTISTIC VAULT TABLE

This traditional Vault Table is used in competition and training to excel in vaulting skills.

- FIG Approved
- Meets USAG, NCAA® and AAU competition specifications
- Stable base with effortless height adjustments allows anyone in the gym to adjust
- Contoured vault head is layered with rebounding foam which helps minimize the impact on athletes hands, wrists and shoulders
- AAI's vault table has the broadest height adjustments, ranging from 37 1/2" to 53" (950-1350mm)
- Fitted Vault Base Pad included (see page 11)

407-556 ELITE™ Artistic Vault Table w/Fitted Pad - FIG Approved

407-562 ELITE™ Artistic Vault Table w/Club Pad

407-528 ELITE™ Artistic Vault Head Only

407-537 ELITE™ Artistic Vault Head Recovery Kit*

* Includes foam pad & sewn cover

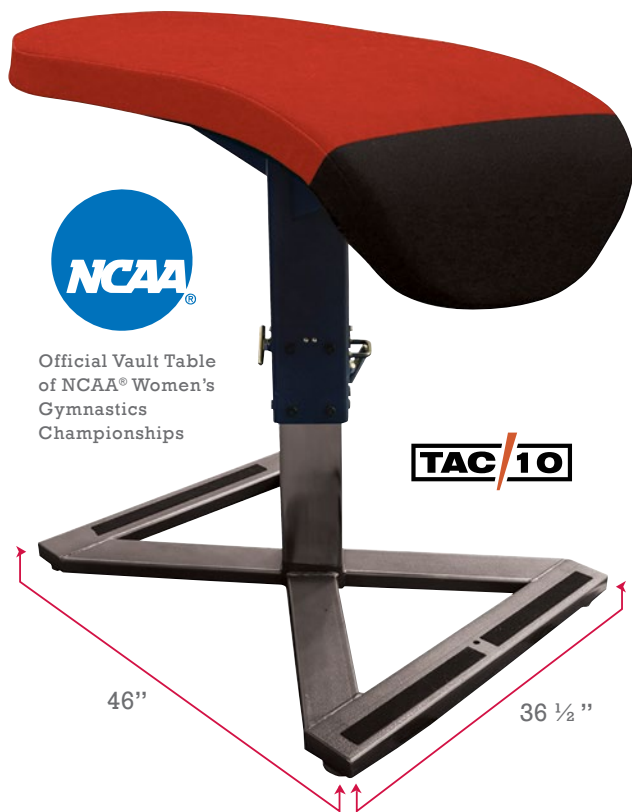

TAC/10 VAULT TABLE

The TAC/10 Vault Head exceeds the FIG allowable rebound by 40%, giving the athletes more height while doing vault skills.

- Official Vault Table of the NCAA® Women's & USAG J.O. Gymnastics Championships
- Meets USAG, NCAA® and AAU competition specifications
- AAI's vault table has the broadest height adjustments, ranging from 37 1/2" to 53" (950-1350mm)
- Contoured vault head is layered with a reactive foam which offers additional rebound
- AAI's exclusive TAC/10 cover provides incredible grip and can be easily cleaned with TAC/10 cleaner
- Club Pad included (see page 11)

407-557 TAC/10 Vault Table

407-543 TAC/10 Vault Head Only

407-553 TAC/10 Vault Head Recovery Kit*

*Includes foam pad and sewn cover

COMPETITION VAULT TABLES

VAULT

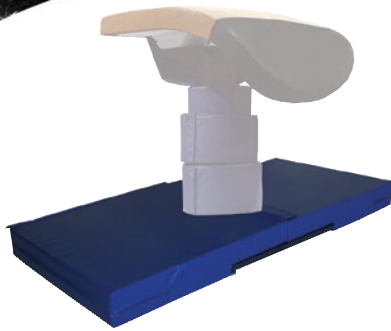

VAULT ANCHOR MAT

Two-piece formfitted system fits over the vault base, providing a 4' x 8' spotting surface.

- Securely adheres with hook and loop fasteners to avoid slipping away from the base and front flap
- Constructed with a high density foam and compliant vinyl
- Back of the mat has a 4" (10cm) flap with loop fasteners that can attach additional landing mats, anchoring the mats to the vault table

416-292 20cm Vault Anchor Mat - FIG Compliant

416-549 20cm Vault Anchor Mat

(larger center hole for easier adjustment)

416-547 12cm Vault Anchor Mat

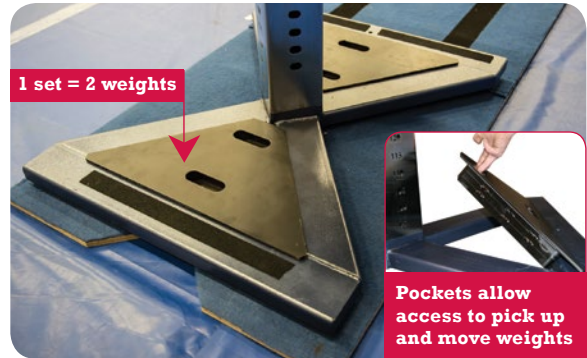

VAULT BASE WEIGHTS

AAI® weights fit securely in the Elite™ freestanding vault table base when anchoring the table is not an option.

- Weights help prevent the table from sliding on the floor, especially on polished concrete or wood floors
- Base weights fit inside the bottom of the table and don't hinder the safety of athletes
- Non-skid material on underside of the weights prevent scratching the vault base

407-568 Front & Back Vault Base Weight Set - 225 lbs.

407-569 Side Vault Base Weight Set - not shown - 260 lbs.

VAULT BASE PAD PACKAGES

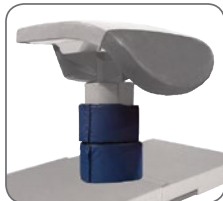

FITTED PAD

- Padding system consists of seven pieces to completely cover the vault base and help protect from injury
- Padding can be easily removed for storage or height adjustment
- Gusset pad covers back side of the base and is constructed of cross-linked polyethylene foam

416-127 Fitted Vault Base Pad Pkg.

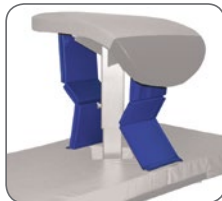

CLUB PAD

- Five piece padding set is designed for protection from the vault base
- Padding set attaches to the Vault Anchor Pads and Vault Head by hook and loop fasteners
- Set comes with front and back pads

407-558 Club Vault Base Pad Pkg.

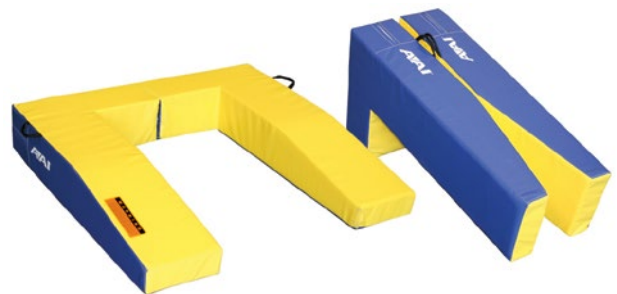

VAULT SAFETY ZONES

The contoured shape hugs Vault Boards to help keep gymnasts safe during round off entries.

- Meets USAG, NCAA®, NFHS and AAU competition specifications
- A must for safety on round-off entry vaults
- Safety zones are a versatile item that is used in the gym all day, by all levels
- High density foam and reinforcement materials add strength and durability while covered with a high quality compliant vinyl

407-206 Folding Vault Safety Zone
(4' x 4'; cut out 24 3/4" x 38")

407-238 Non-Folding Contoured Vault Safety Zone
(4' x 4' 8"; cut out 24 3/4" x 40")

407-204 20cm Non-Folding Vault Safety Zone, FIG recommended
(40 1/2" x 47 7/8"; cut out 24 3/4" x 40")

VAULT BOARDS



Updated rubber foot pads on Stratum® & TAC/10 Vault boards.



COACHES CHOICE

VAULT

STRATUM® VAULT BOARD

This premium popular vault board provides dynamic results.

- FIG Approved
- Meets USAG, NCAA®, NFHS and AAU competition specifications
- Number of springs can be adjusted to meet the needs of the gymnast's weight and ability
- Black oxide springs provide active rebound the gymnast need

- 407-228** Stratum® Adjustable 8-Coil Vault Board - Approved at all levels
- 407-257** Stratum® Soft Non-removable 5-Coil Vault Board (FIG) - Approved at all levels
- 407-259** Stratum® (6 Springs) Vault Board, Soft Version (FIG)
- 407-258** Stratum® (8 Springs) Vault Board, Hard Version (FIG)
- 407-235** Stratum® Vault Board Recovery Kit

TAC/10 VAULT BOARD

Similar to the Stratum® Vault board, but with a thicker, more reactive pad for improved performance.

- Meets USAG, NCAA®, NFHS and AAU competition specifications
- AAI's exclusive TAC/10 cover provides incredible traction and can be easily cleaned with TAC/10 cleaner

- 407-233** TAC/10 8-Coil Vault Board
- 407-207** TAC/10 Vault Board Recovery Kit



The TAC/10 Vault Board is the official Vault Board of the NCAA® Women's Gymnastics Championships.



EVO-SILVER™ SPRING BOARD

- Similar construction as spring Stratum® Vault Board
- Softer and less jarring feel allows for more repetition with anti-fatigue matting providing a unique softer feel on hands or feet

- 407-268** EVO-Silver™ - 8 Spring Vault Board
- 407-269** EVO-Silver™ - 9 Spring Vault Board



AAI® EVO-BOARDS

- Evo-Boards have a larger sweet spot allowing for variations in entry position
- These progressive boards are color coded to help determine which board your athlete will need
- Softer and less jarring feel allows for more repetition with anti-fatigue matting providing a unique softer feel on hands or feet
- Welded aluminum frame with handle for easy transport

- 407-262** EVO-Green™ - Soft
- 407-263** EVO-Yellow™ - Medium
- 407-264** EVO-Orange™ - Firm



Normal springs wear down due to metal fatigue caused during compression. Evo-boards use the next evolution in leaf springs to remain consistent and last longer.

*** APPROVED ***

USAG Women's JO Committee approved and accepted the use of AAI® EVO boards at all levels. May 14, 2018 - amendment to R&P page 63, H. 1

VAULT BOARDS & TRAMPOLINES

VAULT

407-595



407-599



JUNIOR COMPETITION VAULT BOARDS

Similar qualities of the Stratum® Vault Board, but made to accommodate developmental gymnasts.

- USAG levels 1 thru 5 approved
- Utilizes zinc-plated springs to meet the needs of the gymnast's weight and ability
- Constructed of either AAI's exclusive TAC/10 cover or gray carpet
- Recommended for use only up to 90 lbs.

407-595 TAC/10 Junior Competition Vault Board

407-599 Junior Competition Vault Board



VAULT BOARD SPRINGS

15316 Small Spring

15317 Large Spring



CUSTOM COLOR
OPTIONS AVAILABLE

MOUNT TRAINER

- Lightweight, dual density foam provides a stable take-off but will not compress
- Custom colors are available

416-030 Mount Trainer in Gray/Black
24" x 48" x 9" (61 x 122 x 23cm)

ROUND OFF PADS

- Meets FIG specification (excludes mini round off pad)
- USAG and NCAA® approved (416-094)
- Made of an anti-sting foam material to help cushion the wrist and shoulders while doing repetitive training
- 4" (10cm) hook fasteners on perimeter, along with a 2" (5cm) strip down the center to adhere to runway

416-094 Suede Round Off Pad 39.4" x 51.2" x 1 3/8" (1m x 1.3m x 3.6cm)

416-211 Suede Round Off Pad 36" x 51" x 1 3/8" (.91m x 1.3m x 3.6cm)

416-097 Mini Suede Round Off Pad 36" x 36" x 1 3/8" (.9m x .9m x 3.6cm)

416-098 TAC/10 Round Off Pad 39.4" x 51.2" x 1 3/8" (1m x 1.3m x 3.6cm)

416-212 Tac/10 Round Off Pad 36" x 51" x 1 3/8" (.91m x 1.3m x 3.6cm)

416-099 Mini TAC/10 Round Off Pad 36" x 36" x 1 3/8" (.9m x .9m x 3.6cm)

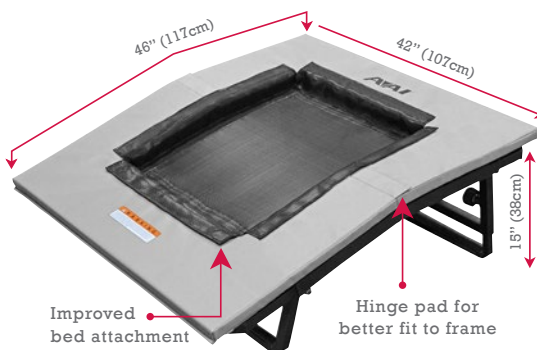

PREMIER VAULT TRAMPOLINE

- Adjustable rear legs to three different heights: 13", 14" and 15" (33cm, 36cm & 38cm)
- Front adjusts to lower the bed to sit on the floor
- Frame pads included

405-115 Premier Vault Trampoline

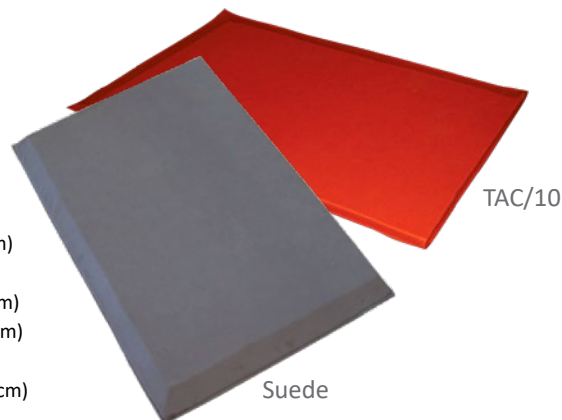

COMPETITION VAULT RUNWAY

VAULT RUNWAY

- Meets USAG, NCAA® and NFHS competition specifications
- Carpet is bonded to a layer of dense foam for performance and wear
- Available in 1 3/8" (35mm) thickness and 3' x 84' (.92m x 25m) in length
- Available in red or blue

B416-785 Vault Runway – 1 3/8" blue

R416-785 Vault Runway – 1 3/8" red

416-047 Runway Marker



Carpet bonded to a layer of dense foam

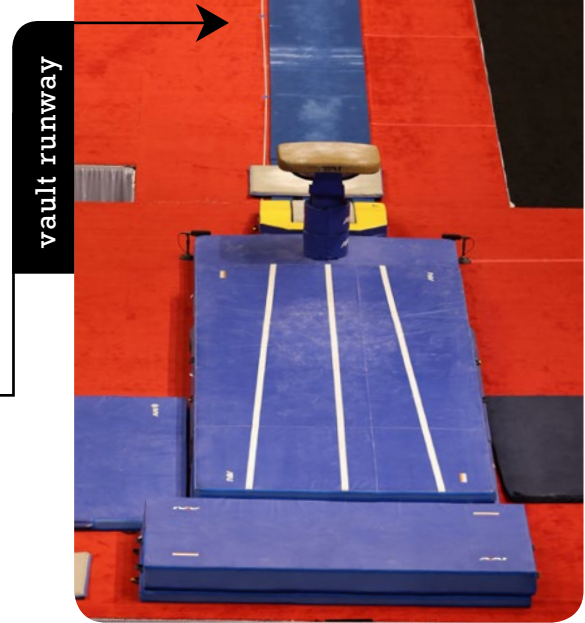
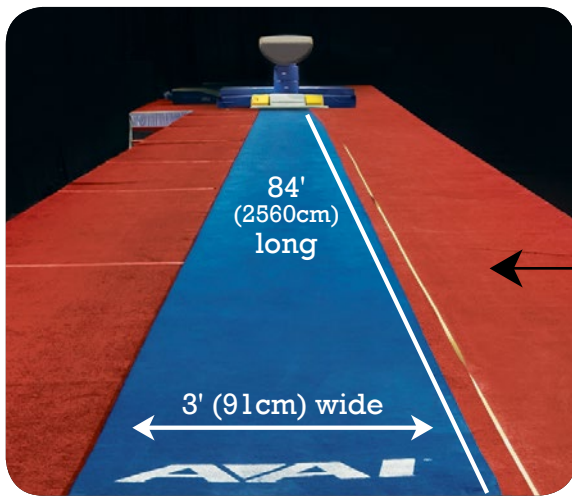

VAULT

FIG INTERNATIONAL VAULT RUNWAY SYSTEM

Provides the ultimate surface for vault approach.

- Meets FIG, USAG, NCAA® and NFHS competition specifications
- Runway is constructed of carpet, bonded to a layer of dense foam, then attached to a support board for use when anchoring vault base
- Runway is 39 3/8" x 82' 1/4" (1m x 25m)
- Runway guides are 10' 6" long (320cm)



(407-427)

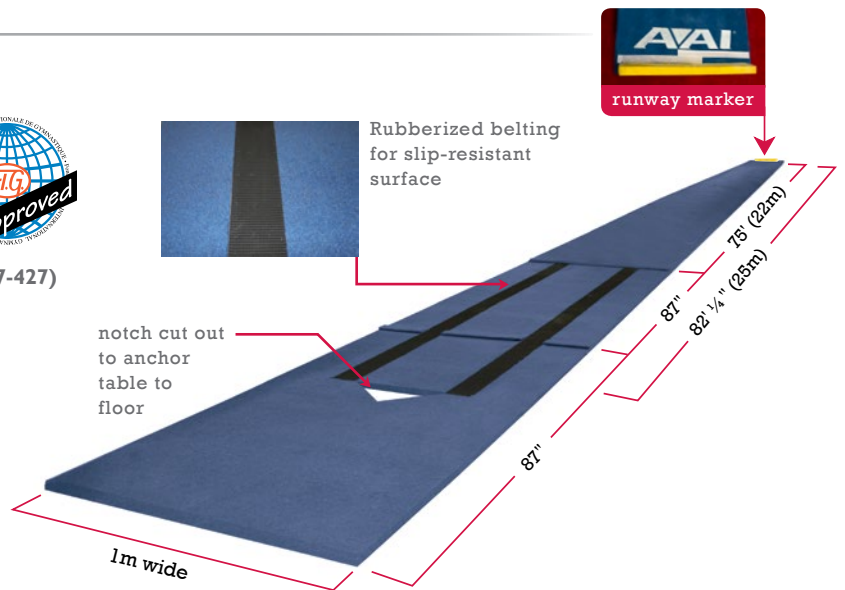

407-427 FIG International Vault Runway System – 1" (2.5cm)

407-429 Vault Runway Only – 1" thick

407-428 Vault Guides Only – 1" thick

416-047 Runway Marker (416-047 included in 407-427)

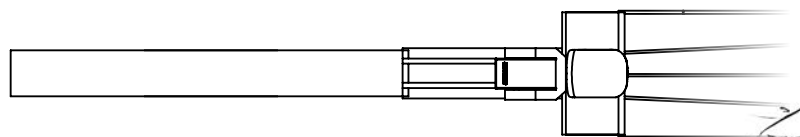

COMPETITION VAULT TRAINING

VAULT

VAULT TRAINER & MEN'S 10CM BLOCK

- Vault trainer has contoured and crowned surface to replicate a vault table
- Three-piece unit assembled is 50 5/8" h x 47 1/4" w x 37 3/8" l (1.3m x 1.2m x 95cm)

416-036 TAC/10 Vault Trainer (shown)

- Additional 10cm block meets men's regulation 54 9/16" height (135cm)

416-035 Men's 10cm Block

Detachable head for training advanced skills at a safer level

Middle section can be used as spotting block

50 5/8"

Shown in Women's Configuration

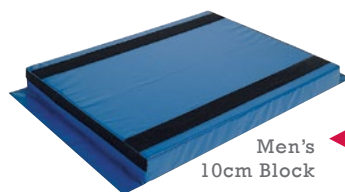

Use with Vault Trainer (416-034 or 416-036) for added height

PROGRESSIVE VAULT SYSTEMS

- Meets J.O. vault specifications
- Modular Pit Bases can be used individually, as spotting blocks or attached with hook and loop fasteners for use in Progressive Vault System
- Hand placement zone marked at 32" (81 cm) on top and side of system

416-440 Curved Vault Progressive System

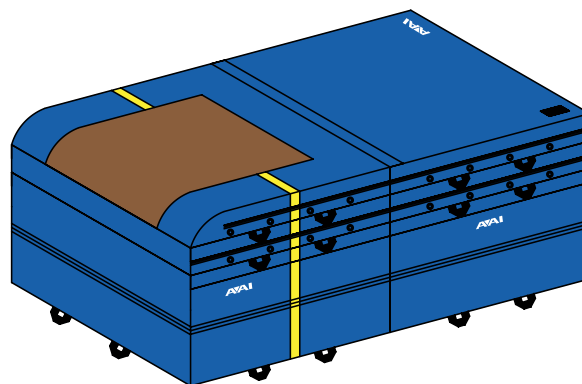

BUILD YOUR OWN PROGRESSIVE VAULT SYSTEM

When ordering a Progressive Vault System, please follow the procedure below to figure your system price.

1. Choose a minimum of 1 Base - 16", 24" or 32"
2. Choose a minimum of 1 Mat plus a Curved Top, or 2 Mats
3. Deduct 5% from the combined total of the item prices (must have at least 3 pieces for discount)

New Progressive Vault System

- 416-440** Progressive Vault System - Curved Vault System Complete
- 416-445** Progressive Vault System - 5' x 5' x 8" mat with curved top & line
- 416-443** Progressive Vault System - 5' x 5' x 8" mat with line
- 416-444** Progressive Vault System - 5' x 5' x 8" mat - no line
- 416-495** Progressive Vault System - 5' x 5' x 16" Progressive Vault base with line
- 416-496** Progressive Vault System - 5' x 5' x 16" Progressive Vault base - no line
- 416-493** Progressive Vault System - 5' x 5' x 24" Progressive Vault base with line
- 416-494** Progressive Vault System - 5' x 5' x 24" Progressive Vault base - no line
- 416-491** Progressive Vault System - 5' x 5' x 32" Progressive Vault base with line
- 416-492** Progressive Vault System - 5' x 5' x 32" Progressive Vault base - no line

Old Progressive Vault System

- 416-419** Progressive Vault System - 5' x 10' x 32" Modular Base
- 416-424** Progressive Vault System - 5' x 5' x 32" Modular Base
- 416-425** Progressive Vault System - 5' x 10' x 24" Modular Base
- 416-426** Progressive Vault System - 5' x 10' x 16" Modular Base
- 416-414** Progressive Vault System - 5' x 10' x 8" Top pad only
- 416-413** Complete Progressive Vault System - 32" full base w/2 8" mats
- 416-420** Complete Progressive Vault System - 32" split pit w/2 8" mats
- 538-631** Complete Progressive Vault System - 24" full pit w/3 8" mats

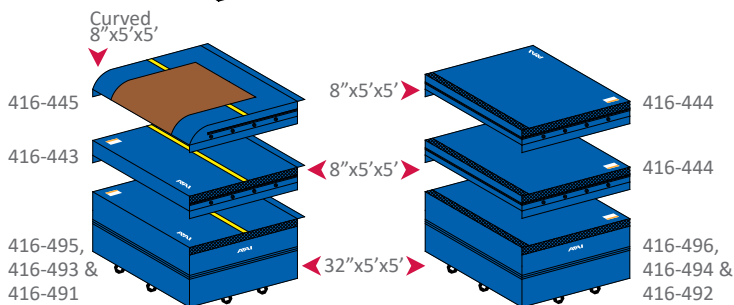

COMPETITION UNEVEN BARS

AAI features unique rod ends which allow for more flex and reduces the lengthy "break-in" period associated with other manufacturers' systems.



94 1/2" (240cm) center-to-center

Dual snap and spin lock systems provide optimum height accuracy and security.

Encased in a transparent heat sealed tube, AAI® Copper Compression Sleeves improve performance on our cabled apparatus.



Can be used with the Freestanding Uneven Bar Adapter on page 51 and/or SRS System on page 49



AAI includes four cable covers with all Uneven Bar Systems.

BARS

ELITE™ UNEVEN BARS

- 407-080** ELITE™ Uneven Bars w/Graphite X Rails - FIG Approved * aka AAI® International Uneven Bars
- 407-109** ELITE™ Uneven Bars w/Graphite E Rails - FIG Approved
- 416-369** Uneven Bars Protective Pads - not included

- Rod ends provide a more consistent performance with reduced wear on the rail collar
- Dual slide collars allow unit to exceed FIG bar-to-bar width specifications, adjusting from 95 to 192cm
- Low bar adjusts in height from 61" (155cm) to 73" (185cm)
- High bar adjust in height from 93" (235cm) to 104" (265cm)
- Graphite X bars provide the feel of wood with the strength and resiliency of fiberglass for maximum performance
- Heavy-duty pistons designed to provide added stability and performance
- Easy to adjust cabling system for enhanced stability
- Bases and spreader links finished in powder coated navy vein
- Can be used with the Freestanding Uneven Bar Adapter on page 51 and/or SRS System on page 49
- Includes four cable covers - as shown above
- Unit requires four floor anchors (not included - see page 50)

UNEVEN BARS	Part #	407-080 & 407-109	407-126 & 407-326	407-053 & 407-073
	Equipment	Elite™ Uneven Bars	International Asymmetric Bars	Constant Tension Bars (CTB)
	FIG Approved	(407-080)* & 407-109	(407-126) International Asymmetric Bars	N/A
	Meets Competition Specifications	FIG, USAG, NCAA & NFHS	FIG, USAG, NCAA & NFHS	FIG & NCAA
	Low Bar Adjustment	61" (155cm) to 72-7/8" (185cm)	61" (155cm) to 72-7/8" (185cm)	61" (155cm) to 72-7/8" (185cm)
	High Bar Adjustment	92-1/2" (235cm) to 104-1/4" (265cm)	92-1/2" (235cm) to 104-1/4" (265cm)	92-1/2" (235cm) to 104-1/4" (265cm)
	Bar Width Adjustment	95 to 192cm	90 to 200cm	95 to 192cm
	Footprint (measured from anchor points)	18' x 13' (5.5 x 4.9m)	18' x 13' (5.5 x 4.9m)	12' x 7' (3.7 x 2.1m)
	Rail Type	Graphite X & E	Graphite X & E	Graphite X & E
	# Floor Anchors	4	4	6
Freestanding Able	yes	yes	N/A	
Powder Coat	Uprights - Chrome Plated Bases - Navy Blue Metallic	Uprights - Chrome Plated Bases - Chrome Plated	Uprights - Chrome Plated Bases - Navy Blue Metallic	

COMPETITION UNEVEN BARS

BARRS



Slide collar allows unit to exceed FIG bar-to-bar width specifications, adjusting from 90cm to 200cm

Height markings on the piston makes adjustment of the system more convenient and accurate



(407-126)

INTERNATIONAL ASYMMETRIC BARS

The International Asymmetric Bars were designed to easily show height marking's for FIG compliant requirements during competition.

407-126 – International Asymmetric Bars with Graphite X Rails - FIG Approved

407-326 – International Asymmetric Bars with Graphite E Rails

- The International Asymmetric Bars are designed primarily for use in Elite level gymnastics programs
- Uprights are chrome plated, while the bases, spreader bar and collar are finished in powder coated navy vein
- Low bar adjusts in height from 61" (155cm) to 72 7/8" (185cm)
- High bar adjust in height from 92 1/2" (235cm) to 104 1/4" (265cm)

- Swiveling tie-downs are easy to install and designed to transfer any loads sustained by the cables to properly installed floor anchors
- Easy to adjust cabling system for quick modifications and enhanced stability
- Heavy-duty pistons designed to provide added stability and performance
- Can be used with the Freestanding Uneven Bar Adapter on page 51 and/or SRS System on page 49
- Unit requires four floor anchors (not included - page 50)
- Features Graphite X bars which provide the feel of wood with the strength and resiliency of fiberglass for maximum performance

CONSTANT TENSION BARS (CTB)

407-053 Constant Tension Bar with Graphite X Rail*

407-073 Constant Tension Bar with Graphite E Rail*

*Includes floor anchors & tie down system

407-057 Constant Tension Bar Conversion Kit
Conversion kit includes: new cables, tie downs, anchors, and four shorter spin locks to replace the spin locks used for height adjustment



Release one loadbinder and easily remove the low rail. The upper rail still remains stable and usable as a single bar, high bar, or strap bar.

64% reduction in floor space for set up

COMPETITION HORIZONTAL BAR

BARS

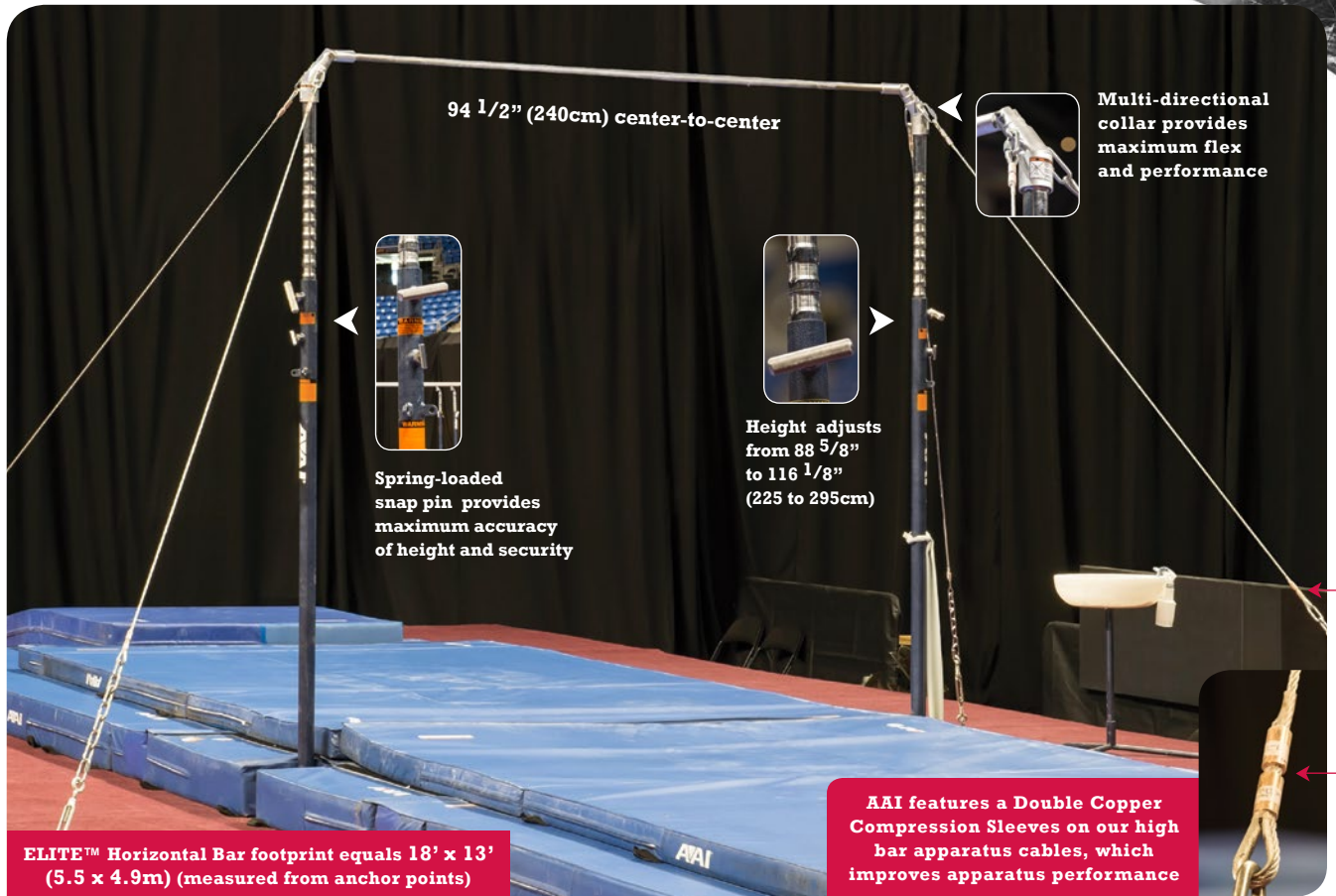

ELITE™ Horizontal Bar footprint equals 18' x 13' (5.5 x 4.9m) (measured from anchor points)

AAI features a Double Copper Compression Sleeves on our high bar apparatus cables, which improves apparatus performance

INTERNATIONAL ELITE™ HORIZONTAL BAR



Industry leading stainless steel Horizontal Bar is virtually indestructible, allowing the athlete to perform the most rigorous routines.

- FIG Approved
- Meets USAG, NCAA® and NFHS competition specifications
- This heat treated shot-peened stainless steel bar has passed over SIX MILLION CYCLES in a controlled destruct test and is magnafluxed to assure no surface cracks are present
- Four 1/4" (6mm) steel coated cables attach to three turnbuckles and one loadbinder turnbuckle
- Can be used with the Freestanding Horizontal Bar Adapter on page 51 and/or SRS System on page 49
- Requires four floor anchors (not included - see page 50)

407-489 International ELITE™ Horizontal Bar

416-368 Horizontal Bar Protective Pads *US Patent #6,475,118

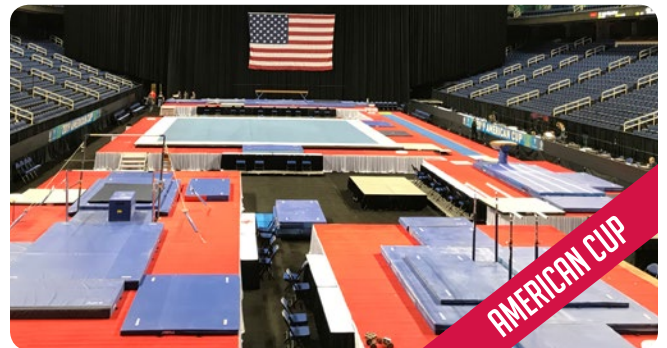

AAI's extremely high strength durable stainless steel bar is shot-peened to eliminate residual stresses on the surface of the bar increasing durability while providing the ultimate texture for a perfect grip*

recommendation

Based on data supplied by the FIG Safety Symposium, American Athletic, Inc. **STRONGLY RECOMMENDS** that horizontal bars and collars be replaced every three years to reduce the possibility of bar breakage. The newer moves being performed are applying greater impact loads and vibrations to the bar and its support structure.

SINGLE BAR TRAINERS

BARS

"It's been a battle for many years to obtain a piece of equipment to place over a training pit that would benefit both women's and men's gymnasts at and up to the elite level without taking up extra space and being able to withstand the G-forces endured by elite level athletes and skills. The AAI® Premier Single rail has done just that. We are 100% happy and satisfied with this piece of equipment that AAI® has produced!"

Travis Rainer
North Valley Gymnastics
Gym Manager & Men's Elite Team Head Coach

Footprint
12' 0" x 6' 0"

Footprint
10' 10" x 5' 0"

Footprint
18' 0" x 13' 0"

Footprint
9' 0" x 1' 2"

PREMIER SINGLE BAR TRAINER (SBT)

Best for training high level athletes doing high level skills

- Rail simulates the competitive top rail
- Great action for release moves
- Can easily transfer skills to uneven bars or horizontal bar
- Floor plates included for concrete floor installation

407-504 Premier Single Bar Trainer with Graphite E Rail

407-505 Premier Single Bar Trainer with Men's Rail

SHORT CABLE SINGLE BAR TRAINER (SBT)

- Formerly U-Base Single Bar Trainer
- Great for entry level skills (not recommended for elite level release moves)
- Floor plates included for concrete floor installation
- Maximum adjustability for over pit use
- Easy/Quick adjustment

407-509 Short Cable Single Bar Trainer with Graphite E Rail

407-507 Short Cable Single Bar Trainer with Men's Rail

Used for recreational programs *giants not recommended

TRADITIONAL SINGLE BAR TRAINER (SBT)

- Same foot pattern as Uneven Bar or High Bar
- Not made for Elite Level release moves
- Great for use over a pit or in open gym
- Includes one Graphite X bar, Safety Collars, Single Bar Trainer and Quick Release Conversion Kit — 20591 quick release pin not included
- Requires four floor anchors (not included - see page 50) — call AAI for information



20591

407-638 Traditional Single Bar Trainer with Men's Rail

407-625 Traditional Single Bar Trainer with Graphite E Rail

NON-CABLED SINGLE BAR TRAINER (SBT)

Designed for Beginner Skills or Recreation Programs *not recommend for training giants

- No cables provides more gym floor space
- Can be used with 6' or 8' rails
- Round bases are 13½" (34cm) in diameter with slotted holes giving additional clearance in case of imperfections to the concrete surface during installation
- Includes floor hardware

406-117 Non-Cabled Single Bar Trainer with Graphite E Rail

406-112 Non-Cabled Single Bar Trainer – Uprights only

406-113 Non-Cabled Single Bar Trainer – Bases, Bar Sleeves & Hardware

COMPETITION PARALLEL BARS

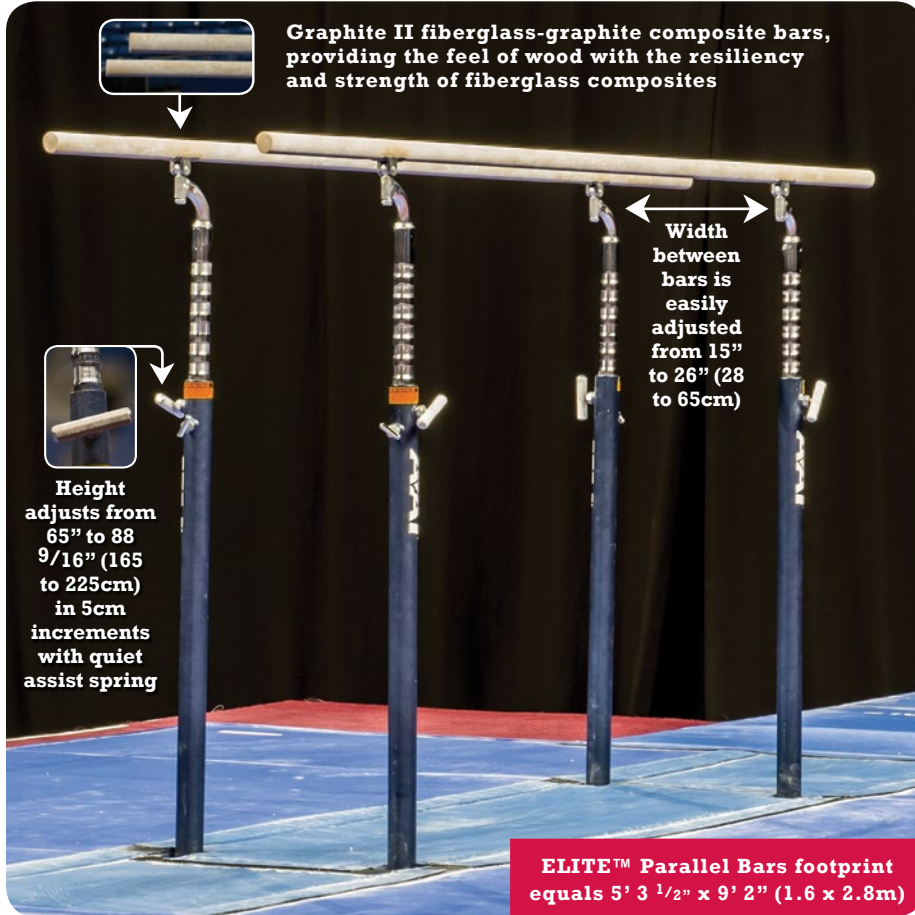

BARS

ELITE™ PARALLEL BARS

- FIG Approved – aka Elite™ AAI® Parallel Bars
- Meets USAG, NCAA® and NFHS competition specifications

407-590 ELITE™ AAI® Parallel Bars

416-365 Parallel Bars Upright Pads (not shown)

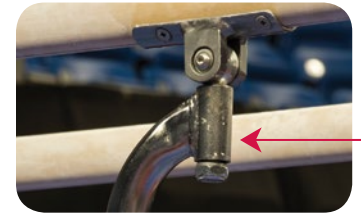

Connection mechanism allows for 360 degree swiveling, which eliminates rattling and unnecessary movement

THANKS ROSS
ATHLETIC SUPPLY, INC.

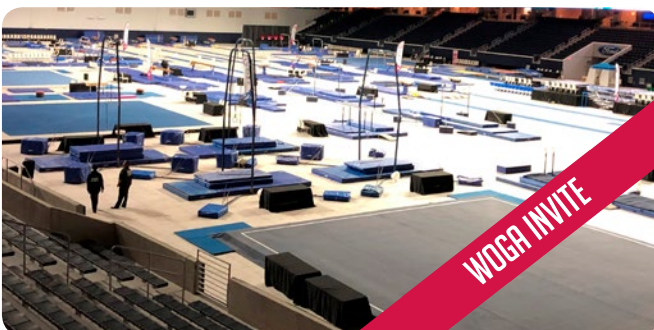

PARALLEL BARS

BARNS

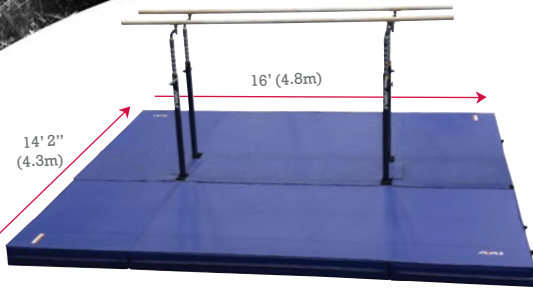

DOMESTIC PARALLEL BARS LANDING MAT CONFIGURATION

- Meets USAG, NCAA® and NFHS specifications for competition
- Duo-fold configuration eliminates seams when landing
- Works with either the 407-590 or the 406-400 Parallel Bars

416-561 Domestic Parallel Bars Landing Mat 14' 2" x 16' x 7 3/4" (4.3m x 4.8m x 20cm)

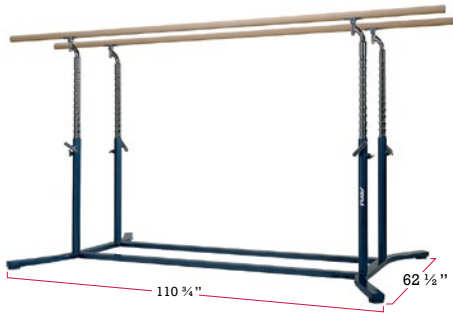

CLASSIC™ PARALLEL BARS

- Recommended for training purposes only
- Bars adjust in width from 15" to 26" (38 to 65cm)
- Graphite II Rail is 138" long (350cm)
- Height adjusts in 5cm increments from 47 1/4" to 76 3/4" (120 to 195cm)
- Apparatus Tie-Down Set included

406-400 CLASSIC™ Parallel Bars

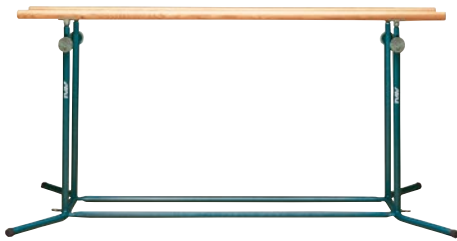

100 SERIES PARALLEL BARS

- Fiberglass composite bars are 1 9/16" (4cm) in diameter, 8' (2.4m) in length and adjust in width to 14", 16", and 18" (35, 40, and 45cm)
- Height adjusts from 45" to 77" (113 to 193cm)
- The height of the bars is adjusted using spin lock

405-116 100 Series Parallel Bars



LOW PARALLEL BARS

- Height from the floor is 16" (40cm)
- Fiberglass composite bars are 1 9/16" (4cm) in diameter, 8' (2.4m) in length and adjusts in width from 14" to 20" (35 to 50cm)

407-001 Low Parallel Bars



◀ Firm inner core for added stability

PARALLEL BAR BLOCKS

- High compression foam base with 2" (5cm) layer of cross-link polyethylene

480-067 Parallel Bar Blocks – sold as pair –
48" x 24" x 48" (122 x 61 x 122cm) (per block)



ESSENTIAL ELEMENTS PARALLEL BAR

- Made of soft, yet sturdy foam material & 18 oz vinyl
- 1-1/4"x2'x4' Mat with straps to attach to either 4'x6' or 4'x8 panel mats while folded
- Mat has removable parallel rail with hook and loop fasteners allowing for progressive training

405-035 Essential Elements Parallel Bar Folding mat - 2' x 4'

405-031 Essential Elements Parallel Bar Rail

RAILS/BARS

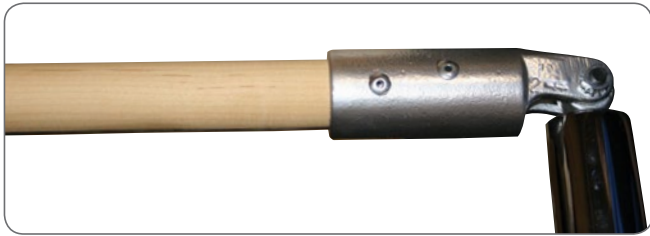

GRAPHITE X RAIL

- Meets FIG, USAG, NCAA® and NFHS competition specifications

407-152 Graphite X Rail with collars - Each

407-178 Graphite X Rail with collars & pistons - Each



GRAPHITE E RAIL

- Meets FIG, USAG, NCAA® and NFHS competition specifications
- Graphite E Rail is made with less Graphite strands making it 15-17% less rigid than our current Graphite X Rail

407-352 Graphite E Rail with collars - Each

407-179 Graphite E Rail with collars & pistons - Each

MEN'S STEEL BAR

- Meets FIG, USAG, NCAA® and NFHS competition specifications

407-490 Men's Stainless Steel Crossbar w/collars

407-491 Men's Stainless Steel Replacement Bar

539-656 Men's 6' Stainless Steel Bar - Each

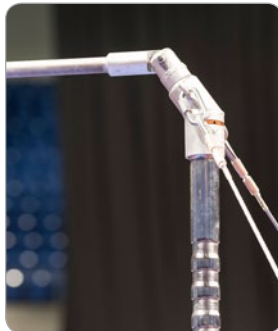

GRAPHITE II BAR

- Improved Grip
- Meets FIG, USAG, NCAA® and NFHS competition specifications
- Used on all AAI® ELITE™ and CLASSIC™ Parallel Bars
- Bar is 11' 6" (350cm) in length

407-502 Graphite II Bar – Each

407-506 Graphite II Bar – Pair

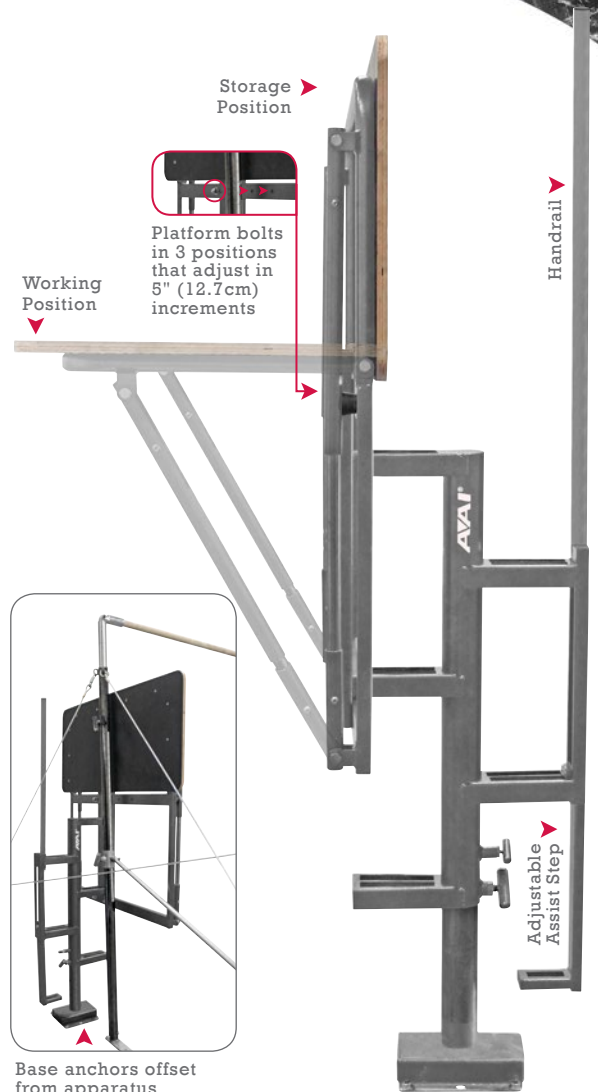

UNIVERSAL SPOTTING PLATFORM

- The platform can be used with SBT's, Uneven Bars, Horizontal Bar and Ring Tower
- Height of platform can be adjusted in height from 48" (122cm) to 72" (183cm) in 4" (10cm) increments
- Platform size: 24" length x 48" width (61 x 122cm)
- Access to the platform steps and handrail is eased with a retractable assist step
- When platform is not in use the self-retracting pistons slowly pull up the platform
- Platform includes 4 anchors so it is self-supporting, adding no extra weight or bind on the primary apparatus

407-690 Universal Spotting Platform

416-352 Universal Spotting Platform Pad – 4x6

BARS

BALANCE BEAMS

BEAM FEATURES

- Unique 1/2" (12.7mm) Air Channel Rubber pad provides better cushioning to absorb the impact for gymnasts from beginner through elite
- Powder coated navy vein finish resists chipping, fading, and regular wear and tear found in average finishes
- Padded end cap on competition beams additional protection
- Beam cover is more supple with less cracking on the corners and a better feel

BEAMS

COMPETITION

Part #	407-440	407-430	406-540	406-440
Equipment	ELITE™ RA Balance Beam	ELITE™ RNA Balance Beam	Adjustable Club Balance Beam	CLASSIC™ NRA Balance Beam
FIG Approved	aka International ELITE™ Balance Beam	N/A	N/A	N/A
Meets Competition Specifications	FIG, USAG, NCAA & NFHS	USAG, NCAA & NFHS	USAG, NCAA & NFHS	USAG, NCAA & NFHS
Height Adjustment	100, 110, 120, 125 cm	Fixed at 125cm	50-125cm	100-125cm
Shock Absorption	Urethane spring maintains energy absorbing properties through repeated impacts	Urethane spring maintains energy absorbing properties through repeated impacts	Shock absorption equal to ELITE™ beams	-
Weight	371 lbs (168kg)	362lbs (164kg)	417lbs (189kg)	310lbs (141kg)
Beam Leg Pads	416-325	416-325	416-540	416-330
Use	National & International Competitions	National & International Competitions	Regional & National Championships	Schools, Clubs & Training

RA = Reflex Adjusting RNA = Reflex Non-Adjusting



ELITE™ BALANCE BEAMS

- Reflex action from the beam's inner spring provides the athlete with the appropriate amount of shock absorption and rebound which returns the energy to the gymnast
- Height adjusts to 100, 110, 120 & 125cm

- **407-440** ELITE™ RA Balance Beam (FIG Approved)
- **407-430** ELITE™ RNA Balance Beam (not shown)
- **407-034** ELITE™ Balance Beam Recovery Kit (available through authorized AAI dealers)



CLASSIC™ NON-REFLEX BALANCE BEAM

- Quick set system easily changes to accommodate gymnasts various weights and ages
- Height adjusts to 100, 110, 120 & 125cm

406-425 Classic™ Non-Reflex Balance Beam

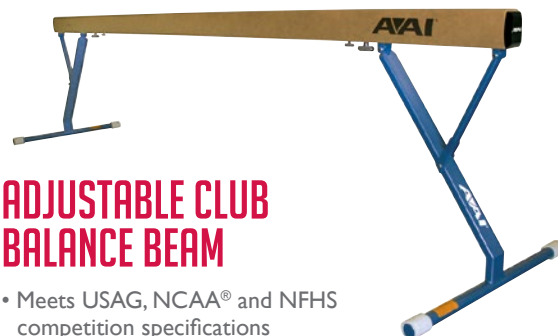

ADJUSTABLE CLUB BALANCE BEAM

- Meets USAG, NCAA® and NFHS competition specifications
- Accommodates FIG, USAG, NCAA® and NFHS mat specifications
- Easy, one-person adjustment between 50cm and 125cm heights to accommodate gymnasts various skill levels and ages
- Beam dimensions: 16' 5" long x 4" wide (5m x 10cm)

406-540 Adjustable Club Balance Beam

BALANCE BEAM TRAINING



COVERED ELITE BEAM CORE WITH END CAPS

- A competition ready beam top to replace your worn or damaged beam top
- Standard Elite Balance Beam Core without the internal hardware or beam legs

407-447 Covered Elite Beam Core with End Caps

BEAM CAP REPLACEMENT

- Updated assembly to use beam core to hold in place rather than glue and spring
- New cap design comes standard in AAI® Elite™, Classic™ and Evo-Black™ beams

49687 Beam Cap Replacement



BEAM LEG PADS AND FILLER SYSTEMS

Designed to cover the legs of the ELITE™ Balance Beams and the CLASSIC™ Balance Beams.

- Made of prime 70 ILD polyurethane and cross-link polyethylene
- Padding includes 18 oz. vinyl covers with hook and loop fasteners
- Connects base and landing mats together
- Available in 20, 18 or 12cm thickness

416-325 ELITE™ Beam Leg Pads — as shown

416-560 ELITE™ Beam Filler System - 20cm — as shown

416-315 ELITE™ Beam Filler System - 12cm

416-540 Adjustable Club Beam Leg Pads

416-330 CLASSIC™ Beam Leg Pads

416-380 CLASSIC™ Beam Filler System - 12cm

LOW BALANCE BEAM

Non-Reflex Training Balance Beam.

- Similar to Competition CLASSIC™ beam but without interchangeable reflex springs
- Quality low training beam for athletes of all levels
- Accommodates mats up to 20cm

406-090 Low Balance Beam



100 SERIES LOW BALANCE BEAM

This beam is perfect for teaching entry-level skills.

- Steel core covered with suede-like material
- Two round gray rubber foot pads on each leg to protect from skidding and floor damage

406-032 100 Series Low Balance Beam

BALANCE BEAM TRAINING

BEAMS

BALANCE BEAM TRAINING PAD

Necessary for learning and practicing new skills.

- Single pad is 72" (183cm) long x 20" (8cm) wide
- Foam filler is 1 1/4" (38mm) thick with 18 oz. red vinyl cover
- Snug fit with 6 1/2" (16.5cm) hook and loop fasteners
- Pad can be positioned anywhere on the beam (end, left, right) in order to provide cushioning where the athlete is performing

416-057 Balance Beam Training Pad



Balance Beam Training Pad

SUEDE PADDED BEAM MAT

Designed to cushion landings during beam training.

- Constructed of a material that is similar to AAI® Balance Beams
- A non-slip material on the underside to help keep the pad in place
- Includes hook and loop straps to help keep it in place and ensure a tight fit
- Uses 1/2" thick closed cell sponge
- Measures 15" (38cm) wide x 48" (122cm) long x 1/2" (13mm) thick

416-110 Suede Padded Beam Mat



non-slip material



BEAM TARGET BLOCKS

Providing a wider landing or take-off zone when training on the balance beam.

- Cover material is the same as our competition balance beam
- Constructed of a 3lb EPS with MDF wood top and bottom for strength
- High strength webbing holds the two halves together while ratchet straps secure it to the balance beam
- Narrow Blocks are 2" wide and 36" long, expanding the beam up to 9" wide while maintaining a flat working surface
- Wide Blocks are 4" wide and 36" long, expanding the beam up to 11" wide while maintaining a flat working surface

405-120 Beam Target Blocks – wide

405-121 Beam Target Blocks – narrow



Prep Mat's flexibility allows it to contour to equipment

PREP MAT

- Non-slip material on the bottom to help the pad in place
- 100% brushed polyester knit top material
- Uses 1/2" thick closed cell sponge to cushion landings when on equipment or on the floor

416-350 Prep Mat 54" x 36" x 1/2"

416-351 Prep Mat 27" x 36" x 1/2"

COMPETITION POMMEL HORSE

Chrome plated pistons are made of 2 3/8" (6cm) dia. heavy wall steel tubing with nine grooves, precision turned at 5cm intervals for height adjustments

International ELITE™ Pommel Horse footprint equals 4' 3 1/2" x 5' 6 1/2" (131 x 169cm)



INTERNATIONAL ELITE™ POMMEL HORSE

The flat top design enables the gymnast to use the full body of the horse to perform more difficult skills.

- FIG Approved – aka Elite™ International AAI® Pommel Horse
- Meets FIG, USAG, NCAA® and NFHS competition specifications
- Apparatus can accommodate freestanding or anchored configurations (Floor Anchors and Tie-Down System not included)
- Soft Leather

407-298 International ELITE™ Pommel Horse

POMMEL

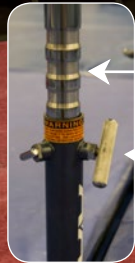

Dual locking spin and snap lock mechanisms



Steel shell is covered in a 2 piece 7/10" (1.8cm) thick polyethylene foam that is cut, shaped and fitted to the horse body then covered with a soft top-grade leather



Non-marking floor contacts, one with an adjustable leveling foot

Height adjusts from 37 1/2" to 53" (95 to 135cm) in 5cm increments with smooth action assist springs

SoCal Xcel State Meet



NorCal State Men



Long Beach Open Gymnastics



Olympica Gymnastics Academy



Peter Vidmar Invitational



THANKS
Poway Gymnastics



CLASSIC™ POMMEL HORSE

Adjustable apparatus made with the same craftsmanship as the ELITE™ Pommel

- Meets USAG, NCAA® and NFHS competition specifications
- Constructed with 7/10" (1.8cm) layer of dense foam and covered with a formfitting cover
- Height adjustable from 37 1/2" to 53" (95 to 135cm) in 5cm increments with smooth action assist springs
- Dual locking spin and snap lock mechanisms
- A Tie-Down System is recommended, since the base is lighter than the ELITE™ unit (422-068)

406-100 CLASSIC™ Pommel Horse

POMMEL ACCESSORIES

POMMEL



Pads come with firm foam inserts for additional support in landings.

DOMESTIC POMMEL HORSE COMPETITION MAT CONFIGURATION

- Meets USAG, NCAA® and NFHS competition specifications
- 416-160** Domestic Pommel Horse Competition Mat 12' x 13' x 4" (3.6m x 3.9m x 10cm)



TIE-DOWN SYSTEM

- Easily attaches to ELITE™ and CLASSIC™ Pommel Horse when added stability is required
- Requires one floor anchor (not included) — refer to page 50

422-068 Tie-Down System



POMMEL HORSE UPRIGHT PADS

- These pads guard against impact with the uprights during competition or training

416-372 Pommel Horse Upright Pads (blue)



POMMEL BUCK

- Complete system includes covered body, two pommels, two pistons, and a base
- Horse body is constructed using 14 gauge steel shell, covered with a 2-piece 18mm thick polyethylene foam cut, shaped and fitted to the body contour. The body is then wrapped with a high quality, durable material molded to assure smoothness while being securely staple stitched on the underside

406-300 Pommel Buck



FLAT TOP POMMELS

- Groove in the steel cast allows multiple settings for levels of competition
- Pommels have 2 3/4" (7cm) of adjustment in width

407-436 Flat Top Pommels - Pair

POMMEL TRAINING



TRAINING POD

- Designed for use in teaching pommel horse skills
- Official pommel training pod for level 4, 5 and 6 competition
- TAC/10 cover provides easy cleaning with excellent grip & durability
- Top is 25" (63.5cm) in diameter and 18" (45.7cm) in height
- Removable top is marked with an "X" for proper hand placement

407-670 Training Pod — TAC/10



406-304

FLOOR POMMEL BUCK

- Buck size pommel horse similar to 406-300 but low to the ground for safe and effective training
- Stable enough for all skills from beginner thru elite
- Ideal for endurance and strength training
- It's not "just like" a Pommel horse, it is a pommel horse

406-307 Floor Pommel Buck - no pommels

406-304 Floor Pommel Buck - 2 pommels

406-305 Floor Pommel Buck - 3 pommels

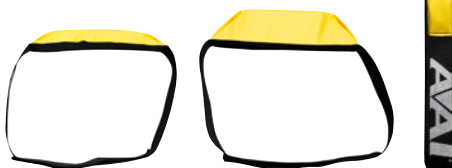

ESSENTIAL ELEMENTS POMMEL STRAPS

- Made of soft, yet sturdy foam material & 18oz vinyl
- Training Strap Pommels come with two each, 1-1/4" high, 3" high and 4-7/8" high to allow for progressive training
- Easily attaches to the pommel horse body with hook and loop fasteners
- Progressive training for younger athletes or good for training higher level skills without hitting the pommel
- Builds confidence by alleviating collision with the pommel
- Makes skill progression easier with gradual increase of the attachment heights: smallest to largest

405-032 Essential Elements Soft Pommel Straps - Set of 3 pair



COMPETITION RINGS

RINGS



Rings are attached to the framework with high performance shock absorbing spring-loaded swivels, plastic-coated cables and straps which reduce stress on the athlete



AAI® swivel enables the adjustment of the ring/cable height with the twist of the wrist

Straps are manufactured using 2" wide heavy nylon webbing with leather insert between ring and webbing, eliminating excessive wear

Eight 1/4" steel cables connect the frame to sturdy swivel anchor assemblies



INTERNATIONAL ELITE™ RING TOWER

Sturdy construction and wood rings provide excellent gripping surface, giving the athlete confidence through performance.

- FIG Approved; Meets USAG, NCAA® and NFHS competition specifications
- AAI's Ring Tower has the support and bounce that athletes need to perform at the highest level
- The Ring tower is sturdy with very little movement, which makes a difference when bigger more powerful athletes are swinging
- Spring-loaded swivel at the top of the tower help reduce the impact on athlete's shoulders and back
- Minimum floor to ceiling height required for the tower is 20' 3" (617cm) and the footprint equals 18' 0" x 13' 0" (5.5 x 4m)
- Can be used with the Freestanding Ring Adapter on page 51
- Requires four anchors (not included - see page 50)

407-378 International ELITE™ Ring Tower (adjustable)

407-478 International ELITE™ Ring Tower (non-adjustable height of 110 1/4" (280cm))

406-285 CLASSIC™ Single Ring Tower (non-adjustable height of 110 1/4" (280cm))

407-288 Fixed Strap — Wood — Spring-Loaded Adjustable Swivel Assembly - Pair (used on Ring Towers 407-378, 407-478, 406-285, 407-698, 407-700)

407-497 Fixed Strap — Wood — Adjustable Assembly - Pair (used on Ring Towers 407-378, 407-478, 406-285, 407-698, 407-700)

416-366 ELITE™ Ring Tower Protective Pads - not included

407-048 Alpha Rocker – see page 62 for more details



Alpha Rocker – see page 62 for more details

RINGS

RING ASSEMBLIES

- Fixed rings are set at 110 1/4" (280cm) height from floor
- Adjustable rings from 103 1/2" to 117" (258 to 292cm) height from floor
- Plastic-coated steel cables are permanently attached to swivels
- AAI features Copper Compression Sleeves on our apparatus cables, which improves apparatus performance
- Spring-loaded swivel is a fully machined assembly with encased bearings and spring to eliminate lock-up and ease shoulder strain
- Wood Rings are multi-laminated, hardwood rings that meet the FIG Specifications



407-408

407-479

407-783

NOTE: Ceiling and beam hardware not included. Specify beam size and distance from floor to ceiling attachment. Each pair of rings requires a pair of beam clamps (not included – see page 48).

407-479 Adjustable Reflex Ceiling Rings – Wood– Spring-Loaded Swivel

407-203 Adjustable Reflex Ceiling Rings – Polycarbonate – Spring-Loaded Swivel

407-202 Adjustable Ceiling Rings – Polycarbonate – Regular Swivel

407-783 Adjustable Ring Strap only – Each

Please contact your local dealer or AAI at 1-800-247-3978 for information on custom lengths.

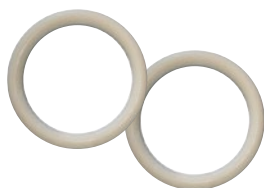

REPLACEMENT POLYCARBONATE RINGS

The Polycarbonate Ring is great for training purposes.

- One-piece seamless construction
- Composite material is textured and pre-chalked for use
- Recommended for non-competitive programs and recreational use only

407-296 Polycarbonate Rings — Pair (Straps not included)

REPLACEMENT WOOD RINGS

AAI® Wood Rings provide durability and strength that athletes need.

- Meets FIG, USAG, NCAA® and NFHS competition specifications
- Multi-laminated beech hardwood veneer construction
- Tested and approved with double weight requirements established by FIG

407-496 Wood Rings — Pair (Straps not included)

407-408 Adjustable Ring Strap with Wood Ring (1 strap and 1 ring)— Each

recommendation

American Athletic, Inc. STRONGLY RECOMMENDS that the RINGS be replaced every three years to reduce the possibility of ring breakage. The newer moves being performed are applying greater impact loads the ring and its support structure.

ESSENTIAL ELEMENTS RING

- Ring Strap easily hung from any rail
- Allows for younger athletes to train ring skills

407-030 Essential Elements Ring



407-783



RING TRAINER

- Easy Set up with Adjustable belts (based off size)
- The Ring Trainer eliminates about 50% of your body weight to allow you to train multiple skills and work on that proper technique for each one.
- Great tool for improving your upper body strength while having fun doing it
- Train Progressions from Pull Ups to the Iron Cross with the Ring trainer

405-296 Ring Trainer Small

405-297 Ring Trainer Medium

405-298 Ring Trainer Large

COMPETITION FLOOR EXERCISE SYSTEMS

FLOOR

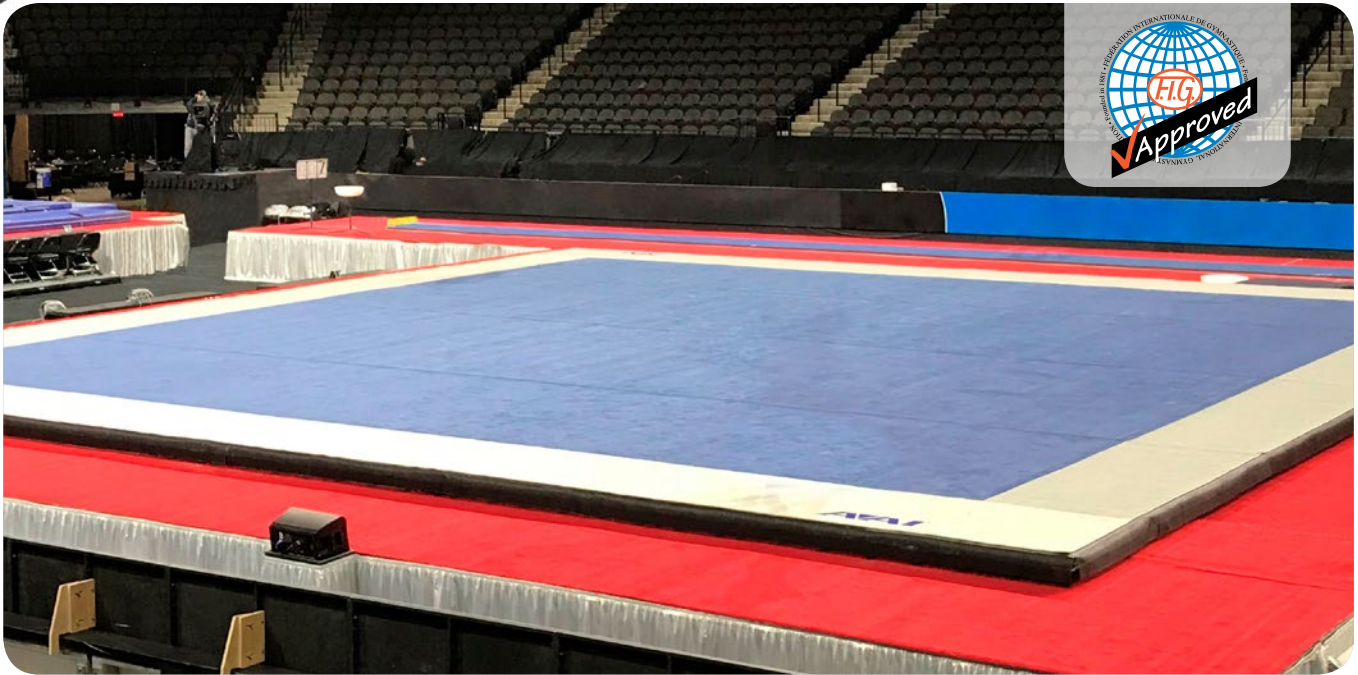

INTERNATIONAL SSC ARTISTIC FLOOR EXERCISE SYSTEM

This complete system is used by world-class athletes to reach their maximum performance.

- FIG Approved
- Meets USAG, NCAA, NFH and Acro competition specifications
- Utilizes our new Stratum® Secure Connect Spring Deck
- This complete system with full deck provides a more even feel without the sloped foam border
- Includes: 432-424 Carpet & Accessories, 432-488 Foam Package, and 432-492 SSC Spring Deck

432-491 International SSC Artistic Floor Exercise System
– 46' square (14m) square

FLOOR LAYOUT DIAGRAM

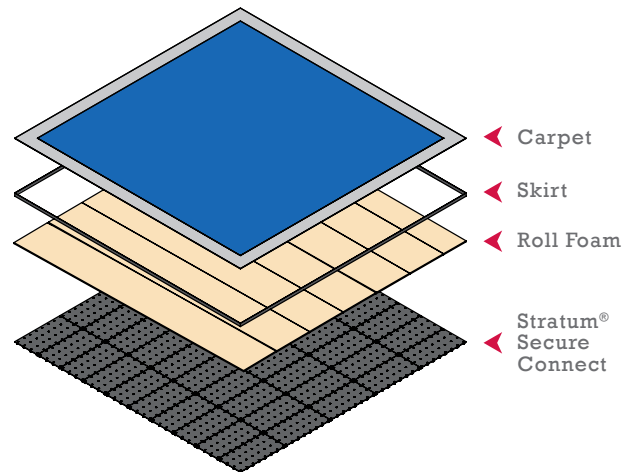

SETTING UP FLOOR EQUIPMENT PROPERLY

When setting up your Floor Exercise Systems including the blue carpet and white border tape, the actual performance dimension is 39' 4 1/2" or 12M with a variance of 3cm +/- when measured by the outside of the tape. The tape is considered part of the performance area. When laying your border please ensure you are including the tape within the measurement and you are measuring to the outside of the tape.

Below is information by the FIG on the measurements of the Floor Exercise to be in FIG compliance:

PERFORMANCE AREA: 1200cm x 1200cm, Tolerance +/- 3cm
DIAGONALS OF THE PERFORMANCE AREA: 1697cm +/- 5cm
Border 100cm, min.

BORDER AS A VARIANT

Horizontal Area, Width 50cm, min.
Slope max. 25 %, Width 50cm, min.
Height of outer border at the very end 3.5cm, max.

WHEN THERE IS A DELIMITATION STRIPE BETWEEN THE PERFORMANCE AREA AND THE BORDER :

Delimitation strip width 5cm, Tolerance +/- 0.5cm

The delimitation strip is part of the Performance area.

COMPETITION FLOOR EXERCISE SYSTEMS

ARTISTIC FLOOR EXERCISE SYSTEMS

All AAI® floors are handmade to ensure the finest craftsmanship and quality. Complete Floor Exercise System includes carpet, spring deck, foam and border.

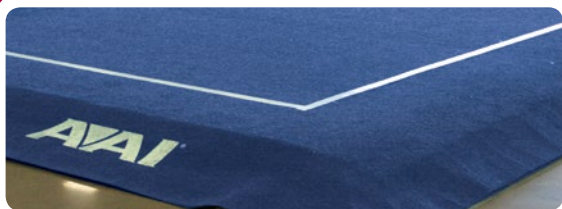

AMERICAN SSC ARTISTIC FLOOR EXERCISE SYSTEM

Coaches and athletes alike prefer this system for its ease-of-use and assembly.

- Meets USAG, NCAA® and NFHS competition specifications
- Our most economically priced floor
- Floor system consists of: 50 spring-loaded fiberglass reinforced wood floor panels, sloped foam border of 4 ¾" (12cm) high and 23 ¾" (60cm) wide to surround the deck, 7 rolls of 2" cross-link polyethylene roll foam and a 45' (13.7m) square blue working surface with 2" white tape to locate the performing surface
- Includes 432-340 Spring Deck, 416-750 Foam, 432-891 Border, and 432-504 Blue Carpet with White Tape Boundary and 13 Floor Straps

432-480 American SSC Artistic Floor Exercise System
45' (13.7m) square (40' square deck)



ALL-AMERICAN SSC ARTISTIC FLOOR EXERCISE SYSTEM

From the training gym to the collegiate competition, this system is the perfect fit for athletes of all levels.

- Meets USAG, NCAA® and NFHS competition specifications
- Floor system consists of: 50 spring-loaded fiberglass reinforced wood floor panels, sloped foam border that is 4 ¾" (12cm) high and 23 ¾" (60cm) wide to surround the deck, 7 rolls of 2" (5cm) cross-link polyethylene roll foam and a 39' 4 ½" (12m) square blue working surface with a 3' (92cm) gray carpet border on all four sides
- Includes 432-340 Spring Deck, 416-750 Foam, 432-891 Border, 432-509 blue carpet with gray carpet border and 13 Floor Straps

432-485 All American SSC Artistic Floor Exercise System
45' 4 ½" (13.8m) square (40' square deck)



DGS Little Boston



DGS Level 56 Reg



DGS Special Olympics



DGS level 52



DGS ECAC



DGS Beauty and Beast



DGS TW Battlefield Meet



DGS Dream Big

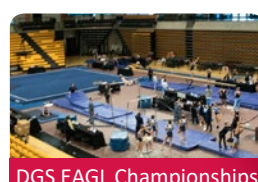

DGS EAGL Championships

CBF CORNER BORDER SYSTEM

Includes a set of (4) 4'x6' (1.2x1.8m) CBF Flex mats, (4) 4'x10' (1.2x3m) CBF Flex mats, with 4" (10cm) hook fasteners to attach these mats together in the corners, as well as strips of 2" (5cm) hook fasteners to attach to the mats and around a spring on the floor to hold them in place.

416-736 Carpet Bonded Foam Corner Border System

* Both AAI® corner mat systems are compliant with the Women's JO and the NCAA® rules.



COMPETITION FLOOR EXERCISE SYSTEMS



INTERNATIONAL ELITE™ RHYTHMIC FLOOR SYSTEM

Designed for the beauty and grace of the rhythmic athlete.

- FIG Approved – aka International Elite™ Rhythmic Floor System
- Meets FIG and USAG competition specifications
- Floor system consists of 61 floor panels with foam block supports, 16 ½” (42cm) sloped foam border to surround the deck, then covered with a tan velour carpet to create a finished area of 48’ (14.6m) square with red tape to locate the performing surface
- Includes 432-378 Rhythmic Reflex Floor; 432-375 Rhythmic Foam Border, and 432-278 Rhythmic Carpet

432-379 International ELITE™ Rhythmic Floor System 48’ (14.6m) square

432-279 Domestic Rhythmic Carpet 48’ Square

For acro floor see International SSC Artistic Floor Exercise System on page 31.

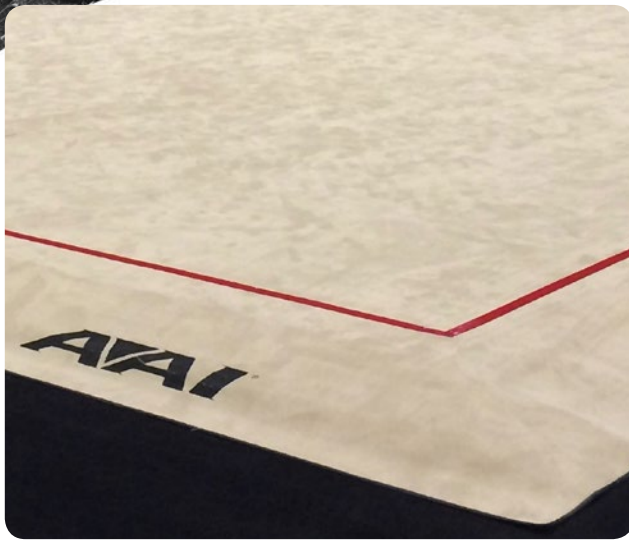

FLOOR

Below is information by the FIG on the measurements for Rhythmic Gymnastics to be in FIG compliance:

PERFORMANCE AREA: 1300cm x 1300cm, Tolerance +/- 3cm
 DIAGONALS OF THE PERFORMANCE AREA: 1838cm +/- 5cm
 Border (25 + 25) 50cm
 Safety border 200cm

BORDER AS A VARIANT: Horizontal Area, Width 25cm – Slope max. 20 %, Width 25cm
 WHEN THERE IS A DELIMITATION STRIP BETWEEN THE PERFORMANCE AREA AND THE BORDER: Delimitation strip width 5cm, Tolerance +/- 0.5cm

The delimitation strip is part of the Performance area.



ACRO BLOCKS

- Great for USAG competitive block program
- Good for novice through advanced levels
- Meets all competitive regulations
- Retains athletes that lose or do not have partners
- Strengthen overall athlete training
- Great low-cost program for beginner clubs
- Stable, sturdy, and light weight
- Great to take to the gym or practice at home
- Hand Block is covered with a non-slip suede material
- Light weight steel construction

405-249 Angled Acrobatic Block - Each

405-250 Flat Acrobatic Block - Each

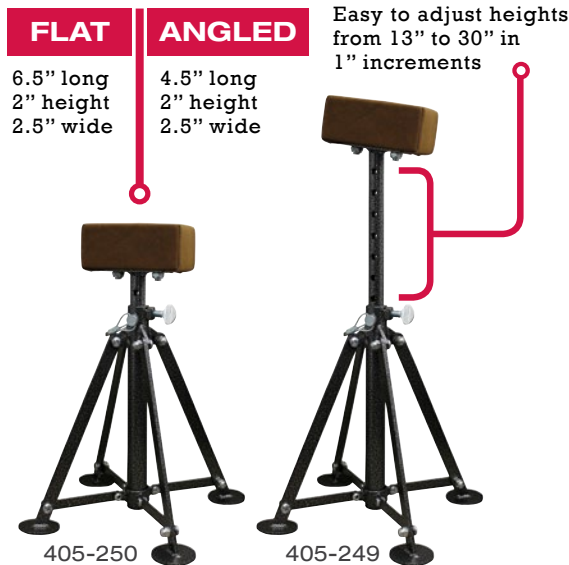

FLOOR EXERCISE DECK

STRATUM® SECURE CONNECT

The Stratum® Secure Connect is ideal for high-level competition and training. Its fiberglass composite material gives the gymnasts a very proactive, stable and uniform performance surface.

- Each 4' x 8' (122 x 244cm) floor panel is supported by 32 ELITE™ Power Springs
- AAI's 4" ELITE™ Power Spring system allows for a more reactive floor, allowing the gymnast to train more effectively
- The AAI Stratum® Secure Connect offers you the best value for your investment
- With new connection system there is no need for straps, allowing for a faster assembly

5 year Stratum® Deck Warranty
(Contact AAI at 1-800-247-3978 for more details)

- 432-497 Stratum® Secure Connect 40' (12m) square
 - 432-429 Stratum® Secure Connect 42' (12.8m) square
 - 432-428 Stratum® Secure Connect 44' (13.4m) square
 - 432-492 Stratum® Secure Connect 46' (14m) square
- * Secure Connect Kits available, please see AAI price list.



4' x 8' Floor Panel

FLOOR

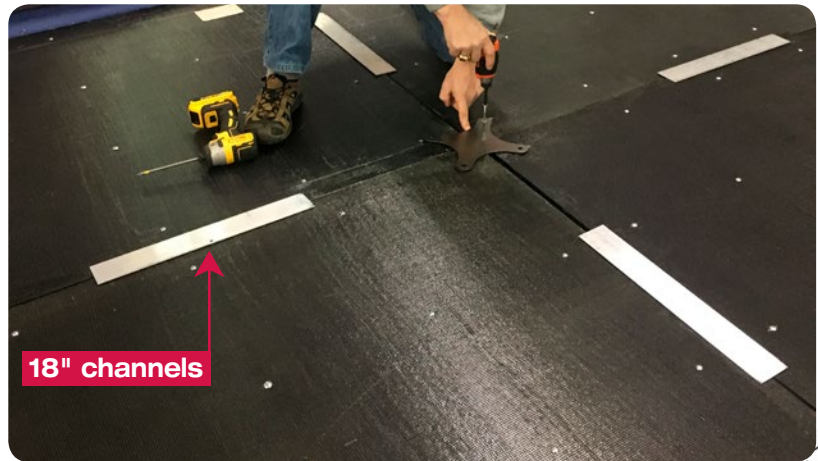
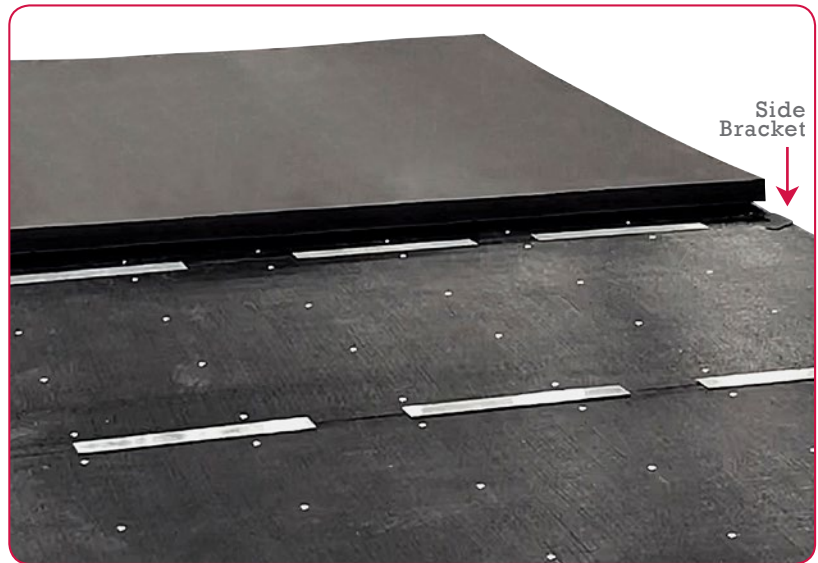
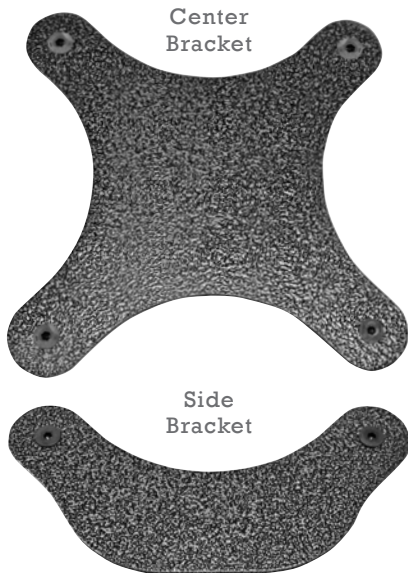

FLOOR EXERCISE DECK

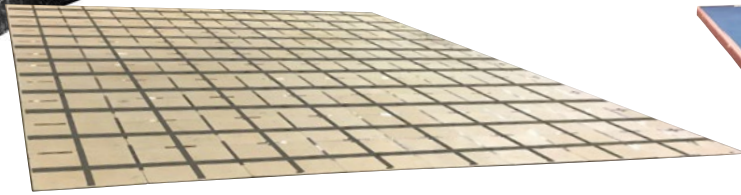

Complete Club Birch Spring Deck

CLUB BIRCH SPRING DECK

- Each deck panel is constructed from 12mm Russian Birch ranging in sizes of 2' x 2' (.06 x .06m) to 5' x 5' (1.5 x 1.5m) depending on the floor size
- The deck utilizes 2" (5cm) diameter x 4" (10cm) long springs, aluminum channels, and secured together with hook and loop fasteners
- Springs are evenly spaced throughout the floor to avoid dead spots

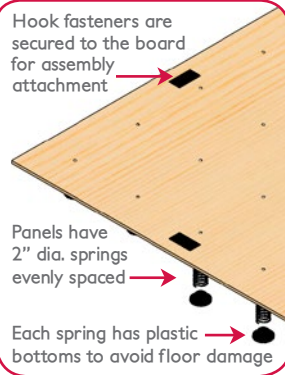

- 432-472** 40' x 40' Birch Spring Deck (12m x 12m)
- 432-474** 42' x 42' Birch Spring Deck (12.8m x 12.8m)
- 432-476** 42' x 54' Birch Spring Deck (12.8m x 16.45m)
- 548-786** 40' x 40' Foam Border with Skirt (12m x 12m)
- 548-816** 42' x 42' Foam Border with Skirt (12.8m x 12.8m)
- 548-821** 42' x 54' Foam Border with Skirt (12.8m x 16.45m)



NCAA® NATIONAL GYMNASTICS CHAMPIONSHIPS

CLUB BIRCH TUMBLING STRIP

Work on your tumbling pass with this spring paneled tumbling strip.

- Tumbling Surface is made up of 5' x 5' & 2' x 5' panels with springs attached
- Panels are connected with 20" & 48" aluminum H-channels as well as hook and loop fastener straps for connection
- Tumbling strip is covered with 1-3/8" Flex Carpet Bonded Foam
- Vinyl covered border attaches to the Flex Carpet Bonded Foam

432-053 12' x 42' Club Birch Tumbling Strip

432-054 12' x 60' Club Birch Tumbling Strip

STRATUM® TUMBLING STRIP

Work on your tumbling pass with this spring paneled tumbling strip.

- Tumbling Surface is 4' x 6' panels with 24 springs attached
- Side borders pieces are 8' long x 2' wide and slopes to 2" above the floor
- End borders are 6' long x 3' wide and slopes to 2" above the floor
- Tumbling strip is covered with 2" polyethylene roll foam and blue carpet

432-179 40' Stratum® Tumbling Strip

432-185 48' Stratum® Tumbling Strip

432-188 56' Stratum® Tumbling Strip

FLOOR EXERCISE CARPETS

All AAI® Floor Exercise Carpets are made of the finest materials available for gymnastics with its soft nylon 30oz plush carpet and strong 68oz weight. AAI carpets are offered in multiple colors to meet your gyms needs, contact our customer service department for additional details.



Carpet Style for 432-509 & 432-524

ALL-AMERICAN ELITE™ CARPET

- Overall carpet size is 45' 4 1/2" (13.8m) square
- Performance area is 39' 4 1/2" (12m) square Newport Blue carpet
- Outside surrounding border is 3' (91cm) wide gray carpet
- Carpet comes in four sections and utilizes 4" (10cm) hook fasteners for attachment to eliminate seams

432-509 All-American ELITE™ Carpet

INTERNATIONAL ELITE™ CARPET

- Overall size is 48' 4 1/2" (14.7m) square
- Performance area is 39' 4 1/2" (12m) square carpet
- Outside surrounding border is 4' (1.2m) wide gray carpet
- Carpet comes in four sections and utilizes 4" (10cm) hook fasteners for attachment to eliminate seams

432-524 International ELITE™ Carpet

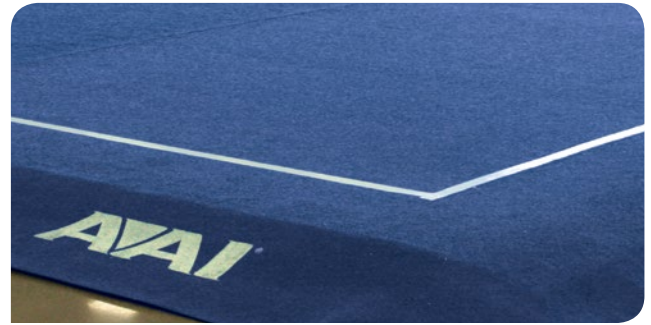

Carpet Style for 432-504 & 432-545

AMERICAN ELITE™ CARPET

- Overall size is 45' (13.7m) square Newport Blue carpet
- 2" (5cm) white tape is included to mark off the performance area
- Carpet comes in four sections and utilizes 4" (10cm) hook fasteners for attachment to eliminate seams

432-504 American ELITE™ Carpet

AMERICAN CLASSIC™ CARPET

- Overall size is 42' (12.8m) square Newport Blue carpet
- 2" (5cm) white tape is included to mark off the performance area
- Carpet comes in four sections and utilizes 4" (10cm) hook fasteners for attachment to eliminate seams

432-545 American CLASSIC™ Carpet

STRAP WINDER

- Strap Winder can hold approx. 50-70 feet of hook strap
- Open side so strap roll can slide off easily

405-020 Strap Winder



Insert strap into the slots then crank.



▶ Check out strap winder video at americanathletic.com/winder

FLOOR

FLOOR EXERCISE CBF



FLOOR



Carpet Bonded Foam for competition floor and tumbling strips are available in blue, red, black, purple, teal, pink, charcoal & light gray.



ENVIROLITE™ CBF - FLAT ROLL

416-780 Carpet Bonded Foam - Flat Roll - 6' x 42' x 1-3/8" (Blue, Light Gray or Charcoal)

416-781 Carpet Bonded Foam - Flat Roll - 6' x 42' x 1-3/8" (Black, Red or Purple)

416-782 Carpet Bonded Foam - Flat Roll - 6' x 42' x 2" (Blue, Light Gray or Charcoal)

416-783 Carpet Bonded Foam - Flat Roll - 6' x 42' x 2" (Black, Red or Purple)

416-788 Carpet Bonded Foam - EVA - Flat Roll - 6' x 42' x 1-3/8" (Blue, Black, Light Gray, Red or Charcoal)

416-789 Carpet Bonded Foam - EVA - Flat Roll - 6' x 42' x 2" (Blue, Black, Light Gray, Red or Charcoal)

PACKAGES

416-790 Carpet Bonded Foam Package - Flat - 1-3/8" - 7 Rolls (Blue, Black, Light Gray, Red or Charcoal)

416-792 Carpet Bonded Foam Package - Flat - 2" - 7 Rolls (Blue, Black, Light Gray, Red or Charcoal)

- Flat and Flex rolls are available in EVA or PE options
- Standard sizes: 6'x42'x2" or 6'x42'x1 3/8"

ENVIROLITE™ CBF - FLEX ROLL

416-786 Carpet Bonded Foam - Flex Roll - 6' x 42' x 1-3/8" (Blue, Black, Light Gray, Red or Charcoal)

416-787 Carpet Bonded Foam - Flex Roll - 6' x 42' x 2" (Blue, Black, Light Gray, Red or Charcoal)

416-820 Carpet Bonded Foam - EVA - Flex Roll - 6' x 42' x 1-1/2" (Blue, Black, Light Gray, Red or Charcoal)

416-822 Carpet Bonded Foam - EVA - Flex Roll - 6' x 42' x 2" (Blue, Black, Light Gray, Red or Charcoal)

- EVA is a denser foam that is higher quality which will last longer and perform better.
- EVA foam has a softer and more rubbery feel and has very quick rebound properties.

POLYETHYLENE ROLL FOAM

416-770 Roll Foam 6' x 42' x 1 3/8" (1.8m x 12.3m x 3.5cm)

416-771 Roll Foam 6' x 42' x 2" (1.8m x 12.3m x 5cm)

432-708 Roll Foam 6' x 42' x 2 1/4" (1.8m x 12.3m x 5.7cm)

432-408 Roll Foam 6' x 45' x 2 1/4" (1.8m x 13.7m x 5.7cm)

432-508 Roll Foam 6' x 46' 6" x 2 1/4" (1.8m x 14.2m x 5.7cm)

CROSSLINK EVA ROLL FOAM

416-772 Crosslink EVA Roll Foam 6' x 42' x 1 1/4" (1.8m x 12.3m x 3.5cm)

416-773 Crosslink EVA Roll Foam 6' x 42' x 2" (1.8m x 12.3m x 5cm)

ELITE™ ROLL FOAM PACKAGE

• Seven rolls of 2" (5cm) cross-link polyethylene foam

416-750 American ELITE™ Roll Foam Package 6' x 42' x 2" (1.8m x 12.3m x 5cm) - 7 Rolls

416-745 International ELITE™ Roll Foam Package 5' 9 3/4" x 46' 6" x 2" (1.8m x 14.2m x 5cm) - 8 Rolls



ELITE™ TUMBLING TRAMPOLINES

THE ELITE™ TUMBLING TRAMPOLINE

The ELITE™ Tumbling Trampoline is a training tool designed to improve strength and flexibility, aiding in the development of basic and advanced tumbling progressions. The benefits include more repetition with less strain on the athletes body, improving air awareness and adding greater diversity in tumbling workouts.

- 13" (33cm) wide frame pads are made of dense foam 1 1/2" (38mm) thick covered with 18 oz. vinyl
- End pads attach to the safety pads which cover the end of the framework
- Durable polypropylene bed with reinforced stitching
- 6" (15cm) high performance springs made of music wire and zinc plated to last longer
- Trampoline frame is made of the same high strength rectangular steel used for our competitive apparatus line
- Bed comes with vinyl covered ends labeled with a "No Tumble Zone" warning stencil
- Warranty: Frame: 5 year; Bed: 2 year

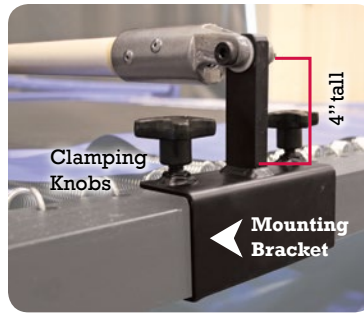

- 406-126** ELITE™ Tumbling Trampoline - 10' (3m) section
- 406-127** ELITE™ Tumbling Trampoline - 20' (6m) section
- 406-128** ELITE™ Tumbling Trampoline - 30' (9m) section
- 406-129** ELITE™ Tumbling Trampoline - 40' (12m) section
- 406-130** ELITE™ Tumbling Trampoline - 50' (15m) section
- 406-131** ELITE™ Tumbling Trampoline - 60' (18m) section
- 416-430** Landing Mat - 7' x 14' x 18" (2m x 4.3m x 46cm)
- 416-433** Landing Mat - 7' x 16' x 18" (2m x 4.9m x 46cm)
- 416-434** Landing Mat - 7' x 18' x 18" (2m x 5.4m x 46cm)
- 015235** Replacement Springs

TRAINING BAR

- Rail can be attached at any location of the ELITE™ Tumbling Trampoline simply by loosening the clamping knobs and moving to desired position
- User friendly & easy to install
- Clamping knobs tighten to lock down for easy movement
- Fiberglass bar similar as our Graphite X Bar without the wood laminate

406-140 Training Bar

FILLER BLOCK

- Provides cushion & protection if an athlete overshoots while training new skills
- Safety strap connects the trampoline frame, filler block & landing mat to eliminate separation

B416-431 Filler Block - 57" x 23 3/8" x 18" (145 x 59 x 46cm)



Model#	406-126	406-127	406-128	406-129	406-130	406-131
Length	10' (3m)	20' (6m)	30' (9m)	40' (12m)	50' (15m)	60' (18m)
Number of springs	92	188	284	380	476	572
Number of pads	4	8	12	16	20	24

TRAMPOLINE

EUROTRAMP® TRAMPOLINES

EUROTRAMP®

AAI is the exclusive distributor for Eurotramp® in the United States!

Eurotramp® is a worldwide leading company specialized on building trampolines with more than 55 years of experience. They produce high quality products for professional competitions as well as leisure time and outdoor products. High quality standard as well as the ambition to innovation, with the best possible customer relationship and excellent reliability are mirrored in every single Eurotramp® trampoline. Not for nothing...top athletes all over the world trust Eurotramp® trampolines and service every single day.



"Easy-Lock-System" to set up the trampoline quicker and more efficiently

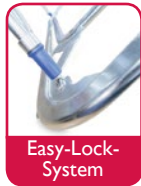

GOOD CHOICE FOR CLUBS THAT NEED MOBILITY



Laser-cut accuracy gives the new frame design greater potential for safety

ULTIMATE 4X4 TRAMPOLINE

This impressive state of the art piece of equipment has outstanding improvements in durability, usability, safety and stability.



- FIG Approved
- Competition trampoline for the World Championships 2014 in Daytona Beach (USA), World Championships Odense (Denmark) 2015 and the Rio 2016 Olympic Games
- Tried and tested by many of the world's best gymnasts as a huge step and enrichment for the trampoline family
- Superb balance between the flexibility of the frame and its strength with high-tech steel of supreme quality
- Unique engineered hinge design with block friction bearings giving more resistance to wear and tear
- "Ultimate"-springs for optimum dynamics and longevity

403-102 Ultimate 4x4 Trampoline

ULTIMATE DOUBLE-MINISTRAMP 6X6



- FIG Approved
- "newest version" heavier frame than the 403-111
- Sinking depth in the center of the jumping bed is better for the security of the athlete
- More power and durability due to optimized spring suspension and sturdy frame
- High-performance springs guarantee a high performance consistency
- Unique energy-efficiency for the athletes
- Optimal balanced jumping behavior

403-110 Ultimate Double-Minitramp 6x6

TRAMPOLINE

EUROTRAMP® TRAMPOLINES



PITCH MAT

Pitch mat is thrown onto the trampoline while the athlete is in the air in order to soften the landing.

- Reinforced handles on the sides allow for easy grabbing and tossing
- Mat size: 4' x 6' x 5" (122 x 183 x 13cm)

416-595 Pitch Mat – Firm



NYLON BAND WIDTH AT JUMPING BEDS

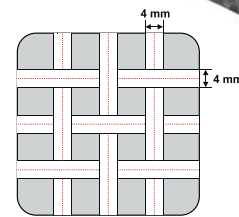

When talking about 4x4 beds, 4 mm means the width of the strands, both in the long and in the wide direction

TRAMPOLINE JUMPING BED

Several jumping bed variations enable usage geared exactly to the area of application. Eurotramp jumping beds are made with the highest precision with innovative and high performance materials.

- 403-150** Jumping Bed - 6x4 for Grand Master Exclusive
- 403-151** Jumping Bed - 4x4 for Grand Master with anchor bars
- 403-152** Jumping Bed - 426 x 213cm polyester web for Grand Master
- 403-153** Jumping Bed - Double Mini Trampoline (DMT)
- 403-154** Jumping Bed - 392 x 92cm nylon web for Ultimate DMT 6x6
- 403-155** Jumping Bed - Open-End Minitramp
- 403-225** Bed Marking Kit
- 403-226** Red Paint for Bed
- 403-160** Spring Set – 110 springs plus 8 corner springs - springs are 10" (25.8cm)
- 403-162** Strengthened Steel Corner Spring – each - spring is 10" (25.8cm)

CLUB SPORTS & HIGH PERFORMANCE

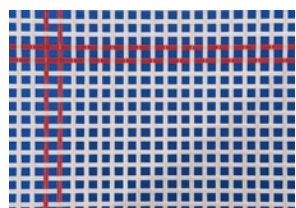

6x6-bed

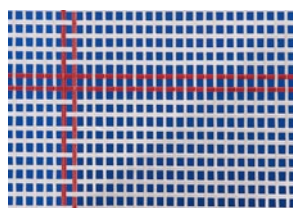

6x4-bed

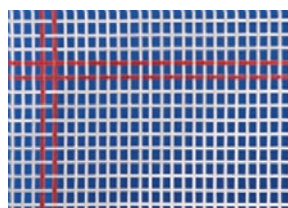

4x4-bed

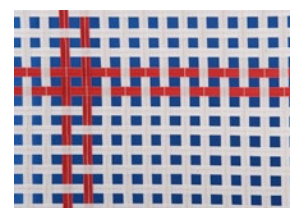

13x13-bed

SCHOOL & THERAPY

4x4

This jumping bed is made of 4 mm and 4 mm wide woven nylon bands sewn lengthwise and crosswise respectively. It offers the maximum permissible jumping performance according to FIG rules and is used in almost all trampoline competitions worldwide. **Used for only** Premium and Ultimate frame

6x4

This jumping bed is made of 4 mm and 6 mm wide woven nylon bands sewn in lengthwise and crosswise respectively. Because of the minimal air resistance caused by bouncing, it offers the high performance required for competitions. **Used for only** Premium and Grand Master Exclusiv frame

6x6

The bed is the predecessor of the 6x4 mm and has 6 mm wide woven nylon bands both lengthwise and crosswise. The 6 mm bed has a lower level of performance than the 6x4 mm model but can be also used in competitions, according to FIG. **Used for only** Grand Master Exclusiv frame, Minitramp Teamgym, Open-End-Minitramp

13x13

A well-proven type of bed; combining comfort with the necessary power and used for nearly all types of apparatus. Highly recommended as a standard bed with a broad spectrum of performance and excellent spring characteristics. **Used for** Grand Master Exclusiv frame, Double-Minitramp series, Minitramps, Open-End-Minitramps, Minitramp, Teamgym

TRAMPOLINE

EUROTRAMP® TRAMPOLINES

MODULAR MAT STRAPS

548-249	144"	Mats utilize hook straps to connect mat edges.
548-247	93"	
547-981	90"	

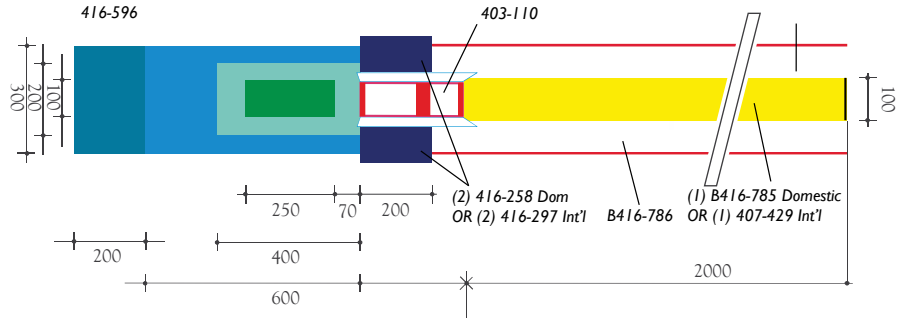

DOUBLE MINI SET-UP

407-429	International Vault Runway
416-308	5 x 8 20 cm
416-297	7.5' x 12.5' x 20 cm V4
416-594	Landing Mat Cover, Target
416-596	SC-12 5' x 10' V2
548-828	4" Hook strap assy 9"x120"
B416-785	Vault Runway - 1-3/8" - Blue
B416-786	CBF Flex Roll 6' x 42' x 1-3/8"

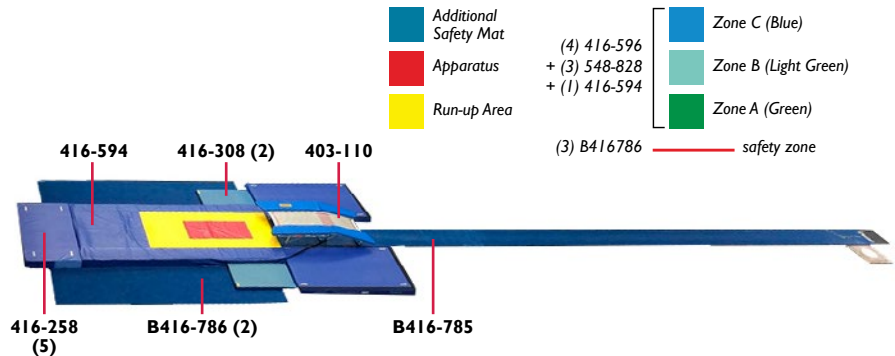

COMPETITION LANDING MATS

Description	Style	20cm Model
8' x 12' (2.4 x 3.6m)	V4	416-296
7.5' x 12.5' (2.2 x 3.8m)	V4	416-297
6' x 7.75' (1.8 x 2.3m)	V4 Slab	416-298
7.5' x 7.75' (2.2 x 2.3m)	V4 Slab	416-299
8' x 7.75' (2.4 x 2.3m)	V4 Slab	416-300
403-109 End Deck Frame		

416-593 End Deck Mat System includes (2) of the 416-591 end deck mats and (2) of the 416-592 end deck wedges.

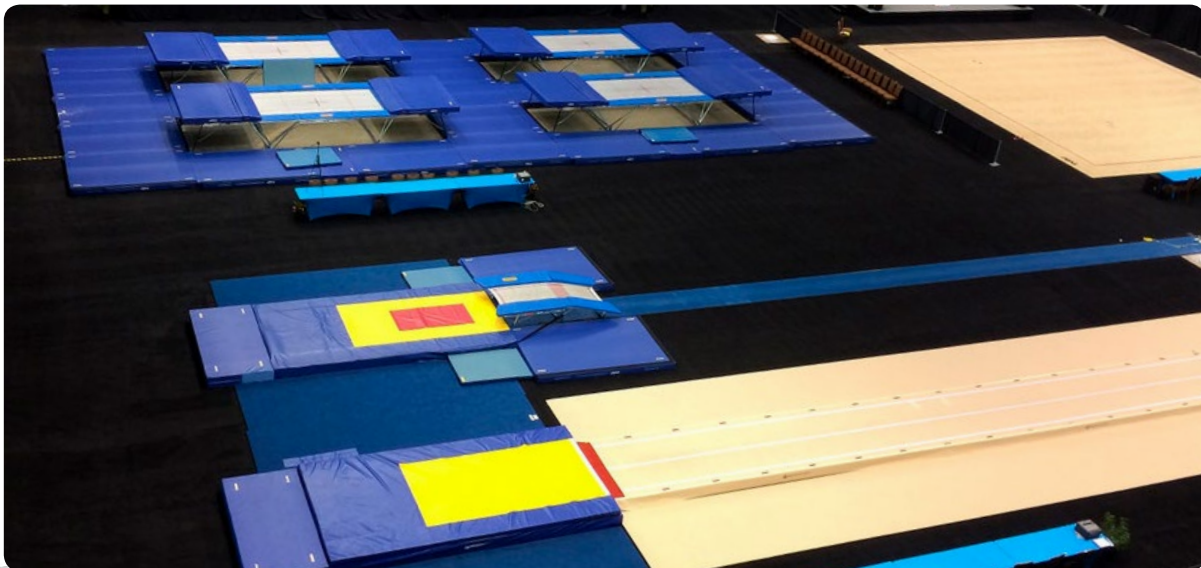
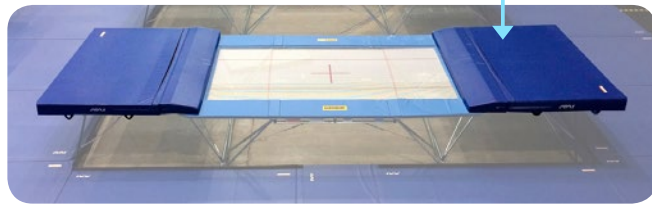
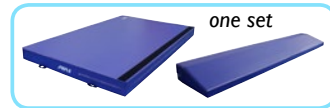

TRAMPOLINE

EUROTRAMP® TRAMPOLINES

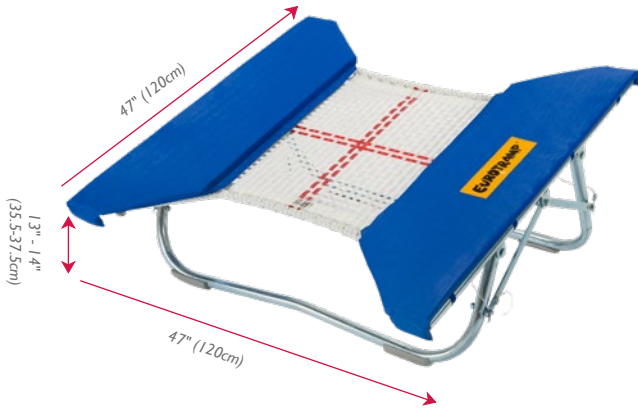

OPEN-END MINITRAMP

- The Open-End-Minitramp is meant for users that have a high achievement objective with barrier-free entry
- Adjustable in height
- The flat oval frame with frame-less jump in and out zones offers a strong performance and is suitable especially for more difficult jumps

- 403-I 14** Open-End Minitramp Premium 6x6
- 403-I 13** Open-End Minitramp School 13x13
- 403-I 17** Open-End Minitramp Standard 13x13

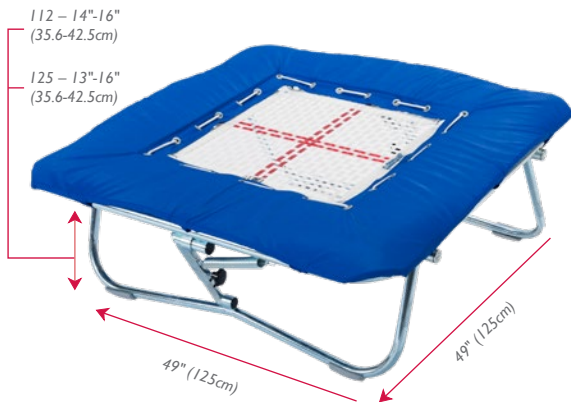

MINITRAMP 112 & 125

- Used as an angled take-off trampoline and can be used for vaulting
- There are a variety of uses in schools or in rehabilitation centers
- A jumping bed provides the necessary performance level for all athletes
- Difference between 112 & 125 is dimensional (112cm sq. vs 125cm sq.)
- Shock absorbing and stable frame pads
- Wheels for easy transport & adjustable in height

- 403-I 12** Minitramp 112
- 403-I 18** Minitramp 125



BOOSTER BOARD/VAULT TRAMPOLINE

- Approved by USAG for use in Excel Programs
- Unites the functionality of a classical springboard with the dynamics, ease, and jumping fun-factor of a trampoline
- Suited for recreational, amateur and school sports, artistic gymnastics, indoor Parkour and Freerunning
- Even, barrier-free jump-in
- Adjustable in height (26.5cm to 32cm)

- 403-I 03** Booster Board/Vault Trampoline

TRAMPOLINES

	FIG Approved	Bed Type(mm)	Bed Size	Frame Type	Roller Stand Type	Number of Springs	Spring Type	Set up Dimension(cm)	Weight	Use
Ultimate	YES	4x4	426x213cm	Closed	Lifting Roller Stands	118	258mm Steel	520 L x 305 W x 115 H	260 kg	HP - T
Ultimate Double Minitramp	YES	6x6	292x92cm	Open	Roller Stands	102	235mm Steel	350 L x 190 W x 70 H	152 KG	HP - T
Open-End Minitramp Premium	NO	6x6	70x60cm	Open	N/A	32	185mm Steel Galvanized	120 L x 120 W x 35.5-37.5 H	39 kg	HP - T - R
Open-End Minitramp Standard	NO	13x13	70x60cm	Open	N/A	32	185mm Steel Galvanized	120 L x 120 W x 35.5-37.5 H	39 kg	HP - T - R
Open-End Minitramp School	NO	13x13	70x60cm	Open	N/A	32	185mm Steel Galvanized	120 L x 120 W x 35.5-37.5 H	39 kg	HP - T - R
Minitramp 125	NO	13x13	70x70cm	Closed	N/A	32	185mm Steel	125 L x 125 W x 35-42 H	32 kg	R
Minitramp 112	NO	13x13	60x60cm	Closed	N/A	28	185mm Steel	112 L x 112 W x 35.3-42.5 H	29 kg	R
Booster Board	NO	N/A	93x57cm	Open	N/A	42	Steel	135 L x 100 W x 26.5-32 H	33 kg	T - R

TRAMPOLINE

IN-GROUND TRAINING PITS

From beginning to advanced techniques, AAI® pits provide the soft landing area required for today's advanced gymnastics. Gymnastic pits function as dismount landing areas which provide extra cushioning when learning new skills, in case of falls from the equipment. Custom foam pits are designed to fit your exacting specifications. To outfit your facility, contact your local AAI dealer or call 800.247.3978 for details.

PIT EDGING

Made from the same great materials as our carpet bonded foam and used for padded edging in your in-ground training pits.

LOOSE FOAM

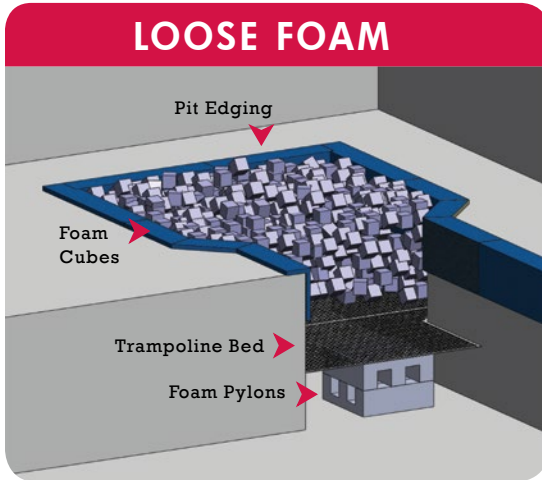

IN-GROUND TRAINING PITS:

- Traditionally loose foam pits are 6-8' deep filled with foam blocks
- Compatible with most AAI® apparatus
- Pit edging will cover 14" (35.5cm) of the concrete floor and 22" (56cm) inside the in-ground pit wall consists of cross-link polyethylene foam bonded to a low pile blue carpet with finished edges in sections of 2" (5cm) thick and 6' (1.8m) length

FOAM CUBES

Provides a combination of softness, durability and safe landing.

- Foam cubes fill rate: 75% minimum
- Available in 6" x 6" x 6" & 8" x 8" x 8" sizes (15 x 15 x 15cm & 20 x 20 x 20cm)
- Standard blue with other color options available

TRAMPOLINE BED

• A trampoline bed mounted 2', (61cm) above the bottom of the pit which provides support for loose foam cubes as well as floor clearance

FOAM PYLONS

For added safety & longevity AAI® foam modules can be placed below the trampoline bed providing additional support.

- Foam Pylons are 2' x 2' x 2' in shape (61 x 61 x 61cm)
- Help minimize sag over time
- Typically spaced 6' (183cm) on center (3' (91cm) from walls)

MODULAR

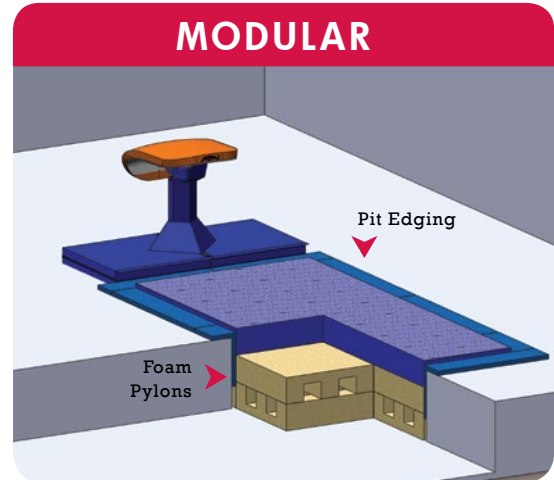

MODULAR IN-GROUND PITS:

- Helps athlete gain confidence from loose foam to landing mat
- Pit edging will cover 14" of the concrete floor and 22" inside the in-ground pit wall consists of cross-link polyethylene foam bonded to a low pile blue carpet with finished edges in sections of 2" thick and 6' (183cm) length

TOP SKILL CUSHION

- 18 oz. vinyl cover, mesh top and/or sides
- Top mat can be rotated to double life span
- Top mat can be flush with, above, or below the floor surface
- Mesh Top and/or sides allow the pit to breathe during impact

FOAM PYLONS

- Foam Pylons vary in size depending on pit size
- Increases cushioning for training
- Bare base foam modules can minimize cost
- Customized foam firmness upon request

WARNING

No pit of any kind can completely eliminate the possibility of a serious neck or back injury. Every effort must be taken to avoid landing on the head or neck, especially going forward. Careful gymnastic progression must be followed to avoid dangerous landings on the neck.

IN-GROUND TRAINING PITS

TRAINING PITS



- Pits are 24" (61cm) or 32" (81cm) thick, utilizing the combination of one-piece foam sections providing an optimum combination of softness and maximization of foam life
- 18 oz. vinyl covers the bottom and sides with a mesh top that allows air release upon landings

416-471 Training Pit 5' x 10' x 24" (1.5m x 3.0m x 61cm)

416-450 Training Pit 5' x 10' x 32" (1.5m x 3.0m x 81cm)

416-472 Training Pit 7½' x 16' x 24" (2.3m x 4.9m x 61cm)

416-473 Training Pit 7½' x 16' x 32" (2.3m x 4.9m x 81cm)

Custom sizes available — call 1-800-247-3978 for details.

CHANNEL PITS



- Specially designed to fit any facility's space
- Each pit is custom fit to give the exact protective edge, side and bottom for your training area

Contact your local dealer or AAI at 1-800-247-3978 for price information on channel pits.

533-504 Women's Trench Bar

533-511 Men's Trench Bar

- Optional Channel Bar available - call for custom sizes

CBF PIT EDGING

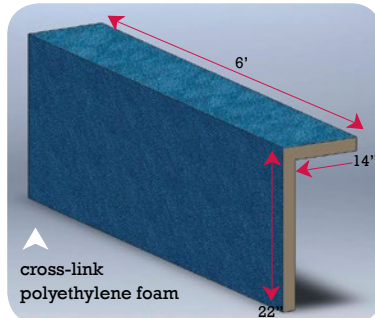
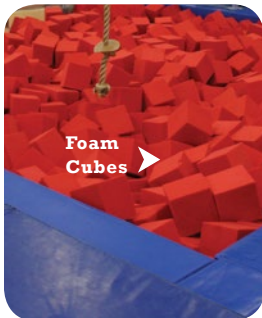

- Pit edging consists of cross-link polyethylene foam bonded to a low pile blue carpet with finished edges
- Each section is 2" (5cm) or 1 3/8" (3.5cm) thick and 6' (1.8m) in length
- Pit edging will cover 14" (36cm) of the concrete floor and 22" (56cm) inside the in-ground pit wall
- Sections come pre-cut flat for easy use and installation

416-881 1 3/8" x 3' x 6' (3.5 x 91 x 183cm) — pre-cut flat



PITS

PIT CUBES & COVERS



FOAM PIT CUBES

- High-quality polyurethane in 6" and 8" sizes
- 1.45# density, 45 ILD
- Meets California Technical Bulletin 117 standards
- Custom colors available upon special order
- Foam cubes are available in Black, Blue, Charcoal, Light Gray, Kelly Green, Lime Green, Orange, Purple, Red and Yellow

Contact your local dealer or AAI at
1-800-247-3978 for price information.



PIT CUBE COVERS

- Reduce dust caused by friction
- Extends the life of the cubes & protects your investment
- Reduce "picking" the cubes apart
- Cleaner pits & cleaner air to breath
- Looks and feels better!

416-178 8" (20cm) Pit Cube Covers - 200 covers
416-113 6" (15cm) Pit Cube Covers - 300 covers



FREE SAMPLES FOR YOUR GYM!

Email your name, gym name,
address and phone number to
AskAAI@americanathletic.com

PITS



CUBE COVER

FOAM CUBE

LESS DUST

ACCESSORIES

truce CHALK REMOVER

CHALK... KIDS PLAY WITH IT... EQUIPMENT IS COVERED IN IT... NOW, YOU CAN CLEAN IT! LEAVE THE NASTY CHEMICALS TO SOMEONE ELSE. SAFE, SIMPLE AND EFFECTIVE INGREDIENTS ARE ALL YOU NEED TO GET THE JOB DONE RIGHT.

USES All Chalky surfaces including vinyl mats, carpet bonded foam, plastic bins, beams, vault tables and more.

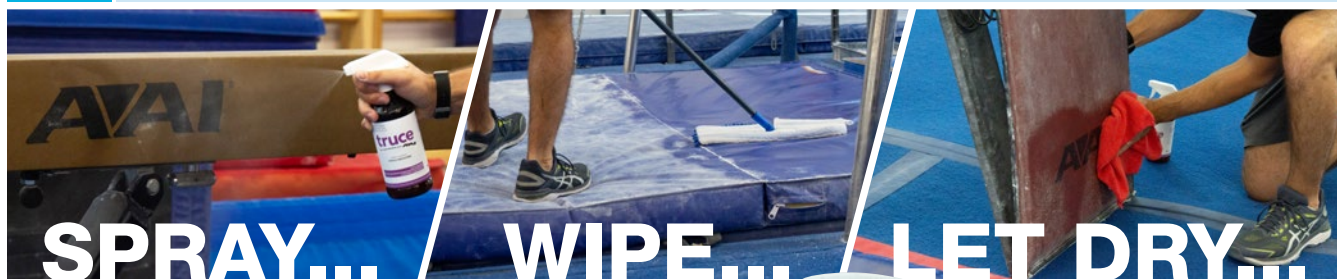

TRUCE CHALK REMOVER

- SLS-free (No Sulfates)
- No Phthalates, Phosphates, and Parabens
- No Dyes and Fragrance-free
- Toxin-free and cruelty-free
- Hypoallergenic and Aromatherapeutic
- Made in the USA

60099 Truce Chalk Remover Gallon

60098 Truce Chalk Remover Case of 4

*Every Gallon and Case come with
1 Spray Bottle and 1 Pump.

NO MATTER WHAT TYPE OF FACILITY YOU RUN, YOU TAKE ENSURING THE SAFETY OF YOUR FAMILIES, COACHES, AND EMPLOYEES SERIOUSLY.



ACCESSORIES

ACCESSORIES



CHALK

- 2 ounce blocks of magnesium carbonate gym chalk, perfect for gymnastics, weight training, and more!

407-550 1 lb Chalk in 2 oz blocks

407-565 36 lb Chalk in 2 oz blocks



EVO-BLACK™ CHALK HOLDER

- Chalk bowl made of rugged white polyethylene top and a black polyethylene bottom
- Stands 32" (81 cm) tall

407-197 Evo-Black™
Chalk Holder



LOW CHALK HOLDER

- Made of rugged white polyethylene
- 13" (33cm) wide base for stability
- Stands 20" (50cm) tall

407-011 Low Chalk Holder



STEP-IN CHALK HOLDER

- Step-in chalk bowl made of rugged white polyethylene
- Place on floor for easy access
- 24" (61 cm) in diameter x 2" (5cm) high

407-007 Step-In Chalk Holder



HIGH CHALK HOLDER

- Chalk bowl made of rugged white polyethylene
- Stands 32" (81 cm) tall

407-008 High Chalk Holder

TAC/10 SURFACE CLEANER

- Soy-based product developed for people with certain allergies and chemical sensitivities
- Includes 1 Quart (32fl.oz.) 946ml spray bottle and one microfiber towel
- Not manufactured by AAI

407-567 TAC/10 Surface Cleaner



TAC/10 TOWEL

- Towel provides a slight tackiness helping to prevent slipping due to moisture
- No build-up on hands - unlike chalk
- Not manufactured by AAI

407-571 TAC/10 Towel (Box of 12)



ACCESSORIES

OVERHEAD SUSPENSION

- Unit comes complete with two 5" (13cm) pulleys, ropes and a 407-064 Adjustable Padded Tumbling Belt
- Requires two Beam Clamps (not included)
- For optimal installation, the ropes shall be suspended at a 35 degree angle from vertical when the tumbling belt is at waist height above the apparatus
- Ceiling height, beam placement and distance between the beams will be required when placing order

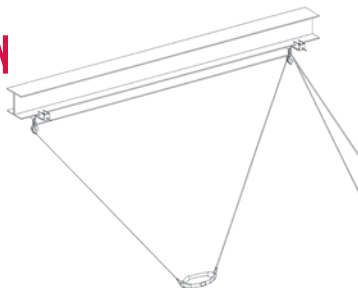

407-041 Overhead Suspension — Contact AAI for ordering information.

TWISTING BELTS

- Rotating rings are cast of high tensile strength aircraft aluminum alloy
- Lined with soft padding for comfort



407-037 Small Padded Twisting Belt - up to 25" (64cm)

407-020 Medium Padded Twisting Belt - 25" to 29" (64 to 74cm)

407-038 Large Padded Twisting Belt - 29" and over (74cm)



TUMBLING BELTS

- Two styles – one-piece padded and two-piece adjustable padded
- Color coded for easy selection, yellow-small, red-medium, blue-large and black-adjustable

407-063 Small Padded Tumbling Belt - 24"-28" (61-71cm)

407-062 Medium Padded Tumbling Belt - 28"-32" (71-81cm)

407-060 Large Padded Tumbling Belt - 32"-36" (81-91cm)

407-064 Adjustable Padded Tumbling Belt - 28"-42" (71-107cm)

CLIMBING ROPES

- 1 1/2" (4cm) diameter manila rope
- Standard lengths of 24' (7.3m)
- Custom lengths available - sold on a non-return basis



CR202 Manila 24' Climbing Rope with Woven Knots every 12"

CR201 Manila 24' Climbing Rope with Turks Head Knot

CR200 Manila 24' Climbing Rope with Leather Boot

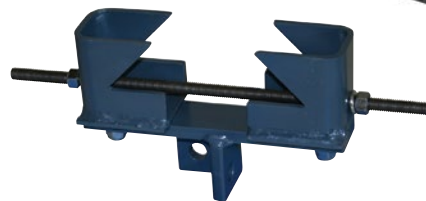

I-BEAM CLAMP

422-053 Fits beams 5" to 9" (12.7 to 22.8cm) with flange up to 3/4" (1.9cm) thick

422-054 Fits beams 9" to 14" (23 to 36cm) with flange up to 3/4" (2cm) thick

WOOD CLAMP

- Fits square and tapered beams 5" to 7" (13 to 18cm) in width
- Includes four lag screws

422-061 Wood Clamp

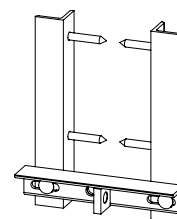

PIPE CLAMPS

- Fits 3" (7.6cm) ID pipe (Specify inside diameter or circumference of pipe when ordering.)

422-023 Pipe Clamp

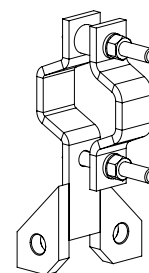

CONCRETE CLAMP

- Fits square and tapered beams 5" to 7" (13 to 18cm) in width
- Includes four expansion bolts

422-060 Concrete Clamp

** Contact your local dealer or AAI for special size clamps.*

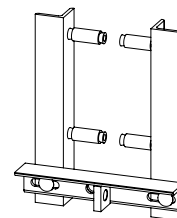

RING/ROPE HOIST

Conveniently stores rings when not in use.

- Wooden wall bracket attaches quickly to any wall
- Weighted top end of rope brings rings down when needed

407-022 Ring/Rope Hoist

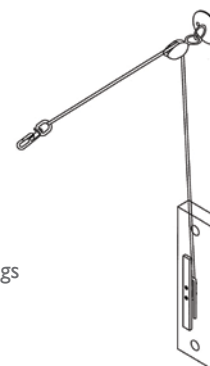

ACCESSORIES

APPARATUS ACCESSORIES



STANDARD SWIVEL ANCHOR

- Included with all AAI® cabled apparatus
- Installs into AAI® 3/4" (13mm) threaded floor plate
- Swivels 360°

49003 Standard Swivel Anchor – Each

407-135 Standard Swivel Anchor – Set of Four

49004 Retro Fit Floor Anchor - Each

407-140 Retro Fit Floor Anchor - Set of Four

VAULT SPRING REPLACEMENT KIT

- Each kit shall include
 - (4) Constant force springs,
 - (4) Plastic drums for the inside of the springs, (8) 1/4-20 x 1/2 bolts and (8) 1/4-20 acorn nuts



405-034 Spring Replacement Kit

SRS SYSTEM

System as a space-saving alternative to uneven bars, high bar and traditional SBT

- 144x144 uneven bars footprint
- 150³/₈ x 98¹¹/₁₆ horizontal bar and sbt footprints

407-078 SRS System* (pads not included)

407-890 SRS Pads - Set of four

*US Patent #6,336,892



407-078 SRS System Set of four



407-890 SRS Pad - Set of four



Quick Release Pin



Men's Quick Release Bar

QUICK RELEASE CONVERSION KIT

- Includes one pair of collars and locking quick release pins to fit AAI® Single Bar Trainers
- Pin fits SBT models 407-450, 407-625, 407-639

407-360 Quick Release Conversion Kit

407-356 Men's Quick Release Bar

20591 Quick Release Pin Replacement



20591

NEW E-LOCK



- E-Locks gives a stronger hold to the upright
- Re-designed Spinlock with Coned designed and "O" ring lock, reduces any movement during use

16192 E-Lock

SPIN LOCK



- Precision machined and knurled chrome-plated finish

19359 Spin Lock - short handle

19155 Spin Lock - longer handle



VAULT TABLE SPIN LOCK KIT

- Used in 407-546 CFS Base

407-554 Vault Table Spin Lock Kit



ELITE™ VAULT TABLE SNAP LOCK

- Features a larger handle than standard snap lock for easy adjustment

9700051 ELITE™ Vault Table Snap Lock

SNAP LOCK



- Precision machined and chrome-plated finish

19189 Snap Lock

48563 Snap Lock (used for UTB adjustment link)



SPIN/SNAP LOCK ASSEMBLY

- Used on 407-440 ELITE™ BEAM ONLY

70470 Spin/Snap Lock Assembly



ADJUSTABLE CLUB BEAM SNAP LOCK

- Used on 406-540 Adjustable Club Balance BEAM ONLY

79337 Adjustable Club Beam Snap Lock



APPARATUS TIE-DOWN

- Requires two floor anchors

422-028 Apparatus Tie-Down Set

ACCESSORIES

APPARATUS ACCESSORIES

EQUIPMENT TRANSPORTERS

- Adjustable transporters are designed to work with Uneven Bars, Balance Beams, Pommel Horse, Vault Table and Parallel Bars
- Designed to fit tubes 1 1/2" - 3" tall (38mm x 76mm)

407-016 Equipment Transporters - Pair



STYLE B FLOOR ANCHOR

- Installed securely in wood floors anchored into concrete
- Replaceable spring-loaded pop-up cap
- Includes anchoring cement

422-121 Style B Floor Anchor



STYLE BX FLOOR ANCHOR

- Longer knurled anchor - 3 1/4" (81mm) than model 422-121
- Installed securely in wood floors anchored into concrete
- Replaceable spring-loaded pop-up cap
- Includes anchoring cement

422-122 Style BX Floor Anchor



STYLE C FLOOR ANCHOR

- Installed in concrete and vinyl covered concrete floors
- Replaceable spring-loaded pop-up cap
- Includes anchoring cement

422-120 Style C Floor Anchor



STYLE E FLOOR ANCHOR

- Installed in floating wood floors resting on sleepers or metal clip fasteners
- Features removable cap
- Includes anchoring cement

- **Measure distance from top of floor to concrete to determine model**

422-123 Style E Floor Anchor — less than 2 7/8" (7cm)

422-124 Style E Floor Anchor — 2 7/8" to 4" (7 x 10cm)

422-125 Style E Floor Anchor — 2 7/8" to 5" (7 x 13cm)

422-126 Style E Floor Anchor — 2 7/8" to 6" (7 x 15cm)

422-127 Style E Floor Anchor — 2 7/8" to 7" (7 x 18cm)

422-128 Style E Floor Anchor — 2 7/8" to 9" (7 x 23cm)



ASSIST STEP

- Can be quickly positioned at various heights on both the inside and outside of the bar
- Designed for use on AAI UTB, High Bar & Premier SBT

407-158 2.375" Assist Step (Each)

407-188 2.375" Assist Step (Pair)

407-159 2" Assist Step (Each)

DELUXE CABLE TIGHTENER

- Pulleys are on 6" (15cm) centers

407-116 Deluxe Cable Tightener - Each

407-115 Deluxe Cable Tightener - Set of 4

407-114 Deluxe Cable Tightener - Replacement Parts Package (Includes 8 rollers and hardware)

407-353 Wear Kit (includes Rollers, plates and hardware)



LOADBINDER TURNBUCKLE

- Heavy-duty construction
- Loadbinder has locking mechanism
- Drop forged steel, hot galvanized finish

71880 Loadbinder Turnbuckle



TURNBUCKLE (EYE & EYE)

- Used on all AAI® cabled apparatus

71878 Turnbuckle (Eye & Eye)



TURNBUCKLE (HOOK & JAW)

- Drop forged steel, hot galvanized finish
- Note: for use on Pommel Horse only

420-735 Turnbuckle (Hook & Jaw)

ACCESSORIES

FREESTANDING ADAPTERS

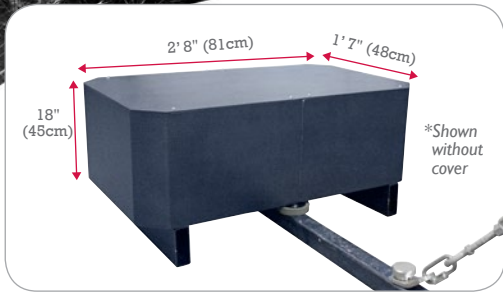

ELITE™ FREESTANDING WEIGHT BOX LEG PACKAGE

- Use in conjunction with any Freestanding Adapter
- Includes four leg sections, four weight boxes with covers

- 407-461** ELITE™ Freestanding Weight Box Leg Package (Filled) 1,200 lbs.
- 407-467** ELITE™ Freestanding Weight Box Leg Package (Empty)
- 407-474** ELITE™ Freestanding Weight Box with 40 lbs. Ballast Bags
- 407-469** ELITE™ Ballast Bags 40 lbs. Weight (Each)
- 407-465** ELITE™ Freestanding Extra 50lb. Weight (Each)

ELITE™ FREESTANDING UNEVEN BAR ADAPTER

- Use in conjunction with ELITE™ Freestanding Leg Packages
- Includes two base stabilizers with four base clamp assemblies
- Floor space dimensions - 18' 6" x 22' 2" (5.6m x 6.75m)

- 407-349** ELITE™ Freestanding Uneven Bar Adapter



ELITE™ FREESTANDING HORIZONTAL BAR ADAPTER

- Includes one horizontal bar stabilizer with two base clamps and four cable assemblies
- Use in conjunction with ELITE™ Freestanding Leg Packages
- Floor space dimensions - 18' 6" x 22' 3" (5.6m x 6.75m)

- 407-362** ELITE™ Freestanding Horizontal Bar Adapter

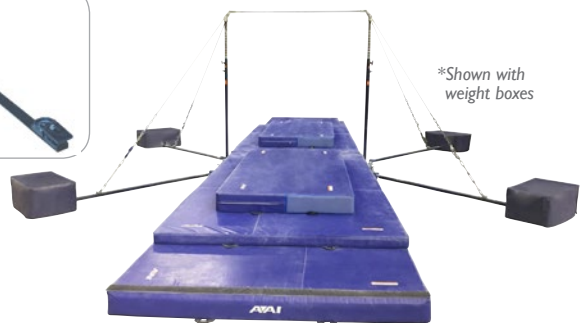

ELITE™ FREESTANDING RING TOWER ADAPTER

- Includes one ring tower stabilizer with two base clamps
- Use in conjunction with ELITE™ Freestanding Leg Packages
- Floor space dimensions - 18' 6" x 22' 6" (5.6m x 6.75m)

- 407-363** ELITE™ Freestanding Ring Tower Adapter
- 403-944** Hardware bag (not shown)

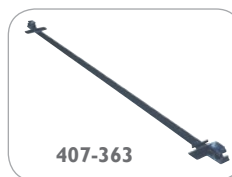

ELITE™ FREESTANDING WEIGHT JUG LEG PACKAGE

- Use in conjunction with any Freestanding Adapter
- Includes four leg sections, four weight platforms and 24 (15 gallon) jugs with covers

- 407-361** ELITE™ Freestanding Weight Jug Leg Package

COMPETITION LANDING MATS

COMPETITION LANDING MATS

AAI manufactures a complete line of competition mats, all designed with the athlete in mind.

- FIG Approved – Event Landing Mat 20cm Mat (only 20cm mats)
- Meets USAG, NCAA® and NFHS competition specifications
- Foam core of 20cm models consists of a top & bottom layer of cross-link foam over a softer dual density polyurethane foam
- Foam core of 12cm models consist of a top layer of polyethylene foam, over a softer layer of polyurethane foam
- Constructed with 18 oz. vinyl cover
- 4" (10cm) hook and loop fasteners on the 20cm models for secure attachment
- 2" (5cm) hook and loop fasteners on the 12cm models for a strong and secure attachment
- Heat sealed top surfaces provide a uniform, seamless landing area



Duo-Fold*



Quad-Fold**



20CM LANDING MATS

Description	Style	20cm Model
4' x 7.5' (1.2 x 2.3m)	V2 Slab	416-381
4' x 8' (1.2 x 2.4m)	V2 Slab	416-382
5' x 7.5' (1.5 x 2.3m)	V2 Slab	416-312
5' x 8' (1.5 x 2.4m)	V2 Slab	416-308
7.5' x 12' (2.3 x 3.6m)	V2	416-383*
7.5' x 15.5' (2.3 x 4.7m)	V2	416-384*
8' x 12' (2.4 x 3.6m)	V2	416-317*
8' x 15.5' (2.4 x 4.7m)	V2	416-322*
8' x 15.5' (2.4 x 4.7m)	V2	540-294*

V2 - Hook and Loop on short sides

V4 - Hook and Loop on all sides

Landing mats also available with V3 & V4 configurations.

** References Quad-fold

* References Duo-fold

12CM LANDING MATS

Description	Style	12cm Model
4' x 7.5' (1.2 x 2.3m)	V2 Slab Firm	416-184
5' x 7.5' (1.5 x 2.3m)	V2 Slab Firm	416-170
6' x 15.5' (1.8 x 7m)	V2 Firm	416-121*/416-116* Ends
6' x 15.5' (1.8 x 7m)	V2	416-076*
7.5' x 12' (2.3 x 3.6m)	V2	416-183*
7.5' x 12' (2.3 x 3.6m)	V2 Firm	416-074 Slab / 416-376* / 416-185*
7.5' x 15.5' (2.3 x 4.7m)	V2	416-531 Slab / 416-375* / 416-122**
7.5' x 15.5' (2.3 x 4.7m)	V2 Firm	416-532 Slab / 416-123**
8' x 12' (2.4 x 3.6m)	V2	416-177*/416-196-Firm*
8' x 15.5' (2.4 x 4.7m)	V2	416-180**/416-377*
8' x 15.5' (2.4 x 4.7m)	V2 Firm	416-378* / 416-197**
8' x 18' (2.4 x 5.5m)	V2	416-198**

COMPETITION LANDING MATS



10CM SUPPLEMENTAL THROW MATS

Supplemental competition and training mat.



- FIG Approved (416-020 10cm Supplemental Throw Mat) – aka 10cm Landing Mat
- Meets USAG, NCAA® and NFHS competition specifications
- 18 oz. vinyl are used on the top and sides for durability
- Mesh bottom panel accommodate rapid air release and reduces slippage
- Polyurethane foam filler is 4” (10cm) thick

- 416-609** 10cm Supplemental Throw Mat 3.5’ x 5’ x 4” (1.1m x 1.5m x 10cm)
- 416-017** 10cm Supplemental Throw Mat 4’ x 8’ x 4” (1.2m x 2.4m x 10cm)
- 416-018** 10cm Supplemental Throw Mat 5’ x 10’ x 4” (1.5m x 3m x 10cm)
- 416-318*** 10cm Supplemental Throw Mat 5’ x 10’ x 4” (1.5m x 3m x 10cm) Firm
- 416-019** 10cm Supplemental Throw Mat 7’ x 10’ x 4” (2.1m x 3m x 10cm)
- 416-319*** 10cm Supplemental Throw Mat 7’ x 10’ x 4” (2.1m x 3m x 10cm) Firm
- 416-020** 10cm Supplemental Throw Mat 8’ x 15’ x 4” (2.4m x 4.5m x 10cm) FIG Approved
- 416-195** Lined (95cm - 150cm) 10cm Supplemental Throw Mat 8’ x 19’ 8 1/4” x 4” (2.4m x 6m x 10cm) FIG Approved - mesh side panels only



BOTTOM SIDE OF MAT

ANTI-SKID THROW MATS & SKILL CUSHIONS

AAI® Anti-Skid mats use a rubberized underside. This technology reduces the risk of “mat surfing” for a more stable landing area.

- Nylon mesh side panels breathe, allowing air to escape on landings
- Reinforced handles are attached for easy mobility
- 18 oz. vinyl are used on the top and sides for durability

- 416-259** SC-8 Anti-Skid 5’ x 10’ x 8” (1.5m x 3.0m x 20cm)
- 416-257** 10cm Anti-Skid Supplemental Throw Mat 5’ x 10’ x 4” (1.5m x 3m x 10cm)
- 416-258** 10cm Anti-Skid Supplemental Throw Mat 7’ x 10’ x 4” (2.1m x 3m x 10cm)



FIG COMPETITION LANDING MATS

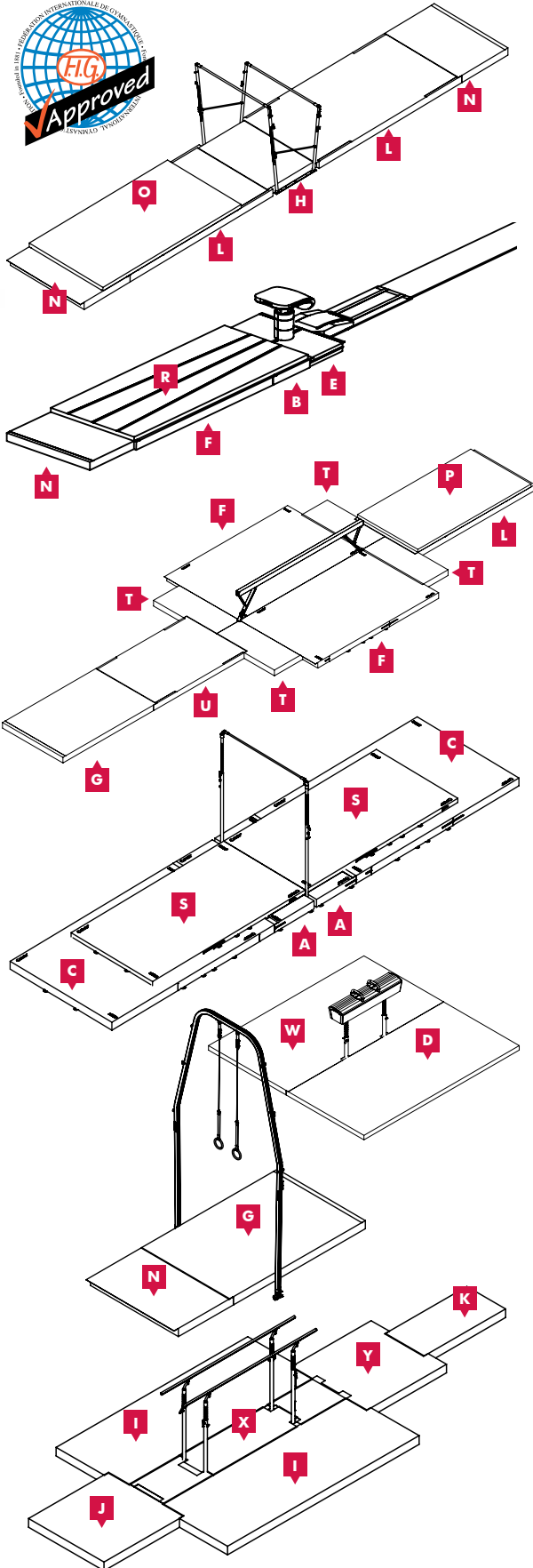

FIG COMPETITION UNEVEN BARS LANDING MAT CONFIGURATION

- (2) **N** 416-308 (5' x 8' x 20cm) V2 Slab | (152.40 x 243.84 x 20cm)
- (2) **L** 416-307 (8' x 15' 6" x 20cm) V-Spec | (243.84 x 472.44 x 20cm)
- (1) **H** 416-312 (5' x 7' 6" x 20cm) V2 | (152.40 x 228.60 x 20cm)
- (1) **O** 416-263 (8' x 15' x 10cm) Supplemental | (243.84 x 472.44 x 10cm)

416-306 FIG Uneven Bars Competition Landing Mat Set

416-595 183 x 122 x 13cm supplemental pitch mat for training

FIG COMPETITION VAULT LANDING MAT CONFIGURATION

- (1) **E** 416-292 (4' x 8' x 20cm) Vault Anchor Mat | (121.92 x 243.84 x 20cm)
- (1) **B** 416-303 (4' 1/4" x 8' 2 1/2" x 20cm) V2 | (127.64 x 250 x 20cm)
- (1) **F** 416-304 (8' 2 1/2" x 15' 6" x 20cm) V2 | (250 x 472.44 x 20cm)
- (1) **N** 416-308 (5' x 8' x 20cm) V2 Slab | (152.40 x 243.84 x 20cm)
- (1) **R** 416-195 (8' x 19' 8 1/4" x 10cm) Supplemental | (243.84 x 600 x 10cm)

416-301 FIG Vault Competition Landing Mat Set

416-256 200cm x 200cm x 10cm supplemental throw mat for training

FIG COMPETITION BALANCE BEAM LANDING MAT CONFIGURATION

- (1) **L** 416-307 (8' x 15' 6" x 20cm) V-Spec | (243.84 x 472.44 x 20cm)
- (2) **F** 416-322 (8' x 15' 6" x 20cm) V2 | (243.84 x 472.44 x 20cm)
- (1) **G** 416-317 (8' x 12' x 20cm) V2 | (243.84 x 365.76 x 20cm)
- (1) **T** 416-313 FIG Beam Filler System (16' x 3' x 20cm) | (287.68 x 91.44 x 20cm)
- (1) **U** 416-354 (8' x 12' V-Spec) | (243.84 x 365.76 x 20cm)
- (1) 416-325 Beam Leg Pads
- (1) **P** 416-263 (8' x 15' x 10cm) Supplemental | (243.84 x 472.44 x 10cm)

416-327 FIG Balance Beam Competition Landing Mat Set

416-256 200cm x 200cm x 10cm supplemental throw mat for training

FIG COMPETITION HORIZONTAL BAR MAT CONFIGURATION

- (2) **C** 416-332 (10' x 16' x 20cm) V-Spec | (304.8 x 487.68 x 20cm)
- (2) **A** 416-349 (4' x 10' x 20cm) V2 | (121.92 x 243.84 x 20cm)
- (2) **S** 416-282 (8' x 15' x 10cm) Supplemental | (243.84 x 472.44 x 10cm)

416-331 FIG Horizontal Bar Competition Landing Mat Set

416-256 200cm x 200cm x 10cm supplemental throw mat for training

FIG COMPETITION POMMEL HORSE LANDING MAT CONFIGURATION

- (1) **D** 416-271 (6' 9" x 13' 6" x 10cm) | (205.5 x 411 x 10cm)
- (1) **W** 416-272 (6' 9" x 13' 6" x 10cm) | (205.5 x 411 x 10cm)

416-270 FIG Pommel Horse Competition Landing Mat Set

FIG COMPETITION RINGS LANDING MAT CONFIGURATION

- (1) **N** 416-308 (5' x 8' x 20cm) V2 Slab | (152.40 x 243.84 x 20cm)
- (1) **G** 416-317 (8' x 12' x 20cm) V2 | (243.84 x 365.76 x 20cm)

416-328 FIG Ring Competition Landing Mat Set

416-256 200cm x 200cm x 10cm supplemental throw mat for training

FIG COMPETITION PARALLEL BARS MAT CONFIGURATION

- (1) **J** 416-290 (6' 6 3/4" x 6' 6 3/4" x 20cm) | (200 x 200 x 20cm)
- (2) **I** 416-289 (6' 3 1/2" x 16' 6" x 20cm) | (191.77 x 502.9 x 20cm)
- (1) **X** 416-287 Ends (2' 2" x 4 1/4" x 20cm) | (66 x 129.5 x 20cm)
Center (2' 2 1/4" x 7' 10 3/4" x 20cm) | (66.6 x 240.6 x 20cm)
- (1) **Y** 416-291 (6' 6 3/4" x 6' 6 3/4" x 20cm) | (200 x 200 x 20cm)
- (1) **K** 416-288 (3' 4" x 6' 8" x 20cm) | (101.6 x 203.2 x 20cm)

416-286 FIG Parallel Bars Competition Landing Mat Set

416-595 and 416-256 are supplemental mats for training and warm-up hall, podium training and warming up in apparatus finals on podium

TRAINING MATS SKILL CUSHIONS



416-664

SC-8 & SC-12 SKILL CUSHIONS

These mats are used teaching aids for skill development during training and practice sessions.

- Meets USAG, NCAA® and NFHS competition specifications
- All mats consist of 50 ILD polyurethane except "Softy" (416-006), which uses 32 ILD
- Constructed with 18 oz. vinyl cover
- Nylon mesh side panels breathe, allowing air to escape on landings
- Reinforced handles are attached for easy mobility

416-661 SC-8 4' x 6' x 8" (1.2m x 1.8m x 20cm)

416-206 SC-8 4' x 6' x 8" (1.2m x 1.8m x 20cm) "Softy"– Red Mesh

416-662 SC-8 4' x 8' x 8" (1.2m x 2.4m x 20cm)

416-663 SC-8 5' x 10' x 8" (1.5m x 3.0m x 20cm)

416-681 SC-8 7' x 10' x 8" (2.1m x 3.0m x 20cm)

416-669 SC-8 8' x 10' x 8" (2.4m x 3.0m x 20cm) Folding Mat

416-670 SC-8 6' x 12' x 8" (1.8m x 3.6m x 20cm)

416-006 SC-8 5' x 10' x 8" (1.5m x 3.0m x 20cm) "Softy"– Red Mesh

416-665 SC-12 5' x 10' x 12" (1.5m x 3.0m x 30cm)

416-664 SC-12 6' x 12' x 12" (1.8m x 3.6m x 30cm) Folding Mat



416-006
"Softy"– Red Mesh

STING MATS

This competition and training mat is both lightweight and versatile, providing extra cushioning for landings.

- Meets USAG, NCAA® and NFHS competition specifications
- Cover material is a lightweight navy stretch denim
- Foam is removable for easy cleaning of cover
- All mats are made with a core of 1 1/4" (32mm) PCA foam, except for 416-584 which is made with a 2" (5cm) prime polyurethane core
- Mats roll up for storage with hook and loop fastener straps

416-585 Sting Mat 3' 3 3/8" x 3' 3 3/8" x 1 1/2" (1m x 1m x 3.8cm)

416-582 Sting Mat 3' 3 3/8" x 6' 3/4" x 1 1/2" (1m x 2m x 3.8cm)

416-583 Sting Mat 4' 6" x 10' x 1 1/2" (1.5m x 3m x 3.8cm)

416-584 Sting Mat 6' 8" x 8' 4" x 2" (2.1m x 3m x 5cm)





416-582

FOLDING MATS

FOLDING MAT ORDER GUIDELINES

When ordering folding mats, please follow the simple four steps below.

Mat Style	Foam Filler	Panel Width	Folding Interval
EM 1.4-2	 1 3/8" cross-link polyethylene	2'	2'
IM 1.5	 1 1/2" laminated polyethylene	2'	2'

1. CHOOSE FOAM

- EM or IM Series

2. CHOOSE SIZE

Mat sizes for EM series

- 4' x 6' (1.2 x 1.8m)
- 4' x 8' (1.2 x 2.4m)
- 5' x 10' (1.5 x 3.0m)
- 6' x 12' (1.8 x 3.6m)

Mat sizes for IM series

- 4' x 6' (1.2 x 1.8m)
- 4' x 8' (1.2 x 2.4m)
- 4' x 10' (1.2 x 3.0m)
- 4' x 12' (1.2 x 3.6m)
- 5' x 10' (1.5 x 3.0m)
- 6' x 12' (1.8 x 3.6m)

3. CHOOSE FASTENER

- V0, V2 and V4 (placed on the ends of V2 mats)

4. CHOOSE COLOR

- See color charts at the side to select color options
- Rainbow mats come in repeating panels of royal blue, red, green and yellow
- Custom multi-colors available — see color guides below



4 x 8 Rainbow Mat

18 OZ. VINYL COLORS



Note: Colors shown in catalog and on website may not be an exact match. Please request a color swatch.



VELSTICK® WALL MOULDING

Adheres mats to the wall for safety and storage.

- Velstick® is a 2 3/4" (70mm) wide aluminum extrusion, with a 1 3/4" (44mm) wide plastic backed Velcro® insert in center channel
- Standard Velstick® comes with pile (loop) Velcro®
- Use to hang EM and IM model folding mats

422-504 Velstick® 4' (1.2m) Section

422-505 Velstick® 5' (1.5m) Section

422-506 Velstick® 6' (1.8m) Section

Velstick® and Velcro® are registered trademarks of the Velcro® companies. Velstick® is also available with hook Velcro®. Contact your local dealer or AAI for information.



HANDSTAND PUSH-UP MAT

- 2' X 3' working surface matches the specifications for Competition
- Soft enough to protect your head, but firm enough to give stability
- Anti-skid bottom helps prevent movement

470-155 Handstand Push-up Mat

AIRTRACK

AIR FLOOR

Height: 4" | Width: 6.5' | Lengths: 10', 20', 26', 33', 39' or 49'

- The AirFloor works perfectly for all floor exercise and tumbling passes which translates to less impact on the body and higher jumps.
- The AirFloor can be used on a regular solid surface, foam mat or on a spring floor depending on the type of sports, level and age. Be careful using the AirFloor on a solid surface: heavier users may bottom out when practicing high jumps. This can be prevented by adding a foam mat on top or underneath the AirFloor.
- Pressure is easily customized within seconds, while inflating and deflating is done in a single minute.
- After inflation, the AirFloor will maintain its pressure for hours.



RECOMMENDED FOR
 GYMNASTICS / RECREATIONAL GYM / PRE-SCHOOL GYMNASTICS / SCHOOL SPORTS / SHOW GROUPS / CHERLEADING / MARTIAL ARTS / FREERUNNING / SENIOR GYM / FITNESS / INDOOR TRAMPOLINE PARKS

REQUIRED



OV10 BLOWER

OR FOOTPUMP

INCLUDED



TRANSPORT BAG

USER MANUAL

AIR TRACK P2

Height: 8" | Width: 6.5' | Lengths: 20', 26', 33', 39' or 49'

- The AirTrack P2 is used best for takeoff purposes, not for landings unless 2 or more jumps are connected.
- Jumps can be repeated more often with less chance of overuse injuries than on traditional training equipment.
- The AirTrack P2 is relatively light and easily setup on any floor.
- Pressure is easily customized within seconds, while inflating and deflating is done within 4 minutes.
- After inflation, the AirTrack will maintain its pressure for hours without the noise of a constant blower.



RECOMMENDED FOR
 GYMNASTICS / RECREATIONAL GYM / PRE-SCHOOL GYMNASTICS / SCHOOL SPORTS / SHOW GROUPS / CHERLEADING / MARTIAL ARTS / FREERUNNING / SENIOR GYM / FITNESS / INDOOR TRAMPOLINE PARKS

REQUIRED



HITACHI BLOWER

INCLUDED



TRANSPORT BAG

USER MANUAL

AIR TRACK P3

Height: 13" | Width: 6.5' & 9.2' | Lengths: 20', 26', 33', 39' & 49'

- Soft impact and maximum jump heights is what the P3 provides. Combining the P3 with foam blocks, landing mats or other air products greatly increases the amount of training possibilities.
- The AirTrack P3 is thick enough to prevent elite level power tumblers from bottoming out, while being soft enough for pre-rec and recreational athletes.
- The rebound on air makes you jump higher and grants more precious air-time to work on your technique.
- The AirTrack P3 can be easily setup on any floor.
- Pressure is easily customized within seconds, while inflating and deflating is done within 4 minutes.
- After inflation, the AirTrack will maintain its pressure for hours without the noise of a constant blower.



COACHES CHOICE

RECOMMENDED FOR
 GYMNASTICS / RECREATIONAL GYM / PRE-SCHOOL GYMNASTICS / SCHOOL SPORTS / SHOW GROUPS / CHERLEADING / MARTIAL ARTS / FREERUNNING / SENIOR GYM / FITNESS / INDOOR TRAMPOLINE PARKS

REQUIRED



HITACHI BLOWER

INCLUDED



TRANSPORT BAG

USER MANUAL

* Blowers for AirTrack products sold separately

PROTECTIVE PADDING

ECONOMY SCORER'S TABLE

- Fits seminar tables with 2" thick tops, measuring 72" x 18" and 96" x 18"
- Pads are designed to fit tables 29" high, and come in lengths of 6 or 8 feet
- Mounting brackets can fit up to 2" thick top and are made of formed steel sheet and powder-coated

6' Table & padding

- 411-224 6' Economy Scorer's Table - Red
- 411-225 6' Economy Scorer's Table - Burgundy
- 411-226 6' Economy Scorer's Table - Green
- 411-227 6' Economy Scorer's Table - Navy
- 411-228 6' Economy Scorer's Table - Royal
- 411-229 6' Economy Scorer's Table - Purple
- 411-230 6' Economy Scorer's Table - Black

8' Table & padding

- 411-231 8' Economy Scorer's Table - Red
- 411-232 8' Economy Scorer's Table - Burgundy
- 411-233 8' Economy Scorer's Table - Green
- 411-234 8' Economy Scorer's Table - Navy
- 411-235 8' Economy Scorer's Table - Royal
- 411-236 8' Economy Scorer's Table - Purple
- 411-237 8' Economy Scorer's Table - Black

6' & 8' padding can be purchased without table



VINYL PADDING COLORS



2" POLYURETHANE WALL PADS*

- 2 7/16" (62mm) thick protective wall padding that can be permanently installed or removable *
- Constructed of 7/16" (11mm) O.S.B backing, 2" (5cm) 100 ILD polyurethane foam and 18 oz. vinyl cover
- Choose from a variety of standard colors
- Vinyl cover meets National Fire Protection Standard 701

Please contact AAI for ordering information.

DIGITAL GRAPHIC WALL PADS

All digital graphics are printed using state-of-the-art, six-color large format printers. Durable, vivid inks are designed to be long-lasting relative to the silk-screens and vinyl applications of the past. High resolution printing provides sharp image quality from any distance.

Please contact AAI for ordering information and specifications on custom digital graphics.



MOTOR DEVELOPMENT

FOLDING INCLINES

60" x 120" x 24"
(152 x 305 x 61cm)



24" x 48" x 14"
(61 x 122 x 36cm)



24" x 48" x 14"
(61 x 122 x 36cm)
Shown as block



60" x 84" x 18"
(152 x 213 x 46cm)



NON-FOLDING INCLINES

48" x 96" x 24"
(122 x 244 x 61cm)



48" x 72" x 16"
(122 x 183 x 41cm)



36" x 72" x 16"
(91 x 183 x 41cm)



INCLINES

AAI's most popular motor development shape!
A must for teaching rolls and other basic skills.

- Folding inclines double as spotting blocks
- Inclines available with firm top layer which provides extra stiffness for handsprings or soft top layer for more cushion



STANDARD FOAM / NON-FOLDING

- SDW100-1013** 24" x 48" x 14" (61 x 122 x 36cm) Orange/Purple
- SDW100-1004** 36" x 72" x 16" (91 x 182 x 40cm) Marine Blue/Yellow
- SDW100-1006** 48" x 72" x 16" (121 x 182 x 40cm) Red/Royal Blue
- SDW100-1005** 60" x 84" x 18" (152 x 213 x 46cm) Orange/Yellow
- SDW100-1008** 48" x 96" x 24" (121 x 244 x 61cm) Purple/Pink

FIRM FOAM / NON-FOLDING

- SDW100-1007** 24" x 48" x 14" (61 x 122 x 36cm) Orange/Purple
- SDW100-1002** 36" x 72" x 16" (91 x 182 x 40cm) Marine Blue/Yellow
- SDW100-1001** 48" x 72" x 16" (121 x 182 x 40cm) Red/Royal Blue
- SDW100-1021** 60" x 84" x 18" (152 x 213 x 46cm) Orange/Yellow
- SDW100-1015** 48" x 96" x 24" (121 x 244 x 61cm) Purple/Pink

STANDARD FOAM / FOLDING

- SDW100-1009** 24" x 48" x 14" (61 x 122 x 36cm) Orange/Purple
- SDW100-1000** 36" x 72" x 16" (91 x 182 x 40cm) Marine Blue/Yellow
- SDW100-1011** 48" x 72" x 16" (121 x 182 x 40cm) Red/Royal Blue
- SDW100-1018** 60" x 84" x 18" (152 x 213 x 46cm) Orange/Yellow
- SDW100-1016** 48" x 96" x 24" (121 x 244 x 61cm) Purple/Pink
- SDW100-1003** 60" x 120" x 24" (152 x 305 x 61cm) Lime/Royal Blue

FIRM FOAM / FOLDING

- SDW100-1014** 24" x 48" x 14" (61 x 122 x 36cm) Orange/Purple
- SDW100-1020** 36" x 72" x 16" (91 x 182 x 40cm) Marine Blue/Yellow
- SDW100-1010** 48" x 72" x 16" (121 x 182 x 40cm) Red/Royal Blue
- SDW100-1017** 60" x 84" x 18" (152 x 213 x 46cm) Orange/Yellow
- SDW100-1022** 48" x 96" x 24" (121 x 244 x 61cm) Purple/Pink
- SDW100-1012** 60" x 120" x 24" (152 x 305 x 61cm) Lime/Royal Blue

MOTOR DEVELOPMENT



OCTAGONS

• Fasteners connect shapes in a row for a variety of activities

480-288 Octagon 20" x 28" (51 x 71cm) – Lime/Marine Blue

480-289 Octagon 25" x 36" (63 x 91cm) – Purple/Pink

480-290 Octagon 30" x 36" (78 x 91cm) – Red/Green

480-307 Octagon 35" x 40" (89 x 102cm) – Marine Blue/Yellow



TRAPEZOIDS

• Now made with anti-skid material making it easier to separate without each piece sticking together

480-311 Trapezoid 48" x 48" x 36" – Royal Blue

480-335 Trapezoid 48" x 48" x 36" – Marine Blue/Black

480-336 Small Trapezoid 36" x 36" x 30" – Royal/Lime/Orange

GAGA IS A GREAT GAME TO ADD FOR BIRTHDAY PARTIES AT THE GYM CLUB!



WIDE & SHORT HURDLES FOR NINJA COURSES

Gaga is a co-ed sport that can be played by all ages. A different way to get up and moving. AAI® Gaga pit is for indoor use at gym clubs, schools and rec centers.

- Gaga is similar to dodge ball but played with a single ball. The game consists of dodging, running, jumping or striking the ball with the goal to be last person in the Gaga pit. Players hit the ball at each other using their hands, being eliminated if the ball strikes them on or below the knee. Gaga can be played by several individual players or in teams.

480-572 8' x 30" Gaga Wall **480-574** 12' Complete Gaga Pit

480-573 3' x 24" Gaga Wall **480-575** 14' Complete Gaga Pit

Custom colors available contact AAI at 1-800-247-3978



PLAY INDOORS



EASY TAKE APART



480-574

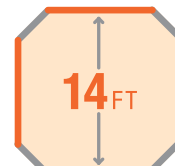

480-575

Customize your Gaga Pit size by adding additional sides to expand game area for larger groups.

DEVELOPMENT ACCESSORIES



PRESCHOOL TRAINING BAR

- Bar is made of 1" (25mm) OD steel tubing welded directly to the pistons for added stability
- Combo spin/snap lock allows for easy adjustment
- Four height settings ranging from 34" to 52" (86 to 132cm)
- Base covers an area of 52" (132cm) wide x 46 1/2" (118cm) deep
- Any 4' (122cm) wide mat can be used between uprights
- Suggested ages/weight: 2-7 years & limit is 50-75 lbs.

G407-668 Preschool Training Bar (Steel Bar)

G407-684 Preschool Training Bar (Laminate Bar)



ROUND PARALLETTE BARS

- Made of solid maple and bar is covered in a protective laminate coating
- Bar is 12" in length (30cm)
- Overall dimensions of 13 1/2" long x 4 1/2" tall x 8" wide (34 x 11 x 20cm)

405-220 Round Parallette Bars — Pair

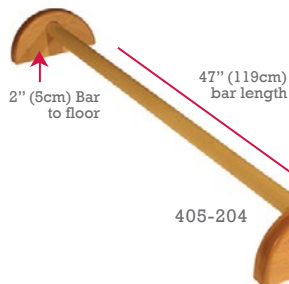

FLOOR TRAINING RAILS

- Wood end brace is 2" (5cm) wide x 9" long x 4 1/2" (11cm) high. Bar length of 47" (119cm)
- 1 1/2" (38mm) diameter rail fiberglass

405-204 2" Floor Training Rail

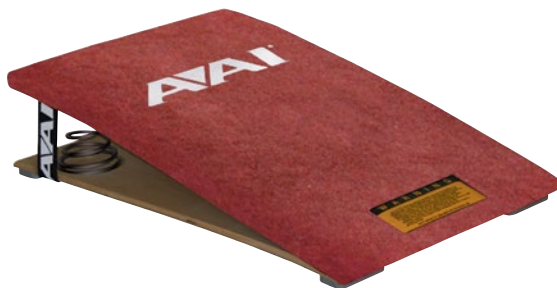

JUNIOR SPRING BOARD

- Board is constructed of 1/2" (13mm) 8-ply cross-grain maple and poplar plywood and padded with 1/4" (6mm) polyethylene foam with a carpeted surface
- Three wire springs across the front of the bottom board
- For children under 85 lbs. (39kg)

407-601 Junior Spring Board



SPOTTING BLOCK

- High density foam filler, with top and bottom layers of firm polyethylene foam add support for the instructor
- Firm inner core for added stability

416-048 Spotting Block 2' x 2' x 4' (61 x 61 x 122cm)

416-042 Spotting Block 2' x 1' x 4' (61 x 30 x 122cm)

416-169 Spotting Block 30" x 30" x 30" (76 x 76 x 76 cm) — Marine/Royal

DEVELOPMENT ACCESSORIES



JUNIOR BALANCE BEAMS

- Wood core construction and beam rests on wooden feet
- Working surface has 1/4" (.6cm) padding, with competition suede-like cover
- Top of beam is 5 1/2" (14cm) high and beam width is 4" (10cm)

406-223 Junior Balance Beam 8' (2.4m)

406-224 Junior Balance Beam 10' (3m)



TAC/10 & FOAM BALANCE BEAM

- 406-250 TAC/10 cover provides easy cleaning with excellent grip and durability
- 406-222 Durable suede cover provides authentic balance beam feel
- 4" (10cm) beam width provides the gymnast with a comfortable working surface
- Foam core is constructed using polyethylene foam

406-250 TAC/10 Foam Balance Beam 4" x 106" x 2" (10 x 269 x 5cm)

406-222 Foam Balance Beam 4" x 106" x 2" (10 x 269 x 5cm)



ELITE™ BALANCE STAND

- A great way to perfect body positions for balance beam
- Adjustable knob allows the athlete to develop at their own pace by increasing or decreasing the amount of stability to the platform
- Compact size lets you practice at home or in the gym

C405-406 Elite™ Balance Stand



ALPHA ROCKER

- Great tool for training handstand skills and strength that transfer not only to Rings but also Parallel Bars, and Beam
- Rocking motion helps focus on stabilizer muscles
- Portable and easy to move

407-048 Alpha Rocker



RING TRAINER

- Easy Set up with Adjustable belts (based off size)
- The Ring Trainer eliminates about 50% of your body weight to allow you to train multiple skills and work on that proper technique for each one.
- Great Tool for improving your upper body strength while having fun doing it
- Train Progressions from Pull Ups to the Iron Cross with the Ring trainer

405-296 Ring Trainer Small

405-297 Ring Trainer Medium

405-298 Ring Trainer Large

G2N™ GYMNASTICS MEETS NINJA



G2N™ CHALLENGES KIDS OF ALL AGES TO BE ACTIVE CREATIVE AND SKILLFUL. YOU CAN CALL IT WARRIOR, PARKOUR OR NINJA...WE CALL IT FUN!!

- Strong enough for adults, adaptable enough for children, and unique enough for Ninjas
- Built of high quality steel providing strength and durability
- Powder coated for durable clean appearance
- Conveniently mounts to the wall and folds out in minutes
- Individual (2 piece) units occupy 10' X 10' area with 12 different mounting heights for attachments
- Additional sections add challenges 10 square feet at a time
- Multiple attachments are easy to hang, adjust, or remove
- Rung pads included for safety

- 405-256 G2N™ Package 1*
- 405-257 G2N™ Package 2*
- 405-258 G2N™ Package 3*
- 405-259 G2N™ Package 4*
- 405-252 G2N™ Wall Unit - One Section
- 405-253 G2N™ Wall Unit - Two Section
- 405-232 G2N™ Cross Bar
- 405-233 G2N™ Solid Plank
- 405-235 G2N™ Climbing Wall - Pkg of 2
- 405-244 G2N™ Rung pads - Set of 23
- 409-560 G2N™ Throw Mat
4'9" x 10' V1 Black/Lime
- 405-242 G2N™ Ring Trainer - Small
- 405-240 G2N™ Ring Trainer - Medium
- 405-243 G2N™ Ring Trainer - Large
- 409-561 G2N™ Incline with Anti-skid

*See next page for package listings.

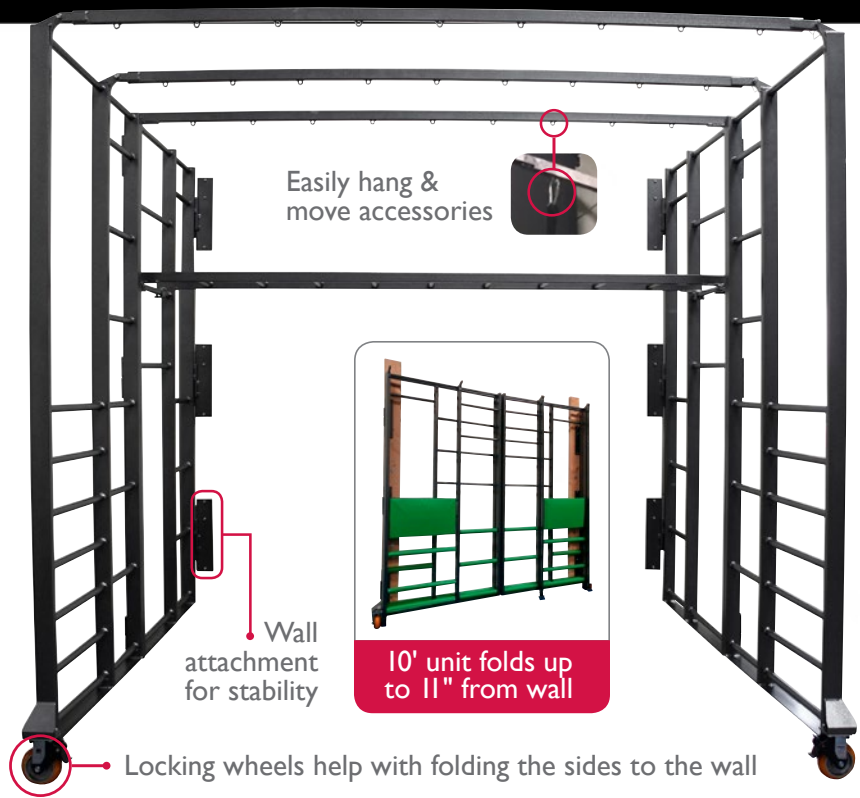

CREATE YOUR OWN OBSTACLE COURSES WITH MULTIPLE OPTIONS

- Ropes and rope steps
- Cargo Net
- Monkey bars
- Ring Trainer
- Rings
- Floating Plank
- Rockwall

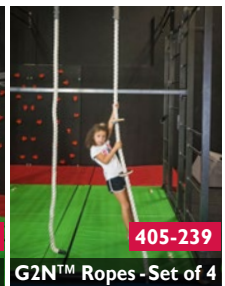
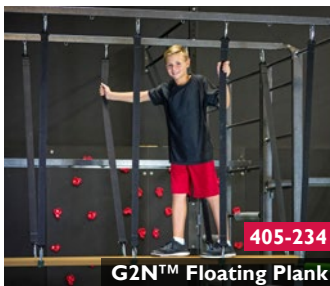
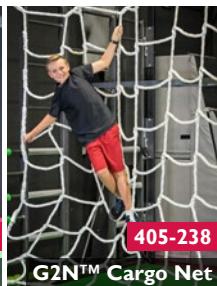

G2N™ PACKAGES



Throw Mat 4'9" x 10' V1 Black/Lime 409-560



G2N™ Freestanding uses additional bracing at top and bolted footing for stability.



405-241 Ladder Leg



408-236 Plank Leg

foot sold separately

G2N™ WALL-MOUNT PACKAGE AND FREESTANDING PACKAGES

405-256 NEW!! G2N™ Wall-Mount Package 1

405-280 NEW!! G2N™ Freestanding Package 1

• Includes: Wall Unit - One Section, Monkey Bars, 2 Cross Bars for additional attachments, Cargo Net, 4 Ropes, 4 Rings, Floating Plank, Solid Plank, Slide Bar with Rings, 2 Throw Mats, Ring Trainer - Small & Rung Pads

405-258 NEW!! G2N™ Wall-Mount Wizard Package 2

405-282 NEW!! G2N™ Freestanding Wizard Package 2

• Includes: Package One PLUS: Bolster Bag, Swinging Pipes, CBF & Wizard Warp Wall

405-305 NEW!! G2N™ Wall-Mount Master Package 2

405-302 NEW!! G2N™ Freestanding Master Package 2

• Includes: Package One PLUS: Bolster Bag, Swinging Pipes, CBF & Master Warp Wall

405-258 NEW!! G2N™ Wall-Mount Wizard Package 3

405-282 NEW!! G2N™ Freestanding Wizard Package 3

• Includes: Package Two PLUS: Bolster Bag, Swinging Pipes, CBF, Set of 4 Slanted Steps, 4 Piece Barrier & Wizard Warp Wall

405-305 NEW!! G2N™ Wall-Mount Master Package 3

405-302 NEW!! G2N™ Freestanding Master Package 3

• Includes: Package Two PLUS: Bolster Bag, Swinging Pipes, CBF, Set of 4 Slanted Steps, 4 Piece Barrier & Master Warp Wall

405-259 NEW!! G2N™ Wall-Mount Wizard Package 4

405-283 NEW!! G2N™ Freestanding Wizard Package 4

• Includes: Wall Unit - Two Section, Monkey Bars, Floating Monkey Bars, 4 Cross Bars for additional attachments, Cargo Net, 4 Ropes, 4 Rings, Floating Plank, Solid Plank, Slide Bar with Rings, 4 Throw Mats, Carpet Bonded Foam, Ring Trainer - Small, Wizard Warp Wall, 4 layer Barrier, Set of 4 Slanted Steps, & Rung Pads

405-306 NEW!! G2N™ Wall-Mount Master Package 4

405-303 NEW!! G2N™ Freestanding Master Package 4

• Includes: Freestanding Unit - Two Section, Monkey Bars, Floating Monkey Bars, 4 Cross Bars for additional attachments, Cargo Net, 4 Ropes, 4 Rings, Floating Plank, Solid Plank, Slide Bar with Rings, 4 Throw Mats, Carpet Bonded Foam, Ring Trainer - Small, Master Warp Wall, 4 layer Barrier, Set of 4 Slanted Steps, & Rung Pads

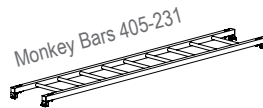

Climbing Wall (Pkg of 2) 405-235

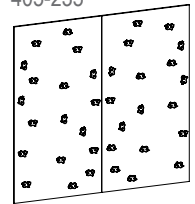

4 Layer Barrier 409-563



Rung pads (Set of 23) 405-244



Slanted Steps (Set of 4) 480-310



Wizard Warp Wall 405-055

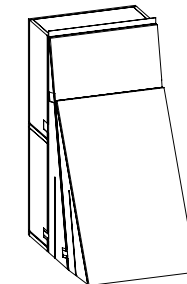

Carpet Bonded Foam

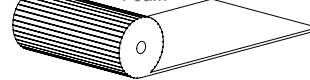

Master Warp Wall

551-988

551-998

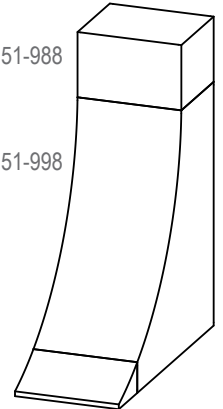

Floating Plank 405-234

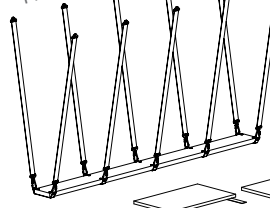

Rings (Set of 4) 405-237

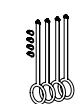

Ring Trainer (Small) 405-242

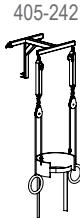

Ropes (Set of 4) 405-239

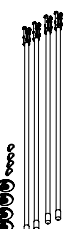

Cargo Net 405-238

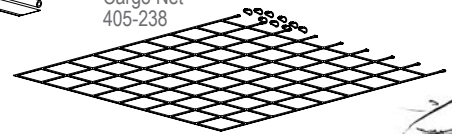

G2N™ ADD-ON ATTACHMENTS

KEEP ADDING TO THE FUN!



NEW

3 RING STRAP

- Hang, Climb & Swing your way Up And down on the 3 ring strap
- Gain Strength and Body Awareness while you hang in the air reaching from ring to ring

405-275 3 Ring Strap

NEW

BOLSTER BAG

- The bolster bag provides a great deal of fun while your trying to jump onto it and catch it while it swings across the slide pole
- The padding provides the right amount of grip to allow you to hang onto the bag and maneuver off of it as you desire

405-290 Bolster Bag

NEW

FLOATING MONKEY BARS



- Floating monkey bars create endless angles of fun and challenges for all levels
- Use strap extensions to create a flat angle, or make it more challenging by turning it more vertical for the more advanced
- The angle of the ladder provides each athlete the challenge to make it constantly fun

405-292 Floating Monkey Bars



NEW

SWINGING PIPES

- The swinging pipes are fun for all ages
- Keep your set up nice and even, or mix up the straps to make it more difficult. Whatever you choose the swinging pipes will help all kids learn balance, strength and body awareness as they move through the different logs

405-294 Swinging Pipes



NEW

STEPPING SWING

- Use a double strap on each step side to reduce swing or a single strap on each side to increase swing between steps
- The stepping swing are fun for all ages

405-295 Stepping Swing - each

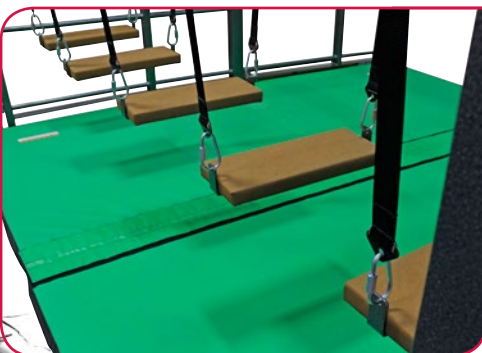

WHO DOESN'T JUST WANT TO SWING

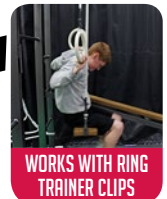

WORKS WITH RING TRAINER CLIPS

G2N™ OBSTACLES & CURRICULUM

G2N™ MASTER WARP WALL

551-998 G2N™ Master Warp Wall
551-988 G2N™ Master Warp Wall Top Block



G2N™ WIZARD WARP WALL

405-055 G2N™ Wizard Warp Wall



G2N™ OCTAROCK



480-315 G2N™ Large Octarock

480-314 G2N™ Medium Octarock

480-313 G2N™ Small Octarock

- Without the use of hook fasteners G2N™ obstacles are easier and faster to move around when changing up the course
- Made with 18oz vinyl and polyethylene foam for durability and easy cleaning
- Anti-skid material keeps the shapes from moving on the floor or when stacked

G2N™ BARRIER

- Available in 3 different configurations
- No attachments make the barrier easy to break down



409-572 G2N™ Barrier - 2 pieces

409-568 G2N™ Barrier - 3 pieces

409-563 G2N™ Barrier - 4 pieces

G2N™ BALANCE SERIES

Customize your own ninja courses with AAI's G2N™ package or individual pieces.

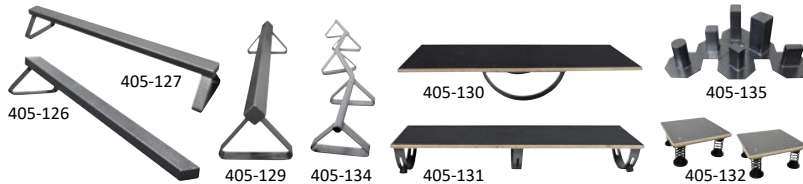

405-126 G2N™ Angled Beam

405-127 G2N™ Balance Beam

405-129 G2N™ Tipped Beam

405-130 G2N™ Rockertable

405-131 G2N™ Balance Board

405-132 G2N™ Quad Spring Board

405-134 G2N™ Snake Run

405-135 G2N™ Steel Stairs (Set of 6)



G2N™ SLANTED STEPS

- Buy individually or as a set of 4

480-309 G2N™ Slanted Steps - Each

480-310 G2N™ Slanted Steps - Set of 4

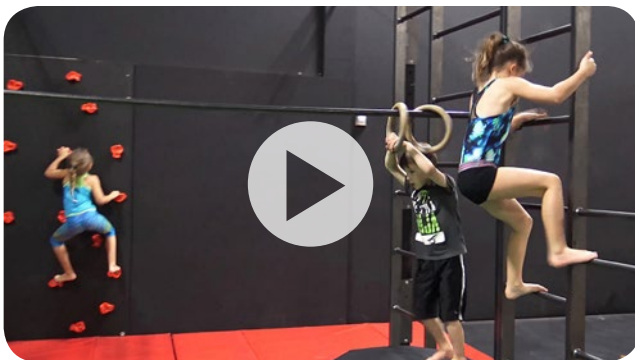

G2N™ OFFERS A COMPREHENSIVE CURRICULUM THAT INCORPORATES FUNDAMENTAL GYMNASTICS CONCEPTS WITH PHYSICAL FITNESS COMPETENCIES.

- The 8 week curriculum offers a turn key program to facilities. It comes with detailed weekly written lesson plans as well as training videos for the staff to ensure consistency within the program.

THE G2N™ CURRICULUM OFFERS FACILITIES:

- Turn key program for the staff
- An additional profit center
- A program that helps with member retention

THE G2N™ CURRICULUM TEACHES KIDS:

- STRENGTH
- ENDURANCE
- BALANCE
- FLEXIBILITY
- SKILL DEVELOPMENT
- FUN

ELITE™ KIDS GYM



The AAI® ELITE™ Kids Gym line teaches beginning gymnastics, a favorite for instructors and children ages 2-12. This skill development apparatus is made from the same quality materials and craftsmanship as AAI® competitive equipment, and can be tailored to meet the needs of your gym with multiple circuit configurations. Additionally, a wide range of accessories offers versatility for all types of preschool and recreational programs. Contact AAI to create your custom circuit at 800-247-3978.



FOUR-STATION CIRCUIT

405-355 Includes: Uneven Bars, Rings, Parallel Bars, High Bar (steel) & Mats

405-350 Includes: Uneven Bars, Rings, Parallel Bars, High Bar (laminated) & Mats

The Four-Station ELITE™ KIDS GYM Circuit requires a floor space 16' 8" x 16' 8" (5.1 x 5.1m) square.



INLINE CIRCUIT

405-376 Includes: Rings, Uneven Bars, Parallel Bars, High Bar (steel) & Mats

405-351 Includes: Uneven Bars, Rings, Parallel Bars, High Bar (laminated) & Mats

The ELITE™ KIDS GYM Inline Circuit requires a floor space of 75" wide x 72" deep (191 x 183cm) for the first unit and 68" wide x 72" deep (173 x 183cm) for each additional unit

ELITE™ KIDS GYM BENEFITS:

- Heavy-Duty tubular steel uprights are powder coated with an orange gloss finish
- Tubular aluminum pistons are powder coated with a silver finish
- Uprights adjust in 3" (75mm) increments
- Fiberglass bars are covered in a wood veneer finish
- Accommodate up to 8" (20cm) landing mat 5' x 10' mat (1.5 x 3m)
- Suggested weight limit for Elite™ Kids Gym apparatuses and accessories is 100-150 lbs

ELITE™ KIDS GYM MATS

- Designed to be used as teaching aids during training and practicing

416-333 4" ELITE™ KIDS GYM Four Circuit Mat Set* - center mat included**

416-334 4" ELITE™ KIDS GYM Four Circuit Center Mat - Yellow**

416-335 4" ELITE™ KIDS GYM Inline Circuit Mat Set*

416-336 4" ELITE™ KIDS GYM 5' x 10' V2 Purple Mat*

416-337 4" ELITE™ KIDS GYM 5' x 10' V2 Lime Green Mat*

416-338 4" ELITE™ KIDS GYM 5' x 10' V2 Marine Blue Mat*

416-339 4" ELITE™ KIDS GYM 5' x 10' V2 Pink Mat*

405-330 ELITE™ KIDS GYM CBF Upright Padding

405-385 ELITE™ KIDS GYM Vinyl Upright Padding

* Units are 5' x 10' x 4" (1.5m x 3.0m x 10cm)

** Units are 49½" x 49½" x 4" (126 x 126 x 10cm)



Circuit Center Mat



5' x 10' V2 Mats



Vinyl Upright Padding



CBF Upright Padding

ELITE™ KIDS GYM



ELITE™ KIDS GYM SWING

- Connects to the ELITE™ Kids Ring Tower using a quick link with a thimble and rope clamp

405-340 ELITE™ KIDS GYM Swing



ELITE™ KIDS GYM TRAPEZE

- Includes two adjustable straps to connect with the ELITE™ Kids Ring Tower (equipment sold separately)
- Adjustable straps made from 1" (25mm) webbing with welded D-rings

405-342 ELITE™ KIDS GYM Trapeze



ELITE™ KIDS GYM CLIMBING ROPE

- Connects to the ELITE™ Kids Ring Tower using a quick link with a thimble and rope clamp

405-341 ELITE™ KIDS GYM Climbing Rope

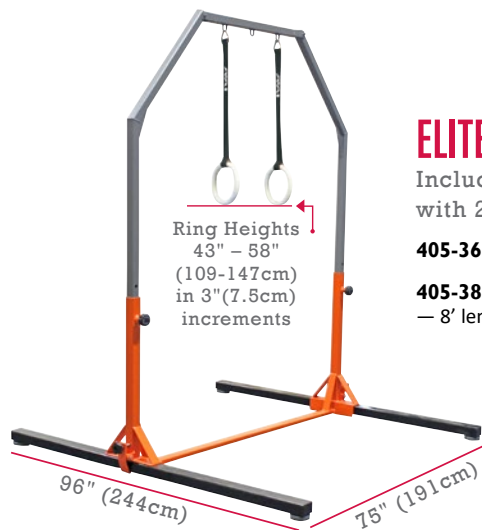

ELITE™ KIDS GYM RINGS SET

Includes regular competition rings with 2" (5cm) wide nylon straps.

405-360 ELITE™ KIDS GYM Rings Set

405-387 ELITE™ KIDS GYM Long Base — 8' length for use w/Ring Set



The ELITE™ KIDS GYM Swing, ELITE™ KIDS GYM Climbing Rope and ELITE™ KIDS GYM Trapeze can also be added to the G2N™ Wall-Unit and Freestanding packages.

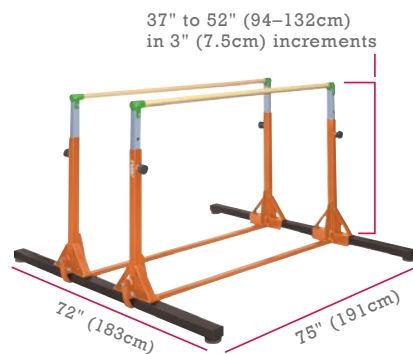

ELITE™ KIDS GYM PARALLEL BARS SET

405-359 ELITE™ KIDS GYM Parallel Bars Set

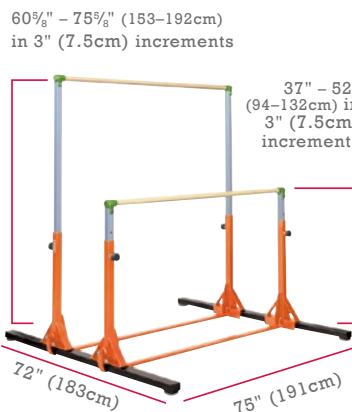

ELITE™ KIDS GYM UNEVEN BARS SET

405-356 ELITE™ KIDS GYM Uneven Bars Set

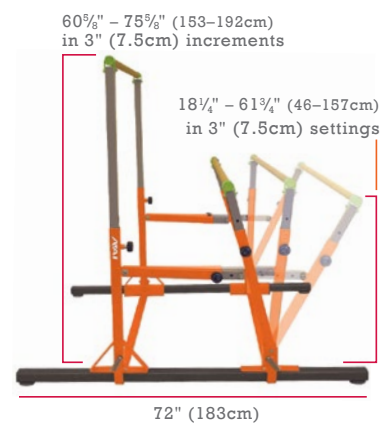

ELITE™ KIDS GYM ADJUSTABLE SPREADER UNEVEN BARS

405-390 ELITE™ KIDS GYM Adjustable Spreader Uneven Bars

ELITE™ KIDS GYM



ELITE™ KIDS GYM HORIZONTAL BAR SET

Comes in two models, one with a wood laminate finish and one with a steel bar.

405-357 ELITE™ KIDS GYM Horizontal Bar Set – Laminate Bar

405-396 ELITE™ KIDS GYM Low Horizontal Bar Set – Laminate Bar

405-358 ELITE™ KIDS GYM Horizontal Bar Set – Steel Bar

ELITE™ KIDS GYM MONKEY BARS

- Constructed of rectangle and round tubing with a rubber base to prevent slipping
- Includes hardware attachments for use with ELITE™ Kids High Bar (equipment sold separately)

405-345 ELITE™ KIDS GYM Monkey Bars



MAKE YOUR OWN COMBO!

ELITE™ KIDS GYM SLIDE

- Made from polyethylene foam with an outside dimension of 18" (46cm)
- Includes hardware attachments for use with ELITE™ Kids Low Bar Uprights or Parallel Bars (equipment sold separately)
- Designed to only be used with the ELITE™ Kids Climbing Wall or Cargo Net but not alone

405-343 ELITE™ KIDS GYM Slide

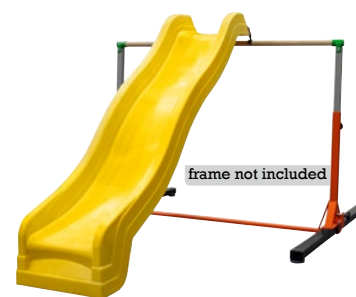

ELITE™ KIDS GYM CLIMBING WALL

- Constructed of 3/4" (19mm) plywood with waffle-weave textured overlay and polyethylene-molded rocks with easy grip texture
- Includes hardware attachments for use with the ELITE™ Kids Low Bar or Parallel Bars (equipment sold separately)
- Designed to only be used with the ELITE™ Kids Cargo Net or Slide but not alone

405-344 ELITE™ KIDS GYM Climbing Wall

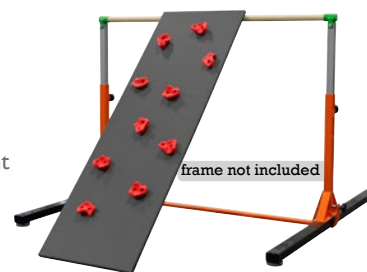

ELITE™ KIDS GYM CARGO NET

- Constructed of 1" (25mm) sewn webbing, attached to the base holder with sewn loops
- Base holder is made of round tubing and flat bar stock and powder-coated for long life
- Includes hardware attachments for use with the ELITE™ Kids Low Bar or Parallel Bars (equipment sold separately)
- Designed to only be used with the ELITE™ Kids Climbing Wall or Slide but not alone
- Cargo net only fits the inline circuit or individual station

405-346 ELITE™ KIDS GYM Cargo Net



CUSTOMIZE YOUR GYM

MATCH YOUR TEAM COLORS!

AAI can customize mats and skill shapes of 18oz vinyl with your team colors. Pick from our 15 vinyl color options at no extra charge.

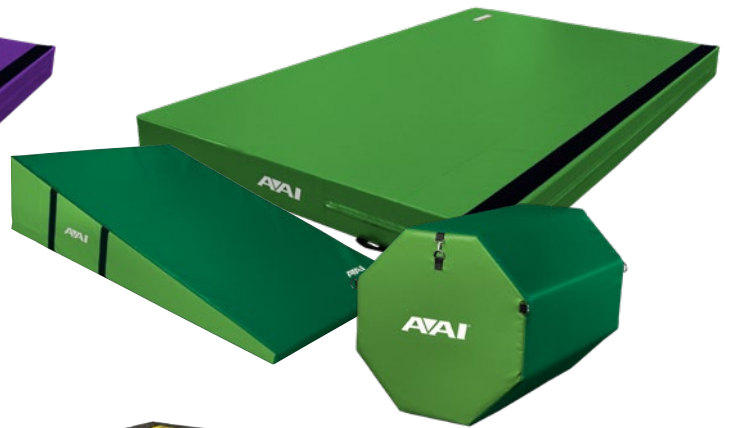

PUT YOUR LOGO ON IT!

AAI can screen your gym's logo onto the mats and skill shapes.

Artwork Requirements

File Type: .AI, .EPS or .PDF



CHOICE IN COLORS

Custom color powder coat colors on beams, bars and rings and other metal apparatus.



STANDARD POWDER-COAT FINISH OPTIONS

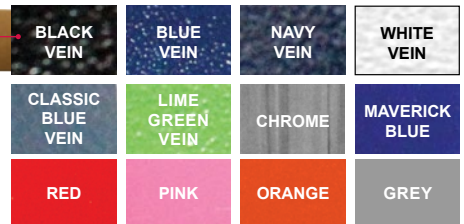

*All custom color product sales are final and more colors available for up-charge.

GYM DESIGN

AAI can help design a gym whether you're starting from scratch or remodeling a gym.

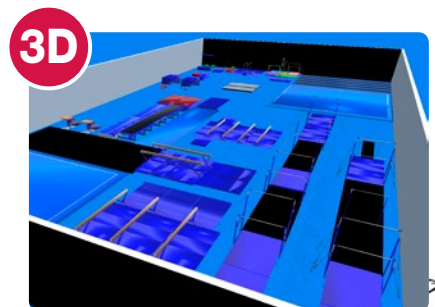
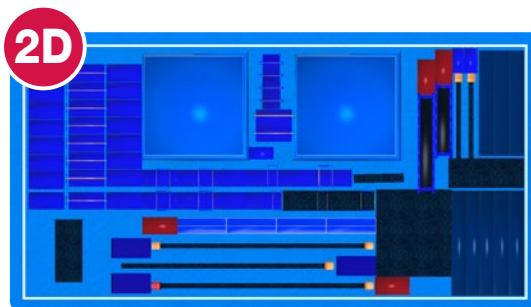

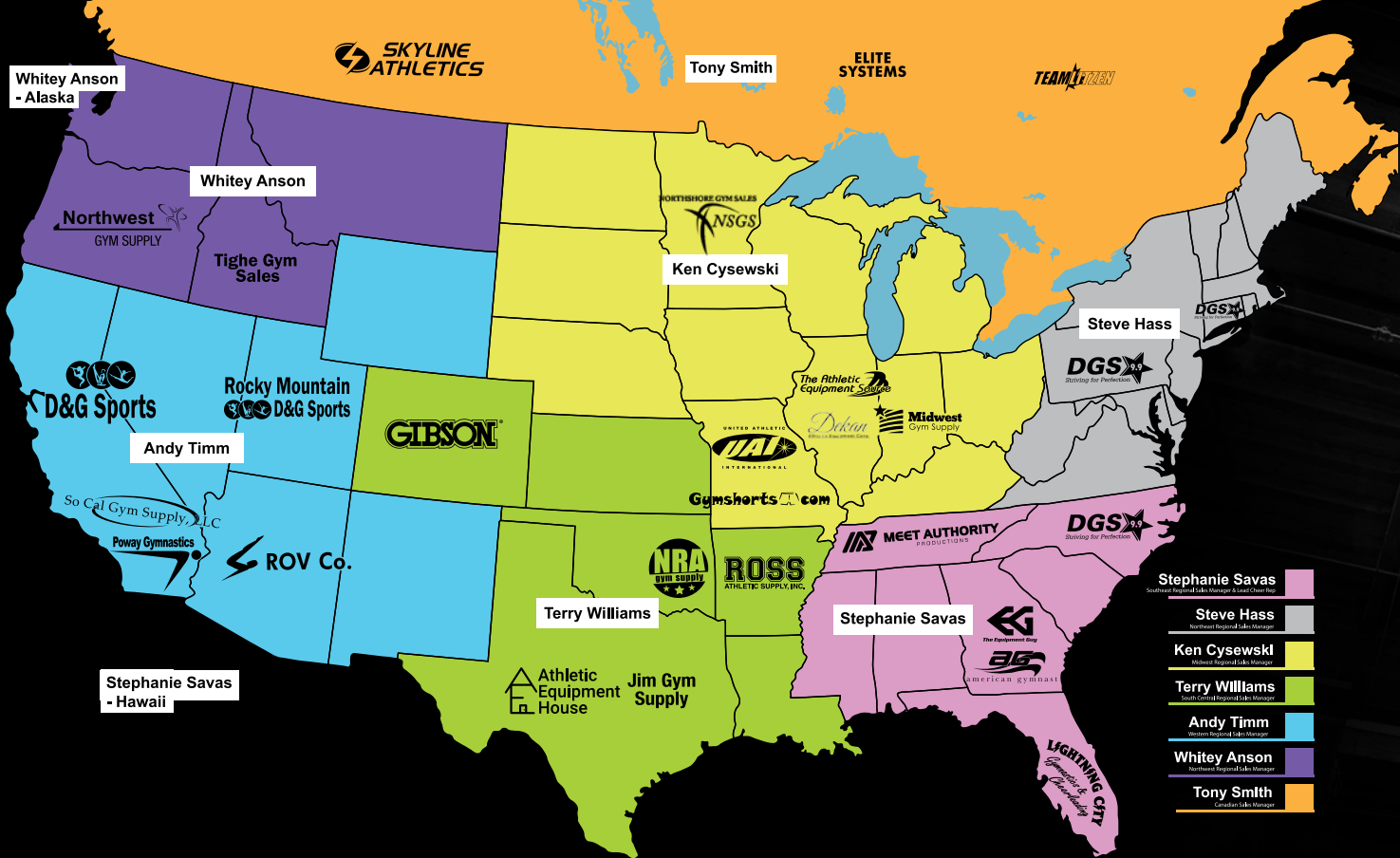

AAI WE ARE HERE FOR YOU

AMERICANATHLETIC.COM/GYMNASTICS
Email: AskAAI@americanathletic.com

200 American Ave. | Jefferson, IA 50129
{Toll Free} 800.247.3978 {Direct} 515.386.3125

CALIFORNIA PROPOSITION 65

Certain products in this catalog are subject to the California Safe Drinking Water and Toxic Enforcement Act of 1986, more commonly known as "Proposition 65." Proposition 65 requires clear and reasonable warnings for products that expose individuals in the State of California to a chemical known to the State to cause cancer, birth defects, and other reproductive harm. Applicable products shipped to California will have the following Warning (or other appropriate warning) affixed:

WARNING: This product contains chemicals known to the State of California to cause cancer, birth defects and other reproductive harm.

NBA®, WNBA, G-League, NCAA®, Final Four®, Truce™, Eurotramp® and Airtrack® are registered trademarks.

WARRANTY DETAILS

AAI warrants its products against defects in material and workmanship. Without charge, AAI will, at its option, either repair or replace any products shown to our satisfaction to be defective within one (1) year from receipt by customer, provided it is returned to the factory (after authorization), transportation prepaid. This warranty covers only products manufactured by AAI and does not extend to transportation, installation or replacement charges incurred by customer; nor does it apply to products or components of another manufacturer appearing in this catalog or used in conjunction with AAI products according to the terms here of and standards acceptable in AAI's industry.

This warranty is exclusive and in lieu of any other express or implied warranties, including but not limited to any implied warranty of merchantability or fitness for particular purpose.

Modification of AAI products renders the warranty void and could create a risk of severe personal injury. Abuse, misuse, abnormal usage, faulty installation, improper maintenance or unauthorized repairs are not covered under warranty. No obligations or liabilities exist on the part of AAI for consequential damages arising out of or in connection with the use or performance of the products.

ALSO AVAILABLE FROM OUR FACILITY

SPALDING

Official backboard supplier to:



BASKETBALL | GYMNASIUM | VOLLEYBALL
SPALDINGEQUIPMENT.COM | 800-435-3865

© 2019 Russell Brands, LLC.