

---

# GYMNASTICS CATALOG

---



COMPETITION & TRAINING  
Apparatus and Allied Equipment

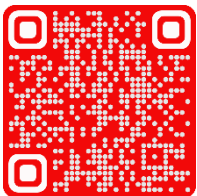

URL

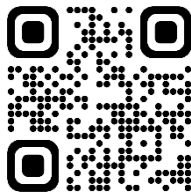

MSME Mart Online Store

**STANDARD SPORTS INDUSTRIES PVT. LTD.**

36-2, Dhandekar Industrial Estate, Kondhwa, Pune 411 048 (MH)

88063 96501 / 94033 21450 / stan\_sports@rediffmail.com / <https://www.ssipl.info>

MSME Reg.: UAM: MH26A0017422 / URN: UDYAM-MH-26-0107528

## A BRIEF INTRODUCTION

**STANDARD SPORTS INDUSTRIES PVT. LTD.** was incorporated in 1986 by Late Mr. Ashok Grover and today is one of the leading manufacturers, distributors and suppliers of Gymnastics Competition and Training equipment to the Indian Defence Forces, Government Sporting Departments, Schools and other reputed institutions in India.

With over 40+ years of dedicated service in the field of sports and fitness, has seen the company grow from a small backyard workshop to a fully-fledged manufacturing unit. Being in the field of Gymnastics over the years, has given us the expertise and has evolved our brand **PHYSIQUE** to one of the best manufacturers for gymnastic equipment's in India and are known for incorporating some of the best materials in our manufactured products.

Our knowledge, experience and expertise in gymnastics has given us the opportunity to collaborate with brands like **American Athletic Instruments (AAI) – USA; Eurotramp – Germany; BagJump – Austria; Gaofei - China** and also our manufactured equipment under the branding  which has now become one of the noted brands in the country.

We provide the following services and solutions



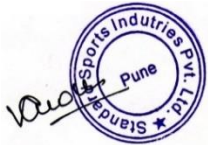

- FIG Approved Gymnastics equipment from AAI, USA
- FIG Approved Trampolines from Eurotramp, GmbH
- Budget friendly FIG Approved equipment from Gaofei, China.
- MAGA recommended
- Complete Turn-Key Solutions for centers ranging from toddlers to FIG competition Arenas.
- Allied equipment and coaches testing and evaluation tools.
- Complete design of centers offering the best solutions.

We take pride in our production and the solutions we have to offer. We are your ONE-STOP Gymnastics Shop.



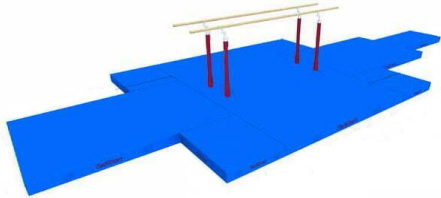

Thank You.



Varun Grover  
Director. 0091 88063 96501





<b>1001</b>	<b>Competition Parallel Bars: Conforming to FIG Specifications</b>	
	<ul style="list-style-type: none"> <li>• <b>1001A:</b> 'PHYSIQUE' FIG Spec. Fiber Glass with wood veneer finish</li> <li>• <b>1001B:</b> 'PHYSIQUE' Multi-Laminated wooden bars with 16mmØ bar insert</li> <li>• Bar Length: 350 cm</li> <li>• Height Adjustment: 160 cm – 210 cm</li> <li>• Width Adjustment: 42 cm – 62 cm.</li> <li>• 80mm x 40mm x 40mm stability weights in base</li> <li>• All hard chrome machined upright with FIG height markings.</li> <li>• Extra heavy weighted uprights.</li> <li>• <b>**FIG Approved Bars optionally available.</b></li> </ul>	
<b>1002</b>	<b>Low Parallel Bars:</b>	
	<ul style="list-style-type: none"> <li>• Bar Length: 350 cm</li> <li>• Height: 40 cms</li> <li>• Width Adjustment: 32cm – 52cm</li> <li>• Multi-Laminated wooden bars with 16mm Ø bar insert.</li> </ul>	
<b>1003</b>	<b>Kids Parallel Bars:</b>	
	<ul style="list-style-type: none"> <li>• Bar Length: 180 cm</li> <li>• Height Adjustable: 95 cm – 135 cm</li> <li>• Width Adjustable.</li> <li>• Fiber glass bars of 4cm Ø.</li> <li>• Quick width adjustments with T-bolts.</li> <li>• Quick height adjustments with spring loaded plungers.</li> </ul>	
<b>1004</b>	<b>Parallel Bar Competition Landing Mat Configurations: Conforming to FIG Specifications</b>	
	<ul style="list-style-type: none"> <li>• Size: 11m x 4.5m x 20cm</li> <li>• High Density PVC Covers</li> <li>• High Density and High Resilience HR40D PU Foam</li> <li>• Size and Quantity: 200cm x 100cm x 20cm x 01 nos. 300cm x 200cm x 20cm x 02 nos. 100cm x 125cm x 20cm x 04 nos. 300cm x 70cm x 20cm x 01 nos. 190cm x 300cm x 20cm x 02 nos.</li> </ul>	
<b>1005</b>	<b>Parallel Bar Training Blocks:</b>	
	<ul style="list-style-type: none"> <li>• Block size: 140 (L) x 50 (W) x 120 (H) cm,</li> <li>• Width Adjustment: 40 cm to 80 cms.</li> <li>• Steel frame core frame</li> <li>• Covered with HD-XPE 36kg<sup>3</sup> 1" foam.</li> <li>• Double Coated Nylon PVC Cover; non-tearing and washable.</li> </ul>	





## PARALLEL BARS: Competition & Allied

1006	<b>Crash Move Mat for Parallel Bars:</b>	
	<ul style="list-style-type: none"> <li>• Size: 150cm (L) x 90cm (W) x 15cm (H)</li> <li>• Marine Ply Core Covered with HD-XPE 36kg<sup>3</sup> foam of 2"</li> <li>• Double Coated Nylon PVC Cover; non-tearing and washable.</li> </ul>	
1007	<b>Spare Rails: 3.5m (L)</b>	
	<ul style="list-style-type: none"> <li>• Size: 3.5m (L) x 5cm Ø (Oval)</li> <li>• <b>1007A:</b> 'PHYSIQUE' Competition FIG Spec. Fiber Glass Rails with wood veneer.</li> <li>• <b>1007B:</b> 'PHYSIQUE' Multi-laminated wooden bars with 16mmØ bar.</li> <li>• <b>1007C:</b> <b>GAOFEI FIG Approved</b> Fiber Glass Rails with wood veneer.</li> </ul>	
1008	<b>Parallettes:</b>	
	<ul style="list-style-type: none"> <li>• Size: 40cm (L) x 4cm Ø x 1 pr.</li> <li>• Made from imported beechwood.</li> <li>• PU Finish.</li> <li>• The wooden Parallettes are lightweight, portable and great from gym use.</li> <li>• These bars can be used for various number of parallel bar and handstand drills, skills and conditioning.</li> </ul>	
1009	<b>Parallel Bar Spotting Platform:</b>	
	<ul style="list-style-type: none"> <li>• Size: 245cm x 25cm Platform</li> <li>• Height adjustable: 55 – 80cm</li> <li>• Hook mounting system on bars</li> <li>• Made from 18mm Marine ply with veneer covering</li> <li>• PU finish</li> </ul>	





## HORIZONTAL BARS: Competition & Allied

2001	<b>Competition Horizontal Bars: Conforming to FIG Specifications</b>	
	<ul style="list-style-type: none"> <li>• <b>2001A:</b> 'PHYSIQUE' Competition FIG Spec. Stainless Steel Bar with wire insert</li> <li>• <b>2001B:</b> 'PHYSIQUE' 28mmØ FIG Spec. Spring Steel Bar</li> <li>• Conforming to FIG Specification.</li> <li>• Height Adjustment: 270 cm – 305 cm</li> <li>• Bar Width: 240 cm</li> <li>• 35mmØ bar machined for height adjustments.</li> <li>• FIG height markings on adjuster bar</li> <li>• Includes mounting accessories i.e. wire rope, chain, turnbuckle, wire rope adjusters.</li> <li>• <b>**FIG Approved Bar optionally available.</b></li> </ul>	



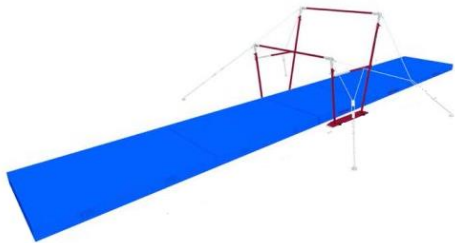

2002	<b>Multi Function Horizontal Bar:</b>	
	<ul style="list-style-type: none"> <li>• Height Adjustment: 80 cm – 280 cm</li> <li>• Bar Width: 240 cm</li> <li>• Bar Ø: 28mm heavy duty spring steel</li> <li>• Made from heavy gauge 80mm x 40mm x 3mm &amp; 100mm x 50mm x 3mm steel.</li> <li>• Spring loaded plunger for bar height adjustments.</li> <li>• T-Bolt spin lock for additional safety.</li> <li>• Includes mounting accessories i.e. Turnbuckles, Chain, Wire rope.</li> <li>• Floor Anchors Not Included.</li> </ul>	
2002-QRC	<b>Multi Function Horizontal Bar: <i>NEW &amp; IMPROVED</i></b>	
	<ul style="list-style-type: none"> <li>• <b>2002-QRC:</b> Single Bar Trainer with Quick Release System to interchange bars from 28mm steel bar to 4cm Uneven Bar.</li> <li>• Rapid tensioner system.</li> <li>• Includes 4cm Ø Fiber Glass Uneven Bar.</li> <li>• Spin knobs for bar collar mounts for quick change between Horizontal bar and Uneven Bar</li> <li>• Includes mounting accessories i.e. Turnbuckles, Chain, Wire rope.</li> <li>• Floor Anchors Not Included.</li> </ul>	
2003	<b>Kids Horizontal Bar:</b>	
	<ul style="list-style-type: none"> <li>• Height Adjustment: 140cm – 180cm</li> <li>• Rail Length: 180cms</li> <li>• Fiber glass bars of 4cm Ø.</li> <li>• Quick width adjustments with T-bolts.</li> <li>• Quick height adjustments with spring loaded plungers.</li> </ul>	
2004	<b>Low Single Trench Bar:</b>	
	<ul style="list-style-type: none"> <li>• Interchangeable bars from 28mm Ø and 4cm Ø</li> <li>• Height: 40 cm</li> <li>• Length: 240cm</li> <li>• 40cm Ø x 8mm thick base plate for firm stability.</li> <li>• Includes mounting accessories i.e. Turnbuckles, Chain, Wire rope.</li> <li>• Floor Anchors Not Included.</li> </ul>	
2005	<b>Horizontal Bar Competition Landing Mat Configuration: <i>Conforming to FIG Specifications</i></b>	
	<ul style="list-style-type: none"> <li>• Size: 12m x 2m x 20cm</li> <li>• High Density PVC Covers</li> <li>• High Density and High Resilience HR40D PU Foam</li> <li>• Size and Quantity: 300cm x 200cm x 20cm (4pcs)</li> </ul>	

<b>2006</b>	<b>Spare Bar for Horizontal Bars:</b>	
	<ul style="list-style-type: none"> <li>• Size: 2.4m (L) x 28mm<math>\varnothing</math></li> <li>• <b>2006A: 'PHYSIQUE' Competition FIG Spec. 28mm<math>\varnothing</math> Stainless Steel Bar with wire insert and collars.</b></li> <li>• <b>2006B: 'PHYSIQUE' 28mm<math>\varnothing</math> Spring Steel Bar with Collars</b></li> <li>• <b>2006C: GAOFEI FIG Approved Spring Steel Rail.</b></li> </ul>	
<b>2007</b>	<b>Release Move Mat for Horizontal Bar:</b>	
	<ul style="list-style-type: none"> <li>• Length: 140cm</li> <li>• Inner Width: 40mm</li> <li>• Thickness: 2"</li> <li>• Non-tearing cover with nylon handle.</li> </ul>	
<b>2008</b>	<b>Double Rebounder Rotation Trainer:</b>	
	<ul style="list-style-type: none"> <li>• High Bar Height: 95 – 130cm Adjustable</li> <li>• Low Bar Height: 30cm</li> <li>• Bar Length: 180cm</li> <li>• Bar <math>\varnothing</math>: 4 cm Fiber Glass Bar</li> <li>• Frame made of heavy gauge 50mm x 50mm steel tubes</li> <li>• Quick width adjustments with T-bolts.</li> <li>• Quick height adjustments using spring loaded plungers with height markings.</li> <li>• Bungee cord from Eurotramp provides ideal rebound.</li> <li>• 50cm x 4" <math>\varnothing</math> EVA foam rollers.</li> <li>• One upright can be removed to convert to a hand stand rebounder.</li> <li>• Floor levelers incorporated into the base.</li> </ul>	
<b>2009</b>	<b>Single Floor Rail:</b>	
	<ul style="list-style-type: none"> <li>• Size: 90cm (L) x 4cm <math>\varnothing</math></li> <li>• Made from imported beechwood.</li> <li>• PU Finish.</li> <li>• The wooden Parallettes are lightweight,</li> <li>• These bars can be used for various number of Horizontal bar and handstand drills, skills and conditioning.</li> </ul>	
<b>2010</b>	<b>Spotting Platform for Horizontal Bar:</b>	
	<ul style="list-style-type: none"> <li>• Platform Size: 100cm x 45cm</li> <li>• Height Adjustable: 140 – 180 cm</li> <li>• Made from 18mm Marine ply with veneer covering</li> <li>• 1" HD-XPE Foam covered with FIG PU Leather.</li> <li>• Hydraulic Based release system.</li> </ul>	



3001	<b>Competition Uneven Bars: Conforming to FIG Specifications</b>	
	<ul style="list-style-type: none"> <li>• <b>3001A: 'PHYSIQUE'</b> Competition FIG Spec. Fiber Glass with wood veneer finish.</li> <li>• <b>3001B: 'PHYSIQUE'</b> Multi-Laminated wooden bars with 16mm Ø bar insert</li> <li>• High Bar Height: 230 – 280cm</li> <li>• Low Bar Height: 150 – 200cm</li> <li>• Width: 110 – 1850cm</li> <li>• Bar Ø: 4cm</li> <li>• Bar Length: 240cm</li> <li>• All hard chrome machined upright with FIG height markings.</li> <li>• Shaft driven threaded width adjustment system with FIG markings.</li> <li>• Includes mounting accessories i.e. Turnbuckles, Chain, Wire rope.</li> <li>• Floor Anchors Not Included.</li> <li>• <b>**FIG Approved Bar optionally available.</b></li> </ul>	
3002	<b>Kids Uneven Bars / Asymmetrical Bars:</b>	
	<ul style="list-style-type: none"> <li>• Bar Ø: 4cm;</li> <li>• Bar length: 70cm;</li> <li>• Height adjustment of low bar: 95cm - 135cm in 5cm increments</li> <li>• Height adjustment of high bar is 155cm-195cm in 5cm increments</li> <li>• Width Adjustable.</li> <li>• Fiber glass bars of 4cm Ø.</li> <li>• Quick width adjustments with T-bolts.</li> <li>• Quick height adjustments using spring loaded plungers with height markings</li> </ul>	
3003	<b>Uneven Bars Competition Landing Mat Configuration: Conforming to FIG Specifications</b>	
	<ul style="list-style-type: none"> <li>• Size: 14m x 2m x 20cm</li> <li>• High Density PVC Covers</li> <li>• High Density and High Resilience HR40D PU Foam</li> <li>• Size and Quantity 300cm x 200cm x 20cm (4pcs) 200cm x 200cm x 20cm (1pcs)</li> </ul>	
3004	<b>Spare Rails for Uneven Bars:</b>	
	<ul style="list-style-type: none"> <li>• Size: 2.4m (L) x 4cm Ø</li> <li>• <b>3004A: 'PHYSIQUE'</b> Competition FIG Spec. Fiber Glass Rails with wood veneer.</li> <li>• <b>3004B: 'PHYSIQUE'</b> Multi-laminated wooden bars with 16mmØ bar.</li> <li>• <b>3004C GAOFEI FIG Approved</b> Fiber Glass Rails with wood veneer.</li> </ul>	
3005	<b>Release Move Mat for Uneven Bar:</b>	
	<ul style="list-style-type: none"> <li>• Length: 140cm</li> <li>• Inner Width: 40mm</li> <li>• Thickness: 2"</li> <li>• Non-tearing cover with nylon handle.</li> </ul>	

<b>3006</b>	<b>Spotting Platform for Uneven Bars:</b>	
	<ul style="list-style-type: none"> <li>Platform Size: 100cm x 45cm</li> <li>Height Adjustable: 140 – 180 cm</li> <li>Made from 18mm Marine ply with veneer covering</li> <li>1" HD-XPE Foam covered with FIG PU Leather.</li> <li>Hydraulic Based release system.</li> </ul>	



<b>4001</b>	<b>Competition Balance Beam: Conforming to FIG Specifications</b>	
	<ul style="list-style-type: none"> <li>Beam length: 500cm;</li> <li>Upper width: 10cm;</li> <li>Beam Height: 16cm.</li> <li>Height Adjustment: 70 cm – 125 cm in 5 cm increments.</li> <li>FIG Approved PU Leather cover on 10mm HD-XPE foam with wood core.</li> </ul>	
<b>4002</b>	<b>Low Balance Beam:</b>	
	<ul style="list-style-type: none"> <li><b>4002A</b> 5m / 16.5' (L) x 30cm (H)</li> <li><b>4002B</b> 3m / 10' (L) x 30cm (H)</li> <li>5m (L) Beam top conforming to FIG Specifications.</li> <li>FIG Approved PU Leather cover on 10mm HD-XPE foam with wood core.</li> <li>Floor levelers on base.</li> </ul>	
<b>4003</b>	<b>Foam Balance Beam:</b>	
	<ul style="list-style-type: none"> <li><b>4003A</b> 4m (L) x 300mm (B/W) x 200mm (T/W) x 300mm (H)</li> <li><b>4003B</b> 2.5m (L) x 250mm (B/W) x 150mm (T/W) x 100mm (H)</li> <li>Made with a combination of HD-XLPE and HR-PU foam.</li> <li>Double coated nylon PVC cover; non-tearing and washable.</li> <li>PU Leather Strip on beam top.</li> <li>** (B/W = Bottom Width; T/W = Top Width)</li> </ul>	
<b>4004</b>	<b>Balance Beam Surface Widener:</b>	
	<ul style="list-style-type: none"> <li>Size: 250cm (L) x 20cm (W)</li> <li>Board top made from high density foam and non-skid leatherette cover</li> <li>Features: Special safety belt to be fixed on the balance beam surface, suitable for junior practitioners.</li> </ul>	
<b>4005</b>	<b>Soft Mat for Beam:</b>	
	<ul style="list-style-type: none"> <li>Size: 2.5m (L) x 40 cm (W) x 2 cm (T)</li> <li>Good Stability, Easy to install, appropriate flexibility</li> <li>FIG PU Leather top which provides authentic Beam feel.</li> <li>Anti-Slip underlay.</li> <li>Velcro Attachments.</li> </ul>	



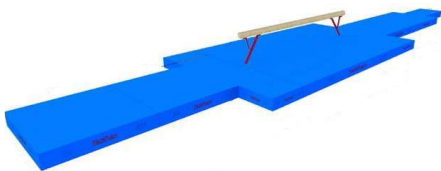





## BALANCE BEAM: Competition & Allied





4006	<b>Balance Beam Competition Landing Mat Configuration: Conforming to FIG Specifications</b>	
	<ul style="list-style-type: none"> <li>• Size: 18m x 4m x 20cm</li> <li>• High Density PVC Covers</li> <li>• High Density and High Resilience HR40D PU Foam</li> <li>• Size and Quantity: 200cm x 200cm x 20cm (1pcs), 300cm x 200cm x 20cm(3pcs), 100cm x 100cm x 20cm (4pcs), 250cm x 200cm x 20cm(4pcs), 200cm x 100cm x 20cm (1pc)</li> </ul>	





## RING FRAME: Competition & Allied

5001	<b>Competition Rings: Conforming to FIG Specifications</b>	
	<ul style="list-style-type: none"> <li>• <b>'PHYSIQUE'</b> Competition Fiber Glass with wood veneer finish</li> <li>• Size: 590cm (H)</li> <li>• Distance Between Columns: 316 cm</li> <li>• Distance Between rings: 50 cm</li> <li>• FIG Fiber Glass Rings with wood veneer finish and good moisture absorption.</li> <li>• Damping device incorporated in ring frame.</li> <li>• Includes mounting accessories i.e. wire rope, chain, turnbuckle, wire rope adjusters</li> <li>• Floor Anchors Not Included.</li> <li>• <b>**FIG Approved Rings optionally available.</b></li> </ul>	
5002	<b>Kids Rings:</b>	
	<ul style="list-style-type: none"> <li>• Ring diameter: 16cm Fiber Glass Rings.;</li> <li>• Ring height adjustment: 110 cm – 150 cm in 5 cm increments.</li> <li>• Quick width adjustments with T-bolts.</li> <li>• Quick height adjustments with spring loaded plungers.</li> </ul>	
5003	<b>Arm Strength Trainer:</b>	
	<ul style="list-style-type: none"> <li>• Size: 250 cm (L) x 60 cm (W) x 75 – 125 cm (H).</li> <li>• Size of the sliding board: 70 x 35 cm, covered with PVC cloth, inner is plywood board and XPE Foam.</li> <li>• Equipped with bearing loaded rolling devices</li> <li>• Rings are fiber glass</li> <li>• Features: Smooth sliding, flexible height adjustment, and stable standing.</li> </ul>	







<p><b>5004</b></p>	<p><b>Wall Mounted Rings:</b></p> <ul style="list-style-type: none"> <li>• 28mmØ Fiber Glass rings.</li> <li>• Arm length: 180cm, rings' distance: 50cm.</li> <li>• Rings are made of fiber glass with wood veneer.</li> <li>• Height adjustment scope from rings to the ground is 50cm-275cm, adjustable.</li> </ul>	
<p><b>5005</b></p>	<p><b>Ring Frame Competition Landing Mat Configuration: Conforming to FIG Specifications</b></p> <ul style="list-style-type: none"> <li>• Size: 5m x 2m x 20cm</li> <li>• High Density PVC Covers</li> <li>• Combination of High Resilience PU Foam of 40D and High Density EPE foam.</li> <li>• Size and Quantity: 300cm x 200cm x 20cm (1pcs), 100cm x 200cm x 20cm (2pcs)</li> </ul>	
<p><b>5006</b></p>	<p><b>Ring Trainer:</b></p> <ul style="list-style-type: none"> <li>• Easy Set up with Adjustable belts (based off size)</li> <li>• The Ring Trainer eliminates about 50% of your body weight to allow you to train multiple skills and work on that proper technique for each one.</li> <li>• Great tool for improving your upper body strength while having fun doing it</li> <li>• Train Progressions from Pull Ups to the Iron Cross with the Ring trainer</li> </ul>	
<p><b>5007</b></p>	<p><b>Spare Rings:</b></p> <ul style="list-style-type: none"> <li>• <b>5007A:</b> 'PHYSIQUE' Competition Fiber Glass Rings with wood veneer finish</li> <li>• <b>5007B:</b> GAOFEI FIG Approved Fiber Glass Rings with wood veneer finish</li> <li>• Includes Rings; Leather Strap; Wire Rope and swivel.</li> </ul>	
<p><b>5008</b></p>	<p><b>Cross Brace Trainer:</b></p> <ul style="list-style-type: none"> <li>• Size: 35 cm x 18 cm.</li> <li>• The elastic band adopts nylon rubber, and the wide elastic band is built in the framework. Medium elasticity makes arm touching comfortable.</li> <li>• The framework is welded by high-quality carbon steel tube and hooks, equipped with special hanging device</li> </ul>	

<b>5009</b>	<b>Spotting Platform for Rings:</b>	
	<ul style="list-style-type: none"> <li>• 100cm x 45cm Platform</li> <li>• Height Adjustable: 140 – 180 cm</li> <li>• Made from 18mm Marine ply with veneer covering</li> <li>• 1" HD-XPE Foam covered with FIG PU Leather.</li> <li>• Hydraulic Based release system.</li> </ul>	

<b>6001</b>	<b>Competition Pommel Horse: Conforming to FIG Specifications</b>	
	<ul style="list-style-type: none"> <li>• Fiberglass pommels with adjustable aluminum base and studs.</li> <li>• Firm molded grip. (As per FIG Specs)</li> <li>• Size: 160 cm (L) x 35 cm (W) x 28 cm (H) of pommel</li> <li>• FIG Approved PU leather cover with high density XPE foam.</li> <li>• Pommel Height: 12cm;</li> <li>• Distance between Pommels: 40 - 45cm, adjustable;</li> <li>• Height Adjustable: 95 cm – 125 cm in 5cm increments.</li> <li>• Includes turnbuckle; chain; anchor plate for stability.</li> </ul>	
<b>6002</b>	<b>Low Pommel Horse:</b>	
	<ul style="list-style-type: none"> <li>• Fiberglass pommels with adjustable aluminum base and studs.</li> <li>• Firm molded grip. (As per FIG Specs)</li> <li>• Pommel Top Conforming to FIG Specifications.</li> <li>• Size: 160 cm (L) x 35 cm (W) x 28 cm (H) of pommel</li> <li>• Pommel Height: 12cm;</li> <li>• Distance between Pommels: 40 - 45cm, adjustable;</li> </ul>	
<b>6003</b>	<b>Mushroom Trainers:</b>	
	<ul style="list-style-type: none"> <li>• <b>6003A</b> Adjustable Mushroom Trainer.</li> <li>• <b>6003B</b> Adjustable Mushroom Trainer with 1 nos. Pommel Grip</li> <li>• <b>6003C</b> Adjustable Mushroom Trainer with 2 nos. Pommel Grips</li> <li>• <b>6003D</b> Floor Mushroom: 100cm Ø x 20cm (H)</li> <li>• Mushroom Head: 60cmØ</li> <li>• Height Adjustable from 50cm – 70cm in 5cm increments</li> <li>• FIG PU leather top</li> <li>• Fiberglass pommels with adjustable aluminum base.</li> </ul>	
<b>6004</b>	<b>Mushroom Rotation Trainer:</b>	
	<ul style="list-style-type: none"> <li>• Rotating Mushroom Table: 150cmØ</li> <li>• Mushroom Head: 60cmØ with FIG PU leather top</li> <li>• Anti-Skid, synthetic leatherette cover on rotation table</li> <li>• Height: 60cm.</li> <li>• Bearing loaded rotation sleeves for rotating table.</li> </ul>	



6005	<b>Wall Fixed Mushroom Leg Trainer:</b>	
	<ul style="list-style-type: none"> <li>• Wall Mounted frame.</li> <li>• Height adjustable from 250cm to 300 cm.</li> <li>• Bearing loaded dual axis twisting frame.</li> <li>• Leather + Nylon cushioned leg supports.</li> <li>• Accessory for 6003 + 6004</li> </ul>	
6006	<b>Pommel Horse Competition Landing Mat Configuration: Conforming to FIG Specifications</b>	
	<ul style="list-style-type: none"> <li>• Size: 4m x 4m x 10cm</li> <li>• High Density PVC Covers</li> <li>• Combination of High Resilience PU Foam of 40D and High Density EPE foam.</li> <li>• Size and Quantity:</li> <li>• 4m x 2m x 10cm (2pcs.)</li> </ul>	
6007	<b>Spare Pommel Grips:</b>	
	<ul style="list-style-type: none"> <li>• <b>6007A:</b> 'PHYSIQUE' Competition Nylon grips with Aluminum Base and studs</li> <li>• <b>6007B:</b> GAOFEI FIG Approved Nylon Grips with Aluminum Base and studs</li> </ul>	
6008	<b>Pommel Soft Pads:</b>	
	<ul style="list-style-type: none"> <li>• Pre-Moulded base conforming to pommel top.</li> <li>• Covered with HD-XPE Foam and PU Leather</li> <li>• Thickness: 1"</li> <li>• Velcro attachment to Pommel Top</li> </ul>	
6009	<b>Floor Pommel Buck:</b>	
	<ul style="list-style-type: none"> <li>• Size: 800 cm (L) x 35 cm (W) x 28 cm (H) of pommel</li> <li>• FIG Approved PU leather cover with high density XPE foam.</li> <li>• Pommel Height: 12cm;</li> <li>• Total Height: 45cm</li> </ul>	

7001	<b>Competition Vault Table: Conforming to FIG Specifications</b>	
	<ul style="list-style-type: none"> <li>• Vault Head Size: 120cm (H) x 95 cm (W)</li> <li>• Moulded Table Top with FIG PU Leather top + 4" HD-XPE Foam.</li> <li>• Height Adjustable from 105 cm – 135 cm in 5 cm increments with heavy duty steel base</li> <li>• Hydraulic based height adjustment system.</li> <li>• Base upright covers with height adjustment markings.</li> <li>• Additional 80 x 40 x 40mm weight flats for added weight.</li> <li>• Includes turnbuckle and chain with floor anchor for added stability.</li> </ul>	



<b>7002</b>	<b>Competition Spring Board:</b> <i>Conforming to FIG Specifications</i>	
	<ul style="list-style-type: none"> <li>• <b>7002A:</b> 8 nos. High Compression Springs. HARD</li> <li>• <b>7002B:</b> 5 nos. High Compression Springs. SOFT</li> <li>• Moulded Double Flex System.</li> <li>• Size: 120cm x 60cm x 22cm (H)</li> <li>• FIG carpet top with HD-XPE Foam.</li> </ul>	
<b>7003</b>	<b>Kids Spring Board:</b>	
	<ul style="list-style-type: none"> <li>• Moulded Double Flex System.</li> <li>• Size: 90cm x 60cm x 22cm (H)</li> <li>• FIG carpet top with HD-XPE Foam.</li> </ul>	
<b>7004</b>	<b>Vault Runway Mat:</b> <i>Conforming to FIG Specifications</i>	
	<ul style="list-style-type: none"> <li>• Size: 3' (W) x 25m (L) x 25mm / 1" thickness</li> <li>• Made from High Density XPE foam with anti-skid and anti-static acrylic carpet surface laminated to the foam.</li> </ul>	
<b>7005</b>	<b>Safety Collar for Spring Boards:</b> <i>Conforming to FIG Specifications</i>	
	<ul style="list-style-type: none"> <li>• Dimensions: 120 cm (L) x 100 cm (W) x 20 cm (H).</li> <li>• Ideal for the safety of gymnasts, especially when performing round-off vaults.</li> <li>• Fits all springboards.</li> </ul>	
<b>7006</b>	<b>Foam Vault:</b>	
	<ul style="list-style-type: none"> <li>• Size: 120cm (L) x 135cm (H) x 95cm (W)</li> <li>• 3 Connecting Pieces for use in men's' or women's vaulting programs.</li> <li>• PU Leather Top for better grip while performing elements.</li> <li>• Add or remove blocks to adjust height <ul style="list-style-type: none"> <li>- Top Block: 95cm (W) x 120cm (L) x 60cm (H)</li> <li>- Centre Block: 95cm (W) x 120cm (L) x 40cm (H)</li> <li>- Bottom Block: 95cm (W) x 120cm (L) x 25cm (H)</li> <li>- Men's Block: 95cm (W) x 120cm (L) x 10cm (H)</li> </ul> </li> </ul>	
<b>7007</b>	<b>Vault Competition Landing Mat Configuration:</b>	
	<ul style="list-style-type: none"> <li>• Size: 6m x 2.5m x 20cm</li> <li>• High Density PVC Covers</li> <li>• Combination of High Resilience PU Foam of 40D and High Density EPE foam.</li> <li>• Size and Quantity: <ul style="list-style-type: none"> <li>200cm x 250cm x 20cm (3pcs)</li> <li>200cm x 600cm x 10cm (1pcs) Top mat with markings.</li> </ul> </li> </ul>	



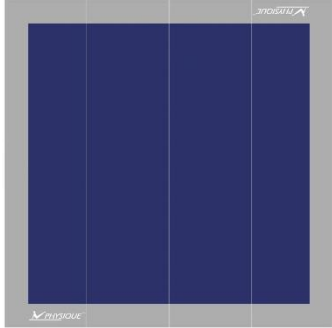

## VAULT TABLE: Competition & Allied

<b>7008</b>	<b>Vault Handmat:</b>	
	<ul style="list-style-type: none"> <li>• Specs: 1.2m x 1m x 30mm Thick</li> <li>• HD XPE Foam with Anti-Skid PU Leather Cover</li> </ul>	
<b>7009</b>	<b>Vaulting Horse:</b>	
	<ul style="list-style-type: none"> <li>• Size: 125 cm (L) x 78 cm (W) x 125cm (H)</li> <li>• Made of Teakwood</li> <li>• 4 section Vaulting Horse</li> <li>• 2" Cushion top with synthetic leatherette cover.</li> <li>• PU Finish</li> </ul>	
<b>7010</b>	<b>Vaulting Buck:</b>	
	<ul style="list-style-type: none"> <li>• <b>7010A</b> Small Vaulting Buck: Buck Size: 50 cm (L) x 35 cm (W) x 28 cm (H) Height Adjustable: 80 cm – 110 cm in 5cm increments</li> <li>• <b>7010B</b> Large Vaulting Buck: Buck Size: 60 cm (L) x 35 cm (W) x 28 cm (H) Height Adjustable: 100 cm – 140 cm in 5cm increments</li> <li>• Molded top with PU Leather Cover.</li> </ul>	



## FLOOR EXERCISE:





<b>8001</b>	<b>Competition Artistic Floor: Conforming to FIG Specifications</b>	
	<ul style="list-style-type: none"> <li>• Size: 14m x 14 m / Performance Area: 12m x 12m</li> <li>• Imported Carpet size: 3.5m x 4 nos; connected with velcro</li> <li>• Performance area marked by two tone carpet.</li> <li>• Floor system consists of 72 nos. floor panels of 18mm marine ply with springs positioned precisely to achieve best performance.</li> <li>• Connected by connector panels for Joint flexibility and velcro strapping to secure the floor</li> <li>• Covered with 50mm thick HD-XPE Foam rolls. Carpet rolled over.</li> <li>• Side PVC strip to close the complete system.</li> </ul>	
<b>8002</b>	<b>Tumbling Strip:</b>	
	<ul style="list-style-type: none"> <li>• High Density Cross Link XPE Foam with heavy anti-static and anti-skid carpet.</li> <li>• 14m (L) x 2m (W)</li> <li>• Sprung Floor with 100mm springs and nylon caps.</li> <li>• 18mm heavy marine ply with metal connector panels, strapped together.</li> </ul>	

## FLOOR EXERCISE:

8003	<b>Competition Rhythmic Floor: Conforming to FIG Specifications</b>	
	<ul style="list-style-type: none"> <li>• Complete Imported System</li> <li>• Size: 14.5m x 14.5m,</li> <li>• Performance area of 13m x 13m.</li> <li>• Imported FIG Approved RG Carpet: 14.5m x 14.5m.</li> <li>• 3 strips of 14.5m x 4m &amp; 1 strip of 14.5m x 2m</li> <li>• Performance area marked by adhesive velcro</li> <li>• Floor system consists of dynamic floor panels of 9mm + 9mm marine ply with imported EVA foam blocks of 70mm x 70mm x 70mm (H) laminated to the ply.</li> <li>• Dynamic ply with interconnecting brackets have a perfect stable floor.</li> <li>• Covered with 10mm thick laminated cushion.</li> <li>• Carpet joint with velcro beneath the surface.</li> </ul>	
8004	<b>Competition Tumbling Track: Conforming to FIG Specifications</b>	
	<ul style="list-style-type: none"> <li>• Tumbling Track Size: 2m (W) x 25m (L) x 30cm (H)</li> <li>• Made from 50mm x 50mm Lazer slotted frame.</li> <li>• 2m(L) fiber glass rods slotted into the frame.</li> <li>• 60mm thick HD-XLPE multi-laminated crosslink foam with heavy duty acrylic carpet top.</li> <li>• Skirting on complete frame.</li> <li>• Landing zone of 6m (L) x 3m (W) x 30cm (H) with 4m x 2m x 10cm supplementary mat; HR40D PU Foam Fillers.</li> <li>• Runup track of 10m (L) x 1m (W) x 30cm (H); 30mm XLPE foam with laminated carpet top.</li> <li>• <b>** Options for other sizes available.</b></li> </ul>	

## AIR APPARATUS:



PHY-AF	<b>AirFloor:</b>	
	<ul style="list-style-type: none"> <li>• Available Size: 8m x 8m / 10m x 10m / 12m x 12m &amp; 14m x 14m</li> <li>• Bonded and sealed Seams.</li> <li>• Air compressors &amp; Repair Kit included.</li> <li>• One Year Warranty</li> <li>• FIG Standard Training Equipment</li> <li>• Good elasticity with Non-Slip Surface.</li> <li>• Sizes can be customized.</li> </ul>	
PHY-AT	<b>AirTrack:</b>	
	<ul style="list-style-type: none"> <li>• Sizes: 2m (W) x 20cm (H)</li> <li>• Available Lengths: 8m / 12m / 10m / 15m / 20m (L)</li> <li>• Bonded and sealed Seams.</li> <li>• Air compressors &amp; Repair Kit included.</li> <li>• One Year Warranty</li> <li>• FIG Standard Training Equipment</li> <li>• Good elasticity with Non-Slip Surface.</li> <li>• Deflate and carry.</li> </ul>	





<b>PHY-AS</b>	<b>AirSpots: (MOQ 4 nos.)</b>	
	<ul style="list-style-type: none"> <li>• Sizes: 70cm Ø to 140cm Ø x 20cm (T)</li> <li>• Bonded and sealed Seams.</li> <li>• Air compressors &amp; Repair Kit included.</li> <li>• One Year Warranty</li> <li>• Good elasticity with Non-Slip Surface.</li> <li>• Deflate and carry.</li> </ul>	
<b>PHY-AR</b>	<b>AirRolls: (MOQ 4 nos.)</b>	
	<ul style="list-style-type: none"> <li>• Sizes: 60cm Ø – 90cm Ø</li> <li>• Lengths: 100cm – 120cm</li> <li>• Bonded and sealed Seams.</li> <li>• Air compressors &amp; Repair Kit included.</li> <li>• One Year Warranty</li> <li>• Good elasticity with Non-Slip Surface.</li> <li>• Deflate and carry.</li> </ul>	
<b>PHY-AB</b>	<b>AirBlocks:</b>	
	<ul style="list-style-type: none"> <li>• Sizes: 1m x 2.1m x 20cm (T) 1m x 2.8m x 33cm (T)</li> <li>• 15cm wide soft velcro all around the top</li> <li>• 15cm wide hard velcro small ends on the bottom</li> <li>• D-rings on corners</li> <li>• Air compressors &amp; Repair Kit included.</li> <li>• One Year Warranty</li> <li>• Good elasticity with Non-Slip Surface.</li> <li>• Stackable blocks</li> </ul>	
<b>PHY-ABP</b>	<b>AirBoard PRO: (MOQ 4 nos.)</b>	
	<ul style="list-style-type: none"> <li>• Size: 1.2m x 60cm x 20cm (T)</li> <li>• The AirBoard is a rectangular air-filled training pad designed to work perfectly with vaulting sets and smaller Airtrack's to create methodical landscapes.</li> <li>• Equipped with D-Rings and straps to fit on spring boards</li> </ul>	
<b>PHY-ASP</b>	<b>AirSquare PRO: (MOQ 4 nos.)</b>	
	<ul style="list-style-type: none"> <li>• Size: 95cm x 95cm x 20cm for Vault</li> <li>• Size: 1m x 1m x 20cm for MiniTrampoline.</li> <li>• The AirSquare are designed to work on various equipment like the Vault Table and MiniTramp to add extra bounce or reduce stress when performing multiple repetitions.</li> <li>• Equipped with D-Rings and straps to fit on Vault table or trampoline.</li> </ul>	

## AIR APPARATUS:







<b>PHY-AB</b>	<b>AirBeam: (MOQ 4 nos.)</b>	
	<ul style="list-style-type: none"> <li>Sizes: 3m and 5m</li> <li>Bonded and sealed Seams.</li> <li>Air compressors &amp; Repair Kit included.</li> <li>One Year Warranty</li> <li>Good elasticity with Non-Slip Surface.</li> <li>Deflate and carry.</li> </ul>	

## TRAMPOLINES:

<b>10001</b>	<b>Competition Trampoline: Conforming to FIG Specifications</b>	
	<ul style="list-style-type: none"> <li>Frame Size: 5.20m x 3.05m x 1.15m,</li> <li>Safety Platform: 1.85 m x 2.65m x 1.15m x 2 nos.,</li> <li>Springs: 110 springs with 08 nos. corner springs (118 pcs)</li> <li>Jumping Bed Size: 4.26m x 2.13m</li> <li>Webbed: 4mm x 5mm nylon webbed.</li> </ul>	
<b>10002</b>	<b>Ground Mats for Competition Trampoline: Conforming to FIG Specifications</b>	
	<ul style="list-style-type: none"> <li>Size: 13.20m x 6.9m x 30cm (H)</li> <li>3m x 2m x 30cm x 8 nos.</li> <li>2m x 2m x 30cm x 4 nos.</li> </ul>	
<b>10003</b>	<b>MiniTramp:</b>	
	<ul style="list-style-type: none"> <li>Frame Size: 130 x 130cm,</li> <li>overall height: 45 to 65cm adjustable,</li> <li>Jumping Bed Size: 70cm x 70cm</li> <li>Webbed: 8mm x 8mm nylon webbed.</li> </ul>	
<b>10004</b>	<b>Vault Trampoline:</b>	
	<ul style="list-style-type: none"> <li>Frame Size: 137 x 100cm,</li> <li>overall height: 27 to 34cm adjustable,</li> <li>Jumping Bed Size: 93cm x 57cm</li> <li>Webbed: 8mm x 8mm nylon webbed</li> </ul>	
<b>10005</b>	<b>OpenEnd MiniTramp:</b>	
	<ul style="list-style-type: none"> <li>Frame Size: 123 x 126cm</li> <li>Height Adjustments: 3206cm – 38.50cm Low side; 63.5cm – 72.10cm High side</li> <li>Jumping Bed Size: 60cm x 70cm</li> <li>Webbed: 8mm x 8mm nylon webbed</li> </ul>	

03000	<b>ULTIMATE Competition Trampoline: FIG Approved</b>	
	<ul style="list-style-type: none"> <li>• Frame: Flat-oval steel frame 520 x 305 x 115cm, "easy-lock- system",</li> <li>• Jumping bed: 426 x 213cm, 4 x 4mm / 5 x 4mm / 6 x 4mm nylon strings and stitched-in anchor bars,</li> <li>• Springs: 110 steel springs 258 x 29mm + 8 corner springs 258 x 39mm</li> <li>• Padding: 32mm, foldable,</li> <li>• Supplies: roller stands, service bag</li> </ul>	
27300	<b>ULTIMATE Safety Platform: FIG Approved</b>	
	<ul style="list-style-type: none"> <li>• Eurotramp Safety Platforms for Ultimate FIG APPROVED: Safety platforms "Competition Universal", 262 x 187 x 115cm, for Ultimate, FIG-certificate 1 Pair</li> </ul>	
28000	<b>ULTIMATE Safety Mat with Wedge: FIG Approved</b>	
	<ul style="list-style-type: none"> <li>• Eurotramp Safety mats "Competition" with wedge 300x200x20cm, wedge 300x40x20cm, for Safety platforms "Competition" FIG- certificate 1 Pair</li> </ul>	
23200	<b>ULTIMATE DMT 6x6: FIG Approved</b>	
	<ul style="list-style-type: none"> <li>• New 6 x 6mm high performance nylon jumping bed (292 x 292cm</li> <li>• 98 steel springs (length 235mm x 39mmØ</li> <li>• Frame: Flat oval steel tube 350 x 190 x 70cm, made of special steel; galvanized</li> <li>• Total weight: 152 kg.</li> </ul>	
50500	<b>MiniTramp 112:</b>	
	<ul style="list-style-type: none"> <li>• Frame: Round Tube 112cm x 112cm</li> <li>• Legs: Made of special steel round tube, height adjustable, galvanized.</li> <li>• Jumping Bed: 60cm x 60cm</li> <li>• Webbed: Double Perlon 13mm wide weaved nylon bands</li> <li>• 28 steel springs 185mm (L) x 32mmØ</li> <li>• 4 rubber cables 230cm (L) x 11.4mmØ</li> </ul>	
60500	<b>MiniTramp 125</b>	
	<ul style="list-style-type: none"> <li>• Frame: Round Tube 125cm x 125cm</li> <li>• Legs: Made of special steel round tube, height adjustable, galvanized.</li> <li>• Jumping Bed: 70cm x 70cm</li> <li>• Webbed: Double Perlon 13mm wide weaved nylon bands</li> <li>• 32 steel springs 185mm (L) x 32mmØ</li> <li>• 4 rubber cables 230cm (L) x 11.4mmØ</li> <li>• Genuine hologram Label</li> </ul>	



45500	<b>Open-End MiniTramp:</b>	
	<ul style="list-style-type: none"> <li>• Open-End-MiniTramp "Standard" with jumping bed (60 x 70 cm) made of 13 mm nylon bands</li> <li>• Legs: round tube made of special steel, adjustable in height, galvanized; legs strengthened by brace</li> <li>• 32 steel springs (length: 185 mm, Ø 32 mm); galvanized</li> <li>• Shock absorbing and stable frame pads</li> <li>• Genuine hologram label</li> </ul>	
61000	<b>Booster Board:</b>	
	<ul style="list-style-type: none"> <li>• Frame: 135 x 100 / Height 26,5-23cm,</li> <li>• Jumping bed: 93x57cm</li> <li>• Made of double perlon bed with integrated neoprene-spring- cover,</li> <li>• Springs: 42 steel springs / Padding: 22mm,</li> <li>• Transport castors</li> </ul>	
8810	<b>Trampoline Track Stationery 2</b>	
	<ul style="list-style-type: none"> <li>• Length: 4m – 20m in 2m sections</li> <li>• Width: 2m / Height: 72cm</li> <li>• Jumping bed: PVC Coated Fabric resistant to weather and UV light.</li> <li>• Springs: 185mm (L) x 32mmØ</li> <li>• Springs from 136 nos. – 640 nos.</li> </ul>	
87500	<b>Air Track 'PLUS':</b>	
	<ul style="list-style-type: none"> <li>• Length: 7.5m / 9m / 10m / 12m / 15m / 18m / 20m</li> <li>• Adjustable hardness, making the track equally suitable for elite gymnasts and beginners alike</li> <li>• Grips on both sides as standard facilitate handling</li> <li>• Velcro on all sides as standard ensures multi-purpose use, providing ideal opportunities for exciting tumbling choreographies and differentiated training</li> <li>• Blower included.</li> </ul>	
28330	<b>Ground Safety Mats: FIG Approved</b>	
	<ul style="list-style-type: none"> <li>• Flat stable core with high-density absorbent foam.</li> <li>• 4 handy grips</li> <li>• Top layer of heat-absorbent needle felt.</li> <li>• Seams covers with 2mm thick, 15cm wide velour / velcro strips.</li> <li>• Rapid load absorption, high degree damping, very stable.</li> <li>• 4-sided coupling</li> <li>• Reinforced edging, sandwich core.</li> </ul>	
26101	<b>Double MiniTramp Landing Mats: FIG Approved</b>	
	<ul style="list-style-type: none"> <li>• Set of landing-mats, 3 soft ground-mats, each 300 x 200 x 30cm, for Double-MiniTramp, according to FIG-guidelines</li> <li>• Landing-mat cover, 600 x 300 x 30cm, yellow landing area 400 x 200cm, red landing area 250 x 100cm, for Set of landing mats, Double-MiniTramp</li> </ul>	

**28600 Spotting Mats: Conforming to FIG Specifications**

- Size: 164 x 113 x 14cm.
- Weight: 8kgs.
- Excellent cushioning properties
- Weight optimized for easier handling
- Modern design match to Eurotramp equipment.
- Edges are rounded to avoid bumping or getting caught when pushing or throwing.
- New handle design for ergonomic optimization of hand position.
- In accordance with FIG apparatus norms.



**MATS:**

**9001 Gym Mats:**

- 9001A: 6' x 4' x 10cm Soft Mat
- 9001B: 6' x 4' x 20cm Soft Mat
- 9001C: 6' x 4' x 20cm Firm Mat
- 9001D: 6' x 4' x 5cm Gym Mat
- Soft Mats made of HR40D PU Foam.
- Firm Mats made with a combination of HD-XLPE and HD40D PU foam in sandwich format.
- Heavy duty double coated nylon PVC covers of 1680 GSM; non-tearing and washable; with carry handles

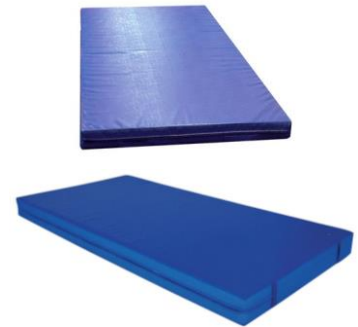

**10100 Gymnastic Crash Mats:**

- 10100A: 3m x 2m x 20cm; *Conforming to FIG Specification.*
- 10100B: 3m x 2m x 30cm.
- 10100C: Foldable Crash Mat; 6m x 2m x 10cm > 3m x 2m x 20cm
- Mats are made of HR40D PU foam.
- Foam layout in log format to give more softness with ample airflow.
- Air vents on sides to ensure mats softness and foam recovery.
- Heavy duty double coated nylon PVC covers of 1680 GSM; non-tearing and washable; with carry handles.





**11100 10cm Supplementary Mats: Conforming to FIG Specification.**

- 11100A: 2m x 2m x 10cm
- 11100B: 2m x 3m x 10cm
- 11100C: 2m x 4m x 10cm
- 11100D: 2m x 5m x 10cm
- 11100E: 2m x 6m x 10cm
- Mats are made of HR40D PU foam blocks.
- Air vents on sides to ensure mats softness and foam recovery.
- Heavy duty double coated nylon PVC covers of 1680 GSM; non-tearing and washable; with carry handles.













<b>12100</b>	<b>Roll-Up Mats:</b>	
	<ul style="list-style-type: none"> <li>• Size: 1.8m (W) x 30mm &amp; 50mm (T)</li> <li>• Acrylic Anti-Skid and Anti-Static Carpet Laminated onto HD-XLPE Foam</li> <li>• Multiple mats can be used to make a seamless Gymnastics Floor.</li> </ul>	







<b>00160</b>	<b>Spotting Blocks / Methodical Blocks:</b>	
	<ul style="list-style-type: none"> <li>• 00160A: 50cm (L) x 50cm (W) x 50 cm (H)</li> <li>• 00160B: 80cm (L) x 80cm (W) x 80cm (H)</li> <li>• 00160C: 100cm (L) x 100cm (W) x 100cm (H)</li> <li>• 00160D: 80cm (L) x 40cm (W) x 50cm (H)</li> <li>• 00160E: 160cm (L) x 80cm (W) x 100cm (H)</li> <li>• Made with a combination of HD-EPE and HD-XLPE foam.</li> <li>• Heavy duty double coated nylon PVC covers of 1680 GSM; non-tearing and washable; with carry handles</li> </ul>	

<b>00170</b>	<b>Hand Stand Bouncer:</b>	
	<ul style="list-style-type: none"> <li>• Height Adjustable:</li> <li>• 100 – 150 cm</li> <li>• Length of Bar: 1.6m</li> <li>• Flexi Strip with foam roller.</li> </ul>	

<b>00180</b>	<b>Wall Bars:</b>	
	<ul style="list-style-type: none"> <li>• Size: 8' x 3' sections</li> <li>• 16 nos. Oval Rings</li> <li>• Made of Imported Beechwood.</li> <li>• PU Finish</li> <li>• Wall mounted.</li> </ul>	

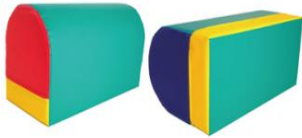
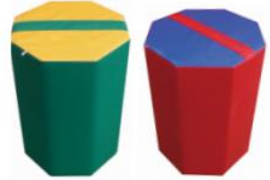

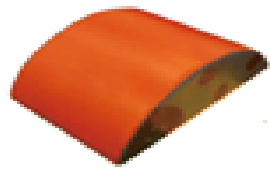

<b>00190</b>	<b>Wall Bar Bend:</b>	
	<ul style="list-style-type: none"> <li>• Size: 90cm (L) x 50cm (W) x 42cm (H).</li> <li>• Tear drop shape.</li> <li>• Velcro strapping to mount on wall bars.</li> <li>• Made with a combination of HD-EPE and HD-XLPE foam.</li> <li>• Heavy duty double coated nylon PVC covers of 1680 GSM; non-tearing and washable.</li> </ul>	









<b>00200</b>	<b>Hand Stand Rocker:</b>	
	<ul style="list-style-type: none"> <li>Great tool for training handstand skills and strength that transfer not only to Rings but also Parallel Bars, and Beam.</li> <li>Rocking motion helps focus on stabilizer muscles.</li> <li>Stoppers for controlling rocking motion.</li> </ul>	
<b>00210</b>	<b>Gymnastic Bench</b>	
	<ul style="list-style-type: none"> <li>10' (L) x 1' (H)</li> <li>Made of Beech Wood.</li> <li>Includes wall bar attachments.</li> </ul>	
<b>00220</b>	<b>Floor Anchors</b>	
	<ul style="list-style-type: none"> <li>00220A: Full Grouted Flush System (set of 4)</li> <li>00220B: Anchor Plates (including fasteners)</li> <li>00220C: Complete mounting system (floor anchors + mounting acc.)</li> </ul>	
<b>00230</b>	<b>Powder Stand</b>	
	<ul style="list-style-type: none"> <li>Powder Stand:</li> <li>Light weight and sturdy.</li> <li>Stainless steel bowl</li> <li>Steel Uprights with floor levelers.</li> </ul>	
<b>FOAM MODULES</b>		
<b>01000</b>	<b>Wedge:</b> 01000A: 80cm x 60cm x 35 > 3cm (S) 01000B: 120cm x 60cm x 40 > 4cm (M) 01000C: 185cm x 90cm x 40 > 4cm (L)	
<b>02000</b>	<b>Foldable Wedge:</b> 02000A: 185cm x 125cm x 40 > 4 cm (S) 02000B: 305cm x 150cm x 55 > 5cm (L)	
<b>03000</b>	<b>Straight Wedge:</b> 140cm x 70cm x 40 > 10cm	
<b>04000</b>	<b>Mid Triangle:</b> 110cm x 82cm x 60 / 3cm	
<b>05000</b>	<b>Slope Ladder Mat:</b> 60cm x 80cm x 20cm x 30cm	

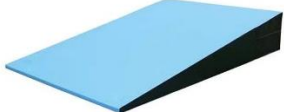



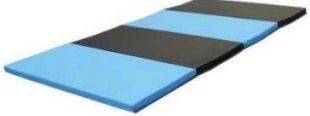

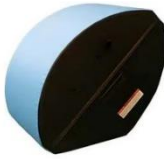
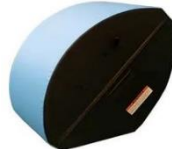
FOAM MODULES:		
06000	<p><b>Foam Rings:</b> 06000A: 120cm (od) x 60cm (id) x 30cm (thick) (Small) 06000B: 135cm (od) x 75cm (id) x 45cm (thick) (Large)</p>	
07000	<p><b>Handspring Trainers:</b> 07000A: Small Trainer 32" <math>\phi</math> 07000B: Medium Trainer 36" <math>\phi</math> 07000C: Handspring Trainer 48" <math>\phi</math></p>	
08000	<p><b>Mailbox:</b> 08000A: 90cm x 40cm x 40cm. 08000B: 120cm x 60cm x 60cm</p>	
09000	<p><b>Octagon:</b> 09000A: 35cm <math>\phi</math> x 60cm (L) 09000B: 50cm <math>\phi</math> x 75cm (L) 09000C: 75cm <math>\phi</math> x 90cm (L)</p>	
10000	<p><b>Cylinders with cradle:</b> 10000A: 20cm <math>\phi</math> x 40cm (L) 10000B: 30cm <math>\phi</math> x 120cm (L) 10000C: 50cm <math>\phi</math> x 70cm (L) 10000D: 65cm <math>\phi</math> x 120cm (L)</p>	
11000	<p><b>Semi-Circle:</b> 40cm <math>\phi</math> x 60cm thickness</p>	
12000	<p><b>Octagon Ring:</b> 120cm (od) x 65cm (id) x 40cm thickness</p>	
13000	<p><b>Foam Trapezoid:</b> Top width 38cm, Bottom width 90cm, Length 1.2 m, Height of 0.3 - 1.2 m, Combination of EPE and PU foam.</p>	



<p><b>14000</b></p>	<p><b>Step-Ups:</b>            14000A: 40cm x 40cm x 20cm (small step ladder)            14000B: 60cm x 55cm x 35cm (2 –step)            14000C: 85cm x 60cm x 55cm (3-step)            14000D: 140cm x 70cm x 70cm (5-step)</p>	
<p><b>15000</b></p>	<p><b>Semi-Circle Rings:</b>            15000A: 120cm (OD) x 60cm (ID) x 30cm (T)            15000B: 130cm (OD) x 75cm (ID) x 45cm (T)</p>	
<p><b>16000</b></p>	<p><b>Foldable Block:</b>            60cm x 60cm x 5 cm Thick            2.4m (L) x 60cm (W) x 5cm (T) when open</p>	
<p><b>17000</b></p>	<p><b>Jumping Blocks:</b>            17000A: 90cm (L) x 15cm(H) x 15cm (T)            17000B: 90cm (L) x 20cm (H) x 15cm (T)            17000C: 90cm (L) x 25cm (H) x 15cm (T)            17000D: 90cm (L) x 30cm (H) x 15cm (T)</p>	

<p><b>PM1001</b></p>	<p><b>Triangular pier: large slope:</b>            Size: 754 x 610 x 630mm            Set: 4 pieces</p>	
<p><b>PM1002</b></p>	<p><b>Jump Box:</b>            Size: 1220 x 600 x 760mm</p>	
<p><b>PM1003</b></p>	<p><b>Single bench:</b>            Size: 600 x 600 x 370mm            Set: 4 pieces</p>	
<p><b>PM1004</b></p>	<p><b>Table obstacle Block: (bench type)</b>            Size: 1220 x 508 x 660mm</p>	

<p><b>PM1005</b></p>	<p><b>Octagonal:</b> Size: 760 x 630 x 630mm</p>	
<p><b>PM1006</b></p>	<p><b>Incline mat:</b> Size: 2130 x 1520 x 450mm</p>	
<p><b>PM1007</b></p>	<p><b>Folding incline mat:</b> Size: 1220 x 610 x 356mm</p>	
<p><b>PM1008</b></p>	<p><b>Balance beam:</b> Size: 1820 x 370 x 200mm</p>	
<p><b>PM1009</b></p>	<p><b>Cartwheel mat:</b> Size: 530 x 330 x 130mm</p>	
<p><b>PM1010</b></p>	<p><b>Folding mat:</b> Size: 1240 x 2440 x 50mm</p>	
<p><b>PM1011</b></p>	<p><b>Foam mat:</b> Size: 1510 x 1510 x 200mm</p>	
<p><b>PM1012</b></p>	<p><b>Big mat:</b> Size: 2000 x 1480 x 300mm</p>	
<p><b>PM1013</b></p>	<p><b>Stepping stone:</b> Size: 914 x 533 x 635mm</p>	
<p><b>PM1014</b></p>	<p><b>Stepping stone:</b> Size: 1143 x 711 x 889mm</p>	
<p><b>PM1015</b></p>	<p><b>Mailbox:</b> Size: 825 x 400 x 500mm</p>	

<p><b>PM1016</b></p>	<p><b>Single barrier:</b> Size: 1215 x 610 x 625mm</p>	
<p><b>PM1017</b></p>	<p><b>Protection mat:</b> Size: 2400 x 1180 x 100mm</p>	
<p><b>PM1018</b></p>	<p><b>Warrior wall:</b> Size: 2086 x 1200 x 1200mm</p>	
<p><b>PM1019</b></p>	<p><b>Warped wall:</b> Size: 1829 x 1067 x 2185mm</p>	
<p><b>PM1020</b></p>	<p><b>Table:</b> Size: 1220 x 762 x 915mm 3 blocks</p>	
<p><b>PM1021</b></p>	<p><b>Slanted steps:</b> Size: 754 x 610 x 630mm Set: 4 pieces</p>	
<p><b>PM1022</b></p>	<p><b>Cylinder:</b> Size: <math>\phi</math>730 x 750mm</p>	

- All foam modules are made using the highest quality of EPE, PU and XPE foam
- Foam modules are made with a combination of HD-EPE and HD-XLPE Foam
- Parkour Mats are made of HD-XLPE Crosslink foam and 2400D PVC Covers.
- Covers are made of Heavy duty double coated nylon PVC covers of 1680 GSM; non-tearing and washable; with carry handles.



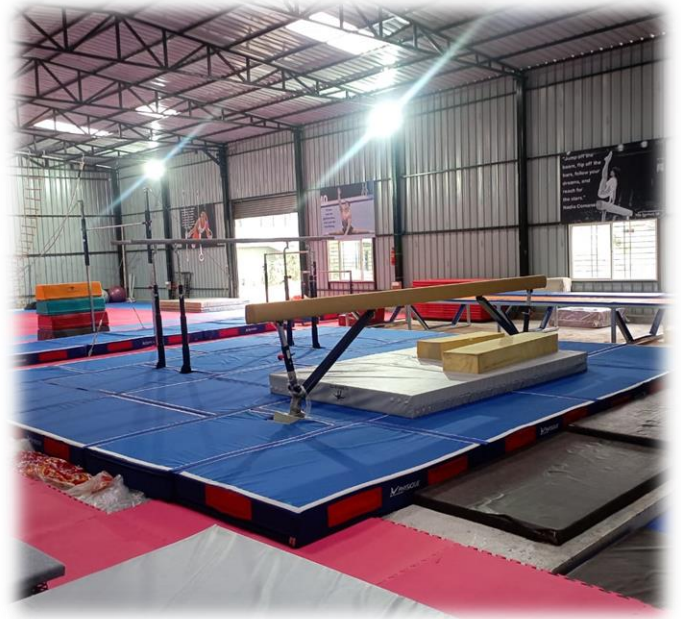

***Exclusive Representatives for American Athletic Inc. (AAI), USA; Eurotramp, Germany and Gaofei, China.***