



EW23001

Power Steering Fluid Exchange Machine



Operations Manual

TABLE OF CONTENTS

INTRODUCTION TO THE MACHINE	2
CUSTOMER SERVICE CONTACT INFO	2
SAFETY INFORMATION	3
MACHINE SPECIFICATIONS & FEATURES	8
MACHINE OVERVIEW	9
OPERATING INSTRUCTIONS	10
MAINTENANCE	13
REPLACEMENT PARTS	14
WARRANTY INFORMATION	16

INTRODUCTION *to the* **Wynn's Power Steering Fluid Exchange Machine**

Congratulations on the purchase of your Wynn's power steering fluid exchange machine!

Simply put, this machine is the cleanest, safest, easiest, fastest, most thorough, and most cost-efficient method of power steering fluid exchange ever devised. Suddenly, power steering maintenance has become a more realistic proposition. Fluid exchanges are cleaner and neater than ever!

Service neglect leads to power steering system complaints including poor handling, hard or sluggish steering, and objectionable noise. Historically, power steering system fluid service has been neglected, often due to the lack of a convenient method for providing such fluid exchange services. Previous methods for exchanging the power steering system or replacing the power steering fluid were time consuming and often inefficient or incomplete. Now, it's easier than ever to replace up to 95% of the old power steering fluid in less than 8 minutes, to ensure your power steering system has a long, trouble-free life.

Please take time to read through this manual to familiarize yourself with this machine before performing your first power steering fluid exchange.

CUSTOMER SERVICE CONTACT INFORMATION

For product information, tech support, or to order replacement parts,
please call: **833-303-4644**
or visit: ***equipment.wynnsusa.com***

IMPORTANT SAFETY NOTICE

For your safety, read this manual thoroughly before operating your machine. This machine is intended for use by properly trained, skilled professional automotive technicians. The safety messages presented below and throughout this user's manual are reminders to the operator to exercise care when using this unit. Before using this machine, always refer to and follow the safety messages and applicable service procedures provided by the manufacturer of the vehicle being serviced.

• Read All Safety Instructions

Read, understand and follow all safety messages and instructions in this manual. Safety messages in this section of the manual contain a signal word with a three-part message and, in some instances, an icon.

• Signal Words

The signal word indicates the level of the hazard in a situation:

DANGER

Indicates an imminently hazardous situation which, if not avoided, will result in death or serious injury to the operator or to bystanders.

WARNING

Indicates a potentially hazardous situation which, if not avoided, could result in death or serious injury to the operator or to bystanders.

CAUTION

Indicates a potentially hazardous situation which, if not avoided, may result in moderate or minor injury to the operator or to bystanders.

IMPORTANT

Indicates a situation which, if not avoided, may result in damage to the machine, or the vehicle being serviced.

• Safety Messages

Safety messages in this section contain three different type styles:

- Normal type states the hazard.
- **Bold type** states how to avoid the hazard.
- *Italic type* states the possible consequences of not avoiding the hazard.

• Safety Symbols

A safety symbol, when present, gives a graphical description of the potential hazard, and how to avoid the hazard:



Risk of Fire



Read Instructions Before Use



Risk of Explosion



Mandatory Eye Protection



Risk of Entanglement



Mandatory Protective Gloves



Dangerous Fumes



Mandatory Protective Clothing



Do Not Pull or Move

IMPORTANT SAFETY INSTRUCTIONS

DANGER



Engine exhaust contains toxic gases.

- **Vent vehicle's exhaust away from work area.**
- **Do not breathe exhaust.**

Exhaust gases will cause injury or death.

WARNING



Improper use and operation.

- **Read, understand and follow all safety messages and operational procedures in this manual before operating the machine.**
- **This equipment should be operated only by qualified personnel.**
- **Use this equipment only as described in this manual.**

Improper use and operation of this product can result in injury.

WARNING



Engine systems can malfunction expelling fuel, oil vapors, hot steam, hot toxic exhaust gases and other debris.

- **Wear safety goggles and protective clothing, user and bystander.**

Engine systems that fail can cause serious injury.

WARNING



Risk of expelling pressurized fluids.

- **Wear safety goggles and protective clothing, user and bystander.**
- **Always unplug the machine from its power source when not in use.**
- **Keep the service hoses away from hot or moving engine parts. Hoses can split or burst causing fluid to be expelled.**
- **Avoid contact with power steering fluid.**
- **Treatment methods are as follows:**
 - Eyes: Flush eyes with plenty of water.**
 - Skin: Wash with soap and water.**
 - Inhalation: Move to uncontaminated area.**
 - Ingestion: If large amount, get medical attention.**
 - If any irritation persists, get medical attention.**
- **Dispose of used fluid according to environmental laws and regulations.**

Although automatic transmission and power steering fluid pose no significant health hazards, some individuals may experience adverse reactions upon contact. Pressurized fluid can cause serious injury.

WARNING

Risk of unexpected vehicle movement.

- **Block drive wheels before starting vehicle's engine to begin an exchange.**
- **Unless instructed otherwise, set parking brake and put gear selector in park.**
- **Do not leave a running vehicle unattended.**

A moving vehicle can cause injury.

WARNING



Engine has moving parts. Risk of entanglement.

- **Do not place tools on fenders or other places in engine compartment.**
- **Keep yourself, clothing, battery cables and service hoses clear of moving parts such as fan blades, belts and pulleys.**

Contact with moving parts can cause injury.

WARNING



Risk of fire or explosion.

- Do not operate the machine in the vicinity of open containers of flammable liquids such as gasoline.
- Keep hoses and jumper cables away from heat sources and sharp edges.
- Do not operate equipment with damaged cords or hoses until they have been examined by a qualified serviceman.

Fire or explosion can cause injury.

WARNING



Risk of fire or explosion. Gases produced by a battery are highly explosive.

- Wear safety goggles and protective clothing, user and bystander.
- This machine is equipped to operate on 12-volt DC power only. A power source greater than this can result in serious injury to the user as well as damage to the machine.
- Do not smoke, place metal tools on battery or allow a spark or flame in vicinity of battery.
- Clean battery terminals before hooking the machine's battery clips to them. During cleaning, keep airborne corrosion from eyes, nose and mouth.
- Be sure both battery cables are tightly connected to the battery terminals as instructed before proceeding with a fluid exchange.
- Never remove battery cables from the battery terminals while the machine is operating.

Battery explosion can cause injury.

WARNING



Battery acid is a highly corrosive sulfuric acid.

- Wear safety goggles and protective gloves, user and bystander.
- Have plenty of fresh water and soap nearby. If battery acid contacts skin, clothing, or eyes, flush exposed area with soap and water for 10 minutes.
- While cleaning battery's terminals, keep airborne corrosion from eyes, nose and mouth.
- Do not touch eyes while working near battery.

Battery acid can burn eyes and skin.

WARNING



Risk of burns.

- Wear gloves when working near hot engine components.
- Do not touch hot exhaust systems, manifolds, engines, radiators, etc.
- The fluid coming from the vehicle along with some of the machine's components that the fluid comes into direct contact with (i.e. external: hoses and quick-disconnect fittings; internal: hoses and all fittings) may reach temperatures uncomfortable to the touch. Exercise caution in avoiding contact with these items.

Hot components can cause injury or discomfort.

CAUTION



Risk of injury.

- This equipment should be operated by qualified personnel only.
- Use this equipment only as described in this manual.
- Always unplug the machine from its power source when not in use.
- Loop the power cord loosely in its proper location when machine is not in use.
- Do not operate equipment with a damaged battery cables or hoses, or if the equipment has been dropped or damaged, until it has been examined by a qualified service representative.
- Care should be taken to arrange the battery cables and service hoses so that they will not be tripped over or pulled.
- Never pull on the power cables or service hoses to transport the machine. Damage may occur to these components, or machine may tip over.
- Keep area of operation clear of unnecessary tools and equipment. Utilize recessed tool storage areas on the top of the machine.
- Never leave the machine running unattended.
- This machine is not designed for any other purpose than the exchanging of power steering fluid.

Operation of your machine by anyone other than qualified personnel may result in injury.

IMPORTANT

Risk of equipment damage.

- Connect battery cables to a 12-volt power source only (i.e. vehicle's battery).
- Servicing, transporting, or storing this machine in an attitude other than the normal operating position can result in fluid spillage and/or component damage.
- Never pull on the power cables or service hoses to transport the machine. Damage may occur to these components, or machine may tip over.
- Periodically clean the machine by wiping down with a clean, soft, dry cloth.

Improper operation of equipment may result in damage to machine or components.

SAVE AND FOLLOW THESE INSTRUCTIONS!

MACHINE SPECIFICATIONS

Dimensions: 38" H x 18" W x 25" D

Weight: 45 lbs.

Waste Fluid Bottle: 128 oz.

Power: 12V DC Power

FEATURES

The Wynn's Power Steering Fluid Exchange Machine allows for routine servicing of the power steering fluid system, extending component life, maintaining peak performance and reducing expensive repairs.

- ✓ Patented, Drainage & Refill Process Through the Power Steering Fluid Reservoir
- ✓ Dual Pumps for Separation of Old & New Fluid
- ✓ Dual Service Hoses for Increased Exchange Efficiency
- ✓ New/Waste Fluid On/Off Switches
- ✓ Polyethylene Body for Serviced Vehicle Protection
- ✓ For Use with Wynn's Power Steering Products
- ✓ Convenient, Portable Roll-Around Unit
- ✓ No Bay Required

MACHINE OVERVIEW

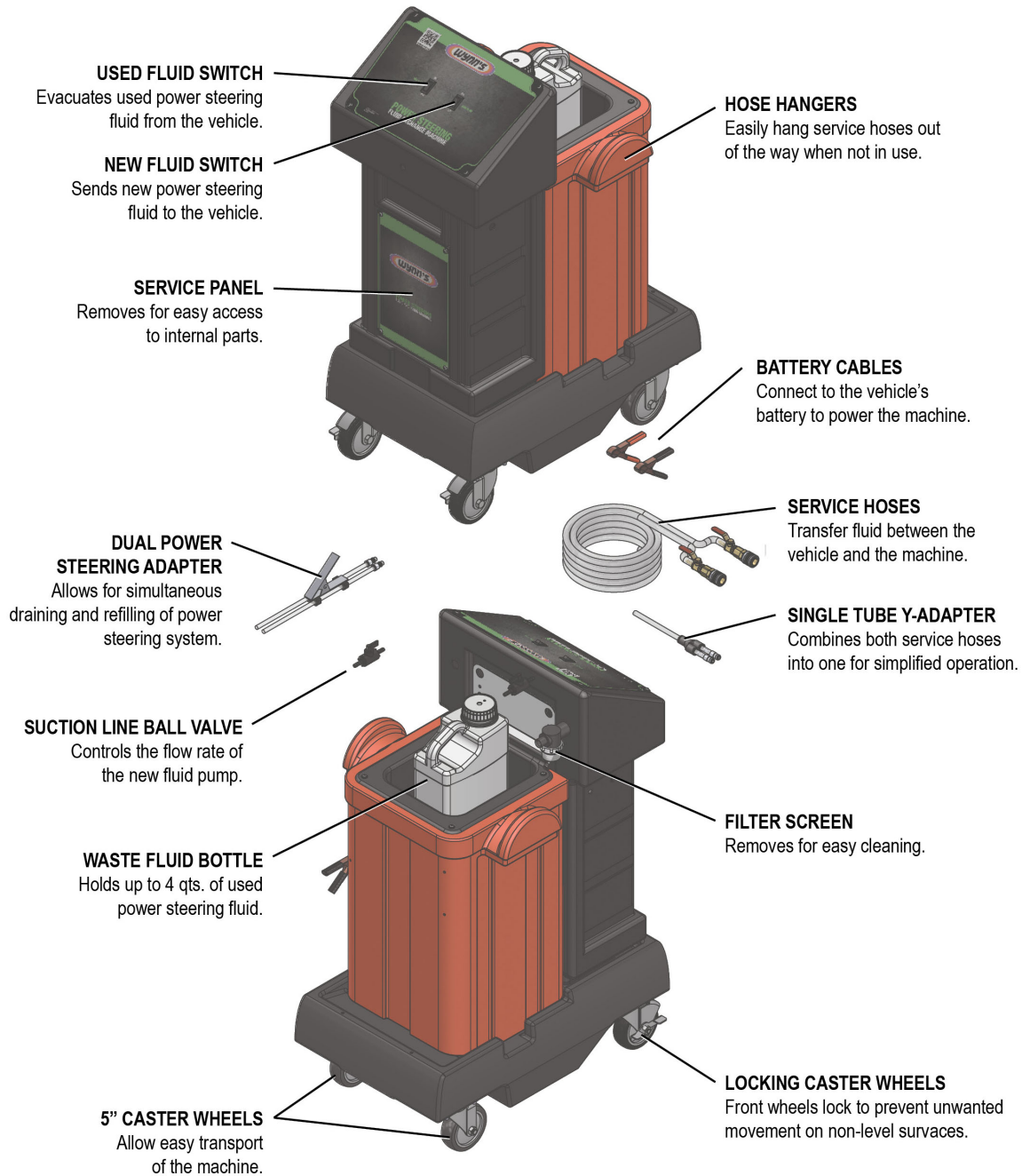

OPERATING INSTRUCTIONS

SAFETY RECOMMENDATIONS

Use extreme safety measures when working around a running engine.

Always block the vehicle's drive wheels.

Ventilate the vehicle's exhaust.

Always wear safety glasses.

It's a good idea to wear gloves.

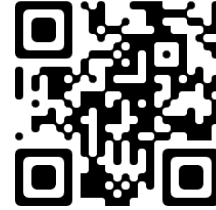

PREPARATION

Check the fluid level and quality.

Road test the vehicle for at least one mile.

Make sure that there are no problems with the power steering system such as leaks, belt slippage or excessive noise.

Connect battery cables to vehicle's battery.

Position and secure both lines, using clamp, into the power steering fluid reservoir, with the **USED FLUID** line positioned at or near max (Full) and the **NEW FLUID** Line at the bottom of the reservoir.

Make sure hose ball valves are in the open position.

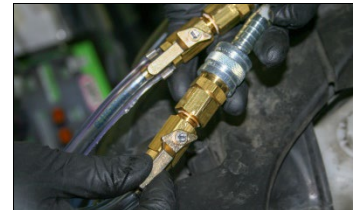





Attach **NEW FLUID** cap / inlet tube to bottle of Wynn's Power Steering Cleaner.

Make sure **USED FLUID** bottle is empty & attach to **USED FLUID** cap/inlet tube.

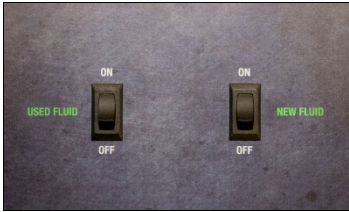

PERFORMING SERVICE

<p>Start the vehicle's engine.</p>	
<p>Turn both the NEW and USED FLUID pumps ON to begin service. The fluid level in the vehicle's power steering reservoir should remain unchanged during service. Ball valves at adapters are only used to turn flow on or off.</p> <p>Monitor the Power Steering fluid level, if the reservoir begins to overfill, turn the NEW FLUID switch to OFF, allow fluid level to return to normal and return the NEW FLUID switch to ON. Continue to monitor fluid level, you may need to take this action again before service is complete</p> <p>NOTE: Flow rates are balanced from the factory and will not usually require adjustment.</p> <p>When the Power Steering Cleaner bottle is empty, turn OFF both pumps.</p> <p>Turn the steering wheel lock to lock for 10 minutes to circulate the Cleaner throughout the system.</p>	<div style="display: flex; justify-content: space-around;">   </div>
<p>Attach NEW FLUID cap/inlet tube to bottle of Wynn's Power Steering Fluid.</p> <p>Make sure USED FLUID bottle is empty & attach to USED FLUID cap/inlet tube.</p>	<div style="display: flex; justify-content: space-around;">   </div>

Turn both the **NEW** and **USED FLUID** pumps **ON** to begin service. The fluid level in the vehicle's power steering reservoir should remain unchanged during service. Ball valves at adapters are only used to turn flow on or off.

Monitor the Power Steering fluid level, if the reservoir begins to overflow, turn the **NEW FLUID** switch to **OFF**, allow fluid level to return to normal and return the **NEW FLUID** switch to **ON**. Continue to monitor fluid level, you may need to take this action again before service is complete

NOTE: Flow rates are balanced from the factory and will not usually require adjustment.

Turn the steering wheel lock to lock several times throughout the exchange process.

When the fluid is clean (or service kit bottle is empty), turn **OFF** both fluid pumps.



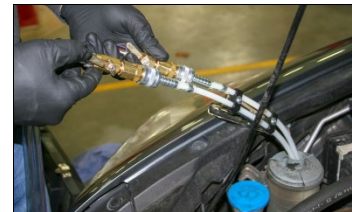
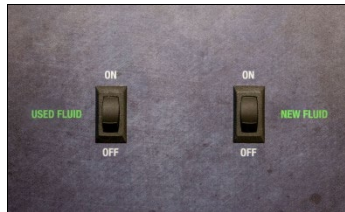

NOTE: When adding an additive at the end of the exchange, leave the necessary space in the reservoir



Turn off engine, disconnect battery cables, and replace reservoir cap (and screen if applicable).

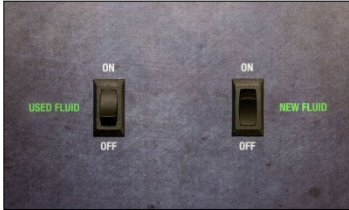
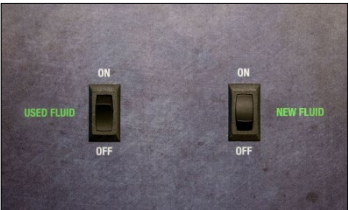

EXCHANGE USING SINGLE TUBE Y-ADAPTER

<p>Position and secure the included single tube Y-adapter into the power steering fluid reservoir.</p> <p>Make sure hose ball valves are in the open position.</p> <p>Start the vehicle's engine.</p>	<div style="display: flex; justify-content: space-around;">   </div>
<p>Set the USED FLUID switch to the ON position to drain the power steering fluid reservoir, leaving enough on the bottom to prevent air from entering the lines. Set the switch to the OFF position.</p> <p>Set the NEW FLUID switch to the ON position. Once the reservoir is filled to the proper level, set the switch to the OFF position.</p> <p>Turn the steering wheel lock to lock several times, and repeat drain/fill and turning steering wheel until the fluid is clean (or service kit bottle is empty).</p> <p>NOTE: When adding an additive at the end of the exchange, leave the necessary space in the reservoir.</p>	<div style="display: flex; justify-content: space-around;">   </div>
<p>Turn off engine, disconnect battery cables, and replace reservoir cap (and screen if applicable).</p>	<div style="display: flex; justify-content: space-around;">   </div>

MAINTENANCE

Clean Filter Screen every 50 exchanges, or as needed:

Open filter screen housing by unscrewing the top. Use a sharp pick to remove screen from housing. Clean using degreaser and brush, and blow out with air compressor. Put screen back in housing.

REPLACEMENT PARTS

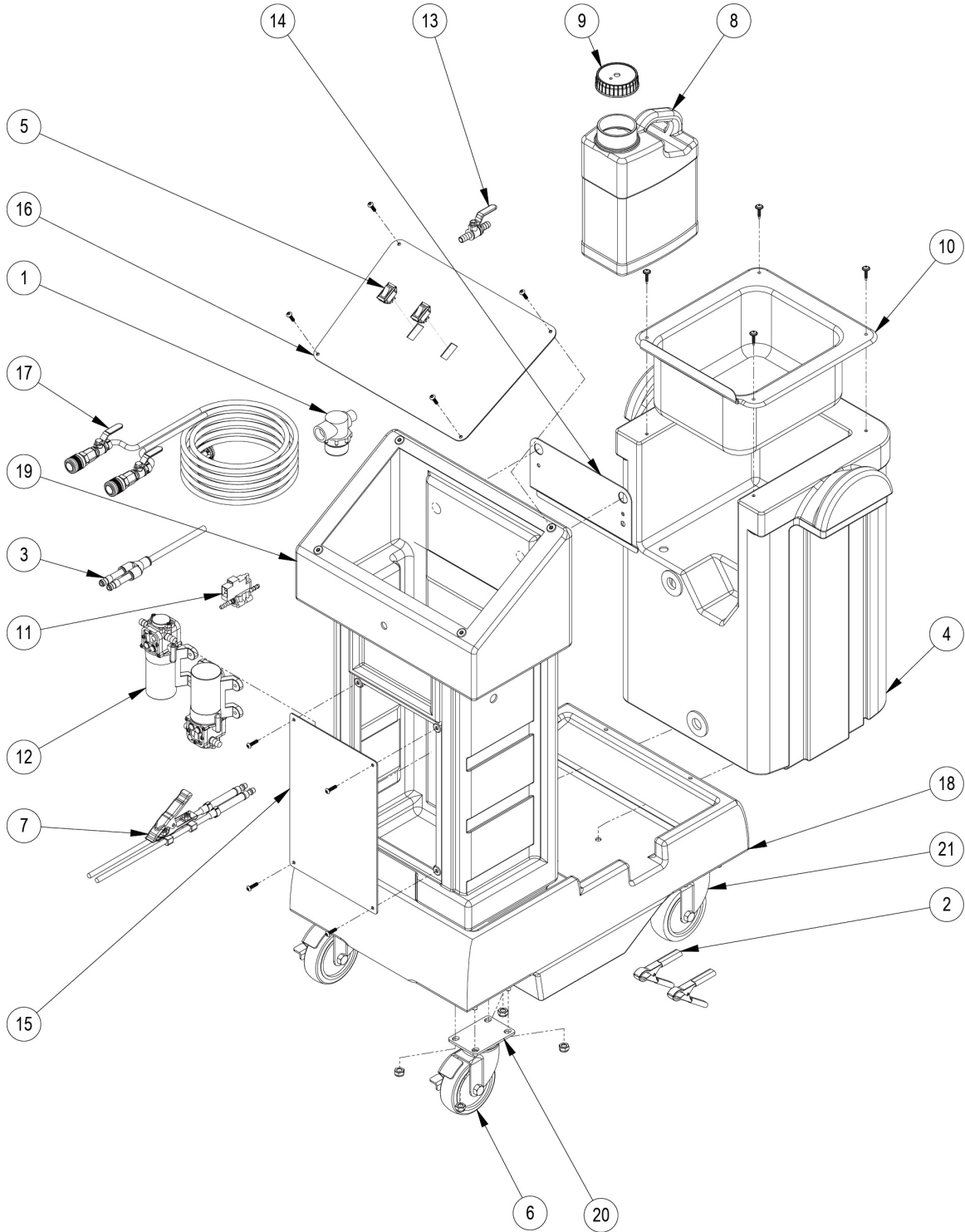

ITEM NO.	PART NO.	DESCRIPTION	QTY.
1	940552	IN LINE STRAINER	1
2	940830	BATTERY CABLE ASSEMBLY 12FT	1
3	941178	Y - ADAPTER	1
4	941252	REAR CABINET SUPPORT - RED	1
5	941341	2 WAY SWITCH	2
6	942137W	WHEEL ONLY 4" CASTERS	4
7	40100067	POWER STEERING ADAPTER	1
8	40200438	1 GAL WASTE FLUID BOTTLE	1
9	40200439	CAP FOR 40200438 WASTE BOTTLE	1
10	40200440	2 GAL MOLDED TRAY	1
11	40200741	INLINE PRESSURE SWITCH 3/8 PORTS	1
12	40200742	35 PSI PUMP	2
13	40200759	BALL VALVE 3/8	1
14	40300260	PLATE - REAR CABINET	1
15	40300309	SERVICE PANEL - OVERLAY ASSEMBLY	1
16	40300313	CONTROL PANEL - OVERLAY ASSEMBLY	1
17	40300353	HOSE ASSEMBLY	1
18	R940750	CHASSIS - BLACK	1
19	R940751	CONSOLE - BLACK	1
20	R942118	CASTER 4" W/BRAKE	2
21	R942137	CASTER 4" SWIVEL	2

Wynn's Equipment Limited Warranty Terms and Conditions

(1 Year on Equipment / 2 Years on Parts)

Seller warrants to its distributors that under normal use, care and service, the Equipment (except as otherwise provided herein) shall be free from defects in material and workmanship for One (1) year from the date of original invoice (unless a machine was put into inventory and later sold (such sale from inventor to occur no later than [six (6) months] after the date of original invoice), and a distributor can provide proof of sale and registered warranty card, then the one-year warranty will begin on the registration date) for all Equipment with an additional 12 months of coverage for **parts only**. External hoses, remote control modules, adapters and all other attachments, supplies and consumables (except as otherwise provided herein) are warranted for 90 calendar days from the date of original invoice. Filter elements are not warranted. Printed circuit boards purchased from Seller will be warrantable for a period of one (1) years from original purchase date, and any repair services for machines under warranty or to a purchased circuit board by an ITW employee or authorized representative shall be reimbursed.

SELLER'S OBLIGATIONS UNDER THIS WARRANTY ARE LIMITED SOLELY TO THE REPAIR OR, AT SELLER'S OPTION, REPLACEMENT OF EQUIPMENT OR PARTS, AND LABOR COSTS ASSOCIATED WHICH TO SELLER'S SATISFACTION ARE DETERMINED TO BE DEFECTIVE AND WHICH ARE NECESSARY, IN SELLER'S JUDGEMENT, TO RETURN THE EQUIPMENT TO GOOD OPERATING CONDITION. NO OTHER WARRANTIES EXPRESS OR IMPLIED OR STATUTORY, INCLUDING WITHOUT LIMITATION ANY IMPLIED WARRANTY OF MERCHANTABILITY OR FITNESS FOR A PARTICULAR PURPOSE, SHALL APPLY AND ALL SUCH WARRANTIES ARE HEREBY EXPRESSLY DISCLAIMED.

This warranty does not cover (and separate charges for parts, labor and related expenses shall apply to) any damage to, malfunctioning, inoperability or improper operation of the Equipment caused by, resulting from or attributable to (A) abuse, misuse or tampering; (B) alteration, modification or adjustment of the Equipment by anyone other than Seller's authorized representatives; (D) improper or negligent use, application, operation, care, cleaning, storage or handling; (E) fire, water, wind, lightning or other natural causes; (F) adverse environmental conditions, including, without limitation, excessive heat, moisture, corrosive elements, or dust or other air contaminants, radio frequency interference, electric power failure, power line voltages beyond those specified for the equipment, unusual physical, electrical or electromagnetic stress, and/or any other condition outside of Seller's environmental specifications; (G) use of the Equipment in combination or connection with other equipment, attachments, supplies or consumables not manufactured or supplied by Seller; or (H) failure to comply with any applicable federal, state or local regulation.

Repairs or replacements qualifying under this Warranty will be performed on regular business days during Seller's normal working hours within a similar timeframe and process as BUYER already has in place, to be accomplished by Wynn's/QMI distributors with the support and cooperation of the SELLER, or by SELLER or SELLER's subcontractors if that is acceptable to the BUYER following Purchaser's request or if agreed to between Seller and Buyer by Purchaser's/ ITW staff if necessary. All requests for Warranty service must be made during the stated Warranty period. **This warranty is non-transferable.**